

TB



3-Corner Grooving & Parting Tools for High Speed, High Feed and Interrupted Machining

▣ Machining Stability

Strong clamping prevents tool vibration to produce high quality finishes and longer tool life

▣ Chip Control

Stable chip control boosts productivity at high speeds and high feeds

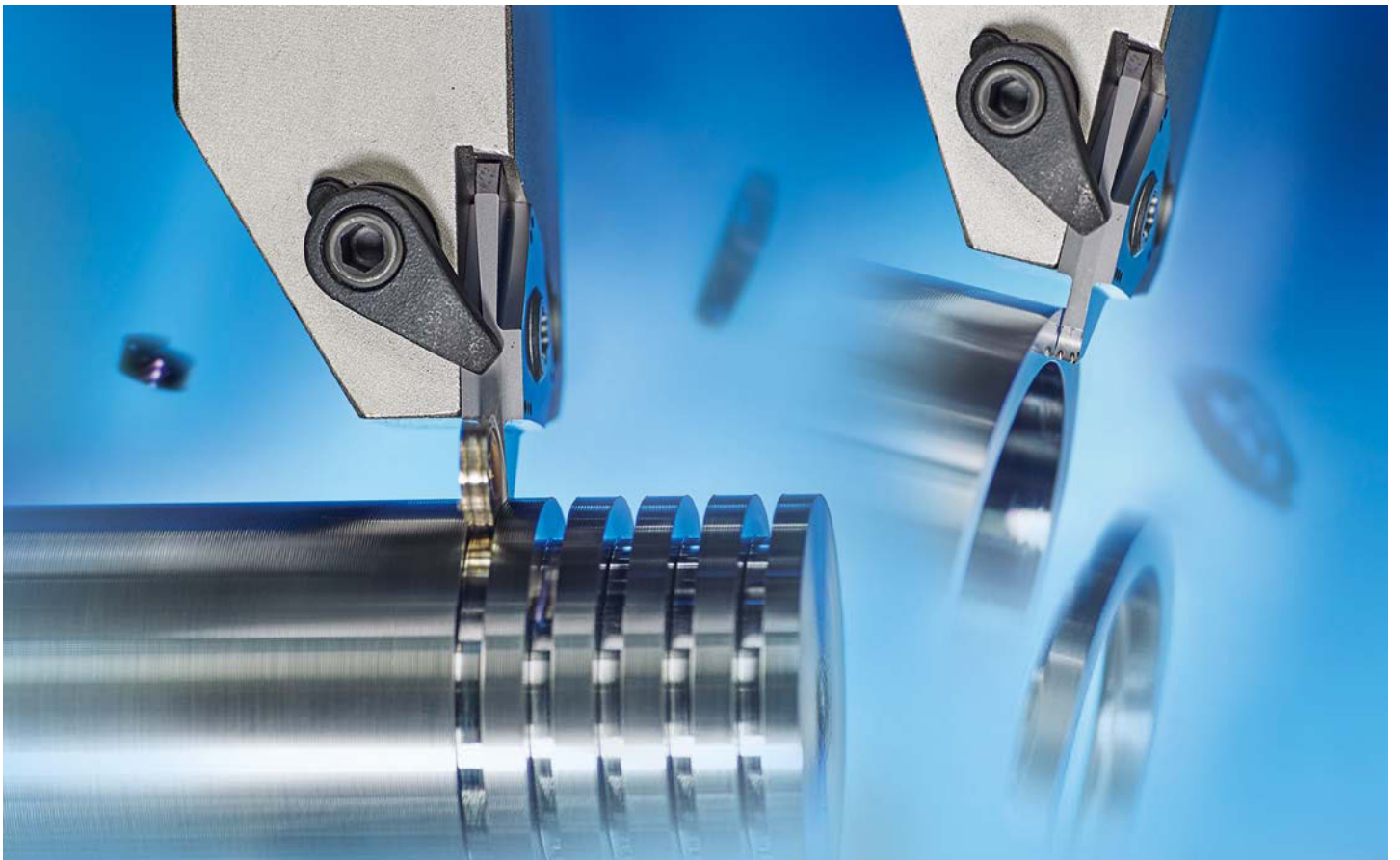

3-Corner Grooving & Parting Tools for High Efficiency

TB



TB3, TB4

Ground chip breaker



TB4-M

M-class chip breaker

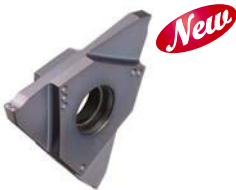

TB5-M

M-class chip breaker

Machining small components requires high productivity tools that are capable of high speed and high feed work. These tough cutting conditions often involve high spindle speeds over 2,000 RPM. These high speeds cause vibrations of the spindle, and the cutting tools are negatively affected by the vibrations.

Grooving and parting inserts normally have thin and narrow cutting edges, which leads to tool vibration at high speeds and feeds. Such vibrations can cause decreased level of surface finish, dimensional changes, and shortened tool life. Clamping stability and improved rigidity of the cutting edges are essential to cutting performance.

TB was designed to have wide supporting areas along the outer edge of the equilateral triangle-shaped insert, to maximize clamping stability. A double clamping system, using both a clamp and screw, also enables stable machining at high speeds, high feeds, and high interruptions. Additionally, its specialized chip breakers help to minimize cutting force and improve chip evacuation, which results in excellent surface finish.

TB is a combination of grooving and parting tools that can boost your productivity with its high stability at high speeds, high feeds, and high interruptions.

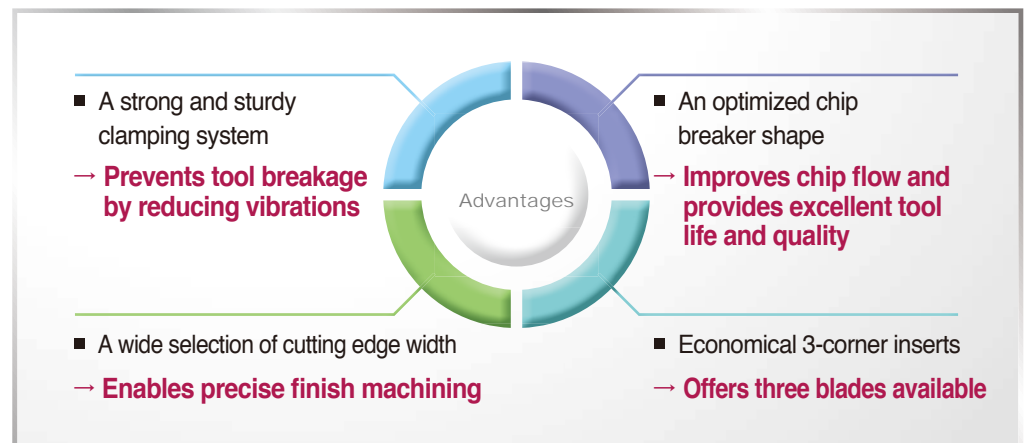

Code System

[Insert]

TB	5	150	N	-	010	-	M
Triangle Blade	Inscribed circle	Cutting edge width	Hand		Nose R		Chip breaker
	3: 9.525 mm 4: 12.7 mm 5: 15.875 mm	0.5~4.5 mm	N: Neutral R: Right-handed L: Left-handed		0.00~0.40mm		None M

[Holder]

TBH	5	25	R
Triangle Blade Holder	Inscribed circle	Shank size	Hand
	3: 9.525mm 4: 12.7mm 5: 15.875mm	10~25mm	R: Right-handed L: Left-handed

Common Problems When Grooving and Parting Off

- Vibrations and impacts are caused by low clamping stability in interrupted machining
→ **Burr creation, reduced surface quality and tool breakage**
- When chip flow is not smooth in high speed and high feed machining, chips are caught inside each groove and rough cutting edges
→ **Increased cutting force leads to inferior surface quality and shortened tool life**

Development of the TB

Higher clamping stability		
Type	TB3, TB4, TB4-M	TB5-M
Shape	<p>Clamp an insert</p> <p>Clamping area of 60°</p>	<p>First, screw an insert</p> <p>Second, clamp it</p> <p>Clamping area of 60°</p>
Features	<ul style="list-style-type: none"> • Stable clamping system with an internal angle of 60° • Clamp use 	<ul style="list-style-type: none"> • Stable clamping system with an internal angle of 60° • Double clamping using both a screw and a clamp

• Cutting conditions:
vc (m/min) = 150
ap (mm) = 3, wet

Improved chip control (M chip breaker)				
Type	Competitor		TB4-M, TB5-M	
Feed, fn (mm/rev)	0.12	0.18	0.12	0.18
C45 (Carbon steel)				
X5CrNi18-9 (Stainless steel)				
Result	Decreased machining quality owing to unstable chip evacuation		Improved machining quality thanks to stable chip evacuation	

Development Effect



• Workpiece: 18CrMo4
• Cutting conditions :
vc (m/min) = 120
fn (mm/rev) = 0.1
ap (mm) = 4.5, wet

Interrupted machining availability

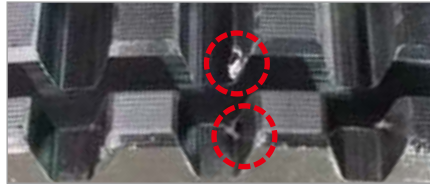

Burrs, created by vibrations in interrupted cutting
[Competitor]

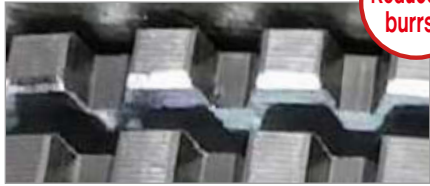

Reduced burr creation thanks to higher clamping stability
[TB5-M]

Reduced burrs



• Workpiece: C45
• Cutting conditions :
vc (m/min) = 180
fn (mm/rev) = 0.18
ap (mm) = 5.0, wet

High speed and high feed machining availability

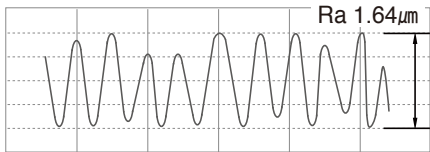

Decreased level of surface finish owing to poor chip flow
[Competitor]

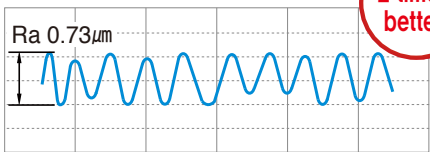

Improved surface finish thanks to smooth chip flow
[TB5-M]

2 times better

⇒ TB Features

- **TB3, TB4, TB4-M**

(For grooving)

→ Recommended for continuous cutting

- **TB5-M** (For grooving)

→ Recommended for both continuous and interrupted cutting

For interrupted machining

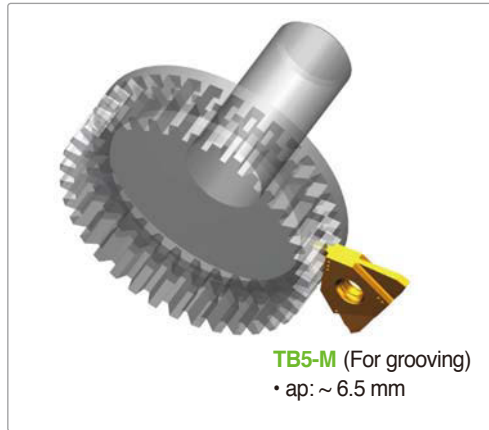

→ **TB5-M is recommended for interrupted machining**

For grooving and parting off

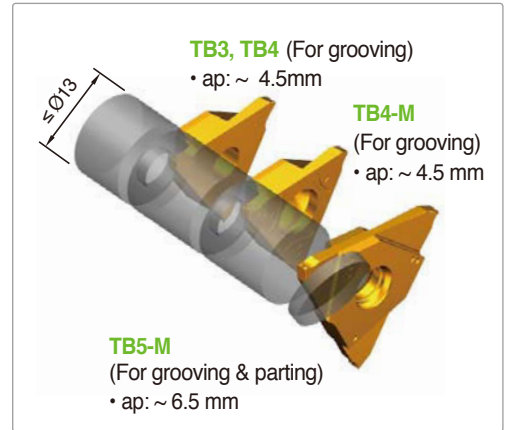

→ **TB5-M is capable of cutting off a steel bar with external diameter $\leq \text{Ø}13$**

Specification	TB3000R/L TB4000R/L	TB4000R-M	TB5000N-000-M <i>New</i>	
Designation	TB3125R/L~TB3430R/L (Inscribed circle of 9.525 mm) TB4125R/L~TB4430R/L (Inscribed circle of 12.7 mm)	TB4150R-M ~TB4450R-M (Inscribed circle of 12.7 mm)	TB5050N-000-M ~TB5318N-020-M (Inscribed circle of 15.875 mm)	
Insert shape				
Features	Chip breaker	Ground chip breaker	Pressed chip breaker	
	Hand	Right/Left-handed	Right-handed	Neutral
	Cutting edge width (b)	TB3000: 1.25~4.3 mm TB4000: 1.25~4.5 mm	1.5~4.5 mm	0.5~3.18 mm
	Depth of cut (T-MAX)	TB3000: ~3.5 mm TB4000: ~5.0 mm	~5.0 mm	~6.5 mm
Specialized	Shape	○	X	X
	Cutting edge width	○	○	○
Chip breaker shape				
Application range	P	P, M, K	P, M, K	
Grade	CN2000, PC5300	CN2000, PC5300	PC5300	

Guide for TB

(mm)

[Recommended machining method]

• TB3, TB4



For grooving

• TB4-M

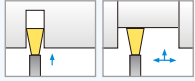

For grooving For turning

• TB5-M



For parting off For grooving For turning

Cutting edge width W	TB			Recommended feed rate (mm/rev)	TB3, TB4	TB4-M	TB5-M
	Depth of cut T-MAX						
	TB3, TB4	TB4-M	TB5-M				
0.50	-	-	2.5	0.05 (0.03~0.1)	-	-	●
0.80	-	-	1.6		-	-	●
1.00	-	-	3.5		-	-	●
1.04	-	-	2.0		-	-	●
1.20	-	-	2.0		-	-	●
1.25	2.0	-	2.0		●	-	-
1.40	2.0	-	6.5	●	-	●	
1.45	2.0	-	-	●	-	-	
1.47	-	-	6.5	-	-	●	
1.50	3.5	3.5	6.5	●	●	●	
1.57	-	-	6.5	-	-	●	
1.70	-	-	6.5	-	-	●	
1.75	3.5	3.5	-	●	●	-	
1.78	-	-	6.5	-	-	●	
1.85	3.5	3.5	-	●	●	-	
1.96	-	-	6.5	-	-	●	
2.00	3.5	3.5	6.5	●	●	●	
2.15	3.5	3.5	-	●	●	-	
2.22	6.5	-	6.5	-	-	●	
2.30	3.5	3.5	6.5	●	●	●	
2.39	-	-	6.5	-	-	●	
2.47	-	-	6.5	-	-	●	
2.50	4.0	4.0	6.5	●	●	●	
2.65	4.0	4.0	6.5	●	●	-	
2.70	-	-	6.5	-	-	●	
2.80	4.0	4.0	-	●	●	-	
2.87	-	-	6.5	-	-	●	
3.00	4.0	4.0	6.5	●	●	●	
3.15	-	-	6.5	-	-	●	
3.18	-	-	6.5	-	-	●	
3.30	4.0	-	-	●	-	-	
3.50	5.0	5.0	-	●	●	-	
4.00	5.0	5.0	-	●	●	-	
4.30	5.0	5.0	-	●	●	-	
4.50	5.0	5.0	-	●	●	-	

● : Managed item

Recommended Cutting Conditions

Recommended cutting speed, vc (m/min)

Workpiece		CN2000 (Cermet)			PC5300 (Coated)		
		Min.	Recommended	Max.	Min.	Recommended	Max.
P	SMOOC type	100	160	220	80	140	200
	SCM type	100	150	200	80	130	180
M	STS type	-	-	-	40	80	150
K	GC, GCD type	-	-	-	80	130	180

Recommended Cutting Range

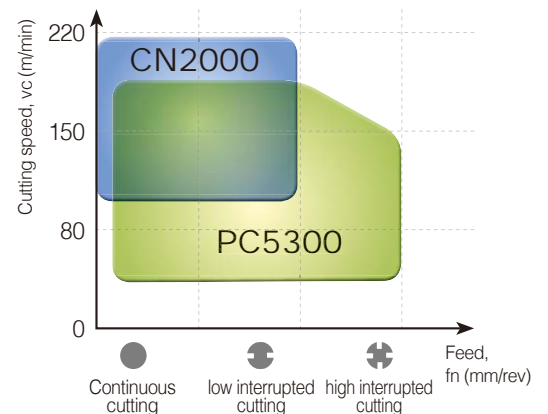

TB-M Chip Breaker

- Minimized cutting force at high speed and high feed → **Smooth chip evacuation outside each groove**
- High precision cutting performance → **Exceptional surface finish and accurate dimensions**
- Excellent chip flow and cutting results → **Ideal for automated and unmanned production**

• Purpose: Grooving, parting off and interrupted cutting ≤ 6.5 mm with T-MAX

TB5-M Chip breaker

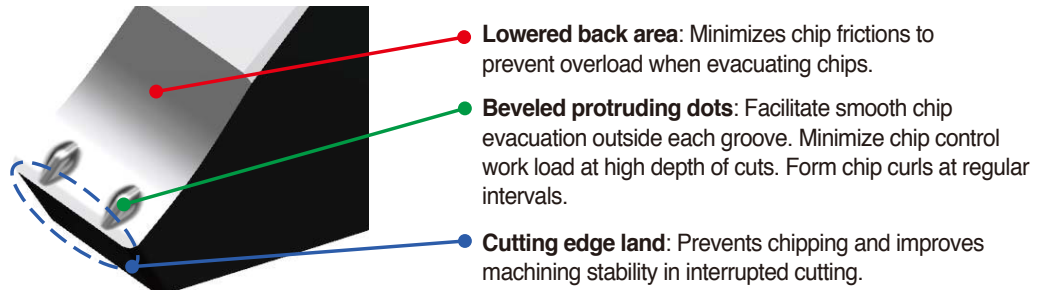

Designation	TB5050N-M ~TB5120N-M	TB5140N-M ~TB5178N-M	TB5196N-M ~TB5239N-M	TB5247N-M ~TB5287N-M	TB5300N-M ~TB5318N-M
Shape					
Cutting edge width (b)	0.5~1.2 mm	1.40~1.78 mm	1.96~2.39 mm	2.47~2.87 mm	3.0~3.18 mm

• Purpose: Grooving and turning ≤ 4.5 mm with T-MAX

TB4-M Chip breaker

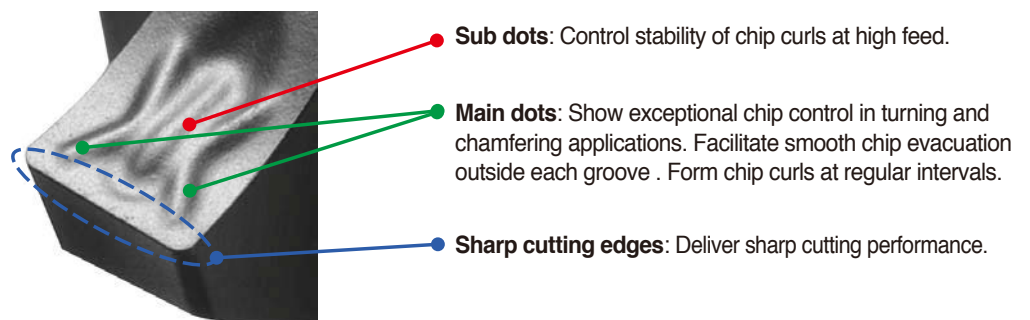

Designation	TB4150R-M ~TB4185R-M	TB4200R-M ~TB4228R-M	TB4300R-M ~TB4350R-M	TB4400R-M ~TB4450R-M
Shape				
Cutting edge width (b)	1.5~1.85 mm	2.0~2.8 mm	3.0~3.5 mm	4.0~4.5 mm

➔ Wear Resistance Test

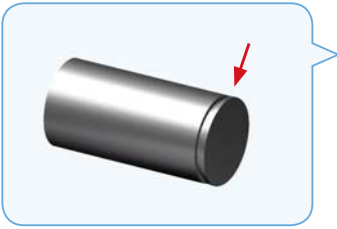

35 min. long machining

- **Workpiece** C45 (Carbon steel), External turning and grooving
- **Cutting conditions** vc (m/min) = 200, ap (mm) = 3, fn (mm/rev) = 0.12, wet
- **Tools** TB5200N-020-M (PC5300)

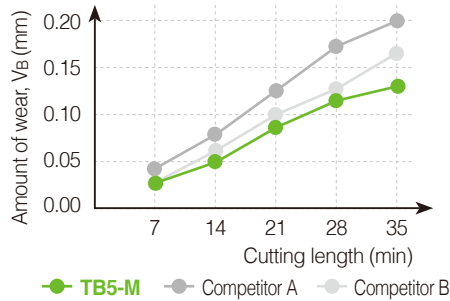

Type	TB5200N-020-M (PC5300)	Competitor A (Universal grade)	Competitor B (Universal grade)
Picture of wear			
Tool life comparison	100%	70%	40%

10 min. long machining

- **Workpiece** X5CrNi18-9 (Stainless steel), External turning and grooving
- **Cutting conditions** vc (m/min) = 120, ap (mm) = 3, fn (mm/rev) = 0.1, wet
- **Tools** TB5200N-020-M (PC5300)

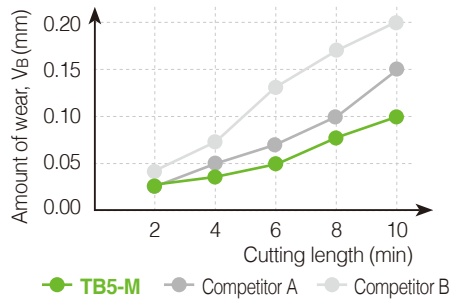

Type	TB5200N-020-M (PC5300)	Competitor A (Universal grade)	Competitor B (Universal grade)
Picture of wear			
Tool life comparison	100%	70%	40%

➔ Evaluation of Wear

- **Workpiece** C45 (Carbon steel), Grooving with four times of interruption
- **Cutting conditions** vc (m/min) = 100, ap (mm) = 3, fn (mm/rev) = 0.1, wet
- **Tools** TB5200N-020-M (PC5300)

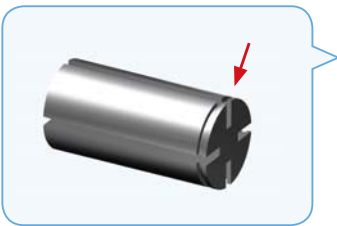

Feed rate (0.1 mm/rev)

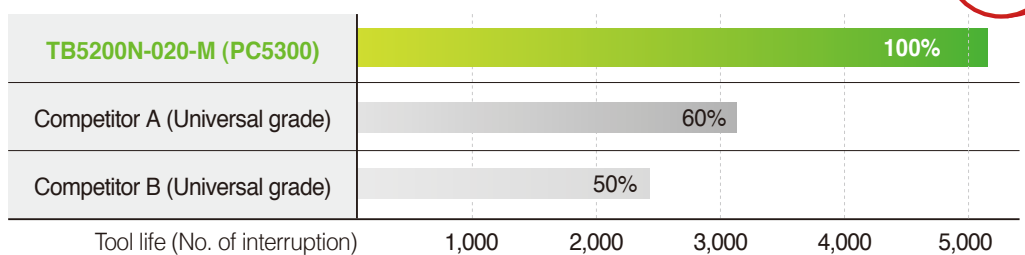

40%
longer
tool life

⇒ TB5-M Machining Range

* There is a limit to cutting diameters of TB5-M when depth of cuts are over 5 mm.
(e.g. When cutting with a TB5200N-020-M insert at the depth of 6.2 mm, Ø60 D-MAX is available.)

* N.L = No limit

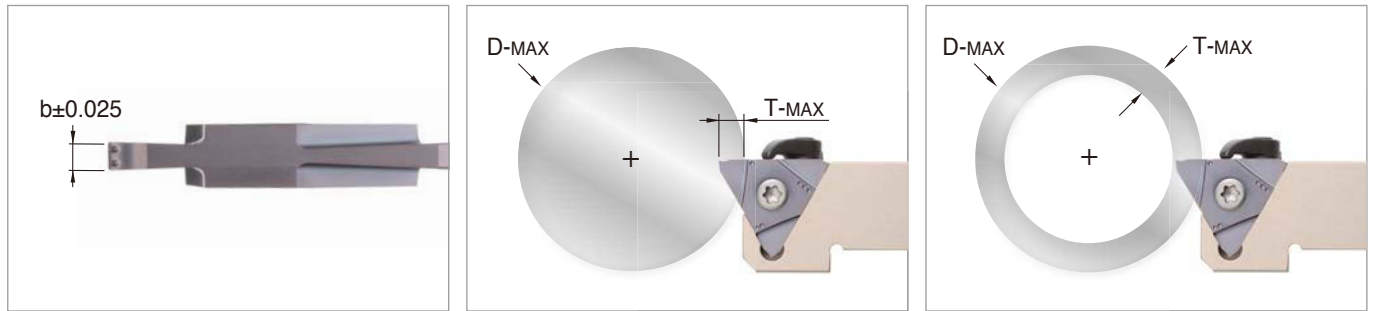

(mm)

Designation	b	g(T-MAX)	r	ØD-MAX									
				T ≤ 3.0	T ≤ 3.5	T ≤ 4.0	T ≤ 4.5	T ≤ 5.0	T ≤ 5.5	T ≤ 6.0	T ≤ 6.4	T ≤ 6.5	
TB 5050N-000-M	0.50	1.0	0.00	-	-	-	-	-	-	-	-	-	-
5050N-004-M	0.50	2.5	0.04	-	-	-	-	-	-	-	-	-	-
5080N-000-M	0.80	1.6	0.00	-	-	-	-	-	-	-	-	-	-
5100N-006-M	1.00	3.5	0.06	-	-	-	-	-	-	-	-	-	-
5104N-000-M	1.04	2.0	0.00	-	-	-	-	-	-	-	-	-	-
5120N-000-M	1.20	2.0	0.00	-	-	-	-	-	-	-	-	-	-
5140N-000-M	1.40	6.5	0.00	N.L	N.L	N.L	N.L	N.L	Ø300	Ø170	Ø60	Ø40	
5147N-000-M	1.47	6.5	0.00	N.L	N.L	N.L	N.L	N.L	Ø300	Ø170	Ø60	Ø40	
5150N-010-M	1.50	6.5	0.10	N.L	N.L	N.L	N.L	N.L	Ø300	Ø170	Ø60	Ø40	
5150N-015-M	1.50	6.5	0.15	N.L	N.L	N.L	N.L	N.L	Ø300	Ø170	Ø60	Ø40	
5157N-015-M	1.57	6.5	0.15	N.L	N.L	N.L	N.L	N.L	Ø300	Ø170	Ø60	Ø40	
5170N-010-M	1.70	6.5	0.10	N.L	N.L	N.L	N.L	N.L	Ø300	Ø170	Ø60	Ø40	
5178N-018-M	1.78	6.5	0.18	N.L	N.L	N.L	N.L	N.L	Ø300	Ø170	Ø60	Ø40	
5196N-015-M	1.96	6.5	0.15	N.L	N.L	N.L	N.L	N.L	Ø300	Ø170	Ø60	Ø40	
5200N-020-M	2.00	6.5	0.20	N.L	N.L	N.L	N.L	N.L	Ø300	Ø170	Ø60	Ø40	
5222N-015-M	2.22	6.5	0.15	N.L	N.L	N.L	N.L	N.L	Ø300	Ø170	Ø60	Ø40	
5230N-020-M	2.30	6.5	0.20	N.L	N.L	N.L	N.L	N.L	Ø300	Ø170	Ø60	Ø40	
5239N-015-M	2.39	6.5	0.15	N.L	N.L	N.L	N.L	N.L	Ø300	Ø170	Ø60	Ø40	
5247N-020-M	2.47	6.5	0.20	N.L	N.L	N.L	N.L	N.L	Ø300	Ø170	Ø60	Ø40	
5250N-020-M	2.50	6.5	0.20	N.L	N.L	N.L	N.L	N.L	Ø300	Ø170	Ø60	Ø40	
5270N-010-M	2.70	6.5	0.10	N.L	N.L	N.L	N.L	N.L	Ø300	Ø170	Ø60	Ø40	
5287N-020-M	2.87	6.5	0.20	N.L	N.L	N.L	N.L	N.L	Ø300	Ø170	Ø60	Ø40	
5300N-000-M	3.00	6.5	0.00	N.L	N.L	N.L	N.L	N.L	Ø300	Ø170	Ø60	Ø40	
5300N-020-M	3.00	6.5	0.20	N.L	N.L	N.L	N.L	N.L	Ø300	Ø170	Ø60	Ø40	
5300N-040-M	3.00	6.5	0.40	N.L	N.L	N.L	N.L	N.L	Ø300	Ø170	Ø60	Ø40	
5315N-015-M	3.15	6.5	0.15	N.L	N.L	N.L	N.L	N.L	Ø300	Ø170	Ø60	Ø40	
5318N-020-M	3.18	6.5	0.20	N.L	N.L	N.L	N.L	N.L	Ø300	Ø170	Ø60	Ø40	

⇒ Application Examples



Servo piston

- Workpiece 18CrMo4
- Cutting conditions vc (m/min) = 120, ap (mm) = 2.0, fn (mm/rev) = 0.1, wet
- Tools TB4200R-M (PC5300)

TB4-M	1000 ea/tooth
Competitor	820 ea/tooth

20% more

➔ 20% longer tool life than the competitor, thanks to improved chip flow

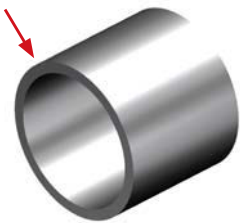

Sleeve

- Workpiece C20
- Cutting conditions vc (m/min) = 200, ap (mm) = 2.0, fn (mm/rev) = 0.12, wet
- Tools TB5200N-020-M (PC5300)

TB5-M	600 ea/tooth
Competitor	460 ea/tooth

30% more

➔ Reduced burr creation and 30% longer than the competitor, tool life thanks to improved stability at high speed



Clutch hub

- Workpiece 20Cr4
- Cutting conditions vc (m/min) = 150, ap (mm) = 4.5, fn (mm/rev) = 0.12, wet
- Tools TB5200N-020-M (PC5300)

TB5-M	110 ea/tooth
Competitor	100 ea/tooth

10% more

➔ 10% longer tool life than the competitor, thanks to excellent machining stability and quality results even at high feed





Gate valve spindle

- Workpiece B1
- Cutting conditions vc (m/min) = 130, ap (mm) = 3.5, fn (mm/rev) = 0.1, wet
- Tools TB5200N-020-M (PC5300)

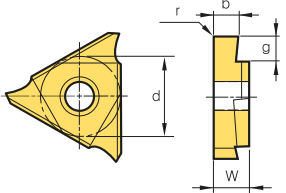

TB5-M	720 ea/tooth
Competitor	600 ea/tooth

20% more

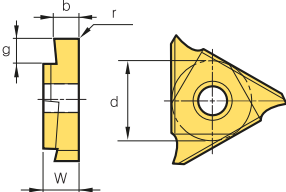

➔ 20% longer tool life than the competitor, thanks to excellent machining quality

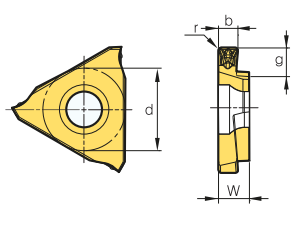
Shape	Designation		Cermet	Coated	Dimensions (mm)					Figure
			CN2000	PC5300	b	g (T-MAX)	r	w	d	
	TB (Right-handed)	3125R			1.25	1.5	0.20	4.76	9.525	
		3145R			1.45					
		3175R			1.75					
		3185R			1.85					
		3200R			2.00					
		3230R			2.30					
		3280R			2.80					
		3330R			3.30					
		3430R			4.30					
		4125R	●	●	1.25	2.0	0.20	4.76	12.7	
		4145R	●	●	1.45					
		4150R	●	●	1.50					
		4175R	●	●	1.75					
		4185R	●	●	1.85					
		4200R	●	●	2.00					
		4215R	●	●	2.15					
		4230R	●	●	2.30					
		4250R	●	●	2.50					
		4265R	●	●	2.65					
		4280R	●	●	2.80					
		4300R	●	●	3.00					
		4330R	●	●	3.30					
		4350R	●	●	3.50					
		4400R	●	●	4.00	5.0	0.40			
4430R	●	●	4.30							
4450R	●	●	4.50							
	TB (Left-handed)	3125L			1.25	1.5	0.20	4.76	9.525	
		3145L			1.45					
		3175L			1.75					
		3185L			1.85					
		3200L			2.00					
		3230L			2.30					
		3280L			2.80					
		3330L			3.30					
		3430L			4.30					
		4125L			1.25	2.0	0.20	4.76	12.7	
		4145L			1.45					
		4150L			1.50					
		4175L			1.75					
		4185L			1.85					
		4200L			2.00					
		4215L			2.15					
		4230L			2.30					
		4250L			2.50					
		4265L			2.65					
		4280L			2.80					
		4300L			3.00					
		4330L			3.30					
		4350L			3.50					
		4400L			4.00	5.0	0.40			
4430L			4.30							
4450L			4.50							

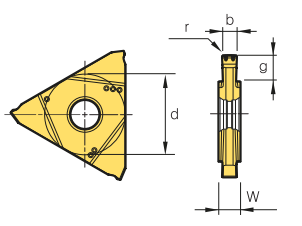
● : Managed item

Shape	Designation		Cermet	Coated	Dimensions (mm)					Figure
			CN2000	PC5300	b	g (T-MAX)	r	w	d	
	TB (Right-handed)	4150R-M	●	●	1.50	3.5	0.20	4.76	12.7	
		4175R-M	●	●	1.75					
		4185R-M	●	●	1.85					
		4200R-M	●	●	2.00					
		4215R-M	●	●	2.15					
		4230R-M	●	●	2.30					
		4250R-M	●	●	2.50	4.0	0.30			
		4265R-M	●	●	2.65					
		4280R-M	●	●	2.80					
		4300R-M	●	●	3.00					
		4330R-M	●	●	3.30	5.0	0.40			
		4350R-M	●	●	3.50					
		4400R-M	●	●	4.00					
		4430R-M	●	●	4.30					
4450R-M	●	●	4.50							
	TB (Neutral)	5050N-000-M		●	0.50	1.0	0.00	4.50	15.875	
		5050N-004-M		●		2.5	0.04			
		5080N-000-M		●	0.80	1.6	0.00			
		5100N-006-M		●	1.00	3.5	0.06			
		5104N-000-M		●	1.04	2.0	0.00			
		5120N-000-M		●	1.20					
		5140N-000-M		●	1.40	6.5	0.10			
		5147N-000-M		●	1.47					
		5150N-010-M		●	1.50	0.15				
		5150N-015-M		●						
		5157N-015-M		●	1.57	0.10				
		5170N-010-M		●	1.70					
		5178N-018-M		●	1.78	0.18				
		5196N-015-M		●	1.96	0.15				
		5200N-020-M		●	2.00	0.20				
		5222N-015-M		●	2.22	0.15				
		5230N-020-M		●	2.30					
		5239N-015-M		●	2.39	0.20				
		5247N-020-M		●	2.47					
		5250N-020-M		●	2.50	0.10				
		5270N-010-M		●	2.70					
		5287N-020-M		●	2.87	0.20				
		5300N-000-M		●	3.00	0.00				
		5300N-020-M		●		0.20				
		5300N-040-M		●		0.40				
		5315N-015-M		●	3.15	0.15				
5318N-020-M		●	3.18	0.20						

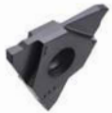
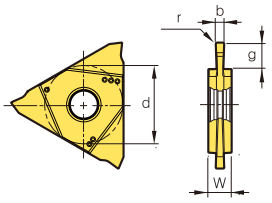
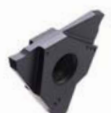
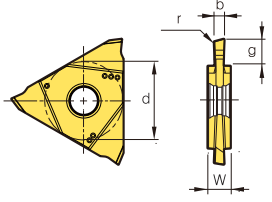
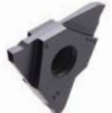
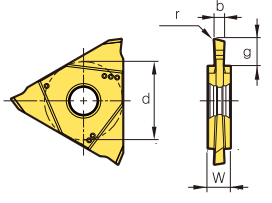
● : Managed item

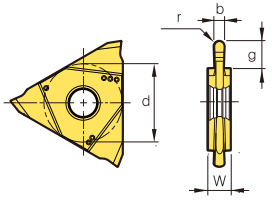
Shape	Designation		Cermet	Coated	Dimensions (mm)					Figure	
			CN2000	PC5300	b	g (T-MAX)	r	a°	w		d
	TB (Neutral)	5050N-004-P			0.50	1.0	0.04	-	4.50	15.875	
		5100N-010-P			1.00	3.5	0.10				
		5150N-010-P			1.50	6.5	0.20				
		5150N-020-P					0.10				
		5200N-010-P			2.00	6.5	0.20				
		5200N-020-P					0.15				
		5239N-015-P			2.39	6.5	0.20				
		5250N-020-P			2.50	6.5	0.20				
		5300N-020-P			3.00	6.5	0.20				
	TB (Neutral, Right cutting)	5100R-6D-P			1.00	3.5	6	4.50	15.875		
		5100R-15D-P					15				
		5150R-6D-P			1.50	6.5	6				
		5150R-15D-P					15				
		5200R-6D-P			2.00	6.5	6				
		5200R-15D-P					15				
	TB (Neutral, Left cutting)	5100L-6D-P			1.00	3.5	6	4.50	15.875		
		5100L-15D-P					15				
		5150L-6D-P			1.50	6.5	6				
		5150L-15D-P					15				
		5200L-6D-P			2.00	6.5	6				
		5200L-15D-P					15				
	TB (Neutral, Round shape)	5157N-079-P			1.57	6.5	0.79	4.50	15.875		
		5200N-100-P					1.00				
		5239N-120-P					1.20				
		5300N-150-P					1.50				

● : Managed item



TB3000R/L
TB4000R-M

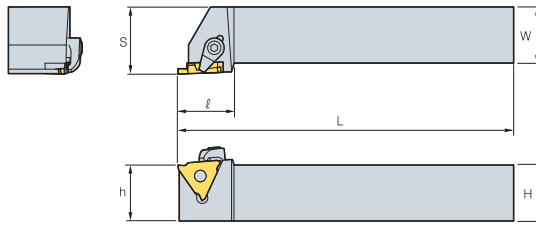
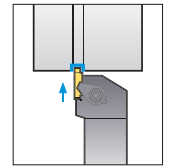

Fig. 1



This figure applies to right-hand



TB5000N-000-M

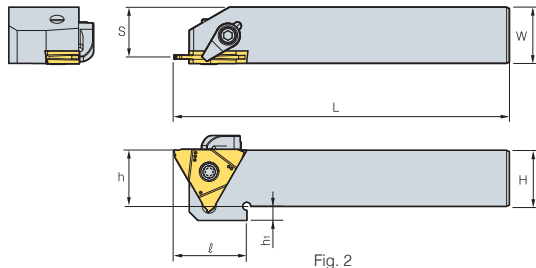

Fig. 2

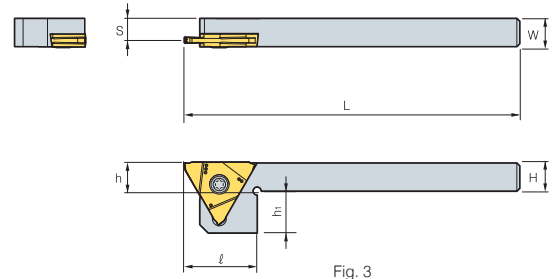

Fig. 3

(mm)

Designation		H = (h)	W	L	ℓ	h ₁	S	Applicable insert	Clamp	Clamp screw	Screw	Wrench	Fig.
TBH	320R/L-23	20	20	125	25.5	-	25	TB3125~3230R/L					1
	320R/L-33	20	20	125	25.5	-	25	TB3280~3330R/L					
	320R/L-45	20	20	125	25.5	-	25	TB3430R/L					
	325R/L-23	25	25	150	25.5	-	30	TB3125~3230R/L					
	325R/L-33	25	25	150	25.5	-	30	TB3280~3330R/L					
	325R/L-45	25	25	150	25.5	-	30	TB3430R/L					
	420R/L-23	20	20	125	25.5	-	25	TB4125~4230R/L					
	420R/L-33	20	20	125	25.5	-	25	TB4250~4330R/L					
	420R/L-45	20	20	125	25.5	-	25	TB4350~4450R/L					
	425R/L-23	25	25	150	25.5	-	30	TB4125~4230R/L					
	425R/L-33	25	25	150	25.5	-	30	TB4250~4330R/L					
	425R/L-45	25	25	150	25.5	-	30	TB4350~4450R/L					
TBH	510R/L	10	10	125	25	15	7.8	TB5050~5318N	-	-	FTNA0512	TW20L	3
	512R/L	12	12	125	25	13	9.8						
	516R/L	16	16	125	26	9	13.8						
	520R/L	20	20	125	26	5	17.8						
	525R/L	25	25	150	-	-	22.8						
								CS6R1	DHA0617	FTNA0516	HW30L TW20L	2	

www.korloy.com



Holystar B/D, 1350, Nambusunhwan-ro, Geumcheon-gu, Seoul, 08536, Korea
Tel : +82-2-522-3181 Fax : +82-2-522-3184, +82-2-3474-4744 Web : www.korloy.com E-mail : export@korloy.com

 **KORLOY AMERICA**

620 Maple Avenue, Torrance, CA 90503, USA
Tel : +1-310-782-3800 Toll Free : +1-888-711-0001 Fax : +1-310-782-3885
www.korloyamerica.com E-mail : sales@korloy.us

 **KORLOY EUROPE**

Gablonzer Str. 25-27, 61440 Oberursel, Germany
Tel : +49-6171-277-83-0 Fax : +49-6171-277-83-59
www.korloyeurope.com E-mail : sales@korloyeurope.com

 **KORLOY INDIA**

Plot NO.415, Sector 8, IMT Manesar, Gurgaon 122051, Haryana, INDIA
Tel : +91-124-4391790 Fax : +91-124-4050032
www.korloyindia.com E-mail : sales.kip@korloy.com

 **KORLOY BRASIL**

Av. Aruana 280, conj.12, WLC, Alphaville, Barueri,
CEP06460-010, SP, Brasil
Tel : +55-11-4193-3810 E-mail : vendas@korloy.com