

ENGLISH

2024 DINE CATALOGUE

TOTAL TOOLING SOLUTION

We will be the leading global company
with the **best technical skills**





CONTENTS

006 Global Networks
008 DINE Products
010 DINE History
012 Tool Application
016 DINOX Map
020 Master Index
028 Balancing System

030 DBT Series
031 HSK Tooling System
032 Catalogue Manual
033 Chuck
137 Arbor/Modular
163 Boring Tool
227 Angular Head

253 cBN/PCD
299 Device & Accessory
325 Standard
334 ABX Index

DINE Inc. makes a better world with its **technologies and quality** in addition to **customer confidence.**

By supplying our customers with high-quality products, we contribute to the development of the automobile, aerospace, electronics, machinery, and plant industries. Furthermore, we will make every effort to demonstrate the excellence of Korean cutting tools to the world by exporting our superior-quality cutting tools overseas.



Achieved ISO quality management system certification

KS Q ISO 9001:2009 / ISO 9001:2008

SBC certifies that the above company's environmental management system meets the requirements of the system standards and certification scope below.



Achieved ISO environmental management system certification

KS I ISO 14001:2009 / ISO 14001:2004

SBC certifies that the above company's management system meets the requirements of the standards and certification scope below.



We have manufactured high-quality
T/H products using high-precision
equipment and advanced CAM software.

T/H



We have manufactured cBN and
PCD tools essential for machining
automobiles, airplanes, and ships, etc.

cBN

T/S



We have also manufactured
MCT (Machining Center) tools
and T/S (Tooling System).



Homepage



Instagram



YouTube



DINE GROUP GLOBAL NETWORKS

DINE GROUP HEAD OFFICE

- DINE HEAD OFFICE / DINE FACTORY KOREA
- KORLOY HEAD OFFICE / KORLOY FACTORY KOREA
- WIDIN HEAD OFFICE ● DSP HEAD OFFICE

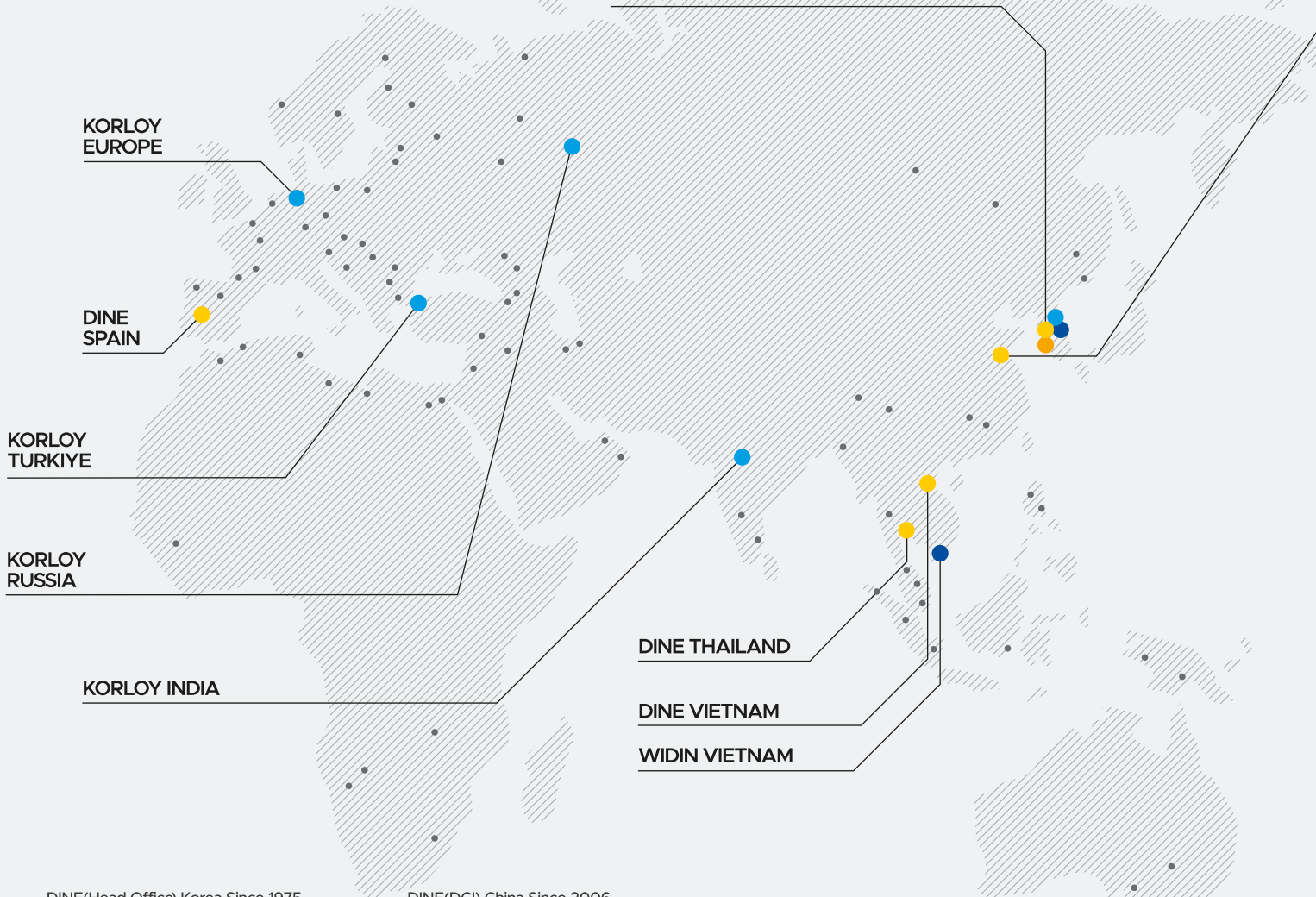

DINE(Head Office) Korea Since 1975

DINE(DCI) China Since 2006



- DINE
- KORLOY
- WIDIN
- DSP
- Overseas Agents

DINE(DVC) Vietnam Since 2017

DINE(DTC) Thailand Since 2020

DINE(DMS) Spain Since 2022

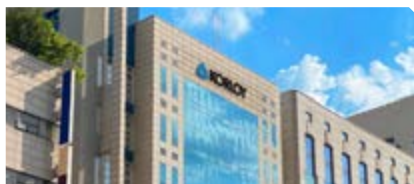

KORLOY Korea Since 1966

WIDIN Korea Since 1988

DSP Tooling inc. Korea Since 2000

- DINE CHINA
- DINE, KORLOY CHINA FACTORY



- KORLOY Head Office
- Gyeongjin Branch
- DSP Head Office
- DINE Inc. Head Office (MTV)
- Jungbu Branch
- KORLOY Jincheon Factory
- Daegu Branch
- Nambu Branch
- Nambu Support Center Smart Factory
- Changwon Branch
- WIDIN Head Office

KOREA NETWORKS

Gyeongjin Branch



Jungbu Branch



Daegu Branch



Nambu Branch



Changwon Branch



Nambu Support Center(SMART FACTORY)

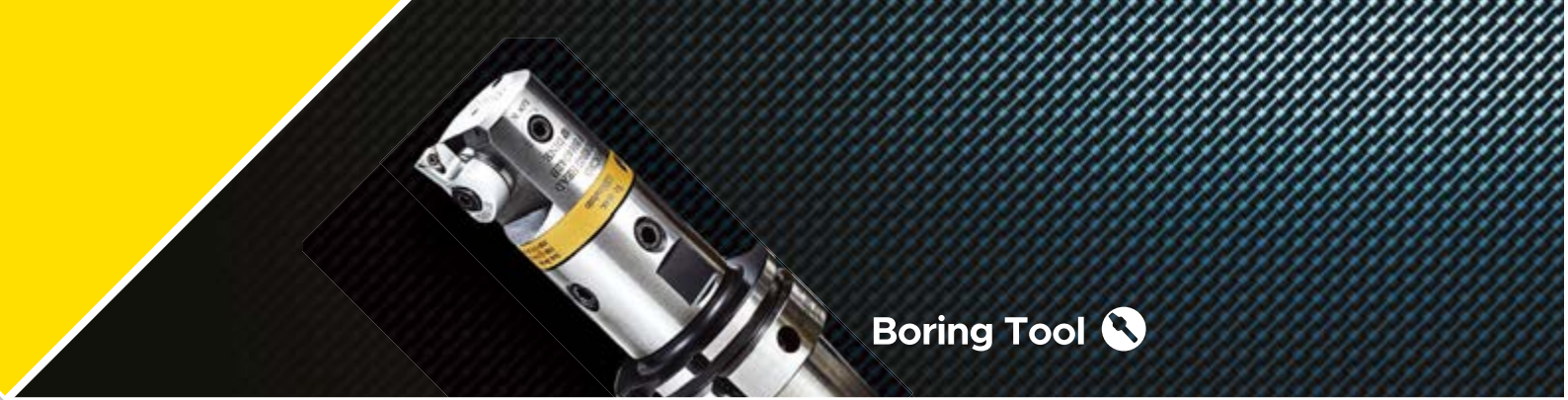

Boring Tool 

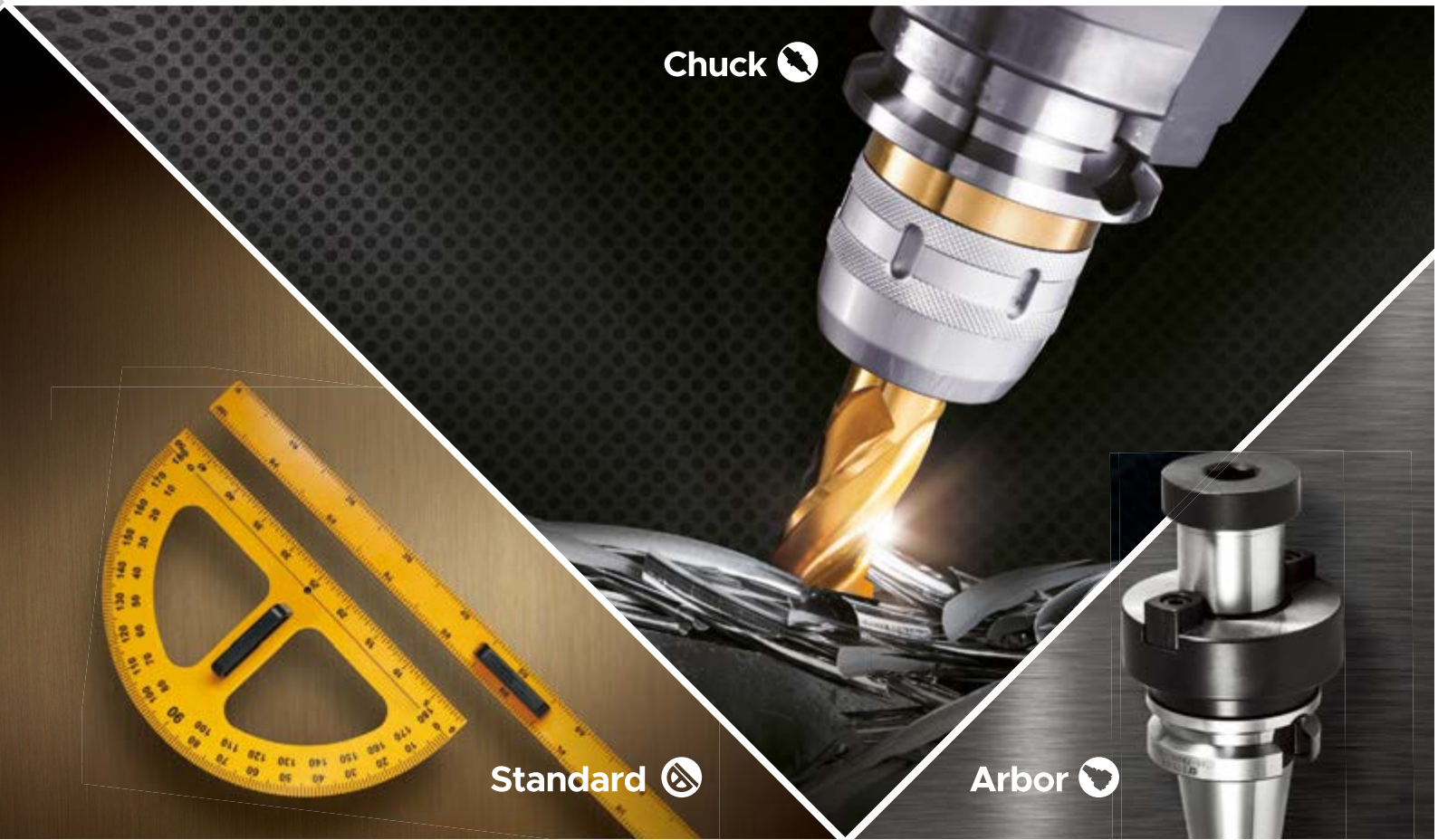

Chuck 

Standard 

Arbor 

DINE PRODUCTS

02	08	05
01	07	06
03	04	

1 Chuck

High-speed, high-precision machining with strong gripping power and perfect balancing work

2 Boring Tool

DINOX boring tools are designed with precise and reliable tolerances for stable and fast machining, and produce that can be work from small to large diameters.

3 Standard

Shank Standard Specification and Parts Information



Angular Head 1

cBN 2

Device & Accessory 3

PCD 4

4 Arbor

A product with strong clamping force by fastening tools with bolts

5 Angular Head

A tool holder that can perform two functions with one machine with various machining angles and stable operation

6 Device & Accessory

Product and Measuring instrument for MCT Cutting

7 PCD

A tool for cutting non-ferrous work piece that uses synthetic diamond to ensure an excellent machining surface and tool life.

8 cBN

It is a cutting tool made of cubic boron nitride for processing hard materials and guarantees excellent cutting performance and stable tool life

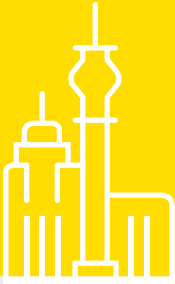

DINE HISTORY



1975

- 1975. 07** Founded Hanju Trading Company (sale of imported Cemented carbide alloy cutting tools)
- 1988. 07** Converted into a corporation and renamed DINE, Inc., Im Sang-jin inaugurated
- 1989. 02** Produced holders and locator, started OEM supply to Korloy
- 1990. 04** The manufacturing technology of NC Tooling System was introduced from Kyoritsu Seiki (Japan); Made a contract (for 5 years); Approved by the Commerce-Industry
- 1994. 08** Ministry Signed a contract for introducing the manufacturing technology of cBN cutting tools with Sumitomo in Japan
- 1995. 12** TOOLING SYSTEM factory was transferred (Sihwa Industrial Complex own factory move-in)
- 1997. 03** cBN/PCD factory was transferred (Sihwa Industrial Complex)
- 1997. 09** Started the localization of the integral angular head of Kyoritsu Seiki (Japan)
- 1998. 11** The head office was transferred (1257-4, Jeongwang-dong, Siheung-si, Gyeonggi-do (Sihwa Industrial Complex 2-da 705))
- 1999. 08** Changed company name to DINE after the merger of (Dine, Inc., Dine Co., Ltd., Ilshin Industry, Presto Co., Ltd.)

2000

- 2000. 02** Designated as IBK Family Enterprise (IBK : outstanding enterprise)
- 2001. 07** Achieved ISO 9001 : 2000 certification (SMB Certification Center)
- 2001. 11** Awarded the 3 Million Dollar Export Tower Prize on the 38th Trade Day
- 2003. 03** Applied for a patent on milling chuck with tightening precision improved (application no. 10-2003-0015317) Awarded the 5 Million
- 2004. 11** Dollar Export Tower Prize on the 41st Trade Day
- 2006. 01** Opened the second Sihwa factory
- 2006. 04** Selected as a company qualified for SMB learning organization business (HRD Korea)
- 2006. 06** Established DINE China, Inc. (DCI)
- 2006. 10** Established DINE Tool R&D Center; Approved by KOITA
- 2006. 11** Awarded the 10 Million Dollar Export Tower Prize on the 43rd Trade Day
- 2006. 12** Designated as a technology-innovation SMB (INNO-BIZ) by the SMBA
- 2007. 01** Opened the knowledge management system "Dian(다이안)"
- 2007. 04** KIPO No.10-0713805 "Milling chuck with a strong structure preventing foreign substance penetration"
- 2007. 06** Opened a call center
- 2007. 08** Selected as a Gyeonggi-do promising SMB (for 5 years)
- 2007. 10** Established a manufacturing corporation in China
- 2007. 12** Received a presidential citation on the 7th Machinist Day (Chairman Yoon Hye-seop)
- 2008. 07** Broke ground for the manufacturing corporation in China
Achieved zero hazard goal twofold
- 2008. 10** Achieved zero hazard goal threefold
- 2008. 12** Awarded the 20 Million Dollar Export Tower Prize on the 45th Trade Day /
Awarded the 3rd Gyeonggi SMB Prize - export field
- 2009. 12** Signed an MOU with the Qingdao Bonded Area / Held the completion ceremony for the manufacturing corporation in China

2010

- 2010. 02** Applied for a patent on the tool holder mounting system (application no. 10-2010-0012422)
- 2010. 03** Built WEB ERP (enterprise resource planning)
- 2010. 06** System Signed a function promotion agreement (HRD Korea)
- 2010. 07** Awarded the 8th Siheung-si Woman Prize (Chairman Yoon Hye-seop) - economy field
- 2010. 09** Selected as an outstanding enterprise for human resource development (Best HRD)
- 2010. 11** Productivity management system (PMS) was confirmed / Awarded IBK Export Tower - Stone Tower / Designated as a management-innovation SMB (MAIN-BIZ) by the SMBA



2024

- 2011.03 Awarded "Trader prize of this month who has brought glory to Korea" - Chairman Yoon Hye-seop
- 2011.05 "National team member agreement for the 41st UK International Vocational Training Competition"
- 2011.08 KIPO No.10-1060687 Cutting tool module of a machine tool using the dual pitch screw method
- 2011.09 ISO 14001 certification
- 2011.11 Zero hazard goal achievement threefold certification (Head office), Zero hazard goal achievement threefold certification (Factory)
- 2011.12 Awarded the 30 Million Dollar Export Tower Prize on the 48th Trade Day
- 2012.04 Achieved Excellent Green Biz certification (SMBA) - grade A
- 2012.05 Selected as an enterprise qualified for Korean-style hidden champion promotion (Export-Import Bank of Korea)
- 2012.08 Signed a rehabilitation social contribution project agreement (Siheung City Hall)
- 2013.03 Received a citation from the Minister of Knowledge Economy on the 40th Day of Commerce and Industry : Yoon Hye-seop
- 2013.04 Received a citation from the Chairman of Fair Trade Commission on the 12th Day of Fair Trade : Yoon Hye-seop
- 2013.07 Established FTA SYSTEM
- 2013.08 Obtained country of origin certification & exporter certification
- 2013.12 Awarded Siheung City 1% welfare foundation sponsor company citation by Siheung Mayor
- 2014.06 Acquired DSP Tooling (DSP)
- 2014.12 Established the standard cost operation system
- 2015.07 Opened the Incheon Logistics Center (DIW)
- 2015.12 Head office and factory were integrated and transferred - Siheung Smart Hub MTV Industrial Complex
- 2016.01 Introduced and established an automatic warehouse system / Established small tool production system for the IT industry / Newly established Busan branch
- 2016.04 Held the completion ceremony for the Sihwa Smart Hub MTV new factory
- 2016.07 Awarded a presidential medal on the 2nd Day of Enterprise of Middle Standing (Chairman Yoon Hye-seop)
- 2016.11 Awarded the Creation Technology Prize in the autumn symposium by KSMTE (Chairman Yoon Hye-seop)
- 2016.12 Awarded the 50 Million Dollar Export Tower Prize on the 55th Trade Day (Achieved 100 billion won of annual sales)
- 2017.01 Launched TAUMAX second brand; started to sell products
- 2017.02 Opened Vietnam branch (DVC)
- 2017.03 Started the solar energy generation project
- 2017.04 Selected as a 2017 small hidden champion (MOEL)
- 2018.01 Newly established Robot Division
- 2018.06 Celebrated Company's 30th anniversary
- 2018.08 Opened Nambu Branch (Ulsan/Changwon/Busan integrated)
- 2018.10 Acquired WIDIN Co., Ltd.
- 2019.11 Opened DINE SMART FACTORY Nambu Support Center
- 2020.01 Changed to independent CEO system, inaugurated as CEO Yim Soo-min
- 2020.03 Opened Thailand Branch (DTC)
- 2021.12 Received the Innovative Growth Management Award (corporate category)
- 2022.01 Establishment of Changwon Sales Office
(Changwon, Jinjoo, Sacheon, West Gyeongnam area)
- 2022.06 Established Southern Europe Branch (DMS)



TOOL APPLICATION

GSK

Milling, Drilling

OFH

Deburring

SAH

Milling, Drilling,
Flank Machining
Inner Side Machining

DBC

Rough Boring

DHE

Milling, Drilling,
Reaming

FBH/B

Boring

FBH/B

Back Boring

NPM

Milling, Drilling

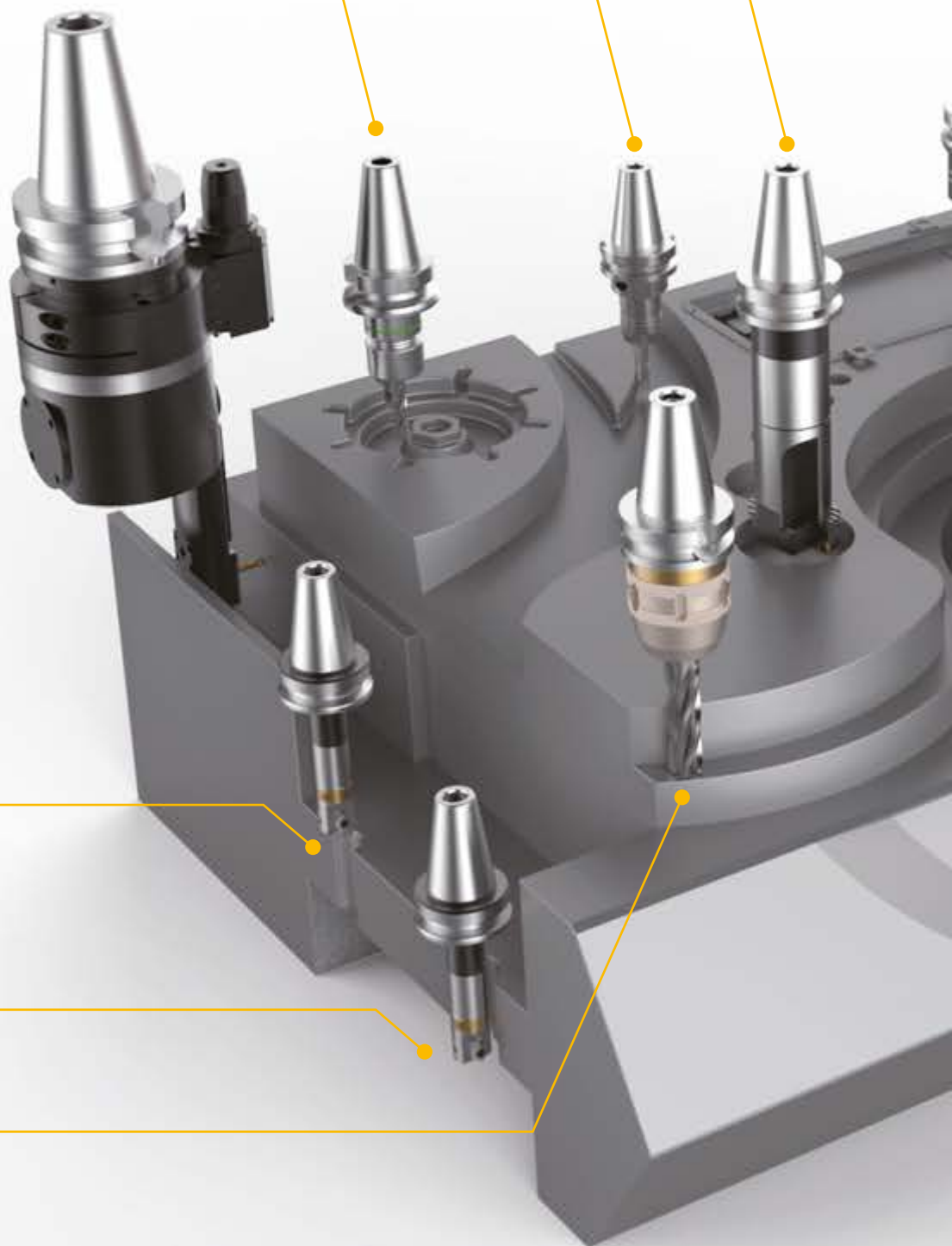



DST

Tapping

DSK

Milling, Drilling

SDC/P

Milling, Drilling,
Tapping, Chamfering

MAH

Milling, Drilling
Corner Rounding
Copy Machining
Inclined Machining

KMB

Micro Boring

SLIM DSC

Milling, Drilling, Reaming,
Chamfering

TBC • FBC

Large Boring

ANGULAR HEAD APPLICATION

KHU

0-90° Tilting Type

KAC

45° Angle Type

HRAG

Attachment Type
(Rigid Reinforced Type)

KAH

90° Angle Type



KHU

0-90° Tilting Type

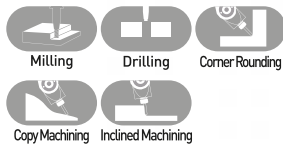

KAG

Attachment Type

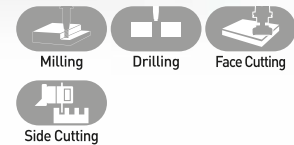

MAH

0-90° Tilting Type
(Rigid Reinforced Type)

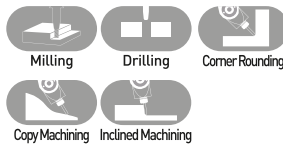

HRAG

Attachment Type
(Rigid Reinforced Type)

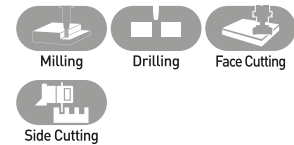

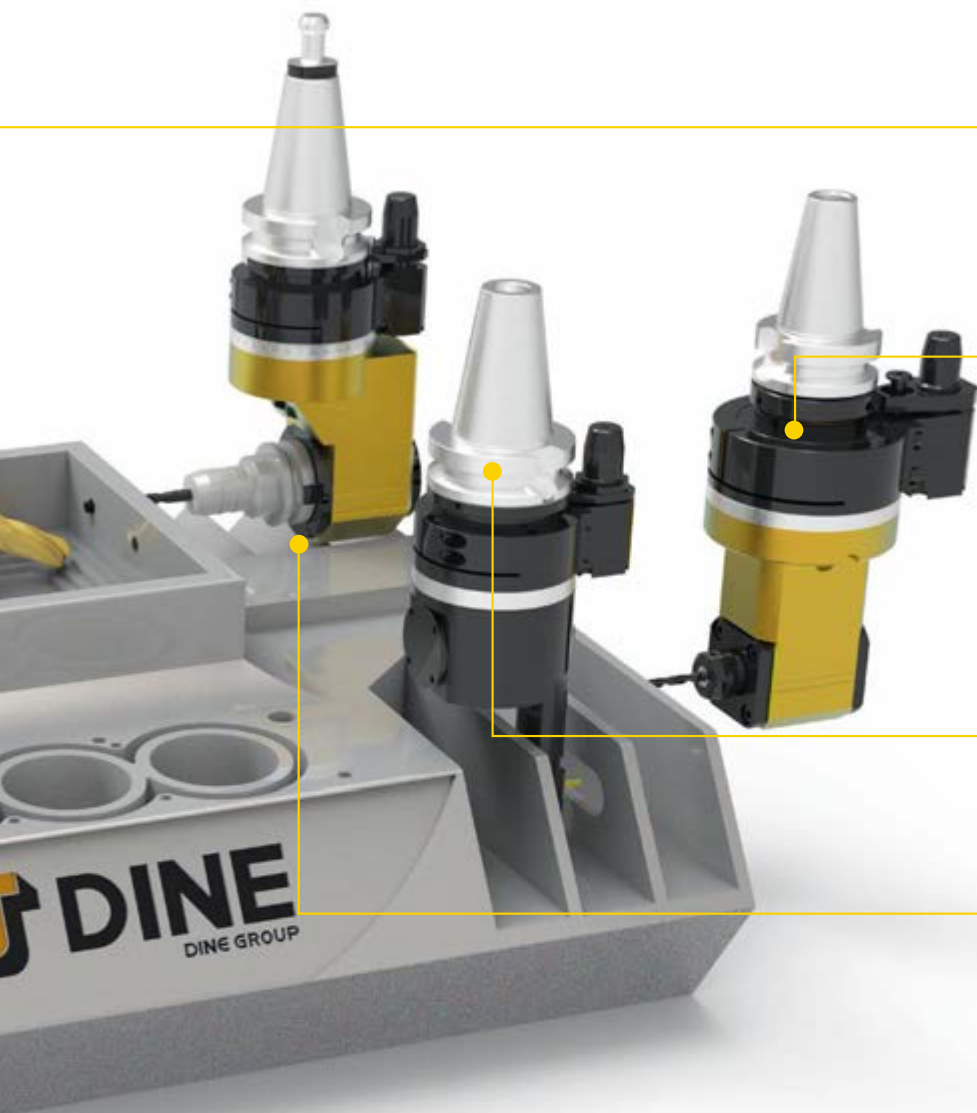

MAH

0-90° Tilting Type
(Rigid Reinforced Type)

KAH

90° Angle Type

SAH

Slim Type

KAG

Attachment Type



KAC

45° Angle Type

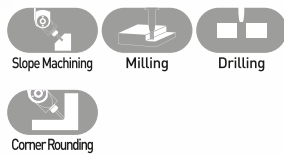

KAH

90° Angle Type



SAH

Slim Type

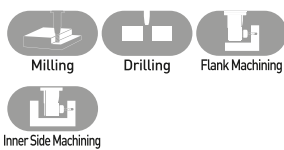

1. Hydraulic Expansion Chuck

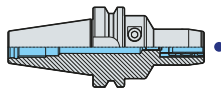

DHE Hydraulic expansion chuck

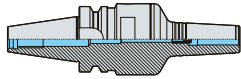

DHE/S Slim hydraulic expansion chuck



DHC DHC collet (General type)



DHC[P] DHC collet (Waterproof type)



DHJ Jet coolant collet



DZC Zero fit collet

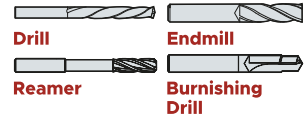

Drill

Reamer

Endmill

Burnishing Drill

2. Shrinking Chuck

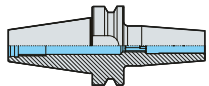

DSC Shrinking Chuck

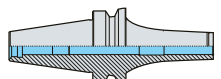

DSC/M Shrinking Chuck (Mono curve type)

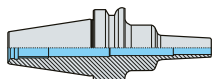

DSC/S Shrinking Chuck (Mono slim type)

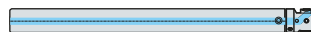

S-FBH/B Micro boring bar

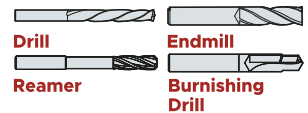

Drill

Reamer

Endmill

Burnishing Drill

3. Tapping Holder

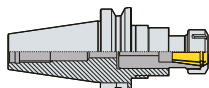

DST High speed synchro tapping chuck



TER TER Collet
ER ER Collet

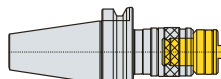

DTN Tapping holder



TCA Tap adapter



TEH Tap extension holder

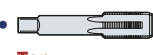

Tap

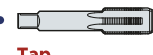

Tap

4. Drill Chuck

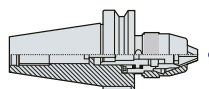

NPU Drill chuck



Drill

5. Floating Holder for Brush

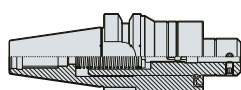

OFH Floating holder for brush



ST-OFH Floating holder for brush



Brush

6. Collet Chuck

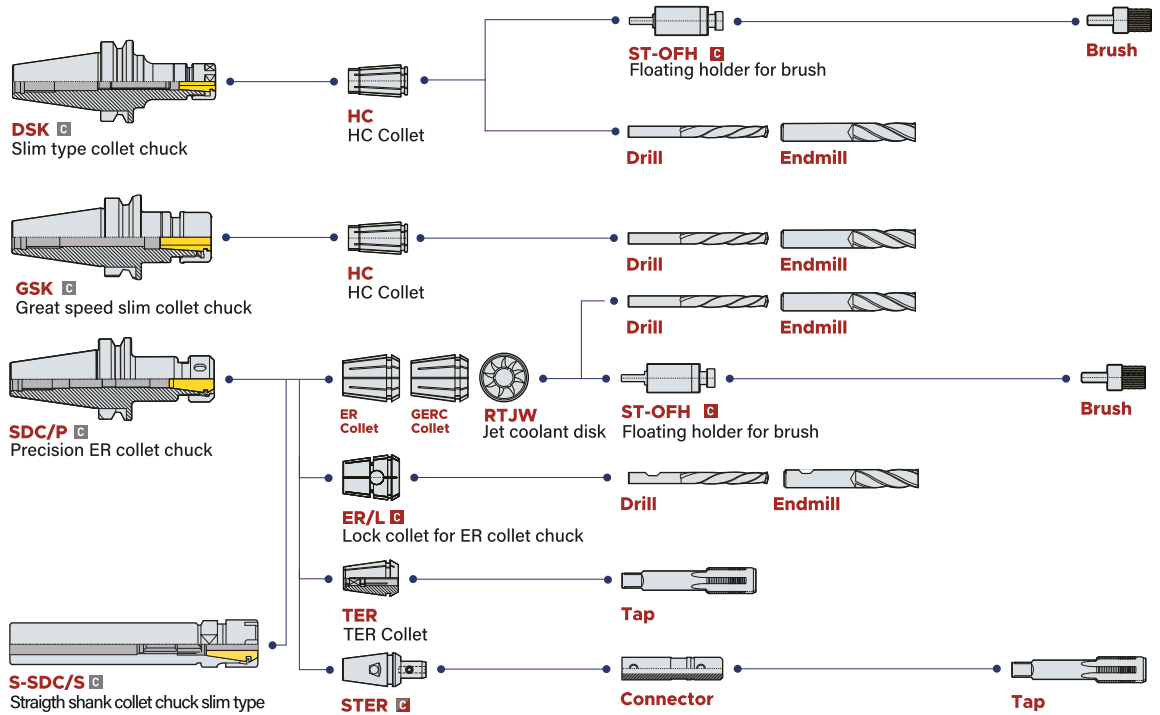

7. Milling Chuck

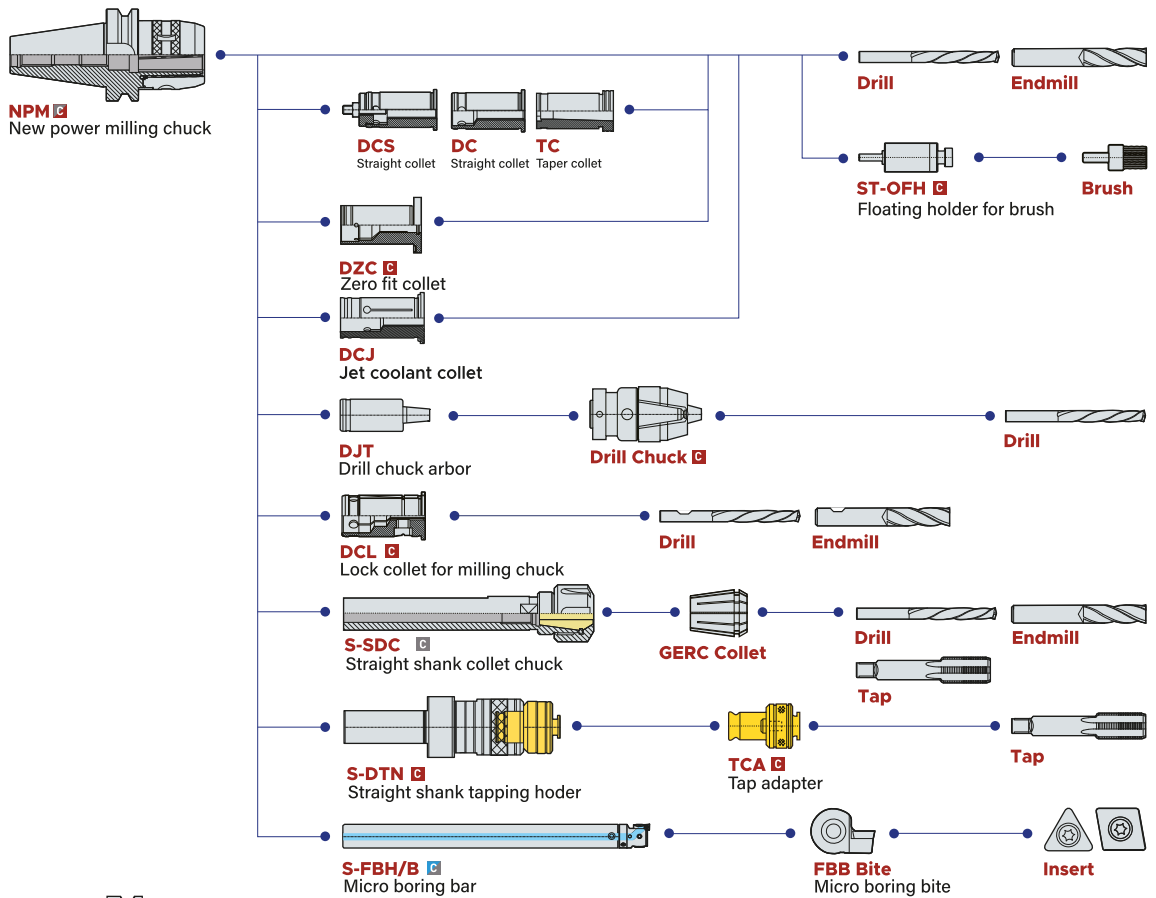

8. Side Lock Arbor

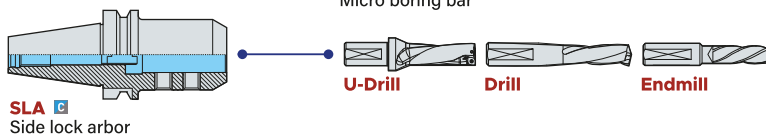

9. Morse Taper Arbor

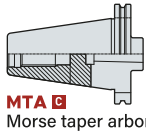

10. Face mill Arbor

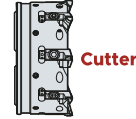
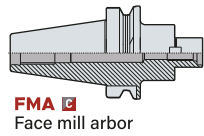

11. Air Spindle

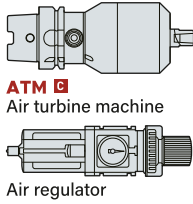

12. Angular Head

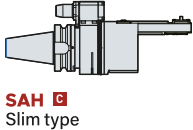
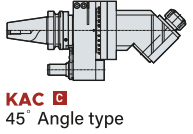
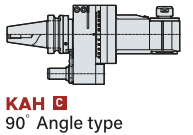
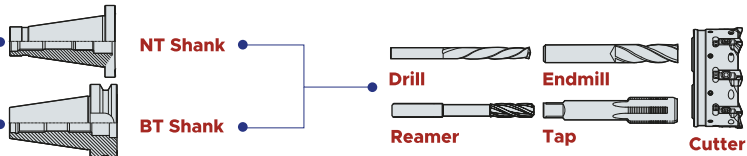
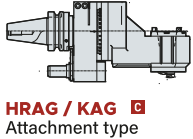
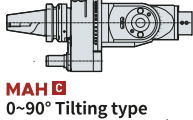
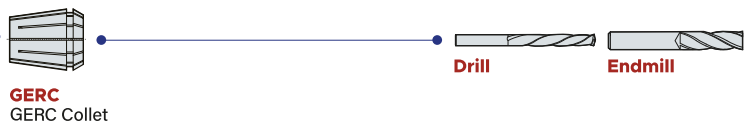
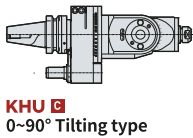

13. Boring Series

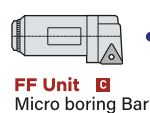
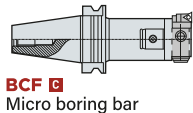
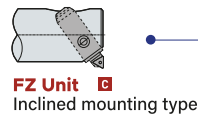
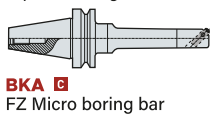
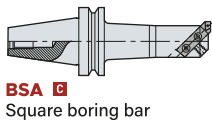

13. Boring Series

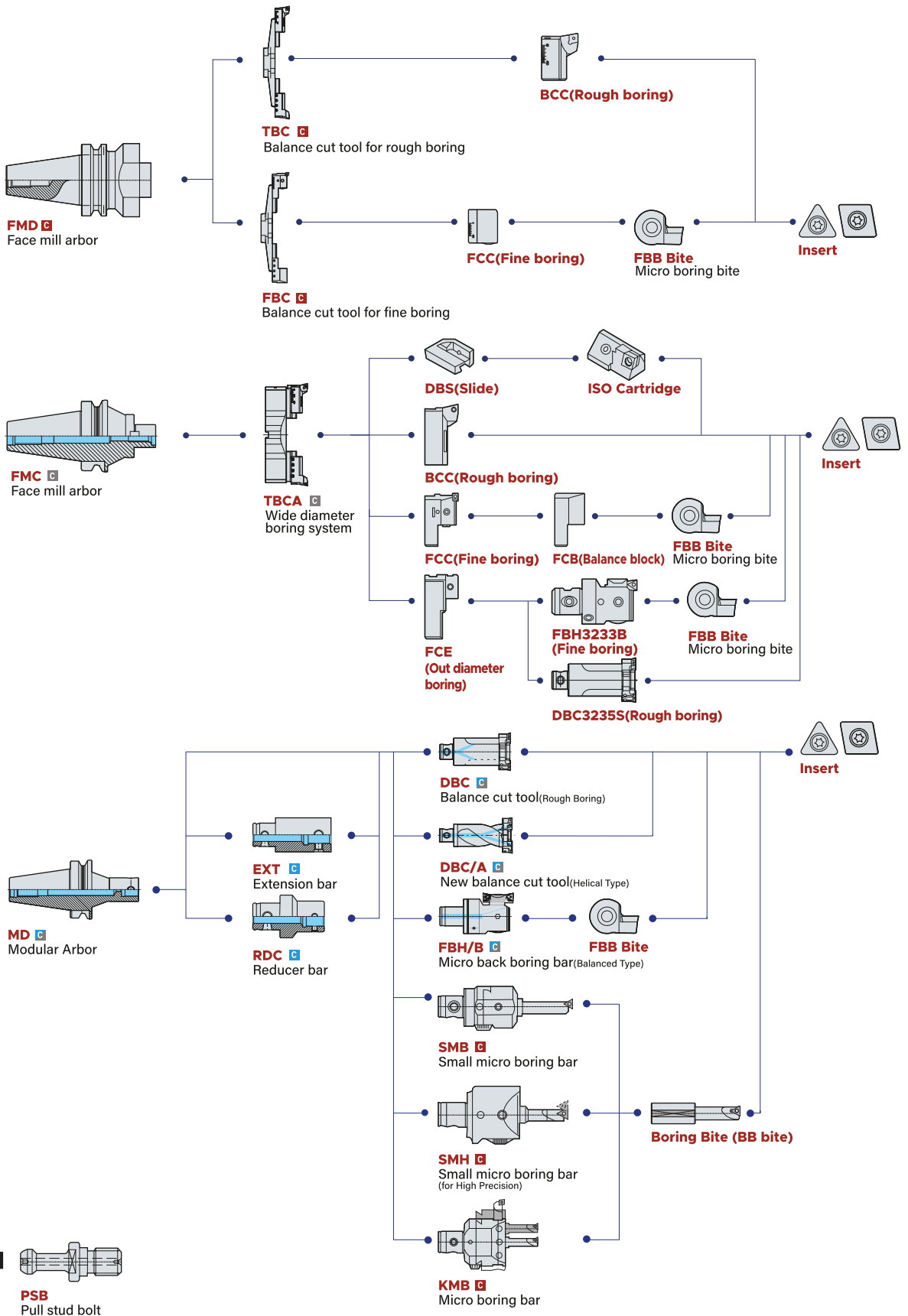

14. Pull Stud Bolt

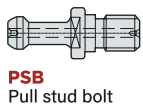

C Internal coolant system is basic **C** Internal coolant system is optional
C This product does not support the internal coolant system

Chuck



DHE
Hydraulic Expansion Chuck

34p

C



DHE/S
Slim Hydraulic Expansion Chuck

42p

C



DHE/G
Hydraulic Expansion Chuck
for Tool Grinding

NEW

46p



DSC
Shrinking Chuck

52p

C



NPM
New Power Milling Chuck

64p

C



DMC
Dine Milling Chuck

73p

NEW



SDC/P
Precision Collet Chuck for
Multi Purpose Machining

80p

C



SDC/PL
Precision Collet Chuck
(Length Adjustment Type)

89p



TXER
TAUMAX ER Collet Chuck

93p

C



DSK
Slim Type Collet Chuck

108p

C



GSK
Great Speed Slim Collet Chuck

112p

C



TSK
TAUMAX High Speed
Slim Collet Chuck

117p

C



NPU
Drill Chuck

120p

C



TNPU
TAUMAX Drill Chuck

123p

C



THPU
TAUMAX Hex Key Drill Chuck

123p

NEW



DTN
Tapping Holder

124p

C



TCA
Tap Adapter

127p



C

DST
High Speed Synchro Tapping Chuck

128p



NEW C

TEH
Tap Extension Holder

132p



C

OFH
Floating Holder for Brush

136p

Modular/Arbor



C

SLA
Side Lock Arbor

138p



C

TSLA
TAUMAX Side Lock Arbor

142p



C

MTA
Morse Taper Arbor

143p



C

TMTA
TAUMAX Morse Taper Arbor

143p



C

FMA
Face Mill Arbor

144p



C

TFMA
TAUMAX Face Mill Arbor

147p



C

FMC
Face Mill Arbor

148p



C

TFMC
TAUMAX Face Mill Arbor

152p



TFMC-L
TAUMAX Long Face Mill Arbor

153p



C

MD
Modular Arbor

154p



NEW C

TMD
TAUMAX Modular Arbor

161p

Boring Tool



C

EXT
Extension Bar

162p



RDC
Reducer Bar

162p



C

FBH/B
FBH Back Boring & Balanced Type

164p



NEW C

FBH/D
Micro Boring Bar(Damping Type)

173p

c Internal coolant system is basic

c Internal coolant system is optional

c This product does not support the internal coolant system

Boring Tool



c

DBCA
New Balance Cut Tool

178p



c

DBC
Balance Cut Tool (Rough Boring)

188p



c

TBCA
Wide Range Diameter Boring System

194p



c

TBC
Balance Cut Tool for Rough Boring

200p



c

FBC
Balance Cut Tool for Fine Boring

203p



c

SMB
Small Micro Boring Bar

207p



c

KMB
Micro Boring

209p



c

SMH
Small Micro Boring Bar

211p



BB BITE
BB Bite (for SMB, SMH, KMB)

215p



c

BSA
Square Boring Bar

216p



BH
Square Boring Bite for BSA

217p

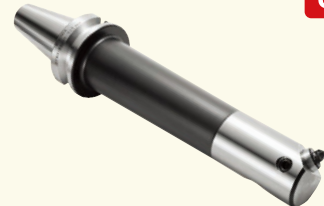

c

BKA
FZ Micro Boring Bar

218p



C

FZ UNIT

FZ Unit Inclined Mounting Type

221p



C

BCF

Micro Boring Bar

223p



C

FF UNIT

FF Unit

225p

Angular Head



C

KAH

90° Angle Type

230p



C

KHU

0-90° Tilting Type

232p



C

KAG

Attachment Type

234p



C

HRAG

Attachment Type
(Rigid Reinforced Type)

236p



C

MAH

0-90° Tilting Type
(Rigid Reinforced Type)

238p



C

KAC

45° Angle Type

240p



C

SAH

Slim Type

242p



NEW

C

ATM

Air Turbine Machine

246p



NEW

C

ATU

Air Turbine Universal Type

250p

c Internal coolant system is basic **c** Internal coolant system is optional
c This product does not support the internal coolant system

cBN/PCD



DNC100
Coated cBN

276p



DNC250
Coated cBN

277p



DNC300
Coated cBN

278p



DNC350
Coated cBN

279p



DB1000
Uncoated cBN

280p



DB2000
Uncoated cBN

281p



DB7000
Uncoated cBN

282p



DB7500
Uncoated cBN

283p



cBN Chip Breaker (GA,RA)
cBN Chip Breaker

284p



PCD Chip Breaker (UC)
New PCD Insert Chip Breaker

294p



PCD Technical data
PCD

295p

Collet

DHC
DHC Collet **48p**

DHJ
DHJ Collet **49p**

DZC
Zero Fit Collet **50p**

DCL
Lock Collet for Milling Chuck **74p**

DCJ
Jet Coolant Collet **76p**

DC
Straight Collet **77p**

TC
Taper Collet **79p**

DJT
Drill Chuck Arbor **79p**

GERC
GERC Collet **94p**

ER COLLET
ER Collet **99p**

NEW

ER-T
TAUMAX ER-T Collet **103p**

ER/L
Lock Collet for ER Collet Chuck **104p**

RTJW
Jet Coolant Disk **106p**

HC COLLET
HC Slim Collet **118p**

TER
TER Collet **131p**

STER
Synchro Tapping ER Collet **135p**

Device & Accessory

PVT
MC Power Vise **300p**

PVTM
MC Power Vise **301p**

DVT
Double Lock & Anglock Vise **303p**

MVT
MC Machine Vise **303p**

FVT
Centering Vise **304p**

NEW

QPT
Quick Point System **306p**

C Internal coolant system is basic

C Internal coolant system is optional

C This product does not support the internal coolant system

Device & Accessory



TAPER CLEANING DEVICE

Taper Cleaning Device

307p



MH-300
MH-300

308p



NEW

TOOL SHRINK BASIC

Shrinking Device

309p



C

CLEAN-TEC FAN

Cleaning Fan

312p



PRECISION MICRO ADJUSTING CARTRIDGE

Precision Micro Adjusting Cartridge

313p



PSBW

Pull Stud Bolt Wrench

313p



TTC

Tool Setting Stand

314p



NEW

TSC

T-Slot Cover

314p



TMB

Magnetic Base

315p



DIGITAL 3D TASTER

Digital 3d Taster

316p



3D

TASTER 2007

3D Taster

316p



HDG

Hydraulic Expansion Chuck Gauge

317p



DZH

DINE Z Axial Height Gauge

318p



DZP

DINE Z Axial Setting Height Gauge

318p



DZOP

DINE Z Axial P Reset Gauge

319p



DOP

DINE Optical Edge Finder

319p



ROT
Run-out Tester

320p



TB
Test Bar

321p



SC
Spindle Cleaner

321p



NTSS
New Tool Setting Stand

322p



PULL STUD BOLT
Pull Stud Bolt

323p



NEW

PSB-T
TAUMAX Pull Stud Bolt-T

324p



BALANCING SYSTEM

The Necessity of Balancing Work

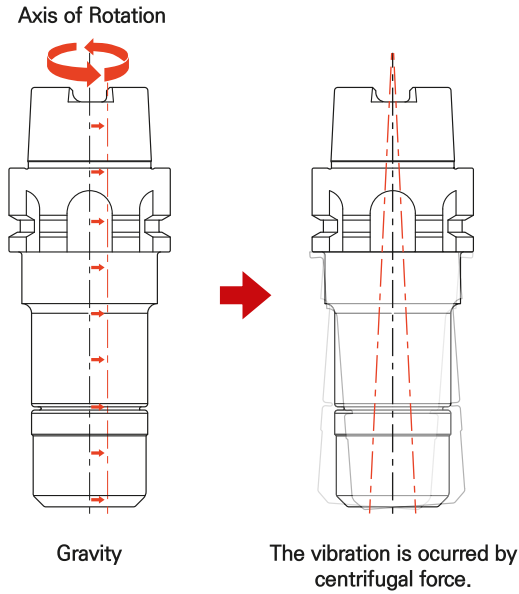

The cause of unbalancing

Asymmetry of tool holder shape and weight imbalance.

The problem of unbalancing

The vibration in the tool by centrifugal force leads to noise and deterioration of surface roughness and tool life.

The necessity of balancing work

Balancing work is necessary for better surface roughness, accuracy and tool life.

※ The phenomenon is that the center of gravity in tool keeps off from a rotation axis

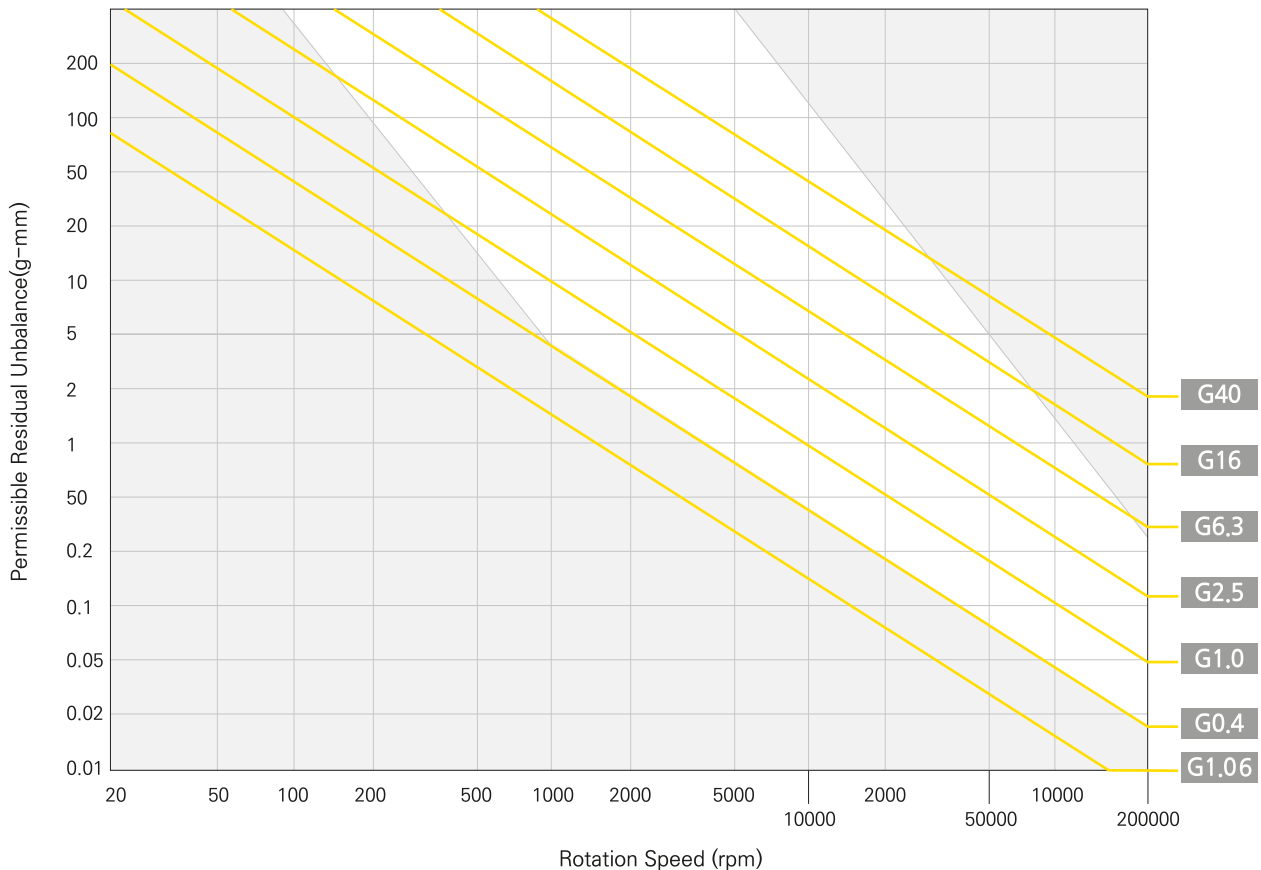

1:1 CHAT



BALANCING SYSTEM

Balancing

The most optimal accuracy at high-speed

1. Keep high-accuracy and rigidity without bending of rotating product due to unbalanced load
2. Excellent balance($\leq G2.5$ or $0.5 \text{ g}\cdot\text{mm}/\text{kg}$)
3. Improve tool life, surface finish, dimension of accuracy and productivity at high-speed

Balancing Grade Standard

The possibility of multiple balancing's quality

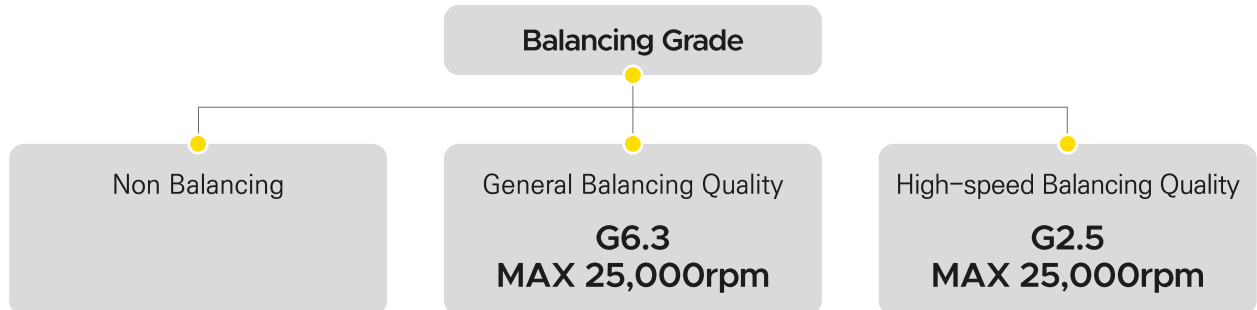

BT, SK Shank	HSK Shank
Balancing Type with Hole	Balancing Type with Hole

Chuck

Arbor/Modular

Boring Tool

Angular Head

cBN/PCD

Device&Accessory

Standard

1:1 CHAT



DBT Series PAT.

For High-speed Machining

DBT Spindle System

2 Face contact type (taper and flange face) for high speed, roughing, finishing and surface roughness

The advantage of 2 face contact type

- Improved surface quality and dimensional accuracy
- Extended tool life
- Improved ATC repeatability
- Eliminate Z-axis movement error during high-speed movement



BT Type

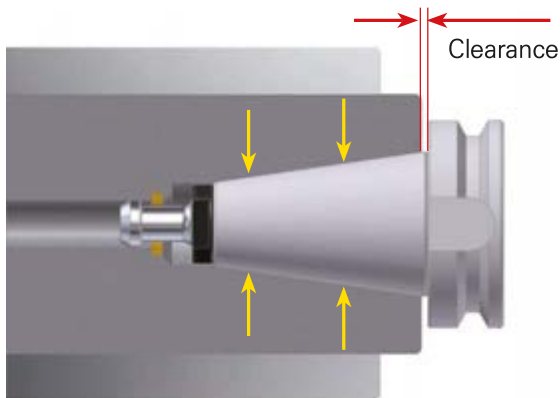

The clearance between spindle and flange face

DBT Type

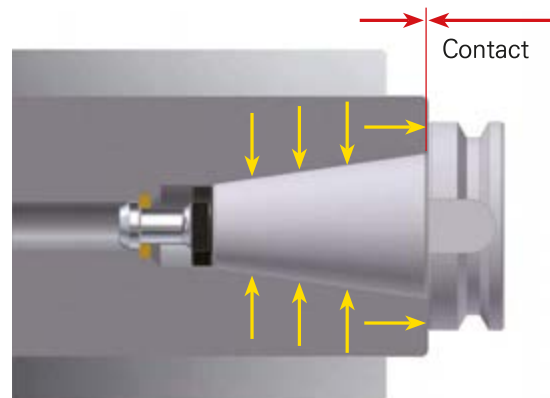

Perfect face contact
(Improved precision and stability)

Powerful Clamping

Unlike BT, DBT shank has better clamping force because of contact both the taper and flange faces

Shank	External Diameter of Taper	External Diameter of Flange
BT30	Ø 31.7	⇒ Ø 46
BT40	Ø 44.4	⇒ Ø 63
BT50	Ø 69.3	⇒ Ø 100

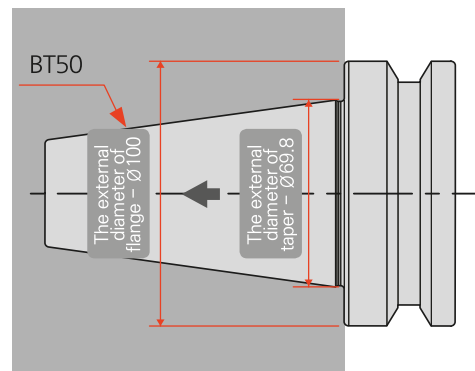

Difference between taper cross-section contact and flange external diameter contact, For high speed machining

1:1 CHAT



HSK TOOLING SYSTEM

DIN69893-1, ISO12164-1:2001

2 Face Constrained Tool Holder

The 7/24 taper shank for multi-purpose has been pointed out that its performance is inappropriate in terms of repeatability, joint stiffness and high-speed machining. Drawbacks of 7/24 taper shank had been eliminated by using new two face contact.

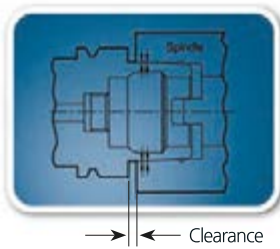

Elastic deformation of taper makes flange

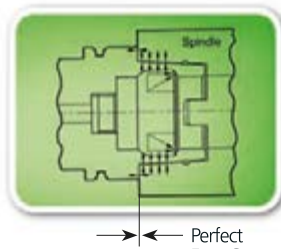

Excellent Repeatability – Run-out Accuracy

As taper of holder elastically deform following the profile of the spindle shape, there is no eccentricity between the spindle and holder. Also, due to perfect face contacts between flange of the holder and spindle face, bending strength of the holder becomes very high, It decides run out accuracy.

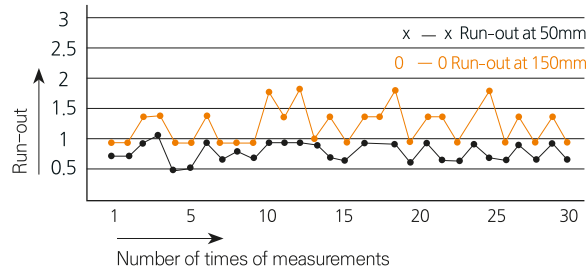
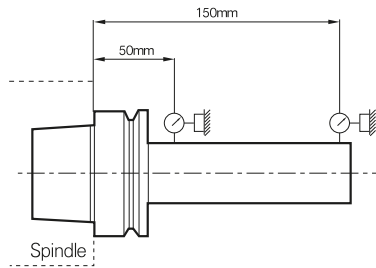

High Rigidity Against Bending Load

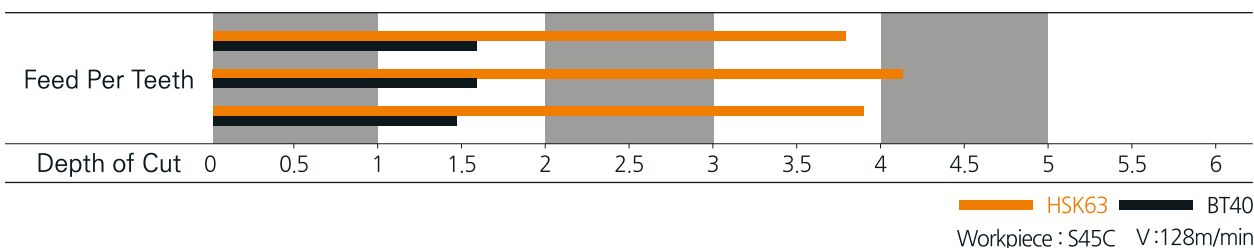
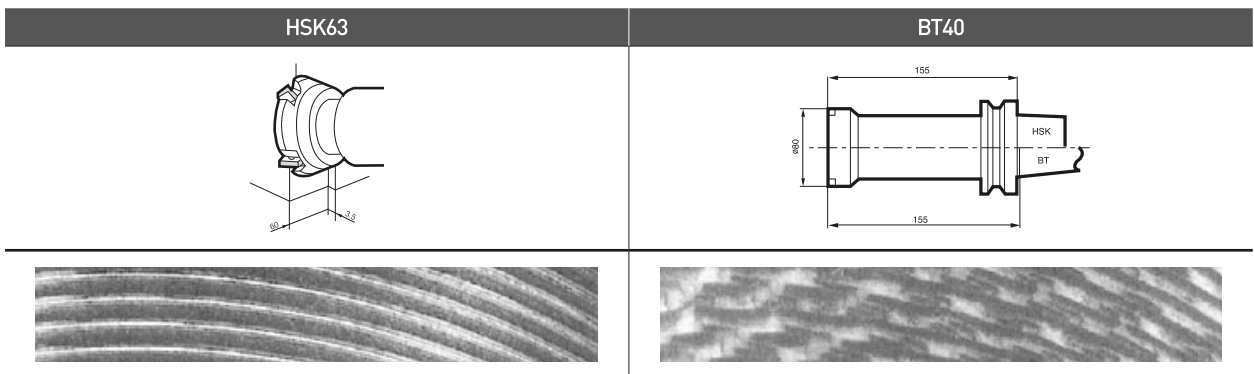

1:1 CHAT



CATALOGUE MANUAL

NC TOTAL TOOLING SYSTEM

Significant Pictogram Description

Common Pictogram

G6.3 Rotational durability value G value	Ø25 Max. endmill diameter Max Dia	C Internal coolant system is basic Coolant System
15,000 Allowable rotation value Max RPM	130 Min. boring diameter Min Range	C Internal coolant system is optional Coolant System
5µm Vibration tolerance Run-out	535 Max. boring diameter Max Range	C This product does not support the internal coolant system Coolant System

ISO Shank Specifications

MAS 403-BT Shank	MAS403 spec. BT shank
DIN 69871 -1A/B Shank	ISO 7388/1 : 1983(E) spec. SK shank
DIN 69893-1 Shank	ISO 12164-1 : 2001 spec. HSK shank
DIN 2080 JISB6101 Shank	ISO 297 : 1988(E) spec. NT shank

Insert

0.3mm Max Depth Max. Cutting Depth	Coating Coating Insert		
K Cast Iron	H Heat-treated steel	Sintered Parts Sintered Parts	Recommended machining grade

Intermittent Cutting Intensity

Continuous	Light Interrupted	Medium Interrupted	Heavy Interrupted
-------------------	--------------------------	---------------------------	--------------------------

Recommended Machining Works by Products



Angular Head Machining



Contact Us as KakaoTalk



Run KakaoTalk

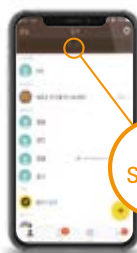

Click Find Friends

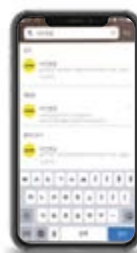

Search for "Dine Inc."

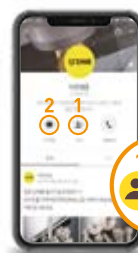

Start "1:1 Chatting" after adding friends



Make an inquiry



Chuck

DINE TOTAL TOOLING SOLUTION

DHE	34
DHE/S	42
DHE/G	46
DHC Collet (General & Sealed Type)	48
DHJ Collet (Jet Coolant)	49
DZC Collet	50
DSC	52
NPM	64
DMC	73
DCL Collet	74
DCJ Collet	76
DC Collet	77
DCS Collet	78
TC Collet	79
DJT	79
SDC/P	80
SDC/PL	89
TXER	93
GERC Collet	94
ER Collet	99
ER-T Collet	103
ER/L Collet	104
RTJW	106
DSK	108
GSK	112
TSK	117
HC Collet	118
NPU	120
TNPU	123
THPU	123
DTN	124
TCA	127
DST	128
TER Collet	131
TEH	132
STER	135
OFH	136

1:1 CHAT



DHE

Hydraulic Expansion Chuck



G6.3

G value

25,000

Max RPM

5 μ m

Run-out

C

Coolant System

Milling

Drilling

Reaming

Features

- Improved work efficiency through the convenient attachment/detachment of tools
- Improved tool life due to high-precision
- Reduced vibration during machining through the damping effects of the hydraulic chamber
- Tool clamping range : $\varnothing 4\text{-}\varnothing 32\text{mm}$

NAMING

BT40

Spindle

DHE

Hydraulic Expansion Chuck

20

Tool Dia.

140

Length

Product Features

Its high-precision not only increases the tool life of a cutting tool by reducing the wear of the tool but also improves machining surface roughness with the effect of vibration reduction by its hydraulic seal.

Completely Closed Inside Construction(Durability)

- The completely closed system of its inner diameter prevents dust, cutting oil, lubricant, and chips, etc. from penetrating it
- Maintains clamping force and precision for a long time

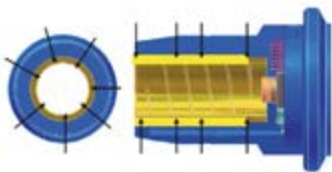

Shank	Grade	Max. RPM
BT50, SK50, HSK100A	G6.3	15,000
BT40, SK40, HSK63A	G6.3	20,000
BT30	G6.3	25,000



C Internal coolant system is basic (DBT, BT, SK Shank)

C Internal coolant system is optional (HSK Shank)

High Precision

- Run-out : 5 μ m or Below
- L = 3 x \varnothing D
- Shank : Tolerance of \varnothing Dh6

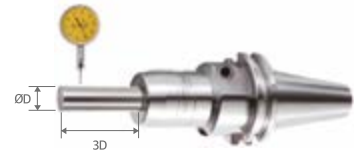

Removal Availability by Using T-wrench Tool

- Clamping/unclamping structure that only requires simple operation (convenience)
- Reduces operator fatigue
- Enhances the operation rate of equipment



Stable Clamping Force

- Provides clamping force by fixing the space of the holder and tool with hydraulic pressure



1:1 CHAT



DBT-DHE

Hydraulic Expansion Chuck

DBT

Shank

G6.3

G value

25,000

Max RPM

5 μ m

Run-out

C

Coolant System



Milling



Drilling



Reaming



Fig.1

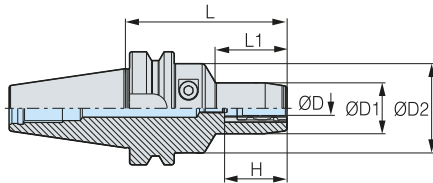
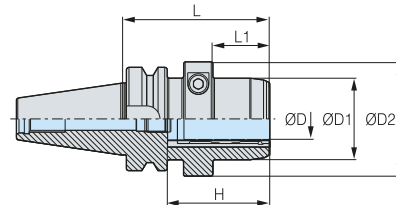

Fig.2



- : Stock
- H : Depth of tool insertion (Min.~Max.)
- C Internal coolant system is basic

- For more information on product features, see **34P**
- For more information on the related parts, see **41P**

	Designation	ØD	L	ØD1	ØD2	L1	H	ADJ	RPM	Fig.	kg	Package Weight(kg)	Stock
DBT30	DBT30-DHE6-65	6	65	29	46	33	30~40	M5	25,000	1	0.7	0.8	
	DBT30-DHE8-65	8	65	31	46	33	30~40	M5	25,000	1	0.7	0.8	
	DBT30-DHE10-65	10	65	32	46	34	35~45	M5	25,000	1	0.7	0.8	
	DBT30-DHE12-70	12	70	35	46	34	41~51	M5	25,000	1	0.8	0.8	
	DBT30-DHE14-90	14	90	36	46	40	43~53	M5	25,000	1	1	1.1	
	DBT30-DHE16-90	16	90	40	46	45	46~56	M5	25,000	1	1	1.1	
	DBT30-DHE18-90	18	90	42	46	40	49~59	M5	25,000	1	1.1	1.2	
	DBT30-DHE20-90	20	90	44	46	45	49~59	M5	25,000	1	1.1	1.2	●
DBT40	DBT40-DHE6-90	6	90	29	50	40	30~40	M5	20,000	1	1.4	1.6	●
	DBT40-DHE6-140	6	140	29	50	40	30~40	M5	20,000	1	2.2	2.5	
	DBT40-DHE8-90	8	90	31	50	40	30~40	M5	20,000	1	1.4	1.6	●
	DBT40-DHE8-140	8	140	31	50	40	30~40	M5	20,000	1	2.2	2.5	
	DBT40-DHE10-90	10	90	33	50	40	35~45	M5	20,000	1	1.5	1.7	●
	DBT40-DHE10-140	10	140	33	50	40	35~45	M5	20,000	1	2.2	2.4	
	DBT40-DHE12-90	12	90	35	50	40	41~51	M10	20,000	1	1.5	1.7	●
	DBT40-DHE12-140	12	140	35	50	40	41~51	M10	20,000	1	2.3	2.5	
	DBT40-DHE14-90	14	90	36	50	40	43~53	M10	20,000	1	1.5	1.7	●
	DBT40-DHE14-140	14	140	36	50	40	43~53	M10	20,000	1	2.2	2.4	
	DBT40-DHE16-90	16	90	40	50	45	46~56	M10	20,000	1	1.5	1.7	●
	DBT40-DHE16-140	16	140	40	50	45	46~56	M10	20,000	1	2.2	2.5	
	DBT40-DHE18-90	18	90	42	50	45	49~59	M10	20,000	1	1.5	1.7	●
	DBT40-DHE18-140	18	140	42	50	45	49~59	M10	20,000	1	2.2	2.5	
	DBT40-DHE20-90	20	90	44	50	47	49~59	M10	20,000	1	1.5	1.7	●
	DBT40-DHE20-140	20	140	44	50	50	49~59	M10	20,000	1	2.3	2.5	
	DBT40-DHE25-90	25	90	50	70	35	58~68	M16	20,000	2	2	2.2	●
	DBT40-DHE32-90	32	90	63	75	35	58~68	M16	20,000	2	2.3	2.5	●

(Unit : mm)

1:1 CHAT



DBT-DHE

Hydraulic Expansion Chuck

DBT
Shank

G6.3
G value

15,000
Max RPM

5_μm
Run-out

C
Coolant System

Milling

Drilling

Reaming



Fig.1

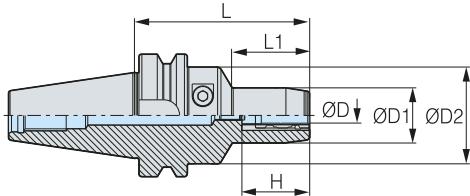
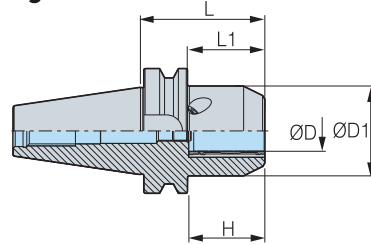

Fig.2



• ● : Stock

• H : Depth of tool insertion (Min.~Max.)

C Internal coolant system is basic

• For more information on product features, see **34P**

• For more information on the related parts, see **41P**

	Designation	ØD	L	ØD1	ØD2	L1	H	ADJ	RPM	Fig.	kg	Package Weight(kg)	Stock	
DBT50	DBT50-DHE6-90	6	90	29	50	34	30~40	M5	15,000	1	3.9	4.2		
	DBT50-DHE6-140	6	140	29	50	40	30~40	M5	15,000	1	4.5	4.8		
	DBT50-DHE8-90	8	90	31	50	34	30~40	M5	15,000	1	4.2	4.5		
	DBT50-DHE8-140	8	140	31	50	40	30~40	M5	15,000	1	4.6	5		
	DBT50-DHE10-90	10	90	33	50	34	35~45	M5	15,000	1	3.9	4.2		
	DBT50-DHE10-140	10	140	33	50	34	35~45	M5	15,000	1	4.5	4.9		
	DBT50-DHE12-90	12	90	35	50	34	41~51	M10	15,000	1	4	4.3		
	DBT50-DHE12-140	12	140	35	50	34	41~51	M10	15,000	1	4.6	5		
	DBT50-DHE14-90	14	90	36	50	34	43~53	M10	15,000	1	3.9	4.2		
	DBT50-DHE14-140	14	140	36	50	34	43~53	M10	15,000	1	4.5	4.9		
	DBT50-DHE16-90	16	90	40	50	34	46~56	M10	15,000	1	4.1	4.4		
	DBT50-DHE16-140	16	140	40	50	34	46~56	M10	15,000	1	4.7	5.1		
	DBT50-DHE18-90	18	90	42	50	40	49~59	M10	15,000	1	4	4.3		
	DBT50-DHE18-140	18	140	42	50	45	49~59	M10	15,000	1	4.5	4.9		
	DBT50-DHE20-90	20	90	44	50	34	49~59	M10	15,000	1	4.2	4.3		
	DBT50-DHE20-140	20	140	44	50	47	49~59	M10	15,000	1	4.5	4.9		
	DBT50-DHE25-90	25	90	66	-	52	58~68	M16	15,000	2	4.7	5		
	DBT50-DHE32-90	32	90	72	-	52	58~68	M16	15,000	2	4.8	6.2		

(Unit : mm)

1:1 CHAT



BT-DHE

Hydraulic Expansion Chuck

MAS
403-BT

Shank

G6.3

G value

25,000

Max RPM

5 μ m

Run-out

C

Coolant System



Milling



Drilling



Reaming



Fig.1

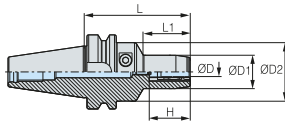

Fig.2

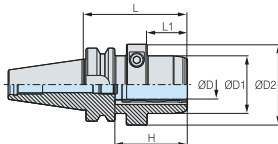

Fig.3

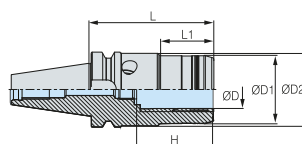
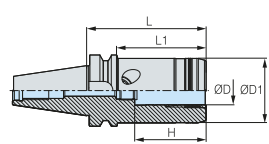

Fig.4



● : Stock

• H : Depth of tool insertion (Min.~Max.)

C Internal coolant system is basic

• For more information on product features, see **34P**

• For more information on the related parts, see **41P**

	Designation	ØD	L	ØD1	ØD2	L1	H	ADJ	RPM	Fig.	kg	Package Weight(kg)	Stock
BT30	BT30-DHE4-65	4	65	29	46	33	40	-	25,000	1	0.7	0.8	●
	BT30-DHE5-65	5	65	29	46	33	40	-	25,000	1	0.7	0.8	●
	BT30-DHE6-65	6	65	29	46	33	30~40	M5	25,000	1	0.7	0.8	●
	BT30-DHE8-65	8	65	31	46	33	30~40	M5	25,000	1	0.7	0.8	●
	BT30-DHE10-65	10	65	32	46	34	35~45	M5	25,000	1	0.7	0.8	●
	BT30-DHE12-70	12	70	35	46	34	36~46	M5	25,000	1	0.8	0.8	●
	BT30-DHE14-90	14	90	36	46	40	43~53	M5	25,000	1	1.0	1.1	●
	BT30-DHE16-90	16	90	40	46	45	46~56	M5	25,000	1	1.0	1.1	●
	BT30-DHE18-90	18	90	42	46	40	49~59	M5	25,000	1	1.1	1.2	●
	BT30-DHE20-90	20	90	44	46	45	49~59	M5	25,000	1	1.1	1.2	●
BT40	BT40-DHE4-90	4	90	29	50	40	40	-	20,000	1	1.4	1.6	●
	BT40-DHE5-90	5	90	29	50	40	40	-	20,000	1	1.4	1.6	●
	BT40-DHE6-90	6	90	29	50	40	30~40	M5	20,000	1	1.4	1.6	●
	BT40-DHE6-140	6	140	29	50	40	30~40	M5	20,000	1	2.2	2.5	●
	BT40-DHE8-90	8	90	31	50	40	30~40	M5	20,000	1	1.4	1.6	●
	BT40-DHE8-140	8	140	31	50	40	30~40	M5	20,000	1	2.2	2.5	●
	BT40-DHE10-90	10	90	33	50	40	35~45	M5	20,000	1	1.5	1.7	●
	BT40-DHE10-140	10	140	33	50	40	35~45	M5	20,000	1	2.2	2.4	●
	BT40-DHE12-90	12	90	35	50	40	41~51	M10	20,000	1	1.5	1.7	●
	BT40-DHE12-140	12	140	35	50	40	41~51	M10	20,000	1	2.3	2.5	●
	BT40-DHE14-90	14	90	36	50	40	43~53	M10	20,000	1	1.5	1.7	●
	BT40-DHE14-140	14	140	36	50	40	43~53	M10	20,000	1	2.2	2.4	●
	BT40-DHE16-90	16	90	40	50	45	46~56	M10	20,000	1	1.5	1.7	●
	BT40-DHE16-140	16	140	40	50	45	46~56	M10	20,000	1	2.2	2.5	●
	BT40-DHE18-90	18	90	42	50	45	49~59	M10	20,000	1	1.5	1.7	●
	BT40-DHE18-140	18	140	42	50	45	49~59	M10	20,000	1	2.2	2.5	●
	BT40-DHE20-90	20	90	44	50	47	49~59	M10	20,000	1	1.5	1.7	●
	BT40-DHE20-140	20	140	44	50	50	49~59	M10	20,000	1	2.3	2.5	●
	BT40-DHE25-90	25	90	50	70	35	58~68	M16	20,000	2	2.0	2.2	●
	BT40-DHE25-105	25	105	57	-	78	51~61	M16	20,000	4	2.0	2.2	●
BT40-DHE25-140	25	140	57	-	113	51~61	M16	20,000	4	2.6	2.9	●	
BT40-DHE32-90	32	90	63	75	35	58~68	M16	20,000	2	2.3	2.5	●	
BT40-DHE32-105	32	105	57	61	45	55~65	M16	20,000	3	2.4	2.6	●	
BT40-DHE32-140	32	140	57	61	45	55~65	M16	20,000	3	3.0	3.2	●	

(Unit : mm)

Chuck

Arbor/Modular

Boring Tool

Angular Head

cBN/PCD

Device&Accessory

Standard

1:1 CHAT



BT-DHE

Hydraulic Expansion Chuck

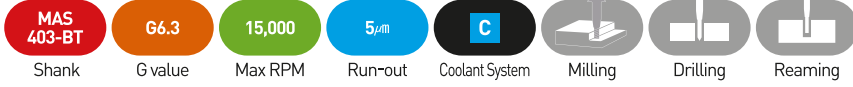

Fig.1

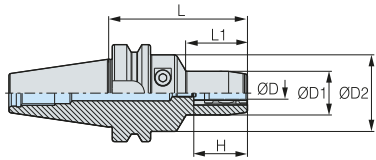

Fig.2

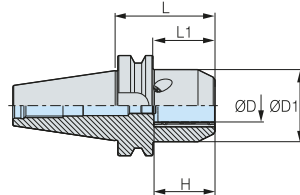
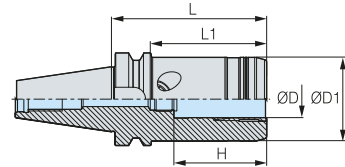

Fig.3



- : Stock
- H : Depth of tool insertion (Min.~Max.)
- C** Internal coolant system is basic

- For more information on product features, see **34P**
- For more information on the related parts, see **41P**

Designation	ØD	L	ØD1	ØD2	L1	H	ADJ	RPM	Fig.	kg	Package Weight (kg)	Stock
BT50-DHE4-90	4	90	29	50	34	40	-	15,000	1	3.9	4.2	●
BT50-DHE5-90	5	90	29	50	34	40	-	15,000	1	3.9	4.2	●
BT50-DHE6-90	6	90	29	50	34	30~40	M5	15,000	1	3.9	4.2	●
BT50-DHE6-140	6	140	29	50	40	30~40	M5	15,000	1	4.4	4.8	●
BT50-DHE8-90	8	90	31	50	34	30~40	M5	15,000	1	4.2	4.5	●
BT50-DHE8-140	8	140	31	50	40	30~40	M5	15,000	1	4.6	5.0	●
BT50-DHE10-90	10	90	33	50	34	35~45	M5	15,000	1	3.9	4.2	●
BT50-DHE10-140	10	140	33	50	34	35~45	M5	15,000	1	4.5	4.9	●
BT50-DHE12-90	12	90	35	50	34	41~51	M10	15,000	1	4.0	4.3	●
BT50-DHE12-140	12	140	35	50	34	41~51	M10	15,000	1	4.6	5.0	●
BT50-DHE14-90	14	90	36	50	34	43~53	M10	15,000	1	3.9	4.2	●
BT50-DHE14-140	14	140	36	50	34	43~53	M10	15,000	1	4.5	4.9	●
BT50-DHE16-90	16	90	40	50	34	46~56	M10	15,000	1	4.1	4.4	●
BT50-DHE16-140	16	140	40	50	34	46~56	M10	15,000	1	4.7	5.1	●
BT50-DHE18-90	18	90	42	50	40	49~59	M10	15,000	1	4.0	4.3	●
BT50-DHE18-140	18	140	42	50	45	49~59	M10	15,000	1	4.5	4.9	●
BT50-DHE20-90	20	90	44	50	34	49~59	M10	15,000	1	4.0	4.3	●
BT50-DHE20-140	20	140	44	50	47	49~59	M10	15,000	1	4.5	4.9	●
BT50-DHE25-90	25	90	66	-	52	58~68	M16	15,000	2	4.7	5.0	●
BT50-DHE25-150	25	150	57	-	112	51~61	M16	15,000	3	4.5	4.8	●
BT50-DHE32-90	32	90	72	-	52	58~68	M16	15,000	2	5.8	6.2	●

(Unit : mm)

1:1 CHAT



HSK-DHE

Hydraulic Expansion Chuck

DIN
69893-1

Shank

G6.3

G value

20,000

Max RPM

5 μ m

Run-out

C

Coolant System



Milling



Drilling



Reaming



Fig.1

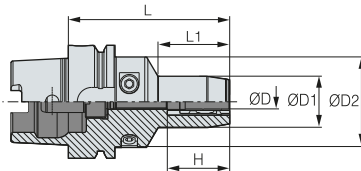
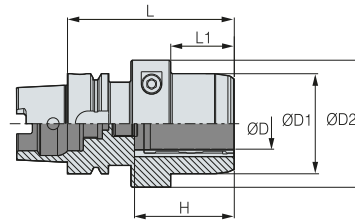

Fig.2



- : Stock
- H : Depth of tool insertion (Min.~Max.)

C Internal coolant system is optional

- For more information on product features, see **34P**
- For more information on the related parts, see **41P**

	Designation	ØD	L	ØD1	ØD2	L1	H	ADJ	Fig.	RPM	kg	Package Weight (kg)	Stock
HSK50A	HSK50A-DHE6-70	6	70	29	40	28	30~40	M5	1	20,000	0.7	0.8	
	HSK50A-DHE8-70	8	70	31	40	28	30~40	M5	1	20,000	0.7	0.9	
	HSK50A-DHE10-80	10	80	33	40	35	35~45	M5	1	20,000	0.8	0.9	
	HSK50A-DHE12-90	12	90	35	40	40	41~51	M5	1	20,000	0.8	1	
	HSK50A-DHE14-95	14	95	36	53	28	43~53	M10	2	20,000	0.8	1.2	
	HSK50A-DHE16-95	16	95	40	53	28	46~56	M10	2	20,000	0.9	1.3	
	HSK50A-DHE18-100	18	100	42	60	28	49~59	M10	2	20,000	0.9	1.4	
	HSK50A-DHE20-100	20	100	44	60	28	49~59	M10	2	20,000	0.9	1.5	
HSK63A	HSK63A-DHE4-75	4	75	29	50	34	40	-	1	20,000	1	1.2	●
	HSK63A-DHE5-75	5	75	29	50	34	40	-	1	20,000	1	1.2	●
	HSK63A-DHE6-75	6	75	29	50	34	30~40	M5	1	20,000	1	1.2	●
	HSK63A-DHE6-150	6	150	29	50	34	30~40	M5	1	20,000	2.2	2.4	
	HSK63A-DHE8-75	8	75	31	50	34	30~40	M5	1	20,000	1	1.2	●
	HSK63A-DHE8-150	8	150	31	50	34	30~40	M5	1	20,000	2.2	2.4	
	HSK63A-DHE10-85	10	85	33	50	34	35~45	M5	1	20,000	1.2	1.4	●
	HSK63A-DHE10-150	10	150	33	51	34	35~45	M5	1	20,000	2.2	2.4	●
	HSK63A-DHE12-90	12	90	35	51	40	41~51	M10	1	20,000	1.2	1.4	●
	HSK63A-DHE12-150	12	150	35	51	40	41~51	M10	1	20,000	2.2	2.4	●
	HSK63A-DHE14-95	14	95	36	52	40	42~53	M10	1	20,000	1.3	1.5	
	HSK63A-DHE14-150	14	150	36	52	40	43~53	M10	1	20,000	2.2	2.4	
	HSK63A-DHE16-95	16	95	40	52	45	46~56	M10	1	20,000	1.3	1.5	●
	HSK63A-DHE16-150	16	150	40	53	45	46~56	M10	1	20,000	2.2	2.4	
	HSK63A-DHE18-100	18	100	42	53	45	49~59	M10	1	20,000	1.4	1.7	
	HSK63A-DHE18-150	18	150	42	53	45	49~59	M10	1	20,000	2.2	2.4	
	HSK63A-DHE20-100	20	100	44	50	50	49~59	M10	1	20,000	1.4	1.7	●
	HSK63A-DHE20-150	20	150	44	50	50	49~59	M10	1	20,000	2.2	2.4	●
	HSK63A-DHE25-110	25	110	50	70	48	56~68	M16	2	20,000	1.9	2.1	●
	HSK63A-DHE32-110	32	110	63	80	48	56~68	M16	2	20,000	2.3	2.5	●

(Unit : mm)

1:1 CHAT



HSK-DHE

Hydraulic Expansion Chuck

DIN
69893-1

Shank

G6.3

G value

15,000

Max RPM

5_μm

Run-out

C

Coolant System



Milling



Drilling



Reaming

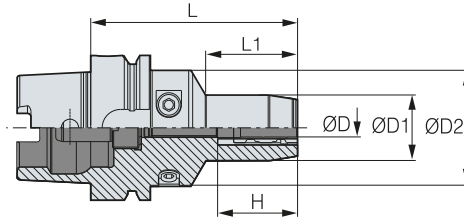

● : Stock

• H : Depth of tool insertion (Min.~Max.)

Ⓢ Internal coolant system is optional

• For more information on product features, see **34P**

• For more information on the related parts, see **41P**

	Designation	ØD	L	ØD1	ØD2	L1	H	ADJ	RPM	kg	Package Weight (kg)	Stock
HSK100A	HSK100A-DHE6-80	6	80	29	50	34	30~40	M5	15,000	2.4	2.6	●
	HSK100A-DHE6-150	6	150	29	50	34	30~40	M5	15,000	2.8	3	
	HSK100A-DHE8-80	8	80	31	50	34	30~40	M5	15,000	2.4	2.6	●
	HSK100A-DHE8-150	8	150	31	50	34	30~40	M5	15,000	2.8	3	
	HSK100A-DHE10-90	10	90	33	50	34	35~45	M5	15,000	2.5	2.7	
	HSK100A-DHE10-150	10	150	33	50	34	35~45	M5	15,000	3	3.2	
	HSK100A-DHE12-95	12	95	35	50	34	41~51	M10	15,000	2.5	2.7	
	HSK100A-DHE12-150	12	150	35	50	34	41~52	M10	15,000	3	3.2	
	HSK100A-DHE14-100	14	100	36	50	40	43~53	M10	15,000	2.6	2.8	
	HSK100A-DHE14-150	14	150	36	50	40	43~54	M10	15,000	3.1	3.3	
	HSK100A-DHE16-100	16	100	40	50	45	46~56	M10	15,000	2.6	2.8	
	HSK100A-DHE16-150	16	150	40	50	45	46~56	M10	15,000	3.1	3.3	
	HSK100A-DHE18-100	18	100	42	50	45	49~59	M10	15,000	2.7	2.9	
	HSK100A-DHE18-150	18	150	42	50	45	49~59	M10	15,000	3.2	3.4	
	HSK100A-DHE20-105	20	105	44	50	50	49~59	M10	15,000	2.8	3	●
	HSK100A-DHE20-150	20	150	44	50	50	49~59	M10	15,000	3.4	3.6	
	HSK100A-DHE25-115	25	115	50	63	62	58~68	M16	15,000	3.3	3.5	●
HSK100A-DHE32-115	32	115	63	75	62	58~68	M16	15,000	3.8	4	●	

(Unit : mm)

Accessories

SPARE PART	Type	Accessories	
		Coolant Tube for HSK	Wrench
	Images		
	Designation		
	HSK50A	HSK50A-CNS	HSK50-WRENCH(C)
	HSK63A	HSK63A-CNS	HSK63-WRENCH(C)
	HSK100A	HSK100A-CNS	HSK100-WRENCH(C)

1:1 CHAT



SK-DHE

Hydraulic Expansion Chuck

DIN69871
-1A/B

Shank

G6.3

G value

20,000

Max RPM

5 μ m

Run-out

C

Coolant System



Milling



Drilling



Reaming

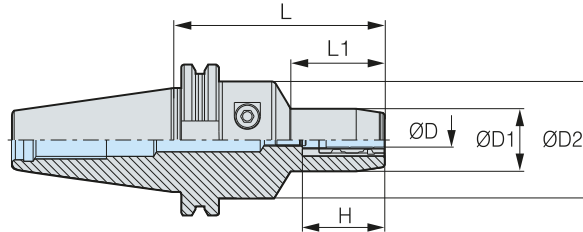

- : Stock
- : To be switched to NP order after stock depletion
- H : Depth of tool insertion (Min.~Max.)

C Internal coolant system is basic

- For more information on product features, see **34P**
- For more information on the related parts, see **41P**

	Designation	ØD	L	ØD1	ØD2	L1	H	ADJ	RPM	Fig.	kg	Package Weight(kg)	Stock
SK40	SK40-DHE6-90	6	90	29	50	40	30-40	M5	20,000	1	1.4	1.6	●
	SK40-DHE8-90	8	90	31	50	40	30-40	M5	20,000	1	1.4	1.6	●
	SK40-DHE10-90	10	90	33	50	40	35-45	M5	20,000	1	1.5	1.7	●
	SK40-DHE12-90	12	90	35	50	40	41-51	M10	20,000	1	1.5	1.7	●
	SK40-DHE12-140	12	140	35	50	40	41-51	M10	20,000	1	2.1	2.3	●
	SK40-DHE14-90	14	90	36	50	40	43-53	M10	20,000	1	1.4	1.6	●
	SK40-DHE16-90	16	90	40	50	45	46-56	M5	20,000	1	1.5	1.7	●
	SK40-DHE18-90	18	90	42	50	45	49-59	M5	20,000	1	1.5	1.7	●
	SK40-DHE20-90	20	90	44	50	50	49-59	M10	20,000	1	1.5	1.7	●
	SK40-DHE20-140	20	140	44	50	50	49-59	M10	20,000	1	2.1	2.4	●
SK50	SK50-DHE12-90	12	90	35	50	40	41-51	M10	15,000	1	3.2	3.5	●
	SK50-DHE14-90	14	90	36	50	40	43-53	M10	15,000	1	3.2	3.5	●
	SK50-DHE16-90	16	90	40	50	45	46-56	M10	15,000	1	3.3	3.5	●
	SK50-DHE18-90	18	90	42	50	40	49-59	M10	15,000	1	3.2	3.5	●
	SK50-DHE20-90	20	90	44	50	47	49-59	M10	15,000	1	3.2	3.5	●

(Unit : mm)

1:1 CHAT



DHE SPARE PARTS

Hydraulic Expansion Chuck Related Parts

SPARE PART	Type	Main Components	
		Clamp Bolt	Wrench
	Images		
	Designation		
	BT30 / SK30 / HSK50A	DHE4.5,6,8,10,12,14,16,18,20	BTF1010 DHETW-5
	BT40/BT50/SK40/ SK50/HSK63A/HSK100A	DHE4.5,6,8,10,12,14,16,18,20	BTF1010 DHETW-5
		DHE25.32	BTF1212-1.5 DHETW-6

SPARE PART	Type	Main Components
		Adjust Screw
	Images	
	Designation	
	DHE 6,8,10	DHE-M5(ADJ)
	DHE 12,14,16,18,20	DHE-M10(ADJ)
	DHE 25.32	DHE-M16(ADJ)

※ DBT30, BT30, HSK50A is Exception

1:1 CHAT



DHE/S

Slim Hydraulic Expansion Chuck



G6.3

G value

25,000

Max RPM

5-8 μ m

Run-out

C

Coolant System

Milling

Drilling

Reaming



Features

- Excellent workpiece accessibility due to slim design
- Improved tool life due to high-precision
- Reduced vibration during machining through the damping effects of the hydraulic chamber
- Tool clamping range : \varnothing 4- \varnothing 20mm

NAMING

BT30

Spindle

DHE

Hydraulic Expansion Chuck

8

Tool Dia.

S

Slim

115

Length

Recommended Machining Works

- Optimized for machining that requires high-precision
- Enables challenging narrow and deep machining
- Products that require finishing



Product Comparison

- Length and thickness are the same as those of DSC/M Type (If the tool projection length is 40mm, difference of α = around 2°)
- Longer gauge line and higher rigidity (versus the DSC/M Type)
- Ideal for mold machining due to its 3-degree taper shape

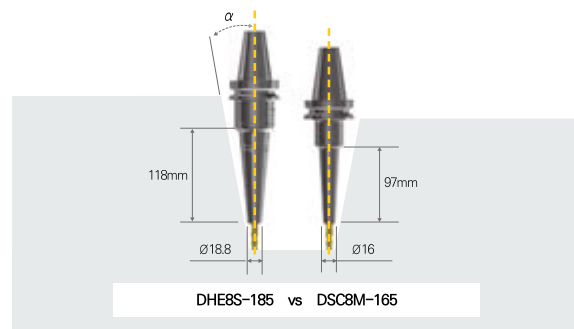

Stable Clamping Force

- Point clamping provides strong grip and stable clamping performance

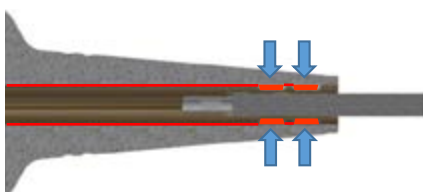

High Precision

- Run-out : 5μ m or Below (Long Type 8μ m)
- $L = 3 \times \varnothing D$



1:1 CHAT



BT-DHE/S

Slim Hydraulic Expansion Chuck

MAS
403-BT

Shank

G6.3

G value

25,000

Max RPM

5-8 μ m

Run-out

C

Coolant System



Milling



Drilling



Reaming

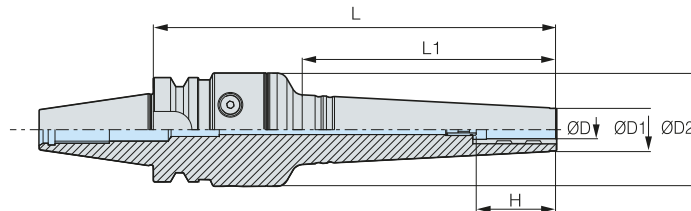

● : Stock

• H : Depth of tool insertion (Min.)

C Internal coolant system is basic

• For more information on product features, see **42P**

• For more information on the related parts, see **45P**

	Designation	ØD	L	ØD1	ØD2	L1	H	RPM	Run-out	kg	Package Weight (kg)	Stock
BT30	BT30-DHE4S-115	4	115	16.8	50	50	19	25,000	5 μ m	1.1	1.2	●
	BT30-DHE5S-115	5	115	16.8	50	50	19	25,000	5 μ m	1.1	1.2	●
	BT30-DHE6S-115	6	115	17	50	50	23	25,000	5 μ m	1.1	1.2	●
	BT30-DHE6S-180	6	180	17	50	115	23	25,000	8 μ m	1.4	1.5	●
	BT30-DHE8S-115	8	115	19	50	50	31	25,000	5 μ m	1.1	1.2	●
	BT30-DHE8S-180	8	180	19	50	115	31	25,000	8 μ m	1.4	1.6	●
	BT30-DHE10S-120	10	120	21	50	55	36	25,000	5 μ m	1.4	1.5	●
	BT30-DHE10S-180	10	180	21	50	115	36	25,000	8 μ m	1.9	2	●
	BT30-DHE12S-130	12	130	23	50	65	38	25,000	5 μ m	1.2	1.3	●
BT30-DHE12S-180	12	180	23	50	115	38	25,000	8 μ m	1.6	1.7	●	
BT40	BT40-DHE4S-120	4	120	16.8	50	50	19	20,000	5 μ m	1.7	1.8	●
	BT40-DHE5S-120	5	120	16.8	50	50	19	20,000	5 μ m	1.7	1.8	●
	BT40-DHE6S-120	6	120	17	50	50	23	20,000	5 μ m	1.7	1.8	●
	BT40-DHE6S-185	6	185	17	50	115	23	20,000	8 μ m	2	2.2	●
	BT40-DHE8S-120	8	120	19	50	50	31	20,000	5 μ m	2	2.1	●
	BT40-DHE8S-185	8	185	19	50	115	31	20,000	8 μ m	2	2.2	●
	BT40-DHE10S-125	10	125	21	50	55	36	20,000	5 μ m	1.6	1.7	●
	BT40-DHE10S-185	10	185	21	50	115	36	20,000	8 μ m	2	2.2	●
	BT40-DHE12S-135	12	135	23	50	65	38	20,000	5 μ m	1.8	1.9	●
	BT40-DHE12S-185	12	185	23	50	115	38	20,000	8 μ m	2.2	2.3	●
	BT40-DHE16S-190	16	190	26.8	50	115	41	20,000	8 μ m	2.3	2.4	●
	BT40-DHE20S-190	20	190	30.8	50	115	44	20,000	8 μ m	2.4	2.5	●
BT50	BT50-DHE6S-200	6	200	16.8	50	115	22	15,000	8 μ m	4.6	4.9	●
	BT50-DHE8S-200	8	200	18.8	50	115	30	15,000	8 μ m	4.6	4.9	●
	BT50-DHE10S-200	10	200	20.8	50	115	35	15,000	8 μ m	4.8	5.0	●
	BT50-DHE12S-200	12	200	22.8	50	115	37	15,000	8 μ m	4.9	5.1	●
	BT50-DHE16S-200	16	200	26.8	50	115	41	15,000	8 μ m	5.0	5.2	●
	BT50-DHE20S-200	20	200	30.8	50	115	44	15,000	8 μ m	5.0	5.3	●

(Unit : mm)

Chuck

Arbor/Modular

Boring Tool

Angular Head

cBN/PCD

Device&Accessory

Standard



HSK-DHE/S

Slim Hydraulic Expansion Chuck



- DIN 69893-1**
Shank
- G6.3**
G value
- 20,000**
Max RPM
- 5-8 μ m**
Run-out
- C**
Coolant System
- Milling
- Drilling
- Reaming

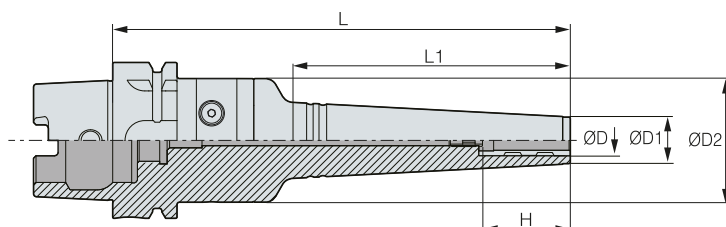

- ● : Stock
- H : Depth of tool insertion (Min.)
- ☐ Internal coolant system is optional

- For more information on product features, see **42P**
- For more information on the related parts, see **45P**

	Designation	ØD	L	ØD1	ØD2	L1	H	RPM	Run-out	kg	Package Weight (kg)	Stock
HSK63	HSK63A-DHE4S-120	4	120	16.8	50	50	19	20,000	5 μ m	1.4	1.6	●
	HSK63A-DHE5S-120	5	120	16.8	50	50	19	20,000	5 μ m	1.4	1.6	●
	HSK63A-DHE6S-120	6	120	17	50	50	23	20,000	5 μ m	1.4	1.6	●
	HSK63A-DHE6S-185	6	185	17	50	115	23	20,000	8 μ m	1.7	1.9	●
	HSK63A-DHE8S-120	8	120	19	50	50	31	20,000	5 μ m	1.4	1.7	●
	HSK63A-DHE8S-185	8	185	19	50	115	31	20,000	8 μ m	1.8	2.0	●
	HSK63A-DHE10S-125	10	125	21	50	55	36	20,000	5 μ m	1.5	1.7	●
	HSK63A-DHE10S-185	10	185	21	50	115	36	20,000	8 μ m	1.8	2.0	●
	HSK63A-DHE12S-135	12	135	23	50	65	38	20,000	5 μ m	1.8	1.9	●
	HSK63A-DHE12S-185	12	185	23	50	115	38	20,000	8 μ m	1.8	2.1	●
	HSK63A-DHE16S-190	16	190	26.8	50	115	41	20,000	8 μ m	2.2	2.4	●
	HSK63A-DHE20S-190	20	190	30.8	50	115	44	20,000	8 μ m	2.3	2.5	●
HSK100	HSK100A-DHE16S-190	16	190	26.8	50	115	41	15,000	8 μ m	3.1	3.3	●
	HSK100A-DHE20S-190	20	190	30.8	50	115	44	15,000	8 μ m	3.3	3.5	●

(Unit : mm)



1:1 CHAT



DHE/S SPARE PART

Slim Hydraulic Expansion Chuck Related Parts

Main Components

SPARE PART	Type		Main Components		
	Images		Clamp Bolt	Wrench	
Designation					
BT30	DHE/S 4,5,6,8,10,12	BTF1010	DHETW-5		
BT40	DHE/S 4,5,6,8,10,12,16,20	BTF1010	DHETW-5		
BT50	DHE/S 6,8,10,12,16,20	BTF1010	DHETW-5		
HSK63A	DHE/S 4,5,6,8,10,12,16,20	BTF1010	DHETW-5		
HSK100A	DHE/S 16,20	BTF1010	DHETW-5		

SPARE PART	Type		Main Components
	Images		Adjust Screw
Designation			
DHE/S 6, 8, 10, 12			
		DHE-M5 (ADJ)	
DHE/S 16,20		DHE-M10 (ADJ)	

Accessories

SPARE PART	Type	Accessories	
		Coolant Tube for HSK	Wrench
Images			
Designation			
HSK63A		HSK63A-CNS	HSK63-WRENCH(C)
HSK100A		HSK100A-CNS	HSK100-WRENCH(C)

1:1 CHAT



DHE/G ^{NEW}

Hydraulic Expansion Chuck for Tool Grinding



G6.3

G value

3 μ m

Run-out



Features

- Minimized wheel interference thanks to the application of 25 degrees to the entrance unit
- Stable run-out within 3 μ m in 3x \varnothing D
- Stable clamping force with 2-point clamping

NAMING

SK50	DHE	12	G	110
Spindle	Hydraulic Expansion Chuck	Tool Dia.	Grinding	Length

High Precision

- Run-out within 3 μ m in 3x \varnothing D achieved by the application of high-precision.

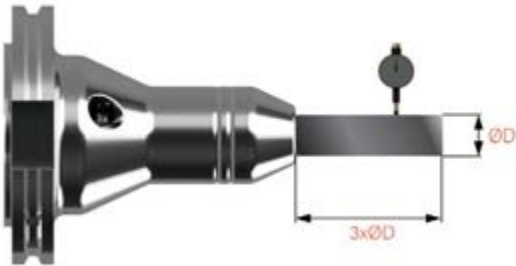

Stable Clamping

- Achieve high-precision due to the stable clamping of 2 points on the upper side and the lower side.

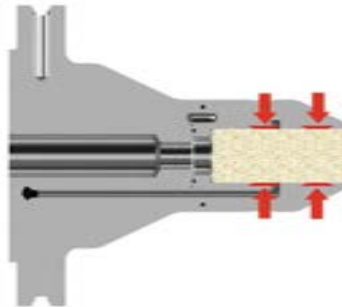

Minimized Wheel Interference

- The front-end unit employs 25° of angle and minimizes wheel interference during machining.

Hydraulic Chuck for Grinding Tools

- Used as a jig for fixing an end tool when grinding the tools.

1:1 CHAT



SK-DHE/G

Hydraulic Expansion Chuck for Tool Grinding



DIN69871
-1A/B

Shank

G6.3

G value

3_{μm}

Run-out

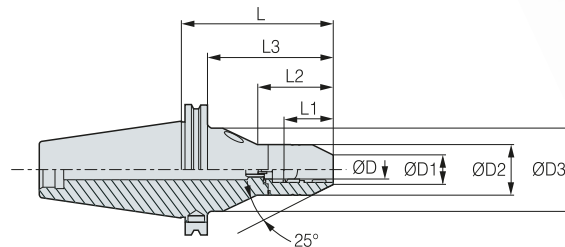

• ● : Stock

• For more information on product features, see **46P**

• For more information on the related parts, see **47P**

Designation	ØD	L	ØD1	ØD2	ØD3	L1	L2	L3	ADJ	kg	Package Weight (kg)	Stock
SK50-DHE6G-110	6	110	15	15	32	25	55	90.9	M5	3.2	3.5	
SK50-DHE8G-110	8	110	17	17	33.5	25	55	90.9	M5	3.4	3.7	
SK50-DHE10G-110	10	110	19	19	35	30	55	90.9	M5	3.4	3.7	
SK50-DHE12G-110	12	110	21.5	21.5	36.5	36	55	90.9	M10	3.6	3.9	●
SK50-DHE14G-110	14	110	23.5	23.5	38	38	60	90.9	M10	3.6	3.9	
SK50-DHE16G-110	16	110	25.5	25.5	39.5	41	60	90.9	M10	3.7	4	
SK50-DHE18G-110	18	110	27.5	27.5	41	44	60	90.9	M10	3.8	4.1	
SK50-DHE20G-110	20	110	28	28	42	44	47	90.9	M10	3.8	4.1	●
SK50-DHE25G-110	25	110	33	33	47	53	49	90.9	M16	4	4.3	
SK50-DHE32G-110	32	110	40	40	54	53	62.5	90.9	M16	4.2	4.5	●

(Unit : mm)

1:1 CHAT



DHE/G SPARE PART

Hydraulic Chuck for Grinder Related Parts

SPARE PART	Type	Main Components	
		Clamp Bolt	Wrench
	Images		
	Designation		
SK50	DHE6,8,10,12,14,16,18,20	BTF1010	DHETW-5
	DHE25.32	BTF1212-1.5	DHETW-6

1:1 CHAT



DHC Collet (General Type & Sealed Type)

DHC Collet (Standard Type) / DHC Collet (Sealed Type)



5 μ m

Run-out



Coolant System

Fig.1

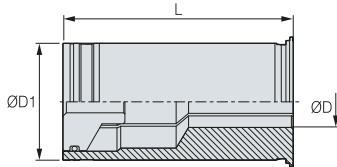
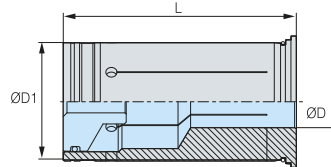

Fig.2



● : Stock

■ This product does not support the internal coolant system

	Designation (Standard Type)	ØD	L	ØD1	Fig.	kg	Stock
DHC12	DHC12-3	3	47	12	1	0.06-0.08	●
	DHC12-4	4	47	12	1	0.06-0.08	●
	DHC12-5	5	47	12	1	0.06-0.08	●
	DHC12-6	6	47	12	1	0.06-0.08	●
	DHC12-8	8	47	12	1	0.06-0.08	●
DHC20	DHC20-3	3	52	20	1	0.04-0.06	●
	DHC20-4	4	52	20	1	0.04-0.06	●
	DHC20-5	5	52	20	1	0.04-0.06	●
	DHC20-6	6	52	20	1	0.04-0.06	●
	DHC20-7	7	52	20	1	0.04-0.06	●
	DHC20-8	8	52	20	1	0.04-0.06	●
	DHC20-9	9	52	20	1	0.04-0.06	●
	DHC20-10	10	52	20	1	0.04-0.06	●
	DHC20-11	11	52	20	1	0.04-0.06	●
	DHC20-12	12	52	20	1	0.04-0.06	●
	DHC20-14	14	52	20	1	0.04-0.06	●
	DHC20-16	16	52	20	1	0.04-0.06	●
DHC32	DHC32-6	6	63	32	1	0.2-0.5	●
	DHC32-8	8	63	32	1	0.2-0.5	●
	DHC32-10	10	63	32	1	0.2-0.5	●
	DHC32-12	12	63	32	1	0.2-0.5	●
	DHC32-14	14	63	32	1	0.2-0.5	●
	DHC32-16	16	63	32	1	0.2-0.5	●
	DHC32-18	18	63	32	1	0.2-0.5	●
	DHC32-19	19	63	32	1	0.2-0.5	●
	DHC32-20	20	63	32	1	0.2-0.5	●
	DHC32-25	25	63	32	1	0.2-0.5	●

• Other sizes are customizable.

(Unit : mm)

● : Stock

■ Internal coolant system is basic

	Designation (Sealed Type)	ØD	L	ØD1	Fig.	kg	Stock
DHC12	DHC12-3(P)	3	47	12	2	0.04	●
	DHC12-4(P)	4	47	12	2	0.04	●
	DHC12-5(P)	5	47	12	2	0.04	●
	DHC12-6(P)	6	47	12	2	0.04	●
	DHC12-8(P)	8	47	12	2	0.04	●
DHC20	DHC20-3(P)	3	52	20	2	0.06-0.1	●
	DHC20-4(P)	4	52	20	2	0.06-0.1	●
	DHC20-5(P)	5	52	20	2	0.06-0.1	●
	DHC20-6(P)	6	52	20	2	0.06-0.1	●
	DHC20-7(P)	7	52	20	2	0.06-0.1	●
	DHC20-8(P)	8	52	20	2	0.06-0.1	●
	DHC20-9(P)	9	52	20	2	0.06-0.1	●
	DHC20-10(P)	10	52	20	2	0.06-0.1	●
	DHC20-11(P)	11	52	20	2	0.06-0.1	●
	DHC20-12(P)	12	52	20	2	0.06-0.1	●
	DHC20-14(P)	14	52	20	2	0.06-0.1	●
	DHC20-16(P)	16	52	20	2	0.06-0.1	●
DHC32	DHC32-6(P)	6	63	32	2	0.2-0.3	●
	DHC32-8(P)	8	63	32	2	0.2-0.3	●
	DHC32-10(P)	10	63	32	2	0.2-0.3	●
	DHC32-12(P)	12	63	32	2	0.2-0.3	●
	DHC32-14(P)	14	63	32	2	0.2-0.3	●
	DHC32-16(P)	16	63	32	2	0.2-0.3	●
	DHC32-18(P)	18	63	32	2	0.2-0.3	●
	DHC32-19(P)	19	63	32	2	0.2-0.3	●
	DHC32-20(P)	20	63	32	2	0.2-0.3	●
	DHC32-25(P)	25	63	32	2	0.2-0.3	●

• Other sizes are customizable.

(Unit : mm)

1:1 CHAT



DHJ Collet (Jet Coolant)

DHJ Jet Coolant Collet



3μm

Run-out

C

Coolant System

Features

- Jet coolant function is available just by fastening hydraulic chuck
- Internal coolant is available when O-ring is fastened
- Reduces damage by the chips on the material

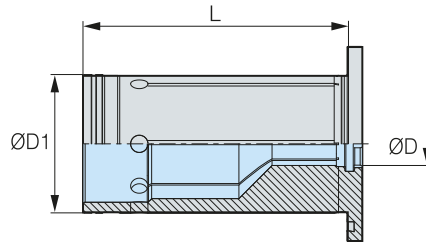

• ● : Stock

■ C Internal coolant system is basic

Designation	ØD	L	ØD1	kg	Package Weight (kg)	Stock
DHJ20-6	6	50	20	0.1	0.1	●
DHJ20-8	8	50	20	0.1	0.1	●
DHJ20-10	10	50	20	0.1	0.1	●
DHJ20-12	12	50	20	0.1	0.1	●
DHJ20-14	14	50	20	0.08	0.08	●
DHJ20-16	16	50	20	0.08	0.08	●

(Unit : mm)

Chuck

Arbor/Modular

Boring Tool

Angular Head

cBN/PCD

Device&Accessory

Standard

1:1 CHAT



DZC

Zero Fit Collet



≤2μm

Run-out

C

Coolant System



Features

- Run-out setting available for higher precision due to the application of six screws
- Fastening errors with the equipment can be corrected (max. Correction dimension: 20μm)
- Applicable for both hydraulic chuck and milling chuck

NAMING

DZC	20	10
Zero Fit Collet	Collet Size	Tool Dia.

Product Features

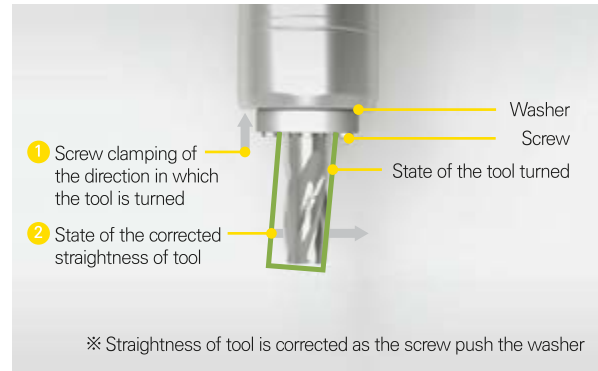
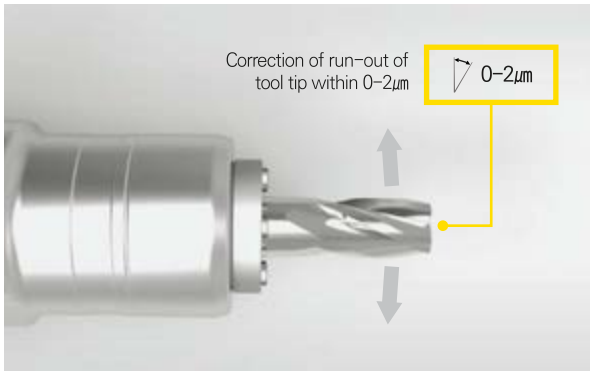

Comparison Test

Run-out of Tool Tip 10-20μm

Run-out of Tool Tip 0-2μm

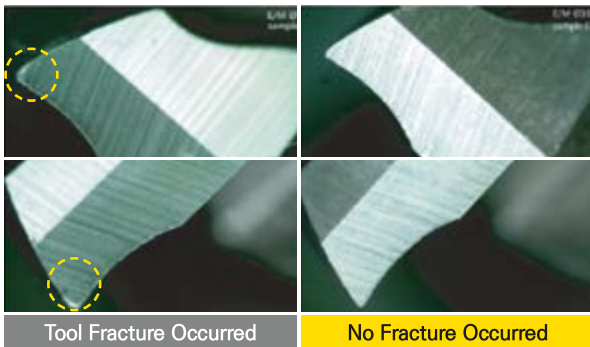
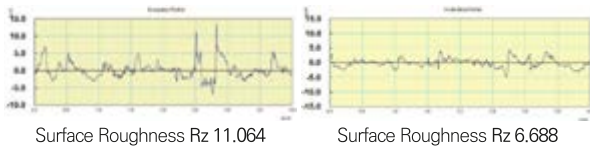

Results of Hole Machining Test with PCD Reamer

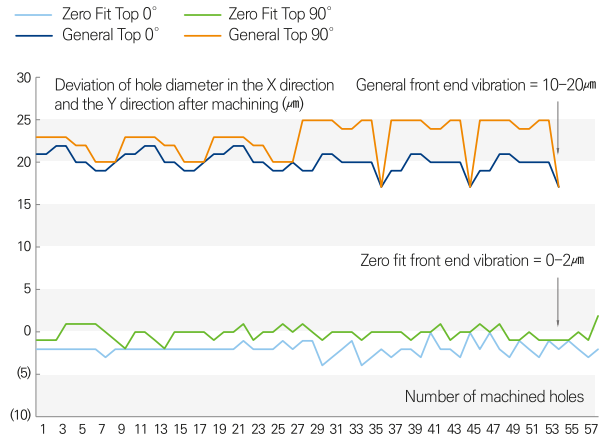

Hole Actual Deviation as Machining Result(mm)		
Based on Ø8	Zero Fit	General
	+0.003	+0.02

1:1 CHAT



DZC

Zero Fit Collet



≤ 2 μ m

Run-out

C

Coolant System

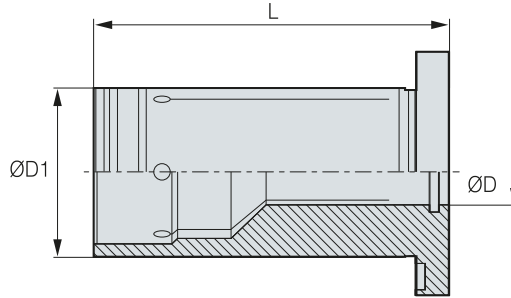

● : Stock

C This product does not support the internal coolant system

• For more information on product features, see **50P**

	Designation	ØD	L	ØD1	Stock	
DZC20	DZC20-6	6	57	20	●	
	DZC20-8	8	57	20	●	
	DZC20-10	10	57	20	●	
	DZC20-12	12	57	20	●	
	DZC20-14	14	57	20	●	
	DZC20-16	16	57	20	●	
DZC32	DZC32-6	6	68	32	●	
	DZC32-8	8	68	32	●	
	DZC32-10	10	68	32	●	
	DZC32-12	12	68	32	●	
	DZC32-16	16	68	32	●	
	DZC32-20	20	68	32	●	
	DZC32-25	25	68	32	●	

※ **Precautions**

(Unit : mm)

- Run-out can be adjusted with small force.
- Excessive clamping of the adjustment screw may result in deformation of the product.
(Suggested clamping torque : less than 600cN·m)
- If the run-out adjustment screw is clamped using excessive force, all six screws must be completely unclamped and adjusted again.

Chuck

Arbor/Modular

Boring Tool

Angular Head

cBN/PCD

Device&Accessory

Standard

1:1 CHAT



DSC

Shrinking Chuck



G2.5

G value

25,000

Max RPM

3 μ m

Run-out

C

Coolant System



Milling



Drilling



Reaming



Chamfering



Features

- Tools can be fastened with high rigidity and precision due to the minimized fastening structure
- Optimized balancing for high-speed machining is achieved by the symmetric design
- The simple structure allows for stable maintenance
- Boring range : \varnothing 3~ \varnothing 20mm

NAMING

BT50

Shank Shape
BT, HSK, SK,
ST

DSC

Shrinking
Chucks

6

Tool Dia.

S

Type
S: Slim
M: Middle
NON: General

140

Length

S

Special
S: Curve Type
NON: General

High Clamping Force

- Increase of 30% clamping force versus hydraulic expansion chuck
- Definite power transmission
- Run-out (≤ 0.003 mm)

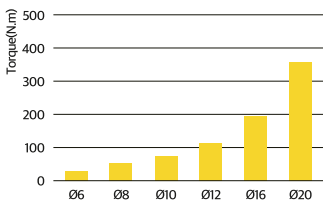

Symmetrical Design



Shrinking Chuck	Collet Chuck
Fix the space between the holder and tool as the heat contraction	Fix the tool using elasticity of the collet
<p>Heat Expansion Heat Contraction</p>	<p>Elastic Strain</p>
Very High Clamping Force	High Clamping Force

Slim Type Series Configuration

Straight Type

Used by combining with various holders such as hydraulic expansion chuck, milling chuck, and collet chuck, etc.



Mono Type

Used with high-precision as integral types



1:1 CHAT



DSC

Shrinking Chuck



Tool Tightening Tolerance

Tool Shank	Tool Shank Tolerance(h6)	Tool Shank	Tool Shank Tolerance(h6)	Tool Shank	Tool Shank Tolerance(h6)	Tool Shank	Tool Shank Tolerance(h6)
Ø3	0~-0.008	Ø6	0~-0.008	Ø12	0~-0.011	Ø25	0~-0.013
Ø4	0~-0.009	Ø8	0~-0.009	Ø16	0~-0.011	Ø32	0~-0.016
Ø5	0~-0.011	Ø10	0~-0.011	Ø20	0~-0.013		

(Unit : mm)

Min. Tool Insertion Depth

Inner Diameter	Type	Ø6	Ø8	Ø10	Ø12	Ø16	Ø20	Ø25	Ø32
Tool's Min. Insertion Depth	Slim	18	24	30	30	-	-	-	-
	Medium	18	24	30	30	32	40	-	-
	General	26	26	32	37	37	40	42	52

(Unit : mm)

DSC Map

Shrinking Chuck

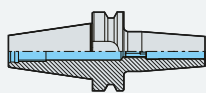

DSC C
Shrinking Chuck

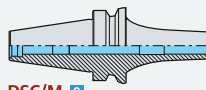

DSC/M C
Shrinking Chuck(Mono Curve)

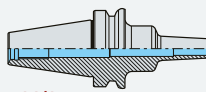

DSC/S C
Shrinking Chuck(Mono Slim)

SW-FBHB C
Micro Boring Bar

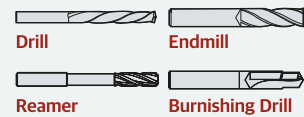

Drill

Endmill

Reamer

Burnishing Drill

1:1 CHAT



DSC

Shrinking Chuck



Mono Type

Shape	Accuracy	Type	
<p>3° Taper Thickness (T)</p>	<p>Run-out 3µm 3xD</p>	<p>1.5T Slim Type</p>	<p>2~4.5T Medium Type</p>

- Ensures good rigidity by using special steel instead of general steel and maintains high-precision due to its excellent thermal resistance even when it is used moer than 5,000 times
- Enables stable cutting and good surface roughness due to its high rigidity
- Provides a long tool life due to its high-precision

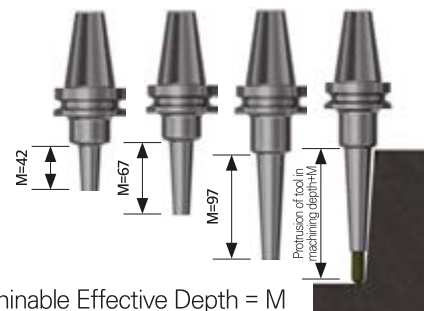

Straight Type

Shape	Accuracy	Type	
<p>3° Taper Thickness (T)</p> <p>Collet Chuck Hydraulic Expansion Chuck Milling Chuck</p>	<p>Run-out 3µm 3xD</p>	<p>1.5T Slim Type</p>	<p>2~4.5T Medium Type</p>
<p>Used by being combined with various holders such as hydraulic chuck, milling chuck, and collet chuck</p>			

- Straight types used by combining with various holders such as hydraulic expansion chuck and collet chuck, etc. maintain high-precision and help enable various machining operations at an affordable price
- There are 20 types of shanks that can be used according to work situations

Examples



Ø6~Ø12 tools can be tightened
Various lengths and shank sizes



Lengths can be adjusted and used according to machining situations

1:1 CHAT



DSC

Shrinking Chuck



Precautions in Use

Tools to Use

- Use cemented carbide tools
- High-speed-steel may not be disassembled
- Using an excessive tolerance tool affects clamping force, causing an accident

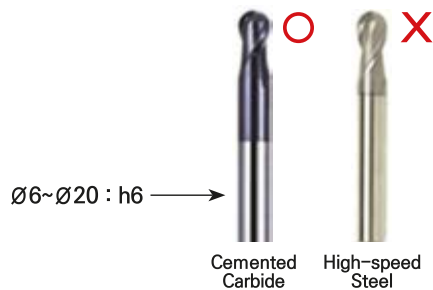

High-frequency Heating-related Precautions

- When tightening/disassembling a tool, it is recommended that slim-type programmed shrink fit devices be used
- Using devices with no slim-type program may cause overheating. (Overheating may affect the product durability, service life, and accuracy.)

Precautions for Fastening Tools

- Maintain clean state by removing rust, dust, cutting oil, etc. generated by corrosion of the inner diameter of the chuck before tool tightening
- When tightening a tool, tighten it under the tightening section
- Tool tightening in the middle of the tightening section affects accuracy and durability
- When tightening a tool, touching the bottom surface affects accuracy

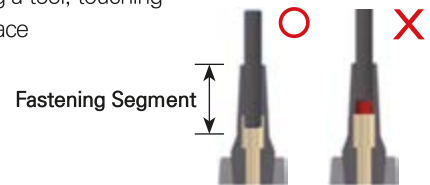

Storage Method

- When the shrink fit chuck is not used, the tool should be separated from the chuck. (Long-time connection may affect the service life of the product.)
- After using the shrink fit chuck, be sure to remove moisture and use inhibited oil and rust-preventing spray to prevent rust from occurring. (Less rust occurs compared to general steel as special steel is used; however, long-time non-use may cause rust occurrence.)

Components for Separate Sale

Shrinking Device **MH-300** **NEW**

- Enables a maximum of 30-times consecutive heating per hour
- Compatible with steel and SUS holders
- Presets for 10 frequently used tool diameters can be saved
- Interchangeable heating coils for small(35mm) and large(58mm) diameters
- Standard BT30/BT40/HSK63 compatible; other shanks available(optional)
- Prevents overheating and enables manual cooling through settings



TOOL SHRINK BASIC **NEW**

- Improved tool life of the holders by preventing overheating by using automatic control of power between 7kW-16kW
- Applicable to holders with an outer diameter of Ø3-Ø32 mm without replacing a coil (regardless of materials such as steel, SUS, HSS, and carbide)
- Easy to use keypad
- Evo-Pi PC is installed for customizing using Wi-Fi
- Online remote support service available



1:1 CHAT



BT-DSC

Shrinking Chuck



MAS 403-BT G2.5 25,000 3_μm C Milling Drilling Reaming Chamfering

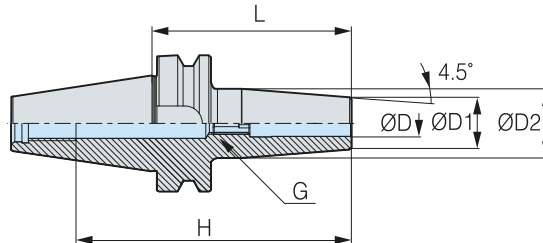

- : To be switched to NP order after stock depletion
- : Stock
- H : Depth of tool insertion
- C Internal coolant system is basic

- For more information on product features, see **52P**
- For more information on the related parts, see **63P**

	Designation	ØD	L	ØD1	ØD2	H	G	RPM	kg	Package Weight (kg)	Stock
BT30	BT30-DSC3-60	3	60	11	18.5	82	-	25,000	0.4	0.5	●
	BT30-DSC4-60	4	60	13	20.5	82	-	25,000	0.4	0.5	●
BT40	BT40-DSC6-90	6	90	21	27	36	M5	20,000	1.1	1.3	●
	BT40-DSC6-120	6	120	21	27	36	M5	20,000	1.2	1.5	●
	BT40-DSC6-160	6	160	21	27	36	M5	20,000	1.4	1.7	●
	BT40-DSC8-90	8	90	21	27	36	M5	20,000	1.1	1.3	●
	BT40-DSC8-120	8	120	21	27	36	M5	20,000	1.2	1.4	●
	BT40-DSC8-160	8	160	21	27	36	M5	20,000	1.4	1.7	●
	BT40-DSC10-90	10	90	24	32	42	M8	20,000	1.1	1.3	●
	BT40-DSC10-120	10	120	24	32	42	M8	20,000	1.3	1.6	●
	BT40-DSC10-160	10	160	24	32	42	M8	20,000	1.6	1.8	●
	BT40-DSC12-90	12	90	24	32	47	M8	20,000	1.1	1.3	●
	BT40-DSC12-120	12	120	24	32	47	M8	20,000	1.3	1.5	●
	BT40-DSC12-160	12	160	24	32	47	M8	20,000	1.6	1.8	●
	BT40-DSC16-90	16	90	27	34	50	M12	20,000	1.2	1.4	●
	BT40-DSC16-120	16	120	27	34	50	M12	20,000	1.3	1.6	●
	BT40-DSC16-160	16	160	27	34	50	M12	20,000	1.7	1.9	●
	BT40-DSC20-90	20	90	33	42	52	M12	20,000	1.3	1.5	●
	BT40-DSC20-120	20	120	33	42	52	M12	20,000	1.5	1.8	●
	BT40-DSC20-160	20	160	33	42	52	M12	20,000	2.0	2.3	

(Unit : mm)

1:1 CHAT



BT-DSC/M MONO TYPE

Shrinking Chuck

MAS
403-BT

Shank

G2.5

G value

20,000

Max RPM

3_μm

Run-out

C

Coolant System



Milling



Drilling



Reaming



Chamfering



Fig.1

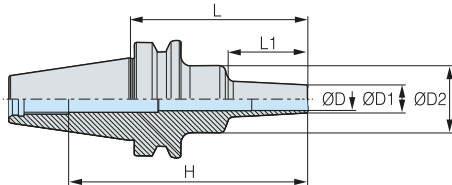
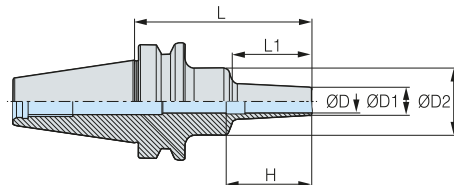

Fig.2



● : Stock

● : H : Depth of tool insertion

C Internal coolant system is basic

※ Adjustment screws cannot be used for this product

※ Fig.1 allows the insertion of 100mm or more.

• For more information on product features, see **52P**• For more information on the related parts, see **63P**

	Designation	ØD	L	ØD1	ØD2	L1	H	RPM	Fig.	kg	Package Weight (kg)	Stock
BT40	BT40-DSC3M-95	3	95	8	26	42	128	20,000	-	1.1	1.2	●
	BT40-DSC4M-95	4	95	8	26	42	128	20,000	-	1.1	1.1	●
	BT40-DSC6M-95	6	95	10	26	42	128	20,000	-	1.0	1.2	●
	BT40-DSC6M-120	6	120	10	26	67	153	20,000	-	1.0	1.2	●
	BT40-DSC6M-160	6	160	10	36	97	193	20,000	-	1.2	1.3	●
	BT40-DSC8M-95	8	95	13	36	42	128	20,000	-	1.3	1.4	●
	BT40-DSC8M-120	8	120	13	36	67	153	20,000	-	1.3	1.5	●
	BT40-DSC8M-160	8	160	13	36	97	193	20,000	-	1.3	1.5	●
	BT40-DSC10M-95	10	95	16	36	42	128	20,000	-	1.1	1.3	●
	BT40-DSC10M-120	10	120	16	36	67	153	20,000	-	1.1	1.4	●
	BT40-DSC10M-160	10	160	16	36	97	193	20,000	-	1.3	1.6	
	BT40-DSC12M-95	12	95	19	36	42	128	20,000	-	1.1	1.2	●
	BT40-DSC12M-120	12	120	19	36	67	153	20,000	-	1.2	1.4	●
	BT40-DSC12M-160	12	160	19	36	97	193	20,000	-	1.4	1.6	
	BT40-DSC16M-95	16	95	24	50	42	47	20,000	2	1.3	1.5	●
	BT40-DSC16M-120	16	120	24	50	67	47	20,000	2	1.4	1.6	
BT40-DSC16M-160	16	160	24	50	97	47	20,000	2	1.7	2.0		
BT40-DSC20M-95	20	95	29	50	42	55	20,000	2	1.3	1.5	●	
BT40-DSC20M-120	20	120	29	50	67	55	20,000	2	1.5	1.7		
BT40-DSC20M-160	20	160	29	50	97	55	20,000	2	1.9	2.1		
BT50	BT50-DSC6M-110	6	110	10	26	42	163	15,000	-	3.5	3.8	●
	BT50-DSC6M-160	6	160	10	36	97	213	15,000	-	3.6	4.0	●
	BT50-DSC8M-110	8	110	13	36	42	163	15,000	-	3.7	4.0	●
	BT50-DSC8M-160	8	160	13	36	97	213	15,000	-	3.7	4.1	●
	BT50-DSC10M-110	10	110	16	36	42	163	15,000	-	3.7	4.0	●
	BT50-DSC10M-160	10	160	16	36	97	213	15,000	-	3.7	4.1	●
	BT50-DSC12M-110	12	110	19	36	42	163	15,000	-	3.7	4.0	●
	BT50-DSC12M-160	12	160	19	50	97	213	15,000	-	4.0	4.4	●
	BT50-DSC16M-110	16	110	24	50	42	163	15,000	-	3.9	4.2	
	BT50-DSC16M-160	16	160	24	50	97	213	15,000	-	4.1	4.5	●
	BT50-DSC20M-110	20	110	29	50	42	55	15,000	2	3.9	4.2	●
	BT50-DSC20M-160	20	160	29	50	97	55	15,000	2	4.2	4.6	●

(Unit : mm)

1:1 CHAT



HSK-DSC/M MONO TYPE

Shrinking Chuck



DIN 69893-1
Shank

G2.5
G value

20,000
Max RPM

3_μm
Run-out

C
Coolant System

Milling

Drilling

Reaming

Chamfering

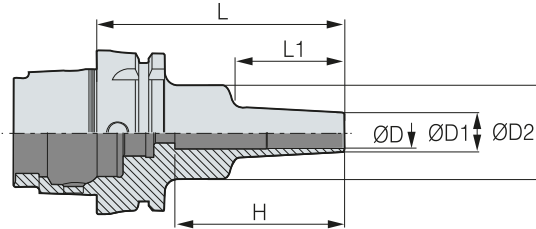

- : Stock
- H : Depth of tool insertion

☐ Internal coolant system is optional

※ Adjustment screws cannot be used for this product

• For more information on product features, see **52P**

• For more information on the related parts, see **63P**

HSK63A

Designation	ØD	L	ØD1	ØD2	L1	H	RPM	kg	Package Weight (kg)	Stock
HSK63A-DSC6M-95	6	95	10	26	42	73	20,000	0.7	0.9	●
HSK63A-DSC8M-95	8	95	13	36	42	39	20,000	0.8	1	●
HSK63A-DSC10M-120	10	120	16	36	67	45	20,000	0.8	1	●
HSK63A-DSC12M-120	12	120	19	36	67	45	20,000	0.9	1.1	●
HSK63A-DSC16M-120	16	120	24	50	67	47	20,000	1.1	1.3	●

(Unit : mm)

Accessories

SPARE PART	Type	Accessories	
		Coolant Tube for HSK	Wrench
	Images		
	Designation	HSK63A-CNS	HSK63-WRENCH(C)
	HSK63A	HSK63A-CNS	HSK63-WRENCH(C)

1:1 CHAT



SK-DSC/M MONO TYPE

Shrinking Chuck



DIN69871
-1A/B

Shank

G2.5

G value

20,000

Max RPM

3 μ m

Run-out

C

Coolant System



Milling



Drilling



Reaming



Chamfering

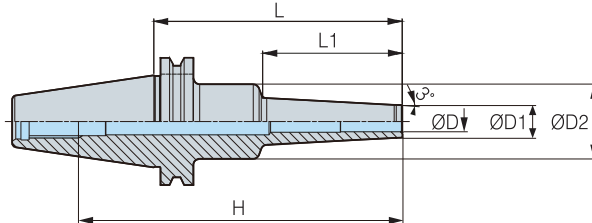

• ● : To be switched to NP order after stock depletion

• H : Depth of tool insertion

C Internal coolant system is basic

※ Adjustment screws cannot be used for this product

• For more information on product features, see **52P**

• For more information on the related parts, see **63P**

Designation	ØD	L	ØD1	ØD2	L1	H	RPM	kg	Package Weight (kg)	Stock
SK40-DSC6M-95	6	95	10	26	42	131	20,000	0.8	1.0	
SK40-DSC6M-120	6	120	10	26	67	156	20,000	1.0	1.2	
SK40-DSC8M-95	8	95	13	36	42	131	20,000	1.4	1.6	
SK40-DSC8M-120	8	120	13	36	67	156	20,000	1.0	1.2	
SK40-DSC10M-95	10	95	16	36	42	131	20,000	1.0	1.2	●
SK40-DSC10M-120	10	120	16	36	67	156	20,000	1.0	1.3	
SK40-DSC12M-95	12	95	19	36	42	131	20,000	1.0	1.2	
SK40-DSC12M-120	12	120	19	36	67	156	20,000	1.1	1.3	
SK40-DSC16M-95	16	95	24	50	42	47	20,000	1.3	1.5	
SK40-DSC16M-120	16	120	24	50	67	47	20,000	1.4	1.6	●
SK40-DSC20M-95	20	95	29	50	42	55	20,000	1.3	1.5	
SK40-DSC20M-120	20	120	29	50	67	55	20,000	1.4	1.6	

(Unit : mm)

1:1 CHAT



BT-DSC/S MONO SLIM TYPE

Shrinking Chuck

MAS
403-BT

Shank

G2.5

G value

25,000

Max RPM

3_μm

Run-out

C

Coolant System



Milling



Drilling



Reaming



Chamfering

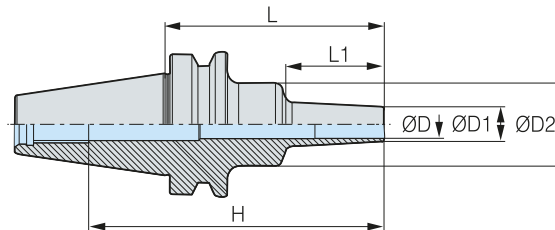
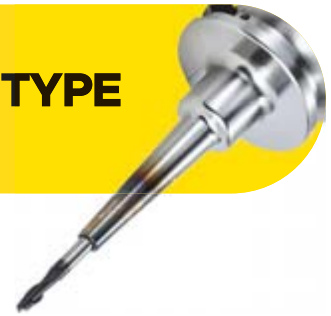

- ● : To be switched to NP order after stock depletion
- H : Depth of tool insertion

C Internal coolant system is basic

※ Adjustment screws cannot be used for this product

• For more information on product features, see **52P**

• For more information on the related parts, see **63P**

	Designation	ØD	L	ØD1	ØD2	L1	H	RPM	kg	Package Weight (kg)	Stock
BT30	BT30-DSC6S-60	6	60	9	20	22	82	25,000	0.4	0.5	●
	BT30-DSC6S-80	6	80	9	20	42	102	25,000	0.5	0.5	●
	BT30-DSC6S-120	6	120	9	25	67	142	25,000	0.5	0.6	●
BT40	BT40-DSC6S-95	6	95	9	26	42	128	20,000	1.0	1.2	
	BT40-DSC6S-120	6	120	9	26	67	153	20,000	1.0	1.2	
	BT40-DSC6S-160	6	160	9	36	97	193	20,000	1.2	1.4	
	BT40-DSC8S-95	8	95	11	36	42	128	20,000	1.1	1.3	
	BT40-DSC8S-120	8	120	11	36	67	153	20,000	1.1	1.3	
	BT40-DSC8S-160	8	160	11	36	97	193	20,000	1.2	1.5	
	BT40-DSC10S-95	10	95	13	36	42	128	20,000	1.0	1.2	●
	BT40-DSC10S-120	10	120	13	36	67	153	20,000	1.1	1.3	
	BT40-DSC10S-160	10	160	13	36	97	193	20,000	1.2	1.5	
	BT40-DSC12S-95	12	95	15	36	42	128	20,000	1.1	1.3	●
	BT40-DSC12S-120	12	120	15	36	67	153	20,000	1.1	1.3	●
	BT40-DSC12S-160	12	160	15	36	97	193	20,000	1.2	1.4	
BT50	BT50-DSC6S-110	6	110	9	26	42	166	15,000	3.5	3.8	
	BT50-DSC6S-160	6	160	9	36	97	216	15,000	3.6	4.0	●
	BT50-DSC8S-110	8	110	11	36	42	166	15,000	3.6	3.9	
	BT50-DSC8S-160	8	160	11	36	97	216	15,000	3.6	4.0	●
	BT50-DSC10S-110	10	110	13	36	42	166	15,000	3.6	3.9	
	BT50-DSC10S-160	10	160	13	36	97	216	15,000	3.6	4.0	●
	BT50-DSC12S-110	12	110	15	36	42	166	15,000	3.6	3.9	
	BT50-DSC12S-160	12	160	15	36	97	216	15,000	3.7	4.1	●

(Unit : mm)

1:1 CHAT



ST-DSC/M

Straight Shank Shrinking Chuck

3 μm

Run-out

C

Coolant System



Milling



Drilling



Reaming



Chamfering

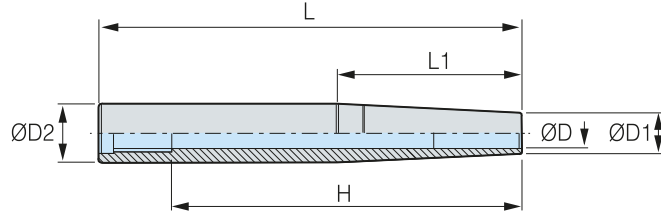

- ● : To be switched to NP order after stock depletion
- H : Depth of tool insertion
- ☐ C Internal coolant system is basic

- For more information on product features, see **52P**
- For more information on the related parts, see **63P**

	Designation	ØD	L	ØD1	ØD2	L1	H	kg	Package Weight (kg)	Stock
ST16	ST16-DSC6M-115	6	115	10	16	50	95	0.1	0.2	●
	ST16-DSC6M-140	6	140	10	16	60	120	0.1	0.2	●
ST20	ST20-DSC6M-175	6	175	10	20	95	155	0.2	0.3	●
	ST20-DSC8M-145	8	145	13	20	70	125	0.2	0.3	●
	ST20-DSC10M-120	10	120	16	20	50	45	0.2	0.3	●
ST25	ST25-DSC8M-175	8	175	13	25	105	155	0.4	0.5	●
	ST25-DSC10M-145	10	145	16	25	75	45	0.4	0.5	●
	ST25-DSC10M-175	10	175	16	25	105	45	0.4	0.5	●
	ST25-DSC12M-120	12	120	19	25	50	45	0.4	0.4	
	ST25-DSC12M-150	12	150	19	25	80	45	0.4	0.4	●
	ST25-DSC16M-175	16	175	24	25	50	47	0.5	0.6	●
ST32	ST32-DSC20M-175	20	175	29	32	50	55	0.8	0.9	●

(Unit : mm)

1:1 CHAT



ST-DSC/S

Straight Shank Shrinking Chuck

3 μ m

C

Run-out

Coolant System

Milling

Drilling

Reaming

Chamfering

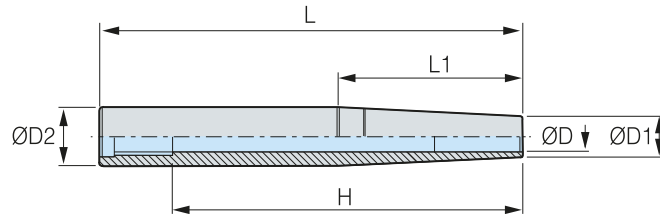

- ● : To be switched to NP order after stock depletion
- H : Depth of tool insertion

C Internal coolant system is basic

- For more information on product features, see **52P**
- For more information on the related parts, see **63P**

	Designation	ØD	L	ØD1	ØD2	L1	H	kg	Package Weight (kg)	Stock
ST16	ST16-DSC6S-115	6	115	9	16	55	95	0.1	0.2	●
	ST16-DSC6S-140	6	140	9	16	70	120	0.1	0.2	●
	ST16-DSC8S-115	8	115	11	16	50	95	0.1	0.2	
ST20	ST20-DSC6S-175	6	175	9	20	105	155	0.2	0.3	●
	ST20-DSC8S-175	8	175	11	20	85	155	0.2	0.3	●
	ST20-DSC10S-145	10	145	13	20	75	77	0.2	0.3	
	ST20-DSC12S-120	12	120	15	20	50	52	0.2	0.3	●
ST32	ST32-DSC12S-315	12	315	15	32	185	295	1.2	1.3	●

(Unit : mm)

1:1 CHAT



DSC SPARE PART

Shrinking Chuck Related Parts

SPARE PART	Type	Main Components	Type	Accessories	
		Adjust Screw		Coolant Tube for HSK	Wrench
	Images		Images		
	Designation		Designation		
	DSC6, DSC8	M520C			
	DSC10, DSC12	M830C	HSK63A	HSK63A-CNS	HSK63-WRENCH(C)
	DSC14, DSC16, DSC18, DSC20, DSC25, DSC32	M1230C			

※Slim and mono type untightened

1:1 CHAT



NPM

New Power Milling Chuck



15 μ m

Run-out



Coolant System



Milling



Drilling



Features

- Strong clamping force improves tool precision
- Dust block function prevents cutting oil and chips from penetrating inside the tool during machining
- Slot design minimizes holder deformation even in roughing
- Boring range : $\varnothing 20 \sim \varnothing 42$ mm

NAMING

BT40	NPM	32	110
Spindle	New Power Milling Chuck	Tool Dia.	Length

Strong Clamping Force

- NPM20 : Min. 130kgf·m
- NPM25 : Min. 265kgf·m
- NPM32 : Min. 350kgf·m
- NPM42 : Min. 500kgf·m
- NPM32(Short Type) : Min. 230kgf·m

Durability Enhanced by Preventing Foreign Objects to be Mixed (Dust Block) PAT.

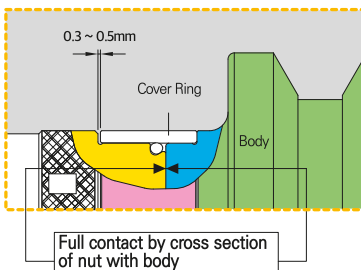

STOP RING applied to the front part Preventing mixing of SHIM RING and O-ring

NPM Structural Features

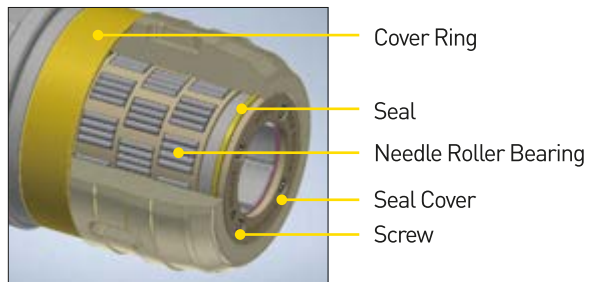

- Needle Roller Bearing (NPM20)

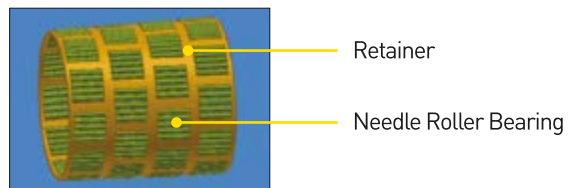

- Special steel bearing used to prevent damage
- Strong tightening due to load dispersion in the process of chucking

Enables Stable Operation from Rough to Medium Machining

Ensures excellent vibration absorption and enhanced cutting power when cutting due to perfect cross-sectional adhesion and strong clamping force



Enables stable operation from rough to medium machining



Radial Depth of Cut (Ae)=1.0mm



Radial Depth of Cut (Ae)=2.5mm



Radial Depth of Cut (Ae)=3.5mm



Radial Depth of Cut (Ae)=5.0mm



Radial Depth of Cut (Ae)=8.0mm

1:1 CHAT



NPM

New Power Milling Chuck



Type

- DBT Type : DBT30, DBT40, DBT50
- BT Type : BT30, BT40, BT50
- HSK Type : HSK63A, HSK50A, HSK100A
- SK Type : SK30, SK40, SK50
- NT Type : NT40, NT50



BT Type

HSK Type

SK Type

NT Type

DBT Type

High Precision

- Run-out accuracy within $15\mu\text{m}$ in the case of $L/D=3$
- Clamp inner diameter (Clamp I.D.) accuracy within $5\mu\text{m}$



Run-out within $15\mu\text{m}$ (Measurement Location : 3D)

Internal Coolant Applicable



NPM

+



CTC(Optional)

=



Internal Coolant Application System

Internal Refueling System

- HSK shank is not available
- Add specifications of the CRS if not the basic application is adopted.
Ex) CTC20-6 : Nut + Screw + CSR-6 (Changeable to the Coolant Stop Ring with specific size instead of standard type)
- ※ Caution: When you fasten the Coolant stop ring (CSR) by using a wrench, if you rotate it continuously, the coolant adjust screw (CAS) will fall below the coolant bush nut (CBN) and the CSR may deviate. So please be careful when using it.



Designation	Nut	Screw	Coolant Stop Ring	Inner Diameter(ϕ)	Applicable Shank	Remarks
CTC32(M16)-□□	CBN-M16N	CAS-M12	CSR-□□	20, 25, 32	#30, 40, 50	#50 is not applicable to inner diameter of $\phi 32$.
CTC32(M24)-□□				32, 42	#50	

※ The above is just an example.

• For more information on product features, see **72P**

⚠ CAUTION

- Be sure not to use a spanner with a pipe, etc. inserted when tightening a milling chuck
- Excessive clamping can deform and/or adversely affect a cutting tool
- When tightening a cutting tool, be sure not to touch it with bare hands
- When using a collet, push it all the way into the milling chuck
- If the insertion depth of the collet is not normal, the tool such as an end mill may fall out and/or the milling chuck may be internally damaged
- In case of a milling chuck failure, do not disassemble it arbitrarily
- In case of a problem arising out of arbitrary disassembly, remember that no compensation will be provided

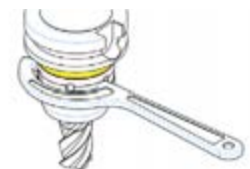

Removable within an average of 2.5 turns

1:1 CHAT



DBT-NPM

New Power Milling Chuck



DBT

Shank

15_μm

Run-out

130~500
kgf·m

Clamping Force

C

Coolant System



Milling



Drilling

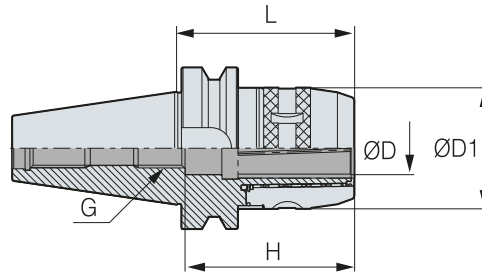

● : Stock

• H : Depth of tool insertion

☐ Internal coolant system is optional

• For more information on product features, see **64P**

• For more information on the related parts, see **72P**

	Designation	ØD	L	ØD1	H	G	Collet	kg	Package Weight (kg)	Stock	
DBT30	DBT30-NPM20-85	20	85	54	85	M16	DC20, DCS20, DCJ20	1.1	1.3		
DBT40	DBT40-NPM20-85	20	85	54	85	M16	DC20, DCS20, DCJ20	2.3	2.5	●	
	DBT40-NPM20-100	20	100	54	85	M16	DC20, DCS20, DCJ20	2.4	2.6		
	DBT40-NPM20-135	20	135	54	85	M16	DC20, DCS20, DCJ20	2.5	2.7		
	DBT40-NPM25-85	25	85	61	83	M16	DC25, DCS25	1.8	1.9		
	DBT40-NPM32-90	32	90	75	85	M16	DC32, DCS32, DCJ32	2.4	2.5		
	DBT40-NPM32-110	32	110	75	95	M16	DC32, DCS32, DCJ32	2.9	3.1	●	
	DBT40-NPM32-120	32	120	75	95	M16	DC32, DCS32, DCJ32	3.1	3.3		
	DBT40-NPM32-135	32	135	75	95	M16	DC32, DCS32, DCJ32	3.4	3.6		
DBT50	DBT50-NPM20-95	20	95	54	85	M16	DC20, DCS20, DCJ20	4.3	4.6		
	DBT50-NPM20-105	20	105	54	85	M16	DC20, DCS20, DCJ20	4.5	4.8	●	
	DBT50-NPM20-125	20	125	54	85	M16	DC20, DCS20, DCJ20	4.8	5.1		
	DBT50-NPM20-165	20	165	54	85	M16	DC20, DCS20, DCJ20	5.3	5.6		
	DBT50-NPM25-95	25	95	61	83	M16	DCS25, DC25	4.6	4.8		
	DBT50-NPM32-90	32	90	75	93	M24	DC32, DCS32, DCJ32	4.9	5.1		
	DBT50-NPM32-110	32	110	75	105	M24	DC32, DCS32, DCJ32	5	5.3	●	
	DBT50-NPM32-135	32	135	75	105	M24	DC32, DCS32, DCJ32	5.8	6.2		
	DBT50-NPM32-165	32	165	75	105	M24	DC32, DCS32, DCJ32	6.9	7.3		
	DBT50-NPM42-110	42	110	90	125	M24	DC42, DCS42	5.6	5.9	●	
	DBT50-NPM42-135	42	135	90	125	M24	DC42, DCS42	6.6	6.9		
	DBT50-NPM42-165	42	165	90	125	M24	DC42, DCS42	8	8.3		

※ If $L \leq 90$, products with over 90 are recommended for roughing due to the application of short type caps.

(Unit : mm)

1:1 CHAT



BT-NPM

New Power Milling Chuck

MAS
403-BT

Shank

15 μ m

Run-out

130~500
kgf·m

Clamping Force

C

Coolant System



Milling



Drilling

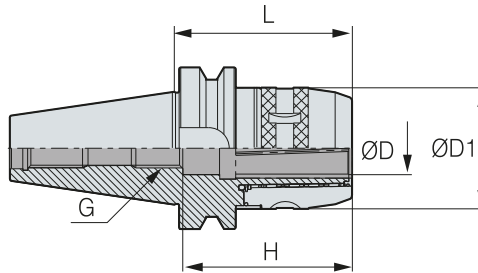

- : Stock
- H : Depth of tool insertion
- C Internal coolant system is optional

- For more information on product features, see **64P**
- For more information on the related parts, see **72P**

	Designation	ØD	L	ØD1	H	G	Collet	kg	Package Weight (kg)	Stock	
BT30	BT30-NPM20-85	20	85	54	85	M16	DC20, DSC20, DCJ20	1.2	1.3	●	
BT40	BT40-NPM20-85	20	85	54	85	M16	DC20, DCS20, DCJ20	2.3	2.6	●	
	BT40-NPM20-100	20	100	54	85	M16	DC20, DCS20, DCJ20	2.3	2.5	●	
	BT40-NPM20-135	20	135	54	85	M16	DC20, DCS20, DCJ20	2.4	2.6		
	BT40-NPM25-85	25	85	61	83	M16	DC25, DCS25	1.7	1.9	●	
	BT40-NPM32-90	32	90	75	85	M16	DC32, DCS32, DCJ32	2.3	2.5	●	
	BT40-NPM32-110	32	110	75	95	M16	DC32, DCS32, DCJ32	2.8	3.1	●	
	BT40-NPM32-120	32	120	75	95	M16	DC32, DCS32, DCJ32	3.0	3.3		
	BT40-NPM32-135	32	135	75	95	M16	DC32, DCS32, DCJ32	3.5	3.8	●	
BT50	BT50-NPM20-95	20	95	54	85	M16	DC20, DCS20, DCJ20	4.3	4.6	●	
	BT50-NPM20-125	20	125	54	85	M16	DC20, DCS20, DCJ20	4.7	5.1	●	
	BT50-NPM20-165	20	165	54	85	M16	DC20, DCS20, DCJ20	5.2	5.6	●	
	BT50-NPM25-95	25	95	61	83	M16	DC25, DCS25	4.6	4.8		
	BT50-NPM32-90	32	90	75	93	M24	DC32, DCS32, DCJ32	4.9	5.1		
	BT50-NPM32-110	32	110	75	105	M24	DC32, DCS32, DCJ32	5.0	5.3	●	
	BT50-NPM32-135	32	135	75	105	M24	DC32, DCS32, DCJ32	5.7	6.1	●	
	BT50-NPM32-165	32	165	75	105	M24	DC32, DCS32, DCJ32	6.9	7.3	●	
	BT50-NPM42-110	42	110	90	125	M24	DC42, DCS42	5.4	5.7	●	
	BT50-NPM42-135	42	135	90	125	M24	DC42, DCS42	6.5	6.9	●	
	BT50-NPM42-165	42	165	90	125	M24	DC42, DCS42	7.9	8.3	●	

※ If $L \leq 90$, products with over 90 are recommended for roughing due to the application of short type caps.

(Unit : mm)

Chuck

Arbor/Modular

Boring Tool

Angular Head

CBN/PCD

Device&Accessory

Standard

1:1 CHAT



HSK-NPM

New Power Milling Chuck



DIN
69893-1

Shank

15 μ m

Run-out

130~350
kgf-m

Clamping Force

C

Coolant System



Milling



Drilling

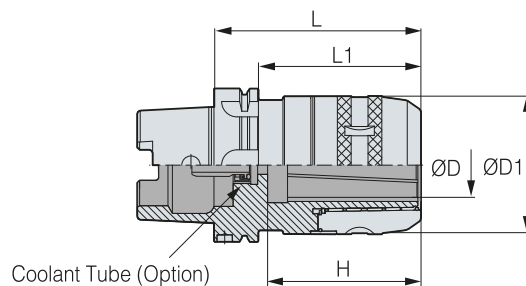

• ● : Stock

• H : Depth of tool insertion

☐ Internal coolant system is optional

• For more information on product features, see **64P**

• For more information on the related parts, see **72P**

	Designation	ØD	L	ØD1	L1	H	Collet	kg	Package Weight (kg)	Stock
HSK50A	HSK50A-NPM20-100	20	100	54	74	75	DC20, DCS20, DCJ20	1	1.2	
HSK63A	HSK63A-NPM20-100	20	100	54	74	75	DC20, DCS20, DCJ20	1.6	1.8	●
	HSK63A-NPM25-100	25	100	61	74	75	DC25, DCS25	1.9	2.1	
	HSK63A-NPM32-110	32	110	75	84	82	DC32, DCS32, DCJ32	2.5	2.7	
	HSK63A-NPM32-120	32	120	75	84	90	DC32, DCS32, DCJ32	2.9	2.8	●
HSK100A	HSK100A-NPM20-110	20	110	54	81	75	DC20, DCS20, DCJ20	3	3.2	
	HSK100A-NPM25-110	25	110	61	81	75	DC25, DCS25, DCJ25	3.2	3.4	
	HSK100A-NPM32-115	32	115	75	86	82	DC32, DCS32, DCJ32	4.1	4.4	
	HSK100A-NPM32-130	32	130	75	101	90	DC32, DCS32, DCJ32	4	4.9	●
	HSK100A-NPM42-135	42	135	90	106	100	DC42, DCS42	5.7	6.0	

(Unit : mm)

Accessories

SPARE PART	Type	Accessories	
		Coolant Tube for HSK	Wrench
	Images		
	Designation		
	HSK50A	HSK50A-CNS	HSK50-WRENCH(C)
	HSK63A	HSK63A-CNS	HSK63-WRENCH(C)
	HSK100A	HSK100A-CNS	HSK100-WRENCH(C)

1:1 CHAT 



NT-NPM

New Power Milling Chuck



DIN2080
JISB6101

Shank

15_{µm}

Run-out

C

Coolant System



Milling



Drilling

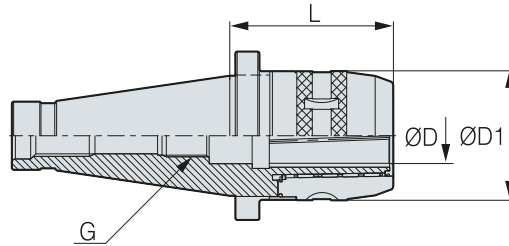

● : Stock

C This product does not support the internal coolant system

• For more information on product features, see **64P**

• For more information on the related parts, see **72P**

	Designation	ØD	L	ØD1	G	Collet	kg	Package Weight (kg)	Stock
NT40	NT40-NPM32-95	32	95	75	M16	DC32, DCS32	2.7	2.9	●
NT50	NT50-NPM32-95	32	95	75	M24	DC32, DCS32	4.3	4.6	●
	NT50-NPM42-95	42	95	90	M24	DC42, DCS42	4.8	5.1	●
NT50M	NT50M-NPM32-95	32	95	75	M24	DC32, DCS32	4.4	4.7	●
	NT50M-NPM42-95	42	95	90	M24	DC42, DCS42	4.9	5.2	●

(Unit : mm)

1:1 CHAT



BT-NPM SET

New Power Milling Chuck SET

MAS
403-BT

Shank

15 μ m

Run-out

130~500
kgf·m

Clamping Force

C

Coolant System



Milling



Drilling

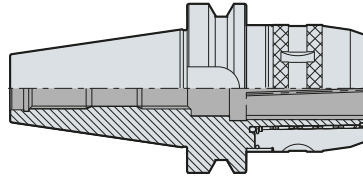

- : Stock
- HSK, SK / B Set are customizable
- C Internal coolant system is optional

• For more information on product features, see **64P**

Type	Body	Collet	TC	DJT	Spanner	Stock	
Images						Stock	
Designation							
A SET	BT40-NPM20-85(A)	BT40-NPM20-85	DC20-6, 8, 10, 12, 16	-	-	57-60	
	BT40-NPM32-110(A)	BT40-NPM32-110	DC32-6, 8, 10, 12, 16, 20, 25	-	-	75-79	●
	BT50-NPM32-110(A)	BT50-NPM32-110	DC32-6, 8, 10, 12, 16, 20, 25	-	-	75-79	●
	BT50-NPM42-110(A)	BT50-NPM42-110	DC42-6, 8, 10, 12, 16, 20, 25	-	-	92-96	●
B SET	BT40-NPM20-85(B)	BT40-NPM20-85	DC20-6, 8, 10, 12, 16	TC20-1,2	DJT20-6	57-60	
	BT40-NPM32-110(B)	BT40-NPM32-110	DC32-6, 8, 10, 12, 16, 20, 25	TC32-1,2,3	DJT32-6	75-79	
	BT50-NPM32-110(B)	BT50-NPM32-110	DC32-6, 8, 10, 12, 16, 20, 25	TC32-1,2,3	DJT32-6	75-79	
	BT50-NPM42-110(B)	BT50-NPM42-110	DC42-6, 8, 10, 12, 16, 20, 25	TC42-1,2,3	DJT42-6	92-96	

(Unit : mm)

1:1 CHAT



NT-NPM SET

New Power Milling Chuck SET

DIN2080
JISB6101

Shank

15 μ m

Run-out

C

Coolant System



Milling



Drilling

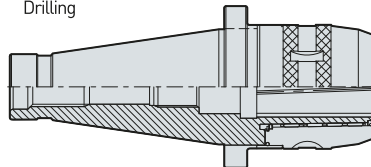

- : To be switched to NP order after stock depletion
- C This product does not support the internal coolant system

• For more information on product features, see **64P**

Type	Body	Collet	TC Collet	DJT	Spanner	Stock	
Images						Stock	
Designation							
NT40	NT40-NPM32-95(B)	NT40-NPM32-95	DC32-6, 8, 10, 12, 16, 20, 25	TC32-MT1,2,3	DJT32-6	75-79	●
NT50	NT50-NPM32-95(B)	NT50-NPM32-95	DC32-6, 8, 10, 12, 16, 20, 25	TC32-MT1,2,3	DJT32-6	75-79	●
	NT50-NPM42-95(B)	NT50-NPM42-95	DC42-6, 8, 10, 12, 16, 20, 25, 32	TC42-MT1,2,3,4	DJT42-6	92-96	●

(Unit : mm)

Chuck

Arbor/Modular

Boring Tool

Angular Head

cBN/PCD

Device&Accessory

Standard

1:1 CHAT



NPM SPARE PART

New Power Milling Chuck Related Parts



Accessories(BT/SK)

SPARE PART	Type	Accessories		
		Coolant System (BT/SK)	Collet	Spanner
	Images			
	Designation			
	NPM20	CTC20-□□	DCS20, DC20, DCJ20	57-60
	NPM25	-	DCS25, DC25	61-65
	NPM32	CTC32-□□	DCS32, DC32, DCJ32	75-79
	NPM42	CTC42-□□	DC42, DCS42	92-96

Accessories(HSK)

SPARE PART	Type	Accessories	
		Coolant Tube for HSK	Wrench
	Images		
	Designation		
	HSK50A	HSK50A-CNS	HSK50-WRENCH(C)
	HSK63A	HSK63A-CNS	HSK63-WRENCH(C)
	HSK100A	HSK100A-CNS	HSK100-WRENCH(C)

Internal Refueling System

- HSK shank is not available
- Select the CSR according to the outer diameter of the tool shank you want to use.

EX) CTC20-6 : Nut + Screw + CSR-6

※ Caution : If the coolant stop ring (CSR) is rotated continuously using Wrench that the coolant adjust screw (CAS) will be used, falls below the Coolant Bush Nut (CBN) and the CSR is dropped, so please be careful when using it.



Designation	Nut	Screw	Coolant Stop Ring	Inner Diameter	Hole Diameter	Applied Screw(G)	Remarks
CTC20(M16)-□□	CBN-M16N	CAS-M12	CSR-□□	20	6,8,10,12,16,20	M16	-
CTC32(M16)-□□	CBN-M16N	CAS-M12	CSR-□□	32	6,8,10,12,16,20,25,32	M16	-
CTC32(M16)-□□	CBN-M24N	CAS-M12	CSR-□□	32	6,8,10,12,16,20,25,32	M24	-
CTC32(M16)-□□	CBN-M24N	CAS-M12	CSR-□□	42	6,8,10,12,16,20,25,32,42	M24	-
CTC42(M24)-□□	CBN-M24N	CAS-M12	CSR-□□	42	42	M24	-

※ For the CTC32 type, use two types, CTC32(M12) and CTC32(M24), because the standard of Adjust Screw per Shank is different.

※ For the Coolant Stop Ring (CSR), you can select the specification option that suits your situation.

1:1 CHAT



BT-DMC NEW

Dine Milling Chuck



MAS 403-BT

Shank

15 μ m

Run-out

130-500 kgf·m

Clamping Force

C

Coolant System

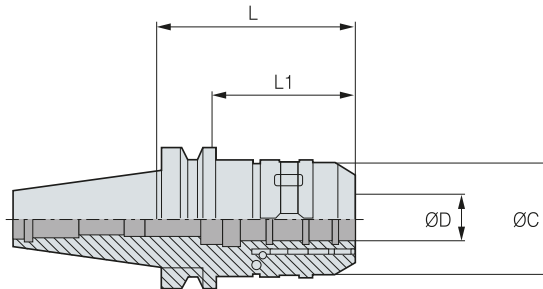

● : Stock

C Internal coolant system is optional

	Designation	ØD	L	ØC	L1	Applicable Collet (Optional)	Package Weight (kg)	Stock
BT30	BT30-DMC20-80	20	80	54	80	DC20, DCS20	1.0	●
BT40	BT40-DMC20-90	20	90	54	80	DC20, DCS20	2.3	●
	BT40-DMC32-105	32	105	75	95	DC32, DCS32	2.9	●
BT50	BT50-DMC32-105	32	105	75	95	DC32, DCS32	4.9	●
	BT50-DMC32-165	32	165	75	95	DC32, DCS32	6.7	●
	BT50-DMC42-105	42	105	90	125	DC42, DCS42	5.2	●
	BT50-DMC42-165	42	165	90	125	DC42, DCS42	8.0	●

(Unit : mm)

Accessories

SPARE PART	Type	Spanner
	Images	
Designation		
	DMC 20	57-60
	DMC 32	75-79
	DMC 42	92-96

1:1 CHAT



DCL

Lock Collet for Milling Chuck



Coolant System



Lock



Features

- The mechanical fastening method enables the prevention of tool deviation
- Stable tool fastening force even under extreme machining conditions

NAMING

DCL	32	20
DINE Lock-Collet	Collet Size	Tool Dia.

Structural Features

Designed to Prevent Fallout

- Designed especially for extreme machining with a lot of mechanical actions, prevents the tool from deviating or pull out
- Weldon flat (DINE 6535HB) end mill used

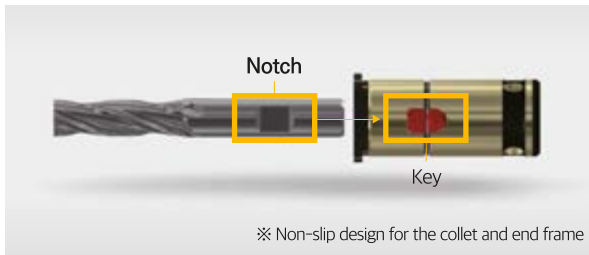

Non-slip Structure

- Closely adhered to the grooves of the milling chuck
 - No slip occurring even under high torque



Detailed Specifications

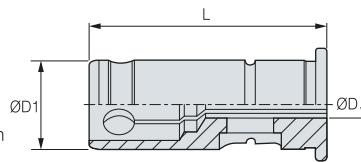

- ● To be switched to NP order after stock depletion
- ※ Use DIN 6535HB standard end mill

	Designation	ØD	L	ØD1	Stock
DCL20	DCL20-6	6	53	20	●
	DCL20-8	8	53	20	●
	DCL20-10	10	53	20	●
	DCL20-12	12	53	20	●
	DCL20-14	14	53	20	●
	DCL20-16	16	53	20	●
DCL32	DCL32-6	6	53	32	●
	DCL32-8	8	65	32	●
	DCL32-10	10	65	32	●
	DCL32-12	12	65	32	●
	DCL32-14	14	65	32	●
	DCL32-16	16	65	32	●
	DCL32-18	18	65	32	●
	DCL32-20	20	65	32	●
	DCL32-25	25	65	32	●

※ Caution: In order to use DCL, an exclusive milling chuck is required, so please inquire the details at the sales department

(Unit : mm)

Example Order BT40-NPM32-110 (DCL)

1:1 CHAT



DCL SPARE PART

Non-slip Milling Chuck Collet Related Parts



SPARE PART

Type	Main Components	
	Key	C-grip
Images		
Designation		
DCL20-6	DCL20-6K	DCL-CG20
DCL20-8	DCL20-8K	DCL-CG20
DCL20-10	DCL20-10K	DCL-CG20
DCL20-12	DCL20-12K	DCL-CG20
DCL20-14	DCL20-14K	DCL-CG20
DCL20-16	DCL20-16K	DCL-CG20
DCL32-6	DCL32-6K	DCL-CG32
DCL32-8	DCL32-8K	DCL-CG32
DCL32-10	DCL32-10K	DCL-CG32
DCL32-12	DCL32-12K	DCL-CG32
DCL32-14	DCL32-14K	DCL-CG32
DCL32-16	DCL32-16K	DCL-CG32
DCL32-18	DCL32-18K	DCL-CG32
DCL32-20	DCL32-20K	DCL-CG32
DCL32-25	DCL32-25K	DCL-CG32

(Unit : mm)

1:1 CHAT



NOTCHED ENDMILL

Notched Endmill

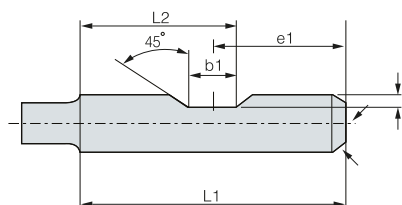

Tool \varnothing	Tool (DIN6535)				
	L1	e1	b1	L2	t
6	36	18	4.2	20.1	0.9
8	36	18	5.5	20.75	1.1
10	40	20	7	23.5	1.5
12	45	22.5	8	26.5	1.6
14	45	22.5	8	26.5	1.3
16	48	24	10	29	1.8
18	48	24	10	29	1.8
20	50	25	11	30.5	1.8
25	56	32	12	30	2.0
32	60	36	14	31	2.0

※ Use DIN 6535HB standard end mill. ※ As a separate purchase, it can be referred to when using ER/L collet.

(Unit : mm)

1:1 CHAT



DCJ

Jet Coolant Collet (for Milling Chuck)



Jet Coolant



Inside Coolant



Features

- Jet coolant function is available just by fastening the milling chuck
- Internal coolant use possible with O-ring fastening
- Reduces damage on workpiece caused by chips

Designation	Ø6	Ø8	Ø10	Ø12	Ø16	Ø20	Ø25	Ø32
NPM20	✓	✓	✓	✓	✓			
NPM32	✓	✓	✓	✓	✓	✓	✓	
NPM42	✓	✓	✓	✓	✓	✓	✓	✓

※ Can be used for an ultrahigh-pressure inside coolant

NPM+JET Coolant Collet

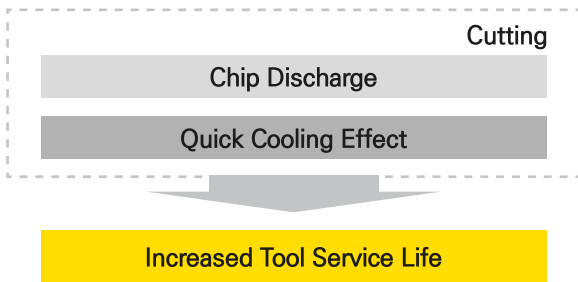

Easy Assembly

Can be used by only combining a collet with the conventional chuck (NPM)



Coolant Type

Jet Coolant



Inside Coolant



Chip Evacuation



Coolant Type

	Type	Designation	Stock
NPM20	NPM20	DCJ20-6	
	NPM20	DCJ20-8	
	NPM20	DCJ20-10	
	NPM20	DCJ20-12	
	NPM20	DCJ20-16	
NPM32	NPM32	DCJ32-6	
	NPM32	DCJ32-8	
	NPM32	DCJ32-10	
	NPM32	DCJ32-12	
	NPM32	DCJ32-16	
	NPM32	DCJ32-20	
	NPM32	DCJ32-25	

(Unit : mm)

1:1 CHAT

**DC**

Straight Collet

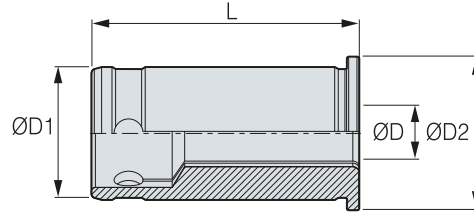

● : Stock

	Designation	ØD	L	ØD1	ØD2	kg	Package Weight (kg)	Stock
DC20	DC20-6	6	53	20	25	0.1	0.1	●
	DC20-8	8	53	20	25	0.1	0.1	●
	DC20-10	10	53	20	25	0.1	0.1	●
	DC20-12	12	53	20	25	0.1	0.1	●
	DC20-14	14	53	20	25	0.1	0.1	●
	DC20-16	16	53	20	25	0.1	0.1	●
DC25	DC25-6	6	62	25	29	0.2	0.2	●
	DC25-8	8	62	25	29	0.2	0.2	●
	DC25-10	10	62	25	29	0.2	0.2	●
	DC25-12	12	62	25	29	0.2	0.2	●
	DC25-16	16	62	25	29	0.2	0.2	●
DC32	DC32-6	6	65	32	37	0.2	0.3	●
	DC32-8	8	65	32	37	0.2	0.3	●
	DC32-10	10	65	32	37	0.2	0.3	●
	DC32-12	12	65	32	37	0.2	0.3	●
	DC32-14	14	65	32	37	0.2	0.3	●
	DC32-16	16	65	32	37	0.2	0.3	●
	DC32-19	19	65	32	37	0.2	0.3	●
	DC32-20	20	65	32	37	0.2	0.3	●
	DC32-25	25	65	32	37	0.2	0.3	●
DC42	DC42-6	6	73	42	47	0.5	0.5	●
	DC42-8	8	73	42	47	0.5	0.5	●
	DC42-10	10	73	42	47	0.5	0.5	●
	DC42-12	12	73	42	47	0.5	0.5	●
	DC42-16	16	73	42	47	0.5	0.5	●
	DC42-20	20	73	42	47	0.5	0.5	●
	DC42-25	25	73	42	47	0.5	0.5	●
	DC42-32	32	73	42	47	0.5	0.5	●

(Unit : mm)

Chuck

Arbor/Modular

Boring Tool

Angular Head

cBN/PCD

Device&Accessory

Standard

1:1 CHAT



DCS

Straight Collet

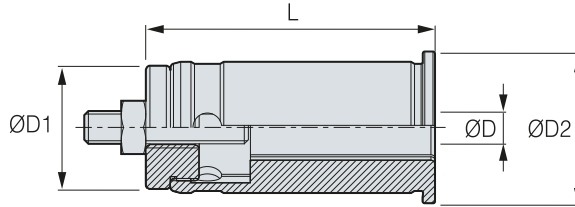

- : Stock
- It can be adjusted in length with a collet adjustment screw

	Designation	ØD	L	ØD1	ØD2	kg	Package Weight (kg)	Stock	
DCS20	DCS20-6	6	57	20	25	0.1	0.1	●	
	DCS20-8	8	57	20	25	0.1	0.1	●	
	DCS20-10	10	57	20	25	0.1	0.1	●	
	DCS20-12	12	57	20	25	0.1	0.1	●	
	DCS20-16	16	57	20	25	0.1	0.1	●	
DCS32	DCS32-6	6	70.5	32	37	0.2	0.3	●	
	DCS32-8	8	70.5	32	37	0.2	0.3	●	
	DCS32-10	10	70.5	32	37	0.2	0.3	●	
	DCS32-12	12	70.5	32	37	0.2	0.3	●	
	DCS32-14	14	70.5	32	37	0.2	0.3	●	
	DCS32-16	16	70.5	32	37	0.2	0.3	●	
	DCS32-19	19	70.5	32	37	0.2	0.3	●	
	DCS32-20	20	70.5	32	37	0.2	0.3	●	
	DCS32-25	25	70.5	32	37	0.2	0.3	●	
DCS42	DCS42-6	6	80	42	47	0.5	0.6	●	
	DCS42-8	8	80	42	47	0.5	0.6	●	
	DCS42-10	10	80	42	47	0.5	0.6	●	
	DCS42-12	12	80	42	47	0.5	0.6	●	
	DCS42-16	16	80	42	47	0.5	0.6	●	
	DCS42-20	20	80	42	47	0.5	0.6	●	
	DCS42-25	25	80	42	47	0.5	0.6	●	
	DCS42-32	32	80	42	47	0.5	0.6	●	

(Unit : mm)

1:1 CHAT



TC

Taper Collet

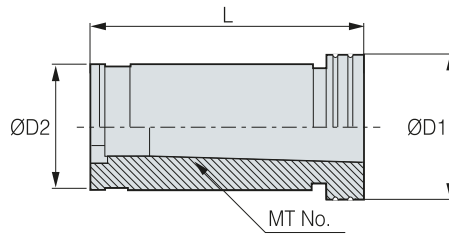

● : Stock

	Designation	MT No.	L	ØD1	ØD2	kg	Package Weight (kg)	Stock
TC20	TC20-1	MT1	60	26	20	0.1	0.1	●
	TC20-2	MT2	72	26	20	0.1	0.1	●
TC25	TC25-1	MT1	60	32	25	0.2	0.2	●
	TC25-2	MT2	72	32	25	0.2	0.2	●
TC32	TC32-1	MT1	60	38	32	0.4	0.4	●
	TC32-2	MT2	72	38	32	0.4	0.4	●
	TC32-3	MT3	90	38	32	0.4	0.4	●
TC42	TC42-1	MT1	60	48	42	0.6	0.6	●
	TC42-2	MT2	72	48	42	0.7	0.7	●
	TC42-3	MT3	90	48	42	0.8	0.8	●
	TC42-4	MT4	113	48	42	0.9	0.9	●

(Unit : mm)

1:1 CHAT



DJT

Drill Chuck Arbor

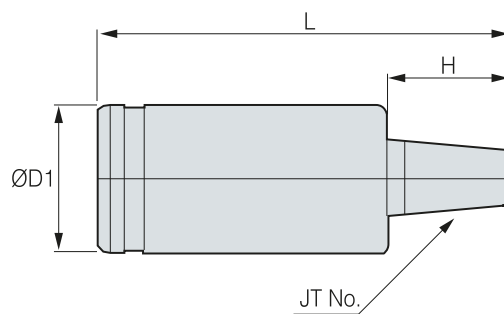

● : Stock

	Designation	JT No.	L	ØD1	H	kg	Package Weight (kg)	Stock
DJT20	DJT20-6	JT6	83	20	28	0.2	0.2	●
DJT32	DJT32-6	JT6	93	32	28	0.5	0.5	●
DJT42	DJT42-6	JT6	103	42	28	0.9	0.9	●

(Unit : mm)

Chuck

Arbor/Modular

Boring Tool

Angular Head

cBN/PCD

Device&Accessory

Standard

1:1 CHAT



SDC/P

Precision Collet Chuck for Multi Purpose Machining



Ø26

Max Dia

C

Coolant System

ER

ER Collet

Milling

Drilling

Tapping

Chamfering



Features

- Superior efficiency for general machining due to affordable pricing and stable performance
- The sleeve nuts allows stable run-out when compared to other companies
- Wide fastening range applicable
- Various machining available just by replacing the collet
- Chucking Range : Ø1-Ø26mm

NAMING

BT30	SDC	10	P	100
Spindle	Collet Chuck	Tool Dia.	Precision	Length

Bearing Nuts Designed for Improved Precision

Soft Sleeve Bearing RN Nut



Jet Coolant Disk Applicable

After replacing with RT/RUT nut, connect RTJW to use jet coolant - internal coolant



SDC/P Application

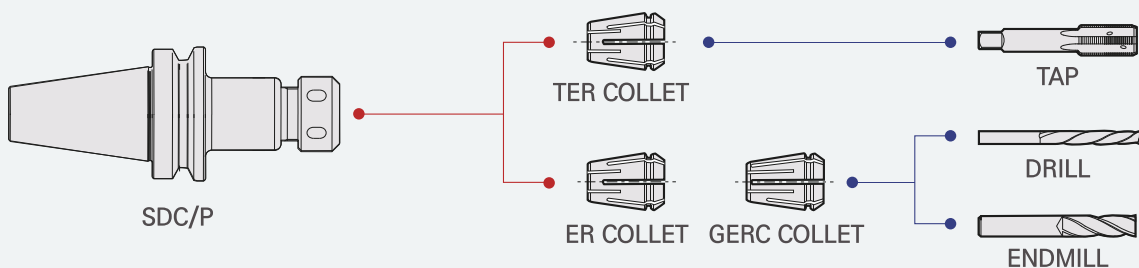

1:1 CHAT



DBT-SDC/P

Precision Collet Chuck for Multi Purpose Machining



DBT

Shank

Ø26

Max Dia

C

Coolant System

ER

ER Collet

Milling

Drilling

Tapping

Chamfering

Fig.1

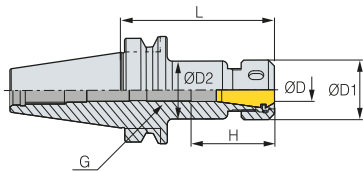

Fig.2

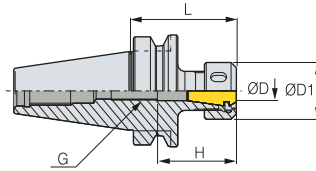
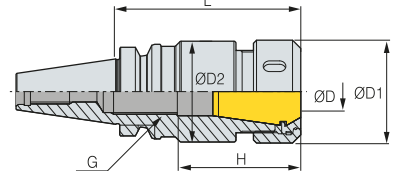

Fig.3



- : Stock

- H : Depth of tool insertion

- C Internal coolant system is optional

- ※ Coolant collet is used when applying coolant system.

- For more information on product features, see **80P**

- For more information on the related parts, see **86P**

- For more information on the applicable collet, see **94P**

	Designation	ØD	L	ØD1	ØD2	H	Collet/Step	G	Fig.	kg	Package Weight (kg)	Stock
DBT30	DBT30-SDC7P-70	1.0~7.0	70	18	17	33	GERC11/0.5	M7	1	0.5	0.5	
	DBT30-SDC7P-100	1.0~7.0	100	18	17	33	GERC11/0.5	M7	1	0.5	0.6	
	DBT30-SDC10P-50	1.0~10.0	50	32	-	45	GERC16/1.0	M10	2	0.5	0.6	
	DBT30-SDC10P-70	1.0~10.0	70	32	31	45	GERC16/1.0	M10	1	0.6	0.6	●
	DBT30-SDC10P-100	1.0~10.0	100	32	31	45	GERC16/1.0	M10	1	0.7	0.9	
	DBT30-SDC13P-50	1.0~13.0	50	35	-	49	GERC20/1.0	M13	2	0.5	0.6	
	DBT30-SDC13P-70	1.0~13.0	70	35	34	49	GERC20/1.0	M13	1	0.6	0.7	
	DBT30-SDC13P-100	1.0~13.0	100	35	34	49	GERC20/1.0	M13	1	0.8	0.9	
	DBT30-SDC16P-50	2.0~16.0	50	42	-	50	GERC25/1.0	M18	2	0.5	0.6	
	DBT30-SDC16P-70	2.0~16.0	70	42	41	50	GERC25/1.0	M18	1	0.7	0.8	
	DBT30-SDC16P-100	2.0~16.0	100	42	41	50	GERC25/1.0	M18	1	1.0	1.1	
	DBT30-SDC20P-60	2.0~20.0	60	50	-	60	GERC32/1.0	M22	2	0.6	0.7	●
	DBT30-SDC20P-90	2.0~20.0	90	50	49	60	GERC32/1.0	M22	3	1.0	1.1	●
	DBT30-SDC20P-120	2.0~20.0	120	50	49	60	GERC32/1.0	M22	3	1.4	1.5	
DBT40	DBT40-SDC7P-70	1.0~7.0	70	18	17	33	GERC11/0.5	M7	1	0.9	1.1	
	DBT40-SDC7P-90	1.0~7.0	90	18	17	33	GERC11/0.5	M7	1	0.9	1.2	●
	DBT40-SDC7P-130	1.0~7.0	130	18	17	33	GERC11/0.5	M7	1	1.0	1.2	
	DBT40-SDC10P-70	1.0~10.0	70	32	31	45	GERC16/1.0	M10	1	1.0	1.2	
	DBT40-SDC10P-90	1.0~10.0	90	32	31	45	GERC16/1.0	M10	1	1.2	1.4	●
	DBT40-SDC10P-130	1.0~10.0	130	32	31	45	GERC16/1.0	M10	2	1.4	1.5	●
	DBT40-SDC13P-70	1.0~13.0	70	35	34	49	GERC20/1.0	M13	1	1.1	1.2	
	DBT40-SDC13P-90	1.0~13.0	90	35	34	49	GERC20/1.0	M13	1	1.2	1.4	●
	DBT40-SDC13P-130	1.0~13.0	130	35	34	49	GERC20/1.0	M13	1	1.4	1.6	
	DBT40-SDC13P-150	1.0~13.0	150	35	34	49	GERC20/1.0	M13	1	1.6	1.8	
	DBT40-SDC16P-70	2.0~16.0	70	42	41	50	GERC25/1.0	M18	1	1.1	1.3	
	DBT40-SDC16P-90	2.0~16.0	90	42	41	50	GERC25/1.0	M18	1	1.3	1.5	●
	DBT40-SDC16P-130	2.0~16.0	130	42	41	50	GERC25/1.0	M18	1	1.7	1.9	
	DBT40-SDC20P-70	2.0~20.0	70	50	-	60	GERC32/1.0	M22	2	1.1	1.3	
	DBT40-SDC20P-90	2.0~20.0	90	50	49	60	GERC32/1.0	M22	1	1.4	1.6	●
	DBT40-SDC20P-130	2.0~20.0	130	50	49	60	GERC32/1.0	M22	1	1.9	2.2	●
	DBT40-SDC20P-150	2.0~20.0	150	50	49	60	GERC32/1.0	M22	1	2.2	2.5	
	DBT40-SDC26P-90	4.0~26.0	90	63	62	71	GERC40/1.0	M28	1	1.7	1.9	

(Unit : mm)

1:1 CHAT



DBT-SDC/P

Precision Collet Chuck for Multi Purpose Machining



Fig.1

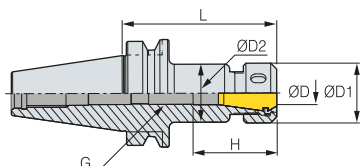
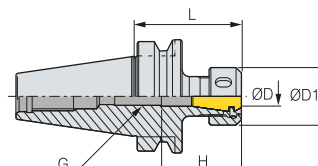

Fig.2



● : Stock

• H : Depth of tool insertion

☐ Internal coolant system is optional

※ Using oil hole types requires the standard dimension

• For more information on product features, see **80P**

• For more information on the related parts, see **86P**

• For more information on the applicable collet, see **94P**

Designation	ØD	L	ØD1	ØD2	H	Collet/Step	G	Fig.	kg	Package Weight (kg)	Stock	
DBT50	DBT50-SDC10P-100	1.0~10.0	100	32	31	45	GERC16/1.0	M10	1	3.7	4.0	
	DBT50-SDC10P-120	1.0~10.0	120	32	31	45	GERC16/1.0	M10	1	3.7	4.1	
	DBT50-SDC10P-160	1.0~10.0	160	32	31	45	GERC16/1.0	M10	1	3.8	4.4	
	DBT50-SDC13P-100	1.0~13.0	100	35	34	49	GERC20/1.0	M13	1	3.8	4.1	
	DBT50-SDC13P-130	1.0~13.0	130	35	34	49	GERC20/1.0	M13	1	3.8	4.2	●
	DBT50-SDC13P-160	1.0~13.0	160	35	34	49	GERC20/1.0	M13	1	4.1	4.5	
	DBT50-SDC13P-180	1.0~13.0	180	35	34	49	GERC20/1.0	M13	1	4.2	4.6	
	DBT50-SDC16P-100	2.0~16.0	100	42	41	50	GERC25/1.0	M18	1	3.9	4.2	●
	DBT50-SDC16P-160	2.0~16.0	160	42	41	50	GERC25/1.0	M18	1	4.3	4.7	
	DBT50-SDC20P-70	2.0~20.0	70	50	-	60	GERC32/1.0	M22	2	1.7	2.0	
	DBT50-SDC20P-100	2.0~20.0	100	50	49	60	GERC32/1.0	M22	1	4.0	4.3	●
	DBT50-SDC20P-130	2.0~20.0	130	50	49	60	GERC32/1.0	M22	1	4.3	4.7	
	DBT50-SDC20P-160	2.0~20.0	160	50	49	60	GERC32/1.0	M22	1	4.7	5.1	●
	DBT50-SDC20P-180	2.0~20.0	180	50	49	60	GERC32/1.0	M22	1	5.0	5.4	
	DBT50-SDC26P-160	4.0~26.0	160	63	62	71	GERC40/1.0	M28	1	5.5	5.9	

(Unit : mm)

1:1 CHAT



BT-SDC/P

Precision Collet Chuck for Multi Purpose Machining



MAS
403-BT

Shank

Ø26

Max Dia

C

Coolant System

ER

ER Collet

Milling

Drilling

Tapping

Chamfering

Fig.1

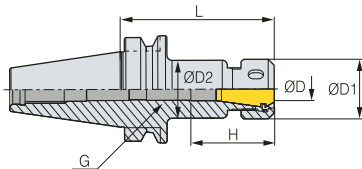

Fig.2

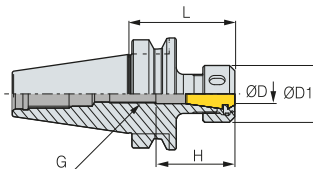
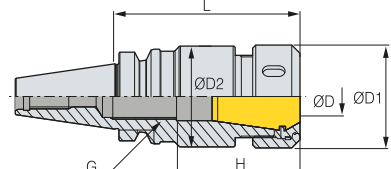

Fig.3



● : Stock

H : Depth of tool insertion

C Internal coolant system is optional

※ Using oil hole types requires the standard dimension

• For more information on product features, see **80P**

• For more information on the related parts, see **86P**

• For more information on the applicable collet, see **94P**

	Designation	ØD	L	ØD1	ØD2	H	Collet/Step	G	Fig.	kg	Package Weight (kg)	Stock
BT30	BT30-SDC7P-70	1.0~7.0	70	18	17	33	GERC11/0.5	M7	1	0.5	0.5	●
	BT30-SDC7P-100	1.0~7.0	100	18	17	33	GERC11/0.5	M7	1	0.5	0.6	●
	BT30-SDC10P-50	1.0~10.0	50	32	-	45	GERC16/1.0	M10	2	0.5	0.6	●
	BT30-SDC10P-70	1.0~10.0	70	32	31	45	GERC16/1.0	M10	1	0.6	0.6	●
	BT30-SDC10P-100	1.0~10.0	100	32	31	45	GERC16/1.0	M10	1	0.7	0.9	●
	BT30-SDC13P-50	1.0~13.0	50	35	-	49	GERC20/1.0	M13	2	0.5	0.6	●
	BT30-SDC13P-70	1.0~13.0	70	35	34	49	GERC20/1.0	M13	1	0.6	0.7	●
	BT30-SDC13P-100	1.0~13.0	100	35	34	49	GERC20/1.0	M13	1	0.8	0.9	●
	BT30-SDC16P-50	2.0~16.0	50	42	-	50	GERC25/1.0	M18	2	0.5	0.6	●
	BT30-SDC16P-70	2.0~16.0	70	42	41	50	GERC25/1.0	M18	1	0.7	0.8	●
	BT30-SDC16P-100	2.0~16.0	100	42	41	50	GERC25/1.0	M18	1	1.0	1.1	●
	BT30-SDC20P-60	2.0~20.0	60	50	-	60	GERC32/1.0	M22	2	0.6	0.7	●
BT30-SDC20P-90	2.0~20.0	90	50	49	60	GERC32/1.0	M22	3	1.0	1.1	●	
BT30-SDC20P-120	2.0~20.0	120	50	49	60	GERC32/1.0	M22	3	1.4	1.5	●	
BT40	BT40-SDC7P-70	1.0~7.0	70	18	17	33	GERC11/0.5	M7	1	0.9	1.1	●
	BT40-SDC7P-90	1.0~7.0	90	18	17	33	GERC11/0.5	M7	1	0.9	1.2	●
	BT40-SDC7P-130	1.0~7.0	130	18	17	33	GERC11/0.5	M7	1	1.0	1.2	●
	BT40-SDC10P-70	1.0~10.0	70	32	31	45	GERC16/1.0	M10	1	1.0	1.2	●
	BT40-SDC10P-90	1.0~10.0	90	32	31	45	GERC16/1.0	M10	1	1.2	1.4	●
	BT40-SDC10P-130	1.0~10.0	130	32	31	45	GERC16/1.0	M10	2	1.4	1.5	●
	BT40-SDC13P-70	1.0~13.0	70	35	34	49	GERC20/1.0	M13	1	1.1	1.2	●
	BT40-SDC13P-90	1.0~13.0	90	35	34	49	GERC20/1.0	M13	1	1.2	1.4	●
	BT40-SDC13P-130	1.0~13.0	130	35	34	49	GERC20/1.0	M13	1	1.4	1.6	●
	BT40-SDC13P-150	1.0~13.0	150	35	34	49	GERC20/1.0	M13	1	1.6	1.8	●
	BT40-SDC16P-70	2.0~16.0	70	42	41	50	GERC25/1.0	M18	1	1.1	1.3	●
	BT40-SDC16P-90	2.0~16.0	90	42	41	50	GERC25/1.0	M18	1	1.3	1.5	●
	BT40-SDC16P-130	2.0~16.0	130	42	41	50	GERC25/1.0	M18	1	1.7	1.9	●
	BT40-SDC20P-70	2.0~20.0	70	50	-	60	GERC32/1.0	M22	2	1.1	1.3	●
	BT40-SDC20P-90	2.0~20.0	90	50	49	60	GERC32/1.0	M22	1	1.4	1.6	●
	BT40-SDC20P-130	2.0~20.0	130	50	49	60	GERC32/1.0	M22	1	1.9	2.2	●
	BT40-SDC20P-150	2.0~20.0	150	50	49	60	GERC32/1.0	M22	1	2.2	2.5	●
	BT40-SDC26P-90	4.0~26.0	90	63	62	71	GERC40/1.0	M28	1	1.7	1.9	●

(Unit : mm)

Chuck

Arbor/Modular

Boring Tool

Angular Head

cBN/PCD

Device&Accessory

Standard



BT-SDC/P

Precision Collet Chuck for Multi Purpose Machining



Fig.1

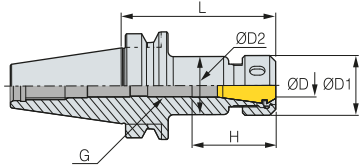
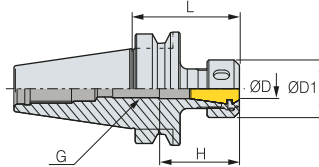

Fig.2



● : Stock

• H : Depth of tool insertion

☑ Internal coolant system is optional

※ Using oil hole types requires the standard dimension

• For more information on product features, see **80P**

• For more information on the related parts, see **86P**

• For more information on the applicable collet, see **94P**

Designation	ØD	L	ØD1	ØD2	H	Collet/Step	G	Fig.	kg	Package Weight (kg)	Stock
BT50-SDC10P-100	1.0~10.0	100	32	31	45	GERC16/1.0	M10	1	3.7	4.0	●
BT50-SDC10P-120	1.0~10.0	120	32	31	45	GERC16/1.0	M10	1	3.7	4.1	●
BT50-SDC10P-160	1.0~10.0	160	32	31	45	GERC16/1.0	M10	1	3.8	4.4	●
BT50-SDC13P-100	1.0~13.0	100	35	34	49	GERC20/1.0	M13	1	3.8	4.1	●
BT50-SDC13P-130	1.0~13.0	130	35	34	49	GERC20/1.0	M13	1	3.8	4.2	●
BT50-SDC13P-160	1.0~13.0	160	35	34	49	GERC20/1.0	M13	1	4.1	4.5	●
BT50-SDC13P-180	1.0~13.0	180	35	34	49	GERC20/1.0	M13	1	4.2	4.6	●
BT50-SDC16P-100	2.0~16.0	100	42	41	50	GERC25/1.0	M18	1	3.9	4.2	●
BT50-SDC16P-160	2.0~16.0	160	42	41	50	GERC25/1.0	M18	1	4.3	4.7	●
BT50-SDC20P-70	2.0~20.0	70	50	-	60	GERC32/1.0	M22	2	1.7	2.0	●
BT50-SDC20P-100	2.0~20.0	100	50	49	60	GERC32/1.0	M22	1	4.0	4.3	●
BT50-SDC20P-130	2.0~20.0	130	50	49	60	GERC32/1.0	M22	1	4.3	4.7	●
BT50-SDC20P-160	2.0~20.0	160	50	49	60	GERC32/1.0	M22	1	4.7	5.1	●
BT50-SDC20P-180	2.0~20.0	180	50	49	60	GERC32/1.0	M22	1	5.0	5.4	●
BT50-SDC26P-160	4.0~26.0	160	63	62	71	GERC40/1.0	M28	1	5.5	5.9	●

(Unit : mm)

1:1 CHAT



HSK-SDC/P

Precision Collet Chuck for Multi Purpose Machining

DIN
69893-1

Shank

Ø26

Max Dia

C

Coolant System

ER

ER Collet

Milling

Drilling

Tapping

Chamfering

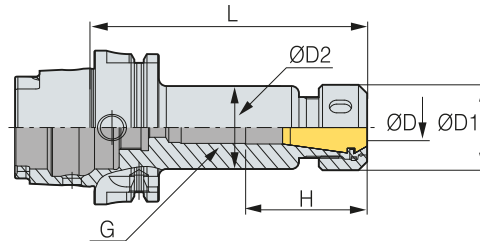

● : Stock

H : Depth of tool insertion

C Internal coolant system is optional

※ Using oil hole types requires the standard dimension

• For more information on product features, see **80P**• For more information on the related parts, see **86P**• For more information on the applicable collet, see **94P**

	Designation	ØD	L	ØD1	ØD2	H	G	Collet/Step	kg	Package Weight (kg)	Stock
HSK63A	HSK63A-SDC7P-100	1.0-7.0	100	18	17	33	M7	GERC11/0.5	0.9	1.0	
	HSK63A-SDC7P-120	1.0-7.0	120	18	17	34	M8	GERC11/0.5	0.9	1.0	
	HSK63A-SDC10P-100	1.0-10.0	100	32	31	44.5	M10	GERC16/1.0	1.0	1.1	●
	HSK63A-SDC10P-120	1.0-10.0	120	32	31	44.5	M10	GERC16/1.0	1.0	1.1	
	HSK63A-SDC13P-100	1.0-13.0	100	35	34	49	M7	GERC20/1.0	1.1	1.2	●
	HSK63A-SDC13P-120	1.0-13.0	120	35	34	49	M7	GERC20/1.0	1.2	1.4	
	HSK63A-SDC13P-150	1.0-13.0	150	35	34	49	M7	GERC20/1.0	1.2	1.4	
	HSK63A-SDC16P-100	2.0-16.0	100	42	41	50	M7	GERC25/1.0	1.2	1.4	●
	HSK63A-SDC20P-110	2.0-20.0	110	50	49	60	M7	GERC32/1.0	1.5	1.7	●
	HSK63A-SDC26P-130	4.0-26.0	130	63	62	71	M10	GERC40/1.0	1.6	1.8	
HSK100A	HSK100A-SDC7P-100	1.0-7.0	100	18	17	33	M7	GERC11/0.5	2.0	2.2	
	HSK100A-SDC10P-100	1.0-10.0	100	32	31	44.5	M10	GERC16/1.0	2.2	2.4	
	HSK100A-SDC13P-100	1.0-13.0	100	35	34	49	M7	GERC20/1.0	2.4	2.6	
	HSK100A-SDC16P-110	2.0-16.0	100	42	41	50	M13	GERC25/1.0	2.6	2.9	●
	HSK100A-SDC20P-120	2.0-20.0	120	50	49	60	M10	GERC32/1.0	2.9	3.3	●
	HSK100A-SDC26P-130	4.0-26.0	130	63	62	71	M28	GERC40/1.0	3.8	4.0	

(Unit : mm)

Accessories

SPARE PART	Type	Accessories	
		Coolant Tube for HSK	Wrench
	Images		
	Designation		
	HSK63A	HSK63A-CNS	HSK63-WRENCH(C)
	HSK100A	HSK100A-CNS	HSK100-WRENCH(C)

1:1 CHAT



SK-SDC/P

Precision Collet Chuck for Multi Purpose Machining

DIN69871
-1A/B

Shank

Ø20

Max Dia

C

Coolant System



ER Collet



Milling



Drilling



Tapping



Chamfering

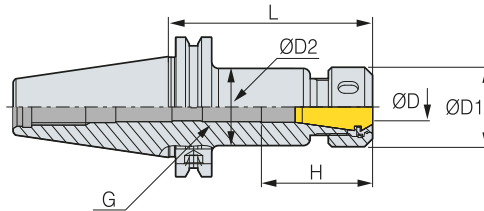

- : Stock

- H : Depth of tool insertion

- ☐ Internal coolant system is optional

※ Using oil hole types requires the standard dimension

- For more information on product features, see **80P**

- For more information on the related parts, see **86P**

- For more information on the applicable collet, see **94P**

Designation	ØD	L	ØD1	ØD2	H	Collet/Step	G	kg	Package Weight (kg)	Stock
SK40-SDC10P-90	1.0~10.0	90	32	31	44.5	GERC16/1.0	M10	1.1	1.2	●
SK40-SDC13P-90	1.0~13.0	90	35	34	49	GERC20/1.0	M13	1.2	1.3	●
SK40-SDC13P-120	1.0~13.0	120	35	34	49	GERC20/1.0	M13	1.3	1.5	
SK40-SDC16P-90	2.0~16.0	90	42	41	50	GERC25/1.0	M18	1.4	1.5	●
SK40-SDC20P-90	2.0~20.0	90	50	49	60	GERC32/1.0	M13	1.5	1.6	●

(Unit : mm)

1:1 CHAT



SDC/P SPARE PART

ER Collet Chuck Related Parts

Type	Main Components		Accessories	
	Sleeve Bearing Nut	Adjust Screw	Spanner	Collet
Images				
Designation				
SDC7P	RN11	BN0716F	20-22	GERC/ER 11-ØD
SDC10P	RN16	BN1025F	32-35	GERC/ER 16-ØD
SDC13P	RN20	BN1325F	35-38	GERC/ER 20-ØD
SDC16P	RN25	BN1830F	42-46	GERC/ER 25-ØD
SDC20P	RN32	BN2230F	48-52	GERC/ER 32-ØD
SDC26P	RN40	BN2838F	62-65	GERC/ER 40-ØD

※ BT30-SDC13P-50/ HSK63A-SDC13P-100 is applied with BN0716F screw.

1:1 CHAT



S-SDC

Straight Shank Collet Chuck



Ø20

Max Dia

C

Coolant System

ER

ER Collet

Milling

Drilling

Tapping

Chamfering

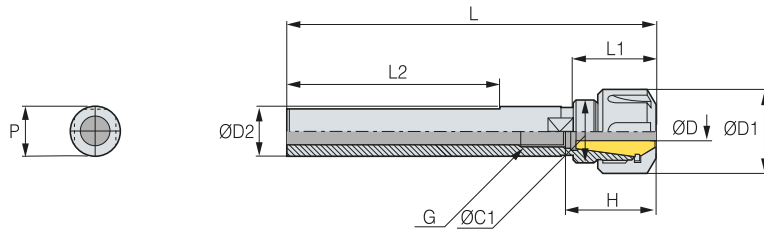

● : Stock

C Internal coolant system is optional

※ For milling (M)/ for turning (T) – e.g.) S16–SDC7–120M (for milling) / S16–SDC7–120T (for turning)

※ It can be used in combination with a milling chuck

• For more information on the applicable collet, see **94P**

	Designation	ØD	L	ØD1	ØD2	P	ØC1	L1	L2	H	Collet/Step	G	kg	Package Weight (kg)	Stock
S16	S16-SDC7-120M	1.0~7.0	120	19	16	-	16	-	-	33	GERC11/0.5	M7	0.1	0.2	●
	S16-SDC7-120T	1.0~7.0	120	19	16	15	16	-	73	33	GERC11/0.5	M7	0.1	0.2	●
	S16-SDC10-150T	1.0~10.0	150	28	16	15	22	46.5	83	34.5	GERC16/1.0	M10	0.2	0.3	●
S20	S20-SDC10-150M	1.0~10.0	150	28	20	-	22	26.5	-	34.5	GERC16/1.0	M10	0.3	0.4	●
	S20-SDC10-150T	1.0~10.0	150	28	20	19	22	26.5	83	34.5	GERC16/1.0	M10	0.3	0.4	●
	S20-SDC13-150M	1.0~13.0	150	35	20	-	25	50	-	49	GERC20/1.0	M13	0.3	0.4	●
	S20-SDC13-150T	1.0~13.0	150	35	20	19	25	50	83	49	GERC20/1.0	M13	0.3	0.4	●
S25	S25-SDC10-150M	1.0~10.0	150	28	25	-	22	-	-	34.5	GERC16/1.0	M10	0.4	0.5	●
	S25-SDC10-150T	1.0~10.0	150	28	25	24	22	-	83	34.5	GERC16/1.0	M10	0.4	0.5	●
	S25-SDC13-150M	1.0~13.0	150	35	25	-	25	-	-	49	GERC20/1.0	M13	0.4	0.5	●
	S25-SDC13-150T	1.0~13.0	150	35	25	24	25	-	83	49	GERC20/1.0	M13	0.4	0.5	●
S32	S32-SDC13-150M	1.0~13.0	150	35	32	-	25	-	-	49	GERC20/1.0	M13	0.7	0.8	●
	S32-SDC13-150T	1.0~13.0	150	35	32	31	25	-	83	49	GERC20/1.0	M13	0.7	0.8	●
	S32-SDC20-165M	2.0~20.0	165	50	32	-	40	-	-	60	GERC32/1.0	M22	0.9	1.0	●
	S32-SDC20-165T	2.0~20.0	165	50	32	31	40	-	83	60	GERC32/1.0	M22	0.9	1.0	●

(Unit : mm)

SPARE PART	Type	Main Components		Accessories		
		Nut		Spanner		GERC/ER
	Images					
	Designation	R11	R16	S-17	S-25	GERC11/ER11-ØD
	S-SDC7	R11	R16	S-17	S-25	GERC11/ER11-ØD
	S-SDC10	R16	R16	S-25	S-25	GERC16/ER16-ØD
	S-SDC13	R16	RU20	S-25	35-38	GERC20/ER20-ØD
	S-SDC20	R16	RU32	S-25	48-52	GERC32/ER32-ØD

※ BT30-SDC13P-50/ HSK63A-SDC13P-100 is applied with BN0716F screw.

1:1 CHAT



S-SDC/S

Straight Shank Collet Chuck Slim Type



Ø16

Max Dia

C

Coolant System



ER Collet



Milling



Drilling



Tapping



Chamfering

Fig.1

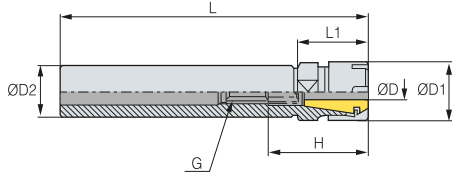
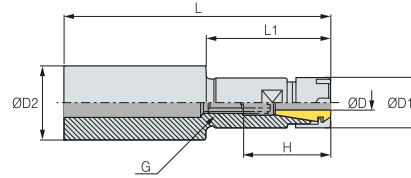

Fig.2



- : Stock
- H : Depth of tool insertion
- Internal coolant system is optional

• For more information on the applicable collet, see **94P**

	Designation	ØD	L	ØD1	ØD2	L1	H	Collet/Step	G	kg	Package Weight (kg)	Stock
S16	S16-SDC7S-100M	1.0~7.0	100	16	16	21	33	GERC11/0.5	M7	0.1	0.2	●
	S16-SDC7S-150M	1.0~7.0	150	16	16	21	33	GERC11/0.5	M7	0.1	0.2	●
	S16-SDC10S-100M	1.0~10.0	100	22	16	50	4.5	GERC16/1.0	M10	0.1	0.2	●
	S16-SDC10S-150M	1.0~10.0	150	22	16	50	4.5	GERC16/1.0	M10	0.1	0.2	●
S20	S20-SDC7S-100M	1.0~7.0	100	16	20	30	35	GERC11/0.5	M7	0.1	0.2	●
	S20-SDC7S-150M	1.0~7.0	150	16	20	80	35	GERC11/0.5	M7	0.2	0.3	●
	S20-SDC10S-100M	1.0~10.0	100	22	20	50	4.5	GERC16/1.0	M10	0.1	0.2	●
	S20-SDC10S-150M	1.0~10.0	150	22	20	50	4.5	GERC16/1.0	M10	0.2	0.3	●
	S20-SDC10S-200M	1.0~10.0	200	22	20	50	4.5	GERC16/1.0	M10	0.3	0.4	●
	S20-SDC13S-100M	1.0~13.0	100	28	20	50	49	GERC20/1.0	M13	0.1	0.2	●
S25	S25-SDC13S-150M	1.0~13.0	150	28	20	50	49	GERC20/1.0	M13	0.2	0.3	●
	S25-SDC7S-100M	1.0~7.0	100	16	25	30	33	GERC11/0.5	M7	0.2	0.3	●
	S25-SDC7S-150M	1.0~7.0	150	16	25	80	33	GERC11/0.5	M7	0.2	0.3	●
	S25-SDC10S-100M	1.0~10.0	100	22	25	30	4.5	GERC16/1.0	M10	0.2	0.3	●
	S25-SDC10S-150M	1.0~10.0	150	22	25	80	4.5	GERC16/1.0	M10	0.3	0.4	●
	S25-SDC13S-100M	1.0~13.0	100	28	25	50	49	GERC20/1.0	M13	0.2	0.3	●
	S25-SDC13S-150M	1.0~13.0	150	28	25	50	49	GERC20/1.0	M13	0.4	0.5	●
	S25-SDC16S-100M	2.0~16.0	100	35	25	50	50	GERC25/1.0	M18	0.3	0.4	●
S32	S25-SDC16S-150M	2.0~16.0	150	35	25	50	50	GERC25/1.0	M18	0.4	0.5	●
	S25-SDC16S-200M	2.0~16.0	200	35	25	50	50	GERC25/1.0	M18	0.6	0.7	●
	S32-SDC16S-120M	2.0~16.0	120	35	32	50	50	GERC25/1.0	M18	0.5	0.6	●
	S32-SDC16S-150M	2.0~16.0	150	35	32	50	50	GERC25/1.0	M18	0.6	0.7	●

(Unit : mm)

SPARE PART	Type	Main Components	Accessories	
		Nut	Spanner	GERC/ER
	Images			
	Designation			
	S-SDC7S	R11M	M11M	GERC11/ER11-ØD
	S-SDC10S	R16M	M16M	GERC16/ER16-ØD
	S-SDC13S	R20M	M20M	GERC20/ER20-ØD
	S-SDC16S	R25M	M25M	GERC25/ER25-ØD

1:1 CHAT



SDC/PL

Precision Collet Chuck (Length Adjustment Type)



- Coolant System
- Max Dia
- ER Collet
- Milling
- Drilling
- Chamfering
- Tapping



Features

- Precise tool length adjustment
- Improved production efficiency by reducing tool setup time

NAMING

BT40	SDC	16	P	L	130
Spindle	Collet Chuck	Tool Dia.	Precision	Length Adjustment	Length

What is SDC/PL?

Reduced tool setting time by designing the length to be adjustable from the outside.

Part Name

- Internal coolant system is basic

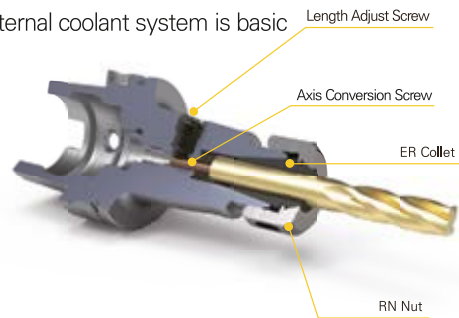

How to Adjust Length

- Rotate the adjustment screw to adjust the tool length

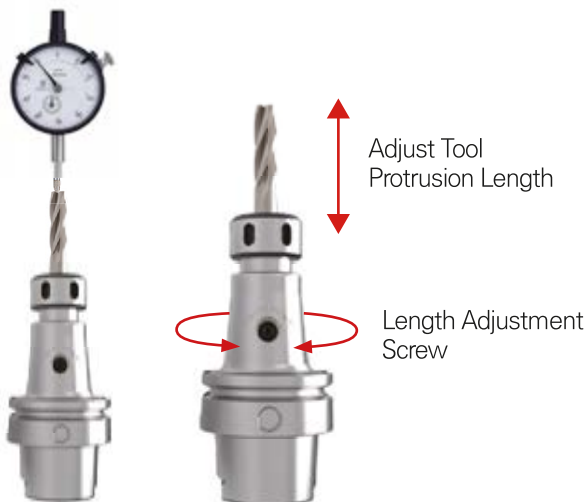

Test

Cutting Conditions	Material	S45C
	Cutting Speed (m/min)	60
	Feed (mm/t)	0.05
	Depth of Cut (mm)	40
	Machining Distance (mm)	20
		External Coolant Supply

Depth of Cut(mm)	SDC/PL	General Collet Chuck
Ae : 0.8mm		
	<ul style="list-style-type: none"> • Ra:1.058μm • Rz:6.354μm • Rt:8.307μm 	<ul style="list-style-type: none"> • Ra:1.110μm • Rz:6.078μm • Rt:8.895μm • Noise • Machining Impossible

1:1 CHAT



BT-SDC/PL

Precision Collet Chuck (Length Adjustment Type)



- MAS
403-BT
- C
- Ø26
- ER Collet
- Milling
- Drilling
- Chamfering
- Tapping

Fig.1

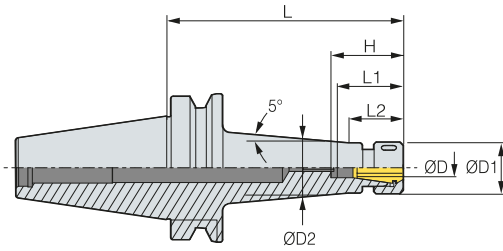
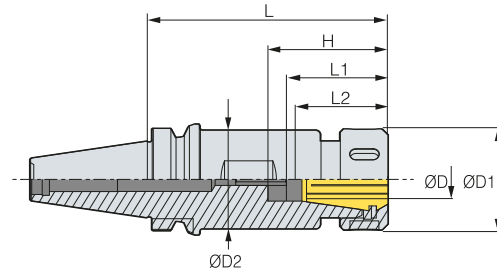

Fig.2



● : Stock

C Internal coolant system is optional

※L1 : Length adjustable range

※L2 : 5° Taper start point

• For more information on product features, see **89P**

For more information on the related parts, see **92P**

• For more information on the applicable collet, see **94P**

	Designation	ØD	L	ØD1	ØD2	H	*L1	*L2	Collet/Step	Fig.	Stock
BT30	BT30-SDC13PL-100	1.0~13.0	100	35	34	49	39~49	37	GERC20/1.0	1	●
	BT30-SDC16PL-100	2.0~16.0	100	42	41	50	40~50	45	GERC25/1.0	2	●
	BT30-SDC20PL-120	2.0~20.0	120	50	49	60	50~60	55	GERC32/1.0	2	●
BT40	BT40-SDC13PL-90	1.0~13.0	90	35	34	49	39~49	37	GERC20/1.0	1	●
	BT40-SDC13PL-130	1.0~13.0	130	35	34	49	39~49	37	GERC20/1.0	1	●
	BT40-SDC13PL-150	1.0~13.0	150	35	34	49	39~49	37	GERC20/1.0	1	●
	BT40-SDC16PL-90	2.0~16.0	90	42	41	50	40~50	37	GERC25/1.0	1	●
	BT40-SDC16PL-130	2.0~16.0	130	42	41	50	40~50	57	GERC25/1.0	1	●
	BT40-SDC20PL-130	2.0~20.0	130	50	49	60	50~60	58	GERC32/1.0	1	●
	BT40-SDC20PL-150	2.0~20.0	150	50	49	60	50~60	68	GERC32/1.0	1	●
	BT50	BT50-SDC13PL-100	1.0~13.0	100	35	34	49	39~49	37	GERC20/1.0	1
BT50-SDC13PL-130		1.0~13.0	130	35	34	49	39~49	37	GERC20/1.0	1	●
BT50-SDC13PL-160		1.0~13.0	160	35	34	49	39~49	37	GERC20/1.0	1	●
BT50-SDC13PL-180		1.0~13.0	180	35	34	49	39~49	37	GERC20/1.0	1	●
BT50-SDC16PL-100		2.0~16.0	100	42	41	50	40~50	37	GERC25/1.0	1	●
BT50-SDC16PL-160		2.0~16.0	160	42	41	50	40~50	67	GERC25/1.0	1	●
BT50-SDC20PL-130		2.0~20.0	130	50	49	60	50~60	52	GERC32/1.0	1	●
BT50-SDC20PL-160		2.0~20.0	160	50	49	60	50~60	67	GERC32/1.0	1	●
BT50-SDC20PL-180		2.0~20.0	180	50	49	60	50~60	77	GERC32/1.0	1	●
BT50-SDC26PL-160		4.0~26.0	160	63	62	71	61~71	68	GERC40/1.0	1	●

(Unit : mm)

1:1 CHAT



HSK-SDC/PL

Precision Collet Chuck (Length Adjustment Type)

DIN
69893-1

Shank

C

Coolant System

Ø20

Max Dia

ER

ER Collet

Milling

Drilling

Chamfering

Tapping

Fig.1

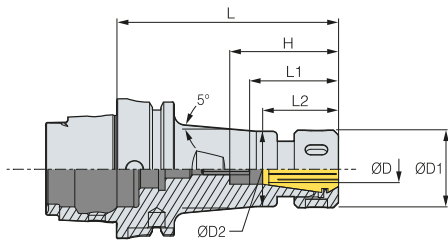
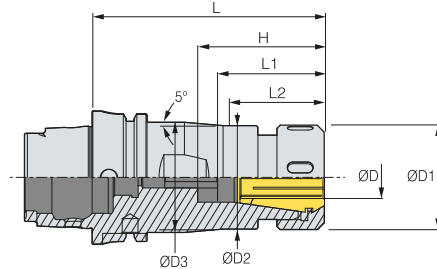

Fig.2



● : Stock

C Internal coolant system is optional

※L1 : Length adjustable range

※L2 : 5° Taper start point

• For more information on product features, see **89P**For more information on the related parts, see **92P**• For more information on the applicable collet, see **94P**

	Designation	ØD	L	ØD1	ØD2	ØD3	H	*L1	*L2	Collet/Step	Fig.	Stock
HSK63A	HSK63A-SDC13PL-100	1.0~13.0	100	35	34	-	49	39~49	37	GERC20/1.0	1	●
	HSK63A-SDC16PL-100	2.0~16.0	100	42	41	-	50	40~50	43	GERC25/1.0	1	●
	HSK63A-SDC20PL-110	2.0~20.0	110	50	49	52	60	50~60	48	GERC32/1.0	2	●
HSK100A	HSK100A-SDC16PL-110	2.0~16.0	110	42	41	-	50	40~50	46	GERC25/1.0	1	●
	HSK100A-SDC20PL-120	2.0~20.0	120	50	49	-	60	50~60	52	GERC32/1.0	1	●

(Unit : mm)

Accessories

SPARE PART	Type	Accessories	
		Coolant Tube for HSK	Wrench
	Images		
	Designation		
	HSK63A	HSK63A-CNS	HSK63-WRENCH(C)
	HSK100A	HSK100A-CNS	HSK100-WRENCH(C)

1:1 CHAT 





SDC/PL SPARE PART

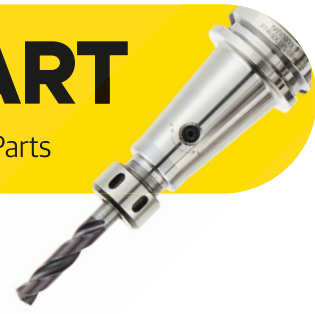

Precision Collet Chuck (Length Adjustment Type) Related Parts

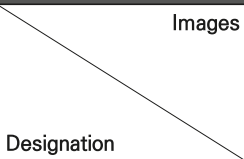

Main Components

SPARE PART	Chuck	Main Components
	Images	Sleeve Bearing Nut
		
	Designation	
	SDC13PL	RN20
	SDC16PL	RN25
	SDC20PL	RN32
	SDC26PL	RN40

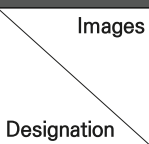
Accessories

SPARE PART	Chuck	Accessories	
	Images	Spanner	Collet
			
	Designation		
	SDC13PL	35-38	GERC/ER 20-ØD
	SDC16PL	42-46	GERC/ER 25-ØD
	SDC20PL	48-52	GERC/ER 32-ØD
	SDC26PL	62-65	GERC/ER 40-ØD

SPARE PART	For Each Shank	Accessories	
	Images	Internal Coolant	Wrench
			
	Designation		
	HSK63A	HSK63A-CNS	HSK63-WRENCH(C)
	HSK100A	HSK100A-CNS	HSK100-WRENCH(C)

1:1 CHAT



BT-TXER

ER Collet Chuck

MAS
403-BT

Shank

C

Coolant System

Ø20

Max Dia



Milling



Drilling



Chamfering



Tapping

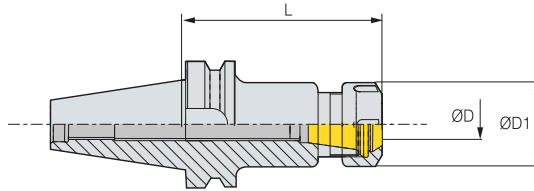

● : Stock

C Internal coolant system is optional

	Designation	ØD	L	ØD1	Collet	Used Nut Fig.	Package Weight (kg)	Stock		
BT30	BT30-TXER16-70	1.0-10.0	70	28	ER16	1	0.7	●		
	BT30-TXER16-100	1.0-10.0	100	28	ER16		0.7	●		
	BT30-TXER20-70	1.0-13.0	70	34	ER20		0.7	●		
	BT30-TXER20-100	1.0-13.0	100	34	ER20		0.9	●		
	BT30-TXER25-70	2.0-16.0	70	42	ER25	2	0.8	●		
	BT30-TXER25-100	2.0-16.0	100	42	ER25		0.9	●		
	BT30-TXER32-70	2.0-20.0	70	50	ER32		0.8	●		
	BT30-TXER32-100	2.0-20.0	100	50	ER32		1.0	●		
BT40	BT40-TXER16-70	1.0-10.0	70	28	ER16	1	1.2	●		
	BT40-TXER16-100	1.0-10.0	100	28	ER16		1.3	●		
	BT40-TXER16-160	1.0-10.0	160	28	ER16		1.5	●		
	BT40-TXER20-70	1.0-13.0	70	34	ER20		1.2	●		
	BT40-TXER20-100	1.0-13.0	100	34	ER20		1.4	●		
	BT40-TXER20-160	1.0-13.0	160	34	ER20		1.8	●		
	BT40-TXER25-70	2.0-16.0	70	42	ER25	2	1.3	●		
	BT40-TXER25-100	2.0-16.0	100	42	ER25		1.4	●		
	BT40-TXER25-130	2.0-16.0	130	42	ER25		1.6	●		
	BT40-TXER25-160	2.0-16.0	160	42	ER25		2.0	●		
	BT40-TXER32-70	2.0-20.0	70	50	ER32		1.4	●		
	BT40-TXER32-100	2.0-20.0	100	50	ER32		1.7	●		
	BT40-TXER32-130	2.0-20.0	130	50	ER32		2.0	●		
	BT40-TXER32-160	2.0-20.0	160	50	ER32		2.5	●		
	BT50	BT50-TXER16-100	1.0-10.0	100	28		ER16	1	3.8	●
		BT50-TXER16-160	1.0-10.0	160	28		ER16		4.1	●
BT50-TXER20-100		1.0-13.0	100	34	ER20	3.9	●			
BT50-TXER20-160		1.0-13.0	160	34	ER20	4.5	●			
BT50-TXER25-100		2.0-16.0	100	42	ER25	2	3.9	●		
BT50-TXER25-130		2.0-16.0	100	42	ER25		4.2	●		
BT50-TXER25-160		2.0-16.0	160	42	ER25		4.6	●		
BT50-TXER32-100		2.0-20.0	100	50	ER32		4.1	●		
BT50-TXER32-130		2.0-20.0	130	50	ER32		4.5	●		
BT50-TXER32-160		2.0-20.0	160	50	ER32		4.9	●		

(Unit : mm)

ER	Designation	ØC	L	G	Fig.
	ER16-DIN6499	28	17.5	M22X1.5	1
	ER20-DIN6499	34	19	M25X1.5	1
	ER25-DIN6499	42	20	M32X1.5	2
	ER32-DIN6499	50	22.5	M40X1.5	2

(Unit : mm)

Fig.1

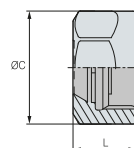
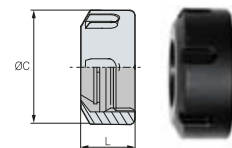

Fig.2



1:1 CHAT



GERC

GERC Collet



General
5 μ m

Run-out

Precision
2 μ m

Run-out



Waterproof



ER Collet



Features

- Top-tier ER collets with high-precision and anti-corrosion coating
- FAHRION's own small incision relative to other companies displays the equivalent fastening force
- All corners are honed, and the damage to nuts and collet chucks is minimized

NAMING

GERC	16	4	HP
GERC Collet	Collet Size	Tool Dia.	HP : Precision NON : General

Special Coating Technology

The characteristics of the conventional unprotected collet unlike GERC collets are as follows:

The conventional uncoated collet is affected by corrosion in a short time due to various causes such as humidity, cutting oil, detergent, salt, and gas. This affects not only the collet but also the entire machining process.



A rusty collet shortens tool service life and greatly lowers precision. To avoid this situation, surface coating is performed to micro range to effectively protect a collet and maintain its precision for a long time by preventing it from corroding in the long term.

Two Collets Used for 4 Months

The left one is an uncoated collet, and the right one is a GERC-used collet.

GERC-HP(Precision Type)

Precision collets are more expensive than general collets, but its high-precision allows better workpieces to be generated, which leads to a higher cost efficiency in the long run.

Accuracy (L/D=3)

- General Type = 5 μ m
- Precision Type 2 μ m

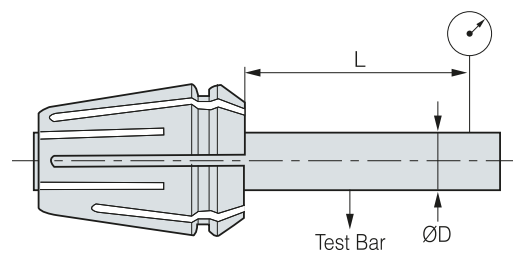
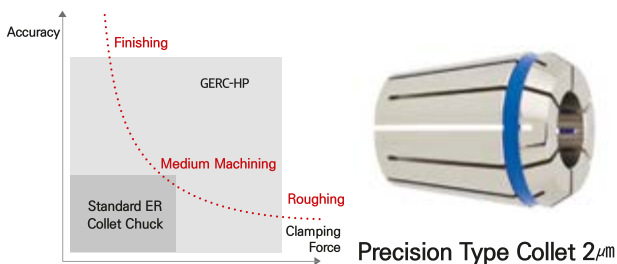

1:1 CHAT



GERC COLLET

GERC Collet (General Type)

General
5 μ m

Run-out



ER Collet

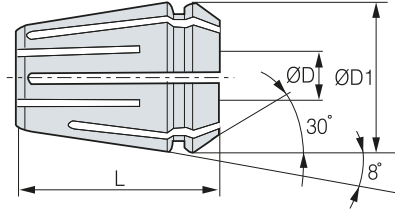

● : Stock

	Designation	ER Size	ØD	L	ØD1	Accuracy	Stock
GERC11	GERC11-1.0	11	1.0	18.0	11.5	5 μ m	●
	GERC11-1.5	11	1.5	18.0	11.5	5 μ m	●
	GERC11-2.0	11	2.0	18.0	11.5	5 μ m	●
	GERC11-2.5	11	2.5	18.0	11.5	5 μ m	●
	GERC11-3.0	11	3.0	18.0	11.5	5 μ m	●
	GERC11-3.5	11	3.5	18.0	11.5	5 μ m	●
	GERC11-4.0	11	4.0	18.0	11.5	5 μ m	●
	GERC11-4.5	11	4.5	18.0	11.5	5 μ m	●
	GERC11-5.0	11	5.0	18.0	11.5	5 μ m	●
	GERC11-5.5	11	5.5	18.0	11.5	5 μ m	●
	GERC11-6.0	11	6.0	18.0	11.5	5 μ m	●
	GERC11-6.5	11	6.5	18.0	11.5	5 μ m	●
	GERC11-7.0	11	7.0	18.0	11.5	5 μ m	●
GERC16	GERC16-1.0	16	1.0	27.5	17.0	5 μ m	●
	GERC16-2.0	16	2.0	27.5	17.0	5 μ m	●
	GERC16-3.0	16	3.0	27.5	17.0	5 μ m	●
	GERC16-4.0	16	4.0	27.5	17.0	5 μ m	●
	GERC16-4.5	16	4.5	27.5	17.0	5 μ m	●
	GERC16-5.0	16	5.0	27.5	17.0	5 μ m	●
	GERC16-6.0	16	6.0	27.5	17.0	5 μ m	●
	GERC16-7.0	16	7.0	27.5	17.0	5 μ m	●
	GERC16-8.0	16	8.0	27.5	17.0	5 μ m	●
	GERC16-9.0	16	9.0	27.5	17.0	5 μ m	●
GERC16-10.0	16	10.0	27.5	17.0	5 μ m	●	
GERC20	GERC20-1.0	20	1.0	31.5	21.0	5 μ m	●
	GERC20-2.0	20	2.0	31.5	21.0	5 μ m	●
	GERC20-3.0	20	3.0	31.5	21.0	5 μ m	●
	GERC20-4.0	20	4.0	31.5	21.0	5 μ m	●
	GERC20-5.0	20	5.0	31.5	21.0	5 μ m	●
	GERC20-6.0	20	6.0	31.5	21.0	5 μ m	●
	GERC20-7.0	20	7.0	31.5	21.0	5 μ m	●
	GERC20-8.0	20	8.0	31.5	21.0	5 μ m	●
	GERC20-9.0	20	9.0	31.5	21.0	5 μ m	●
	GERC20-10.0	20	10.0	31.5	21.0	5 μ m	●
	GERC20-11.0	20	11.0	31.5	21.0	5 μ m	●
	GERC20-12.0	20	12.0	31.5	21.0	5 μ m	●
	GERC20-13.0	20	13.0	31.5	21.0	5 μ m	●
GERC25	GERC25-2.0	25	2.0	34.0	26.0	5 μ m	●
	GERC25-3.0	25	3.0	34.0	26.0	5 μ m	●
	GERC25-4.0	25	4.0	34.0	26.0	5 μ m	●
	GERC25-5.0	25	5.0	34.0	26.0	5 μ m	●
	GERC25-6.0	25	6.0	34.0	26.0	5 μ m	●
	GERC25-7.0	25	7.0	34.0	26.0	5 μ m	●
	GERC25-8.0	25	8.0	34.0	26.0	5 μ m	●
	GERC25-9.0	25	9.0	34.0	26.0	5 μ m	●
	GERC25-10.0	25	10.0	34.0	26.0	5 μ m	●
	GERC25-11.0	25	11.0	34.0	26.0	5 μ m	●
	GERC25-12.0	25	12.0	34.0	26.0	5 μ m	●
	GERC25-13.0	25	13.0	34.0	26.0	5 μ m	●
	GERC25-14.0	25	14.0	34.0	26.0	5 μ m	●
GERC25-15.0	25	15.0	34.0	26.0	5 μ m	●	
GERC25-16.0	25	16.0	34.0	26.0	5 μ m	●	
GERC32	GERC32-2.0	32	2.0	40.0	33.0	5 μ m	●
	GERC32-3.0	32	3.0	40.0	33.0	5 μ m	●
	GERC32-4.0	32	4.0	40.0	33.0	5 μ m	●
	GERC32-5.0	32	5.0	40.0	33.0	5 μ m	●
	GERC32-6.0	32	6.0	40.0	33.0	5 μ m	●
	GERC32-7.0	32	7.0	40.0	33.0	5 μ m	●
	GERC32-8.0	32	8.0	40.0	33.0	5 μ m	●
	GERC32-9.0	32	9.0	40.0	33.0	5 μ m	●
	GERC32-10.0	32	10.0	40.0	33.0	5 μ m	●
	GERC32-11.0	32	11.0	40.0	33.0	5 μ m	●
	GERC32-12.0	32	12.0	40.0	33.0	5 μ m	●
	GERC32-13.0	32	13.0	40.0	33.0	5 μ m	●
	GERC32-14.0	32	14.0	40.0	33.0	5 μ m	●
GERC32-15.0	32	15.0	40.0	33.0	5 μ m	●	
GERC32-16.0	32	16.0	40.0	33.0	5 μ m	●	
GERC32-17.0	32	17.0	40.0	33.0	5 μ m	●	
GERC32-18.0	32	18.0	40.0	33.0	5 μ m	●	
GERC32-19.0	32	19.0	40.0	33.0	5 μ m	●	
GERC32-20.0	32	20.0	40.0	33.0	5 μ m	●	
GERC40	GERC40-16.0	40	16.0	46.0	41.0	5 μ m	●
	GERC40-20.0	40	20.0	46.0	41.0	5 μ m	●
	GERC40-25.0	40	25.0	46.0	41.0	5 μ m	●

Order Example • General Type – Order as GERC16-6.0 • Precision Type – Order as GERC16-6.0HP
 • General Sealed Type – Order as GERC16-6.0C

(Unit : mm)

※ Please contact us about precision sealed type.

※ Please contact us about GERC40 precision type and other diameter.

Chuck

Arbor/Modular

Boring Tool

Angular Head

cBN/PCD

Device&Accessory

Standard

1:1 CHAT



GERC COLLET

GERC Collet (Precision Type)



Precision
2 μ m

Run-out



ER Collet

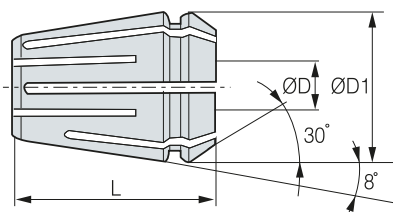

● : Stock

	Designation	ER Size	ØD	L	ØD1	Accuracy	Stock	
GERC11	GERC11-3.0HP	11.0	3.0	18.0	11.5	2 μ m	●	
	GERC11-4.0HP	11.0	4.0	18.0	11.5	2 μ m	●	
	GERC11-5.0HP	11.0	5.0	18.0	11.5	2 μ m	●	
	GERC11-6.0HP	11.0	6.0	18.0	11.5	2 μ m	●	
GERC16	GERC16-3.0HP	16.0	3.0	27.5	17.0	2 μ m	●	
	GERC16-4.0HP	16.0	4.0	27.5	17.0	2 μ m	●	
	GERC16-5.0HP	16.0	5.0	27.5	17.0	2 μ m	●	
	GERC16-6.0HP	16.0	6.0	27.5	17.0	2 μ m	●	
	GERC16-7.0HP	16.0	7.0	27.5	17.0	2 μ m	●	
	GERC16-8.0HP	16.0	8.0	27.5	17.0	2 μ m	●	
	GERC16-9.0HP	16.0	9.0	27.5	17.0	2 μ m	●	
	GERC16-10.0HP	16.0	10.0	27.5	17.0	2 μ m	●	
	GERC20	GERC20-3.0HP	20.0	3.0	31.5	21.0	2 μ m	●
		GERC20-4.0HP	20.0	4.0	31.5	21.0	2 μ m	●
GERC20-5.0HP		20.0	5.0	31.5	21.0	2 μ m	●	
GERC20-6.0HP		20.0	6.0	31.5	21.0	2 μ m	●	
GERC20-8.0HP		20.0	8.0	31.5	21.0	2 μ m	●	
GERC20-9.0HP		20.0	9.0	31.5	21.0	2 μ m	●	
GERC20-10.0HP		20.0	10.0	31.5	21.0	2 μ m	●	
GERC20-11.0HP		20.0	11.0	31.5	21.0	2 μ m	●	
GERC20-12.0HP		20.0	12.0	31.5	21.0	2 μ m	●	
GERC20-13.0HP		20.0	13.0	31.5	21.0	2 μ m	●	
GERC25	GERC25-6.0HP	25.0	6.0	34.0	26.0	2 μ m	●	
	GERC25-10.0HP	25.0	10.0	34.0	26.0	2 μ m	●	
	GERC25-12.0HP	25.0	12.0	34.0	26.0	2 μ m	●	
	GERC25-14.0HP	25.0	14.0	34.0	26.0	2 μ m	●	
	GERC25-16.0HP	25.0	16.0	34.0	26.0	2 μ m	●	
GERC32	GERC32-6.0HP	32.0	6.0	40.0	33.0	2 μ m	●	
	GERC32-10.0HP	32.0	10.0	40.0	33.0	2 μ m	●	
	GERC32-12.0HP	32.0	12.0	40.0	33.0	2 μ m	●	
	GERC32-16.0HP	32.0	16.0	40.0	33.0	2 μ m	●	
	GERC32-18.0HP	32.0	18.0	40.0	33.0	2 μ m	●	
	GERC32-20.0HP	32.0	20.0	40.0	33.0	2 μ m	●	

Order Example • General Type – Order as GERC16-6.0 • Precision Type – Order as GERC16-6.0HP
• General Sealed Type – Order as GERC16-6.0C

(Unit : mm)

※ Please contact us for the waterproof general type.

※ Please contact us about GERC40 precision type and other diameter.

1:1 CHAT



GERC COLLET

GERC Collet (General Sealed Type)

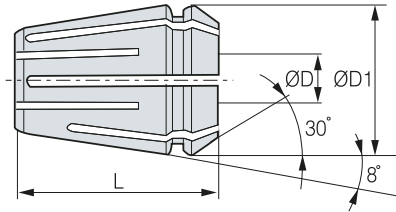

● : Stock

	Designation	ER Size	ØD	L	ØD1	Accuracy	Stock
GERC16	GERC16-5.0C	16	5.0	27.5	17.0	5µm	●
	GERC16-6.0C	16	6.0	27.5	17.0	5µm	●
	GERC16-8.0C	16	8.0	27.5	17.0	5µm	●
	GERC16-10.0C	16	10.0	27.5	17.0	5µm	●
GERC20	GERC20-6.0C	20	6.0	31.5	21.0	5µm	●
	GERC20-8.0C	20	8.0	31.5	21.0	5µm	●
	GERC20-10.0C	20	10.0	31.5	21.0	5µm	●
	GERC20-12.0C	20	12.0	31.5	21.0	5µm	●
GERC25	GERC25-6.0C	25	6.0	34.0	26.0	5µm	●
	GERC25-8.0C	25	8.0	34.0	26.0	5µm	●
	GERC25-10.0C	25	10.0	34.0	26.0	5µm	●
	GERC25-12.0C	25	12.0	34.0	26.0	5µm	●
	GERC25-14.0C	25	14.0	34.0	26.0	5µm	●
	GERC25-16.0C	25	16.0	34.0	26.0	5µm	●
GERC32	GERC32-8.0C	32	8.0	40.0	33.0	5µm	●
	GERC32-9.0C	32	9.0	40.0	33.0	5µm	●
	GERC32-10.0C	32	10.0	40.0	33.0	5µm	●
	GERC32-11.0C	32	11.0	40.0	33.0	5µm	●
	GERC32-12.0C	32	12.0	40.0	33.0	5µm	●
	GERC32-13.0C	32	13.0	40.0	33.0	5µm	●
	GERC32-14.0C	32	14.0	40.0	33.0	5µm	●
	GERC32-15.0C	32	15.0	40.0	33.0	5µm	●
	GERC32-16.0C	32	16.0	40.0	33.0	5µm	●
	GERC32-18.0C	32	18.0	40.0	33.0	5µm	●
	GERC32-20.0C	32	20.0	40.0	33.0	5µm	●

Order example • General Type – Order as GERC16-6.0 • Precision Type – Order as ER16-6.0P (Unit : mm)

• General Sealed Type – Order as GERC16-6.0C

- ※ Please contact us for the waterproof general type.
- ※ Please contact us about GERC40 precision type and other diameter.

Chuck

Arbor/Modular

Boring Tool

Angular Head

cBN/PCD

Device&Accessory

Standard

1:1 CHAT



GERC COLLET SET

GERC Collet Set (General Type)



General
5 μ m
Run-out



● : Stock

GERC SET

Designation	\varnothing D	Clearance	Collet Quantity	Accuracy	kg	Package Weight(kg)	Stock
GERC11 (SET)	1.0-7.0	0.5	13pcs	5 μ m	0.1	0.3	●
GERC16 (SET)	1.0-10.0	1.0	10pcs	5 μ m	0.2	0.4	●
GERC20 (SET)	2.0-13.0	1.0	12pcs	5 μ m	0.5	0.8	●
GERC25 (SET)	2.0-16.0	1.0	15pcs	5 μ m	1.1	1.5	●
GERC32 (SET)	3.0-20.0	1.0	18pcs	5 μ m	2.6	3.1	●
GERC40 (SET)	4.0-26.0	1.0	23pcs	5 μ m	5.8	6.9	●

※ Collet components for each set are different for precision/sealed type. Please check before ordering. (Unit : mm)

1:1 CHAT



ER COLLET

ER Collet (General Type)

General
10_μm

Run-out



ER Collet

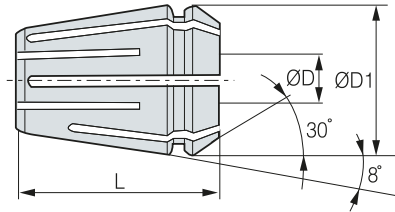

● : Stock

	Designation	ER Size	ØD	L	ØD1	Accuracy	Stock
ER11	ER11-1.0	11	1.0	18.0	11.5	10 _μ m	●
	ER11-1.5	11	1.5	18.0	11.5	10 _μ m	●
	ER11-2.0	11	2.0	18.0	11.5	10 _μ m	●
	ER11-2.5	11	2.5	18.0	11.5	10 _μ m	●
	ER11-3.0	11	3.0	18.0	11.5	10 _μ m	●
	ER11-3.5	11	3.5	18.0	11.5	10 _μ m	●
	ER11-4.0	11	4.0	18.0	11.5	10 _μ m	●
	ER11-4.5	11	4.5	18.0	11.5	10 _μ m	●
	ER11-5.0	11	5.0	18.0	11.5	10 _μ m	●
	ER11-5.5	11	5.5	18.0	11.5	10 _μ m	●
	ER11-6.0	11	6.0	18.0	11.5	10 _μ m	●
	ER11-6.5	11	6.5	18.0	11.5	10 _μ m	●
	ER11-7.0	11	7.0	18.0	11.5	10 _μ m	●
ER16	ER16-1.0	16	1.0	27.5	17.0	10 _μ m	●
	ER16-2.0	16	2.0	27.5	17.0	10 _μ m	●
	ER16-3.0	16	3.0	27.5	17.0	10 _μ m	●
	ER16-4.0	16	4.0	27.5	17.0	10 _μ m	●
	ER16-5.0	16	5.0	27.5	17.0	10 _μ m	●
	ER16-6.0	16	6.0	27.5	17.0	10 _μ m	●
	ER16-7.0	16	7.0	27.5	17.0	10 _μ m	●
	ER16-8.0	16	8.0	27.5	17.0	10 _μ m	●
	ER16-9.0	16	9.0	27.5	17.0	10 _μ m	●
	ER16-10.0	16	10.0	27.5	17.0	10 _μ m	●
ER20	ER20-1.0	20	1.0	31.5	21.0	10 _μ m	●
	ER20-2.0	20	2.0	31.5	21.0	10 _μ m	●
	ER20-3.0	20	3.0	31.5	21.0	10 _μ m	●
	ER20-4.0	20	4.0	31.5	21.0	10 _μ m	●
	ER20-5.0	20	5.0	31.5	21.0	10 _μ m	●
	ER20-6.0	20	6.0	31.5	21.0	10 _μ m	●
	ER20-7.0	20	7.0	31.5	21.0	10 _μ m	●
	ER20-8.0	20	8.0	31.5	21.0	10 _μ m	●
	ER20-9.0	20	9.0	31.5	21.0	10 _μ m	●
	ER20-10.0	20	10.0	31.5	21.0	10 _μ m	●
	ER20-11.0	20	11.0	31.5	21.0	10 _μ m	●
	ER20-12.0	20	12.0	31.5	21.0	10 _μ m	●
	ER20-13.0	20	13.0	31.5	21.0	10 _μ m	●

	Designation	ER Size	ØD	L	ØD1	Accuracy	Stock
ER25	ER25-2.0	25	2.0	34.0	26.0	10 _μ m	●
	ER25-3.0	25	3.0	34.0	26.0	10 _μ m	●
	ER25-4.0	25	4.0	34.0	26.0	10 _μ m	●
	ER25-5.0	25	5.0	34.0	26.0	10 _μ m	●
	ER25-6.0	25	6.0	34.0	26.0	10 _μ m	●
	ER25-7.0	25	7.0	34.0	26.0	10 _μ m	●
	ER25-8.0	25	8.0	34.0	26.0	10 _μ m	●
	ER25-9.0	25	9.0	34.0	26.0	10 _μ m	●
	ER25-10.0	25	10.0	34.0	26.0	10 _μ m	●
	ER25-11.0	25	11.0	34.0	26.0	10 _μ m	●
	ER25-12.0	25	12.0	34.0	26.0	10 _μ m	●
	ER25-13.0	25	13.0	34.0	26.0	10 _μ m	●
	ER25-14.0	25	14.0	34.0	26.0	10 _μ m	●
ER25-15.0	25	15.0	34.0	26.0	10 _μ m	●	
ER25-16.0	25	16.0	34.0	26.0	10 _μ m	●	
ER32	ER32-2.0	32	2.0	40.0	33.0	10 _μ m	●
	ER32-3.0	32	3.0	40.0	33.0	10 _μ m	●
	ER32-4.0	32	4.0	40.0	33.0	10 _μ m	●
	ER32-5.0	32	5.0	40.0	33.0	10 _μ m	●
	ER32-6.0	32	6.0	40.0	33.0	10 _μ m	●
	ER32-7.0	32	7.0	40.0	33.0	10 _μ m	●
	ER32-8.0	32	8.0	40.0	33.0	10 _μ m	●
	ER32-9.0	32	9.0	40.0	33.0	10 _μ m	●
	ER32-10.0	32	10.0	40.0	33.0	10 _μ m	●
	ER32-11.0	32	11.0	40.0	33.0	10 _μ m	●
	ER32-12.0	32	12.0	40.0	33.0	10 _μ m	●
	ER32-13.0	32	13.0	40.0	33.0	10 _μ m	●
	ER32-14.0	32	14.0	40.0	33.0	10 _μ m	●
ER32-15.0	32	15.0	40.0	33.0	10 _μ m	●	
ER32-16.0	32	16.0	40.0	33.0	10 _μ m	●	
ER32-17.0	32	17.0	40.0	33.0	10 _μ m	●	
ER32-18.0	32	18.0	40.0	33.0	10 _μ m	●	
ER32-19.0	32	19.0	40.0	33.0	10 _μ m	●	
ER32-20.0	32	20.0	40.0	33.0	10 _μ m	●	

Order Example • General Type – Order as ER16-6.0 • Precision Type – Order as ER16-6.0P
 • General Sealed Type – Order as ER16-6.0C

(Unit : mm)

※ Please contact us about other diameter.

※ The (C) type is a sealed ER collet.

Chuck

Arbor/Modular

Boring Tool

Angular Head

CBN/PCD

Device&Accessory

Standard

1:1 CHAT



ER COLLET NEW

ER collet (Precision Type)

Precision
5 μ m

Run-out

ER Collet

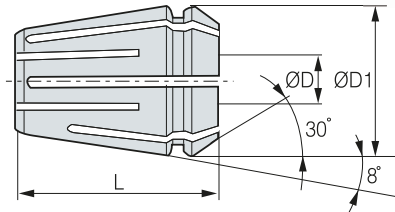

● : Stock

	Designation	ER Size	ØD	L	ØD1	Accuracy	Stock
ER11	ER11-2.0P	11	2.0	18.0	11.3	5 μ m	●
	ER11-3.0P	11	3.0	18.0	11.3	5 μ m	●
	ER11-4.0P	11	4.0	18.0	11.3	5 μ m	●
	ER11-5.0P	11	5.0	18.0	11.3	5 μ m	●
	ER11-6.0P	11	6.0	18.0	11.3	5 μ m	●
	ER11-7.0P	11	7.0	18.0	11.3	5 μ m	●
ER16	ER16-3.0P	16	3.0	27.5	16.7	5 μ m	●
	ER16-4.0P	16	4.0	27.5	16.7	5 μ m	●
	ER16-5.0P	16	5.0	27.5	16.7	5 μ m	●
	ER16-6.0P	16	6.0	27.5	16.7	5 μ m	●
	ER16-7.0P	16	7.0	27.5	16.7	5 μ m	●
	ER16-8.0P	16	8.0	27.5	16.7	5 μ m	●
ER20	ER20-9.0P	16	9.0	27.5	16.7	5 μ m	●
	ER20-10.0P	16	10.0	27.5	16.7	5 μ m	●
	ER20-3.0P	20	3.0	31.5	20.7	5 μ m	●
	ER20-4.0P	20	4.0	31.5	20.7	5 μ m	●
	ER20-5.0P	20	5.0	31.5	20.7	5 μ m	●
	ER20-6.0P	20	6.0	31.5	20.7	5 μ m	●
	ER20-7.0P	20	7.0	31.5	20.7	5 μ m	●
	ER20-8.0P	20	8.0	31.5	20.7	5 μ m	●
	ER20-9.0P	20	9.0	31.5	20.7	5 μ m	●
	ER20-10.0P	20	10.0	31.5	20.7	5 μ m	●
	ER20-11.0P	20	11.0	31.5	20.7	5 μ m	●
	ER20-12.0P	20	12.0	31.5	20.7	5 μ m	●
	ER20-13.0P	20	13.0	31.5	20.7	5 μ m	●

	Designation	ER Size	ØD	L	ØD1	Accuracy	Stock
ER25	ER25-3.0P	25	3.0	34.0	25.8	5 μ m	●
	ER25-4.0P	25	4.0	34.0	25.8	5 μ m	●
	ER25-5.0P	25	5.0	34.0	25.8	5 μ m	●
	ER25-6.0P	25	6.0	34.0	25.8	5 μ m	●
	ER25-7.0P	25	7.0	34.0	25.8	5 μ m	●
	ER25-8.0P	25	8.0	34.0	25.8	5 μ m	●
	ER25-9.0P	25	9.0	34.0	25.8	5 μ m	●
	ER25-10.0P	25	10.0	34.0	25.8	5 μ m	●
	ER25-11.0P	25	11.0	34.0	25.8	5 μ m	●
	ER25-12.0P	25	12.0	34.0	25.8	5 μ m	●
	ER25-13.0P	25	13.0	34.0	25.8	5 μ m	●
	ER25-14.0P	25	14.0	34.0	25.8	5 μ m	●
ER32	ER25-15.0P	25	15.0	34.0	25.8	5 μ m	●
	ER25-16.0P	25	16.0	34.0	25.8	5 μ m	●
	ER32-3.0P	32	3.0	40.0	32.8	5 μ m	●
	ER32-4.0P	32	4.0	40.0	32.8	5 μ m	●
	ER32-5.0P	32	5.0	40.0	32.8	5 μ m	●
	ER32-6.0P	32	6.0	40.0	32.8	5 μ m	●
	ER32-7.0P	32	7.0	40.0	32.8	5 μ m	●
	ER32-8.0P	32	8.0	40.0	32.8	5 μ m	●
	ER32-9.0P	32	9.0	40.0	32.8	5 μ m	●
	ER32-10.0P	32	10.0	40.0	32.8	5 μ m	●
	ER32-11.0P	32	11.0	40.0	32.8	5 μ m	●
	ER32-12.0P	32	12.0	40.0	32.8	5 μ m	●
	ER32-13.0P	32	13.0	40.0	32.8	5 μ m	●
	ER32-14.0P	32	14.0	40.0	32.8	5 μ m	●
	ER32-15.0P	32	15.0	40.0	32.8	5 μ m	●
	ER32-16.0P	32	16.0	40.0	32.8	5 μ m	●
ER32-17.0P	32	17.0	40.0	32.8	5 μ m	●	
ER32-18.0P	32	18.0	40.0	32.8	5 μ m	●	
ER32-19.0P	32	19.0	40.0	32.8	5 μ m	●	
ER32-20.0P	32	20.0	40.0	32.8	5 μ m	●	

Order example • General Type – Order as ER16-6.0 • Precision Type – Order as ER16-6.0P
• General Sealed Type – Order as ER16-6.0C

(Unit : mm)

※ Please contact us about other diameter.

※ The (C) type is a sealed ER collet.

1:1 CHAT



ER COLLET

ER Collet (General Sealed Type)

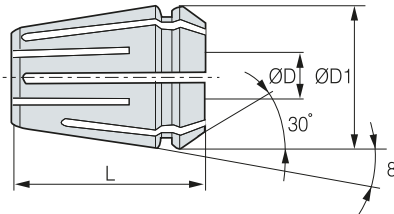

● : Stock

	Designation	ER Size	ØD	L	ØD1	Accuracy	Stock
ER16	ER16-5.0C	16	5.0	27.5	17.0	10µm	●
	ER16-6.0C	16	6.0	27.5	17.0	10µm	●
	ER16-8.0C	16	8.0	27.5	17.0	10µm	●
	ER16-10.0C	16	10.0	27.5	17.0	10µm	●
ER20	ER20-6.0C	20	6.0	31.5	21.0	10µm	●
	ER20-8.0C	20	8.0	31.5	21.0	10µm	●
	ER20-10.0C	20	10.0	31.5	21.0	10µm	●
	ER20-12.0C	20	12.0	31.5	21.0	10µm	●
ER25	ER25-6.0C	25	6.0	34.0	26.0	10µm	●
	ER25-8.0C	25	8.0	34.0	26.0	10µm	●
	ER25-10.0C	25	10.0	34.0	26.0	10µm	●
	ER25-12.0C	25	12.0	34.0	26.0	10µm	●
	ER25-14.0C	25	14.0	34.0	26.0	10µm	●
	ER25-16.0C	25	16.0	34.0	26.0	10µm	●
ER32	ER32-8.0C	32	8.0	40.0	33.0	10µm	●
	ER32-9.0C	32	9.0	40.0	33.0	10µm	●
	ER32-10.0C	32	10.0	40.0	33.0	10µm	●
	ER32-11.0C	32	11.0	40.0	33.0	10µm	●
	ER32-12.0C	32	12.0	40.0	33.0	10µm	●
	ER32-13.0C	32	13.0	40.0	33.0	10µm	●
	ER32-14.0C	32	14.0	40.0	33.0	10µm	●
	ER32-15.0C	32	15.0	40.0	33.0	10µm	●
	ER32-16.0C	32	16.0	40.0	33.0	10µm	●
	ER32-18.0C	32	18.0	40.0	33.0	10µm	●
	ER32-20.0C	32	20.0	40.0	33.0	10µm	●

Order example • General Type – Order as ER16-6.0 • Precision Type – Order as ER16-6.0P (Unit : mm)
 • General Sealed Type – Order as ER16-6.0C

※ Please contact us about other diameter.
 ※ The (C) type is a sealed ER collet.

Chuck
 Arbor/Modular
 Boring Tool
 Angular Head
 cBN/PCD
 Device&Accessory
 Standard

1:1 CHAT 🗨️



ER-T COLLET

NEW

ER-T Collet (General Type)



General
8 μ m
Run-out

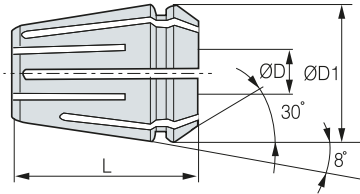

● : Stock

	Designation	ER Size	ØD	L	ØD1	Accuracy	Stock
ER11	ER11-2.0-T	11	2.0	18.0	11.5	8 μ m	●
	ER11-3.0-T	11	3.0	18.0	11.5	8 μ m	●
	ER11-4.0-T	11	4.0	18.0	11.5	8 μ m	●
	ER11-5.0-T	11	5.0	18.0	11.5	8 μ m	●
	ER11-6.0-T	11	6.0	18.0	11.5	8 μ m	●
	ER11-7.0-T	11	7.0	18.0	11.5	8 μ m	●
ER16	ER16-2.0-T	16	2.0	27.5	17.0	8 μ m	●
	ER16-3.0-T	16	3.0	27.5	17.0	8 μ m	●
	ER16-4.0-T	16	4.0	27.5	17.0	8 μ m	●
	ER16-5.0-T	16	5.0	27.5	17.0	8 μ m	●
	ER16-6.0-T	16	6.0	27.5	17.0	8 μ m	●
	ER16-7.0-T	16	7.0	27.5	17.0	8 μ m	●
	ER16-8.0-T	16	8.0	27.5	17.0	8 μ m	●
	ER16-9.0-T	16	9.0	27.5	17.0	8 μ m	●
	ER16-10.0-T	16	10.0	27.5	17.0	8 μ m	●
	ER20	ER20-2.0-T	20	2.0	31.5	21.0	8 μ m
ER20-3.0-T		20	3.0	31.5	21.0	8 μ m	●
ER20-4.0-T		20	4.0	31.5	21.0	8 μ m	●
ER20-5.0-T		20	5.0	31.5	21.0	8 μ m	●
ER20-6.0-T		20	6.0	31.5	21.0	8 μ m	●
ER20-7.0-T		20	7.0	31.5	21.0	8 μ m	●
ER20-8.0-T		20	8.0	31.5	21.0	8 μ m	●
ER20-9.0-T		20	9.0	31.5	21.0	8 μ m	●
ER20-10.0-T		20	10.0	31.5	21.0	8 μ m	●
ER20-11.0-T		20	11.0	31.5	21.0	8 μ m	●
ER20-12.0-T		20	12.0	31.5	21.0	8 μ m	●
ER20-13.0-T		20	13.0	31.5	21.0	8 μ m	●

(Unit : mm)

	Designation	ER Size	ØD	L	ØD1	Accuracy	Stock
ER25	ER25-2.0-T	25	2.0	34.0	26.0	8 μ m	●
	ER25-3.0-T	25	3.0	34.0	26.0	8 μ m	●
	ER25-4.0-T	25	4.0	34.0	26.0	8 μ m	●
	ER25-5.0-T	25	5.0	34.0	26.0	8 μ m	●
	ER25-6.0-T	25	6.0	34.0	26.0	8 μ m	●
	ER25-7.0-T	25	7.0	34.0	26.0	8 μ m	●
	ER25-8.0-T	25	8.0	34.0	26.0	8 μ m	●
	ER25-9.0-T	25	9.0	34.0	26.0	8 μ m	●
	ER25-10.0-T	25	10.0	34.0	26.0	8 μ m	●
	ER25-11.0-T	25	11.0	34.0	26.0	8 μ m	●
	ER25-12.0-T	25	12.0	34.0	26.0	8 μ m	●
	ER25-13.0-T	25	13.0	34.0	26.0	8 μ m	●
	ER25-14.0-T	25	14.0	34.0	26.0	8 μ m	●
	ER25-15.0-T	25	15.0	34.0	26.0	8 μ m	●
	ER25-16.0-T	25	16.0	34.0	26.0	8 μ m	●
	ER32	ER32-2.0-T	32	2.0	40.0	33.0	8 μ m
ER32-3.0-T		32	3.0	40.0	33.0	8 μ m	●
ER32-4.0-T		32	4.0	40.0	33.0	8 μ m	●
ER32-5.0-T		32	5.0	40.0	33.0	8 μ m	●
ER32-6.0-T		32	6.0	40.0	33.0	8 μ m	●
ER32-7.0-T		32	7.0	40.0	33.0	8 μ m	●
ER32-8.0-T		32	8.0	40.0	33.0	8 μ m	●
ER32-9.0-T		32	9.0	40.0	33.0	8 μ m	●
ER32-10.0-T		32	10.0	40.0	33.0	8 μ m	●
ER32-11.0-T		32	11.0	40.0	33.0	8 μ m	●
ER32-12.0-T		32	12.0	40.0	33.0	8 μ m	●
ER32-13.0-T		32	13.0	40.0	33.0	8 μ m	●
ER32-14.0-T		32	14.0	40.0	33.0	8 μ m	●
ER32-15.0-T		32	15.0	40.0	33.0	8 μ m	●
ER32-16.0-T	32	16.0	40.0	33.0	8 μ m	●	
ER32-17.0-T	32	17.0	40.0	33.0	8 μ m	●	
ER32-18.0-T	32	18.0	40.0	33.0	8 μ m	●	
ER32-19.0-T	32	19.0	40.0	33.0	8 μ m	●	
ER32-20.0-T	32	20.0	40.0	33.0	8 μ m	●	

(Unit : mm)

1:1 CHAT



ER/L

Lock Collet for ER Collet Chuck



ER Collet



Lock



Coolant System



Features

- The mechanical fastening method enables the prevention of tool deviation
- Stable tool fastening force even under extreme machining conditions

NAMING

ER	20	12	L
ER Collet	Collet Size	Tool Dia.	Lock

Structural Features

Designed to Prevent Fallout

- Tool fallout is prevented by a key inserted in the collet.
- A key is inserted to prevent the tool from pull out.

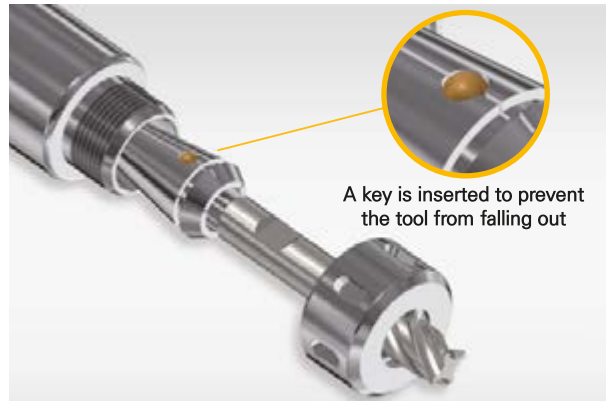

How to Use

1



Combine the non-slip ER collet with nut.

2

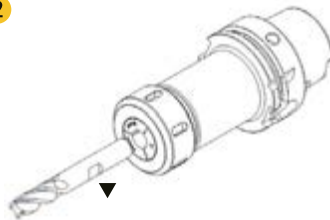

Clamp the nut after inserting no. ① into the collet chuck. After that, insert the end mill notch to be aligned with the part ▼ (steel ball position).

3

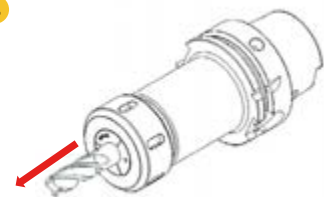

After checking that the steel ball in the collet is caught in the notched part, completely clamp the nut by pulling the end mill in the axial direction (arrow direction)

Note If an auto clamp device is used, skip step ③. (Endmill rotation may cause injury.)

Applicable Endmill

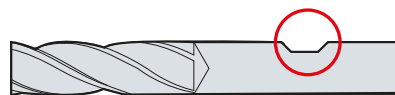

〈DIN6535HB Spec. End Mill〉

※ Please refer to **105p** for detailed specifications.

1:1 CHAT



ER/L

Lock Collet for ER Collet Chuck

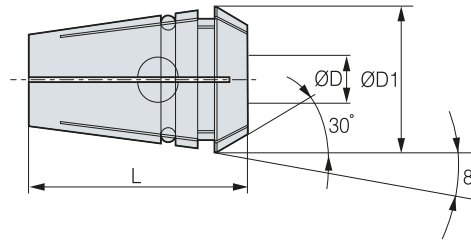

● : Stock

	Designation	ER Size	ØD	L	ØD1	Stock
ER20L	ER20-6L	20	6	31.5	20.7	●
	ER20-8L	20	8	31.5	20.7	●
	ER20-10L	20	10	31.5	20.7	●
	ER20-12L	20	12	31.5	20.7	●
ER32L	ER32-12L	32	12	40.0	32.7	●
	ER32-16L	32	16	40.0	32.7	●
	ER32-20L	32	20	40.0	32.7	●

※ Manufactured based on DIN ISO 15488-A

(Unit : mm)

1:1 CHAT



NOTCHED ENDMILL

Notched Endmill

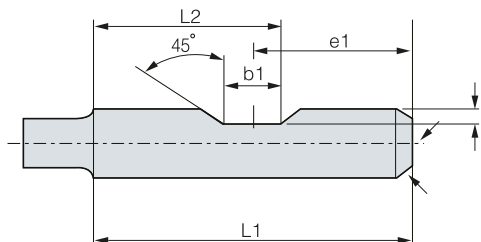

Tool Ø	Tool (DIN6535)				
	L1	e1	b1	L2	t
6	36	18	4.2	20.1	0.9
8	36	18	5.5	20.75	1.1
10	40	20	7	23.5	1.5
12	45	22.5	8	26.5	1.6
14	45	22.5	8	26.5	1.3
16	48	24	10	29	1.8
18	48	24	10	29	1.8
20	50	25	11	30.5	1.8
25	56	32	12	30	2.0
32	60	36	14	31.0	2.0

※ DIN 6535HB standard endmill used. ※ Not supplied with ER/L collet.

(Unit : mm)

Chuck

Arbor/Modular

Boring Tool

Angular Head

cBN/PCD

Device&Accessory

Standard

1:1 CHAT



RTJW

Jet Coolant Disk



Jet Coolant

Inside Coolant



Features

- Internal coolant function available without using an expensive waterproof collet
- When O-ring is removed, the jet coolant function is available
- Reduces damage on workpiece caused by chips

NAMING

RTJW	16	6
Jet Coolant Disk	Nut Size	Tool Dia.

Application

- With one waterproof type (RT, RUT) NUT, the inside jet coolant is simultaneously used
- Enables a fast change of the inside jet coolant only by disk replacement
- Strong jet injection with no scattering even in the high-speed rotation

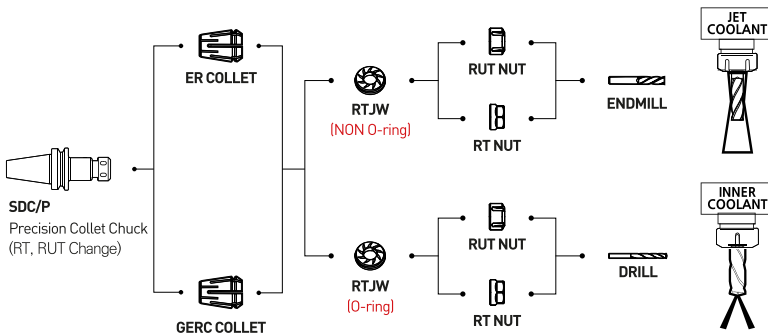

RT NUT

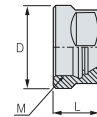

Type	M	D	L
RT16	M22x1.50	28.0	22.5

RUT NUT

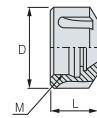

Type	M	D	L
RUT20	M25x1.50	35	24
RUT25	M32x1.50	42	25
RUT32	M40x1.50	50	27.5
RUT40	M50x1.50	63	30.5

Type	Pocket Machining	After	Remarks
Jet Coolant			• The chips in the pocket completely are removed by a strong jet injection.
Outside Coolant			• The chips in the pocket are not removed. • Chips are accumulated in the collet and nut.

Coolant Method

According to use, inside coolant and jet coolant refueling can be used.

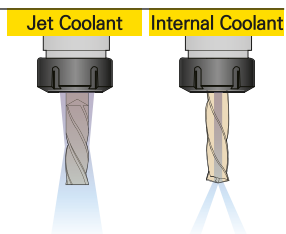

Mixing Prevention

Effective for vibration proof by preventing mixing of cutting chips by using RTJW.

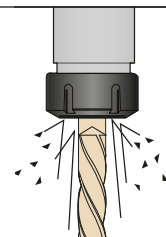

1:1 CHAT



RTJW

Jet Coolant Disk



Jet Coolant



Inside Coolant



- : To be switched to NP order after stock depletion
- : Stock

※ We do not manufacture less than Ø5

- For more information on product features, see **106P**
- For more information on the products to be tightened, see **80P**

	Designation	ER Size	Inner Diameter	Available Nut	Stock
RTJW16	RTJW16-6	16	6	RUT16	●
	RTJW16-7	16	7	RUT16	●
	RTJW16-8	16	8	RUT16	●
RTJW20	RTJW20-6	20	6	RUT20	●
	RTJW20-7	20	7	RUT20	●
	RTJW20-8	20	8	RUT20	●
	RTJW20-9	20	9	RUT20	●
	RTJW20-10	20	10	RUT20	●
RTJW25	RTJW25-6	25	6	RUT25	●
	RTJW25-7	25	7	RUT25	●
	RTJW25-8	25	8	RUT25	●
	RTJW25-9	25	9	RUT25	●
	RTJW25-10	25	10	RUT25	●
	RTJW25-11	25	11	RUT25	●
	RTJW25-12	25	12	RUT25	●
	RTJW25-13	25	13	RUT25	●
	RTJW25-14	25	14	RUT25	●
	RTJW25-15	25	15	RUT25	●
	RTJW25-16	25	16	RUT25	●

(Unit : mm)

	Designation	ER Size	Inner Diameter	Available Nut	Stock
RTJW32	RTJW32-6	32	6	RUT32	●
	RTJW32-7	32	7	RUT32	●
	RTJW32-8	32	8	RUT32	●
	RTJW32-9	32	9	RUT32	●
	RTJW32-10	32	10	RUT32	●
	RTJW32-11	32	11	RUT32	●
	RTJW32-12	32	12	RUT32	●
	RTJW32-13	32	13	RUT32	●
	RTJW32-14	32	14	RUT32	●
	RTJW32-15	32	15	RUT32	●
RTJW40	RTJW40-18	40	18	RUT40	●
	RTJW40-19	40	19	RUT40	●
	RTJW40-20	40	20	RUT40	●
	RTJW40-21	40	21	RUT40	●
	RTJW40-22	40	22	RUT40	●
	RTJW40-24	40	24	RUT40	●

(Unit : mm)

Chuck

Arbor/Modular

Boring Tool

Angular Head

cBN/PCD

Device&Accessory

Standard

1:1 CHAT



DSK

Slim Type Collet Chuck



G6.3

G value

15,000

Max RPM

Ø25

Max Dia

C

Coolant System

HC

HC Collet

Milling

Drilling



Features

- Applied 8-degree collet and broader fastening area
- Stable machinability thanks to high fastening force
- Balancing design for high-speed machining
- Tool clamping range : Ø2-Ø25mm

NAMING

BT30

Spindle

DSK

Slim Type
Collet Chuck

10

Tool Dia.

90

Length

Multipurpose Operation

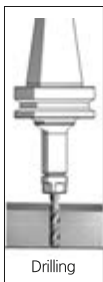

Drilling



Fine milling



Reaming

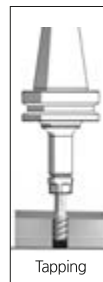

Tapping



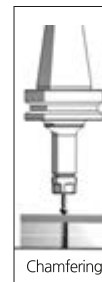

Milling



Chamfering

Collet

General Type & Precision Type	Designation	Max Chucking	Run-out	8° HC Collet
	HC6 - ØD	6.0	General Type 5 µm	 Minimizes tool vibration during machining
	HC10 - ØD	10.0		
	HC13 - ØD	13.0	Precision Type 3 µm	
	HC16 - ØD	16.0		
	HC20 - ØD	20.0		
	HC25 - ØD	25.0		

Spanner(Accessories)

Spanner	Designation	Chuck
	DSS - 6	DSK 6
	DSS - 10	DSK 10
	DSS - 13	DSK 13
	DSS - 16	DSK 16
	DSS - 20	DSK 20
	DSS - 25	DSK 25

Collet Extract Tool

Collet Extractor	Designation	Chuck
	DSS - 6CE	DSK 6
	DSS - 10CE	DSK 10
	DSS - 13CE	DSK 13
	DSS - 16CE	DSK 16
	DSS - 20CE	DSK 20
	DSS - 25CE	DSK 25



BT-DSK

Slim Type Collet Chuck



- MAS 403-BT**
Shank
- G6.3**
G value
- 15,000**
Max RPM
- Ø25**
Max Dia
- C**
Coolant System
- HC**
HC Collet
- Milling
- Drilling

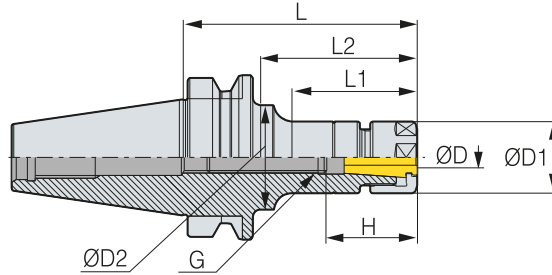

● : Stock

C Internal coolant system is optional.

※ Sealed collet is used when applying internal coolant.

• For more information on product features, see **108P**

• For more information on the related parts, see **111P**

• For more information on the applicable collet, see **118P**

	Designation	ØD	L	ØD1	ØD2	L1	L2	H	Collet	G	RPM	kg	Package Weight (kg)	Stock
BT30	BT30-DSK6-60	3.0~6.0	60	20	20	33	33	31	HC6	M8	15,000	0.4	0.5	●
	BT30-DSK6-90	3.0~6.0	90	20	32	56	65	31	HC6	M8	15,000	0.5	0.6	●
	BT30-DSK10-60	2.0~10.0	60	28	28	35	35	38	HC10	M12	15,000	0.5	0.6	●
	BT30-DSK10-90	2.0~10.0	90	28	28	65	65	38	HC10	M12	15,000	0.6	0.7	●
	BT30-DSK10-120	2.0~10.0	120	28	28	95	95	38	HC10	M12	15,000	1.1	1.1	
	BT30-DSK13-60	3.0~13.0	60	33	33	36	36	43	HC13	M12	15,000	0.5	0.6	●
	BT30-DSK16-60	3.0~16.0	60	40	40	37	37	52	HC16	M12	15,000	0.6	0.7	●
	BT30-DSK16-90	3.0~16.0	90	40	40	67	67	52	HC16	M18	15,000	0.8	0.9	●
	BT30-DSK16-120	3.0~16.0	120	40	40	97	97	60	HC16	M18	15,000	1.1	1.1	
	BT30-DSK20-75	4.0~20.0	75	48	48	52	52	70	HC20	M12	15,000	1.1	1.1	
	BT30-DSK20-90	4.0~20.0	90	48	48	52	52	70	HC20	M18	15,000	1.2	1.2	
BT30-DSK25-90	16.0~25.0	90	55	55	67.5	67.5	63.5	HC25	M12	15,000	0.9	1.1	●	
BT40	BT40-DSK6-60	3.0~6.0	60	20	20	30	30	35	HC6	M8	10,000	1.0	1.0	
	BT40-DSK6-90	3.0~6.0	90	20	32	51	61	31	HC6	M8	10,000	1.1	1.3	●
	BT40-DSK6-120	3.0~6.0	120	20	32	60	90	31	HC6	M8	10,000	1.1	1.3	●
	BT40-DSK6-150	3.0~6.0	150	20	25	60	120	31	HC6	M8	10,000	1.1	1.4	●
	BT40-DSK10-60	2.0~10.0	60	28	28	32	32	50	HC10	M12	10,000	1.1	1.1	
	BT40-DSK10-90	2.0~10.0	90	28	40	48	60	38	HC10	M12	10,000	1.2	1.4	●
	BT40-DSK10-120	2.0~10.0	120	28	40	73	90	38	HC10	M12	10,000	1.2	1.5	●
	BT40-DSK10-150	2.0~10.0	150	28	35	73	118	38	HC10	M12	10,000	1.4	1.7	●
	BT40-DSK10-180	2.0~10.0	180	28	39	73	148	50	HC10	M12	10,000	1.4	1.7	
	BT40-DSK13-90	3.0~13.0	90	33	33	59	59	43	HC13	M15	10,000	1.3	1.5	●
	BT40-DSK16-60	3.0~16.0	60	40	40	32	32	60	HC16	M18	10,000	1.3	1.5	
	BT40-DSK16-90	3.0~16.0	90	40	40	58	58	52	HC16	M18	10,000	1.3	1.5	●
	BT40-DSK16-120	3.0~16.0	120	40	40	88	88	52	HC16	M18	10,000	1.5	1.7	●
	BT40-DSK16-150	3.0~16.0	150	40	40	118	118	52	HC16	M18	10,000	1.9	2.1	●
	BT40-DSK16-180	3.0~16.0	180	40	40	148	148	60	HC16	M18	10,000	1.9	2.1	
	BT40-DSK20-60	4.0~20.0	60	48	48	32	32	70	HC20	M22	10,000	1.5	1.7	
	BT40-DSK20-90	4.0~20.0	90	49	49	60	60	60	HC20	M22	10,000	1.5	1.7	●
	BT40-DSK20-120	4.0~20.0	120	49	49	90	90	60	HC20	M22	10,000	1.8	2.0	●
	BT40-DSK25-90	16.0~25.0	90	55	55	61	61	63.5	HC25	M28	10,000	1.6	1.8	●
	BT40-DSK25-120	16.0~25.0	120	55	55	91	91	85	HC25	M28	10,000	2.0	2.3	●

(Unit : mm)

1:1 CHAT



BT-DSK

Slim Type Collet Chuck



MAS 403-BT Shank	G6.3 G value	8,000 Max RPM	∅25 Max Dia	C Coolant System	HC HC Collet	Milling	Drilling
----------------------------	------------------------	-------------------------	-----------------------	----------------------------	------------------------	---------	----------

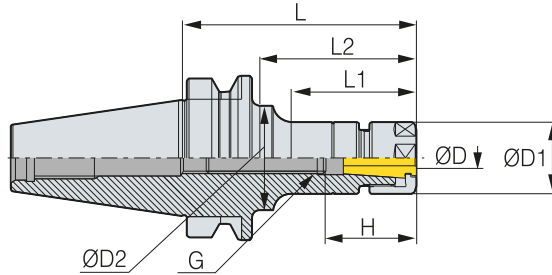

● : Stock

☐ Internal coolant system is optional.

※ Sealed collet is used when applying internal coolant

• For more information on product features, see **108P**

• For more information on the related parts, see **111P**

• For more information on the applicable collet, see **118P**

	Designation	∅D	L	∅D1	∅D2	L1	L2	H	Collet	G	RPM	kg	Package Weight (kg)	Stock
BT50	BT50-DSK6-105	3.0~6.0	105	20	32	55	64	31	HC6	M8	8,000	3.6	3.9	●
	BT50-DSK6-135	3.0~6.0	135	20	32	60	92	31	HC6	M8	8,000	3.7	4.1	●
	BT50-DSK6-165	3.0~6.0	165	20	32	60	114	31	HC6	M8	8,000	4.1	4.4	●
	BT50-DSK10-105	2.0~10.0	105	28	27.5	57	57	38	HC10	M12	8,000	3.8	4.1	●
	BT50-DSK10-135	2.0~10.0	135	28	32	70	92	38	HC10	M12	8,000	3.9	4.3	●
	BT50-DSK10-165	2.0~10.0	165	28	36	75	114	38	HC10	M12	8,000	4.1	4.5	●
	BT50-DSK10-195	2.0~10.0	195	28	36	75	146	38	HC10	M12	8,000	4.5	4.8	
	BT50-DSK13-135	3.0~13.0	135	33	33	92	92	43	HC13	M15	8,000	3.8	4.2	●
	BT50-DSK16-105	3.0~16.0	105	40	40	62	62	52	HC16	M18	8,000	4.0	4.3	●
	BT50-DSK16-135	3.0~16.0	135	40	40	92	92	52	HC16	M18	8,000	4.2	4.6	●
	BT50-DSK16-165	3.0~16.0	165	40	50	40	122	52	HC16	M18	8,000	4.6	5.0	●
	BT50-DSK16-195	3.0~16.0	195	40	52	40	152	60	HC16	M18	8,000	4.6	5.0	
	BT50-DSK20-105	4.0~20.0	105	48	40	62	62	60	HC20	M22	8,000	4.2	4.5	●
	BT50-DSK20-135	4.0~20.0	135	48	40	92	92	60	HC20	M22	8,000	4.5	4.9	●
	BT50-DSK20-165	4.0~20.0	165	48	40	122	122	60	HC20	M22	8,000	4.9	5.3	●
BT50-DSK25-105	16.0~25.0	105	55	55	62	62	64	HC25	M28	8,000	4.4	4.7	●	
BT50-DSK25-135	16.0~25.0	135	55	55	92	92	64	HC25	M28	8,000	4.5	4.9	●	
BT50-DSK25-165	16.0~25.0	165	55	55	122	122	64	HC25	M28	8,000	5.2	5.6	●	

(Unit : mm)

1:1 CHAT



DSK SPARE PART

Slim Collet Chuck Related Parts



Main Components

SPARE PART	Type	Main Components		
		Nut	Adjust Screw	Extraction Tool
	Images			
	Designation			
	DSK6	DN6	BN0825	DSK-6CE
	DSK10	DN10	BN1230	DSK-10CE
	DSK13	DN13	BN1230(BT30) / BN1524F(ETC)	DSK-13CE
	DSK16	DN16	BN1830F	DSK-16CE
	DSK20	DN20	BN2230F	DSK-20CE
	DSK25	DN25	BN2838F	DSK-25CE

※ BN1230 screws are used for BT30-DSK25-90.

Accessories

SPARE PART	Spanner	Designation	Chuck
	DSS-10	DSK10	
	DSS-13	DSK13	
	DSS-16	DSK16	
	DSS-20	DSK20	
	DSS-25	DSK25	

1:1 CHAT



HC COLLET

HC Slim Collet (General Type, Precision Type)



Accessories

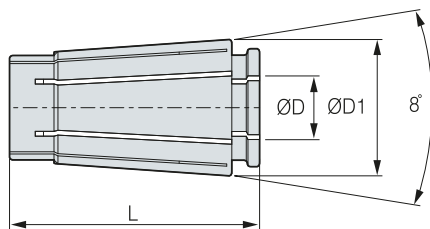

SPARE PART	Designation	ØD1	L	ØD	General	Precision (P)
		HC6 ØD(P)	10.5	25.0	6.0	5 μ m
	HC10 ØD(P)	15.6	30.5	10.0	5 μ m	3 μ m
	HC13 ØD(P)	20.1	39.0	13.0	5 μ m	3 μ m
	HC16 ØD(P)	24.6	45.0	16.0	5 μ m	3 μ m
	HC20 ØD(P)	29.2	54.3	20.0	5 μ m	3 μ m
	HC25 ØD(P)	35.7	57.0	25.0	5 μ m	3 μ m

※ For more information on the detailed specifications, see **118P**. (Unit : mm)

Order Example • General Type – Order as HC16-8.0
• Precision Type – Order as HC16-8.0P

1:1 CHAT



GSK

Great Speed Slim Collet Chuck



G2.5

G value

25,000

Max RPM

Ø25

Max Dia

C

Coolant System

HC

HC Collet

Milling

Drilling



Features

- Improved repeatability of fastening tolerance through the sleeve bearing nut
- Applied 8-degree collet and broader fastening area
- Minimizes imbalance due to fastening grooves through high-speed type nuts
- Tool clamping range : Ø2-Ø25mm

NAMING

BT40	GSK	10	90
Spindle	Great Speed Slim Collet Chuck	Tool Dia.	Length

Original Design

GSK

Other Companies

Planar part fixing method

Nuts for high-speed rotation

8° HC collet

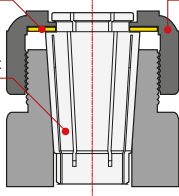

Provides strong tightening force with a 8° collet and good fixation degree based on planar part fixing method

Imbalance causing shaking

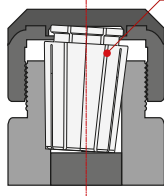

Unstable balance is generated by the centrifugal force at the time of high-speed rotation

Comparison of Screw Polishing at Points of Nut Tightened

GSK

Other Companies

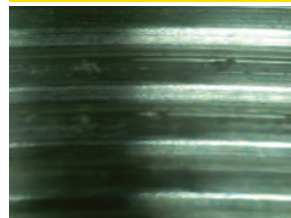

Provides excellent reproduction precision through screw grinding

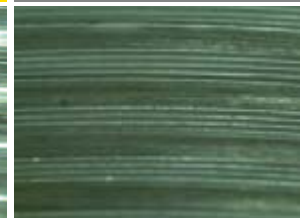

Unstable precision due to turning operation

Special Design

Optimized for great-speed collet chucks and uniquely designed to enable easy run-out measurement by designating the test bar area to the product

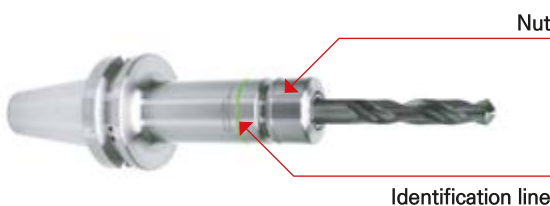

Nut

Identification line

C Internal coolant system is optional

Spanner(Optional)



Designation	GSK
GSK6 SPANNER	GSK6
GSK10 SPANNER	GSK10
GSK13 SPANNER	GSK13
GSK16 SPANNER	GSK16
GSK20 SPANNER	GSK20
GSK25 SPANNER	GSK25

1:1 CHAT



BT-GSK

Great Speed Slim Type Collet Chuck

MAS
403-BT

Shank

G2.5

G value

25,000

Max RPM

Ø25

Max Dia

C

Coolant System

HC

HC Collet



Milling



Drilling

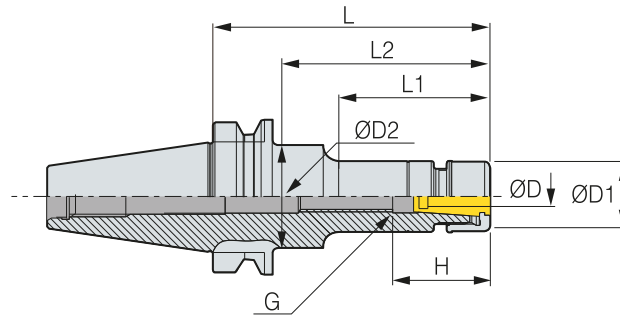

● : Stock

• H : Depth of tool insertion

C Internal coolant system is optional.

※ Sealed collet is used when applying internal coolant

• For more information on product features, see **112P**

• For more information on the related parts, see **117P**

• For more information on the applicable collet, see **118P**

	Designation	ØD	L	ØD1	ØD2	L1	L2	H	Collet	G	RPM	kg	Package Weight (kg)	Stock	
BT30	BT30-GSK6-60	3.0~6.0	60	20	20	33	33	31	HC6	M8	25,000	0.4	0.4	●	
	BT30-GSK6-90	3.0~6.0	90	20	32	56	65	31	HC6	M8	25,000	0.5	0.6	●	
	BT30-GSK10-60	2.0~10.0	60	27	27	35	35	38	HC10	M12	25,000	0.5	0.6	●	
	BT30-GSK10-90	2.0~10.0	90	27	27	65	65	38	HC10	M12	25,000	0.6	0.7	●	
	BT30-GSK13-60	3.0~13.0	60	35	35	36	36	43	HC13	M12	25,000	0.6	0.7	●	
	BT30-GSK16-60	3.0~16.0	60	40	40	37	37	52	HC16	M12	25,000	0.6	0.7	●	
	BT30-GSK16-90	3.0~16.0	90	40	40	67	67	52	HC16	M18	25,000	0.8	0.9	●	
	BT30-GSK25-90	16.0~25.0	90	55	55	68	68	64	HC25	M12	25,000	1.0	1.1	●	
BT40	BT40-GSK6-90	3.0~6.0	90	20	32	51	61	31	HC6	M8	20,000	1.0	1.2	●	
	BT40-GSK6-120	3.0~6.0	120	20	32	60	90	31	HC6	M8	20,000	1.2	1.5	●	
	BT40-GSK6-150	3.0~6.0	150	20	25	60	120	31	HC6	M8	20,000	1.2	1.4	●	
	BT40-GSK10-90	2.0~10.0	90	27	40	48	60	38	HC10	M12	20,000	1.1	1.3	●	
	BT40-GSK10-120	2.0~10.0	120	27	40	73	90	38	HC10	M12	20,000	1.3	1.5	●	
	BT40-GSK10-150	2.0~10.0	150	27	65	73	118	38	HC10	M12	20,000	1.4	1.6	●	
	BT40-GSK13-90	3.0~13.0	90	35	35	59	59	43	HC13	M15	20,000	1.2	1.4	●	
	BT40-GSK16-90	3.0~16.0	90	40	40	58	58	52	HC16	M18	20,000	1.3	1.5	●	
	BT40-GSK16-120	3.0~16.0	120	40	40	88	88	52	HC16	M18	20,000	1.5	1.7	●	
	BT40-GSK16-150	3.0~16.0	150	40	40	118	118	52	HC16	M18	20,000	1.8	2.0	●	
	BT40-GSK20-90	4.0~20.0	90	48	48	60	60	60	HC20	M22	20,000	1.4	1.6	●	
	BT40-GSK20-120	4.0~20.0	120	48	48	90	90	60	HC20	M22	20,000	1.8	2.0	●	
	BT40-GSK25-90	16.0~25.0	90	55	55	61	61	64	HC25	M28	20,000	1.6	1.8	●	
	BT40-GSK25-120	16.0~25.0	120	55	55	91	91	64	HC25	M28	20,000	2.0	2.2	●	

(Unit : mm)

1:1 CHAT



BT-GSK

Great Speed Slim Type Collet Chuck

MAS
403-BT

Shank

G2.5

G value

15,000

Max RPM

∅25

Max Dia

C

Coolant System

HC

HC Collet



Milling



Drilling

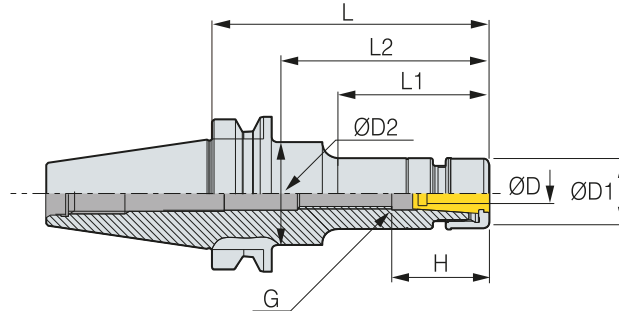

● : Stock

• H : Depth of tool insertion

C Internal coolant system is optional

※ Sealed collet is used when applying internal coolant

• For more information on product features, see [112P](#)

• For more information on the related parts, see [117P](#)

• For more information on the applicable collet, see [118P](#)

BT50

Designation	∅D	L	∅D1	∅D2	L1	L2	H	Collet	G	RPM	kg	Package Weight (kg)	Stock
BT50-GSK6-105	3.0~6.0	105	20	32	55	64	31	HC6	M8	15,000	3.6	3.9	●
BT50-GSK6-135	3.0~6.0	135	20	32	60	92	31	HC6	M8	15,000	3.6	4.0	●
BT50-GSK6-165	3.0~6.0	165	20	32	60	114	31	HC6	M8	15,000	3.9	4.3	●
BT50-GSK10-105	2.0~10.0	105	27	27	57	57	38	HC10	M12	15,000	3.7	4.0	●
BT50-GSK10-135	2.0~10.0	135	27	32	70	92	38	HC10	M12	15,000	3.7	4.1	●
BT50-GSK10-165	2.0~10.0	165	27	36	75	114	38	HC10	M12	15,000	4.0	4.4	●
BT50-GSK13-135	3.0~13.0	135	35	35	92	92	43	HC13	M15	15,000	3.9	4.3	●
BT50-GSK16-105	3.0~16.0	105	40	40	62	62	52	HC16	M18	15,000	3.9	4.2	●
BT50-GSK16-135	3.0~16.0	135	40	40	92	92	52	HC16	M18	15,000	4.1	4.5	●
BT50-GSK16-165	3.0~16.0	165	40	50	40	122	52	HC16	M18	15,000	4.3	4.7	●
BT50-GSK20-105	4.0~20.0	105	48	-	-	62	60	HC20	M22	15,000	4.1	4.4	●
BT50-GSK20-135	4.0~20.0	135	48	-	-	92	60	HC20	M22	15,000	4.4	4.8	●
BT50-GSK20-165	4.0~20.0	165	48	-	-	122	60	HC20	M22	15,000	4.9	5.1	●
BT50-GSK25-105	16.0~25.0	105	55	55	62	62	64	HC25	M28	15,000	4.2	4.5	●
BT50-GSK25-135	16.0~25.0	135	55	55	92	92	64	HC25	M28	15,000	4.6	5.0	●
BT50-GSK25-165	16.0~25.0	165	55	55	122	122	64	HC25	M28	15,000	5.1	5.5	●

(Unit : mm)

1:1 CHAT



HSK-GSK

Great Speed Slim Type Collet Chuck



- DIN 69893-1**
Shank
- G2.5**
G value
- 20,000**
Max RPM
- Ø25**
Max Dia
- C**
Coolant System
- HC**
HC Collet
- Milling
- Drilling

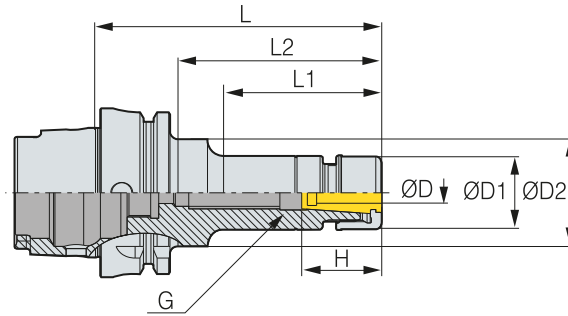

- ● : Stock
- H : Depth of tool insertion
- ☐ C Internal coolant system is optional
- ※ Sealed collet is used when applying internal coolant

- For more information on product features, see **112P**
- For more information on the related parts, see **117P**
- For more information on the applicable collet, see **118P**

	Designation	ØD	L	ØD1	ØD2	L1	L2	H	Collet	G	RPM	kg	Package Weight (kg)	Stock
HSK63A	HSK63A-GSK6-100	3.0~6.0	100	20	32	51	71	31	HC6	M8	20,000	0.8	1.0	●
	HSK63A-GSK10-105	2.0~10.0	105	27	35	60	76	38	HC10	M12	20,000	0.9	1.2	●
	HSK63A-GSK16-120	3.0~16.0	120	40	40	90	-	52	HC16	M18	20,000	1.3	1.5	●
	HSK63A-GSK20-120	4.0~20.0	120	48	48	92	-	60	HC20	M22	20,000	1.6	1.8	●
HSK100A	HSK100A-GSK6-120	3.0~6.0	120	19.5	32	70	88	31	HC6	M8	15,000	2.2	2.6	●
	HSK100A-GSK10-120	2.0~10.0	120	27	27	70	88	38	HC10	M12	15,000	2.3	2.7	●
	HSK100A-GSK16-140	3.0~16.0	140	40	40	105	-	52	HC16	M18	15,000	2.8	3.1	●
	HSK100A-GSK25-155	16.0~25.0	155	55	55	120	-	64	HC25	M28	15,000	3.6	4.0	●

(Unit : mm)

Accessories

SPARE PART	Type	Accessories	
		Coolant Tube for HSK	Wrench
	Images		
	Designation		
	HSK63A	HSK63A-CNS	HSK63-WRENCH(C)
	HSK100A	HSK100A-CNS	HSK100-WRENCH(C)

Chuck
 Arbor/Modular
 Boring Tool
 Angular Head
 cBN/PCD
 Device&Accessory
 Standard

1:1 CHAT



SK-GSK

Great Speed Slim Type Collet Chuck



DIN69871 -1A/B	G2.5	20,000	Ø25	C	HC		
Shank	G value	Max RPM	Max Dia	Coolant System	HC Collet	Milling	Drilling

Fig.1

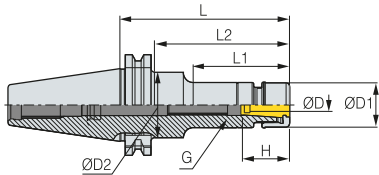

Fig.2

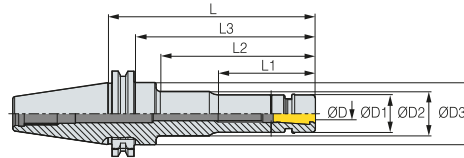
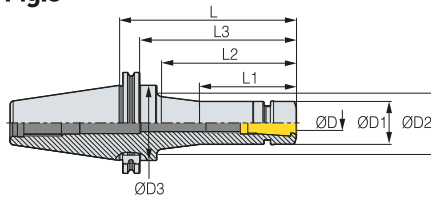

Fig.3



- : To be switched to NP order after stock depletion
- : Stock

C Internal coolant system is optional

※ Sealed collet is used when applying internal coolant

• For more information on product features, see **112P**

• For more information on the related parts, see **117P**

• For more information on the applicable collet, see **118P**

	Designation	ØD	L	ØD1	ØD2	ØD3	L1	L2	L3	H	Collet	G	RPM	Fig.	kg	Package Weight (kg)	Stock
SK40	SK40-GSK6-60	3.0~6.0	60	20	-	-	41	-	-	31	HC6	M8	20,000	1	0.8	1.0	●
	SK40-GSK6-90	3.0~6.0	90	20	45	-	48	71	-	31	HC6	M8	20,000	1	1.0	1.2	●
	SK40-GSK10-90	2.0~10.0	90	27	45	-	50	71	-	38	HC10	M12	20,000	1	1.1	1.3	●
	SK40-GSK10-150	2.0~10.0	150	27	32	45	70	112	131	38	HC10	M12	20,000	2	1.3	1.6	●
	SK40-GSK16-90	3.0~16.0	90	40	-	-	68	-	-	52	HC16	M18	20,000	1	1.2	1.4	●
	SK40-GSK16-150	3.0~16.0	150	40	45	-	114	118	-	52	HC16	M18	20,000	1	1.7	2.0	●
	SK40-GSK20-90	4.0~20.0	90	48	-	-	71	-	-	60	HC20	M22	20,000	1	1.3	1.5	●
	SK40-GSK25-90	16.0~25.0	90	55	-	-	71	-	-	64	HC25	M28	20,000	1	1.3	1.5	●
SK50	SK50-GSK6-105	3.0~6.0	105	20	70	-	60	86	-	31	HC6	M8	15,000	1	3.1	3.4	●
	SK50-GSK6-165	3.0~6.0	165	20	32	70	60	120	15	31	HC6	M8	15,000	2	3.3	3.7	●
	SK50-GSK10-105	2.0~10.0	105	27	70	-	65	86	-	38	HC10	M12	15,000	1	3.2	3.5	●
	SK50-GSK10-165	2.0~10.0	165	27	32	70	75	120	15	38	HC10	M12	15,000	2	3.4	3.8	●
	SK50-GSK16-105	3.0~16.0	105	40	70	-	65	86	-	52	HC16	M18	15,000	1	3.4	3.7	●
	SK50-GSK16-165	3.0~16.0	165	40	50	70	90	126	15	52	HC16	M18	15,000	3	3.9	4.3	●
	SK50-GSK20-105	4.0~20.0	105	48	70	-	65	86	-	60	HC20	M22	15,000	1	3.6	3.9	●
	SK50-GSK20-165	4.0~20.0	165	48	70	-	125	146	-	60	HC20	M22	15,000	1	4.3	4.7	●
	SK50-GSK25-105	16.0~25.0	105	55	70	-	65	86	-	64	HC25	M28	15,000	1	3.7	4.0	●
	SK50-GSK25-165	16.0~25.0	165	55	70	-	125	146	-	64	HC25	M28	15,000	1	4.6	5.0	●

(Unit : mm)

1:1 CHAT



GSK SPARE PART

Great Speed Slim Collet Chuck Related Parts



Main Components

SPARE PART	Type	Main Components		
	Images	Nut	Adjust Screw	Extraction Tool
	Designation			
	GSK6	GN6	BN0825	DSK-6CE
	GSK10	GN10	BN1230	DSK-10CE
	GSK13	GN13	BN1230(BT30) / BN1524F(ETC)	DSK-13CE
	GSK16	GN16	BN1830F	DSK-16CE
	GSK20	GN20	BN2230F	DSK-20CE
	GSK25	GN25	BN2838F	DSK-25CE

Accessories

SPARE PART	Spanner	Applicable Chuck	Spanner Designation
		GSK6	GSK6 SPANNER
		GSK10	GSK10 SPANNER
		GSK13	GSK13 SPANNER
		GSK16	GSK16 SPANNER
		GSK20	GSK20 SPANNER
		GSK25	GSK25 SPANNER

1:1 CHAT



BT-TSK

High Speed Slim Collet Chuck

MAS
403-BT

Shank

G2.5

G value

25,000

Max RPM

C

Coolant System



Milling



Drilling

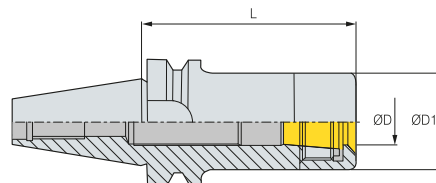

● : Stock

C Internal coolant system is optional

	Designation	ØD	L	ØD1	Collet	Package Weight (kg)	Stock
BT30	BT30-TSK10-60	2.0~10.0	60	27.5	HC10	0.9	●
	BT30-TSK10-90	2.0~10.0	90	27.5	HC10	1	●
	BT30-TSK10-120	2.0~10.0	120	27.5	HC10	1.3	●
	BT30-TSK16-60	3.0~16.0	60	40	HC16	1.2	●
	BT30-TSK16-90	3.0~16.0	90	40	HC16	1.4	●
	BT30-TSK16-120	3.0~16.0	120	40	HC16	1.5	●
BT40	BT40-TSK10-90	2.0~10.0	90	27.5	HC10	1.2	●
	BT40-TSK16-90	3.0~16.0	90	40	HC16	1.5	●

(Unit : mm)

1:1 CHAT



HC COLLET

HC Slim Collet (General Type)



General
5 μ m

Run-out



HC Collet

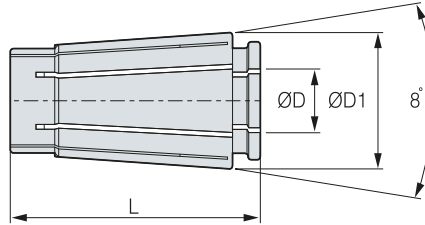

● : Stock

	Designation	ØD	L	ØD1	Accuracy	Stock
HC6	HC6-3.0	3.0	25.0	10.5	5 μ m	●
	HC6-4.0	4.0	25.0	10.5	5 μ m	●
	HC6-5.0	5.0	25.0	10.5	5 μ m	●
	HC6-6.0	6.0	25.0	10.5	5 μ m	●
HC10	HC10-2.0	2.0	30.5	15.6	5 μ m	●
	HC10-3.0	3.0	30.5	15.6	5 μ m	●
	HC10-4.0	4.0	30.5	15.6	5 μ m	●
	HC10-5.0	5.0	30.5	15.6	5 μ m	●
	HC10-6.0	6.0	30.5	15.6	5 μ m	●
	HC10-7.0	7.0	30.5	15.6	5 μ m	●
	HC10-8.0	8.0	30.5	15.6	5 μ m	●
	HC10-9.0	9.0	30.5	15.6	5 μ m	●
	HC10-10.0	10.0	30.5	15.6	5 μ m	●
	HC13	HC13-3.0	3.0	39.0	20.1	5 μ m
HC13-4.0		4.0	39.0	20.1	5 μ m	●
HC13-5.0		5.0	39.0	20.1	5 μ m	●
HC13-6.0		6.0	39.0	20.1	5 μ m	●
HC13-7.0		7.0	39.0	20.1	5 μ m	●
HC13-8.0		8.0	39.0	20.1	5 μ m	●
HC13-9.0		9.0	39.0	20.1	5 μ m	●
HC13-10.0		10.0	39.0	20.1	5 μ m	●
HC13-11.0		11.0	39.0	20.1	5 μ m	●
HC13-12.0		12.0	39.0	20.1	5 μ m	●
HC13-13.0		13.0	39.0	20.1	5 μ m	●
HC16		HC16-3.0	3.0	45.0	24.6	5 μ m
	HC16-4.0	4.0	45.0	24.6	5 μ m	●
	HC16-5.0	5.0	45.0	24.6	5 μ m	●
	HC16-6.0	6.0	45.0	24.6	5 μ m	●
	HC16-7.0	7.0	45.0	24.6	5 μ m	●
	HC16-8.0	8.0	45.0	24.6	5 μ m	●
	HC16-9.0	9.0	45.0	24.6	5 μ m	●
	HC16-10.0	10.0	45.0	24.6	5 μ m	●
	HC16-11.0	11.0	45.0	24.6	5 μ m	●
	HC16-12.0	12.0	45.0	24.6	5 μ m	●
	HC16-13.0	13.0	45.0	24.6	5 μ m	●
	HC16-14.0	14.0	45.0	24.6	5 μ m	●
	HC16-15.0	15.0	45.0	24.6	5 μ m	●
	HC16-16.0	16.0	45.0	24.6	5 μ m	●

(Unit : mm)

	Designation	ØD	L	ØD1	Accuracy	Stock	
HC20	HC20-4.0	4.0	54.3	29.2	5 μ m	●	
	HC20-6.0	6.0	54.3	29.2	5 μ m	●	
	HC20-8.0	8.0	54.3	29.2	5 μ m	●	
	HC20-10.0	10.0	54.3	29.2	5 μ m	●	
	HC20-12.0	12.0	54.3	29.2	5 μ m	●	
	HC20-14.0	14.0	54.3	29.2	5 μ m	●	
	HC20-16.0	16.0	54.3	29.2	5 μ m	●	
	HC20-18.0	18.0	54.3	29.2	5 μ m	●	
	HC20-20.0	20.0	54.3	29.2	5 μ m	●	
	HC25	HC25-16.0	16.0	57.0	35.7	5 μ m	●
HC25-17.0		17.0	57.0	35.7	5 μ m	●	
HC25-18.0		18.0	57.0	35.7	5 μ m	●	
HC25-19.0		19.0	57.0	35.7	5 μ m	●	
HC25-20.0		20.0	57.0	35.7	5 μ m	●	
HC25-21.0		21.0	57.0	35.7	5 μ m	●	
HC25-22.0		22.0	57.0	35.7	5 μ m	●	
HC25-23.0		23.0	57.0	35.7	5 μ m	●	
HC25-24.0		24.0	57.0	35.7	5 μ m	●	
HC25-25.0		25.0	57.0	35.7	5 μ m	●	

(Unit : mm)

Order Example · General Type – Order as HC16-8.0 · Precision Type – Order as HC16-8.0P

※ Please contact us for items not in the catalog.

1:1 CHAT



HC COLLET

HC Slim Collet (General Type)



Precision
3 μ m

Run-out



HC Collet

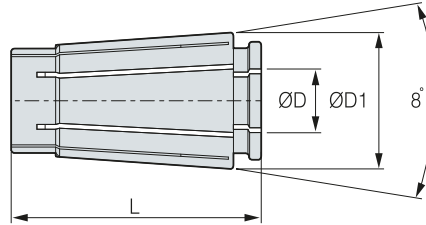

● : Stock

	Designation	ØD	L	ØD1	Accuracy	Stock	
HC6(P)	HC6-3.0P	3.0	25.0	10.5	3 μ m	●	
	HC6-4.0P	4.0	25.0	10.5	3 μ m	●	
	HC6-5.0P	5.0	25.0	10.5	3 μ m	●	
	HC6-6.0P	6.0	25.0	10.5	3 μ m	●	
HC10(P)	HC10-2.0P	2.0	30.5	15.6	3 μ m	●	
	HC10-3.0P	3.0	30.5	15.6	3 μ m	●	
	HC10-4.0P	4.0	30.5	15.6	3 μ m	●	
	HC10-5.0P	5.0	30.5	15.6	3 μ m	●	
	HC10-6.0P	6.0	30.5	15.6	3 μ m	●	
	HC10-7.0P	7.0	30.5	15.6	3 μ m	●	
	HC10-8.0P	8.0	30.5	15.6	3 μ m	●	
	HC10-9.0P	9.0	30.5	15.6	3 μ m	●	
	HC10-10.0P	10.0	30.5	15.6	3 μ m	●	
	HC13(P)	HC13-3.0P	3.0	39.0	20.1	3 μ m	●
HC13-4.0P		4.0	39.0	20.1	3 μ m	●	
HC13-5.0P		5.0	39.0	20.1	3 μ m	●	
HC13-6.0P		6.0	39.0	20.1	3 μ m	●	
HC13-7.0P		7.0	39.0	20.1	3 μ m	●	
HC13-8.0P		8.0	39.0	20.1	3 μ m	●	
HC13-9.0P		9.0	39.0	20.1	3 μ m	●	
HC13-10.0P		10.0	39.0	20.1	3 μ m	●	
HC13-11.0P		11.0	39.0	20.1	3 μ m	●	
HC13-12.0P		12.0	39.0	20.1	3 μ m	●	
HC13-13.0P		13.0	39.0	20.1	3 μ m	●	
HC16(P)		HC16-3.0P	3.0	45.0	24.6	3 μ m	●
		HC16-4.0P	4.0	45.0	24.6	3 μ m	●
	HC16-5.0P	5.0	45.0	24.6	3 μ m	●	
	HC16-6.0P	6.0	45.0	24.6	3 μ m	●	
	HC16-7.0P	7.0	45.0	24.6	3 μ m	●	
	HC16-8.0P	8.0	45.0	24.6	3 μ m	●	
	HC16-9.0P	9.0	45.0	24.6	3 μ m	●	
	HC16-10.0P	10.0	45.0	24.6	3 μ m	●	
	HC16-11.0P	11.0	45.0	24.6	3 μ m	●	
	HC16-12.0P	12.0	45.0	24.6	3 μ m	●	
	HC16-13.0P	13.0	45.0	24.6	3 μ m	●	
	HC16-14.0P	14.0	45.0	24.6	3 μ m	●	
	HC16-15.0P	15.0	45.0	24.6	3 μ m	●	
HC16-16.0P	16.0	45.0	24.6	3 μ m	●		

(Unit : mm)

● : To be switched to NP order after stock depletion

	Designation	ØD	L	ØD1	Accuracy	Stock
HC20(P)	HC20-4.0P	4.0	54.3	29.2	3 μ m	●
	HC20-6.0P	6.0	54.3	29.2	3 μ m	●
	HC20-8.0P	8.0	54.3	29.2	3 μ m	●
	HC20-10.0P	10.0	54.3	29.2	3 μ m	●
	HC20-12.0P	12.0	54.3	29.2	3 μ m	●
	HC20-14.0P	14.0	54.3	29.2	3 μ m	●
	HC20-16.0P	16.0	54.3	29.2	3 μ m	●
	HC20-18.0P	18.0	54.3	29.2	3 μ m	●
	HC20-20.0P	20.0	54.3	29.2	3 μ m	●
	HC25(P)	HC25-16.0P	16.0	57.0	35.7	3 μ m
HC25-17.0P		17.0	57.0	35.7	3 μ m	
HC25-18.0P		18.0	57.0	35.7	3 μ m	
HC25-19.0P		19.0	57.0	35.7	3 μ m	
HC25-20.0P		20.0	57.0	35.7	3 μ m	●
HC25-21.0P		21.0	57.0	35.7	3 μ m	
HC25-22.0P		22.0	57.0	35.7	3 μ m	
HC25-23.0P		23.0	57.0	35.7	3 μ m	
HC25-24.0P		24.0	57.0	35.7	3 μ m	
HC25-25.0P		25.0	57.0	35.7	3 μ m	●

(Unit : mm)

Order example · General Type – Order as HC16-8.0 · Precision Type – Order as HC16-8.0P

※ Please contact us for items not in the catalog.

1:1 CHAT



BT-NPU

Drill Chuck



MAS
403-BT

Shank

C

Coolant System



Drilling

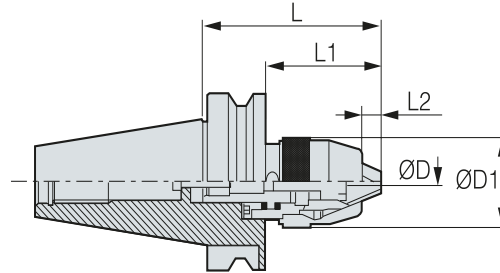

• ● : Stock

⚠ This product does not support the internal coolant system

• For more information on the related parts, see **122P**

	Designation	ØD	L	ØD1	L1	L2	kg	Package Weight (kg)	Stock
BT30	BT30-NPU8-97	1~8	97	38	75	8	0.8	0.9	●
	BT30-NPU13-125	1~13	125	50	103	12	1.4	1.6	●
BT40	BT40-NPU8-87	1~8	87	38	60	8	1.2	1.4	●
	BT40-NPU13-105	1~13	105	50	78	12	1.6	1.9	●
	BT40-NPU13-130	1~13	130	50	103	12	1.9	2.2	●
BT50	BT50-NPU13-130	1~13	130	50	92	12	4.5	4.9	●
	BT50-NPU13-190	1~13	190	50	152	12	5.3	5.7	●

(Unit : mm)

1:1 CHAT



HSK-NPU

Drill Chuck



DIN 69893-1

Shank

C

Coolant System



Drilling

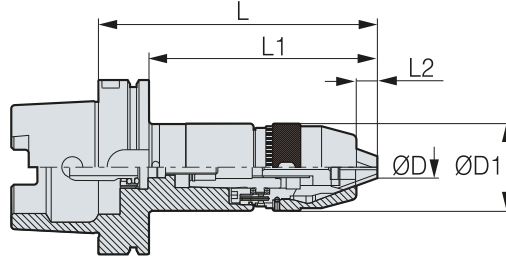

● : Stock

C This product does not support the internal coolant system

• For more information on the related parts, see [122P](#)

	Designation	ØD	L	ØD1	L1	L2	kg	Package Weight (kg)	Stock
HSK63A	HSK63A-NPU13-175	1-13	175	50	149	12	2.4	2.6	●
HSK100A	HSK100A-NPU13-180	1-13	180	50	151	12	3.6	4.0	●

(Unit : mm)

1:1 CHAT



SK-NPU

Drill Chuck



DIN69871 -1A/B

Shank

C

Coolant System



Drilling

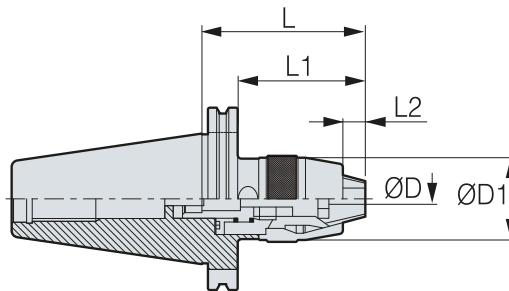

● : Stock

C This product does not support the internal coolant system

• For more information on the related parts, see [122P](#)

	Designation	ØD	L	ØD1	L1	L2	kg	Package Weight (kg)	Stock
SK40	SK40-NPU13-105	1-13	105	50	78	12.5	1.6	1.8	●
SK50	SK50-NPU13-111	1-13	111	50	84	12.5	3.6	3.9	●

(Unit : mm)

Chuck

Arbor/Modular

Boring Tool

Angular Head

cBN/PCD

Device&Accessory



Standard



NPU SPARE PART

Drill Chuck Related Parts



SPARE PART	Type	Main Components		Accessories
	Images	Drill Chuck Head	Bolt	Spanner
		Designation		
				
	NPU8	NPU8	BX0620	NPU0836
	NPU13	NPU13	BX0825	NPU1348

1:1 CHAT



BT-TNPU

Drill Chuck



MAS 403-BT

Shank



Coolant System



Drilling

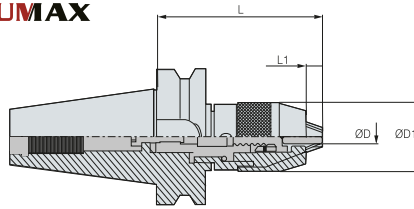

● : Stock

C This product does not support the internal coolant system

	Designation	ØD	ØD1	L	L1	Package Weight (kg)	Stock
BT30	BT30-TNPU08-75	0.3-8	38	84.5	7.5	0.7	●
BT40	BT40-TNPU08-80	0.3-8	38	87.5	7.5	1.3	●
	BT40-TNPU13-90	0.3-13	50	102.5	12.5	1.7	●
	BT40-TNPU13-130	0.3-13	50	142.5	12.5	2.2	●
BT50	BT50-TNPU13-110	0.3-13	50	122.5	12.5	4.4	●
	BT50-TNPU13-130	0.3-13	50	142.5	12.5	4.7	●
	BT50-TNPU13-190	0.3-13	50	202.5	12.5	5.4	●

* Min. tool insertion depth

- TNPU08 : 20mm or above / - TNPU13 : 30mm or above

(Unit : mm)

1:1 CHAT



SK-THPU

Hex Key Drill Chuck

NEW



MAS 403-BT

Shank



Coolant System



Drilling

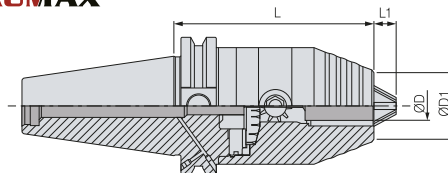

● : Stock

C This product does not support the internal coolant system

	Designation	ØD	ØD1	L	L1	Package Weight (kg)	Stock
SK40	SK40-THPU13-90	0.3-13	50	90	11	1.5	●
	SK40-THPU16-95	1.5-16	50	95	9	1.6	●
SK50	SK50-THPU13-90	0.3-13	50	90	11	4.0	●
	SK50-THPU16-95	1.5-16	50	95	9	4.0	●

* Min. tool insertion depth

- THPU13 : 30mm or above / - THPU16 : 40mm or above

(Unit : mm)

SPARE PART	Type	Accessories
	Images	
	Designation	
	SK40	THPUTW-6
	SK50	THPUTW-6

1:1 CHAT



DTN

Tapping Holder



Coolant System



Tapping



Features

- Quick and convenient modular tool change using exclusive adapter
- Increased tap life in general machining center through the tension function
- Tapping range : M3-M38

NAMING

BT40	DTN	22	130
Spindle	Tapping Holder	Tapping Range	Length

Easy TCA (Tap Adapter) Change

- One-touch-replaceable adapter with high-precision level and long lifespan
- Quick exchange of tabs for each diameter and applicable for various machining
- Enables tensile contraction using the axial direction floating method

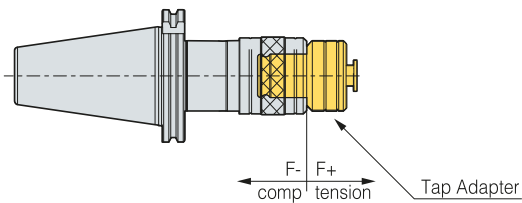

How to Tighten

TCA Insertion

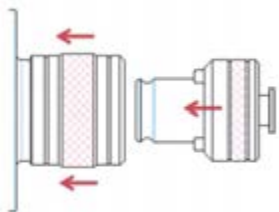

1. Insert TCA after pressing the tap holder cover down
2. Connect TCA to be aligned with the key groove and press it until the sound "click" is heard.

TCA Mounting

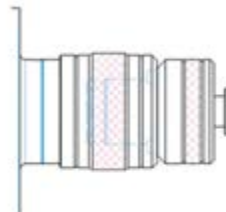

1. The tap holder cover is put in the normal position.

TCA Removal

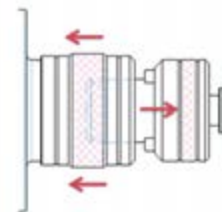

1. Remove TCA after pressing the tap holder cover.

※ DTN12, DTN22 : Remove them by pulling the sliding ring down. ※ DTN38 : Remove it by pulling the adapter forward.

1:1 CHAT



BT-DTN

Tapping Holder



MAS 403-BT

Shank

C

Coolant System



Tapping

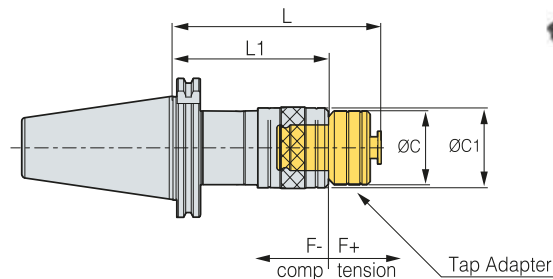

• ● : Stock

C This product does not support the internal coolant system

• For more information on product features, see **124P**

• For more information on the applicable adapter, see **127P**

	Designation	Tap Size	ØC	L	ØC1	L1	Adapter Used	F-	F+	kg	Package Weight(kg)	Stock
BT30	BT30-DTN12-85	M3-M12	32	85	39	60	TCA1-M	4	10	0.5	0.7	●
BT40	BT40-DTN12-90	M3-M12	32	90	39	65	TCA1-M	4	10	1.2	1.4	●
	BT40-DTN12-120	M3-M12	32	120	39	95	TCA1-M	4	10	1.5	1.7	●
	BT40-DTN22-130	M8-M24	50	130	56	96	TCA2-M	12.5	12.5	1.7	1.9	●
	BT40-DTN22-160	M8-M24	50	160	56	126	TCA2-M	12.5	12.5	2.2	2.4	●
BT50	BT50-DTN12-100	M3-M12	32	100	39	75	TCA1-M	4	10	3.9	4.2	●
	BT50-DTN12-130	M3-M12	32	130	39	105	TCA1-M	4	10	3.9	4.3	●
	BT50-DTN22-140	M8-M24	50	140	56	106	TCA2-M	12.5	12.5	4.3	4.7	●
	BT50-DTN22-170	M8-M24	50	170	56	136	TCA2-M	12.5	12.5	4.7	5.1	●
	BT50-DTN38-185	M16-M38	72	185	81	140	TCA3-M	20	20	5.7	6.1	●
	BT50-DTN38-215	M16-M38	72	215	81	170	TCA3-M	20	20	6.7	7.1	●

(Unit : mm)

Chuck

Arbor/Modular

Boring Tool

Angular Head

cBN/PCD

Device&Accessory

Standard

1:1 CHAT



S-DTN

Straight Shank Tapping Holder



Coolant System



Tapping

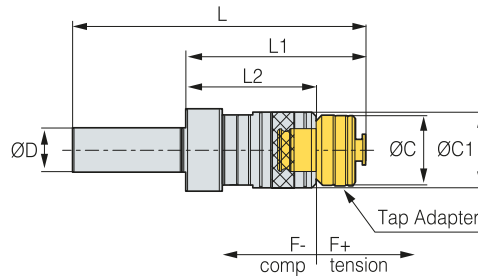

• ● : Stock

☐ This product does not support the internal coolant system

• For more information on product features, see [124P](#)

• For more information on the applicable adapter, see [127P](#)

	Designation	Tapping Range	ØC	ØD	L	ØC1	L1	L2	Adapter Used	F-	F+	kg	Package Weight (kg)	Stock
S32	S32-DTN12-90	M3-M12	32	32	170	39	90	65	TCA1	4	10	1.0	1.1	●
	S32-DTN22-130	M8-M24	50	32	210	56	130	96	TCA2	12.5	12.5	1.8	1.9	●

(Unit : mm)

1:1 CHAT



SK-DTN

Tapping Holder



Shank



Coolant System



Tapping

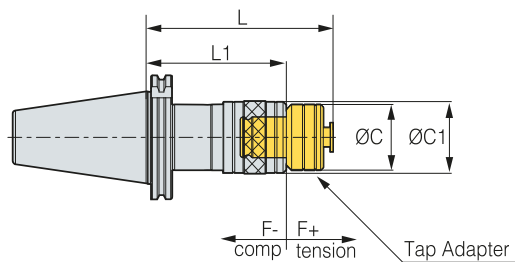

• ● : Stock

☐ This product does not support the internal coolant system

• For more information on product features, see [124P](#)

• For more information on the applicable adapter, see [127P](#)

	Designation	Tap Size	ØC	L	ØC1	L1	Adapter Used	F-	F+	kg	Package Weight (kg)	Stock
SK40	SK40-DTN12-90	M3-M12	32	90	39	65	TCA1-M	4	10	1.0	1.2	●
	SK40-DTN22-130	M8-M22	50	130	56	96	TCA2-M	12.5	12.5	1.6	1.8	●
SK50	SK50-DTN12-100	M3-M12	32	100	39	75	TCA1-M	4	10	2.9	3.2	●
	SK50-DTN22-140	M8-M22	50	140	56	106	TCA2-M	12.5	12.5	3.5	3.9	●

(Unit : mm)

1:1 CHAT



TCA

Tap Adapter



Coolant System



Tapping

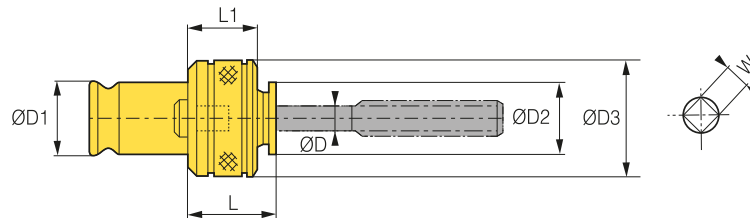

● : Stock

C This product does not support the internal coolant system

※ DIN standards can be made to order

• For more information on product features, see **124P**

	Designation	ØD	L	ØD1	L1	ØD2	ØD3	W	kg	Package Weight (kg)	Stock
TCA1	TCA1-M3	4	27	19	25	19	32	3	0.2	0.2	●
	TCA1-M4	5	27	19	25	19	32	4	0.2	0.2	●
	TCA1-M5	6	27	19	25	19	32	4	0.2	0.2	●
	TCA1-M6	6	27	19	25	19	32	4	0.2	0.2	●
	TCA1-M8	6.2	27	19	25	19	32	5	0.2	0.2	●
	TCA1-M10	7	27	19	25	19	32	6	0.2	0.2	●
	TCA1-M11	8	27	19	25	19	32	6	0.2	0.2	●
TCA1-M12	9	27	19	25	19	32	7	0.2	0.2	●	
TCA2	TCA2-M8	6.2	34	31	31	29	50	5	0.5	0.5	●
	TCA2-M10	7	34	31	31	29	50	6	0.5	0.5	●
	TCA2-M12	8.5	34	31	31	29	50	7	0.5	0.5	●
	TCA2-M14	11	34	31	31	29	50	8	0.5	0.5	●
	TCA2-P1/4	11	34	31	31	29	50	9	0.5	0.5	●
	TCA2-M16	13	34	31	31	29	50	10	0.5	0.5	●
	TCA2-M18	14	34	31	31	29	50	11	0.5	0.5	●
	TCA2-M20	15	34	31	31	29	50	12	0.5	0.5	●
	TCA2-M22	17	34	31	31	29	50	13	0.5	0.5	●
	TCA2-P1/2	18	34	31	31	29	50	14	0.5	0.5	●
	TCA2-M24	19	34	31	31	29	50	15	0.5	0.5	●
TCA3	TCA3-M16	13	45	48	41	44	72	10	1.4	1.6	●
	TCA3-M18	14	45	48	41	44	72	11	1.4	1.6	●
	TCA3-M20	15	45	48	41	44	72	12	1.4	1.6	●
	TCA3-M22	17	45	48	41	44	72	13	1.4	1.6	●
	TCA3-M24	19	45	48	41	44	72	15	1.4	1.6	●
	TCA3-M27	20	45	48	41	44	72	15	1.4	1.6	●
	TCA3-M30	23	45	48	41	44	72	17	1.4	1.6	●
	TCA3-M33	25	45	48	41	44	72	19	1.4	1.6	●
TCA3-M36	28	45	48	41	44	72	21	1.4	1.6	●	

(Unit : mm)

1:1 CHAT



DST PAT.

High Speed Synchro Tapping Chuck



Coolant System



TER Collet



Tapping



Features

- Optimized floating design allows for the highest high-speed tap machinability
- Design for minimizing synchronous error (when using the MCT TAP rigid function)
- Internal coolant applicable
- Tapping range : M1 – M22

NAMING

BT40	DST	22	110
Spindle	Tapping Holder	Tapping Range	Length

Precise Machining

Machining Range Expanded

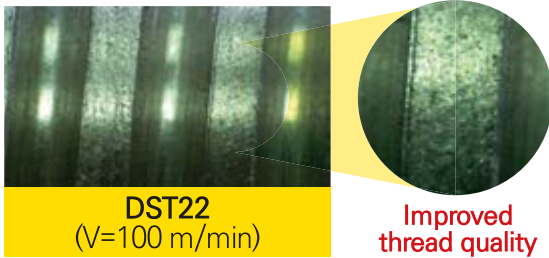

M1.4x0.3 Service Life Test

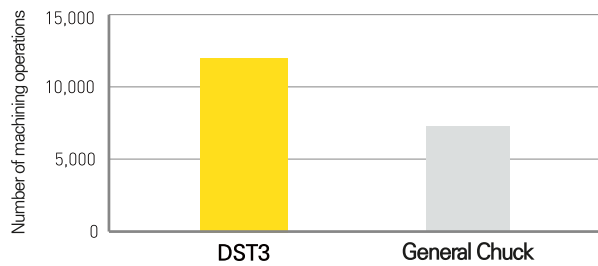

Increased Tool Service Life versus Collet Chuck Use

Tapping Dedicated Collet

- In the case of tapping, it is recommended to use TER collet
- DST3 : ER11 collet used



Comparison of Thread Shape

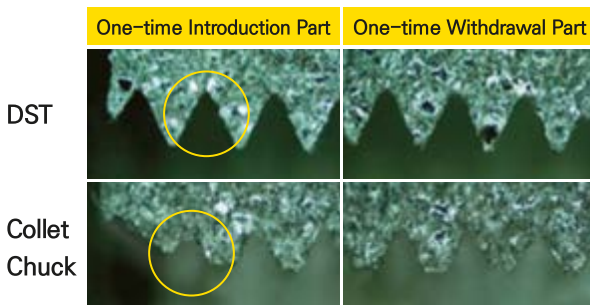

Synchro Tap Chuck (DST3)

Clean thread shape without collapse

General Collet Chuck

Collapsed thread due to no adjustment for synchro error

C Internal coolant system is optional

1:1 CHAT



BT-DST

High Speed Synchro Tapping Chuck

MAS
403-BT

Shank

C

Coolant System

TER

TER Collet

Tapping

Tapping

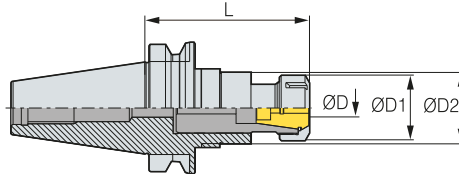

● : Stock

C Internal coolant system is optional

• For more information on product features, see [128P](#)• For more information on ER collet, see [100P](#)• For more information on TER collet, see [131P](#)

	Designation	ØD	L	ØD1	ØD2	Collet Used	F-	F+	kg	Package Weight (kg)	Stock
BT30	BT30-DST3-70	M1~M3	70	20	19	ER11	0.5	0.5	0.5	0.5	●
	BT30-DST10-100	M3~M10	100	40.4	28	TER16	0.5	0.5	0.8	0.9	●
BT40	BT40-DST3-70	M1~M3	70	20	19	ER11	0.5	0.5	1.0	1.1	●
	BT40-DST10-100	M3~M10	100	40.4	28	TER16	0.5	0.5	1.3	1.4	●
	BT40-DST22-110	M6~M22	110	60	50	TER32	0.7	0.7	1.7	2.0	●
BT50	BT50-DST10-110	M3~M10	110	60	50	TER16	0.5	0.5	3.8	4.1	●
	BT50-DST22-130	M6~M22	130	60	50	TER32	0.7	0.7	4.5	4.9	●

(Unit : mm)

1:1 CHAT



HSK-DST

High Speed Synchro Tapping Chuck

DIN
69893-1

Shank

C

Coolant System

TER

TER Collet

Tapping

Tapping

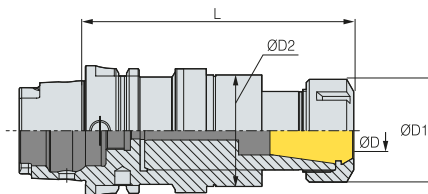

● : Stock

C Internal coolant system is optional

• For more information on product features, see [128P](#)• For more information on ER collet, see [100P](#)• For more information on TER collet, see [131P](#)• For more information on Internal coolant system, see [130P](#)

	Designation	ØD	L	ØD1	ØD2	Collet Used	F-	F+	kg	Package Weight (kg)	Stock
HSK63A	HSK63A-DST3-80	M1~M3	80	19	20	ER11	0.5	0.5	0.7	0.8	●
	HSK63A-DST10-100	M3~M10	100	28	40.4	TER16	0.5	0.5	0.9	1.2	●
	HSK63A-DST22-130	M6~M22	130	49.5	60	TER32	0.7	0.7	1.8	2.0	●

(Unit : mm)

1:1 CHAT



SK-DST

High Speed Synchro Tapping Chuck

DIN69871
-1A/B

Shank

C

Coolant System

Tapping

TER Collet

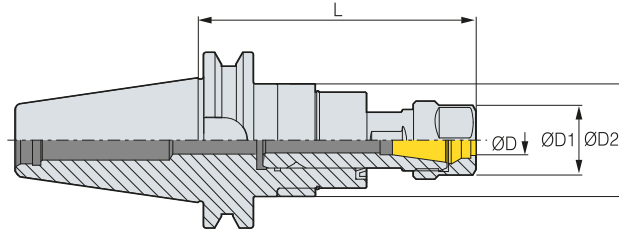

• ● : Stock

☐ Internal coolant system is optional

• For more information on product features, see **128P**• For more information on ER collet, see **100P**• For more information on TER collet, see **131P**

	Designation	ØD	L	ØD1	ØD2	Collet Used	F-	F+	kg	Package Weight (kg)	Stock
SK30	SK30-DST3-70	M1~M3	70	19	20	ER11	0.2	0.2	0.4	0.5	●
SK40	SK40-DST3-70	M1~M3	70	19	20	ER11	0.2	0.2	0.9	1.0	
	SK40-DST10-110	M3~M10	110	28	35	TER16	0.5	0.5	1.2	1.4	●
	SK40-DST22-120	M6~M22	120	50	54	TER32	0.7	0.7	1.8	2.1	●
SK50	SK50-DST10-110	M3~M10	110	28	35	TER16	0.5	0.5	3.0	3.3	●
	SK50-DST22-120	M6~M22	120	50	54	TER32	0.7	0.7	3.7	4.1	●

(Unit : mm)

1:1 CHAT



DST SPARE PART

High Speed Synchro Tapping Chuck Related Parts

SPARE PART	Type	Main Components		Accessories			Type	Accessories	
		Nut		Spanner		ER/TER		Coolant Tube for HSK	Wrench
	Images								
	Designation	DST3	DST10	S-17	S-25	GERC11/ER11-ØD	HSK50A	HSK50-WRENCH(C)	
							HSK63A	HSK63-WRENCH(C)	
							HSK100A	HSK100-WRENCH(C)	

1:1 CHAT



TER

TER Collet



TER Collet

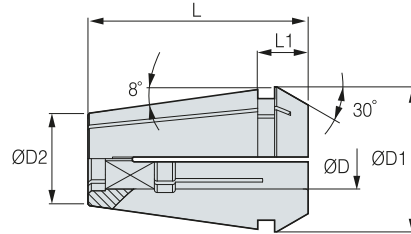
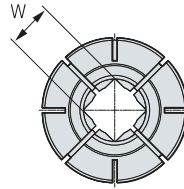

● : Stock

※ Waterproof type tapping is possible by using RTJW and RUT nuts (standard dimension only)

	Designation	Tap Applied	ØD	L	W	ØD1	ØD2	L1	kg	Package Weight (kg)	Stock
TER16	TER16-4x3.2	M3	4	27.5	3.2	16.74	10.1	6.3	0.03	0.03	●
	TER16-5x4	M4	5	27.5	4	16.74	10.1	6.3	0.03	0.03	●
	TER16-5.5x4.5	M5	5.5	27.5	4.5	16.74	10.1	6.3	0.02	0.02	●
	TER16-6x4.5	M6,U1/4	6	27.5	4.5	16.74	10.1	6.3	0.02	0.02	●
	TER16-6.2x5	M7, M8	6.2	27.5	5	16.74	10.1	6.3	0.02	0.02	●
	TER16-7x5.5	M9, M10, U3/8	7	27.5	5.5	16.74	10.1	6.3	0.02	0.02	●
TER20	TER20-5x4	M4	5	31.5	4	20.74	13.2	7.2	0.05	0.05	●
	TER20-5.5x4.5	M5	5.5	31.5	4.5	20.74	13.2	7.2	0.05	0.05	●
	TER20-6x4.5	M6,U1/4	6	31.5	4.5	20.74	13.2	7.2	0.05	0.05	●
	TER20-6.2x5	M7, M8	6.2	31.5	5	20.74	13.2	7.2	0.04	0.04	●
	TER20-7x5.5	M9, M10, U3/8	7	31.5	5.5	20.74	13.2	7.2	0.05	0.05	●
	TER20-8x6	M11, U7/16, P1/8	8	31.5	6	20.74	13.2	7.2	0.04	0.04	●
TER25	TER25-5x4	M4	5	34	4	25.74	17.6	7.5	0.9	0.9	●
	TER25-5.5x4.5	M5	5.5	34	4.5	25.74	17.6	7.5	0.8	0.8	●
	TER25-6x4.5	M6	6	34	4.5	25.74	17.6	7.5	0.8	0.8	●
	TER25-6.2x5	M7, M8	6.2	34	5	25.74	17.6	7.5	0.1	0.1	●
	TER25-7x5.5	M9, M10, U3/8	7	34	5.5	25.74	17.6	7.5	0.8	0.8	●
	TER25-8.5x6.5	M12	8.5	34	6.5	25.74	17.6	7.5	0.8	0.8	●
TER32	TER32-6x4.5	M6,U1/4	6.2	40	4.5	32.74	23.1	8.2	0.2	0.2	●
	TER32-6.2x5	M7, M8	6.2	40	5	32.74	23.1	8.2	0.2	0.2	●
	TER32-7x5.5	M9, M10, U3/8	7	40	5.5	32.74	23.1	8.2	0.2	0.2	●
	TER32-8x6	M11, U7/16, P1/8	8	40	6	32.74	23.1	8.2	0.2	0.2	●
	TER32-8.5x6.5	M12	8.5	40	6.5	32.74	23.1	8.2	0.2	0.2	●
	TER32-10.5x8	M14, U9/16	10.5	40	8	32.74	23.1	8.2	0.2	0.2	●
	TER32-12.5x10	M16	12.5	40	10	32.74	23.1	8.2	0.2	0.2	●
	TER32-9x7	U1/2	9	40	7	32.74	23.1	8.2	0.2	0.2	●
	TER32-11x9	P1/4	11	40	9	32.74	23.1	8.2	0.2	0.2	●
	TER32-12x9	U5/8	12	40	9	32.74	23.1	8.2	0.2	0.2	●
	TER32-14x11	M18, P3/8	14	40	11	32.74	23.1	8.2	0.1	0.1	●
	TER32-15x12	M20	15	40	12	32.74	23.1	8.2	0.1	0.1	●
TER32-17x13	M22, U7/8	17	40	13	32.74	23.1	8.2	0.1	0.1	●	

(Unit : mm)

Chuck

Arbor/Modular

Boring Tool

Angular Head

cBN/PCD

Device&Accessory

Standard

1:1 CHAT



TEH

NEW

Tap Extension Holder



Coolant System



Tapping



Features

- Length-extending holder exclusive for tap when applying to the interference section
- Tool cost is reduced, and machining performance is improved compared to the use of long taps

NAMING

THE	230	D6	J	M6	C
Tap Extension Holder	Length	Shank Dia.	J : JIS NON : DIN	Tap Size	C : Coolant NON : None Coolant

Part Name

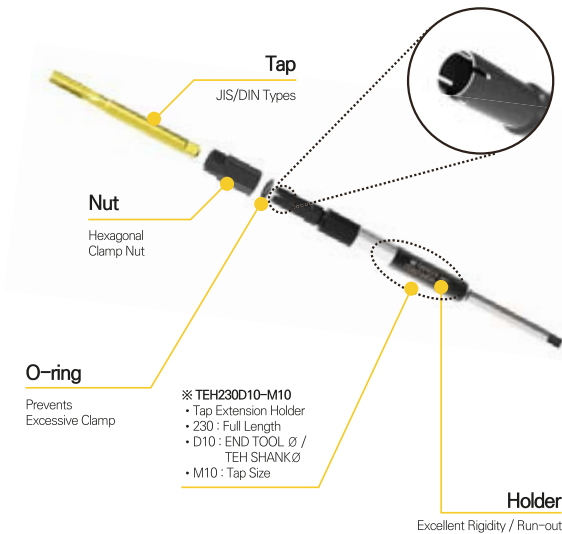

Processing of Deep Holes

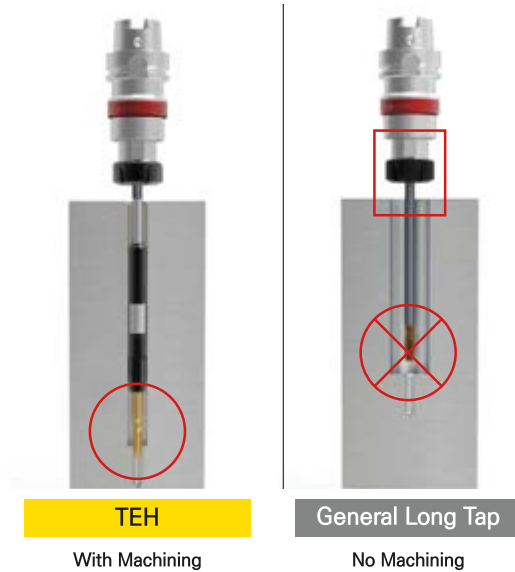

Total Length Comparison	Long Tap	TEH
M10	150mm	230mm
M22	200mm	330mm

※Since the full length is longer than that of the general long tap, it is favorable for processing narrow, deep holes.

TEH Setting Method



DST
High Speed Synchro Tapping Chuck

TER Collet

TEH
Tap Extension Holder

Tap
(M4-M22)

1:1 CHAT



TEH(SPEC/JIS)

NEW

Tap Extension Holder



Fig.1

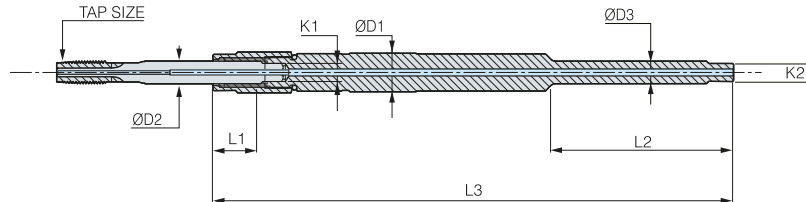
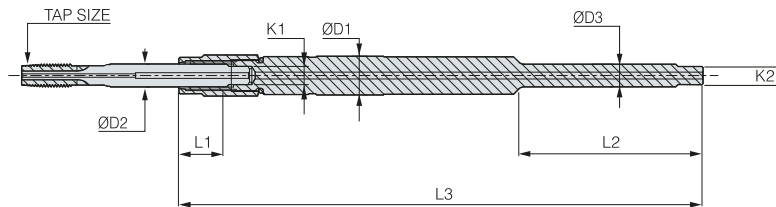

Fig.2



C Internal coolant system is basic

C This product does not support the internal coolant system
(Fig.2 Designation is non-coolant type)

• For more information on product features, see **132P**

	Designation (JIS Specifications)	Tap Size	L1	L2	L3	ØD1	ØD2	ØD3	K1	K2	Nut External Dia. Ø	Fig.	Stock	
TEH230	TEH230D5J-M4	M4	18	50	230	11	5	6	4	4.5	12.1	2		
	TEH230D6J-M6C	M6	18	50	230	12	6	6	4.5	4.5	13.3	1		
	TEH230D6.2J-M8C	M8	18	65	230	12	6.2	6.2	5	5	13.3	1		
	TEH230D7J-M10C	M10	18	65	230	13	7	7	5.5	5.5	14.4	1		
TEH330	TEH230D8.5J-M12C	M12	22	65	230	14	8.5	8.5	6.5	6.5	15.6	1		
	TEH330D10.5J-M14C	M14	25	70	330	16	10.5	10.5	8	8	17.9	1		
	TEH330D12.5J-M16C	M16	25	70	330	18	12.5	12.5	10	10	19.9	1		
	TEH330D14J-M18C	M18	25	70	330	20	14	14	11	11	21.9	1		
	TEH330D15J-M20C	M20	25	75	330	21	15	15	12	12	22.9	1		
	TEH330D17J-M22C	M22	25	75	330	23	17	17	13	13	25.9	1		

(Unit : mm)

Chuck
Arbor/Modular
Boring Tool
Angular Head
cBN/PCD
Device&Accessory
Standard

1:1 CHAT



TEH(SPEC/DIN) NEW

Tap Extension Holder



Coolant System

Tapping

Fig.1

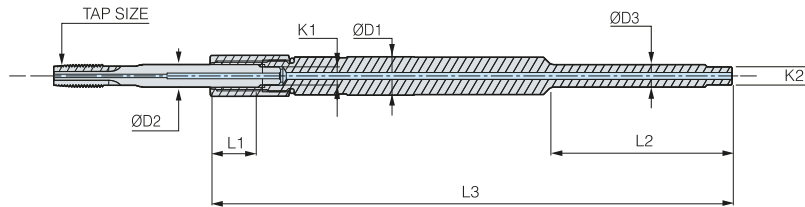
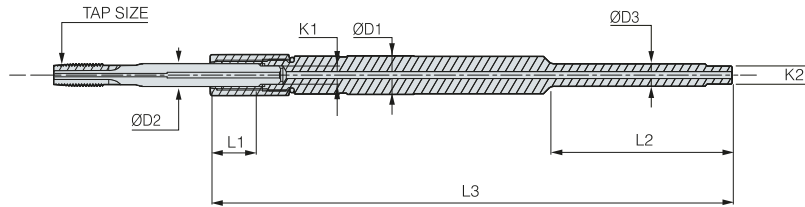

Fig.2



C Internal coolant system is basic

C This product does not support the internal coolant system
(Fig.2 Designation is non-coolant type)

• For more information on product features, see 132P

	Designation (DIN Specifications)	Tap Size	L1	L2	L3	ØD1	ØD2	ØD3	K1	K2	Nut External Dia. Ø	Fig.	Stock	
TEH230	TEH230D4.5-M4	M4	18	50	230	10	4.5	6	3.4	4.5	11.1	2		
	TEH230D6-M6C	M6	20	50	230	12	6	7	4.9	5.5	13.3	1		
	TEH230D8-M8C	M8	23	65	230	14	8	8	6.3	6.2	15.6	1		
	TEH230D10-M10C	M10	24	65	230	16	10	10	8	8	17.9	1		
	TEH230D9-M12C	M12	23	65	230	15	9	9	7	7	16.8	1		
TEH330	TEH330D11-M14C	M14	26	70	330	17	11	11	9	9	19.1	1		
	TEH330D12-M16C	M16	26	70	330	18	12	12	9	9	19.9	1		
	TEH330D14-M18C	M18	28	70	330	20	14	14	11	11	21.9	1		
	TEH330D16-M20C	M20	28	75	330	22	16	16	12	12	23.9	1		
	TEH330D18-M22C	M22	28	75	330	24	18	18	14.5	14.5	25.9	1		

(Unit : mm)

1:1 CHAT



STER PAT. NEW

DINE Synchro Tapping ER Collet



Features

- Floating function applicable for tap machining just by fastening the ER collet chuck
- Tap size can be converted just by replacing the connector
- Tap : M6~M16

NAMING

ST	ER	32	M6
Synchronizing Tapping Collet	Collet	Collet Size	Tapping Range

Details

STER32

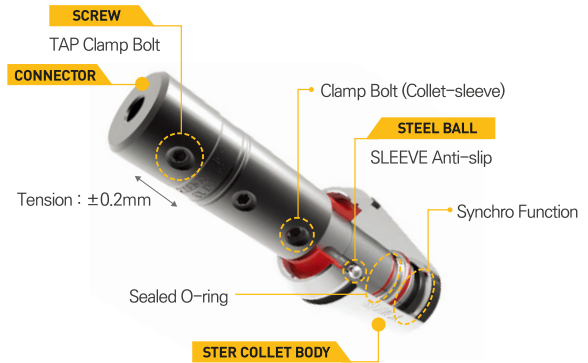

Detailed Specifications

Collet

Fig.1

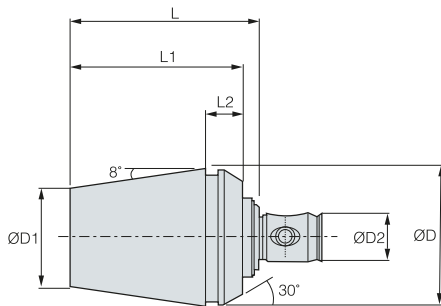

※ Collet

• ● : Stock

Designation	ØD	ØD1	ØD2	ØD3	L	L1	L2	Stock
STER32	32	23.1	11	11	44	40	8.2	●

(Unit : mm)

※ Connector

• ● : Stock

Designation	ØD	ØD1	ØD2	ØD3	L	H	W	Fig.	Stock
STER32C-M6	19	19	6	11	50	29.5	4.5	1	●
STER32C-M8	19	19	6.2	11	50	30	5	1	●
STER32C-M10	19	19	7	11	50	29	5.5	1	●
STER32C-M12	19	19	8.5	11	50	30.5	6.5	1	●
STER32C-M14	19	19	10.5	11	50	31	8	1	●
STER32C-M16	19	21	12.5	11	50	40.5	10	2	●

(Unit : mm)

Connector

Fig.1

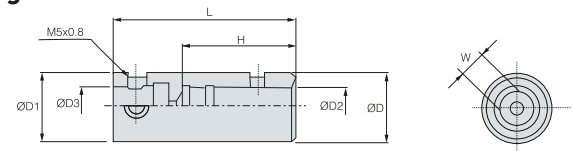
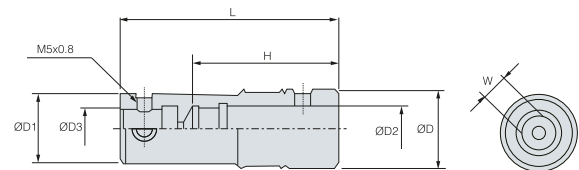

Fig.2



Part(Screw)

BTT0506F



BT0504



Part(Screw)

LW-2.5



Chuck

Arbor/Modular

Boring Tool

Angular Head

cBN/PCD

Device&Accessory

Standard

1:1 CHAT



BT-OFH

Floating Holder for Brush



MAS
403-BT

Shank

G6.3

G value

15,000

Max RPM

6mm

Sleeve

C

Coolant System



Deburring

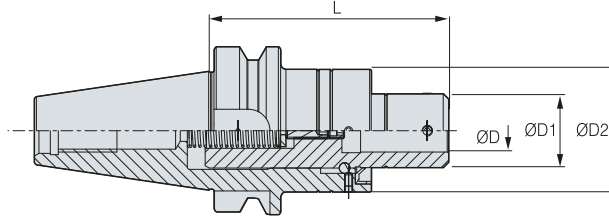

• • : Stock

C This product does not support the internal coolant system

	Designation	Sleeve Dia. (ØD)	L	ØD1	ØD2	Sleeve Stroke(F)	RPM	Stock
BT30	BT30-OFH6-75	6	75	19.7	38	6	15,000	•

(Unit : mm)

1:1 CHAT



ST-OFH

Floating Holder for Brush



G6.3

G value

15,000

Max RPM

6mm

Sleeve

C

Coolant System



Deburring

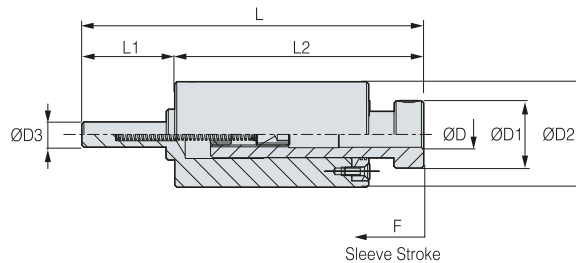

• • : Stock

C This product does not support the internal coolant system

	Designation	Sleeve Dia. (ØD)	L	ØD1	ØD2	ØD3	L1	L2	Sleeve Stroke(F)	RPM	Stock
ST06	ST06-OFH6-60	6	81	16	25	6	59	22	6	15,000	•

(Unit : mm)



Arbor/ Modular

DINE TOTAL TOOLING SOLUTION

SLA	138
TSLA	142
MTA	143
TMTA	143
FMA	144
TFMA	147
FMC	148
TFMC	152
TFMC-L	153
MD	154
TMD	161
EXT	162
RDC	162

1:1 CHAT



BT-SLA

Side Lock Arbor



MAS
403-BT
Shank

C
Coolant System

Milling

Drilling

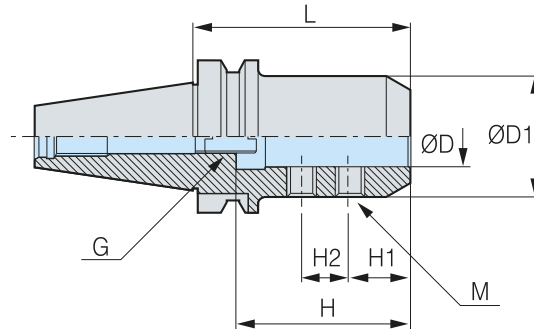

• ● : Stock

C Internal coolant system is basic

• For more information on the related parts, see **141P**

	Designation	ØD	L	ØD1	H	H1	H2	M	G	kg	Package Weight(kg)	Stock
BT30	BT30-SLA16-90	16	90	40	72	25	20	M10	M12	0.9	1.0	●
	BT30-SLA20-90	20	90	50	72	25	20	M12	M12	1.2	1.3	●
	BT30-SLA25-90	25	90	50	72	25	20	M12	M12	1.1	1.2	●
BT40	BT40-SLA16-90	16	90	40	72	25	20	M10	M12	1.4	1.6	●
	BT40-SLA20-90	20	90	50	72	25	20	M12	M12	1.8	2.0	●
	BT40-SLA25-90	25	90	50	72	25	20	M12	M12	1.6	1.8	●
	BT40-SLA32-90	32	90	60	82	25	25	M14	M12	1.8	2.0	●
	BT40-SLA32-105	32	105	60	82	25	25	M14	M12	2.0	2.3	●
BT50	BT40-SLA40-105	40	105	80	82	25	25	M16	M12	2.9	3.1	●
	BT50-SLA16-90	16	90	40	72	25	20	M10	M12	4.0	4.3	
	BT50-SLA20-105	20	105	50	72	25	20	M12	M12	4.4	4.7	●
	BT50-SLA25-105	25	105	50	72	25	20	M12	M12	4.3	4.6	●
	BT50-SLA25-135	25	135	50	72	25	20	M12	M12	4.6	4.9	
	BT50-SLA25-165	25	165	50	72	25	20	M12	M12	5.2	5.5	
	BT50-SLA32-105	32	105	60	82	25	25	M14	M12	4.5	4.8	●
	BT50-SLA32-135	32	135	60	82	25	25	M14	M12	5.1	5.4	
	BT50-SLA32-165	32	165	60	82	25	25	M14	M12	5.7	6.1	
	BT50-SLA40-105	40	105	90	82	25	25	M16	M12	6.1	6.4	●
	BT50-SLA40-150	40	150	90	82	25	25	M16	M12	8.1	8.5	
BT50-SLA42-105	42	105	90	82	25	25	M16	M12	5.9	6.2	●	

(Unit : mm)

1:1 CHAT



HSK-SLA

Side Lock Arbor



DIN 69893-1

Shank

C

Coolant System



Milling



Drilling

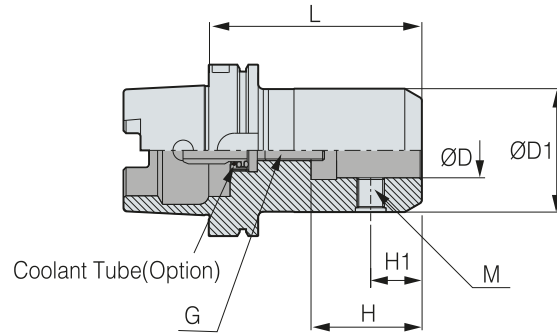

● : Stock

☐ Internal coolant system is optional

• For more information on the related parts, see **141P**

	Designation	ØD	L	ØD1	H	H1	M	G	kg	Package Weight(kg)	Stock
HSK63A	HSK63A-SLA20-100	20	100	52	51	25	M8	M12	1.6	1.8	●
	HSK63A-SLA25-105	25	105	65	59	25	M8	M12	2.1	2.4	●
	HSK63A-SLA32-105	32	105	72	63	30	M5	M12	2.3	2.6	●
HSK100A	HSK100A-SLA20-105	20	105	52	51	25	M16	M12	3.1	3.4	●
	HSK100A-SLA25-110	25	110	65	59	25	M18	M12	3.8	4.0	●
	HSK100A-SLA32-125	32	125	72	63	30	M20	M12	4.4	4.8	●
	HSK100A-SLA40-135	40	135	80	73	32	M20	M12	5.2	5.6	●

(Unit : mm)

Accessories

SPARE PART	Type	Accessories	
		Coolant Tube for HSK	Wrench
	Images		
	Designation		
	HSK63A	HSK63A-CNS	HSK63-WRENCH(C)
	HSK100A	HSK100A-CNS	HSK100-WRENCH(C)



SK-SLA

Side Lock Arbor



DIN69871
-1A/B

C



Shank

Coolant System

Milling

Drilling

Fig.1

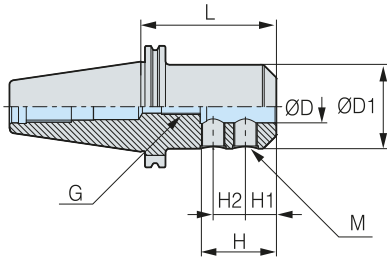
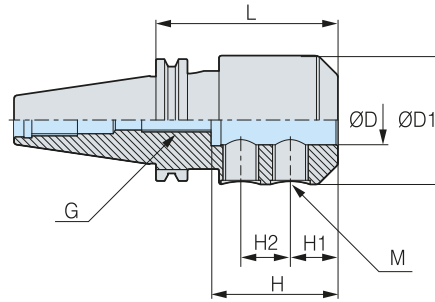

Fig.2



• ● : Stock

C Internal coolant system is basic

• For more information on the related parts, see **141P**

	Designation	ØD	L	ØD1	H	H1	H2	M	G	Fig.	kg	Package Weight(kg)	Stock
SK40	SK40-SLA16-75	16	75	48	49	24	-	M14	M12	1	1.4	1.6	●
	SK40-SLA20-75	20	75	52	51	25	-	M16	M12	1	1.5	1.7	●
	SK40-SLA25-95	25	95	65	59	24	25	M18	M12	2	2.1	2.4	●
	SK40-SLA32-105	32	105	72	63	24	28	M20	M12	2	2.8	2.9	●
SK50	SK50-SLA16-90	16	90	48	49	24	-	M14	M12	1	3.5	3.8	●
	SK50-SLA20-90	20	90	52	51	25	-	M16	M12	1	3.6	3.9	●
	SK50-SLA25-105	25	105	65	59	24	25	M18	M12	1	4.5	4.8	●
	SK50-SLA32-120	32	120	72	63	24	28	M20	M12	1	5.2	5.6	●
	SK50-SLA40-120	40	120	80	73	30	32	M20	M12	1	5.6	5.6	●

(Unit : mm)

1:1 CHAT



SLA SPARE PART

Side Lock Arbor Related Parts



Main Components

SPARE PART	Type	Main Components		
	Images	Set Screw		Adjust Screw
		BT Type	HSK / SK Type	
				
	Designation			
	SLA16	BT F1010	BT F1414 - 1.5	M1230C
	SLA20	BT F1212-1.5	BT F1616 - 1.5	M1230C
	SLA25	BT F1212-1.5	BT F1818 - 1.5	M1230C
	SLA32	BT F1414-1.5	BT F2020 - 1.5	M1230C
	SLA40	BT F1616-1.5	BT F2020 - 1.5	M1230C
	SLA42	BT F1624-1.5	BT F2020 - 1.5	M1230C

※ In the case of HSK types, adjustment screws may be different.

Accessories

SPARE PART	Type	Accessories	
	Images	Wrench	
		BT Type	HSK / SK Type
			
	Designation		
	SLA16	LW - 5	LW - 6
	SLA20	LW - 6	LW - 8
	SLA25	LW - 6	LW - 8
	SLA32	LW - 6	LW - 10
	SLA40	LW - 8	LW - 10
	SLA42	LW - 8	LW - 10

SPARE PART	Type	Accessories	
	Images	Coolant Tube for HSK	Wrench
			
	Designation		
	HSK63A	HSK63A-CNS	HSK63-WRENCH(C)
	HSK100A	HSK100A-CNS	HSK100-WRENCH(C)

1:1 CHAT



BT-TSLA

Side Lock Arbor



MAS
403-BT

C

Shank

Coolant System

Milling

Drilling

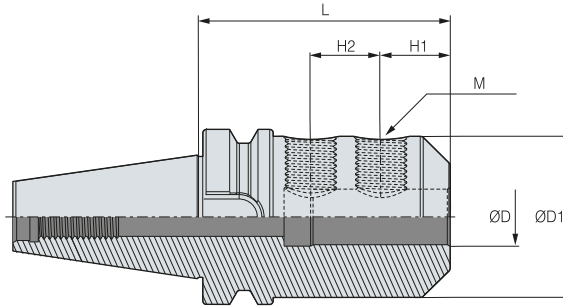

● : Stock

☐ Internal coolant system is optional

	Designation	ØD	L	ØD1	H1	H2	M	Package Weight(kg)	Stock
BT30	BT30-TSLA20-90	20	90	50	25	20	M12	1.3	●
	BT30-TSLA25-90	25	90	50	25	20	M12	1.8	●
BT40	BT40-TSLA16-100	16	100	40	25	20	M10	1.8	●
	BT40-TSLA20-100	20	100	50	25	20	M12	2.2	●
	BT40-TSLA25-90	25	90	50	25	20	M12	2.6	●
	BT40-TSLA32-100	32	100	60	25	25	M14	3.8	●
	BT40-TSLA40-105	40	105	70	25	25	M16	3.1	●
BT50	BT50-TSLA16-100	16	100	40	25	20	M10	3.8	●
	BT50-TSLA20-100	20	100	50	25	20	M12	4.0	●
	BT50-TSLA25-100	25	100	50	25	20	M12	4.8	●
	BT50-TSLA32-105	32	105	60	25	25	M14	5.1	●
	BT50-TSLA40-120	40	120	90	25	25	M16	6.1	●
	BT50-TSLA42-120	42	120	90	25	25	M16	5.8	●

(Unit : mm)

Set Screw

Designation	M	L	W
TSLN-M10*16	M10	16	5
TSLN-M16*16	M16	16	8
TSLN-M16*10	M16	10	8

(Unit : mm)

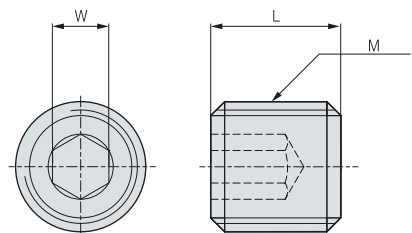

1:1 CHAT



SK-MTA

Morse Taper Arbor

DIN69871
-1A/B

Shank

C

Coolant System



Drilling



Reaming



Fig.1

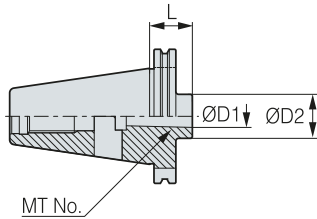
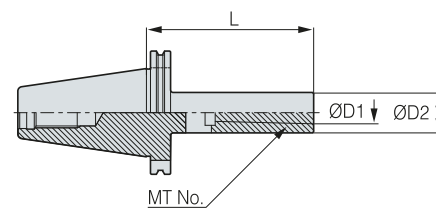

Fig.2



- ● : Stock
- Holder for morse taper shank tools (drill, reamer)
- C** This product does not support the internal coolant system

	Designation	MT No.	L	ØD1	ØD2	Fig.	kg	Package Weight(kg)	Stock
SK50	SK50-MTA3-45	3	45	23.825	40	1	2.7	3.0	●
	SK50-MTA3-150	3	150	23.825	40	2	3.6	4.0	●
	SK50-MTA4-75	4	75	31.267	50	1	2.9	3.2	●

(Unit : mm)

1:1 CHAT



BT-TMTA

Morse Taper Arbor

MAS
403-BT

Shank

C

Coolant System



Drilling



Reaming



Fig.1

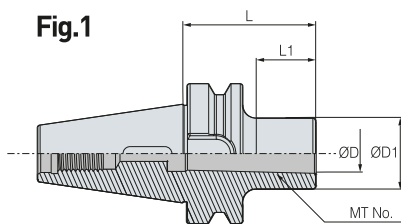
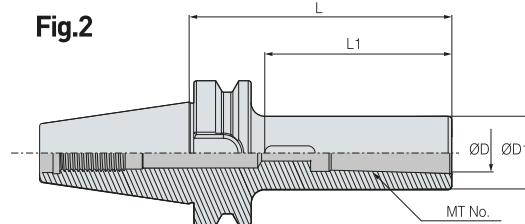

Fig.2



- ● : Stock
- C** Internal coolant system is optional

	Designation	MT No.	L	ØD	ØD1	L1	Fig	Package Weight(kg)	Stock
BT40	BT40-TMTA1-120	1	120	12.065	25	93	2	1.3	●
	BT40-TMTA2-120	2	120	17.78	32	93	2	1.4	●
	BT40-TMTA3-135	3	135	23.825	40	108	2	1.7	●
BT50	BT50-TMTA2-60	2	60	17.78	32	22	1	3.6	●
	BT50-TMTA2-135	2	135	17.78	32	97	2	4.2	●
	BT50-TMTA3-65	3	65	23.825	40	27	1	4.4	●
	BT50-TMTA3-150	3	150	23.825	40	112	2	4.4	●
	BT50-TMTA3-180	3	180	23.825	40	142	2	4.6	●
	BT50-TMTA4-95	4	95	31.267	50	57	1	3.9	●

(Unit : mm)

1:1 CHAT



BT-FMA

Face Mill Arbor



MAS
403-BT

Shank

C

Coolant System



Face Cutting

Fig.1

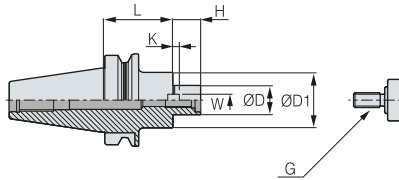

Fig.2

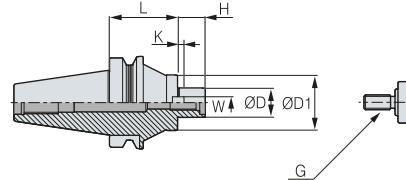

Fig.3

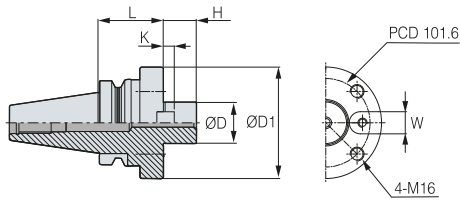
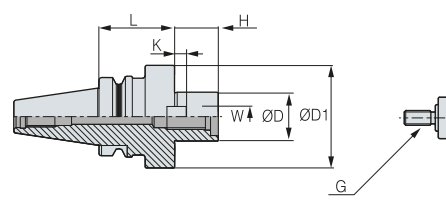

Fig.4



• ● : Stock

☐ Internal coolant system is optional

※ The relevant weight excludes the weight of the face cutter

• For more information on the related parts, see **146P**

	Designation	Cutter Diameter	ØD	L	ØD1	H	W	K	G	Fig.	kg	Package Weight(kg)	Stock	
BT30	BT30-FMA25.4-45	80	25.4	45	50	22	9.5	5	M12	4	1.0	1.0	●	
BT40	BT40-FMA25.4-45	80	25.4	45	50	22	9.5	5	M12	1	1.4	1.6	●	
	BT40-FMA25.4-90	80	25.4	90	50	22	9.5	5	M12	1	2.2	2.4	●	
	BT40-FMA31.75-45	100	31.75	45	60	30	12.7	7	M16	1	1.6	1.8	●	
	BT40-FMA31.75-75	100	31.75	75	60	30	12.7	7	M16	1	2.2	2.4		
	BT40-FMA31.75-90	100	31.75	90	60	30	12.7	7	M16	1	2.5	2.7	●	
	BT40-FMA38.1-60	125	38.1	60	80	34	15.87	9	M20	4	2.6	2.8	●	
BT50	BT50-FMA25.4-45	80	25.4	45	50	22	9.5	5	M12	1	4.0	4.3	●	
	BT50-FMA25.4-90	80	25.4	90	50	22	9.5	5	M12	1	4.7	5.0	●	
	BT50-FMA25.4-150	80	25.4	150	50	22	9.5	5	M12	2	6.4	6.8	●	
	BT50-FMA31.75-45	100	31.75	45	60	30	12.7	7	M16	1	4.1	4.4	●	
	BT50-FMA31.75-75	100	31.75	75	60	30	12.7	7	M16	1	4.8	5.1	●	
	BT50-FMA31.75-105	100	31.75	105	60	30	12.7	7	M16	2	5.6	5.9	●	
	BT50-FMA38.1-45	125	38.1	45	80	34	15.87	9	M20	1	4.4	4.7	●	
	BT50-FMA38.1-75	125	38.1	75	80	34	15.87	9	M20	1	5.6	5.9	●	
	BT50-FMA50.8-45	160	50.8	45	100	36	19.05	10	M24	1	4.9	5.2	●	
	BT50-FMA50.8-75	160	50.8	75	100	36	19.05	10	M24	1	6.8	7.1	●	
	BT50-FMA47.625-75	200	47.625	75	128	38	25.4	12.5	-	3	8.3	8.6	●	

(Unit : mm)

1:1 CHAT



NT-FMA

Face Mill Arbor



DIN2080
JISB6101

Shank

C

Coolant System



Face Cutting

Fig.1

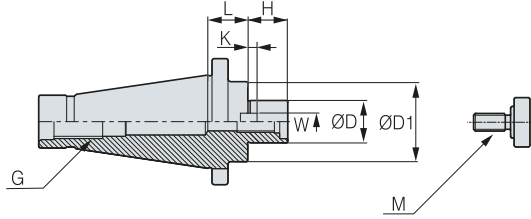
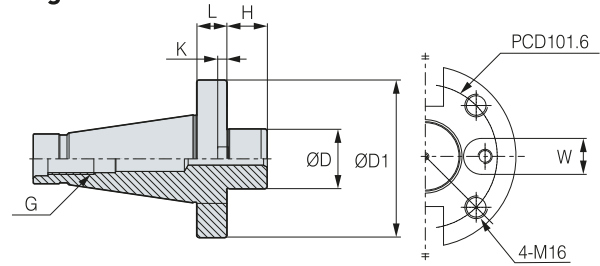

Fig.2



• ● : Stock

C This product does not support the internal coolant system

※ The relevant weight excludes the weight of the face cutter

• For more information on the related parts, see **146P**

	Designation	Cutter Diameter	ØD	L	ØD1	H	M	W	K	G	Fig.	kg	Package Weight(kg)	Stock
NT40	NT40-FMA25.4-25	80	25.4	25	50	22	M12	9.5	5	M16	1	1.1	1.3	●
	NT40-FMA31.75-25	100	31.75	25	60	30	M16	12.7	7	M16	1	1.3	1.5	●
	NT40-FMA38.1-25	125	38.1	25	80	34	M20	15.87	9	M16	1	1.8	2.0	●
	NT40-FMA50.8-25	160	50.8	25	100	36	M24	19.05	10	M16	1	2.8	3.0	●
NT50	NT50-FMA25.4-25	80	25.4	23.2	50	22	M12	9.5	5	M24	1	3.1	3.4	●
	NT50-FMA31.75-30	100	31.75	26.2	60	30	M16	12.7	7	M24	1	3.3	3.6	●
	NT50-FMA38.1-30	125	38.1	25.2	80	34	M20	15.87	9	M24	1	3.6	3.9	●
	NT50-FMA50.8-30	160	50.8	27.2	100	36	M24	19.05	10	M24	1	4.2	4.5	●
	NT50-FMA47.625-25	200	47.625	27.2	128	38	-	25.4	12.5	M24	2	5.3	5.6	●

(Unit : mm)

1:1 CHAT







FMA SPARE PART

Face Mill Arbor Related Parts



Main Components

SPARE PART	Type	Main Components			
		Key	Key Bolt	Mount Bolt	Clamp Bolt
	Images				
	Designation				
	FMA25.4	K9.5	BX0412	MBA-M12	BX1230
	FMA31.75	K12.7	BX0515	MBA-M16	-
	FMA38.1	K15.87	BX0616	MBA-M20	-
	FMA50.8	K19.05	BX0820	MBA-M24	-
	FMA47.625	K25.4	BX1020	-	BX1645

Accessories

SPARE PART	Type	Accessories	
		Wrench	
	Images		
	Designation		
	FMA25.4		LW-10
	FMA31.75		LW-14
	FMA38.1		LW-17

1:1 CHAT



BT-TFMA

Face Mill Arbor



MAS
403-BT

Shank



Coolant System



Face Cutting

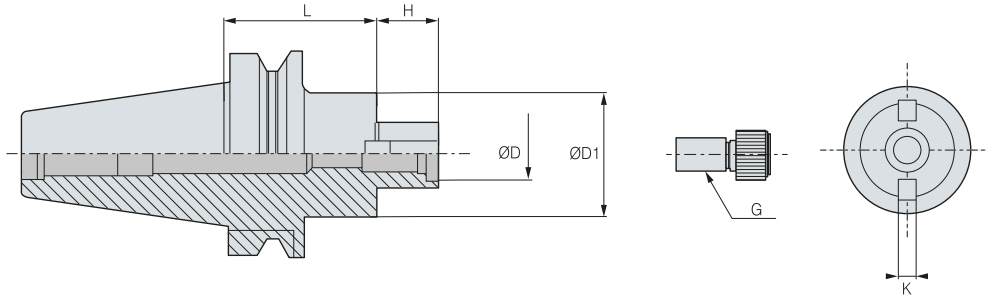

• ● : Stock

C Internal coolant system is optional

	Designation	ØD	L	ØD1	H	K	G	Package Weight(kg)	Stock
BT30	BT30-TFMA25.4-45	25.4	45	50	20	9.5	TMBA-M12	1.2	●
BT40	BT40-TFMA25.4-45	25.4	45	50	20	9.5	TMBA-M12	1.4	●
	BT40-TFMA25.4-90	25.4	90	50	20	9.5	TMBA-M12	3.1	●
	BT40-TFMA31.75-45	31.75	45	60	22	12.7	TMBA-M16	1.6	●
BT50	BT50-TFMA25.4-90	25.4	90	50	20	9.5	TMBA-M12	4.5	●
	BT50-TFMA25.4-150	25.4	150	50	20	9.5	TMBA-M12	5.5	●
	BT50-TFMA31.75-105	31.75	105	98	22	12.7	TMBA-M16	6.0	●
	BT50-TFMA38.1-75	38.1	75	50	25	15.9	TMBA-M20	5.5	●

(Unit : mm)

Clamp Bolt

Designation	M	A	L	ØD	W
TCB-M8	M8	7.8	25	12.9	6
TCB-M10	M10	9.6	30	15.6	8

(Unit : mm)

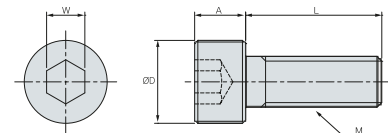

Mount Bolt

Designation	M	A	L	ØD	W
TMBA-M12	M12*1.75	10	35	33	10
TMBA-M16	M16*2.0	10	50	39	14

(Unit : mm)

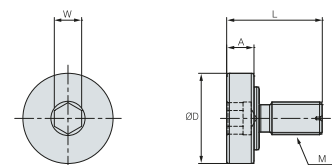

1:1 CHAT



BT-FMC

Face Mill Arbor



MAS
403-BT

C

Shank

Coolant System

Face Cutting

Fig.1

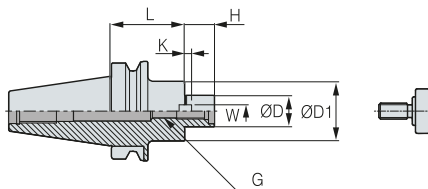

Fig.2

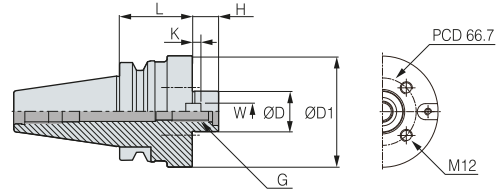
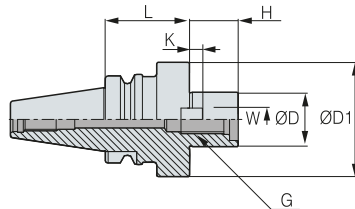

Fig.3



• ● : Stock

☐ Internal coolant system is optional

※ The relevant weight excludes the weight of the face cutter

• For more information on the related parts, see **151P**

	Designation	Cutter Diameter	ØD	L	ØD1	H	W	K	G	Fig.	kg	Package Weight(kg)	Stock
BT30	BT30-FMC16-45	40	16	45	38	17	8	5.0	M8	1	0.7	0.7	●
	BT30-FMC22-45	50/63	22	45	48	19	10	5.6	M10	2	0.8	0.9	●
	BT30-FMC27-50	80	27	50	60	21	12	6.3	M12	2	1.0	1.1	●
BT40	BT40-FMC16-60	40	16	60	38	17	8	5.0	M8	1	1.3	1.5	●
	BT40-FMC22-45	50/63	22	45	48	19	10	5.6	M10	1	1.3	1.5	●
	BT40-FMC22-90	50/63	22	90	48	19	10	5.6	M10	1	1.9	2.1	●
	BT40-FMC27-60	80	27	60	60	21	12	6.3	M12	1	1.8	2.0	●
	BT40-FMC27-90	80	27	90	60	21	12	6.3	M12	1	2.4	2.6	●
	BT40-FMC32-60	100	32	60	78	24	14	7.0	M16	2	2.1	2.3	●
	BT40-FMC40-50	125/160	40	50	89	27	15.87	8.0	M20	3	2.3	2.5	●
	BT50	BT50-FMC16-60	40	16	60	38	17	8	5.0	M8	1	3.9	4.2
BT50-FMC22-60		50/63	22	60	48	19	10	5.6	M10	1	4.1	4.4	●
BT50-FMC27-40		80	27	40	60	21	12	6.3	M12	1	3.8	4.1	●
BT50-FMC27-90		80	27	90	60	21	12	6.3	M12	1	4.8	5.1	●
BT50-FMC27-150		80	27	150	60	21	12	6.3	M12	1	6.1	6.5	●
BT50-FMC32-45		100	32	45	78	24	14	7.0	M16	1	4.1	4.4	●
BT50-FMC32-75		100	32	75	78	24	14	7.0	M16	1	5.2	5.5	●
BT50-FMC32-105		100	32	105	78	24	14	7.0	M16	1	6.3	6.6	●
BT50-FMC40-50		125/160	40	50	89	27	15.87	8.0	M20	2	4.6	4.9	●

(Unit : mm)



SK-FMC

Face Mill Arbor



DIN69871
-1A/B
C

Shank Coolant System Face Cutting

Fig.1

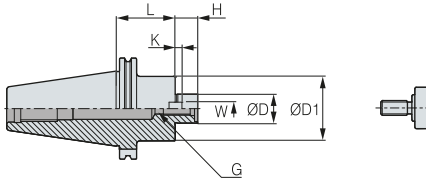

Fig.2

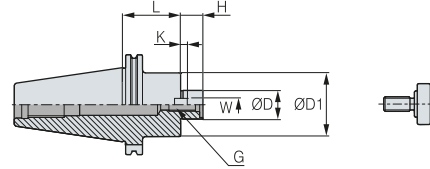
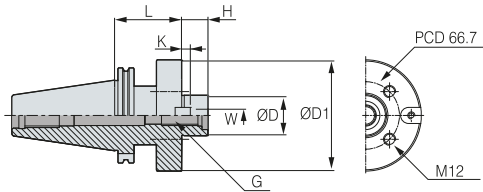

Fig.3



- ● : To be switched to NP order after stock depletion
- ● : Stock

☐ Internal coolant system is optional

※ The relevant weight excludes the weight of the face cutter

• For more information on the related parts, see **151P**

	Designation	Cutter Diameter	ØD	L	ØD1	H	W	K	G	Fig.	kg	Package Weight(kg)	Stock
SK30	SK30-FMC16-60	40	16	60	38	17	8	5.0	M8	1	0.8	0.8	●
	SK30-FMC22-50	50/63	22	50	48	19	10	5.6	M10	2	0.8	0.9	●
	SK30-FMC27-55	80	27	55	60	21	12	6.3	M12	2	1.1	1.2	●
SK40	SK40-FMC16-55	40	16	55	38	17	8	5.0	M8	1	1.2	1.4	●
	SK40-FMC22-55	50/63	22	55	48	19	10	5.6	M10	1	1.4	1.6	●
	SK40-FMC27-60	80	27	60	60	21	12	6.3	M12	2	1.6	1.8	●
	SK40-FMC32-60	100	32	60	78	24	14	7.0	M16	2	2.2	2.4	●
	SK40-FMC40-50	125/160	40	50	89	27	15.87	8.0	M20	3	2.3	2.5	●
SK50	SK50-FMC16-60	40	16	60	38	17	8	5.0	M8	1	2.9	3.2	●
	SK50-FMC22-60	50/63	22	60	48	19	10	5.6	M10	1	3.2	3.5	●
	SK50-FMC27-40	80	27	40	60	21	12	6.3	M12	1	3.2	3.5	●
	SK50-FMC32-45	100	32	45	78	24	14	7.0	M16	1	3.7	4.0	●
	SK50-FMC40-50	125/160	40	50	89	27	15.87	8.0	M20	3	4.2	4.5	●

(Unit : mm)

1:1 CHAT



FMC SPARE PART

Face Mill Arbor Related Parts



Chuck

Arbor/Modular

Boring Tool

Angular Head

cBN/PCD

Device&Accessory

Standard

Main Components

SPARE PART	Type	Main Components			
		Key	Key Bolt	Mount Bolt	Clamp Bolt
	Images				
	Designation				
	FMC16	K8.0	BX0310	-	BX0830
	FMC22	K10.0	BX0412	-	BX1030
	FMC27	K12.0	BX0516	MBA-M12	BX1230
	FMC32	K14.0	BX0616	MBA-M16	-
	FMC40	K15.87	BX0616	MBA-M20	BX1230

※ BX1235 clamp bolts are used for SK40-FMC40-50.

Accessories

SPARE PART	Type	Accessories
		Wrench
	Images	
	Designation	
	FMC16	LW-6
	FMC22	LW-8
	FMC27	LW-10
	FMC32	LW-14
	FMC40	LW-17

SPARE PART	Type	Accessories	
		Coolant Tube for HSK	Wrench
	Images		
	Designation		
	HSK50A	HSK50A-CNS	HSK50-WRENCH(C)
	HSK63A	HSK63A-CNS	HSK63-WRENCH(C)

1:1 CHAT



BT-TFMC

Face Mill Arbor



MAS
403-BT

C



Shank

Coolant System

Face Cutting

Fig.1

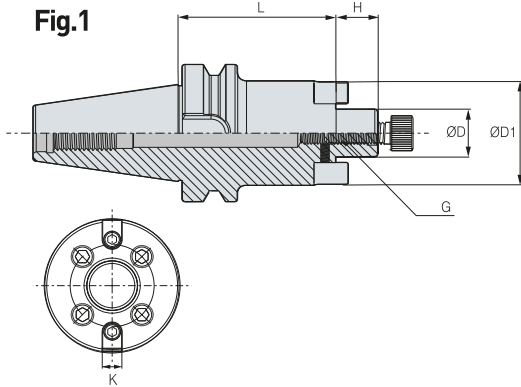
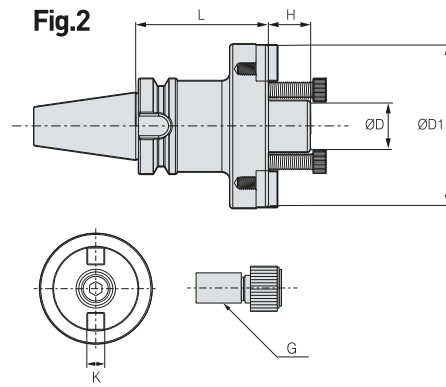

Fig.2



• : Stock

☐ Internal coolant system is optional

	Designation	ØD	L	ØD1	H	K	G	Fig	Package Weight(kg)	Stock
BT30	BT30-TFMC16-35	16	35	38	17	8.0	M8	1	0.5	●
	BT30-TFMC22-45	22	45	48	18	10.0	M10	1	0.8	●
	BT30-TFMC27-45	27	45	60	20	12.0	M12	1	0.9	●
BT40	BT40-TFMC16-40	16	40	38	17	8.0	M8	1	1.1	●
	BT40-TFMC22-40	22	40	48	19	10.0	M10	1	1.2	●
	BT40-TFMC22-100	22	100	48	19	10.0	M10	1	2.0	●
	BT40-TFMC27-40	27	40	60	21	12.0	M12	1	1.3	●
	BT40-TFMC27-100	27	100	60	20	12.0	M12	1	2.6	●
	BT40-TFMC32-50	32	50	78	24	14.0	M16	1	2.0	●
	BT40-TFMC32-75	32	75	78	22	14.0	M16	1	5.5	●
BT50	BT50-TFMC16-55	16	55	38	17	8.0	M8	1	3.7	●
	BT50-TFMC22-55	22	55	48	19	10.0	M10	1	3.8	●
	BT50-TFMC27-55	27	55	60	21	12.0	M12	1	4.1	●
	BT50-TFMC27-100	27	100	60	21	12.0	M12	1	5.2	●
	BT50-TFMC32-55	32	55	78	24	14.0	M16	1	4.4	●
	BT50-TFMC32-75	32	75	78	22	14.0	M16	1	5.5	●
	BT50-TFMC32-100	32	100	78	24	14.0	M16	1	6.0	●
	BT50-TFMC40-55[D160]	40	55	108	27	16.0	M20	2	4.8	●

(Unit : mm)

Clamp Bolt

Designation	M	A	L	ØD	W
TCB-M8	M8	7.8	25	12.9	6
TCB-M10	M10	9.6	30	15.6	8

(Unit : mm)

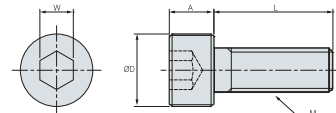

Mount Bolt

Designation	M	A	L	ØD	W
TMBA-M12	M12*1.75	10	35	33	10
TMBA-M16	M16*2.0	10	50	39	14

(Unit : mm)

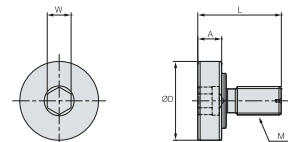

1:1 CHAT



BT-TFMC-L

Long Face Mill Arbor



MAS
403-BT



Shank

Coolant System

Face Cutting

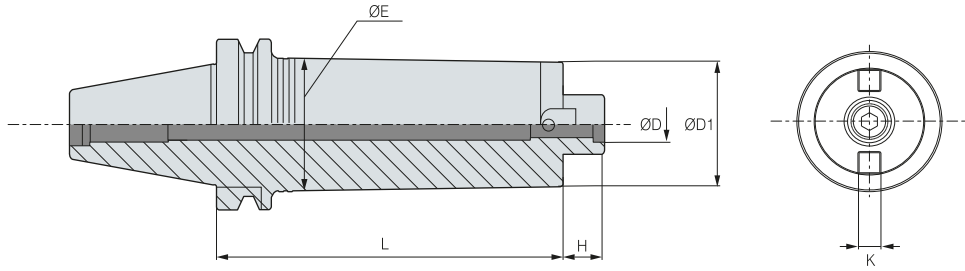

• ● : Stock

C Internal coolant system is optional

Designation	ØD	L	ØD1	ØE	H	K	Package Weight(kg)	Stock
BT50	BT50-TFMC22-160R(D50)	22	160	46	49	19	5.0	●
	BT50-TFMC22-200R(D50)	22	200	46	49	19	5.4	●
	BT50-TFMC22-250R(D50)	22	250	46	49	19	6.9	●
	BT50-TFMC22-160R(D63)	22	160	59	62	19	6.1	●
	BT50-TFMC22-200R(D63)	22	200	59	62	19	6.9	●
	BT50-TFMC22-250R(D63)	22	250	59	62	19	7.9	●
	BT50-TFMC22-300R(D63)	22	300	59	62	19	8.8	●
	BT50-TFMC27-200R(D80)	27	200	62	78	21	8.2	●
	BT50-TFMC27-250R(D80)	27	250	62	78	21	9.6	●
BT50-TFMC27-300R(D80)	27	300	62	78	21	11.0	●	

(Unit : mm)

Chuck
Arbor/Modular
Boring Tool
Angular Head
cBN/PCD
Device&Accessory
Standard

1:1 CHAT



DBT-MD

Modular Arbor



DBT

Shank

G6.3

G value

C

Coolant System

Fig.1

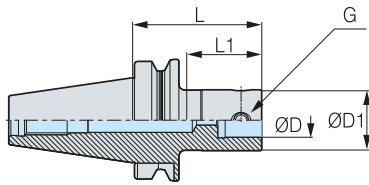

Fig.2

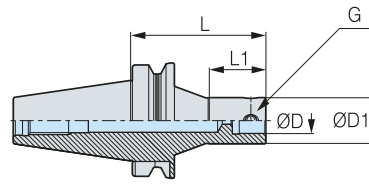

Fig.3

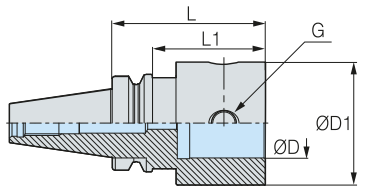
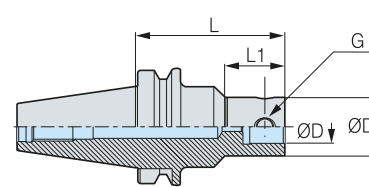

Fig.4



C Internal coolant system is basic

• For more information on the related parts, see **160P**

	Designation	ØD	L	ØD1	L1	G	Fig.	kg	Package Weight(kg)	Stock	
DBT30	DBT30-MD19F-70R	11	70	19	27	M5	4	0.5	0.6		
	DBT30-MD25F-90R	14	90	25	43	M6	4	0.6	0.7		
	DBT30-MD32F-80R	18	80	32	39	M8	4	0.7	0.8		
	DBT30-MD40F-45	22	45	40	24	M10	1	0.5	0.6		
	DBT30-MD40F-80R	22	80	40	49	M10	4	0.8	0.9		
	DBT30-MD50F-70	28	70	50	48	M12	3	0.9	1.0		
DBT40	DBT40-MD19F-70	11	70	19	43	M5	1	1.0	1.2		
	DBT40-MD25F-95	14	95	25	68	M6	1	1.1	1.3		
	DBT40-MD25F-105R	14	105	25	40	M6	2	1.2	1.4		
	DBT40-MD32F-100	18	100	32	70	M8	1	1.2	1.5		
	DBT40-MD32F-115R	18	115	32	45	M8	2	1.5	1.7		
	DBT40-MD40F-50	22	50	40	21	M10	1	1.2	1.4		
	DBT40-MD40F-110R	22	110	40	60	M10	2	1.6	1.8		
	DBT40-MD40F-115	22	115	40	83	M10	1	1.6	1.8		
	DBT40-MD50F-100R	28	100	50	50	M12	2	1.8	2.1		
	DBT40-MD50F-105	28	105	50	75	M12	1	1.9	2.1		
	DBT40-MD63F-64	36	64	63	37	M16	3	1.5	1.7		
	DBT40-MD63F-90	36	90	63	63	M16	3	2.1	2.3		
	DBT40-MD63F-110	36	110	63	83	M16	3	2.5	2.7		
	DBT40-MD80F-100	45	100	80	73	M16	3	2.9	3.1		

(Unit : mm)

1:1 CHAT



DBT-MD

Modular Arbor



DBT

Shank

G6.3

G value

C

Coolant System

Fig.1

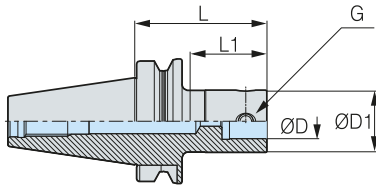

Fig.2

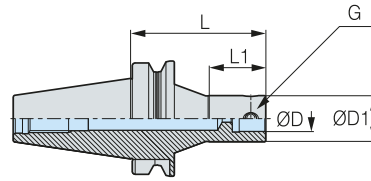

Fig.3

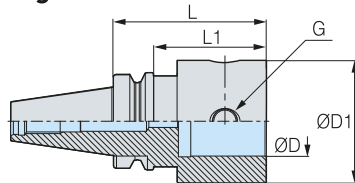
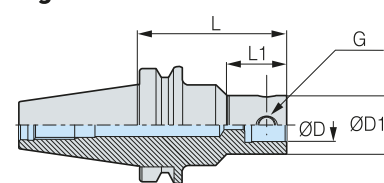

Fig.4



C Internal coolant system is basic

• For more information on the related parts, see **160P**

	Designation	ØD	L	ØD1	L1	G	Fig.	kg	Package Weight(kg)	Stock
DBT50	DBT50-MD19F-85	11	85	19	45	M5	1	3.7	4.0	
	DBT50-MD19F-100	11	100	19	60	M5	1	3.8	4.1	
	DBT50-MD25F-105	14	105	25	64	M6	1	3.9	4.2	
	DBT50-MD25F-120R	14	120	25	40	M6	2	4.0	4.4	
	DBT50-MD32F-110	18	110	32	67	M8	1	4.1	4.4	
	DBT50-MD32F-115R	18	115	32	45	M8	2	4.2	4.6	
	DBT50-MD32F-235R	18	235	32	115	M8	2	5.5	5.9	
	DBT50-MD40F-60	22	60	40	22	M10	1	3.7	4.0	
	DBT50-MD40F-125R	22	125	40	59	M10	2	4.3	4.7	
	DBT50-MD40F-145	22	145	40	102	M10	1	4.5	4.9	
	DBT50-MD40F-195R	22	195	40	83	M10	4	4.8	5.2	
	DBT50-MD40F-230R	22	230	40	180	M10	2	5.0	5.4	
	DBT50-MD50F-125	28	125	50	82	M12	1	4.6	5.0	
	DBT50-MD50F-160R	28	160	50	61	M12	2	5.8	6.2	
	DBT50-MD50F-225R	28	225	50	125	M12	4	6.0	6.4	
	DBT50-MD50F-250R	28	250	50	81	M12	2	7.0	7.4	
	DBT50-MD63F-75	36	75	63	35	M16	1	4.2	4.5	
	DBT50-MD63F-130	36	130	63	87	M16	1	5.3	5.7	
	DBT50-MD63F-140	36	140	63	97	M16	1	5.5	5.9	
	DBT50-MD63F-140R	36	140	63	70	M16	2	5.7	6.1	
DBT50-MD63F-195R	36	195	63	120	M16	4	6.8	7.2		
DBT50-MD63F-230R	36	230	63	149	M16	4	7.5	7.9		
DBT50-MD63F-240R	36	240	63	190	M16	2	7.8	8.2		
DBT50-MD80F-75	45	75	80	36	M16	1	4.4	4.7		
DBT50-MD80F-110	45	110	80	69	M16	1	5.8	6.1		
DBT50-MD80F-160	45	160	80	119	M16	1	8.0	8.4		
DBT50-MD90F-75	45	75	90	37	M16	1	4.8	5.1		
DBT50-MD90F-145	45	145	90	107	M16	1	7.4	7.8		

(Unit : mm)

Chuck

Arbor/Modular

Boring Tool

Angular Head

cBN/PCD

Device&Accessory

Standard



BT-MD

Modular Arbor



MAS
403-BT

Shank

G6.3

G value

C

Coolant System

Fig.1

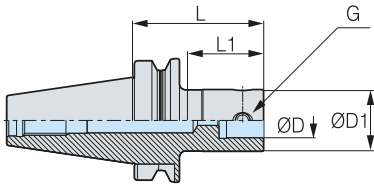

Fig.2

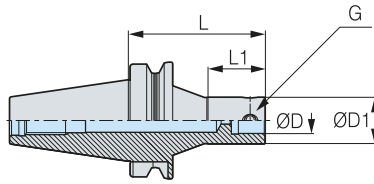
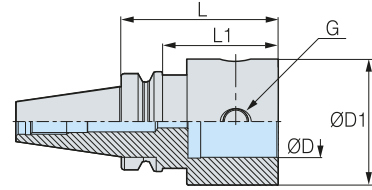

Fig.3



● : Stock

C Internal coolant system is basic

• For more information on the related parts, see **160P**

	Designation	ØD	L	ØD1	L1	G	Fig.	kg	Package Weight(kg)	Stock
BT30	BT30-MD19F-70	11	70	19	45	M5	1	0.5	0.5	●
	BT30-MD25F-90	14	90	25	63	M6	1	0.6	0.7	●
	BT30-MD32F-80	18	80	32	55	M8	1	0.7	0.7	●
	BT30-MD40F-45	22	45	40	22	M10	1	0.5	0.6	●
	BT30-MD40F-60	22	60	40	36	M10	1	0.7	0.7	●
	BT30-MD40F-80	22	80	40	56	M10	1	0.9	0.9	●
	BT30-MD50F-70	28	70	50	48	M12	3	0.9	1.0	●
BT40	BT40-MD19F-70	11	70	19	40	M5	1	1.0	1.2	●
	BT40-MD25F-95	14	95	25	63	M6	1	1.1	1.3	●
	BT40-MD25F-105R	14	105	25	40	M6	2	1.2	1.4	●
	BT40-MD32F-100	18	100	32	70	M8	1	1.2	1.5	●
	BT40-MD32F-115R	18	115	32	45	M8	2	1.5	1.8	●
	BT40-MD40F-60	22	60	40	31	M10	1	1.1	1.3	●
	BT40-MD40F-110R	22	110	40	60	M10	2	1.6	1.9	●
	BT40-MD40F-115	22	115	40	83	M10	1	1.6	1.8	●
	BT40-MD50F-60	28	60	50	30	M12	1	1.3	1.5	
	BT40-MD50F-100R	28	100	50	50	M12	2	1.8	2.1	
	BT40-MD50F-105	28	105	50	73	M12	1	1.8	2.1	●
	BT40-MD63F-64	36	64	63	37	M16	3	1.5	1.7	●
	BT40-MD63F-90	36	90	63	63	M16	3	2.0	2.3	
	BT40-MD63F-110	36	110	63	83	M16	3	2.4	2.6	●
	BT40-MD63F-135	36	135	63	108	M16	3	3.0	3.3	●
	BT40-MD80F-100	45	100	80	73	M16	3	2.9	3.1	●

(Unit : mm)

1:1 CHAT



BT-MD

Modular Arbor

MAS
403-BT

Shank

G6.3

G value

C

Coolant System

Fig.1

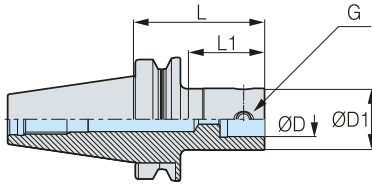
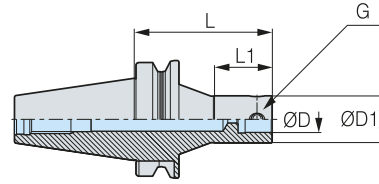

Fig.2



● : Stock

C Internal coolant system is basic

• For more information on the related parts, see **160P**

	Designation	ØD	L	ØD1	L1	G	Fig.	kg	Package Weight(kg)	Stock	
BT50	BT50-MD19F-85	11	85	19	44	M5	1	3.7	4.0	●	
	BT50-MD19F-100	11	100	19	59	M5	1	3.7	4.0	●	
	BT50-MD25F-105	14	105	25	62	M6	1	3.8	4.1	●	
	BT50-MD25F-120R	14	120	25	40	M6	2	3.8	4.1	●	
	BT50-MD32F-110	18	110	32	67	M8	1	4.0	4.3	●	
	BT50-MD32F-115R	18	115	32	45	M8	2	4.1	4.5	●	
	BT50-MD32F-235R	18	235	32	115	M8	2	5.5	5.9	●	
	BT50-MD40F-60	22	60	40	22	M10	1	3.7	4.0	●	
	BT50-MD40F-125R	22	125	40	59	M10	2	3.8	4.1		
	BT50-MD40F-145	22	145	40	102	M10	1	4.3	4.7		
	BT50-MD40F-195	22	195	40	152	M10	1	4.8	5.2	●	
	BT50-MD40F-230R	22	230	40	180	M10	2	5.0	5.4	●	
	BT50-MD50F-125	28	125	50	82	M12	1	4.6	5.0	●	
	BT50-MD50F-160R	28	160	50	61	M12	2	5.7	6.1		
	BT50-MD50F-225	28	225	50	182	M12	1	6.0	6.4	●	
	BT50-MD50F-250R	28	250	50	81	M12	2	7.0	7.4	●	
	BT50-MD63F-75	36	75	63	35	M16	1	4.2	4.5	●	
	BT50-MD63F-130	36	130	63	87	M16	1	5.3	5.7	●	
	BT50-MD63F-140	36	140	63	97	M16	1	5.5	5.9		
	BT50-MD63F-140R	36	140	63	80	M16	2	5.7	6.1		
	BT50-MD63F-195	36	195	63	152	M16	1	6.8	7.2	●	
	BT50-MD63F-230	36	230	63	187	M16	1	7.5	7.9	●	
	BT50-MD63F-240R	36	240	63	190	M16	2	7.8	8.2		
	BT50-MD80F-75	45	75	80	36	M16	1	4.3	4.6	●	
	BT50-MD80F-110	45	110	80	69	M16	1	5.7	6.0	●	
	BT50-MD80F-175	45	175	80	134	M16	1	8.0	8.4	●	
	BT50-MD90F-75	45	75	90	36	M16	1	4.8	5.1	●	
	BT50-MD90F-145	45	145	90	104	M16	1	7.4	7.8	●	
	BT50-MD90F-195	45	195	90	154	M16	1	9.4	9.8	●	

(Unit : mm)

Chuck

Arbor/Modular

Boring Tool

Angular Head

cBN/PCD

Device&Accessory

Standard

1:1 CHAT



HSK-MD

Modular Arbor



DIN
69893-1

Shank

G6.3

G value

C

Coolant System

Fig.1

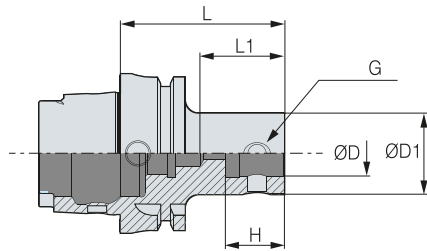
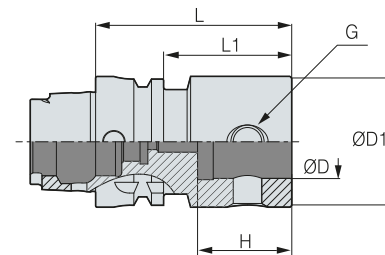

Fig.2



● : Stock

☐ Internal coolant system is optional

• For more information on the related parts, see **160P**

	Designation	ØD	L	ØD1	L1	H	G	Fig.	kg	Package Weight(kg)	Stock
HSK63A	HSK63A-MD19F-60	11	60	19	31	15.5	M5	1	0.7	0.9	●
	HSK63A-MD25F-60	14	60	25	31	18.5	M6	1	0.7	0.9	●
	HSK63A-MD32F-65	18	65	32	36	23.5	M8	1	0.8	1.0	●
	HSK63A-MD40F-70	22	70	40	41	29.0	M10	1	0.9	1.1	●
	HSK63A-MD50F-85	28	85	50	58	36.0	M12	1	1.3	1.5	●
	HSK63A-MD63F-95	36	95	63	69	46.0	M16	2	1.7	1.9	●
HSK100A	HSK100A-MD19F-60	11	60	19	19	15.5	M5	1	2.1	2.3	
	HSK100A-MD25F-60	14	60	25	20	18.5	M6	1	2.1	2.3	
	HSK100A-MD32F-65	18	65	32	26	23.5	M8	1	2.1	2.4	
	HSK100A-MD40F-70	22	70	40	38	29	M10	1	2.3	2.6	
	HSK100A-MD50F-80	28	80	50	48	36	M12	1	2.6	2.9	
	HSK100A-MD63F-90	36	90	63	58	46	M16	1	3.0	3.4	
	HSK100A-MD80F-105	45	105	80	73	57	M16	1	4.2	4.5	
	HSK100A-MD90F-105	45	105	90	76	57	M16	1	4.7	5.0	

(Unit : mm)

Accessories

SPARE PART	Type	Accessories	
		Coolant Tube for HSK	Wrench
	Images		
	Designation		
	HSK63A	HSK63A-CNS	HSK63-WRENCH(C)
	HSK100A	HSK100A-CNS	HSK100-WRENCH(C)

1:1 CHAT



SK-MD

Modular Arbor

DIN69871
-1A/B

Shank

G6.3

G value

C

Coolant System



Fig.1

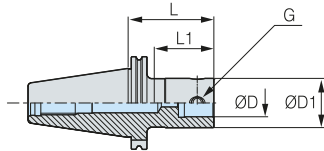

Fig.2

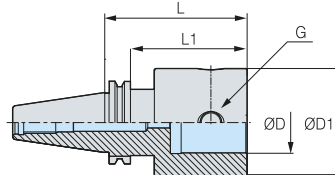
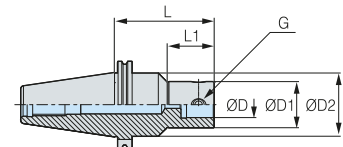

Fig.3



• ● : Stock

C Internal coolant system is basic

• For more information on the related parts, see **160P**

	Designation	ØD	L	ØD1	ØD2	L1	G	Fig.	kg	Package Weight(kg)	Stock	
SK40	SK40-MD19F-80R	11	80	19	30	12	M5	3	1.0	1.2		
	SK40-MD25F-80R	14	80	25	35	22	M6	3	1.1	1.3	●	
	SK40-MD32F-115R	18	115	32	42	36	M8	3	1.5	1.7	●	
	SK40-MD40F-60	22	60	40	-	40	M10	1	1.1	1.3	●	
	SK40-MD40F-100	22	100	40	-	79	M10	1	1.4	1.6	●	
	SK40-MD50F-75	28	75	50	-	55	M10	1	1.5	1.7	●	
	SK40-MD50F-100	28	100	50	-	80	M12	1	1.8	2.0	●	
	SK40-MD63F-70	36	70	63	-	50	M16	2	1.4	1.6	●	
SK50	SK50-MD19F-85R	11	85	19	40	12	M5	3	3.0	3.3		
	SK50-MD25F-80R	14	80	25	44	22	M6	3	3.1	3.4	●	
	SK50-MD25F-105R	14	105	25	44	22	M6	3	3.3	3.6	●	
	SK50-MD32F-110	18	110	32	-	87	M8	1	3.0	3.3	●	
	SK50-MD32F-110R	18	110	32	50	36	M8	3	3.5	3.8	●	
	SK50-MD40F-100	22	100	40	-	75	M10	1	3.2	3.5	●	
	SK50-MD40F-145	22	145	40	-	120	M10	1	3.5	3.9	●	
	SK50-MD40F-220R	22	220	40	60	83	M10	3	5.6	6.0	●	
	SK50-MD50F-125R	28	125	50	65	60	M12	3	4.3	4.6	●	
	SK50-MD50F-240R	28	240	50	65	125	M12	3	6.6	7.0	●	
	SK50-MD63F-75	36	75	63	-	52	M16	1	3.6	3.9	●	
	SK50-MD63F-130	36	130	63	-	107	M16	1	4.7	5.1	●	
	SK50-MD63F-230R	36	230	63	80	149	M16	3	7.9	8.3	●	
	SK50-MD80F-95	45	95	80	-	75	M16	1	4.8	5.1	●	
	SK50-MD80F-150	45	150	80	-	130	M16	1	6.8	7.2	●	
	SK50-MD90F-115	45	115	90	-	95	M16	2	6.3	6.6	●	
	SK50-MD90F-165	45	165	90	-	145	M16	2	8.1	8.5	●	

(Unit : mm)

1:1 CHAT



MD SPARE PART

Modular Arbor Related Parts





Main Components

SPARE PART	Type	Main Components
	Images	Taper Screw
		
	Designation	
	MD19F	BTT0506F
	MD25F	BTT0608F
	MD32F	BTT0810F
	MD40F	BTT1013F
	MD50F	BTT1215F
	MD63F	BTT1620F
	MD80F	BTT1626F
	MD90F	BTT1631F

Accessories

SPARE PART	Type	Accessories	
	Images	Wrench	
			
	Designation		
	MD19F	LW-2.5	
	MD25F	LW-3	
	MD32F	LW-4	
	MD40F	LW-5	
	MD50F	LW-6	
	MD63F	LW-8	
	MD80F	LW-8	
	MD90F	LW-8	

SPARE PART	Type	Accessories	
	Images	Coolant Tube for HSK	Wrench
			
	Designation		
	HSK63A	HSK63A-CNS	HSK63-WRENCH(C)
	HSK100A	HSK100A-CNS	HSK100-WRENCH(C)

1:1 CHAT



BT-TMD

Modular Arbor

NEW



MAS
403-BT

Shank

C

Coolant System



Features

- A multipurpose tooling system allows users to combine and use various tools
- A specially manufactured screw to guarantee high-precision and easy clamping and unclamping.
- Compatible with the modular units of Dine (please refer to the compatibility chart)

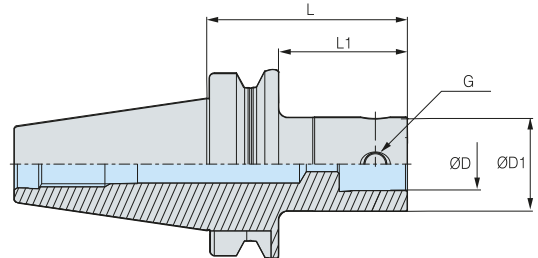

Compatibility Chart

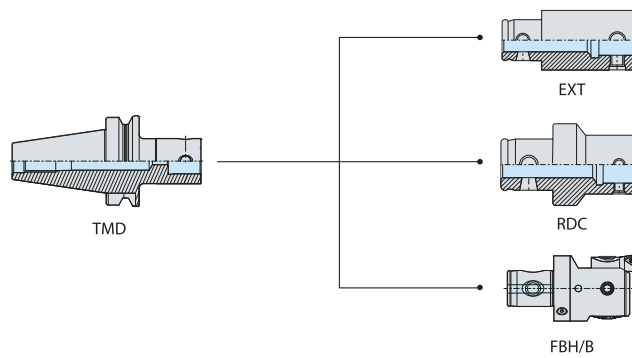

• ● : Stock

C Internal coolant system is basic

• For more information on the related parts, see **160P**

	Designation	ØD	L	ØD1	L1	G	Package Weight(kg)	Stock
BT30	BT30-TMD25F-90	14	90	25	68	M6	0.3	●
BT40	BT40-TMD40F-60	22	60	40	30	M10	2.7	●
	BT40-TMD63F-110	36	110	63	83	M16	3.6	●
BT50	BT50-TMD32F-110	18	110	32	72	M8	5.1	●
	BT50-TMD40F-60	22	60	40	22	M10	5	●
	BT50-TMD40F-145	22	145	40	107	M10	5.2	●
	BT50-TMD40F-195	22	195	40	157	M10	5.4	●
	BT50-TMD50F-125	28	125	50	87	M12	6	●
	BT50-TMD63F-140	36	140	63	102	M16	7	●
	BT50-TMD63F-195	36	195	63	157	M16	8	●
	BT50-TMD63F-230	36	230	63	187	M16	8.4	●
	BT50-TMD80F-75	45	75	80	37	M16	9.1	●
	BT50-TMD80F-110	45	110	80	72	M16	9.4	●
	BT50-TMD80F-175	45	175	80	137	M16	9.5	●

(Unit : mm)

1:1 CHAT



EXT

Extension Bar



C

Coolant System

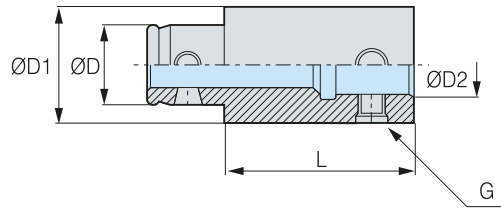

● : Stock

C Internal coolant system is basic

EXT	Designation	ØD	L	ØD1	ØD2	G	kg	Package Weight(kg)	Stock
EXT1930F		11	30	19	11	M5	0.1	0.1	●
EXT1950F		11	50	19	11	M5	0.1	0.1	●
EXT2530F		14	30	25	14	M6	0.1	0.1	●
EXT2550F		14	50	25	14	M6	0.2	0.2	●
EXT3235F		18	35	32	18	M8	0.2	0.2	●
EXT3260F		18	60	32	18	M8	0.4	0.4	●
EXT4040F		22	40	40	22	M10	0.4	0.4	●
EXT4090F		22	90	40	22	M10	0.9	0.9	●
EXT5050F		28	50	50	28	M12	0.7	0.7	●
EXT50100F		28	100	50	28	M12	1.4	1.5	●
EXT6360F		36	60	63	36	M16	1.4	1.5	●
EXT63120F		36	120	63	36	M16	2.9	2.9	●
EXT8070F		45	70	80	45	M16	2.5	2.7	●
EXT80120F		45	120	80	45	M16	4.5	4.7	●
EXT9080F		45	80	90	45	M16	3.8	4.0	●
EXT90130F		45	130	90	45	M16	6.4	6.6	●

(Unit : mm)

1:1 CHAT



RDC

Reducer Bar



C

Coolant System

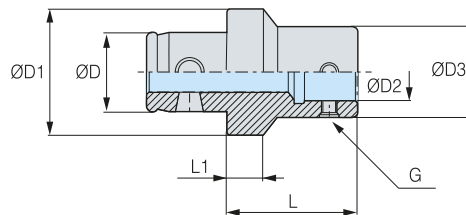

● : Stock

C Internal coolant system is basic

RDC	Designation	ØD	L	ØD1	ØD2	ØD3	L1	G	kg	Package Weight(kg)	Stock
RDC3225F		18	30	32	14	25	9	M6	0.1	0.2	●
RDC4025F		22	30	40	14	25	9	M6	0.3	0.3	●
RDC4032F		22	30	40	18	32	9	M8	0.2	0.2	●
RDC5025F		28	30	50	14	25	9	M6	0.3	0.4	●
RDC5032F		28	40	50	18	32	9	M8	0.3	0.4	●
RDC5040F		28	40	50	22	40	10	M10	0.5	0.6	●
RDC6325F		36	30	63	14	25	9	M6	0.6	0.7	●
RDC6332F		36	40	63	18	32	9	M8	0.6	0.7	●
RDC6340F		36	40	63	22	40	10	M10	0.7	0.8	●
RDC6350F		36	45	63	28	50	10	M12	0.9	1.0	●
RDC8040F		45	40	80	22	40	10	M10	1.2	1.4	●
RDC8050F		45	45	80	28	50	10	M12	1.3	1.5	●
RDC8063F		45	50	80	36	63	13	M16	1.6	1.8	●

(Unit : mm)



Boring Tool

DINE TOTAL TOOLING SOLUTION

FBH/B	164
FBH/D	173
DBCA	178
DBC	188
TBCA	194
TBC	200
FBC	203
SMB	207
KMB	209
SMH	211
BB BITE	215
BSA	216
BH	217
BKA	218
FZ UNIT	221
BCF	223
FF UNIT	225
INSERT	226

1:1 CHAT



FBH/B

FBH Back Boring & Balanced Type



G6.3

G value

C

Coolant System

Boring

Boring



Features

- Improved machining stability relative to conventional goods through the balanced design
- Back boring is available just by changing the location of the bite
- Fine dimension adjustment available through the vernier scale

NAMING

FBH	32	33	B
Fine Boring Head	MD Arbor Size	Boring Range (Min)	Balance Type

Back Boring Range Calculation



Designation	Min. Diameter for Pass (∅) 'C'
FBH1920B	∅24 or above
FBH2526B	∅30.5 or above
FBH3233B	∅35 or above
FBH4042B	∅44 or above
FBH5053B	∅54 or above
FBH6368B	∅71.5 or above
FBH6398B	∅100 or above
FBH8098B	∅100 or above

A	Max. Range of Back Boring (∅)	A Max. Value = (2xC)-B
B	Max. FBH Body Size (∅)	B Max. Value = (2xC)-A
C	Min. Diameter for Pass (∅)	C Min. Value = (A+B)/2

Vernier Scale Adjustment Method

Fine Adjustment : 2μm Boring Range

Can be adjusted at a rate of 2μm by using the main scale and vernier scale

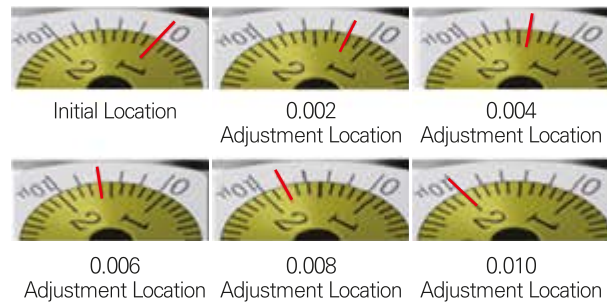

Back Boring Machining

Before Machining

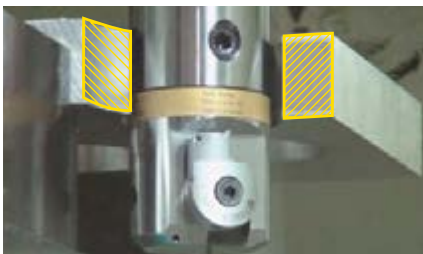

After Machining

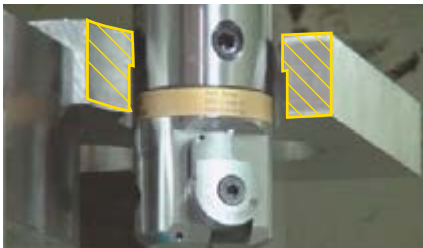

Convertible for Machining Direction

In case of Boring Machining

In case of Back Boring Machining



※ Boring direction can be easily shifted simply by changing the bite direction

1:1 CHAT



FBH/B

FBH Back Boring & Balanced Type



Test Results

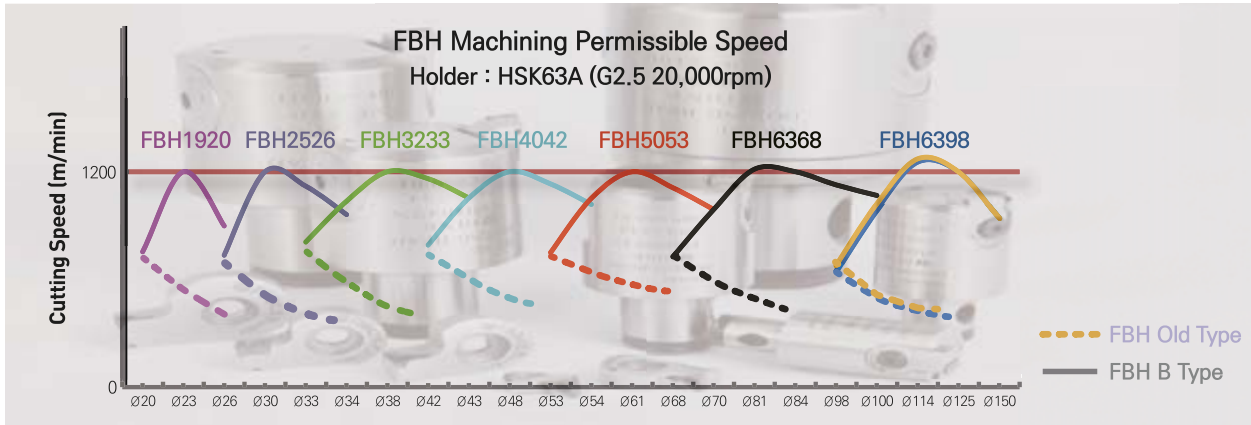

Chuck	Designation	FBH2526B		FBH2526N	
		V(m/min) 732 (6,861rpm)			
HSK63A-MD25F-60	Difference in surface roughness				
		<ul style="list-style-type: none"> • Constant and regular cycles are shown on the graph • Indicates stable boring work at high cutting speed 		<ul style="list-style-type: none"> • Irregular cycles shown on the graph • Indicates unstable boring work at high cutting speed 	

Boring Range

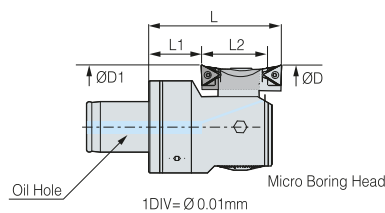

Designation	Boring Range(ØD)			Backboring Range(ØD1)			
	Min.	Max.	L	Min.	Max.	L1	L2
FBH1920B	20(24)	26(30)	35	29	30	13	19
FBH2526B	26(32)	34(40)	41	36	40	15	22
FBH3233B	33(40)	43(50)	41	38(45)	43(50)	13	25
FBH4042B	42(50)	54(62)	50	48(56)	54(62)	15	31
FBH5053B	53(65)	70(82)	58	58(70)	70(82)	16	38
FBH6368B	68(90)	100(122)	81	78(100)	100(122)	27	49
FBH6398B	98(120)	150(172)	101	106(128)	150(172)	47	49
FBH8098B	98(120)	150(172)	101	106(128)	150(172)	47	49

*The value in the () refers to the boring range of FBB bite extension type.

(Unit : mm)



BT-FBH/B

Micro Boring Bar(Balanced Type)



MAS 403-BT G6.3 C 20 172

Shank G value Coolant System Min Range Max Range Boring

Fig.1

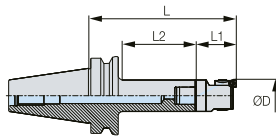

Fig.2

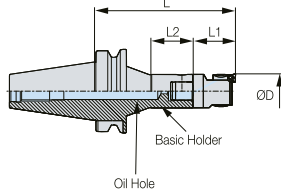
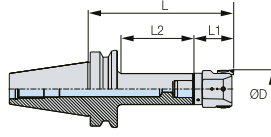
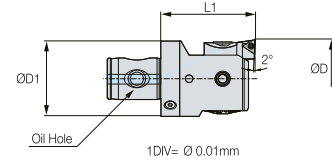

Fig.3



Head



- : Stock
- C Internal coolant system is basic
- ※ Red : Main Component Blue : For Separate Purchase

- For more information on product features, see **164P**
- For more information on MD arbor, see **156P**
- For more information on the related parts, see **172P**
- For more information on FBB bite, see **177P**

	Head Designation	Stock	Bite Designation	Stock	Arbor Designation	Stock	Boring Range(ØD)		L	L1	L2	ØD1	Head Weight(kg)	Head Package Weight(kg)	Fig
							Min.	Max.							
BT30	FBH1920B	●	FBB20N-□-□□	●	BT30-MD19F-70	●	20(24)	26(30)	105	35	45	19	0.2	0.2	1
	FBH2526B	●	FBB26N-□-□□	●	BT30-MD25F-90	●	26(32)	34(40)	131	41	63	25	0.2	0.2	1
	FBH3233B	●	FBB33N-□-□□	●	BT30-MD32F-80	●	33(40)	43(50)	121	41	55	32	0.3	0.3	1
	FBH4042B	●	FBB42N-□-□□	●	BT30-MD40F-45	●	42(50)	54(62)	95	50	22	40	0.5	0.5	1
	FBH4042B	●	FBB42N-□-□□	●	BT30-MD40F-60	●	42(50)	54(62)	110	50	36	40	0.5	0.5	1
	FBH4042B	●	FBB42N-□-□□	●	BT30-MD40F-80	●	42(50)	54(62)	130	50	56	40	0.5	0.5	1
	FBH5053B	●	FBB53N-□-□□	●	BT30-MD50F-70	●	53(65)	70(82)	128	58	47	50	0.8	0.9	1
BT40	FBH1920B	●	FBB20N-□-□□	●	BT40-MD19F-70	●	20(24)	26(30)	105	35	40	19	0.2	0.2	1
	FBH2526B	●	FBB26N-□-□□	●	BT40-MD25F-95	●	26(32)	34(40)	136	41	63	25	0.2	0.2	1
	FBH2526B	●	FBB26N-□-□□	●	BT40-MD25F-105R	●	26(32)	34(40)	146	41	40	25	0.2	0.2	2
	FBH3233B	●	FBB33N-□-□□	●	BT40-MD32F-100	●	33(40)	43(50)	141	41	70	32	0.3	0.3	1
	FBH3233B	●	FBB33N-□-□□	●	BT40-MD32F-115R	●	33(40)	43(50)	156	41	45	32	0.3	0.3	2
	FBH4042B	●	FBB42N-□-□□	●	BT40-MD40F-60	●	42(50)	54(62)	110	50	31	40	0.5	0.5	1
	FBH4042B	●	FBB42N-□-□□	●	BT40-MD40F-110R	●	42(50)	54(62)	160	50	60	40	0.5	0.5	2
	FBH4042B	●	FBB42N-□-□□	●	BT40-MD40F-115	●	42(50)	54(62)	165	50	83	40	0.5	0.5	1
	FBH5053B	●	FBB53N-□-□□	●	BT40-MD50F-105	●	53(65)	70(82)	163	58	73	50	0.8	0.9	1
	FBH6368B	●	FBB68N-□-□□	●	BT40-MD63F-64	●	68(90)	100(122)	145	81	37	63	2.1	2.3	3
	FBH6368B	●	FBB68N-□-□□	●	BT40-MD63F-110	●	68(90)	100(122)	191	81	83	63	2.1	2.3	3
	FBH6368B	●	FBB68N-□-□□	●	BT40-MD63F-135	●	68(90)	100(122)	216	81	108	63	2.1	2.3	3
	FBH6398B	●	FBB68N-□-□□	●	BT40-MD63F-64	●	98(120)	150(172)	165	101	37	63	3.6	3.8	3
	FBH6398B	●	FBB68N-□-□□	●	BT40-MD63F-110	●	98(120)	150(172)	211	101	83	63	3.6	3.8	3
	FBH6398B	●	FBB68N-□-□□	●	BT40-MD63F-135	●	98(120)	150(172)	236	101	108	63	3.6	3.8	3
	FBH8098B	●	FBB68N-□-□□	●	BT40-MD80F-100	●	98(120)	150(172)	201	101	73	80	4.8	5.1	3

- In the above table, the Arbor designation is an example designation and able to adjust the depth of boring with a combination of MD arbors and extension bars. For more details, see the MD arbor page. (Unit : mm)
- FBB bite is largely divided into general-type FBB□□N and extended-type (back boring) FBB□□N-1 and is available as FBB□□N-□-C09, FBB□□N-□-T11 depending on the insert.

Bite	Applicable Insert
FBB□□N, FBB□□N-1	TPGT TPGW0802□□L
FBB□□N-□-C	CCMT, CCGT0602□□L
FBB□□N-□-C09	CCMT, CCGT09T3□□L
FBB□□N-□-T11	TPGT1103□□L



BT-FBH/B

Micro Boring Bar(Balanced Type)



MAS 403-BT Shank
 G6.3 G value
 C Coolant System
 20 Min Range
 172 Max Range
 Boring

Fig.1

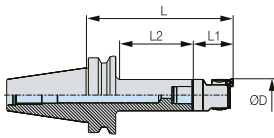

Fig.2

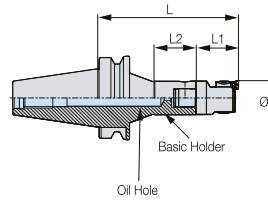
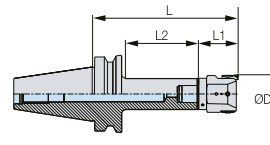
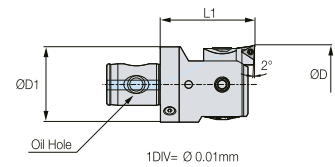

Fig.3



Head



- : Stock
- C Internal coolant system is basic
- ※ Red : Main Component Blue : For Separate Purchase

- For more information on product features, see 164P
- For more information on MD arbor, see 157P
- For more information on the related parts, see 172P
- For more information on FBB bite, see 177P

	Head Designation	Stock	Bite Designation	Stock	Arbor Designation	Stock	Boring Range(ØD)		L	L1	L2	ØD1	Head Weight (kg)	Head Package Weight(kg)	Fig
							Min.	Max.							
BT50	FBH1920B	●	FBB20N-□-□□	●	BT50-MD19F-85	●	20(24)	26(30)	120	35	44	19	0.2	0.2	1
	FBH2526B	●	FBB26N-□-□□	●	BT50-MD25F-105	●	26(32)	34(40)	146	41	62	25	0.2	0.2	1
	FBH2526B	●	FBB26N-□-□□	●	BT50-MD25F-120R	●	26(32)	34(40)	161	41	40	25	0.2	0.2	2
	FBH3233B	●	FBB33N-□-□□	●	BT50-MD32F-110	●	33(40)	43(50)	151	41	67	32	0.3	0.3	1
	FBH3233B	●	FBB33N-□-□□	●	BT50-MD32F-115R	●	33(40)	43(50)	156	41	45	32	0.3	0.3	2
	FBH3233B	●	FBB33N-□-□□	●	BT50-MD32F-235R	●	33(40)	43(50)	276	41	115	32	0.3	0.3	2
	FBH4042B	●	FBB42N-□-□□	●	BT50-MD40F-60	●	42(50)	54(62)	110	50	22	40	0.5	0.5	1
	FBH4042B	●	FBB42N-□-□□	●	BT50-MD40F-195	●	42(50)	54(62)	245	50	152	40	0.5	0.5	1
	FBH4042B	●	FBB42N-□-□□	●	BT50-MD40F-230R	●	42(50)	54(62)	280	50	180	40	0.5	0.5	2
	FBH5053B	●	FBB53N-□-□□	●	BT50-MD50F-125	●	53(65)	70(82)	183	58	82	50	0.8	0.9	1
	FBH5053B	●	FBB53N-□-□□	●	BT50-MD50F-225	●	53(65)	70(82)	283	58	182	50	0.8	0.9	1
	FBH5053B	●	FBB53N-□-□□	●	BT50-MD50F-250R	●	53(65)	70(82)	308	58	81	50	0.8	0.9	2
	FBH6368B	●	FBB68N-□-□□	●	BT50-MD63F-75	●	68(90)	100(122)	156	81	37	63	2.1	2.3	1
	FBH6368B	●	FBB68N-□-□□	●	BT50-MD63F-130	●	68(90)	100(122)	211	81	87	63	2.1	2.3	1
	FBH6368B	●	FBB68N-□-□□	●	BT50-MD63F-195	●	68(90)	100(122)	276	81	152	63	2.1	2.3	1
	FBH6368B	●	FBB68N-□-□□	●	BT50-MD63F-230	●	68(90)	100(122)	311	81	187	63	2.1	2.3	1
	FBH6398B	●	FBB68N-□-□□	●	BT50-MD63F-75	●	98(120)	150(172)	176	101	37	63	3.6	3.8	3
	FBH6398B	●	FBB68N-□-□□	●	BT50-MD63F-130	●	98(120)	150(172)	231	101	87	63	3.6	3.8	3
	FBH6398B	●	FBB68N-□-□□	●	BT50-MD63F-195	●	98(120)	150(172)	296	101	152	63	3.6	3.8	3
	FBH6398B	●	FBB68N-□-□□	●	BT50-MD63F-230	●	98(120)	150(172)	331	101	187	63	3.6	3.8	3
FBH8098B	●	FBB68N-□-□□	●	BT50-MD80F-75	●	98(120)	150(172)	176	101	36	80	4.8	5.1	3	
FBH8098B	●	FBB68N-□-□□	●	BT50-MD80F-110	●	98(120)	150(172)	211	101	69	80	4.8	5.1	3	
FBH8098B	●	FBB68N-□-□□	●	BT50-MD80F-175	●	98(120)	150(172)	276	101	134	80	4.8	5.1	3	

- In the above table, the Arbor designation is an example designation and able to adjust the depth of boring with a combination of MD arbors and extension bars. For more details, see the MD arbor page. (Unit : mm)
- FBB bite is largely divided into general-type FBB□□N and extended-type (back boring) FBB□□N-1 and is available as FBB□□N-□-C09, FBB□□N-□-T11 depending on the insert.

Bite	Applicable Insert
FBB□□N, FBB□□N-1	TPGT TPGW0802□□L
FBB□□N-□-C	CCMT, CCGT0602□□L
FBB□□N-□-C09	CCMT, CCGT09T3□□L
FBB□□N-□-T11	TPGT1103□□L

1:1 CHAT



HSK-FBH/B

Micro Boring Bar(Balanced Type)

DIN
69893-1

Shank

G6.3

G value

C

Coolant System

20

Min Range

172

Max Range



Boring

Fig.1

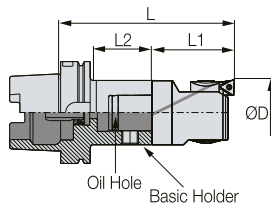
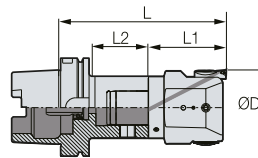
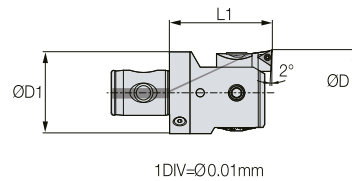

Fig.2



Head



● : Stock

□ Internal coolant system is optional

※ Red : Main Component Blue : For Separate Purchase

• For more information on product features, see **164P**

• For more information on MD arbor, see **158P**

• For more information on the related parts, see **172P**

• For more information on FBB bite, see **177P**

	Head Designation	Stock	Bite Designation	Stock	Arbor Designation	Stock	Boring Range(ØD)		L	L1	L2	ØD1	Head Weight(kg)	Head Package Weight(kg)	Fig.
							Min.	Max.							
HSK63A	FBH1920B	●	FBB20N-□-□□	●	HSK63A-MD19F-60	●	20(24)	26(30)	95	35	31	19	0.2	0.2	1
	FBH2526B	●	FBB26N-□-□□	●	HSK63A-MD25F-60	●	26(32)	34(40)	101	41	31	25	0.2	0.2	1
	FBH3233B	●	FBB33N-□-□□	●	HSK63A-MD32F-65	●	33(40)	43(50)	106	41	36	32	0.3	0.3	1
	FBH4042B	●	FBB42N-□-□□	●	HSK63A-MD40F-70	●	42(50)	54(62)	120	50	41	40	0.5	0.5	1
	FBH5053B	●	FBB53N-□-□□	●	HSK63A-MD50F-85	●	53(65)	70(82)	143	58	58	50	0.8	0.9	1
	FBH6368B	●	FBB68N-□-□□	●	HSK63A-MD63F-95	●	68(90)	100(122)	176	81	69	63	2.1	2.3	1
	FBH6398B	●	FBB68N-□-□□	●	HSK63A-MD63F-95	●	98(120)	150(172)	196	101	69	63	3.6	3.8	2

• In the above table, the Arbor designation is an example designation and able to adjust the depth of boring with a combination of MD arbors and extension bars. For more details, see the MD arbor page.

(Unit : mm)

• FBB bite is largely divided into general-type FBB□□N and extended-type (back boring) FBB□□N-1 and is available as FBB□□N-□-C09, FBB□□N-□-T11 depending on the insert.

Bite	Applicable Insert
FBB□□N, FBB□□N-1	TPGT TPGW0802□□L
FBB□□N-□-C	CCMT, CCGT0602□□L
FBB□□N-□-C09	CCMT, CCGT09T3□□L
FBB□□N-□-T11	TPGT1103□□L

Accessories

SPARE PART	Type	Accessories	
		Coolant Tube for HSK	Wrench
	Images		
	Designation	HSK63A-CNS	HSK63-WRENCH(C)

1:1 CHAT



SK-FBH/B

Micro Boring Bar(Balanced Type)



DIN69871
-1A/B

Shank

G6.3

G value

C

Coolant System

26

Min Range

172

Max Range



Boring

Fig.1

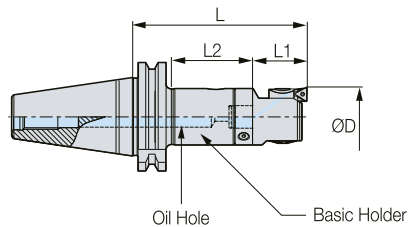

Fig.2

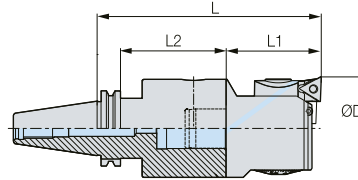
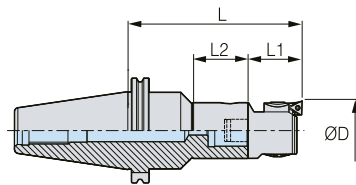
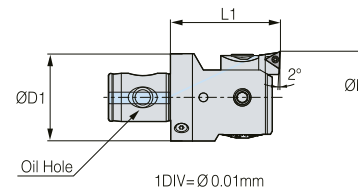

Fig.3



Head



● : Stock

C Internal coolant system is basic

※ Red : Main Component Blue : For Separate Purchase

- For more information on product features, see **164P**
- For more information on MD arbor, see **159P**
- For more information on the related parts, see **172P**
- For more information on FBB bite, see **177P**

	Head Designation	Stock	Bite Designation	Stock	Arbor Designation	Stock	Boring Range(ØD)		L	L1	L2	ØD1	Head Weight (kg)	Head Package Weight(kg)	Fig.
							Min.	Max.							
SK40	FBH2526B	●	FBB26N-□-□□	●	SK40-MD25F-80R	●	26(32)	34(40)	121	41	22	25	0.2	0.2	3
	FBH3233B	●	FBB33N-□-□□	●	SK40-MD32F-115R	●	33(40)	43(50)	156	41	36	32	0.3	0.3	3
	FBH4042B	●	FBB42N-□-□□	●	SK40-MD40F-100	●	42(50)	54(62)	150	50	80	40	0.5	0.5	1
	FBH5053B	●	FBB53N-□-□□	●	SK40-MD50F-100	●	53(65)	70(82)	158	58	80	50	0.8	0.9	1
	FBH6368B	●	FBB68N-□-□□	●	SK40-MD63F-70	●	68(90)	100(122)	151	81	50	63	2.1	2.3	2
	FBH6398B	●	FBB68N-□-□□	●	SK40-MD63F-70	●	98(120)	150(172)	171	101	50	63	3.6	3.8	2
SK50	FBH2526B	●	FBB26N-□-□□	●	SK50-MD25F-105R	●	26(32)	34(40)	146	41	22	25	0.2	0.2	3
	FBH3233B	●	FBB33N-□-□□	●	SK50-MD32F-110	●	33(40)	43(50)	151	41	87	32	0.3	0.3	1
	FBH4042B	●	FBB42N-□-□□	●	SK50-MD40F-145	●	42(50)	54(62)	195	50	120	40	0.5	0.5	1
	FBH5053B	●	FBB53N-□-□□	●	SK50-MD50F-240R	●	53(65)	70(82)	298	58	125	50	0.8	0.9	3
	FBH6368B	●	FBB68N-□-□□	●	SK50-MD63F-130	●	68(90)	100(122)	211	81	107	63	2.1	2.3	1
	FBH6398B	●	FBB68N-□-□□	●	SK50-MD63F-130	●	98(120)	150(172)	231	101	107	63	3.6	3.8	1
	FBH8098B	●	FBB68N-□-□□	●	SK50-MD80F-150	●	98(120)	150(172)	251	101	130	80	4.8	5.1	1

• In the above table, the Arbor designation is an example designation and able to adjust the depth of boring with a combination of MD arbors and extension bars. For more details, see the MD arbor page.

(Unit : mm)

• FBB bite is largely divided into general-type FBB□□N and extended-type (back boring) FBB□□N-1 and is available as FBB□□N-□-C09, FBB□□N-□-T11 depending on the insert.

Bite	Applicable Insert
FBB□□N, FBB□□N-1	TPGT TPGW0802□□L
FBB□□N-□-C	CCMT, CCGT0602□□L
FBB□□N-□-C09	CCMT, CCGT09T3□□L
FBB□□N-□-T11	TPGT1103□□L

1:1 CHAT



S-FBH/B

Micro Boring Bar(Balanced Type)



CARBIDE Shank
 STEEL Shank
 C Coolant System
 20 Min Range
 43 Max Range
 Boring

Head

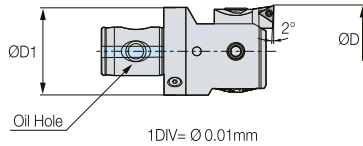
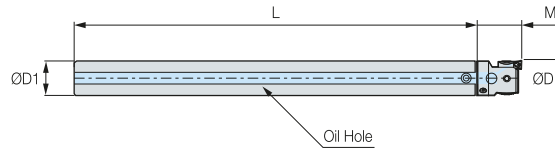

Fig.1



- : Stock
- C** Internal coolant system is basic
- ※ □□W : Cemented carbide shank / □□ : Steel shank

- For more information on product features, see **164P**
- For more information on the related parts, see **172P**
- For more information on FBB bite, see **177P**

	Designation	Boring Range(ØD)		L	ØD1	M	Main Component			kg	Package Weight(kg)	Stock	
		Min.	Max.				Shank	Boring Head	Bite				
Carbide Shank	S19W-FBH20B-120	20	26	157	19	35	S19W-MD19F-157	FBH1920B	FBB20N	0.6	0.7	●	
	S19W-FBH20B-140	20	26	177	19	35	S19W-MD19F-177	FBH1920B	FBB20N	0.7	0.8	●	
	S19W-FBH20B-160	20	26	197	19	35	S19W-MD19F-197	FBH1920B	FBB20N	0.8	0.9	●	
	S25W-FBH26B-150	26	34	197	25	41	S25W-MD25F-197.5	FBH2526B	FBB26N	1.4	1.5	●	
	S25W-FBH26B-175	26	34	222	25	41	S25W-MD25F-222.5	FBH2526B	FBB26N	1.6	1.7	●	
	S25W-FBH26B-200	26	34	247	25	41	S25W-MD25F-247.5	FBH2526B	FBB26N	1.8	1.9	●	
	S32W-FBH33B-180	33	43	239	32	41	S32W-MD32F-239	FBH3233B	FBB33N	2.7	2.8	●	
	S32W-FBH33B-240	33	43	299	32	41	S32W-MD32F-299	FBH3233B	FBB33N	3.4	3.5	●	
Steel Shank	S19-FBH20B-40	20	26	77	19	35	S19-MD19F-77	FBH1920B	FBB20N	0.2	0.3	●	
	S19-FBH20B-80	20	26	117	19	35	S19-MD19F-117	FBH1920B	FBB20N	0.2	0.3	●	
	S25-FBH26B-50	26	34	97	25	41	S25-MD25F-97.5	FBH2526B	FBB26N	0.4	0.5	●	
	S25-FBH26B-100	26	34	147	25	41	S25-MD25F-147.5	FBH2526B	FBB26N	0.6	0.7	●	
	S32-FBH33B-90	33	43	149	32	41	S32-MD32F-149	FBH3233B	FBB33N	1.1	1.2	●	
	S32-FBH33B-120	33	43	179	32	41	S32-MD32F-179	FBH3233B	FBB33N	1.2	1.3	●	

• FBB bite is largely divided into general-type FBB□□N and extended-type (back boring) FBB□□N-1 and is available as FBB□□N-□-C09, FBB□□N-□-T11 depending on the insert. (Unit : mm)

Bite	Applicable Insert
FBB□□N, FBB□□N-1	TPGT TPGW0802□□L
FBB□□N-□-C	CCMT, CCGT0602□□L

1:1 CHAT



S-FBH

Small Micro Boring Bar with Carbide/Steel



- CARBIDE
 - STEEL
 - C
 - 15
 - 22
 - 
- Shank Shank Coolant System Min Range Max Range Boring

Head

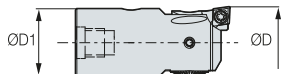
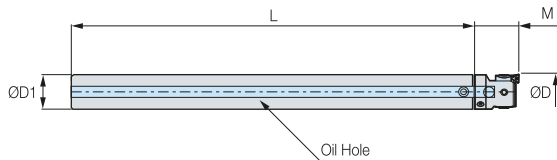

Fig.1



- ● : Stock
- C Internal coolant system is basic
- ※ □□W : Cemented carbide shank / □□□ : Steel shank

- For more information on product features, see 164P
- For more information on the related parts, see 172P
- For more information on FBB bite, see 177P

	Designation	Boring Range(ØD)		L	ØD1	M	Main Component			kg	Package Weight(kg)	Stock
		Min.	Max.				Shank	Boring Head	Bite			
Carbide Shank	S14W-FBH15-85	15	18	123.25	14	31.75	S14W-M6-123	FBH15	FBB15-C	0.3	0.4	●
	S14W-FBH15-110	15	18	148.25	14	31.75	S14W-M6-148	FBH15	FBB15-C	0.3	0.4	●
	S16W-FBH18-95	18	22	128.25	16	36.75	S16W-M8-128	FBH18	FBB15-C	0.4	0.5	●
	S16W-FBH18-125	18	22	158.25	16	36.75	S16W-M8-158	FBH18	FBB15-C	0.5	0.6	●
Steel Shank	S14-FBH15-40	15	18	78.25	14	31.75	S14-M6-78	FBH15	FBB15-C	0.1	0.2	●
	S16-FBH18-45	18	22	78.25	16	36.75	S16-M8-78	FBH18	FBB15-C	0.1	0.2	●

(Unit : mm)

Bite FBB15-C	Applicable Insert CCET0301□□-L
-----------------	-----------------------------------

Chuck
 Arbor/Modular
 Boring Tool
 Angular Head
 CBN/PCD
 Device&Accessory
 Standard

1:1 CHAT





FBH/B SPARE PART

Micro Boring Balanced Type Related Parts



SPARE PART

Main Components		
Type(FBH/B)	Lock Screw	Wrench
		
FBH1920B	BTF0404	LW-2
FBH2526B	BTF0505	LW-2.5
FBH3233B	BTF0606	LW-3
FBH4042B	BTF0808	LW-4
FBH5053B	BTF0812	LW-4
FBH6368B	BTF1016	LW-5
FBH6398B	BTF1010	LW-5
FBH8098B	BTF1016	LW-5

1:1 CHAT



FBH SPARE PART

Micro Boring Related Parts



SPARE PART

Main Components					
Type(FBH)	Lock Screw	FBB	Clamp Screw	Insert Screw	Wrench
					
FBH15	BT0303	FBB15-C	BFTX02505N	BFTX01604N	LW-1.5/TRX6
FBH18	BT0304	FBB15-C	BFTX02505N	BFTX01604N	LW-1.5/TRX6

1:1 CHAT



FBH/D NEW

Micro Boring Bar(Damping Type)



G6.3

G value

C

Coolant System



Damping



Boring



Features

- Stable use on the deep holes is possible through the damping system (Max. 6D)
- Minimum diameter (Ø26)-based 6D processing (Max. insertion depth L=160mm)
- Tool life and the ability to bore difficult materials can be increased by reducing impact due to the damping effect
- Both internal and external coolants are available

NAMING

FBH	25	26	D
Fine Boring Head	MD Arbor Size	Boring Range[Min]	Damping

Machining Conditions

Cutting Speed(m/min)	150~200
Feed Rate(mm/rev)	0.06~0.1
Depth of Cut(mm)	0.1 (One side)

Vibration Waveform Comparison

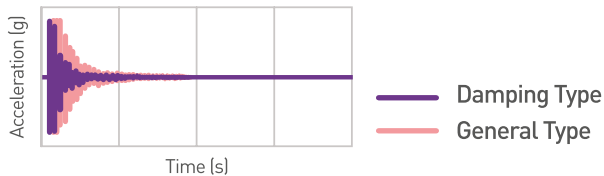

- A damping mechanism is built into the product to minimize vibration.

Precautions

- Performance may vary depending on conditions, so it is required to perform the work under the recommended conditions as much as possible.
 - Inner oil supply Max. 60 bar
 - Performance may decrease by arbitrary disassembly or impact.
- ※ The head and holder are integrated, so they cannot be disassembled.



General Boring Tool



Insert damage or Severe shaking

Damping Boring Tool



Fine machining without vibration

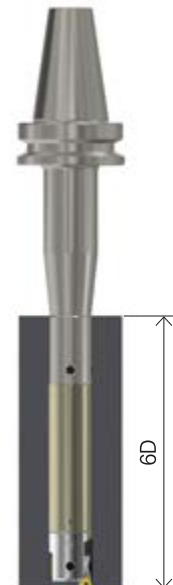

Min. Diameter(D)

1:1 CHAT



BT-FBH/D

NEW

Micro Boring Bar(Damping Type)

MAS
403-BT

Shank

G6.3

G value

C

Coolant System

26

Min Range

40

Max Range



Damping



Boring

Fig.1

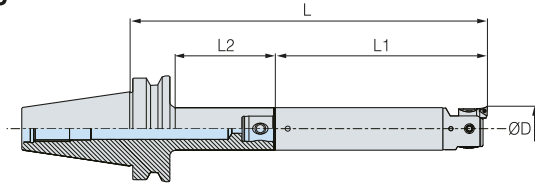
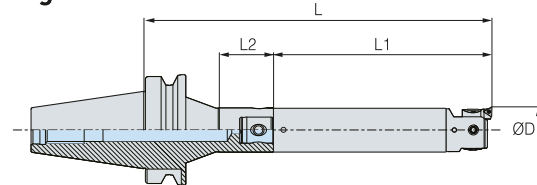
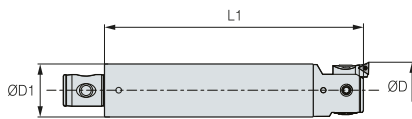

Fig.2



Head



● : Stock

C Internal coolant system is basic

※ Red : Main Component Blue : For Separate Purchase

• For more information on product features, see 173P

• For more information on FBB bite, see 177P

	Head Designation	Stock	Bite Designation	Stock	Arbor Designation	Stock	Boring Range(ØD)		L	L1	L2	ØD1	kg	Package Weight(kg)	Fig
							Min.	Max.							
BT40	FBH2526D	●	FBB26N-□-□□	●	BT40-MD25F-95	●	26(32)	34(40)	215	120	63	25	0.5	0.5	1
	FBH2526D	●	FBB26N-□-□□	●	BT40-MD25F-105R	●	26(32)	34(40)	225	120	40	25	0.5	0.5	2
BT50	FBH2526D	●	FBB26N-□-□□	●	BT50-MD25F-105	●	26(32)	34(40)	225	120	62	25	0.5	0.5	1
	FBH2526D	●	FBB26N-□-□□	●	BT50-MD25F-120R	●	26(32)	34(40)	240	120	40	25	0.5	0.5	2
	FBH2526D	●	FBB26N-□-□□	●	BT50-MD25F-165	●	26(32)	34(40)	285	120	122	25	0.5	0.5	1

(Unit : mm)

1:1 CHAT



SK-FBH/D NEW

Micro Boring Bar(Damping Type)

DIN
69871-1A/B

Shank

G6.3

G value

C

Coolant System

26

Min Range

40

Max Range



Damping



Boring

Fig.1

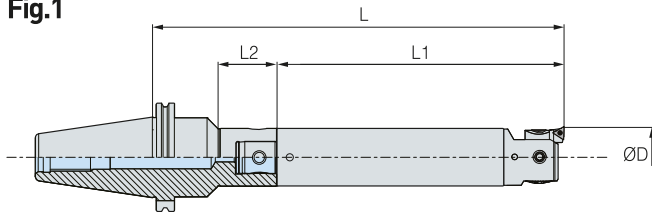

Head

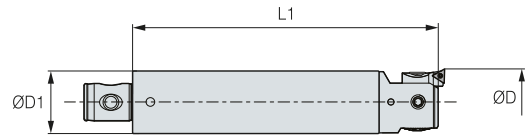

● : Stock

C Internal coolant system is basic

※ Red : Main Component Blue : For Separate Purchase

• For more information on product features, see 173P

• For more information on FBB bite, see 177P

	Head Designation	Stock	Bite Designation	Stock	Arbor Designation	Stock	Boring Range(ØD)		L	L1	L2	ØD1	kg	Package Weight(kg)	Fig
							Min.	Max.							
SK40	FBH2526D	●	FBB26N-□-□□	●	SK40-MD25F-80R	●	26(32)	34(40)	200	120	22	25	0.5	0.5	1
SK50	FBH2526D	●	FBB26N-□-□□	●	SK50-MD25F-105R	●	26(32)	34(40)	225	120	22	25	0.5	0.5	1

(Unit : mm)

1:1 CHAT



DBCA

New Balance Cut Tool



Coolant System

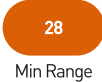

Min Range



Max Range



Boring



Features

- Bidirectional simultaneous diameter adjustment is available due to the twin control structure
- Machining rigidity is reinforced due to the cartridge assist design
- Broader machining area than the existing products
- Boring range : $\varnothing 28$ – $\varnothing 130$ (mm)

NAMING

DBCA	32	33	S	H
New Balance Cut Tool	MD Arbor Size	Min. Boring diameter	Bcc Cartridge Set	H : Helical Type Non : Straight Type

Main Features

Helical Type

- Improved capacity to discharge chips from clogged and deep holes
- Minimized damage to tools and insert due to chip clogging

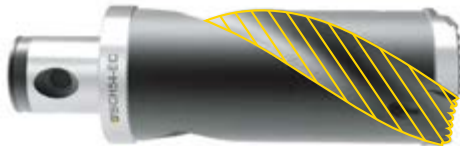

Extended Head Length	Deep hole machining implemented
Helical Type	Improved capacity to discharge chips from holes

Boring Area Optimization

- Max. diameter expanded owing to reinforced rigidity
- Boring range expanded per designation versus conventional boring range of DINE

Coolant Injection Hole



Coolant Hole (Direct Injection to Cutting Edge)	<ul style="list-style-type: none"> • Improved capacity to discharge chips • Improved capacity of machining
---	--

Effect of Improved Rigidity for Cartridge by Cover

Clamps the top of the cartridge stably, minimizing the vibration of tools and improving the roughness of the working surface

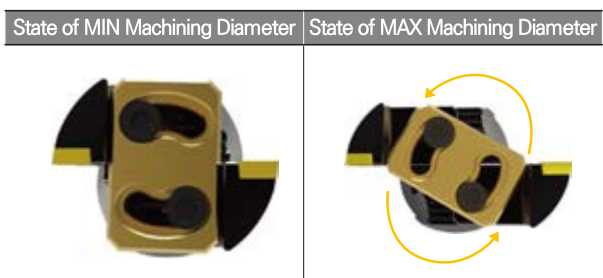
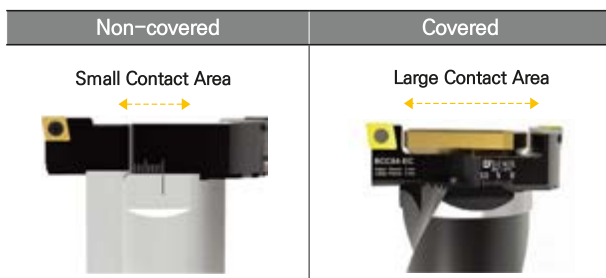

1:1 CHAT



DBCA

New Balance Cut Tool



Comparison with Competitors

Verifying of less vibration due to improved rigidity and smooth chip discharge

→ Superior performance compared to competitors

Manufacturer	L/D	Surface Roughness (RA)	Special Note	Machined Surface
Company A	5D	3.82	Vibration occurred	
Company B	5D	2.46	Vibration occurred, Chips tangled	
DINE	5D	2.19	Well-machined surface, No chip tangled	

New Machining Range versus Old Machining Range of DINE

DBC

DBCA



Designation	Boring Range ØD		Designation	Boring Range ØD	
	Min.	Max.		Min.	Max.
DBC2528S	28	35	DBCA2528S-H	28	38
DBC3235S	35	46	DBCA3238S-H	38	54
DBC4046S	46	58	DBCA5054S-H	54	74
DBC5058S	58	74	DBCA6374S-H	74	100
DBC6347S	74	94	DBCA80100S-H	100	130
DBC8094S	94	120			

(Unit : mm)

Comparison with Competitors

Machining Conditions	Cutting Speed (m/min)	Feed (mm/rev)	Depth of Cut (mm)	Material	Item	Depth of Hall (mm)
	200	0.08	2	S45C	Penetration Hall	30

Manufacturer	Insert	Gauge Line (Head+Shank)	Boring Diameter (mm)	L/D	Surface Roughness (RA)	Special Notes	Machined Surface	Tool Top	Tool Side
Competitor A	SCMT09T0304	164	Ø35	4.68	3.82	Vibration occurred			
Competitor B	CCMT080204	180	Ø35	5.14	2.46	Vibration occurred, Chips tangled			
DINE	CCMT060204	175	Ø35	5	2.19	Wellmachined surface, No chip tangled			

1:1 CHAT



BT-DBCA-H (Helical Type)

New Balance Cut Tool(Helical Type)



MAS
403-BT
C
28
130

Shank Coolant System Min Range Max Range Boring

Fig.1

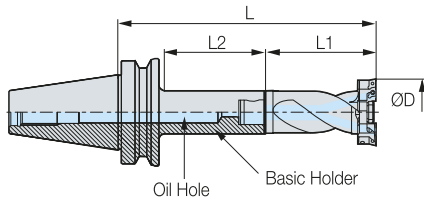

Fig.2

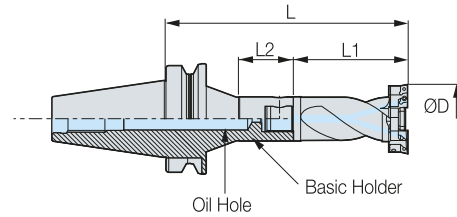
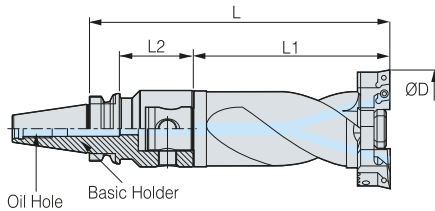
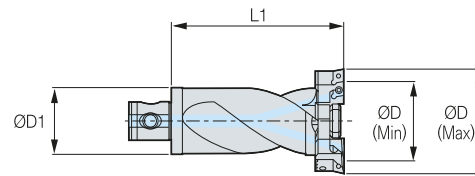

Fig.3



Head



1DIV= Ø 0.01mm

● : Stock

■ Internal coolant system is basic

※ Red : Main Component Blue : For Separate Purchase

• For more information on product features, see **178P**

• For more information on MD arbor, see **156P**

• For more information on the related parts, see **192P**

• For more information on the applicable insert, see **193P**

	Head Designation	Stock	Arbor Designation	Stock	Boring Range(ØD)		L	L1	L2	ØD1	Fig.	Head Weight (kg)	Head Package Weight(kg)
					Min.	Max.							
BT30	DBCA2528S-H	●	BT30-MD25F-90	●	28	38	193	103	63	25	1	0.3	0.3
	DBCA3238S-H	●	BT30-MD32F-80	●	38	54	190	110	55	32	1	0.5	0.6
	DBCA5054S-H	●	BT30-MD50F-70	●	54	74	215	145	48	50	3	1.8	1.9
BT40	DBCA2528S-H	●	BT40-MD25F-95	●	28	38	198	103	63	25	1	0.3	0.3
	DBCA2528S-H	●	BT40-MD25F-105R	●	28	38	208	103	41	25	2	0.3	0.3
	DBCA3238S-H	●	BT40-MD32F-100	●	38	54	210	110	70	32	1	0.5	0.6
	DBCA3238S-H	●	BT40-MD32F-115R	●	38	54	225	110	46	32	2	0.5	0.6
	DBCA5054S-H	●	BT40-MD50F-105	●	54	74	250	145	73	50	1	1.8	1.9
	DBCA6374S-H	●	BT40-MD63F-64	●	74	100	244	180	37	63	1	3.3	3.5
	DBCA6374S-H	●	BT40-MD63F-110	●	74	100	290	180	83	63	1	3.3	3.5
	DBCA6374S-H	●	BT40-MD63F-135	●	74	100	315	180	108	63	1	3.3	3.5
	DBCA80100S-H	●	BT40-MD80F-100	●	100	130	315	215	73	80	3	7.3	7.6

• In the above table, the Arbor designation is an example designation and able to adjust the depth of boring with a combination of MD arbors and extension bars. For more details, see the MD arbor page

(Unit : mm)

- DBCA2528S-H : CCMT0602□□
- DBCA3238S-H : CCMT0602□□
- DBCA5054S-H : CCMT09T3□□
- DBCA6374S-H : CCMT1204□□
- DBCA80100S-H : CCMT1204□□

1:1 CHAT



BT-DBCA-H (Helical Type)

New Balance Cut Tool(Helical Type)



MAS 403-BT Shank
 C Coolant System
 28 Min Range
 130 Max Range
 Boring

Fig.1

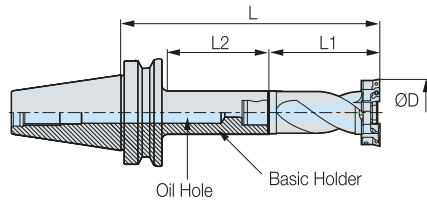
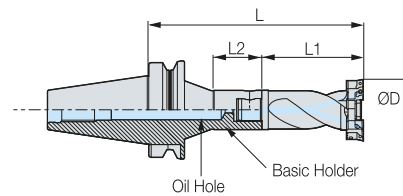
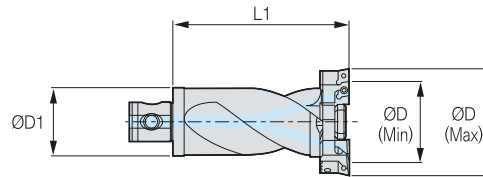

Fig.2



Head



1DIV= Ø 0.01mm

● : Stock

C Internal coolant system is basic

※ Red : Main Component Blue : For Separate Purchase

• For more information on product features, see [178P](#)

• For more information on MD arbor, see [157P](#)

• For more information on the related parts, see [192P](#)

• For more information on the applicable insert, see [193P](#)

	Head Designation	Stock	Arbor Designation	Stock	Boring Range(ØD)		L	L1	L2	ØD1	Fig.	Head Weight(kg)	Head Package Weight(kg)
					Min.	Max.							
BT50	DBCA2528S-H	●	BT50-MD25F-105	●	28	38	208	103	62	25	1	0.3	0.3
	DBCA2528S-H	●	BT50-MD25F-120R	●	28	38	223	103	41	25	2	0.3	0.3
	DBCA3238S-H	●	BT50-MD32F-110	●	38	54	220	110	67	32	1	0.5	0.6
	DBCA3238S-H	●	BT50-MD32F-115R	●	38	54	225	110	46	32	2	0.5	0.6
	DBCA3238S-H	●	BT50-MD32F-235R	●	38	54	345	110	115	32	2	0.5	0.6
	DBCA5054S-H	●	BT50-MD50F-125	●	54	74	270	145	82	50	1	1.8	1.9
	DBCA5054S-H	●	BT50-MD50F-225	●	54	74	370	145	182	50	1	1.8	1.9
	DBCA5054S-H	●	BT50-MD50F-250R	●	54	74	395	145	81	50	2	1.8	1.9
	DBCA6374S-H	●	BT50-MD63F-75	●	74	100	255	180	35	63	1	3.3	3.5
	DBCA6374S-H	●	BT50-MD63F-130	●	74	100	310	180	87	63	1	3.3	3.5
	DBCA6374S-H	●	BT50-MD63F-195	●	74	100	375	180	152	63	1	3.3	3.5
	DBCA6374S-H	●	BT50-MD63F-230	●	74	100	410	180	187	63	1	3.3	3.5
	DBCA80100S-H	●	BT50-MD80F-75	●	100	130	290	215	36	80	1	7.3	7.6
	DBCA80100S-H	●	BT50-MD80F-110	●	100	130	325	215	69	80	1	7.3	7.6
	DBCA80100S-H	●	BT50-MD80F-175	●	100	130	390	215	134	80	1	7.3	7.6

• In the above table, the Arbor designation is an example designation and able to adjust the depth of boring with a combination of MD arbors and extension bars. For more details, see the MD arbor page

(Unit : mm)

- DBCA2528S-H : CCMT0602□□
- DBCA3238S-H : CCMT0602□□
- DBCA5054S-H : CCMT09T3□□
- DBCA6374S-H : CCMT1204□□
- DBCA80100S-H : CCMT1204□□



HSK-DBCA-H (Helical Type)

New Balance Cut Tool(Helical Type)



DIN 69893-1
C
28
100

Shank Coolant System Min Range Max Range Boring

Fig.1

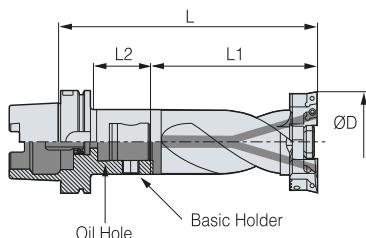
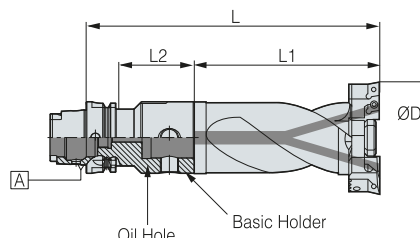
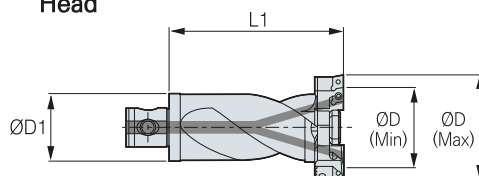

Fig.2



Head



1DIV=Ø0.01mm

● : Stock

☐ Internal coolant system is optional

※ Red : Main Component Blue : For Separate Purchase

• For more information on product features, see **178P**

• For more information on MD arbor, see **158P**

• For more information on the related parts, see **192P**

• For more information on the applicable insert, see **193P**

	Head Designation	Stock	Arbor Designation	Stock	Boring Range(ØD)		L	L1	L2	ØD1	Fig.	Head Weight(kg)	Head Package Weight(kg)
					Min.	Max.							
HSK63A	DBCA2528S-H	●	HSK63A-MD25F-60	●	28	38	163	103	31	25	1	0.3	0.3
	DBCA3238S-H	●	HSK63A-MD32F-65	●	38	54	175	110	36	32	1	0.5	0.6
	DBCA5054S-H	●	HSK63A-MD50F-85	●	54	74	230	145	58	50	1	1.8	1.9
	DBCA6374S-H	●	HSK63A-MD63F-95	●	74	100	275	180	69	63	2	3.3	3.5

• In the above table, the Arbor designation is an example designation and able to adjust the depth of boring with a combination of MD arbors and extension bars. For more details, see the MD arbor page. (Unit : mm)

- DBCA2528S-H : CCMT0602☐☐
- DBCA3238S-H : CCMT0602☐☐
- DBCA5054S-H : CCMT09T3☐☐
- DBCA6374S-H : CCMT1204☐☐
- DBCA80100S-H : CCMT1204☐☐

Accessories

SPARE PART	Type	Accessories	
	Images	Coolant Tube for HSK	Wrench
	Designation		
	HSK63A	HSK63A-CNS	HSK63-WRENCH(C)

1:1 CHAT



SK-DBCA-H (Helical Type)

New Balance Cut Tool(Helical Type)



DIN 69871-1A/B

Shank

C

Coolant System

28

Min Range

130

Max Range



Boring

Fig.1

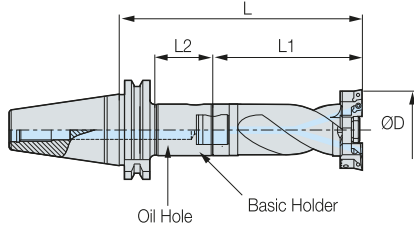

Fig.2

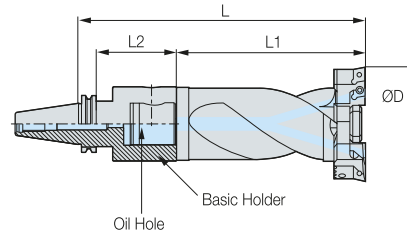
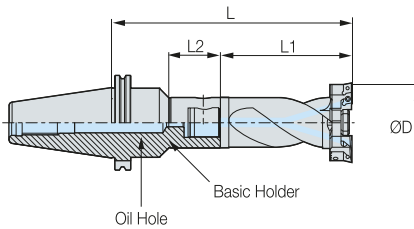
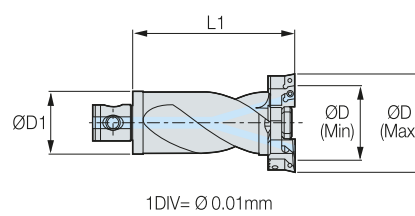

Fig.3



Head



1DIV= Ø 0.01mm

● : Stock

■ Internal coolant system is basic

※ Red : Main Component Blue : For Separate Purchase

• For more information on product features, see [178P](#)

• For more information on MD arbor, see [159P](#)

• For more information on the related parts, see [192P](#)

• For more information on the applicable insert, see [193P](#)

	Head Designation	Stock	Arbor Designation	Stock	Boring Range(ØD)		L	L1	L2	ØD1	Fig.	Head Weight (kg)	Head Package Weight(kg)
					Min.	Max.							
SK40	DBCA2528S-H	●	SK40-MD25F-80R	●	28	38	183	103	22	25	3	0.3	0.3
	DBCA3238S-H	●	SK40-MD32F-115R	●	38	54	225	110	36	32	3	0.5	0.6
	DBCA5054S-H	●	SK40-MD50F-75	●	54	74	220	145	55	50	1	1.8	1.9
	DBCA5054S-H	●	SK40-MD50F-100	●	54	74	245	145	80	50	1	1.8	1.9
	DBCA6374S-H	●	SK40-MD63F-70	●	74	100	250	180	50	63	2	3.3	3.5
SK50	DBCA2528S-H	●	SK50-MD25F-80R	●	28	38	183	103	22	25	3	0.3	0.3
	DBCA2528S-H	●	SK50-MD25F-105R	●	28	38	208	103	22	25	3	0.3	0.3
	DBCA3238S-H	●	SK50-MD32F-110	●	38	54	220	110	87	32	1	0.5	0.6
	DBCA3238S-H	●	SK50-MD32F-110R	●	38	54	220	110	36	32	3	0.5	0.6
	DBCA5054S-H	●	SK50-MD50F-125R	●	54	74	270	145	60	50	3	1.8	1.9
	DBCA5054S-H	●	SK50-MD50F-240R	●	54	74	385	145	125	50	3	1.8	1.9
	DBCA6374S-H	●	SK50-MD63F-75	●	74	100	255	180	52	63	1	3.3	3.5
	DBCA6374S-H	●	SK50-MD63F-130	●	74	100	310	180	107	63	1	3.3	3.5
	DBCA6374S-H	●	SK50-MD63F-230R	●	74	100	410	180	149	63	3	3.3	3.5
	DBCA80100S-H	●	SK50-MD80F-95	●	100	130	310	215	75	80	1	7.3	7.6
	DBCA80100S-H	●	SK50-MD80F-150	●	100	130	365	215	129	80	1	7.3	7.6

• In the above table, the Arbor designation is an example designation and able to adjust the depth of boring with a combination of MD arbors and extension bars. For more details, see the MD arbor page.

(Unit : mm)

- DBCA2528S-H : CCMT0602□□
- DBCA3238S-H : CCMT0602□□
- DBCA5054S-H : CCMT09T3□□
- DBCA6374S-H : CCMT1204□□
- DBCA80100S-H : CCMT1204□□

1:1 CHAT



BT-DBCA

New Balance Cut Tool(Straight Type)



MAS
403-BT
C
28
130

Shank Coolant System Min Range Max Range Boring

Fig.1

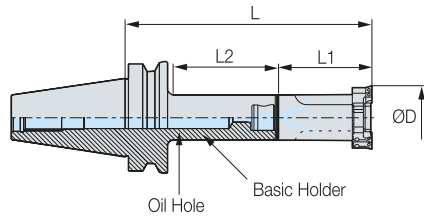

Fig.2

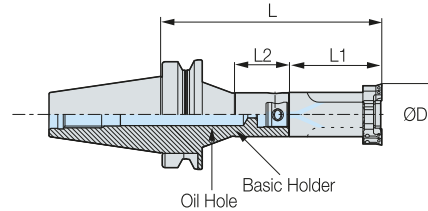
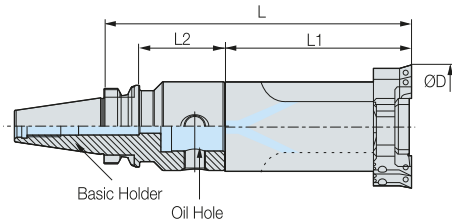
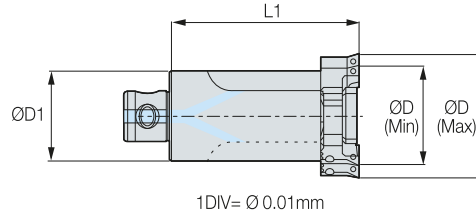

Fig.3



Head



● : Stock

■ Internal coolant system is basic

※ Red : Main Component Blue : For Separate Purchase

• For more information on product features, see **178P**

• For more information on MD arbor, see **156P**

• For more information on the related parts, see **192P**

• For more information on the applicable insert, see **193P**

	Head Designation	Stock	Arbor Designation	Stock	Boring Range(ØD)		L	L1	L2	ØD1	Fig.	Head Weight(kg)	Head Package Weight(kg)
					Min.	Max.							
BT30	DBCA2528S	●	BT30-MD25F-90	●	28	38	150	60	63	25	1	0.2	0.2
	DBCA3238S	●	BT30-MD32F-80	●	38	54	145	65	55	32	1	0.4	0.4
	DBCA5054S	●	BT30-MD50F-70	●	54	74	150	80	48	50	3	1.1	1.1
BT40	DBCA2528S	●	BT40-MD25F-95	●	28	38	155	60	63	25	1	0.2	0.2
	DBCA2528S	●	BT40-MD25F-105R	●	28	38	165	60	41	25	2	0.2	0.2
	DBCA3238S	●	BT40-MD32F-100	●	38	54	165	65	70	32	1	0.4	0.4
	DBCA3238S	●	BT40-MD32F-115R	●	38	54	180	65	46	32	2	0.4	0.4
	DBCA5054S	●	BT40-MD50F-105	●	54	74	185	80	73	50	1	1.1	1.1
	DBCA6374S	●	BT40-MD63F-64	●	74	100	154	90	37	63	1	1.9	2.1
	DBCA6374S	●	BT40-MD63F-110	●	74	100	200	90	83	63	1	1.9	2.1
	DBCA6374S	●	BT40-MD63F-135	●	74	100	225	90	108	63	1	1.9	2.1
	DBCA80100S	●	BT40-MD80F-100	●	100	130	200	100	73	80	3	3.7	3.9

• In the above table, the Arbor designation is an example designation and able to adjust the depth of boring with a combination of MD arbors and extension bars. For more details, see the MD arbor page.

(Unit : mm)

- DBCA2528S : CCMT0602□□
- DBCA3238S : CCMT0602□□
- DBCA5054S : CCMT09T3□□
- DBCA6374S : CCMT1204□□
- DBCA80100S : CCMT1204□□



BT-DBCA

New Balance Cut Tool(Straight Type)



MAS 403-BT C 28 130 Boring
 Shank Coolant System Min Range Max Range Boring

Fig.1

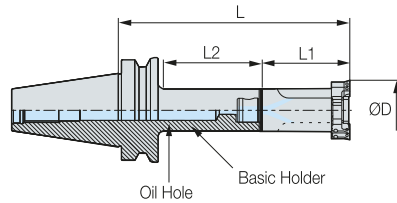
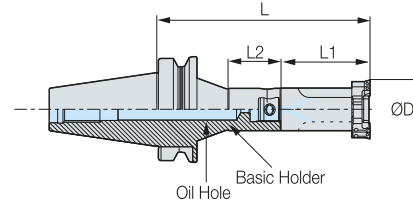
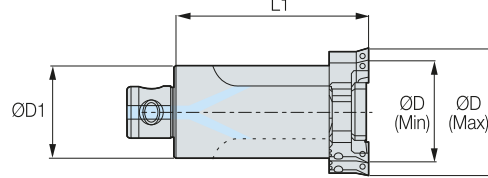

Fig.2



Head



1DIV= Ø 0.01mm

- : Stock
- C Internal coolant system is basic
- ※ Red : Main Component Blue : For Separate Purchase

- For more information on product features, see **178P**
- For more information on MD arbor, see **157P**
- For more information on the related parts, see **192P**
- For more information on the applicable insert, see **193P**

	Head Designation	Stock	Arbor Designation	Stock	Boring Range(ØD)		L	L1	L2	ØD1	Fig.	Head Weight(kg)	Head Package Weight(kg)
					Min.	Max.							
BT50	DBCA2528S	●	BT50-MD25F-105	●	28	38	165	60	62	25	1	0.2	0.2
	DBCA2528S	●	BT50-MD25F-120R	●	28	38	180	60	41	25	2	0.2	0.2
	DBCA3238S	●	BT50-MD32F-110	●	38	54	175	65	67	32	1	0.4	0.4
	DBCA3238S	●	BT50-MD32F-115R	●	38	54	180	65	46	32	2	0.4	0.4
	DBCA3238S	●	BT50-MD32F-235R	●	38	54	300	65	115	32	2	0.4	0.4
	DBCA5054S	●	BT50-MD50F-125	●	54	74	205	80	82	50	1	1.1	1.1
	DBCA5054S	●	BT50-MD50F-225	●	54	74	305	80	182	50	1	1.1	1.1
	DBCA5054S	●	BT50-MD50F-250R	●	54	74	330	80	81	50	2	1.1	1.1
	DBCA6374S	●	BT50-MD63F-75	●	74	100	165	90	35	63	1	1.9	2.1
	DBCA6374S	●	BT50-MD63F-130	●	74	100	220	90	87	63	1	1.9	2.1
	DBCA6374S	●	BT50-MD63F-195	●	74	100	285	90	152	63	1	1.9	2.1
	DBCA6374S	●	BT50-MD63F-230	●	74	100	320	90	187	63	1	1.9	2.1
	DBCA80100S	●	BT50-MD80F-75	●	100	130	175	100	36	80	1	3.7	3.9
	DBCA80100S	●	BT50-MD80F-110	●	100	130	210	100	69	80	1	3.7	3.9
	DBCA80100S	●	BT50-MD80F-175	●	100	130	275	100	134	80	1	3.7	3.9

• In the above table, the Arbor designation is an example designation and able to adjust the depth of boring with a combination of MD arbors and extension bars. For more details, see the MD arbor page. (Unit : mm)

- DBCA2528S : CCMT0602□□
- DBCA3238S : CCMT0602□□
- DBCA5054S : CCMT09T3□□
- DBCA6374S : CCMT1204□□
- DBCA80100S : CCMT1204□□

1:1 CHAT



HSK-DBCA

New Balance Cut Tool(Straight Type)



DIN 69893-1

Shank

C

Coolant System

28

Min Range

100

Max Range



Boring

Fig.1

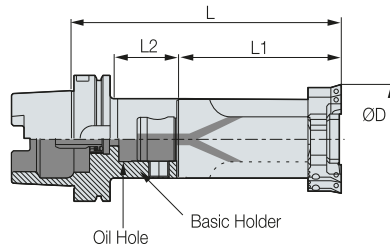
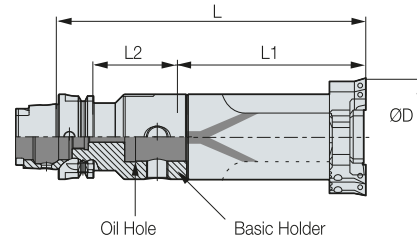
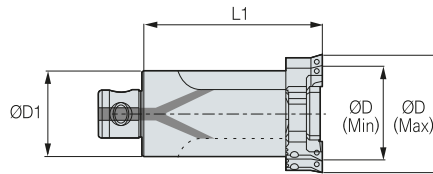

Fig.2



Head



1DIV= Ø 0.01mm

● : Stock

☐ Internal coolant system is optional

※ Red : Main Component Blue : For Separate Purchase

• For more information on product features, see **178P**

• For more information on MD arbor, see **158P**

• For more information on the related parts, see **192P**

• For more information on the applicable insert, see **193P**

	Head Designation	Stock	Arbor Designation	Stock	Boring Range(ØD)		L	L1	L2	ØD1	Fig.	Head Weight(kg)	Head Package Weight(kg)
					Min.	Max.							
HSK63A	DBCA2528S	●	HSK63A-MD25F-60	●	28	38	120	60	31	25	1	0.3	0.3
	DBCA3238S	●	HSK63A-MD32F-65	●	38	54	130	65	36	32	1	0.5	0.6
	DBCA5054S	●	HSK63A-MD50F-85	●	54	74	165	80	58	50	1	1.8	1.9
	DBCA6374S	●	HSK63A-MD63F-95	●	74	100	185	90	69	63	2	3.3	3.5

• In the above table, the Arbor designation is an example designation and able to adjust the depth of boring with a combination of MD arbors and extension bars. For more details, see the MD arbor page.

(Unit : mm)

- DBCA2528S : CCMT0602☐☐
- DBCA3238S : CCMT0602☐☐
- DBCA5054S : CCMT09T3☐☐
- DBCA6374S : CCMT1204☐☐
- DBCA80100S : CCMT1204☐☐

Accessories

SPARE PART	Type	Accessories	
		Coolant Tube for HSK	Wrench
	Images		
	Designation	HSK63A-CNS	HSK63-WRENCH(C)



SK-DBCA

New Balance Cut Tool(Straight Type)



DIN 69871-1A/B
C
28
130
Boring

Shank Coolant System Min Range Max Range Boring

Fig.1

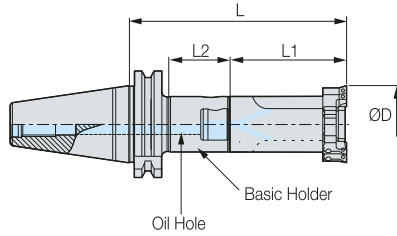

Fig.2

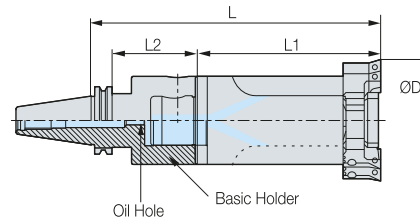
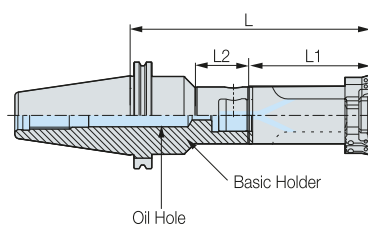
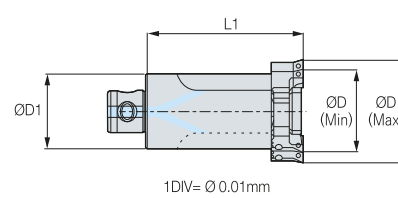

Fig.3



Head



- : Stock
- C Internal coolant system is basic
- ※ Red : Main Component Blue : For Separate Purchase

- For more information on product features, see 178P
- For more information on MD arbor, see 159P
- For more information on the related parts, see 192P
- For more information on the applicable insert, see 193P

	Head Designation	Stock	Arbor Designation	Stock	Boring Range(ØD)		L	L1	L2	ØD1	Fig.	Head Weight (kg)	Head Package Weight(kg)	
					Min.	Max.								
SK40	DBCA2528S	●	SK40-MD25F-80R	●	28	38	140	60	22	25	3	0.2	0.2	
	DBCA3238S	●	SK40-MD32F-115R	●	38	54	180	65	36	32	3	0.4	0.4	
	DBCA5054S	●	SK40-MD50F-75	●	54	74	155	80	55	50	1	1.1	1.1	
	DBCA5054S	●	SK40-MD50F-100	●	54	74	180	80	80	50	1	1.1	1.1	
	DBCA6374S	●	SK40-MD63F-70	●	74	100	160	90	50	63	2	1.9	2.1	
SK50	DBCA2528S	●	SK50-MD25F-80R	●	28	38	140	60	22	25	3	0.2	0.2	
	DBCA2528S	●	SK50-MD25F-105R	●	28	38	165	60	22	25	3	0.2	0.2	
	DBCA3238S	●	SK50-MD32F-110	●	38	54	175	65	87	32	1	0.4	0.4	
	DBCA3238S	●	SK50-MD32F-110R	●	38	54	175	65	36	32	3	0.4	0.4	
	DBCA5054S	●	SK50-MD50F-125R	●	54	74	205	80	60	50	3	1.1	1.1	
	DBCA5054S	●	SK50-MD50F-240R	●	54	74	320	80	125	50	3	1.1	1.1	
	DBCA6374S	●	SK50-MD63F-75	●	74	100	165	90	52	63	1	1.9	2.1	
	DBCA6374S	●	SK50-MD63F-130	●	74	100	220	90	107	63	1	1.9	2.1	
	DBCA6374S	●	SK50-MD63F-230R	●	74	100	320	90	149	63	3	1.9	2.1	
	DBCA80100S	●	SK50-MD80F-95	●	100	130	195	100	75	80	1	3.7	3.9	
	DBCA80100S	●	SK50-MD80F-150	●	100	130	250	100	129	80	1	3.7	3.9	

• In the above table, the Arbor designation is an example designation and able to adjust the depth of boring with a combination of MD arbors and extension bars. For more details, see the MD arbor page. (Unit : mm)

- DBCA2528S : CCMT0602□□
- DBCA3238S : CCMT0602□□
- DBCA5054S : CCMT09T3□□
- DBCA6374S : CCMT1204□□
- DBCA80100S : CCMT1204□□

1:1 CHAT



BT-DBC

Balance Cut Tool(Rough Boring)



MAS
403-BT
C
28
120

Shank Coolant System Min Range Max Range Boring

Fig.1

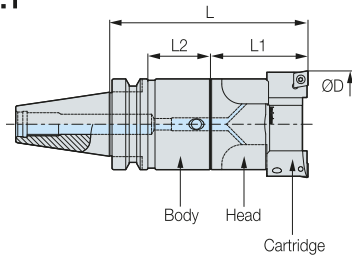

Fig.2

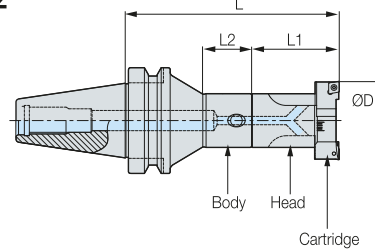
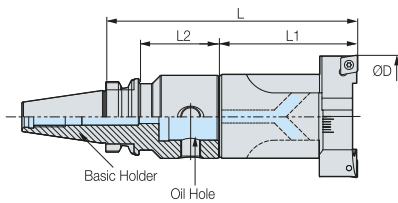
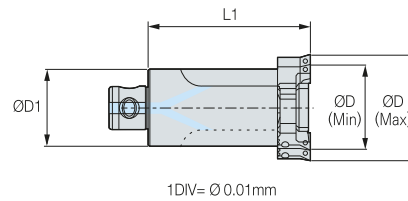

Fig.3



Head



● : Stock

C Internal coolant system is basic

※ Red : Main Component Blue : For Separate Purchase

• For more information on MD arbor, see 156P

• For more information on the related parts, see 192P

• For more information on the applicable insert, see 193P

	Head Designation	Stock	Arbor Designation	Stock	Boring Range(ØD)		L	L1	L2	ØD1	Fig.	Head Weight(kg)	Head Package Weight(kg)
					Min.	Max.							
BT30	DBC2528S	●	BT30-MD25F-90	●	28	35	150	60	63	25	1	0.3	0.3
	DBC3235S	●	BT30-MD32F-80	●	35	46	145	65	55	32	1	0.4	0.4
	DBC4046S	●	BT30-MD40F-45	●	46	58	115	70	22	40	1	0.6	0.7
	DBC4046S	●	BT30-MD40F-60	●	46	58	130	70	36	40	1	0.6	0.7
	DBC4046S	●	BT30-MD40F-80	●	46	58	150	70	56	40	1	0.6	0.7
	DBC5058S	●	BT30-MD50F-70	●	58	74	150	80	48	50	3	1.1	1.2
BT40	DBC2528S	●	BT40-MD25F-95	●	28	35	155	60	63	25	1	0.3	0.3
	DBC2528S	●	BT40-MD25F-105R	●	28	35	165	60	41	25	2	0.3	0.3
	DBC3235S	●	BT40-MD32F-100	●	35	46	165	65	70	32	1	0.4	0.4
	DBC3235S	●	BT40-MD32F-115R	●	35	46	180	65	46	32	2	0.4	0.4
	DBC4046S	●	BT40-MD40F-60	●	46	58	130	70	31	40	1	0.6	0.7
	DBC4046S	●	BT40-MD40F-110R	●	46	58	180	70	60	40	2	0.6	0.7
	DBC4046S	●	BT40-MD40F-115	●	46	58	185	70	83	40	1	0.6	0.7
	DBC5058S	●	BT40-MD50F-105	●	58	74	185	80	73	50	1	1.1	1.2
	DBC6374S	●	BT40-MD63F-64	●	74	94	154	90	37	63	1	2.0	2.2
	DBC6374S	●	BT40-MD63F-110	●	74	94	200	90	83	63	1	2.0	2.2
	DBC6374S	●	BT40-MD63F-135	●	74	94	225	90	108	63	1	2.0	2.2
	DBC8094S	●	BT40-MD80F-100	●	94	120	200	100	73	80	3	3.5	3.7

• In the above table, the Arbor designation is an example designation and able to adjust the depth of boring with a combination of MD arbors and extension bars. For more details, see the MD arbor page.

(Unit : mm)

- DBC2528S : CCMT0602□□
- DBC3235S : CCMT0602□□
- DBC4046S : CCMT09T3□□
- DBC5058S : CCMT09T3□□
- DBC6374S : CCMT1204□□
- DBC8094S : CCMT1204□□

1:1 CHAT



BT-DBC

Balance Cut Tool(Rough Boring)

MAS
403-BT

Shank

C

Coolant System

28

Min Range

175

Max Range



Boring



Fig.1

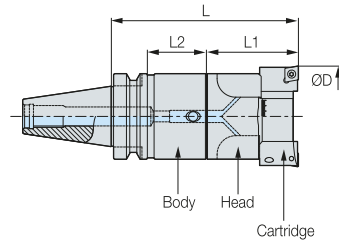
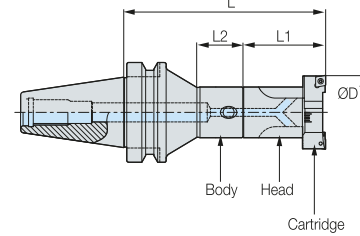
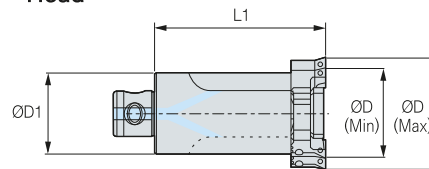

Fig.2



Head



1DIV= Ø 0.01mm

● : Stock

■ Internal coolant system is basic

※ Red : Main Component Blue : For Separate Purchase

• For more information on MD arbor, see **157P**

• For more information on the related parts, see **192P**

• For more information on the applicable insert, see **193P**

	Head Designation	Stock	Arbor Designation	Stock	Boring Range(ØD)		L	L1	L2	ØD1	Fig.	Head Weight(kg)	Head Package Weight(kg)
					Min.	Max.							
BT50	DBC2528S	●	BT50-MD25F-105	●	28	35	165	60	62	25	1	0.3	0.3
	DBC2528S	●	BT50-MD25F-120R	●	28	35	180	60	41	25	2	0.3	0.3
	DBC3235S	●	BT50-MD32F-110	●	35	46	175	65	67	32	1	0.4	0.4
	DBC3235S	●	BT50-MD32F-115R	●	35	46	180	65	46	32	2	0.4	0.4
	DBC3235S	●	BT50-MD32F-235R	●	35	46	300	65	115	32	2	0.4	0.4
	DBC4046S	●	BT50-MD40F-60	●	46	58	130	70	21	40	1	0.6	0.7
	DBC4046S	●	BT50-MD40F-195	●	46	58	265	70	152	40	1	0.6	0.7
	DBC4046S	●	BT50-MD40F-230R	●	46	58	300	70	180	40	2	0.6	0.7
	DBC5058S	●	BT50-MD50F-125	●	58	74	205	80	82	50	1	1.1	1.2
	DBC5058S	●	BT50-MD50F-225	●	58	74	305	80	182	50	1	1.1	1.2
	DBC5058S	●	BT50-MD50F-250R	●	58	74	330	80	81	50	2	1.1	1.2
	DBC6374S	●	BT50-MD63F-75	●	74	94	165	90	35	63	1	2.0	2.2
	DBC6374S	●	BT50-MD63F-130	●	74	94	220	90	87	63	1	2.0	2.2
	DBC6374S	●	BT50-MD63F-195	●	74	94	285	90	152	63	1	2.0	2.2
	DBC6374S	●	BT50-MD63F-230	●	74	94	320	90	187	63	1	2.0	2.2
	DBC8094S	●	BT50-MD80F-75	●	94	120	175	100	36	80	1	3.5	3.7
DBC8094S	●	BT50-MD80F-110	●	94	120	210	100	69	80	1	3.5	3.7	
DBC8094S	●	BT50-MD80F-175	●	94	120	275	100	134	80	1	3.5	3.7	
DBC120S	●	BT50-MD80F-175	●	120	175	275	100	134	80	1	4.1	4.4	

• In the above table, the Arbor designation is an example designation and able to adjust the depth of boring with a combination of MD arbors and extension bars. For more details, see the MD arbor page.

(Unit : mm)

- DBC2528S : CCMT0602□□
- DBC3235S : CCMT0602□□
- DBC4046S : CCMT09T3□□
- DBC5058S : CCMT09T3□□
- DBC6374S : CCMT1204□□
- DBC8094S : CCMT1204□□



HSK-DBC

Balance Cut Tool(Modular Type)



DIN 69893-1
C
28
94

Shank Coolant System Min Range Max Range Boring

Fig.1

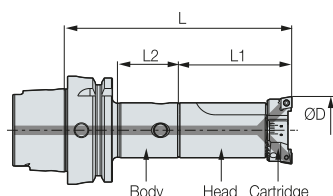
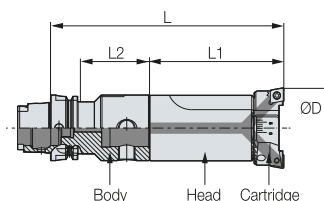
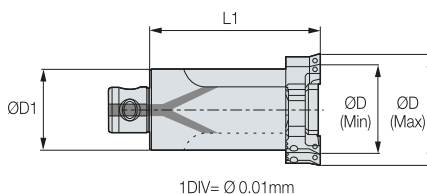

Fig.2



Head



- ● : Stock
- For more information on MD arbor, see **158P**
- For more information on the related parts, see **192P**
- For more information on the applicable insert, see **193P**
- Internal coolant system is optional
- ※ Red : Main Component Blue : For Separate Purchase

	Head Designation	Stock	Arbor Designation	Stock	Boring Range(ØD)		L	L1	L2	ØD1	Fig.	Head Weight(kg)	Head Package Weight(kg)
					Min.	Max.							
HSK63A	DBC2528S	●	HSK63A-MD25F-60	●	28	35	120	60	31	25	1	0.3	0.3
	DBC3235S	●	HSK63A-MD32F-65	●	35	46	130	65	36	32	1	0.4	0.4
	DBC4046S	●	HSK63A-MD40F-70	●	46	58	140	70	41	40	1	0.6	0.7
	DBC5058S	●	HSK63A-MD50F-85	●	58	74	165	80	58	50	1	1.1	1.2
	DBC6374S	●	HSK63A-MD63F-95	●	74	94	185	90	69	63	2	2.0	2.2

• In the above table, the Arbor designation is an example designation and able to adjust the depth of boring with a combination of MD arbors and extension bars. For more details, see the MD arbor page. (Unit : mm)

- DBC2528S : CCMT0602□□
- DBC3235S : CCMT0602□□
- DBC4046S : CCMT09T3□□
- DBC5058S : CCMT09T3□□
- DBC6374S : CCMT1204□□
- DBC8094S : CCMT1204□□

Accessories

SPARE PART	Type	Accessories	
		Coolant Tube for HSK	Wrench
	Images		
	Designation	HSK63A	HSK63-WRENCH(C)

1:1 CHAT



SK-DBC

Balance Cut Tool(Modular Type)



DIN
69871-1A/B

Shank

C

Coolant System

28

Min Range

175

Max Range



Boring

Fig.1

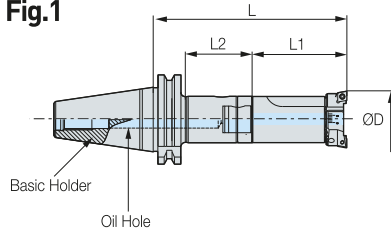

Fig.2

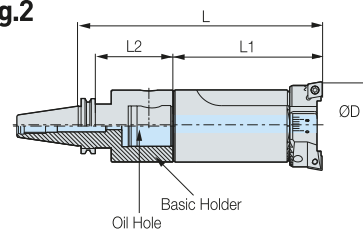
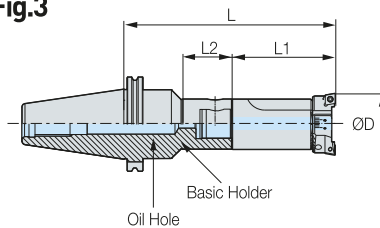
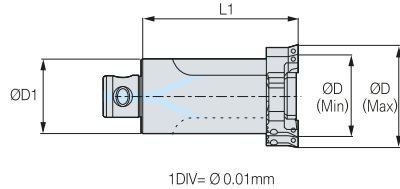

Fig.3



Head



● : Stock

C Internal coolant system is basic

※ Red : Main Component Blue : For Separate Purchase

• For more information on MD arbor, see [159P](#)

• For more information on the related parts, see [192P](#)

• For more information on the applicable insert, see [193P](#)

	Head Designation	Stock	Arbor Designation	Stock	Boring Range(ØD)		L	L1	L2	ØD	ØD1	Fig.	Head Weight(kg)	Head Package Weight(kg)
					Min.	Max.								
SK40	DBC2528S	●	SK40-MD25F-80R	●	28	35	140	60	22	14	25	3	0.3	0.3
	DBC3235S	●	SK40-MD32F-115R	●	35	46	180	65	36	18	32	3	0.4	0.4
	DBC4046S	●	SK40-MD40F-60	●	46	58	130	70	40	22	40	1	0.6	0.7
	DBC4046S	●	SK40-MD40F-100	●	46	58	170	70	80	22	40	1	0.6	0.7
	DBC5058S	●	SK40-MD50F-100	●	58	74	180	80	80	28	50	1	1.1	1.2
	DBC6374S	●	SK40-MD63F-70	●	74	94	160	90	50	36	63	2	2.0	2.2
SK50	DBC2528S	●	SK50-MD25F-80R	●	28	35	140	60	22	14	25	3	0.3	0.3
	DBC2528S	●	SK50-MD25F-105R	●	28	35	165	60	22	14	25	3	0.3	0.3
	DBC3235S	●	SK50-MD32F-110	●	35	46	175	65	87	18	32	1	0.4	0.4
	DBC3235S	●	SK50-MD32F-110R	●	35	46	175	65	36	18	32	3	0.4	0.4
	DBC4046S	●	SK50-MD40F-100	●	46	58	170	70	75	22	40	1	0.6	0.7
	DBC4046S	●	SK50-MD40F-145	●	46	58	215	70	120	22	40	1	0.6	0.7
	DBC4046S	●	SK50-MD40F-220R	●	46	58	290	70	83	22	40	3	0.6	0.7
	DBC5058S	●	SK50-MD50F-125R	●	58	74	205	80	60	28	50	3	1.1	1.2
	DBC5058S	●	SK50-MD50F-240R	●	58	74	320	80	125	28	50	3	1.1	1.2
	DBC6374S	●	SK50-MD63F-75	●	74	94	165	90	52	36	63	1	2.0	2.2
	DBC6374S	●	SK50-MD63F-130	●	74	94	220	90	107	36	63	1	2.0	2.2
	DBC6374S	●	SK50-MD63F-230R	●	74	94	320	90	149	36	63	3	2.0	2.2
	DBC8094S	●	SK50-MD80F-95	●	94	120	195	100	75	45	80	1	3.5	3.7
	DBC8094S	●	SK50-MD80F-150	●	94	120	250	100	129	45	80	1	3.5	3.7
DBC120S	●	SK50-MD80F-150	●	120	175	250	100	129	45	80	1	4.1	4.4	

• In the above table, the Arbor designation is an example designation and able to adjust the depth of boring with a combination of MD arbors and extension bars. For more details, see the MD arbor page.

(Unit : mm)

• DBC2528S : CCMT0602□□ • DBC3235S : CCMT0602□□

• DBC4046S : CCMT09T3□□ • DBC5058S : CCMT09T3□□

• DBC6374S : CCMT1204□□ • DBC8094S : CCMT1204□□

1:1 CHAT



DBCA/DBC SPARE PART

Balance Cut Tool Related Parts



Main Components

DBCA-H

SPARE PART	Type	Main Components										
		Head	Cover	Guide Pin	Spring Pin	Wrench Bolt	Wrench	Cartridge	Set Screw	Wrench	Clamp Screw	Torx Wrench
	Images											
	Designation											
	DBCA2528S-H	DBCA2528-H	DBCA28-ECC	DBCA28-ECG	SP0308	BX0420	LW-3	BCC28-EC(SET)	BT0308	LW-1.5	BFTX02506N	TRX8
	DBCA3238S-H	DBCA3238-H	DBCA38-ECC	DBCA38-ECG	SP0410	BX0525	LW-4	BCC38-EC(SET)	BT0310	LW-1.5	BFTX02506N	TRX8
	DBCA5054S-H	DBCA5054-H	DBCA54-ECC	DBCA54-ECG	SP0616	BX0630	LW-5	BCC54-EC(SET)	BT0414	LW-2	BFTX0407N	TRX15
	DBCA6374S-H	DBCA6374-H	DBCA74-ECC	DBCA74-ECG	SP0818	BX0635	LW-5	BCC74-EC(SET)	BT0520	LW-2.5	BFTX0511N	TRX20
	DBCA80100S-H	DBCA80100-H	DBCA100-ECC	DBCA100-ECG	SP1020	BX0840	LW-6	BCC100-EC (SET)	BT0625	LW-3	BFTX0511N	TRX20

DBCA-S

SPARE PART	Type	Main Components										
		Head	Cover	Guide Pin	Spring Pin	Wrench Bolt	Wrench	Cartridge	Set Screw	Wrench	Clamp Screw	Torx Wrench
	Images											
	Designation											
	DBCA2528S	DBCA2528	DBCA28-ECC	DBCA28-ECG	SP0308	BX0420	LW-3	BCC28-EC(SET)	BT0308	LW-1.5	BFTX02506N	TRX8
	DBCA3238S	DBCA3238	DBCA38-ECC	DBCA38-ECG	SP0410	BX0525	LW-4	BCC38-EC(SET)	BT0310	LW-1.5	BFTX02506N	TRX8
	DBCA5054S	DBCA5054	DBCA54-ECC	DBCA54-ECG	SP0616	BX0630	LW-5	BCC54-EC(SET)	BT0414	LW-2	BFTX0407N	TRX15
	DBCA6374S	DBCA6374	DBCA74-ECC	DBCA74-ECG	SP0818	BX0635	LW-5	BCC74-EC(SET)	BT0520	LW-2.5	BFTX0511N	TRX20
	DBCA80100S	DBCA80100	DBCA100-ECC	DBCA100-ECG	SP1020	BX0840	LW-6	BCC100-EC (SET)	BT0625	LW-3	BFTX0511N	TRX20

DBC

SPARE PART	Type	Main Components								
		Head	Spring Pin	Wrench Bolt	Wrench	Cartridge	Set Screw	Wrench	Clamp Screw	Torx Wrench
	Images									
	Designation									
	DBC2528S	DBC2528	SP0308	BX0416	LW-3	BCC28(SET)	BT0306	LW-1.5	FTKA02565	TRX7
	DBC3235S	DBC3235	SP0410	BX0516	LW-4	BCC35(SET)	BT0308	LW-1.5	FTKA02565	TRX7
	DBC4046S	DBC4046	SP0516	BX0620	LW-5	BCC46(SET)	BT0408	LW-2	FTNA0408	TRX15
	DBC5058S	DBC5058	SP0616	BX0620	LW-5	BCC58(SET)	BT0412	LW-2	FTNA0408	TRX15
	DBC6374S	DBC6374	SP0818	BX0830	LW-6	BCC74(SET)	BT0516	LW-2.5	BFTX0511N	TRX20
	DBC8094S	DBC8094	SP1020	BX1035	LW-8	BCC94(SET)	BT0620	LW-3	BFTX0511N	TRX20
	DBC120S	DBC120N	SP1020	BX0830	LW-6	BCC120(SET)	BT0830	LW-4	BFTX0511N	TRX20

1:1 CHAT



DBCA/DBC Insert

Boring Tool Insert



Accessories

INSERT	Insert	Grade			Workpiece	Cutting	Maker	
	Coated	AC810P	AC820P		Steel	General	Sumitomo	
	Coated	AC8015P	AC8020P	AC8025P	Steel			
	Coated	AC630M	AC6020M	AC6030M	Stainless Steel			
	Coated	T1500A			Steel/Stainless Steel	Finishing	General	Korloy
	Coated	NC3215	NC3120		Steel			
	Coated	NC6310	NC6315		Cast Iron			
	Coated	PC9030	NC9115	NC9125	Stainless Steel	Finishing to Midium		
	Coated	AC5015S	AC5025S		HRSA/Stainless Steel	General	Sumitomo	
	Cermet	T1500A	T2500Z		Steel/Stainless Steel	General		
	Coated	PC5300	PC8110	PC8115	Stainless Steel	General	Korloy	
	W.C	H01			Aluminum/Copper	Finishing to General		
	Coated	AC8015P			Steel	General	Sumitomo	
	Coated	AC8025P			Steel			
	Coated	AC4015K			Cast Iron			
	Coated	AC630M	AC6020M	AC6030M	Stainless Steel	Finishing	General	Korloy
	Coated	T1500A	T2500Z		Steel			
	Coated	NC3215	NC3120		Steel			
	Coated	NC6310	NC6315		Cast Iron			
Coated	PC9030	NC9115	NC9125	Stainless Steel				
	Coated	AC5015S			HRSA/Stainless Steel	General	Sumitomo	
	Cermet	T1500A			Steel/Stainless Steel	Finishing		
	W.C	H1			Aluminum/Copper	Finishing to General	Korloy	
	Coated	PC9030	PC8110	PC8115	Stainless Steel	General		
	Coated	AC8025P			Steel	General	Sumitomo	
	Cermet	T1500A			Steel/Stainless Steel	Finishing		
	Coated	NC3215	NC3120		Steel	General	Korloy	
	Coated	NC6310	NC6315		Cast Iron			
Coated	PC9030	PC5300	PC5400	Stainless Steel				
	W.C	H01			Aluminum/Copper	Finishing to General	Korloy	

- There are a range of grades and chip breakers to choose from according to usage.
- The cartridge for CNMG1204□□ is different from the cartridge for CCMT1204□□ in terms of designation.

1:1 CHAT



TBCA

Wide Range Diameter Boring System



C	AL	130	615	
Coolant System	Material	Min Range	Max Range	Boring



Features

- Minimizes the deformation during machining due to the aluminum bridge made of aerospace materials
- Various large diameter boring applicable (Inner diameter/Outer diameter)
- When the cartridge is replaced, fine boring is available
- Outer diameter boring range : $\varnothing 0$ – $\varnothing 315$ mm
- Inner diameter boring range : $\varnothing 130$ – $\varnothing 615$ mm

NAMING	Body			Head Set		
	BT50	FMC40	50	TBC	130	A
	Spindle	Facemill Arbor	Length	Balance Cut Tool	Minimum Boring Range	Advance

Main Features

Reinforced Rigidity

50% less moment strain (versus the conventional product of DINE)

TBC460 (Old Type)	TBC460A (New Type)

Light Weight Design (Head Set)

BCC(Cartridge)+DBR(Rail)+DBB(Bridge)



TBC130A	TBC175A	TBC220A	TBC265A
4.2Kg	5.6Kg	6.6Kg	7.5Kg
TBC310A	TBC385A	TBC460A	TBC535A
9.6Kg	11.7Kg	14.1Kg	16.5Kg

Machining Method

Twin Edge Boring	Single Edge Boring	Step Boring	Outside Boring

Performance Test

Products	Workpiece		Boring Diameter (Depth of Cut)	Results
	Product Name	Material	mm	Machining
Conventional Tool of DINE	Housing	Cast Iron	$\varnothing 465$ (Rd=7)	<ul style="list-style-type: none"> • Vibration occurred • Insert damaged in the machining • Scratched surface of workpieces
TBC460A Applicable Insert CNMG19	Housing	QT400	$\varnothing 508$ – 527 (Rd=10)	<ul style="list-style-type: none"> • No chattering • No vibration found • Goal of accuracy achieved • Normal chip discharged

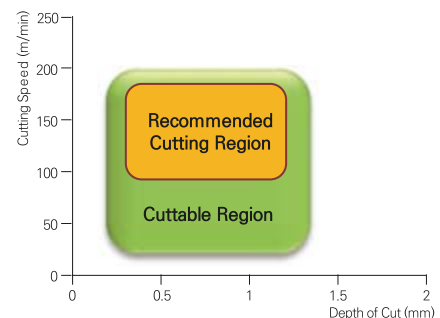

1:1 CHAT



TBCA

Wide Range Diameter Boring System



Convenience

- Inner boring and outer boring can be performed by easily changing the cartridge direction
- With the scale marking on the rail, the boring diameter can be set easily

Inner Boring

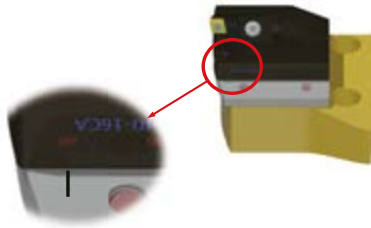

Outer Boring

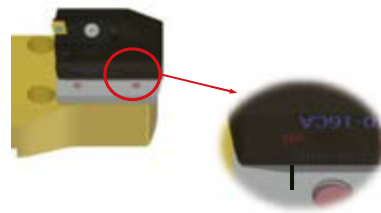

Boring System Map

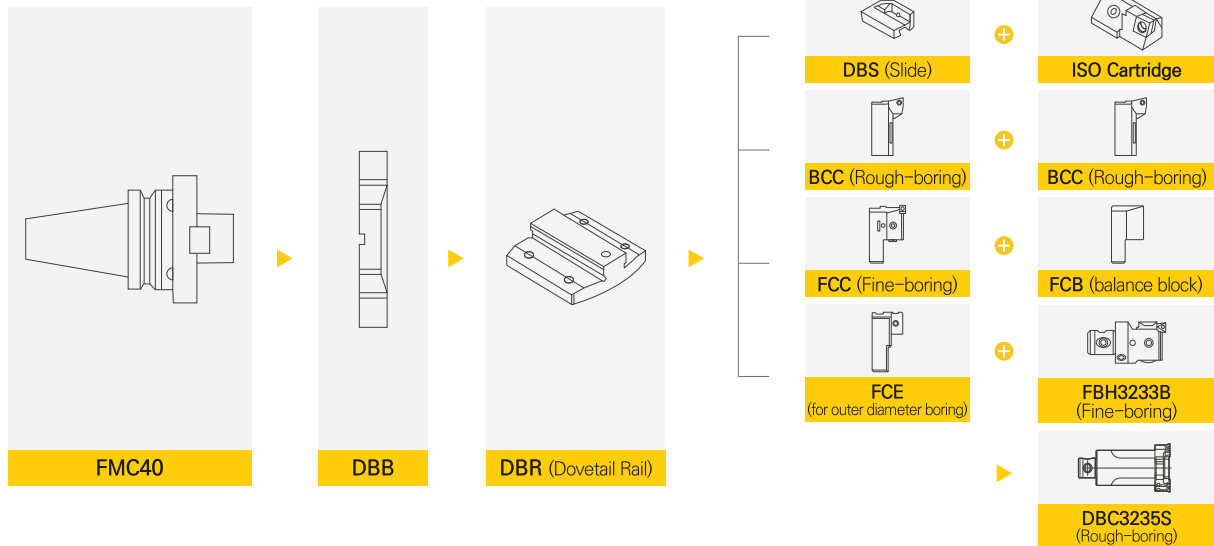

Wide Compatibility

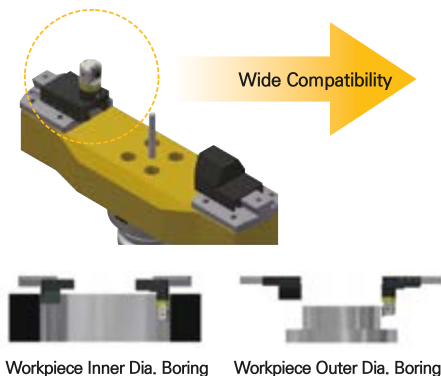

	Images	List of Clamping Parts	Cutting Type
Outer Dia. Boring		FBH3233B+FCE310+FCB310	Fine Boring
		DBC3235S+FCE310+FCB310	Rough Boring
Inner Dia. Boring		DBS□□-□□CA+ISO Cartridge L-type	Rough Boring
		FCC310 + FCB310	Fine Boring
		BCC1354	Rough Boring

- ※ Diameter setting is possible using pins.
- ※ The pin is a separate purchase product.



TBCA

Wide Range Diameter Boring System



MAS 403-BT Shank
 C Coolant System
 AL Material
 130 Min Range
 615 Max Range
 Boring

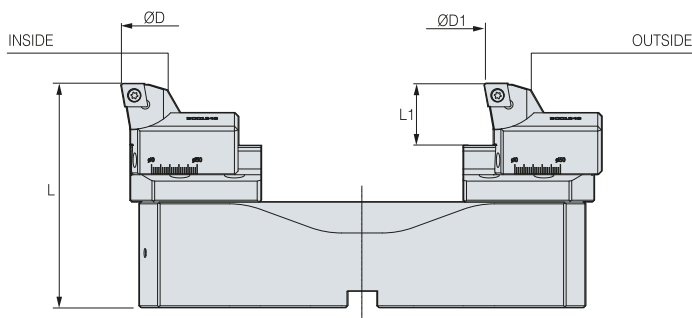

C Internal coolant system is optional

※ FMC arbor is sold separately

※ Red : Main Component

• For more information on product features, see **194P**

• For more information on FMC arbor, see **148P**

Twin Edge Boring for Roughing						L1	kg
TBCA Head Set (Bridge+Rail+BCC Cartridge)	L	Boring Range					
		$\varnothing D$ (Inside)		$\varnothing D1$ (Outside)			
		Min.	Max.	Min.	Max.		
TBC130A [DBB130+DBR130+BCC1348(SET)]	108	130	180	0	34	34	4.2
TBC175A [DBB175+DBR175+BCC1348(SET)]	113	175	225	25	75	34	5.6
TBC220A [DBB220+DBR07015+BCC1348(SET)]	118	220	270	15	65	34	6.6
TBC265A [DBB265+DBR07015+BCC1348(SET)]	123	265	315	61	111	34	7.5
TBC310A [DBB310+DBR10015+BCC1354(SET)]	128	310	390	10	90	34	9.6
TBC385A [DBB385+DBR10015+BCC1354(SET)]	133	385	465	85	165	34	11.7
TBC460A [DBB460+DBR10015+BCC1354(SET)]	138	460	540	160	240	34	14.1
TBC535A [DBB535+DBR10015+BCC1354(SET)]	143	535	615	235	315	34	16.5

(Unit : mm)

Main Components				Accessories	
Head Set	Bridge	Rail	Cartridge	Arbor	Pin
TBC130A	DBB130	DBR130	BCC1348(SET)	BT50-FMC40-50	PIN1080
TBC175A	DBB175	DBR175	BCC1348(SET)	BT50-FMC40-50	PIN1080
TBC220A	DBB220	DBR07015	BCC1348(SET)	BT50-FMC40-50	PIN1080
TBC265A	DBB265	DBR07015	BCC1348(SET)	BT50-FMC40-50	PIN1080
TBC310A	DBB310	DBR10015	BCC1354(SET)	BT50-FMC40-50	PIN1080
TBC385A	DBB385	DBR10015	BCC1354(SET)	BT50-FMC40-50	PIN1080
TBC460A	DBB460	DBR10015	BCC1354(SET)	BT50-FMC40-50	PIN1080
TBC535A	DBB535	DBR10015	BCC1354(SET)	BT50-FMC40-50	PIN1080

※ Inserts are purchased separately.

1:1 CHAT



TBCA (with FCC)

Wide Range Diameter Boring System

MAS
403-BT

Shank

C

Coolant System

AL

Material

130

Min Range

615

Max Range



Boring

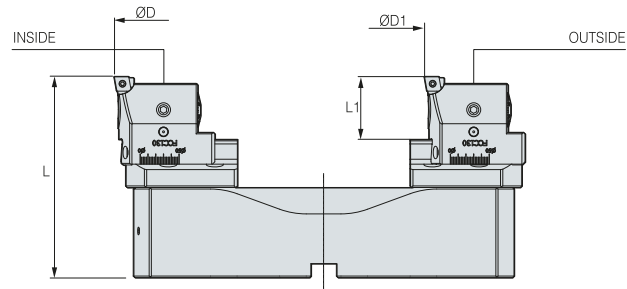

C Internal coolant system is optional

※ The FMC Arbor are sold individually

※ Red : Main Component Blue : For Separate Purchase

• For more information on product features, see **194P**

• For more information on FMC arbor, see **148P**

Single Edge Boring for Finishing						L1	kg
TBCA Head Set (Bridge+Rail+Goods for separate purchase)	L	Boring Range					
		ØD (Inside)		ØD1 (Outside)			
		Min.	Max.	Min.	Max.		
TBC130A (DBB130+DBR130+FCC130+FCB130+FBB130-□□○)	115	130	180	0	34	41	4.4
TBC175A (DBB175+DBR175+FCC130+FCB130+FBB130-□□○)	120	175	225	25	75	41	5.8
TBC220A (DBB220+DBR07015+FCC130+FCB130+FBB130-□□○)	125	220	270	15	65	41	6.9
TBC265A (DBB265+DBR07015+FCC130+FCB130+FBB130-□□○)	130	265	315	61	111	41	7.9
TBC310A (DBB310+DBR10015+FCC310+FCB310+FBB130-□□○)	135	310	390	10	90	41	10
TBC385A (DBB385+DBR10015+FCC310+FCB310+FBB130-□□○)	140	385	465	85	165	41	12.1
TBC460A (DBB460+DBR10015+FCC310+FCB310+FBB130-□□○)	145	460	540	160	240	41	14.7
TBC535A (DBB535+DBR10015+FCC310+FCB310+FBB130-□□○)	150	535	615	235	315	41	16.9

※ The drawings are for understanding the internal/external diameter processing and may differ from the actual product.

(Unit : mm)

Main Components			Accessories				
Head Set	Bridge	Rail	Cartridge	Bite	Balance Block	Arbor	Pin
TBC130A	DBB130	DBR130	FCC130	FBB130-□□○	FCB130	BT50-FMC40-50	PIN1080
TBC175A	DBB175	DBR175	FCC130	FBB130-□□○	FCB130	BT50-FMC40-50	PIN1080
TBC220A	DBB220	DBR07015	FCC130	FBB130-□□○	FCB130	BT50-FMC40-50	PIN1080
TBC265A	DBB265	DBR07015	FCC130	FBB130-□□○	FCB130	BT50-FMC40-50	PIN1080
TBC310A	DBB310	DBR10015	FCC310	FBB130-□□○	FCB310	BT50-FMC40-50	PIN1080
TBC385A	DBB385	DBR10015	FCC310	FBB130-□□○	FCB310	BT50-FMC40-50	PIN1080
TBC460A	DBB460	DBR10015	FCC310	FBB130-□□○	FCB310	BT50-FMC40-50	PIN1080
TBC535A	DBB535	DBR10015	FCC310	FBB130-□□○	FCB310	BT50-FMC40-50	PIN1080

※ Inserts are purchased separately.



TBCA (with ISO Cartridge)

Wide Range Diameter Boring System



- MAS
403-BT
 - C
 - AL
 - 175
 - 615
 -
- Shank Coolant System Material Min Range Max Range Boring

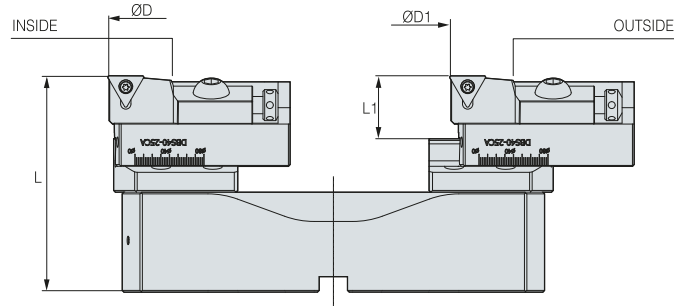

C Internal coolant system is optional
 ※ Red : Main Component Blue : For Separate Purchase
 ※ The FMC Arbor are sold individually

• For more information on product features, see **194P**
 • For more information on FMC arbor, see **148P**

Step Boring for Roughing						L1	Package Weight(kg)
TBCA Head Set (Bridge+Rail+Goods for separate purchase)	L	Boring Range					
		ØD (Inside)		ØD1 (Outside)			
		Min.	Max.	Min.	Max.		
TBC175A (DBB175+DBR175+DBS25-□□CA+ISO CARTRIDGE L-Type)	113	175	225	25	75	34	5.6
TBC220A (DBB220+DBR07015+DBS25-□□CA+ISO CARTRIDGE L-Type)	118	220	270	15	65	34	6.7
TBC265A (DBB265+DBR07015+DBS25-□□CA+ISO CARTRIDGE L-Type)	123	265	315	61	111	34	7.7
TBC310A (DBB310+DBR10015+DBS40-□□CA+ISO CARTRIDGE L-Type)	128	310	390	10	90	34	9.8
TBC385A (DBB385+DBR10015+DBS40-□□CA+ISO CARTRIDGE L-Type)	133	385	465	85	165	34	11.9
TBC460A (DBB460+DBR10015+DBS40-□□CA+ISO CARTRIDGE L-Type)	138	460	540	160	240	34	14.3
TBC535A (DBB535+DBR10015+DBS70-□□CA+ISO CARTRIDGE L-Type)	143	535	615	235	315	34	16.7

(Unit : mm)

Main Components			Accessories				
Head Set	Bridge	Rail	Arbor	Slide	Cartridge	Plate	Pin
TBC175A	DBB175	DBR175	BT50-FMC40-50	DBS25-16CA DBS25-20CA DBS25-25CA	ISO Cartridge	ISO Cartridge Plates	PIN1080
TBC220A	DBB220	DBR07015					
TBC265A	DBB265	DBR07015					
TBC310A	DBB310	DBR10015					
TBC385A	DBB385	DBR10015					
TBC460A	DBB460	DBR10015					
TBC535A	DBB535	DBR10015					

※ Inserts are purchased separately.

1:1 CHAT



TBCA (FBH)

Wide Range Diameter Boring System

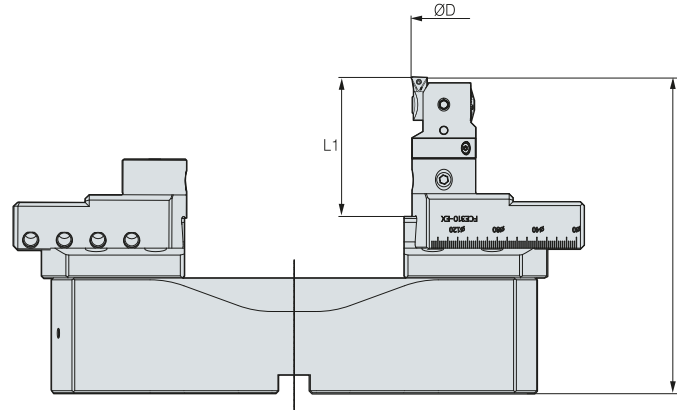

C Internal coolant system is optional

※ Red : Main Component Blue : For Separate Purchase

※ The FMC Arbor are sold individually

• For more information on product features, see **194P**

• For more information on FMC arbor, see **148P**

Single Edge Boring for Finishing				L1	Package Weight(kg)
TBCA Head Set (Bridge+Rail+Goods for separate purchase)	L	Boring Range			
		ØD (Outside)			
		Min.	Max.		
TBC175A (DBB175+DBR175+FCB130+FCE130+FBH3233B+FBB33N)	150	12	82	71	5.8
TBC220A (DBB220+DBR07015+FCB130+FCE130+FBH3233B+FBB33N)	155	54	134	71	6.9
TBC265A (DBB265+DBR07015+FCB130+FCE130+FBH3233B+FBB33N)	160	100	180	71	7.9
TBC310A (DBB310+DBR10015+FCB310+FCE310+FBH3233B+FBB33N)	165	26	172	71	10.1
TBC385A (DBB385+DBR10015+FCB310+FCE310+FBH3233B+FBB33N)	170	101	247	71	12.1
TBC460A (DBB460+DBR10015+FCB310+FCE310+FBH3233B+FBB33N)	175	176	322	71	14.7
TBC535A (DBB535+DBR10015+FCB310+FCE310+FBH3233B+FBB33N)	180	397	543	71	16.9

(Unit : mm)

Main Components			Accessories				
Head Set	Bridge	Rail	Arbor	Slide	Balance Block	Head	Pin
TBC175A	DBB175	DBR175	BT50-FMC40-50	FCE130	FCB130	FBH3233B	PIN1080
TBC220A	DBB220	DBR07015					
TBC265A	DBB265	DBR07015					
TBC310A	DBB310	DBR10015		FCE310	FCB310		
TBC385A	DBB385	DBR10015					
TBC460A	DBB460	DBR10015					
TBC535A	DBB535	DBR10015					

※ Inserts are purchased separately.

1:1 CHAT



BT-TBC

Balance Cut Tool for Rough Boring

MAS
403-BT

Shank

C

Coolant System

130

Min Range

540

Max Range



Boring

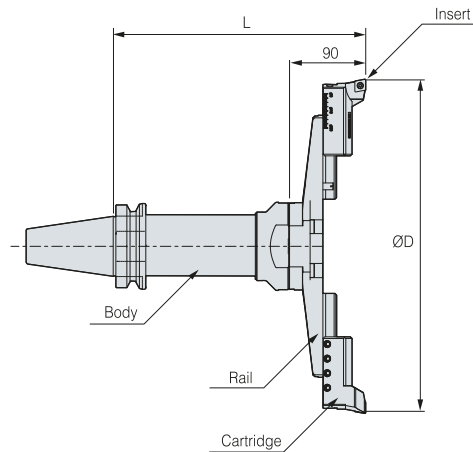

- C This product does not support the internal coolant system
- ※ Red : Main Component Blue : For Separate Purchase
- ※ The FMC Arbor are sold individually

- For more information on the related parts, see 202P
- For more information on FMD arbor, see 206P
- For more information on the applicable insert, see 226P

FMD Designation (Separate Order)	Holder Weight (kg)	Rough Boring (TBC)				
		TBC Head Set (Rail+Cartridge)	L	Boring Range(ØD)		Head Weight (kg)
				Min.	Max.	
BT50 BT50-FMD50-85	5.9	TBC130S [TBR130+BCC1348(SET)]	175	130	180	3.2
BT50-FMD50-155	7.9	TBC130S [TBR130+BCC1348(SET)]	245	130	180	3.2
BT50-FMD50-205	9.7	TBC130S [TBR130+BCC1348(SET)]	295	130	180	3.2
BT50-FMD50-255	13.4	TBC130S [TBR130+BCC1348(SET)]	345	130	180	3.2
BT50-FMD50-85	5.9	TBC175S [TBR175+BCC1348(SET)]	175	175	225	3.6
BT50-FMD50-155	7.9	TBC175S [TBR175+BCC1348(SET)]	245	175	225	3.6
BT50-FMD50-205	9.7	TBC175S [TBR175+BCC1348(SET)]	295	175	225	3.6
BT50-FMD50-255	13.4	TBC175S [TBR175+BCC1348(SET)]	345	175	225	3.6
BT50-FMD50-85	5.9	TBC220S [TBR220+BCC1348(SET)]	175	220	270	4
BT50-FMD50-155	7.9	TBC220S [TBR220+BCC1348(SET)]	245	220	270	4
BT50-FMD50-205	9.7	TBC220S [TBR220+BCC1348(SET)]	295	220	270	4
BT50-FMD50-255	13.4	TBC220S [TBR220+BCC1348(SET)]	345	220	270	4
BT50-FMD50-85	5.9	TBC265S [TBR265+BCC1348(SET)]	175	265	315	4.2
BT50-FMD50-155	7.9	TBC265S [TBR265+BCC1348(SET)]	245	265	315	4.2
BT50-FMD50-205	9.7	TBC265S [TBR265+BCC1348(SET)]	295	265	315	4.2
BT50-FMD50-255	13.4	TBC265S [TBR265+BCC1348(SET)]	345	265	315	4.2
BT50-FMD50-85	5.9	TBC310S [TBR310+BCC1354(SET)]	175	310	390	5.2
BT50-FMD50-155	7.9	TBC310S [TBR310+BCC1354(SET)]	245	310	390	5.2
BT50-FMD50-205	9.7	TBC310S [TBR310+BCC1354(SET)]	295	310	390	5.2
BT50-FMD50-255	13.4	TBC310S [TBR310+BCC1354(SET)]	345	310	390	5.2
BT50-FMD50-85	5.9	TBC385S [TBR385+BCC1354(SET)]	175	385	465	5.5
BT50-FMD50-155	7.9	TBC385S [TBR385+BCC1354(SET)]	245	385	465	5.5
BT50-FMD50-205	9.7	TBC385S [TBR385+BCC1354(SET)]	295	385	465	5.5
BT50-FMD50-255	13.4	TBC385S [TBR385+BCC1354(SET)]	345	385	465	5.5
BT50-FMD50-85	5.9	TBC460S [TBR460+BCC1354(SET)]	175	460	540	12.5
BT50-FMD50-155	7.9	TBC460S [TBR460+BCC1354(SET)]	245	460	540	12.5
BT50-FMD50-205	9.7	TBC460S [TBR460+BCC1354(SET)]	295	460	540	12.5
BT50-FMD50-255	13.4	TBC460S [TBR460+BCC1354(SET)]	345	460	540	12.5

(Unit : mm)

1:1 CHAT



SK-TBC

Balance Cut Tool for Rough Boring



DIN69871
-1A/B

Shank

C

Coolant System

130

Min Range

540

Max Range



Boring

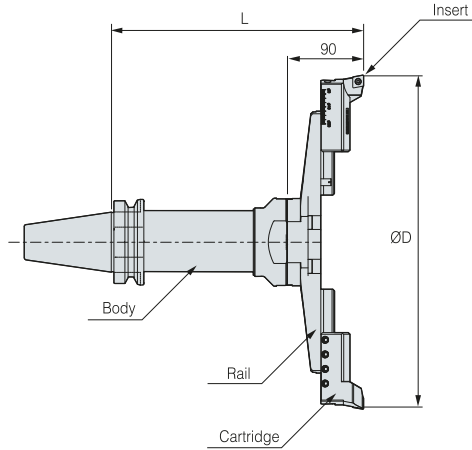

C This product does not support the internal coolant system

※ Red : Main Component Blue : For Separate Purchase

※ The FMC Arbor are sold individually

• For more information on the related parts, see **202P**

• For more information on FMD arbor, see **206P**

• For more information on the applicable insert, see **226P**

FMD Designation (Separate Order)	Holder Weight (kg)	Rough Boring (TBC)					Head Weight (kg)
		TBC Head Set (Rail+Cartridge)	L	Boring Range(ØD)			
				Min.	Max.		
SK50-FMD50-155	7.9	TBC130S [TBR130+BCC1348(SET)]	245	130	180	3.2	
SK50-FMD50-255	13.4	TBC130S [TBR130+BCC1348(SET)]	345	130	180	3.2	
SK50-FMD50-155	7.9	TBC175S [TBR175+BCC1348(SET)]	245	175	225	3.6	
SK50-FMD50-255	13.4	TBC175S [TBR175+BCC1348(SET)]	345	175	225	3.6	
SK50-FMD50-155	7.9	TBC220S [TBR220+BCC1348(SET)]	245	220	270	4	
SK50-FMD50-255	13.4	TBC220S [TBR220+BCC1348(SET)]	345	220	270	4	
SK50-FMD50-155	7.9	TBC265S [TBR265+BCC1348(SET)]	245	265	315	4.2	
SK50-FMD50-255	13.4	TBC265S [TBR265+BCC1348(SET)]	345	265	315	4.2	
SK50-FMD50-155	7.9	TBC310S [TBR310+BCC1354(SET)]	245	310	390	5.2	
SK50-FMD50-255	13.4	TBC310S [TBR310+BCC1354(SET)]	345	310	390	5.2	
SK50-FMD50-155	7.9	TBC385S [TBR385+BCC1354(SET)]	245	385	465	5.5	
SK50-FMD50-255	13.4	TBC385S [TBR385+BCC1354(SET)]	345	385	465	5.5	
SK50-FMD50-155	7.9	TBC460S [TBR460+BCC1354(SET)]	245	460	540	12.5	
SK50-FMD50-255	13.4	TBC460S [TBR460+BCC1354(SET)]	345	460	540	12.5	

(Unit : mm)

Chuck

Arbor/Modular

Boring Tool

Angular Head

cBN/PCD

Device&Accessory

Standard

1:1 CHAT



TBC HEAD SET

Balance Cut Tool for Rough Boring

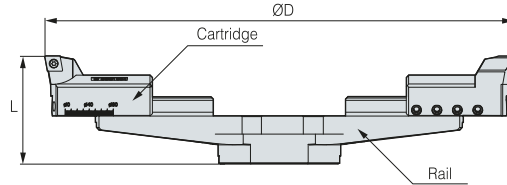

※ If CNMG1204□□ insert is used, BCN1348, BCN1354 cartridges can be ordered

TBC HEAD SET	Head Set (Main Component)			Boring Range(ØD)		L	kg	Accessories
	Designation	Rail	Cartridge	Min.	Max.			Insert
TBC175S	TBR175	BCC1348(SET)	175	225	90	3.9	CCMT1204□□	
TBC220S	TBR220	BCC1348(SET)	220	270	90	4.3	CCMT1204□□	
TBC265S	TBR265	BCC1348(SET)	265	315	90	4.5	CCMT1204□□	
TBC310S	TBR310	BCC1354(SET)	310	390	90	5.5	CCMT1204□□	
TBC385S	TBR385	BCC1354(SET)	385	465	90	5.8	CCMT1204□□	
TBC460S	TBR460	BCC1354(SET)	460	540	90	12.8	CCMT1204□□	

(Unit : mm)

1:1 CHAT



TBC SPARE PART

Balance Cut Tool for Rough Boring Related Parts



SPARE PART	Type	Main Components							
		Rail	Cartridge	Clamp Bolt		Hexagonal Wrench	Clamp Screw	Torx Wrench	
	Images								
	Head Set								
	TBC130S	TBR130	BCC1348(SET)	BX0820	BT0645	LW-3 LW-4 LW-6	BFTX0511N	TRX20	
	TBC175S	TBR175			BT0645				
	TBC220S	TBR220			BT0645				
	TBC265S	TBR265			BT0645				
	TBC310S	TBR310	BCC1354(SET)	BX0820	BT0660		LW-3 LW-4 LW-6	BFTX0511N	TRX20
	TBC385S	TBR385			BT0660				
	TBC460S	TBR460			BT0660				
					BT0660				

1:1 CHAT



BT-FBC

Balance Cut Tool for Fine Boring

MAS
403-BT

Shank

C

Coolant System

130

Min Range

540

Max Range



Boring

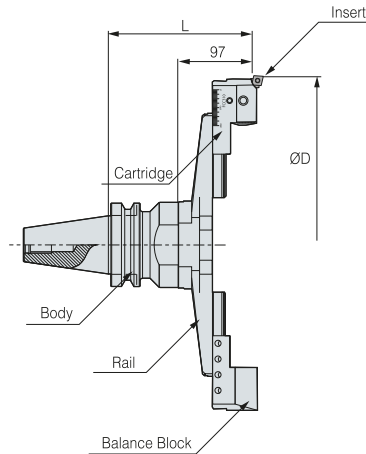

C This product does not support the internal coolant system

※ **Red** : Main Component **Blue** : For Separate Purchase

※ The FMC Arbor are sold individually

※ If BB130-C12bite is used, the minimum boring diameter increases by $\varnothing 6.7$ mm

• For more information on the related parts, see **205P**

• For more information on FMD arbor, see **206P**

• For more information on FBB bite, see **206P**

BT50	FMD Arbor (Individual Order)	Holder Weight (kg)	Fine Boring(FBC)				
			FBC Head Set (Rail+Cartridge+Balance Block)	L	kg	Boring Range($\varnothing D$)	
						Min.	Max.
BT50-FMD50-85	5.9	FBC130S (TBR130+FCC130+FCB130)	182	3.7	130	180	
BT50-FMD50-155	7.9	FBC130S (TBR130+FCC130+FCB130)	252	3.7	130	180	
BT50-FMD50-205	9.7	FBC130S (TBR130+FCC130+FCB130)	302	3.7	130	180	
BT50-FMD50-255	13.4	FBC130S (TBR130+FCC130+FCB130)	352	3.7	130	180	
BT50-FMD50-85	5.9	FBC175S (TBR175+FCC130+FCB130)	182	4.1	175	225	
BT50-FMD50-155	7.9	FBC175S (TBR175+FCC130+FCB130)	252	4.1	175	225	
BT50-FMD50-205	9.7	FBC175S (TBR175+FCC130+FCB130)	302	4.1	175	225	
BT50-FMD50-255	13.4	FBC175S (TBR175+FCC130+FCB130)	352	4.1	175	225	
BT50-FMD50-85	5.9	FBC220S (TBR220+FCC130+FCB130)	182	4.5	220	270	
BT50-FMD50-155	7.9	FBC220S (TBR220+FCC130+FCB130)	252	4.5	220	270	
BT50-FMD50-205	9.7	FBC220S (TBR220+FCC130+FCB130)	302	4.5	220	270	
BT50-FMD50-255	13.4	FBC220S (TBR220+FCC130+FCB130)	352	4.5	220	270	
BT50-FMD50-85	5.9	FBC265S (TBR265+FCC130+FCB130)	182	4.7	265	315	
BT50-FMD50-155	7.9	FBC265S (TBR265+FCC130+FCB130)	252	4.7	265	315	
BT50-FMD50-205	9.7	FBC265S (TBR265+FCC130+FCB130)	302	4.7	265	315	
BT50-FMD50-255	13.4	FBC265S (TBR265+FCC130+FCB130)	352	4.7	265	315	
BT50-FMD50-85	5.9	FBC310S (TBR310+FCC310+FCB310)	182	5.5	310	390	
BT50-FMD50-155	7.9	FBC310S (TBR310+FCC310+FCB310)	252	5.5	310	390	
BT50-FMD50-205	9.7	FBC310S (TBR310+FCC310+FCB310)	302	5.5	310	390	
BT50-FMD50-255	13.4	FBC310S (TBR310+FCC310+FCB310)	352	5.5	310	390	
BT50-FMD50-85	5.9	FBC385S (TBR385+FCC310+FCB310)	182	5.8	385	465	
BT50-FMD50-155	7.9	FBC385S (TBR385+FCC310+FCB310)	252	5.8	385	465	
BT50-FMD50-205	9.7	FBC385S (TBR385+FCC310+FCB310)	302	5.8	385	465	
BT50-FMD50-255	13.4	FBC385S (TBR385+FCC310+FCB310)	352	5.8	385	465	
BT50-FMD50-85	5.9	FBC460S (TBR460+FCC310+FCB310)	182	12.8	460	540	
BT50-FMD50-155	7.9	FBC460S (TBR460+FCC310+FCB310)	252	12.8	460	540	
BT50-FMD50-205	9.7	FBC460S (TBR460+FCC310+FCB310)	302	12.8	460	540	
BT50-FMD50-255	13.4	FBC460S (TBR460+FCC310+FCB310)	352	12.8	460	540	

※ Bite (insert)

FBB130-CC09 (CCMT09T3□□□, CCGT09T3□□□) / FBB130-C12 (CCMT1204□□□) /

FBB130-T11 (TPMT1103□□□, TPGT1103□□□L)

(Unit : mm)

1:1 CHAT



SK-FBC

Balance Cut Tool for Fine Boring



DIN69871 -1A/B	C	130	540	
Shank	Coolant System	Min Range	Max Range	Boring

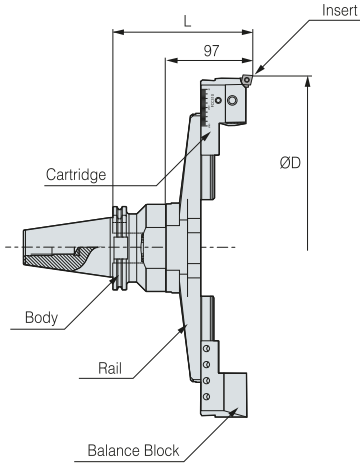

- C** This product does not support the internal coolant system
- ※ Red : Main Component Blue : For Separate Purchase
- ※ The FMD Arbor are sold individually
- ※ If BB130-C12bite is used, the minimum boring diameter increases by $\varnothing 6.7$ mm

- For more information on the related parts, see **205P**
- For more information on FMD arbor, see **206P**
- For more information on FBB bite, see **206P**

SK50

FMD Arbor (Individual Order)	Holder Weight (kg)	Fine Boring(FBC)				
		FBC Head Set (Rail+Cartridge+Balance Block)	L	kg	Boring Range($\varnothing D$)	
					Min.	Max.
SK50-FMD50-155	8	FBC130S (TBR130+FCC130+FCB130)	252	3.8	130	180
SK50-FMD50-255	11.2	FBC130S (TBR130+FCC130+FCB130)	352	3.8	130	180
SK50-FMD50-155	8	FBC175S (TBR175+FCC130+FCB130)	252	4.1	175	225
SK50-FMD50-255	11.2	FBC175S (TBR175+FCC130+FCB130)	352	4.1	175	225
SK50-FMD50-155	8	FBC220S (TBR220+FCC130+FCB130)	252	4.5	220	270
SK50-FMD50-255	11.2	FBC220S (TBR220+FCC130+FCB130)	352	4.5	220	270
SK50-FMD50-155	8	FBC265S (TBR265+FCC130+FCB130)	252	4.7	265	315
SK50-FMD50-255	11.2	FBC265S (TBR265+FCC130+FCB130)	352	4.7	265	315
SK50-FMD50-155	8	FBC310S (TBR310+FCC310+FCB310)	252	5.5	310	390
SK50-FMD50-255	11.2	FBC310S (TBR310+FCC310+FCB310)	352	5.5	310	390
SK50-FMD50-155	8	FBC385S (TBR385+FCC310+FCB310)	252	5.8	385	465
SK50-FMD50-255	11.2	FBC385S (TBR385+FCC310+FCB310)	352	5.8	385	465
SK50-FMD50-155	8	FBC460S (TBR460+FCC310+FCB310)	252	12.8	460	540
SK50-FMD50-255	11.2	FBC460S (TBR460+FCC310+FCB310)	352	12.8	460	540

※ Bite (insert) (Unit : mm)
 FBB130-CC09 (CCMT09T3, CCGT09T3) / FBB130-C12 (CCMT1204) /
 FBB130-T11 (TPMT1103, TPGT1103L)

1:1 CHAT



FBC HEAD SET

Balance Cut Tool for Fine Boring

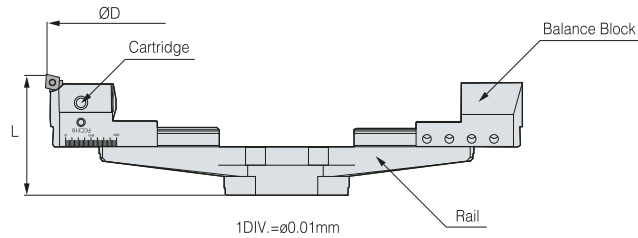

FBC HEAD SET	Head Set (Main Component)			Boring Range(ØD)		L	Package Weight(kg)	Accessories
	Designation	Rail	Cartridge	Balance Block	Min.			Max.
FBC130S	TBR130	FCC130	FCB130	130	180	97	3.8	FBB130-C09 FBB130-C12 FBB130-T11
FBC175S	TBR175	FCC130	FCB130	175	225	97	4.1	
FBC220S	TBR220	FCC130	FCB130	220	270	97	4.5	
FBC265S	TBR265	FCC130	FCB130	265	315	97	4.6	
FBC310S	TBR310	FCC310	FCB310	310	390	97	5.5	
FBC385S	TBR385	FCC310	FCB310	385	465	97	5.8	
FBC460S	TBR460	FCC310	FCB310	460	540	97	12.8	

(Unit : mm)

1:1 CHAT



FBC SPARE PART

Balance Cut Tool for Fine Boring Related Parts



SPARE PART	Type	Main Components					Accessories	
		Rail	Cartridge	Balance Block	Clamp Bolt	Hexagonal Wrench	Bite	
	Images							
	Head Set							
	FBC130S	TBR130	FCC130	FCB130	BTF0810 BTF0814	BT0645	LW-3 LW-4	FBB130-C09 FBB130-C12 FBB130-T11
	FBC175S	TBR175						
	FBC220S	TBR220						
	FBC265S	TBR265	FCC310	FCB310		BT0660		
	FBC310S	TBR310						
	FBC385S	TBR385						
	FBC460S	TBR460						

1:1 CHAT



FBB BITE

Balance Cut Tool for Fine Boring



	Designation	Insert	Insert Screw	Clamp Bolt
FBB	FBB130-C09	CCMT09T3□□, CCGT09T3□□	BFTX0409N	BH0608
	FBB130-C12	CCMT1204□□	BFTX0511N	BH0608
	FBB130-T11	TPMT1103□□, TPGT1103□□	BFTX0307A	BH0608

(Unit : mm)

1:1 CHAT



BT/SK-FMD

Arbor(Basic Holder)

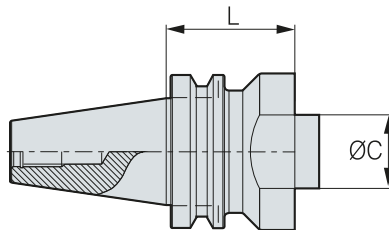

● : Stock

	Designation	L	ØC	kg	Stock
BT50	BT50-FMD50-85	85	50	5.9	●
	BT50-FMD50-155	155	50	7.9	●
	BT50-FMD50-205	205	50	9.7	●
	BT50-FMD50-255	255	50	13.4	●
SK50	SK50-FMD50-155	155	50	8	●
	SK50-FMD50-255	255	50	11.2	●

(Unit : mm)

1:1 CHAT



BT-SMB

Small Micro Boring Bar



MAS
403-BT
C
8
38

Shank Coolant System Min Range Max Range Boring

Fig.1

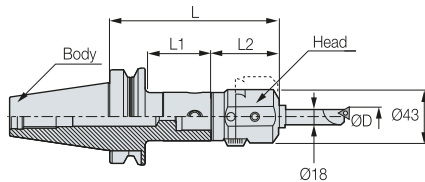
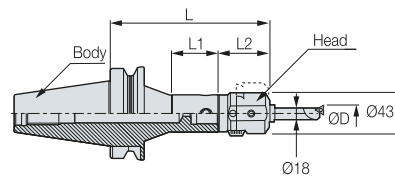
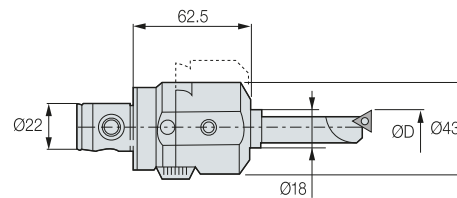

Fig.2



Head



1DIV = ø0.02mm

- ● : Stock
- Adjustment Range : 10mm
- C This product does not support the internal coolant system
- ※ Red : Main Component Blue : For Separate Purchase

- For more information on MD arbor, see 156P
- For more information on the related parts, see 214P

	Head Designation	Stock	Body Designation	Stock	BB Bite	Boring Range(ØD)	L	L1	L2	Fig.	Head Weight (kg)
BT30	SMB4022	●	BT30-MD40F-45	●	BB18-□(S)	Ø8-Ø38	108	22	62.5	1	0.6
	SMB4022	●	BT30-MD40F-60	●	BB18-□(S)	Ø8-Ø38	123	36	62.5	1	0.6
	SMB4022	●	BT30-MD40F-80	●	BB18-□(S)	Ø8-Ø38	143	56	62.5	1	0.6
BT40	SMB4022	●	BT40-MD40F-60	●	BB18-□(S)	Ø8-Ø38	123	31	62.5	1	0.6
	SMB4022	●	BT40-MD40F-110R	●	BB18-□(S)	Ø8-Ø38	173	60	62.5	2	0.6
	SMB4022	●	BT40-MD40F-115	●	BB18-□(S)	Ø8-Ø38	178	83	62.5	1	0.6
BT50	SMB4022	●	BT50-MD40F-60	●	BB18-□(S)	Ø8-Ø38	123	22	62.5	1	0.6
	SMB4022	●	BT50-MD40F-195	●	BB18-□(S)	Ø8-Ø38	258	152	62.5	1	0.6
	SMB4022	●	BT50-MD40F-230R	●	BB18-□(S)	Ø8-Ø38	293	180	62.5	2	0.6

(Unit : mm)

BB Bite (for SMB)	Designation	Boring Range(ØD)		Insert	Screw	kg
		Min.	Max.			
	BB18-7(S)	8	28	TBGT0601□□L	BFTX0204A	0.1
	BB18-9(S)	10	30	TPGT0802□□L	BFTX0204A	0.1
	BB18-11(S)	12	32	TPGT1103□□L	BFTX0307A	0.1
	BB18-13(S)	14	34	TPGT1103□□L	BFTX0307A	0.1
	BB18-15(S)	16	36	TPGT1103□□L	BFTX0307A	0.2
	BB18-17(S)	18	38	TPGT1103□□L	BFTX0307A	0.2

(Unit : mm)

1:1 CHAT



HSK/SK-SMB

Small Micro Boring Bar



DIN 69893-1

Shank

DIN69871 -1A/B

Shank

C

Coolant System

8

Min Range

38

Max Range



Boring

Fig.1

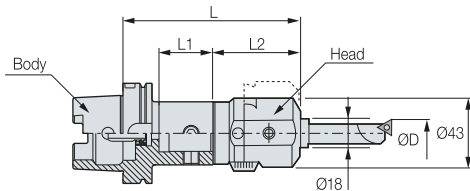

Fig.2

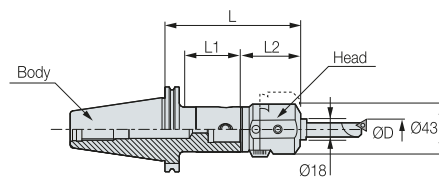
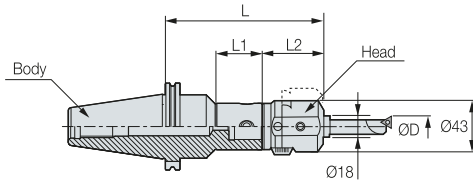
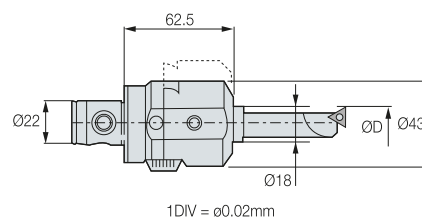

Fig.3



Head



- ● : Stock
- Adjustment Range : 10mm
- This product does not support the internal coolant system
- ※ Red : Main Component Blue : For Separate Purchase

- For more information on MD arbor, see **158P**
- For more information on the related parts, see **214P**

	Head Designation	Stock	Body Designation	Stock	BB Bite	Boring Range(ØD)	L	L1	L2	Fig.	Head Weight (kg)
HSK63A	SMB4022	●	HSK63A-MD40F-70	●	BB18-□(S)	Ø8-Ø38	133	41	62.5	1	0.6
SK40	SMB4022	●	SK40-MD40F-60	●	BB18-□(S)	Ø8-Ø38	123	40	62.5	2	0.6
	SMB4022	●	SK40-MD40F-100	●	BB18-□(S)	Ø8-Ø38	163	79	62.5	2	0.6
SK50	SMB4022	●	SK50-MD40F-145	●	BB18-□(S)	Ø8-Ø38	208	120	62.5	2	0.6
	SMB4022	●	SK50-MD40F-220R	●	BB18-□(S)	Ø8-Ø38	283	83	62.5	3	0.6

(Unit : mm)

BB Bite(forSMB)	Designation	Boring Range(ØD)		Insert	Screw	kg
		Min.	Max.			
	BB18-7(S)	8	28	TBGT0601□□L	BFTX0204A	0.1
	BB18-9(S)	10	30	TPGT0802□□L	BFTX0204A	0.1
	BB18-11(S)	12	32	TPGT1103□□L	BFTX0307A	0.1
	BB18-13(S)	14	34	TPGT1103□□L	BFTX0307A	0.1
	BB18-15(S)	16	36	TPGT1103□□L	BFTX0307A	0.2
	BB18-17(S)	18	38	TPGT1103□□L	BFTX0307A	0.2

(Unit : mm)

1:1 CHAT



BT-KMB

Micro Boring



MAS 403-BT Shank
 C Coolant System
 8 Min Range
 165 Max Range
 Boring

Fig.1

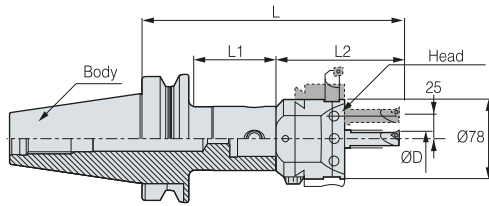

Head

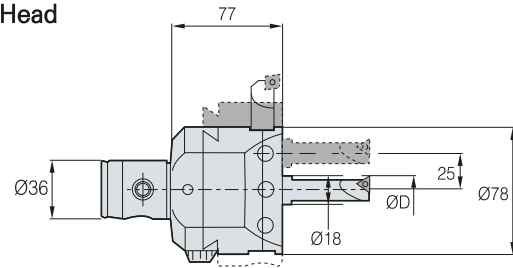

1DIV = $\varnothing 0.02\text{mm}$

- ● : Stock
- Adjustment range : 17mm
- Ⓢ This product does not support the internal coolant system
- ※ Red : Main Component Blue : For Separate Purchase

- For more information on MD arbor, see **156P**
- For more information on the related parts, see **214P**

	Head Designation	Stock	Body Designation	Stock	BB Bite	Boring Range($\varnothing D$)			L	L1	L2	Fig.	Head Weight(kg)
						Center Hole	Eccentric Hole	Side Hole					
BT40	KMB6336	●	BT40-MD63F-64	●	BB18-□(S)	$\varnothing 8\text{--}\varnothing 52$	$\varnothing 43\text{--}\varnothing 101$	MAX $\varnothing 165$	141	37	77	1	2.2
	KMB6336	●	BT40-MD63F-110	●	BB18-□(S)	$\varnothing 8\text{--}\varnothing 52$	$\varnothing 43\text{--}\varnothing 101$	MAX $\varnothing 165$	187	83	77	1	2.2
	KMB6336	●	BT40-MD63F-135	●	BB18-□(S)	$\varnothing 8\text{--}\varnothing 52$	$\varnothing 43\text{--}\varnothing 101$	MAX $\varnothing 165$	212	108	77	1	2.2
BT50	KMB6336	●	BT50-MD63F-75	●	BB18-□(S)	$\varnothing 8\text{--}\varnothing 52$	$\varnothing 43\text{--}\varnothing 101$	MAX $\varnothing 165$	152	35	77	1	2.2
	KMB6336	●	BT50-MD63F-130	●	BB18-□(S)	$\varnothing 8\text{--}\varnothing 52$	$\varnothing 43\text{--}\varnothing 101$	MAX $\varnothing 165$	207	87	77	1	2.2
	KMB6336	●	BT50-MD63F-195	●	BB18-□(S)	$\varnothing 8\text{--}\varnothing 52$	$\varnothing 43\text{--}\varnothing 101$	MAX $\varnothing 165$	272	152	77	1	2.2

(Unit : mm)

BB Bite(For KMB)	Designation	Boring Range($\varnothing D$)				Insert	Screw	kg
		Center	Eccentric					
	BB18-7(S)	8	42	43	91	TBGT0601□□L	BFTX0204A	0.1
	BB18-9(S)	10	44	45	93	TPGT0802□□L	BFTX0204A	0.1
	BB18-11(S)	12	46	47	95	TPGT1103□□L	BFTX0307A	0.1
	BB18-13(S)	14	48	49	97	TPGT1103□□L	BFTX0307A	0.1
	BB18-15(S)	16	50	51	99	TPGT1103□□L	BFTX0307A	0.2
	BB18-17(S)	18	52	53	101	TPGT1103□□L	BFTX0307A	0.2

(Unit : mm)

1:1 CHAT



HSK/SK-KMB

Micro Boring



DIN 69893-1

Shank

DIN69871 -1A/B

Shank

C

Coolant System

8

Min Range

165

Max Range



Boring

Fig.1

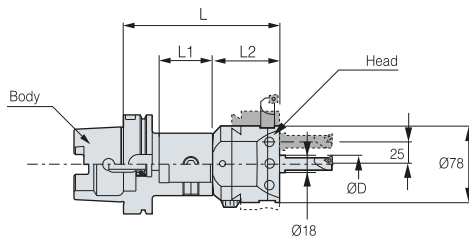

Fig.2

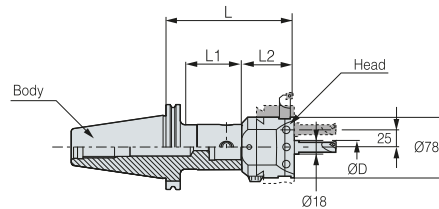
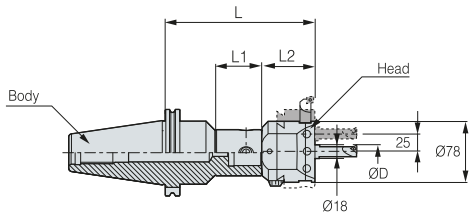
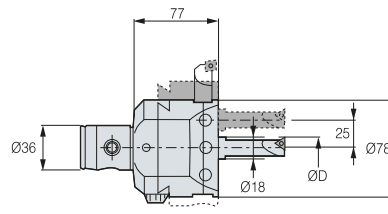

Fig.3



Head



1DIV = 0.02mm

● : Stock

• Adjustment Range : 17mm

Ⓢ This product does not support the internal coolant system

※ Red : Main Component Blue : For Separate Purchase

• For more information on MD arbor, see **158P**

• For more information on the related parts, see **214P**

	Head Designation	Stock	Body Designation	Stock	BB Bite	Boring Range(ØD)			L	L1	L2	Fig.	Head Weight (kg)
						Center Hole	Eccentric Hole	Side Hole					
HSK63A	KMB6336	●	HSK63A-MD63F-95	●	BB18-□(S)	Ø8-Ø52	Ø43-Ø101	MAXØ165	172	69	77	1	2.2
SK40	KMB6336	●	SK40-MD63F-70	●	BB18-□(S)	Ø8-Ø52	Ø43-Ø101	MAXØ165	147	51	77	2	2.2
SK50	KMB6336	●	SK50-MD63F-130	●	BB18-□(S)	Ø8-Ø52	Ø43-Ø101	MAXØ165	207	108	77	2	2.2
	KMB6336	●	SK50-MD63F-230R	●	BB18-□(S)	Ø8-Ø52	Ø43-Ø101	MAXØ165	307	149	77	3	2.2

(Unit : mm)

BB Bite(forKMB)	Designation	Boring Range(ØD)				Insert	Screw	kg
		Center	Eccentric					
	BB18-7(S)	8	42	43	91	TBGT0601□□L	BFTX0204A	0.1
	BB18-9(S)	10	44	45	93	TPGT0802□□L	BFTX0204A	0.1
	BB18-11(S)	12	46	47	95	TPGT1103□□L	BFTX0307A	0.1
	BB18-13(S)	14	48	49	97	TPGT1103□□L	BFTX0307A	0.1
	BB18-15(S)	16	50	51	99	TPGT1103□□L	BFTX0307A	0.2
	BB18-17(S)	18	52	53	101	TPGT1103□□L	BFTX0307A	0.2

(Unit : mm)

1:1 CHAT



BT-SMH

Small Micro Boring Bar



MAS 403-BT C 6 34 Boring
 Shank Coolant System Min Range Max Range Boring

Fig.1

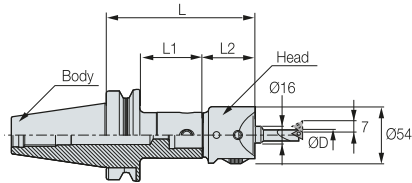
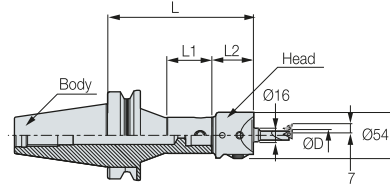
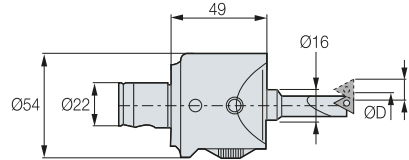

Fig.2



Head



※ 1DIV = ø0.01mm

- : Stock
- Adjustment range : 7mm
- C This product does not support the internal coolant system
- ※ Red : Main Component Blue : For Separate Purchase

- For more information on MD arbor, see **156P**
- For more information on the related parts, see **214P**

	Head Designation	Stock	Body Designation	Stock	BB Bite	Boring Range(ØD)	L	L1	L2	Fig.	Head Weight (kg)
BT30	SMH4022	●	BT30-MD40F-45	●	BB16-□(S)	Ø6~Ø34	94	22	49	1	0.6
	SMH4022	●	BT30-MD40F-60	●	BB16-□(S)	Ø6~Ø34	109	36	49	1	0.6
	SMH4022	●	BT30-MD40F-80	●	BB16-□(S)	Ø6~Ø34	129	56	49	1	0.6
BT40	SMH4022	●	BT40-MD40F-60	●	BB16-□(S)	Ø6~Ø34	109	31	49	1	0.6
	SMH4022	●	BT40-MD40F-100R	●	BB16-□(S)	Ø6~Ø34	149	60	49	2	0.6
	SMH4022	●	BT40-MD40F-115	●	BB16-□(S)	Ø6~Ø34	164	83	49	1	0.6
BT50	SMH4022	●	BT50-MD40F-60	●	BB16-□(S)	Ø6~Ø34	109	22	49	1	0.6
	SMH4022	●	BT50-MD40F-195	●	BB16-□(S)	Ø6~Ø34	244	152	49	1	0.6
	SMH4022	●	BT50-MD40F-230R	●	BB16-□(S)	Ø6~Ø34	279	180	49	2	0.6

(Unit : mm)

Designation	Boring Range(ØD)		Insert	Screw	Wrench
	Min.	Max.			
BB16-5(S)	6	20	WBGT0601□□L	BFTX0203A	TRX06
BB16-7(S)	8	22	TBGT0601□□L	BFTX0204A	TRX06
BB16-9(S)	10	24	TPGT0802□□L	BFTX0204A	TRX06
BB16-11(S)	12	26	TPGT1103□□L	BFTX0307A	TRX10
BB16-15(S)	16	30	TPGT1103□□L	BFTX0307A	TRX10
BB16-19(S)	20	34	TPGT1604□□L	BFTX0410A	TRX15

(Unit : mm)

1:1 CHAT



HSK/SK-SMH

Small Micro Boring Bar



DIN 69893-1

Shank

DIN69871 -1A/B

Shank

C

Coolant System

6

Min Range

34

Max Range



Boring

Fig.1

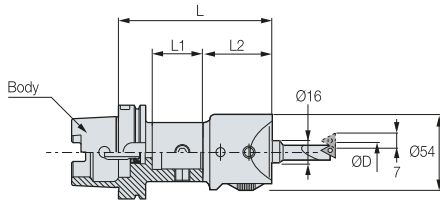

Fig.2

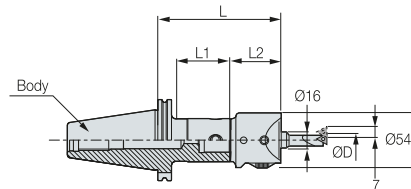
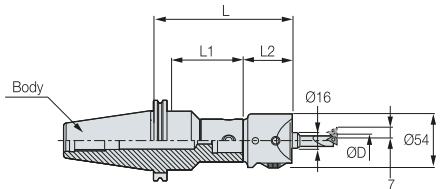
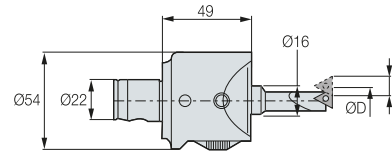

Fig.3



Head



※ 1DIV = ø0.01mm

- : Stock
- Adjustment Range : 7mm
- Ⓢ This product does not support the internal coolant system
- ※ Red : Main Component Blue : For Separate Purchase

- For more information on MD arbor, see **158P**
- For more information on the related parts, see **214P**

	Head Designation	Stock	Body Designation	Stock	BB Bite	Boring Range(ØD)	L	L1	L2	Fig.	Head Weight (kg)
HSK63A	SMH4022	●	HSK63A-MD40F-70	●	BB16-[S]	Ø6-Ø34	119	41	49	1	0.6
SK40	SMH4022	●	SK40-MD40F-60	●	BB16-[S]	Ø6-Ø34	109	40	49	2	0.6
	SMH4022	●	SK40-MD40F-100	●	BB16-[S]	Ø6-Ø34	149	79	49	2	0.6
SK50	SMH4022	●	SK50-MD40F-145	●	BB16-[S]	Ø6-Ø34	194	120	49	2	0.6
	SMH4022	●	SK50-MD40F-220R	●	BB16-[S]	Ø6-Ø34	269	83	49	3	0.6

(Unit : mm)

BB Bite(For SMH)	Designation	Boring Range(ØD)		Insert	Screw	Wrench
		Min.	Max.			
	BB16-5(S)	6	20	WBG0601□□L	BFTX0203A	TRX06
	BB16-7(S)	8	22	TBGT0601□□L	BFTX0204A	TRX06
	BB16-9(S)	10	24	TPGT0802□□L	BFTX0204A	TRX06
	BB16-11(S)	12	26	TPGT1103□□L	BFTX0307A	TRX10
	BB16-15(S)	16	30	TPGT1103□□L	BFTX0307A	TRX10
	BB16-19(S)	20	34	TPGT1604□□L	BFTX0410A	TRX15

(Unit : mm)

1:1 CHAT



SMH SET

Small Micro Boring Set



SMH (SET1)



SMH (SET2)



SMH (SET4)



Set Number

Type	Designation	SMH (SET1)	SMH (SET2)	SMH (SET4)	Applicable Insert
Boring Head	SMH4022	1	1	1	
Body	BT40-MD40F-60	1			
Body	BT50-MD40F-60		1		
BB Bite(Steel)	BB16-0624(S)	1	1	1	WBG060102L
BB Bite(Steel)	BB16-0832(S)	1	1	1	WBG060102L
BB Bite(Steel)	BB16-1040(S)	1	1	1	TPGT080202L
BB Bite(Steel)	BB16-1253(S)	1	1	1	TPGT080202L
BB Bite(Steel)	BB16-1668(S)	1	1	1	TPGT110304L
BB Bite(Steel)	BB16-2083(S)	1	1	1	TPGT110304L
BB Bite(Steel)	BB16-2590(S)	1	1	1	TPGT110304L
BB Bite(Steel)	BB16-3090(S)	1	1	1	TPGT110304L
Screw	BFTX0203A	2	2	2	
Screw	BFTX0204A	2	2	2	
Screw	BFTX0307A	2	2	2	
Wrench	LW-3	1	1	1	
Wrench	LW-5	1	1	1	
Wrench	TRX06	1	1	1	
Wrench	TRX10	1	1	1	

※ The applied insert is based on Sumitomo products.

1:1 CHAT



SMB SPARE PART

Small Micro Boring Bar Related Parts



• The taper screw is built in the arbor by default.

• For more information on MD arbor, see **156P**

SPARE PART	Type	Main Components			Accessories	
		Boring Head	Taper Screw	Wrench	Boring Bite	MD Arbor
	Images					
	Designation					
	SMB	SMB4022	BTT1013F	LW-2.5	BB18	MD40F

1:1 CHAT



KMB SPARE PART

Micro Boring Related Parts



• The taper screw is built in the arbor by default

• For more information on MD arbor, see **156P**

SPARE PART	Type	Main Components			Accessories	
		Boring Head	Taper Screw	Wrench	Boring Bite	MD Arbor
	Images					
	Designation					
	KMB	KMB6336	BTT1620F	LW-4.0	BB18	MD63F

1:1 CHAT



SMH SPARE PART

Micro Boring Related Parts



• The taper screw is built in the arbor by default

• For more information on MD arbor, see **156P**

SPARE PART	Type	Main Components			Accessories	
		Boring Head	Taper Screw	Wrench	Boring Bite	MD Arbor
	Images					
	Designation					
	SMH	SMH4022	BTT1013F	LW-3.0	BB16	MD40F

1:1 CHAT



BB BITE

BB Bite(for SMB, SMH, KMB)



Boring Bite : BB Type(for SMB)

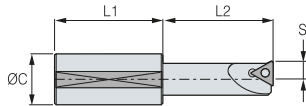

Designation	Boring Range (Center)		S	ØC	L1	L2	Insert	Insert Screw
	Min.	Max.						
BB18 - 7(S)	8	28	3.5	18	30	30	TBGT0601□□L	BFTX0204A
BB18 - 9(S)	10	30	4.5	18	30	40	TPGT0802□□L	BFTX0204A
BB18 - 11(S)	12	32	5.5	18	30	45	TPGT1103□□L	BFTX0307A
BB18 - 13(S)	14	34	6.5	18	40	45	TPGT1103□□L	BFTX0307A
BB18 - 15(S)	16	36	7.5	18	40	50	TPGT1103□□L	BFTX0307A
BB18 - 17(S)	18	38	8.5	18	40	50	TPGT1103□□L	BFTX0307A

(Unit : mm)

Boring Bite : BB Type(for SMH)

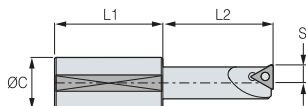

Designation	Boring Range (Center)		S	ØC	L1	L2	Insert	Insert Screw	Wrench
	Min.	Max.							
BB16 - 5(S)	6	20	2.75	16	34	20	WGBT0601□□L	BFTX0203A	TRX06
BB16 - 7(S)	8	22	3.5	16	34	30	TBGT0601□□L	BFTX0204A	TRX06
BB16 - 9(S)	10	24	4.5	16	34	40	TPGT0802□□L	BFTX0204A	TRX06
BB16 - 11(S)	12	26	5.5	16	34	45	TPGT1103□□L	BFTX0307A	TRX10
BB16 - 15(S)	16	30	7.5	16	34	50	TPGT1103□□L	BFTX0307A	TRX10
BB16 - 19(S)	20	34	9.5	16	60	34	TPGT1604□□L	BFTX0410A	TRX15

(Unit : mm)

Boring Bite : BB Type(for KMB)

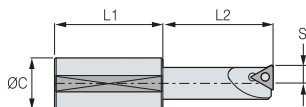

Designation	Boring Range(Center)				S	ØC	L1	L2	Insert	Insert Screw
	Center		Eccentric							
BB18 - 7(S)	8	42	43	91	3.5	18	30	30	TBGT0601□□L	BFTX0204A
BB18 - 9(S)	10	44	45	93	4.5	18	30	40	TPGT0802□□L	BFTX0204A
BB18 - 11(S)	12	46	47	95	5.5	18	30	45	TPGT1103□□L	BFTX0307A
BB18 - 13(S)	14	48	49	97	6.5	18	40	45	TPGT1103□□L	BFTX0307A
BB18 - 15(S)	16	50	51	99	7.5	18	40	50	TPGT1103□□L	BFTX0307A
BB18 - 17(S)	18	52	53	101	8.5	18	40	50	TPGT1103□□L	BFTX0307A

(Unit : mm)

Standard Boring Bite (Insert Type)

Maker	Designation	Purpose of Use	Shank Size	Insert
SUMITOMO	BBPT (WBPT : Carbide Shank)	For Through Hole Boring	Ø8,10,12,16	TP□T0802□□L, TP□T1103□□L
	BBPW (WBPW : Carbide Shank)		Ø5.5,8,10	WB□T0601□□L WB□T0601□□L, WB□T0802□□L
	S-SCLCR	For Stop and Through Hole Boring	Ø8,10,12,16	CC□T0602□□, CC□T0602□□
	C-SCLCR : Carbide Shank			CC□T09T3□□, CC□T09T3□□
KORLOY	S-STFPR (C-STFPR : Carbide Shank)	For Through Hole Boring	Ø12,16	TP□T1103□□L
	S-STUPR		Ø8	TP□□0802□□L
	S-SWUBR (E-SWUBR : Carbide Shank)		Ø5.5,8,10	WB□T0201□□L, WB□TS302□□L
	S-SCLCR (C-SCLCR : Carbide Shank)	For Stop and Through Hole Boring	Ø10,12,16	CC□T0301□□, CC□T0401□□
	S-SCLPR (C-SCLPR : Carbide Shank)		Ø8,10,12,16	CP□T0802□□, CP□T0903□□

(Unit : mm)

1:1 CHAT



BT-BSA

Square Boring Bar

MAS
403-BT

Shank

C

Coolant System

25

Min Range

160

Max Range



Boring

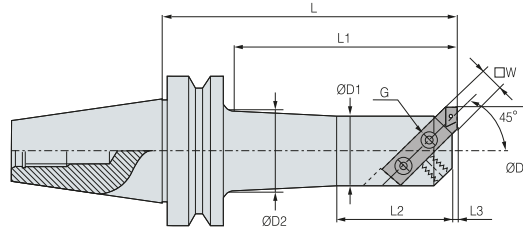

- : To be switched to NP order after stock depletion
- : Stock

C This product does not support the internal coolant system

• For more information on BB bite, see **217P**

Designation	Boring Range(ØD)		L	ØD1	L1	L2	L3	ØD2	W	G	Package Weight(kg)	Stock
	Min.	Max.										
BT50-BSA25-135	25	38	135	20	91	35	1	22	8	M6	4.2	●
BT50-BSA30-165	30	42	165	24	120	40	1.6	26	8	M6	4.5	●
BT50-BSA38-180	38	52	180	30	134	50	2.6	33	10	M8	4.9	●
BT50-BSA42-210	42	56	210	34	167	50	2.6	37	10	M8	5.3	●
BT50-BSA50-180	50	65	180	40	134	65	3	46	13	M10	5.5	●
BT50-BSA50-240	50	65	240	40	197	65	3	44	13	M10	6.2	●
BT50-BSA62-195	62	90	195	50	150	80	2	56	16	M10	6.3	●
BT50-BSA62-270	62	90	270	50	225	80	2	56	16	M10	7.8	●
BT50-BSA72-195	72	110	195	60	149	95	2.4	66	19	M12	7.2	●
BT50-BSA72-285	72	110	285	60	239	95	2.4	66	19	M12	9.5	●
BT50-BSA90-210	90	125	210	75	167	110	4	80	19	M12	9.5	●
BT50-BSA105-195	105	160	195	90	154	130	3	-	25	M12	10.7	●

(Unit : mm)

1:1 CHAT



BSA SPARE PART

Boring Bar Related Parts

Main Components

Type	Main Components	
	Set Screw	
Images		
Designation		
BSA25	BTF0606	
BSA30	BTF0606	
BSA38	BTF0808	
BSA42	BTF0810	
BSA50	BTF1012	
BSA62	BTF1016	
BSA72	BTF1216	
BSA90	BTF1220	
BSA105	BTF1225	

Accessories

Type	Accessories	
	Bite	Wrench
Images		
Designation		
BSA25	BH408	LW-3
BSA30	BH408	LW-3
BSA38	BH410	LW-4
BSA42	BH410	LW-4
BSA50	BH413	LW-5
BSA62	BH416	LW-5
BSA72	BH419	LW-6
BSA90	BH419	LW-6
BSA105	BH425	LW-6

1:1 CHAT



BH

Square Boring Bite for BSA



Boring



Fig.1

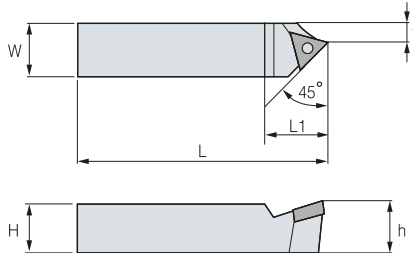
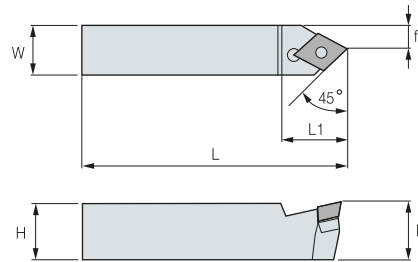

Fig.2



● : Stock

Designation	Fig.	W=H	h	L	L1	f	Usable Insert	Insert Screw	Insert Wrench	Stock
BH408	1	8	7.8	40	9	3.2	TPGT0802□□L	BFTX0204A	TRX06	●
BH410	2	10	9.8	50	10	4.2	CPMT0602□□	BFTX02506N	TRX08	●
BH413	2	13	12.8	60	14	6.2	CPMT0803□□	BFTX0307N	TRX10	●
BH416	2	16	15.8	80	18	7.3	CPMT0903□□	BFTX0407A	TRX15	●
BH419	2	19	18.8	95	22	10.3	CPMH1204□□	BFN0511T	TRX20	●
BH425	2	25	24.8	125	26	14.2	CPMH1604□□	BFX0611R	LW-3.0	●

(Unit : mm)

Insert for Square Boring Bite

Maker	Insert	Grade	Workpiece	Machining
KORLOY	CCGT0602□□-AK	H01	Aluminum	Fine Boring
	CCGT09T3□□-AK			
	CCGT1204□□-AK			

Maker	Insert	Grade	Workpiece	Machining
SUMITOMO	TPGT0802□□	Cermet : T1500A	Steel, Cast Iron, Stainless Steel	Fine Boring
	CPMT0602□□	Coating : AC6030M	Steel	Rough Boring
	CPMT0803□□	Coating : AC6030M	Steel	Rough Boring
	CPMT0903□□	Coating : AC8015P	Steel, Alloy Steel, Cast Iron	Rough Boring
		Coating : AC6030M	Stainless Steel	Rough Boring
		Coating : T3000Z	Steel, Cast Iron, Stainless Steel	Rough Boring-Fine Boring
	CPMH1204□□	Coating : AC6030M	Steel, Stainless Steel	Rough Boring
CPMH1604□□	Coating : AC6030M	Steel, Stainless Steel	Rough Boring	

(Unit : mm)

1:1 CHAT



BT-BKA

FZ Micro Boring Bar



MAS
403-BT

Shank

C

Coolant System



Boring

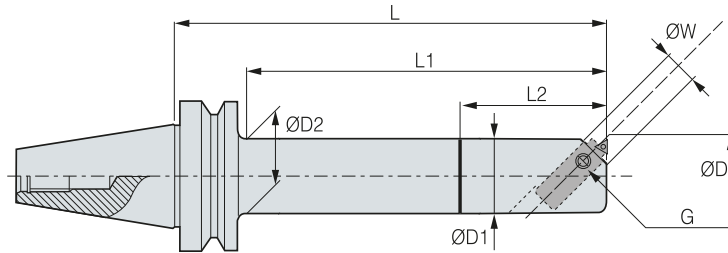

- : To be switched to NP order after stock depletion
- : Stock

C This product does not support the internal coolant system

※ Red : Main Component Blue : For Separate Purchase

※ The boring unit is an item for separate purchase.

※ For more information on the boring range and insert used, see the FZ unit table.

• For more information on the related parts, see **220P**

• For more information on the FZ unit, see **221P**

	Designation	Stock	FZ Unit	Stock	L	L1	L2	ØD1	ØD2	ØW	G	kg	Package Weight(kg)	
BT30	BT30-BKA28-150	●	FZ10-□□-3[S]	●	150	123	-	25	-	10	M6	0.9	1	
	BT30-BKA36-150	●	FZ12-□□-3[S]	●	150	125	-	32	-	12	M8	1.2	1.3	
	BT30-BKA45-150	●	FZ16-□□-3[S]	●	150	128	-	40	-	16	M10	1.6	1.7	
BT40	BT40-BKA23-150	●	FZ8-□□-3[S]	●	150	95	40	20	22	8	M6	1.6	1.9	
	BT40-BKA23-225		FZ8-□□-3[S]	●	225	95	40	20	22	8	M6	2.8	3.1	
	BT40-BKA28-165	●	FZ10-□□-3[S]	●	165	122	50	25	26	10	M6	1.5	1.7	
	BT40-BKA28-225	●	FZ10-□□-3[S]	●	225	125	50	25	26	10	M6	2.6	2.9	
	BT40-BKA36-165	●	FZ12-□□-3[S]	●	165	133	60	32	35	12	M8	1.9	2.1	
	BT40-BKA36-225	●	FZ12-□□-3[S]	●	225	193	60	32	35	12	M8	2.8	3.1	
	BT40-BKA45-165	●	FZ16-□□-3[S]	●	165	133	70	40	44	16	M10	2.3	2.6	
	BT40-BKA45-225	●	FZ16-□□-3[S]	●	225	208	70	40	44	16	M10	3	3.2	
	BT40-BKA56-165	●	FZ20-□□-3[S]	●	165	-	70	50	54	20	M12	3	3.2	
	BT40-BKA56-240	●	FZ20-□□-3[S]	●	240	-	70	50	54	20	M12	4.2	4.5	
	BT40-BKA72-165	●	FZ25-□□-3[S]	●	165	-	-	63	-	25	M16	4	4.2	
	BT40-BKA72-240	●	FZ25-□□-3[S]	●	240	-	-	63	-	25	M16	5.7	5.9	
	BT40-BKA90-165	●	FZ32-□□-3[S]	●	165	-	100	80	-	32	M20	4.9	5.2	
	BT40-BKA90-240		FZ32-□□-3[S]	●	240	-	100	80	-	32	M20	6.8	7	

(Unit : mm)

1:1 CHAT





BKA SPARE PART

FZ Micro Boring Bar Related Parts

Main Components

SPARE PART	Type	Main Components
		Set Screw
	Images	
	Designation	
	BKA23	BTF0606
	BKA28	BTF0606
	BKA36	BTF0808
	BKA45	BTF1010
	BKA56	BTF1212
	BKA72	BTF1616
	BKA90	BTF2020
	BKA110	BTF2020

Accessories

SPARE PART	Type	Accessories	
		Unit	Wrench
	Images		
	Designation		
	BKA23	FZ8-23-3(P10.K10)	
	BKA28	FZ10-28-3(S)	FZ10-32-3(S)
	BKA36	FZ12-36-3(S)	FZ12-40-3(S)
	BKA45	FZ16-45-3(S)	FZ16-50-3(S)
	BKA56	FZ20-56-3(S)	FZ20-64-3(S)
	BKA72	FZ25-72-3(S)	FZ25-80-3(S)
	BKA90	FZ32-90-3(S)	FZ32-100-3(S)
	BKA110	FZ32-110-3(S)	FZ32-125-3(S)

1:1 CHAT



FZ UNIT

FZ Unit Inclined Mounting Type



Coolant System



Boring

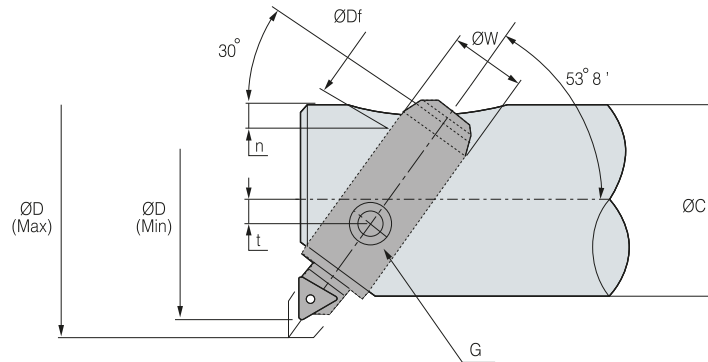

C This product does not support the internal coolant system
 ※ In case of one gradation adjustment, $\varnothing 0.02\text{mm}$

• For more information on the applicable insert, see **222P**
 • For more information on the related parts, see **222P**

	Designation	Boring Range ($\varnothing D$)		Insert Holder (ISO)	Insert (ISO)	$\varnothing C$	n	$\varnothing D_f$	t	G	$\varnothing W$	kg	Package Weight(kg)
		Min.	Max.										
FZ8	FZ8-23-3(P10,K10)	23	29(32)	8Z3 (Brazed Tip)	-	20	3	8	1.5	M6	8	0.04	0.04
	FZ8-26-3(P10,K10)	26	32(34)	8Z3 (Brazed Tip)	-	20	3	8	1.5	M6	8	0.04	0.04
FZ10	FZ10-28-3(S)	28	34(38)	U10Z3S	TBGT0601□□L	25	3.5	8	2	M6	10	0.1	0.1
	FZ10-32-3(S)	32	38(44)	U10Z3S	TBGT0601□□L	25	3.5	8	2	M6	10	0.1	0.1
FZ12	FZ12-36-3(S)	36	44(48)	U12Z3S	TBGT0601□□L	32	4	10	2.5	M8	12	0.1	0.1
	FZ12-40-3(S)	40	48(55)	U12Z3S	TBGT0601□□L	32	4	10	2.5	M8	12	0.1	0.1
FZ16	FZ16-45-3(S)	45	54(60)	U16Z3S	TBGT0802□□L	40	6.5	12	3	M10	16	0.1	0.0
	FZ16-50-3(S)	50	59(68)	U16Z3S	TBGT0802□□L	40	6.5	12	3	M10	16	0.1	0.1
FZ20	FZ20-56-3(S)	56	68(78)	U20Z3S	TBGT0802□□L	50	7	16	5	M12	20	0.2	0.2
	FZ20-64-3(S)	64	76(90)	U20Z3S	TBGT0802□□L	50	7	16	5	M12	20	0.2	0.2
FZ25	FZ25-72-3(S)	72	88(100)	U25Z3S	TPGT1103□□L	63	8	20	4	M16	25	0.3	0.3
	FZ25-80-3(S)	80	96(114)	U25Z3S	TPGT1103□□L	63	8	20	4	M16	25	0.3	0.3
FZ32	FZ32-90-3(S)	90	114(126)	U32Z3S	TPGT1103□□L	80	10	25	6	M20	32	0.6	0.6
	FZ32-100-3(S)	100	124(140)	U32Z3S	TPGT1103□□L	80	10	25	6	M20	32	0.6	0.6
	FZ32-110-3(S)	110	134(150)	U32Z3S	TPGT1103□□L	100	10	25	12	M20	32	0.7	0.7
	FZ32-125-3(S)	125	149(175)	U32Z3S	TPGT1103□□L	100	10	25	12	M20	32	0.8	0.8

(Unit : mm)

1:1 CHAT



FZ UNIT SPARE PART

FZ Unit Related Parts



SPARE PART	Type	Main Components					Accessories
		Housing Set	Spindle	Insert Screw	Torx Wrench	L-Wrench	Wrench
	Images						
	Designation						
	FZ8-23, 26-3, P10	8-23, 26-3	8Z3(P10)	-	-	LW-1.5	R0/N0
	FZ8-23, 26-3, K10	8-23, 26-3	8Z3(K10)	-	-	LW-1.5	R0/N0
	FZ10-28, 32-3(S)	10-28, 32-3	U10Z3-TB06	BFTX0204A	TRX6	LW-2.0	R2/N1
	FZ12-36, 40-3(S)	12-36, 40-3	U12Z3-TB06	BFTX0204A	TRX6	LW-2.5	R2A/N2
	FZ16-45, 50-3(S)	16-45, 50-3	U16Z3-TP08	BFTX0204A	TRX6	LW-3.0	N3
	FZ20-56, 64-3(S)	20-56, 64-3	U20Z3-TP08	BFTX0204A	TRX6	LW-4.0	R4/N4
	FZ25-72, 80-3(S)	25-72, 80-3	U25Z3-TP11	BFTX0307A	TRX10	LW-4.0	ZV25
	FZ32-90, 100, 110, 125-3(S)	32-90, 100-3	U32Z3-TP11	BFTX0307A	TRX10	LW-5.0	R5/N5

1:1 CHAT



INSERT

FZ Unit, FF Unit



Fig.1
Chip Breaker Type

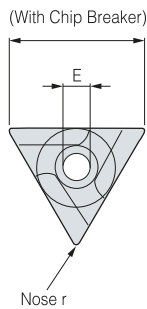

Fig.2

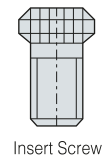
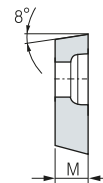
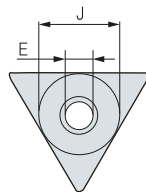

Fig.	Insert Material Type	Workpiece
1	K10(W.C)	Cast Iron, Aluminum
1	P10(W.C)	Steel, Stainless Steel
1	CN1000 or CN2000(Cermet)	Steel
2	K10(W.C)	Exclusive for Cast Iron

Insert	Fig.	J	r	M	E	Insert Screw	Wrench
TBGT0601□□L	1	3.97	0.2	1.59	2.2	BFTX0204A	TRX6
TPGT0802□□L	1	4.76	0.2	2.38	2.4	BFTX0204A	TRX6
TPGT1103□□L	1	6.35	0.4	3.18	2.8	BFTX0307A	TRX10

(Unit : mm)

1:1 CHAT



BT-BCF

Micro Boring Bar



MAS 403-BT C 29.5 141

Shank Coolant System Min Range Max Range Boring

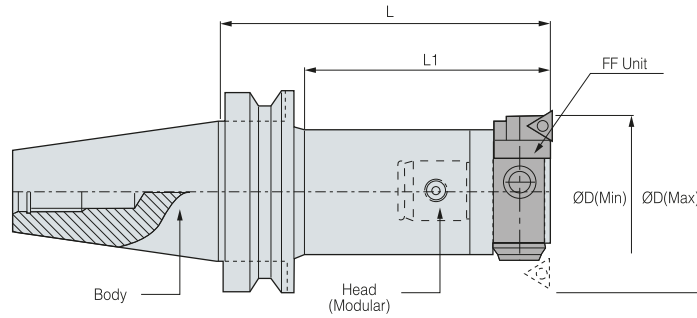

● : Stock

C This product does not support the internal coolant system

※ Red : Main Component Blue : For Separate Purchase

※ The bodies, boring units, and head sets are sold individually

※ Right-angled type micro boring bar

• For more information on FF boring unit, see **225P**

• For more information on the related parts, see **225P**

• For more information on the applicable insert, see **226P**

	Body Designation	Head Designation	Stock	Boring Unit	Stock	Boring Range(ØD)		L	L1	Head Package Weight(kg)	Body
						Min.	Max.				
BT30	BT30-MD25F-90	BCF2530	●	FF10-30[S]	●	29.5	42	140	113	0.3	0.6
	BT30-MD32F-80	BCF3239	●	FF12-39[S]	●	39	50	140	115	0.4	0.7
	BT30-MD40F-80	BCF4047	●	FF16-47[S]	●	47	66	140	116	0.6	0.9
	BT30-MD50F-70	BCF5058	●	FF20-58[S]	●	58	83	140	117	1	0.9
BT40	BT40-MD25F-95	BCF2530	●	FF10-30[S]	●	29.5	42	145	113	0.3	1.1
	BT40-MD32F-100	BCF3239	●	FF12-39[S]	●	39	50	160	130	0.4	1.1
	BT40-MD40F-115	BCF4047	●	FF16-47[S]	●	47	66	175	143	0.6	1.6
	BT40-MD50F-105	BCF5058	●	FF20-58[S]	●	58	83	175	143	1	1.8
	BT40-MD63F-110	BCF6379	●	FF25-79[S]	●	79	108	180	152	1.7	2.4
	BT40-MD80F-100	BCF100	●	FF32-100[S]	●	100	141	200	172	3.8	2.9
BT50	BT50-MD25F-105	BCF2530	●	FF10-30[S]	●	29.5	42	155	112	0.3	4.1
	BT50-MD32F-110	BCF3239	●	FF12-39[S]	●	39	50	170	127	0.4	4.3
	BT50-MD40F-195	BCF4047	●	FF16-47[S]	●	47	66	255	212	0.6	5.2
	BT50-MD50F-225	BCF5058	●	FF20-58[S]	●	58	83	295	252	1	6.4
	BT50-MD63F-195	BCF6379	●	FF25-79[S]	●	79	108	265	222	1.6	7.2
	BT50-MD80F-175	BCF100	●	FF32-100[S]	●	100	141	275	234	3.8	8.4

Boring Unit (Insert)

• FF10-30(S) / FF12-39(S) (TBGT0601L)

• FF16-47(S) / FF20-58(S) (TPGT0802L)

• FF25-79(S) / FF32-100(S) (TPGT1103L)

(Unit : mm)

1:1 CHAT



BT-BCF

Micro Boring Bar



MAS 403-BT C 138 450

Shank Coolant System Min Range Max Range Boring

Fig.1

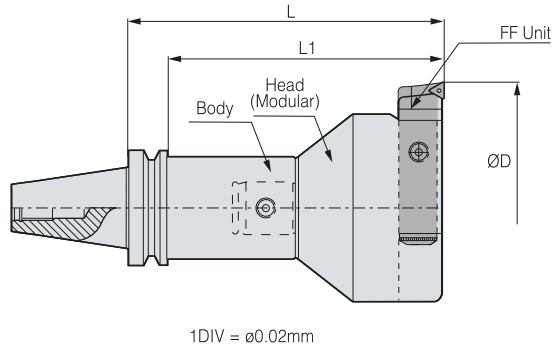
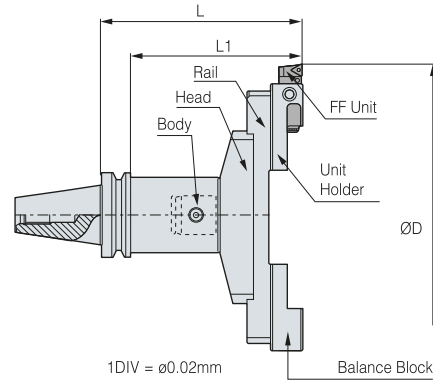

Fig.2



- : To be discontinued after inventory depletion
- : Stock
- C** This product does not support the internal coolant system
- ※ Red : Main component Blue : For separate purchase
- ※ The bodies, boring units, and head sets are sold individually
- ※ Modular type micro boring bar

- For more information on FF boring unit, see [225P](#)
- For more information on the related parts, see [225P](#)
- For more information on the applicable insert, see [226P](#)

	Body Designation	Head Designation	Stock	Boring Unit	Stock	Boring Range (ØD)		L	L1	Fig.	Package Weight(kg)
						Min.	Max.				
BT50	BT50-MD90F-75	BCF138	○	FF32-138(S)	●	138	159	175	136.5	1	8
	BT50-MD90F-145	BCF138	○	FF32-138(S)	●	138	159	245	204	1	9
	BT50-MD90F-75	BCF150	○	FF32-138(S)	●	150	171	175	136.5	1	9.6
	BT50-MD90F-145	BCF150	○	FF32-138(S)	●	150	171	245	204	1	12.4
	BT50-MD90F-195	BCF150	○	FF32-138(S)	●	150	171	295	254	1	15.4
	BT50-MD90F-75	BCF170	○	FF32-138(S)	●	170	191	175	136.5	1	9.8
	BT50-MD90F-145	BCF170	○	FF32-138(S)	●	170	191	245	204	1	12.6
	BT50-MD90F-195	BCF170	○	FF32-138(S)	●	170	191	295	254	1	15.8
	BT50-MD90F-75	BCF190	○	FF32-138(S)	●	190	211	175	136.5	1	10.2
	BT50-MD90F-145	BCF190	○	FF32-138(S)	●	190	211	245	204	1	13
	BT50-MD90F-195	BCF190	○	FF32-138(S)	●	190	211	295	254	1	16.1
	BT50-MD90F-75	BCF210	○	FF32-138(S)	●	210	231	175	136.5	1	10.5
	BT50-MD90F-145	BCF210	○	FF32-138(S)	●	210	231	245	204	1	13.4
	BT50-MD90F-195	BCF210	○	FF32-138(S)	●	210	231	295	254	1	16.5
	BT50-MD90F-75	BCF230	○	FF32-138(S)	●	230	251	175	136.5	1	13.1
	BT50-MD90F-145	BCF230	○	FF32-138(S)	●	230	251	245	204	1	15.6
	BT50-MD90F-195	BCF230	○	FF32-138(S)	●	230	251	295	254	1	18.2
	BT50-MD90F-75	BCF350FS	○	FF25-79(S)	●	350	450	182	143.5	2	16.4
	BT50-MD90F-145	BCF350FS	○	FF25-79(S)	●	350	450	252	211	2	19
BT50-MD90F-195	BCF350FS	○	FF25-79(S)	●	350	450	302	261	2	20.8	

※ Boring unit (Insert) (Unit : mm)
 • FF25-79(S) / FF32-138(S) (TPGT1103L)

1:1 CHAT  **FF**
FF Unit

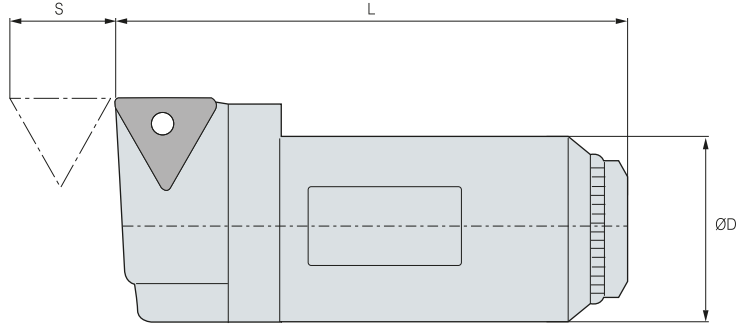
C This product does not support the internal coolant system

Designation	ØD	L	S	Usable Insert
FF10-30(S)	10	28.5	3.5	TBGT0601□□L
FF12-39(S)	12	37.5	3.5	TBGT0601□□L
FF16-47(S)	16	45	5	TPGT0802□□L
FF20-58(S)	20	56	7	TPGT0802□□L
FF25-79(S)	25	77.5	8	TPGT1103□□L
FF32-100(S)	32	97	11	TPGT1103□□L
FF32-138(S)	32	131	11	TPGT1103□□L

(Unit : mm)

1:1 CHAT  **FF UNIT SPARE PART**
FF Unit Related Parts



Type	Main Components		
	Clamp Screw	Torx Wrench	Wrench
Images			
Designation			
FF10-30(S)	BFTX0204A	TRX06	LW-2
FF12-39(S)	BFTX0204A	TRX06	LW-2.5
FF16-47(S)	BFTX0204A	TRX06	LW-3
FF20-58(S)	BFTX0204A	TRX06	LW-4
FF25-79(S)	BFTX0307A	TRX10	LW-4
FF32-100(S)	BFTX0307A	TRX10	LW-5

1:1 CHAT



INSERT

Boring Insert

Insert	Applicable Products (Boring Head)
CCET0301□□L	FBB15C(FBH15,FBH18)
CCET0401□□L	FBB20N-C, FBB20N-1-C(FBH1920B) FBB26N-C, FBB26N-1-C(FBH2526B)
CCMT0602□□L	BCC28(DBC2528S),BCC35(DBC3235S)
CCGT0602□□L	FBB33N-C, FBB33N-1-C(FBH3233B), FBH42N-C FBH42N-1-C(FBH4042B), FBH53N-1-C(FBH5053B)
CPMT0602□□L	BH410(BSA38,BSA42)
CPMT0803□□L	BH413(BSA50)
CCMT09T3□□L	BCC46(DBC4046S),BCC58(DBC5058S)
CCGT09T3□□L	FBB53N-C, FBH53N-1-C09(FBH5053B), FBB68N-C, FBB68N-C09, FBB68N-1-C09(FBH6368B, FBH6398B, FBH8098B) FBB130-C09(FBC130,FBC175,FBC220,FBC265,FBC310,FBC385,FBC460)
CPMT0903□□	BH416(BSA62)
CCMT1204□□L	BCC74(DBC6374S),BCC94(DBC8094),BCC120(DBC120S)
CCGT1204□□L	BCC1348(TBC130,TBC175,TBC220,TBC265) BCC1354(TBC310,TBC385,TBC460) FBB130-C12(FBC130,FBC175,FBC220,FBC265,FBC310,FBC385,FBC460)
CPMH1204□□L	BH419(BSA72,BSA90)
WBG0601□□L	BB16-5(S)(SMH4022)
TBGT0601□□L	BB16-7(S), BB18-7(S)(KMB6336,SMB4022) FZ10-28-3(S),FZ10-32-3(S)(BSA30) FZ12-36-3(S),FZ12-40-3(S)(BSA38) FF10-30(S)(BCF2530),FF12-39(S)(BCF3239)
TPGT0802□□L	BB16-9(S)(SMH4022),BB18-9(S)(KMB6336,SMB4022) BH408(BSA25, BSA28) FBB20N,FBB20N-1(FBH1920B) FBB26N,FBB26N-1(FBH2526B) FBB33N,FBB33N-1(FBH3233B)
TPGW0802□□	FBB42N, FBB42N-1(FBH4042B) FZ16-45-3(S),FZ16-50-3(S)(BSA42) FZ20-56-3(S),FZ20-64-3(S)(BSA50) FF16-47(S)(BCF4047), FF20-58(S)(BCF5058)
TPGT1103□□L	FBB42N-T11,FBB42N-1-T11(FBH4042B), FBB53N-11, FBB53N-1-T11(FBH5053B) FBB68N-11,FBB68N-1-T11(FBH6368B, FBH6398B, FBH8098B) FBB130-T11(FBC130,FBC175,FBC220,FBC265, FBC310,FBC385,FBC460) BB16-11(S),15(S),19(S)(SMH4022) BB18-11(S),13(S),15(S),17(S)(KMB6336,SMB4022) FZ25-72-3(S),FZ25-80-3(S)(BSA62) FZ32-90-3(S), FZ32-100-3(S)(BSA72) FZ32-110-3(S),FZ32-125-3(S)(BSA90)FF25-79(S)(BCF6379,BCF250FS,BCF350FS) FF32-100(S)(BCF100) FF32-138(S)(BCF138,BCF170,BCF190,BCF210,BCF230)
TPGT1604□□L	BB16-19(S)(SMH4022)
CPMH1604□□L	BH425(BSA105)



Angular Head

DINE TOTAL TOOLING SOLUTION

ANGULAR HEAD	228
KAH	230
KHU	232
KAG	234
HRAG	236
MAH	238
KAC	240
SAH	242
POSITIONING BLOCK	244
ATM	246
ATU	250

1:1 CHAT



ANGULAR HEAD

Angular Head



KAH 90° Angle Type



Due to the horizontal rotation by 360°, machining can be conducted at various locations.

Efficient side surface machining can be performed due to the fixed tilt angle of 90°.

- HSK and SK types are customizable.

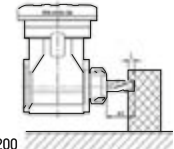

BT50-KAH20-200



KHU 0-90° Tilting Type



Due to the horizontal rotation by 360°, machining can be conducted at various locations.

Due to tilt angle of 0-90°, machining can be conducted at various angles.

- HSK and SK types are customizable.

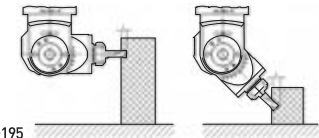

BT50-KHU20-195



KAG Attachment Type



Wide horizontal machining angle range from 0° to 360°.

- Compatible with various tools for BT40 and BT30
- HSK and SK types are customizable

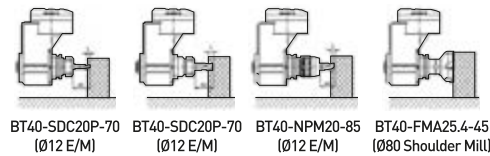

BT40-SDC20P-70 (Ø12 E/M)

BT40-SDC20P-70 (Ø12 E/M)

BT40-NPM20-85 (Ø12 E/M)

BT40-FMA25.4-45 (Ø80 Shoulder Mill)



HRAG Attachment Type (Rigid Reinforced Type)



HRAG that improves the rigidity of the attachment-type bracket by 200%.

- Provides stable operation of the face mill cutter
- Improves the rigidity of the KAG type
- HSK and SK types are customizable.



MAH 0-90° Tilting Type (Rigid Reinforced Type)



MAH that supports mold machining by improving the performance of the current universal-type product.

- Stable machining of large-sized mold
- Supports ball endmill 32mm in diameter (D)
- Improves the rigidity of the KHU type



Corner Rounding Copy Machining Inclined Machining



KAC 45° Angle Type



Due to horizontal rotation by 360°, machining can be conducted at various locations. Tilt angle of 45° fixed.

- HSK and SK types are customizable.

1:1 CHAT



ANGULAR HEAD

Angular Head



Slope Machining



Flank Machining



Inner Side Machining



Free Angle



Features

- Aerospace aluminum body is applied to optimize weight/rigidity (excluding SAH)
- When machining multiple surfaces, the movement of subject is minimized to reduce the setup time.

NAMING

BT50	KHU	10	195
Spindle	Angular Head	Tool Dia.	Length

Name of Each Part

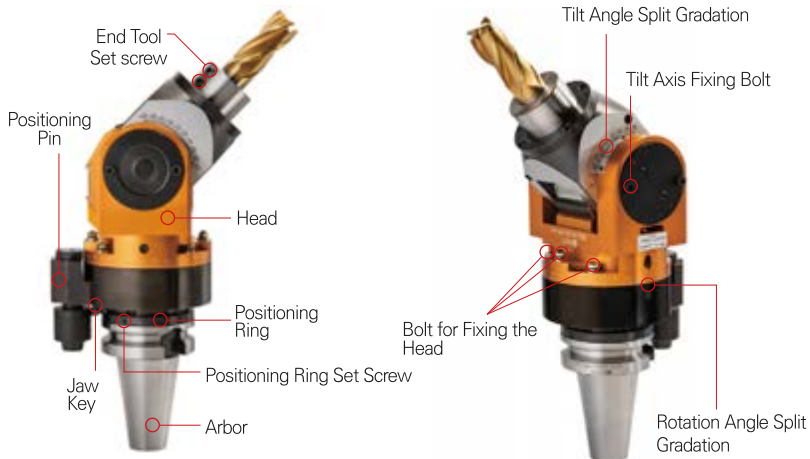

Positioning Pin Structure

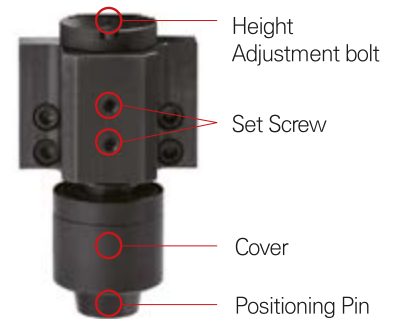

Components



Chuck

Arbor/ Modular

Boring Tool

Angular Head

cBN/PCD

Device&Accessory

Standard



BT-KAH

90° Angle Type



- MAS
403-BT
 - C
 - 3,000
 - ER
 - Milling
 - Drilling
 - Inner Side Machining
- Shank Coolant System Max RPM ER Collet Milling Drilling Inner Side Machining

Features

Adjustable angle-type angular head that enables flexible machining

- Adjusting angle up to 360°
- HSK and SK types are customizable
- ATC (automatic tool change) available
- Tool rotates in the opposite direction to that of spindle.

BT-30 KAH Features

- A small angular head for small equipment (BT30)
- Light weight of 2.6 KG for easy installation
- Available multi-surface processing
- Its processing angle can be freely adjusted by 360° on both sides
- ER11 size collet applied



BT-KAH Structure

- Uses spiral bevel gear (with axial angle of 90°)
- Reduced vibration and noise
- Small backlash
- Thanks to the use of a 1:1 gear ratio, can use without complex calculations
- Reverse-rotation direction compared to spindle (CW:CCW)



Precautions

- Do not inject cutting oil direct to the Angular Head body.

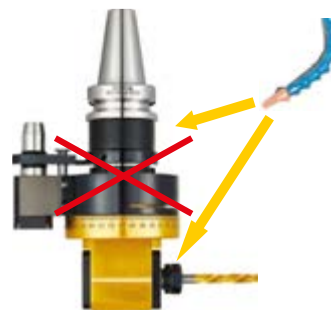

Machining Example

Model : BT50-KAH20-200

Cutting Tool	Workpiece	Depth of Cut(mm)	RPM	Feed(mm/min)	Feed(mm/rev)	BT50-KAH20-200
Ø16-2 Flute Endmill(HSS), Over Length-40mm	S45C	3	700	98	0.14	
	S45C	4	500	60	0.12	
	Al	7	900	72	0.08	
	Al	4	1800	144	0.08	

SPARE PART	Designation	Main Components			Accessories
		Nut	Spanner	Positioning Block	GERC Collet
	KAH7	R11-AH	S-17		GERC11-ØD
	KHU10	R16-AH(M20)	S-25		GERC16-ØD
	KAH13	RU20-AH	35-38		GERC20-ØD
	KHU20	RU32-AH	48-52		GERC32-ØD

1:1 CHAT



BT-KAH

90° Angle Type



MAS 403-BT C 3,000 ER Collet Milling Drilling Inner Side Machining

Shank Coolant System Max RPM ER Collet Milling Drilling Inner Side Machining

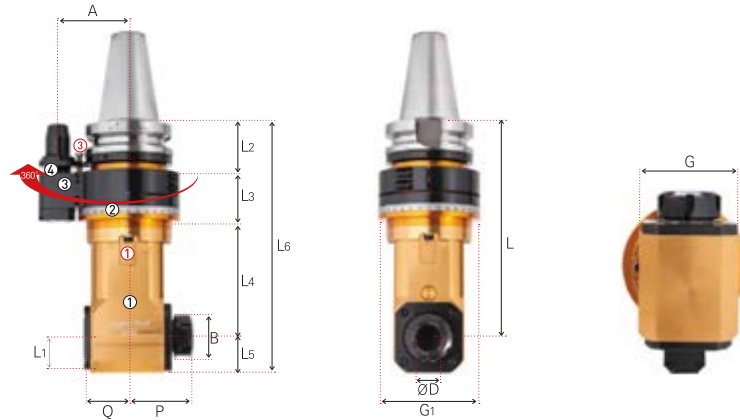

Positioning Pin

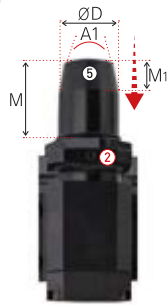

NO	Name
①	Head
②	Rotation Angle Split-gradation (Freely Adjustable for 360°)
③	Position Fix Pin Block
④	Jaw Key
⑤	Height Adjusting Wrench Hole

NO	Name	Designation	Shank
①	Head Angle Fix Bolt	BX0618	BT40, BT50
②	Set Screw	BTF0404	BT40, BT50
③	Position Pin Height Fix Bolt	SBX0630	BT40, BT50

Shank	M(mm)	M1(mm)	A1(deg.)	ØD(mm)
BT30	Max.: 23 / Min.: 17	8	20	15
BT40	Max.: 32 / Min.: 26	10	20	19.6
BT50	Max.: 35 / Min.: 29	15	20	28

● : Stock

C This product does not support the internal coolant system

• For more information on the applicable collet, see **94P**

• For positioning block, see **244P**

	Designation	ØD	L	L1	L2	L3	L4	L5	L6	B	A	P	Q	G	G1	Gear Ratio	Max	Collet	kg	Stock
BT30	BT30-KAH7-120	1.0~7.0	120	20	56	39	25	20	140	19	55	37	24.5	40	72	1:1	5,000	GERC11	2.6	
BT40	BT40-KAH7-170	1.0~7.0	170	20	44	71	55	20	190	19	65	37	24.5	40	96	1:1	5,000	GERC11	5.8	
	BT40-KAH10-195	1.0~10.0	195	25	44	71	80	25	220	28	65	46	32	58	96	1:1	5,000	GERC16	6.2	
	BT40-KAH13-165	1.0~13.0	165	28	44	71	50	28	193	35	65	53	35	60	96	1:1	5,000	GERC20	6.0	
	BT40-KAH20-180	2.0~20.0	180	38	44	71	65	38	218	50	65	71	49	76	96	1:1	3,500	GERC32	7.5	
BT50	BT50-KAH07-220	1.0~7.0	220	20	57	54	109	20	240	19	80	37	24.5	40	96	1:1	3,500	GERC11	10.7	
	BT50-KAH10-215	1.0~10.0	215	25	57	54	104	25	240	28	80	46	32	58	96	1:1	3,500	GERC16	11.0	
	BT50-KAH10-260	1.0~10.0	260	25	57	54	149	25	285	28	80	46	32	58	96	1:1	3,500	GERC16	11.4	
	BT50-KAH13-260	1.0~13.0	260	28	57	54	149	28	288	35	80	53	35	60	96	1:1	3,500	GERC20	12.0	
	BT50-KAH20-200	2.0~20.0	200	38	57	54	89	38	238	50	80	71	49	76	96	1:1	3,500	GERC32	11.6	
	BT50-KAH20-240	2.0~20.0	240	38	57	54	129	38	278	20	80	71	49	76	96	1:1	3,500	GERC32	13.5	

(Unit : mm)

1:1 CHAT



BT-KHU

0-90° Tilting Type



MAS 403-BT
Shank

C Coolant System

6,000 Max RPM

ER Collet

Milling

Drilling

Corner Rounding

Copy Machining

Inclined Machining



KHU Features

Adjustable angle-type angular head that enables flexible machining

- Wide vertical (0°~90°) and horizontal (0°~360°) machining angle range
- HSK and SK types are customizable

Precautions

- Do not inject cutting oil direct to the Angular Head body.

Wear of the ball endmill blade and defective surface roughness of the workpiece can occur, so please slope the edge of the ball endmill when machining

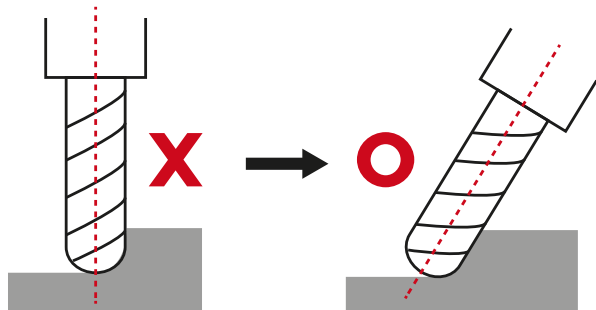

Machining Example

Model : BT50-KHU20-195

Cutting Tool	Workpiece	Depth of Cut(mm)	RPM	Feed(mm/min)	Feed(mm/rev)	Cutting Angle
Ø16-2 Flute Endmill(HSS), Over Length-40mm	S45C	2	600	48	0.08	90°
	AL	3	1200	168	0.14	90°
	S45C	3	600	48	0.08	45°
	AL	5	1200	144	0.12	45°

SPARE PART	Designation	Main Components		Accessories
		Nut	Spanner	GERC Collet
	KHU10	R16-AH	S-25	GERC16-ØD
	KHU20	RU32-AH	48-52	GERC32-ØD

1:1 CHAT



BT-KHU

0-90° Tilting Type

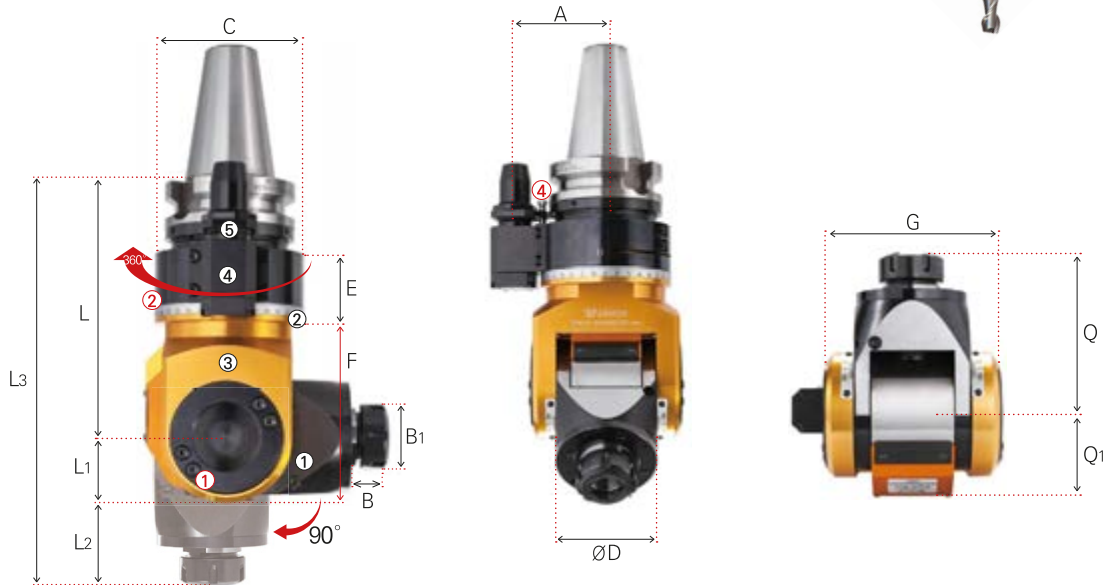

Positioning Pin



NO	Name
①	Tilt Angle Split Gradation (0 - 90°)
②	Rotation Angle Split Gradation (360°)
③	Head
④	Position Fix Pin Block
⑤	Jaw Key
⑥	Height Adjusting Wrench Hole

Shank	M(mm)	M1(mm)	A1(deg.)	ØD(mm)
BT40	Max.: 32 / Min.: 26	10	20	19.6
BT50	Max.: 35 / Min.: 29	15	20	28

NO	Name	Designation	Shank
①	Tilt Axis Fixing Bolt	BH0630	
②	Bracket Angle Fixing Bolt	BX0525	BT40
		BX0412	BT50
③	Set Screw	BTF0404	
④	Fixing Bolt	SBX0630	

● : Stock

C This product does not support the internal coolant system

• For more information on the applicable collet, see **94P**

• For more information on positioning block, see **244P**

	Designation	ØD	B	B1	C	E	F	C2	L	L1	L2	L3	ØD	A	G	Q	Q1	Gear Ratio	Rotation Direction versus Spindle	Max	Collet	kg	Package Weight (kg)	Stock
BT40	BT40-KHU10-160	1.0-10.0	22	28	96	51	98	96	160	33	54	247	58	65	90	87	40	1:2	Normal rotation	6,000	GERC16	8.3	15.2	●
BT50	BT50-KHU10-180	1.0-10.0	22	28	114	53	103	114	180	33	54	267	84	80	90	87	40	1:2	Normal rotation	6,000	GERC16	11.5	23.9	●
	BT50-KHU20-195	2.0-20.0	29	50	114	53	132	114	195	47	73	315	84	80	124	120	63	1:1	Normal rotation	3,000	GERC32	17.9	30.3	●

(Unit : mm)

1:1 CHAT



BT-KAG

Attachment Type

MAS
403-BT

Shank

C

Coolant System

4,000

Max RPM



Milling



Drilling



Face Cutting



Side Cutting

Features of KAG

- Horizontal machining angle range from 0° to 360°
- Compatible with various tools such as BT40 and BT30
- HSK and SK types are customizable
- Coolant types are to be ordered separately



How to Tighten the Tool

1. Insert the tool ① into the angular head spindle.
2. Tightly secure the tool ① using the fixing bolt ②. (BT type)
3. Tighten the tool ① by putting the ring ④ on the bolt ③. (NT type)

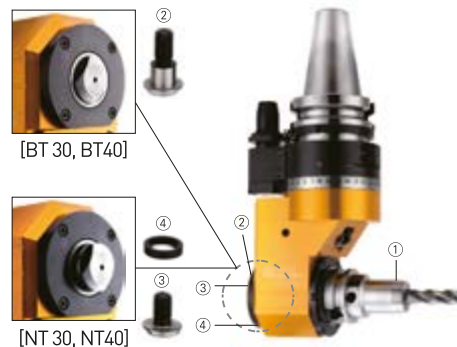

Machining Example

Model : BT50-KAG40-230

Cutting Tool	Workpiece	Depth of Cut(mm)	RPM	Feed(mm/min)	Feed(mm/rev)
BT40-SDC20-60 Ø12-2 Flute Endmill (HSS)	S45C	3	400	72	0.18
	S45C	3	200	36	0.18
NT40-SDC20-60 Ø20-2 Flute Endmill (HSS)	S45C	4	500	50	0.10
	AL	10	1,000	100	0.10
BT40-NPM20-85 Ø20-2 Flute Endmill (HSS) Over Hang 40mm	S45C	3	400	72	0.18
	S45C	3	400	36	0.09
	AL	5	400	72	0.18
	AL	5	480	86	0.18
	AL	10	400	72	0.18
BT40-FMA25.4-45 Ø80 Shoulder Mill (5 Flute-50L)	S45C	2	400	120	0.30
	S45C	1	200	60	0.30
	AL	2	600	150	0.25
	AL	1	600	150	0.25

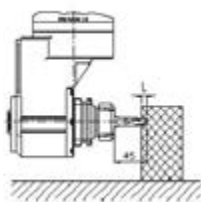
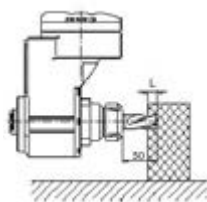
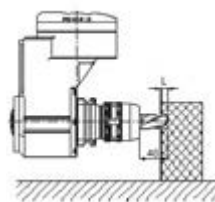
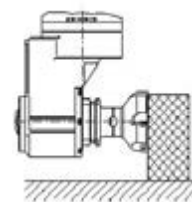
BT40-SDC20-60
(Ø12 E/M)NT40-SDC20-60
(Ø20 E/M)BT40-NPM20-85
(Ø20 E/M)BT40-FMA25.4-45
(Ø80 Shoulder Mill)

1:1 CHAT



BT-KAG

Attachment Type



MAS 403-BT C 4,000 Milling Drilling Face Cutting Side Cutting
 Shank Coolant System Max RPM

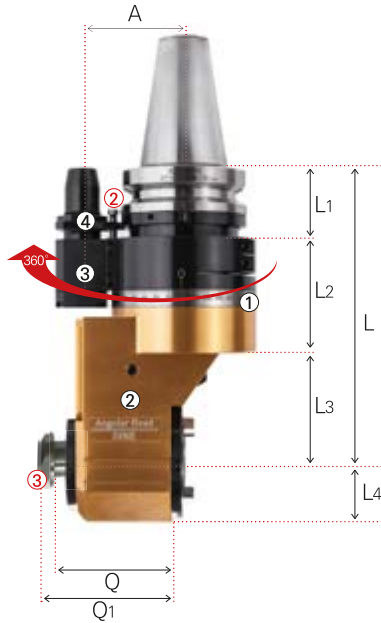

Positioning Pin



NO	Name
①	Rotation Angle Split Gradation (360°)
②	Head
③	Position Fix Pin Block
④	Jaw Key
⑤	Height Adjusting Wrench Hole

NO	Name	Designation
①	Set Screw	BTF0404
②	Fixing Bolt	SBX0630
③	BT / NT Bolt	

Shank	M(mm)	M1(mm)	A1(deg.)	ØD(mm)
BT40	Max.: 32 / Min.: 26	10	20	19.6
BT50	Max.: 35 / Min.: 29	15	20	28

● : Stock

C This product does not support the internal coolant system

• For more information on positioning block, see **244P**

	Designation	L	L1	L2	L3	L4	Q	Q1	A	C	G	Gear Ratio	Rotation Direction versus Spindle	Max	Holder Shank Mounted	kg	Package Weight (kg)	Stock
BT40	BT40-KAG30-195	195	44	86	65	37.5	66	70	65	96	75	1:1	Normal Rotation	4,000	BT/NT30	7.2	14.0	●
BT50	BT50-KAG40-230	230	57	88	85	46.5	89	94	80	114	93	1:1	Normal Rotation	3,000	BT/NT40	15.7	28.1	●

(Unit : mm)

Chuck

Arbor/ Modular

Boring Tool

Angular Head

cBN/PCD

Device&Accessory

Standard

1:1 CHAT



BT-HRAG

Attachment Type (Rigid Reinforced Type)



MAS
403-BT

Shank

C

Coolant System

3,000

Max RPM

Milling

Drilling

Face Cutting

Side Cutting

Features of HRAG

HRAG that improves the rigidity of the attachment-type bracket by 200%

- Provides stable operation of the face mill cutter
- Enhances compatibility with the machining device due to easy bracket disassembly/assembly even on the BT50 shank
- Improves product life cycle

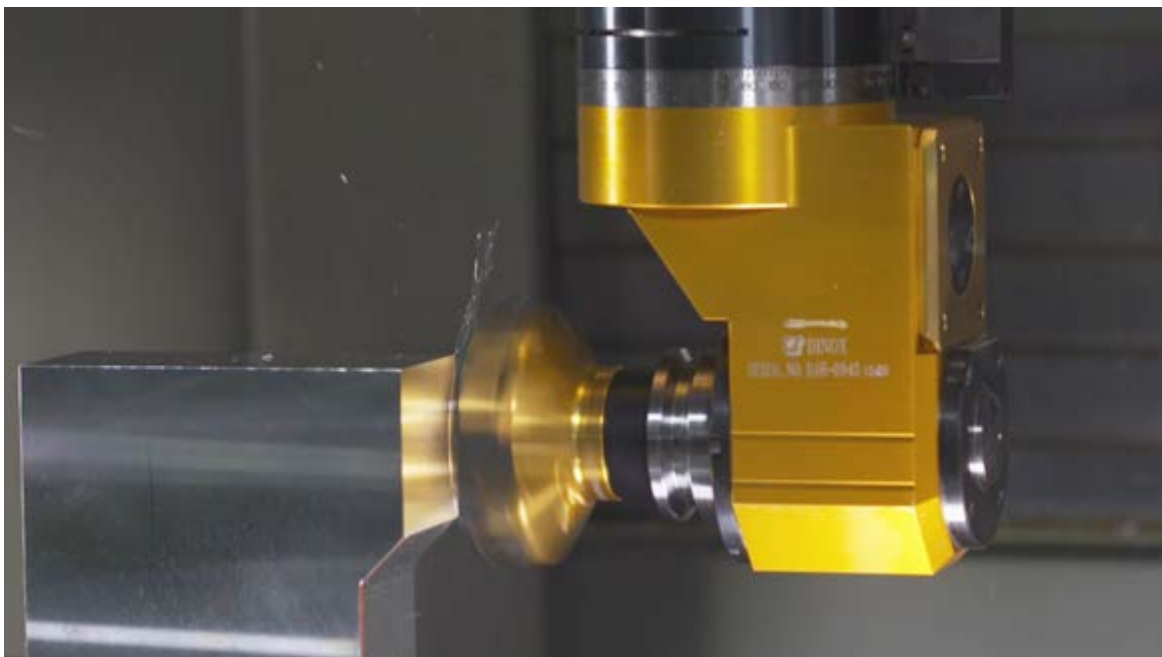

1:1 CHAT



BT-HRAG

Attachment Type (Rigid Reinforced Type)



MAS 403-BT C 3,000 Milling Drilling Face Cutting Side Cutting
 Shank Coolant System Max RPM

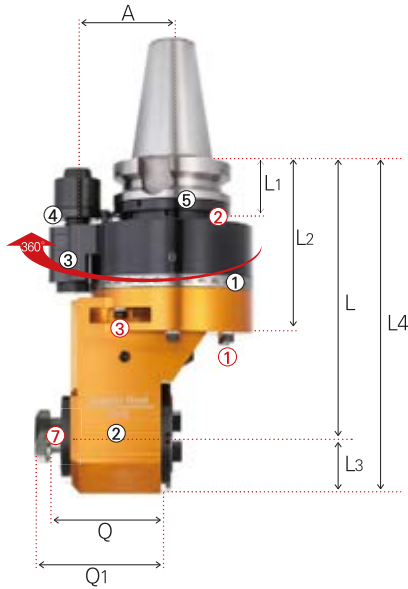

Positioning pin

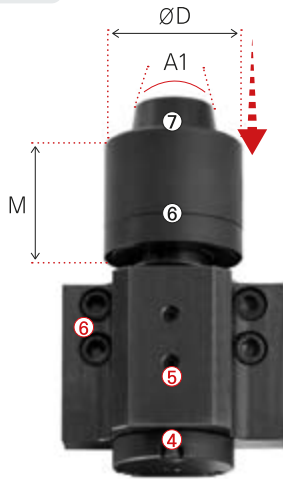

NO	Name
①	Rotation Angle Split Gradation (360°)
②	Head
③	Position Pin Block
④	Jaw Key
⑤	Positioning Ring
⑥	Positioning Cover
⑦	Positioning Pin

NO	Name	Designation
①	Head Angle Fix Bolt	BX0660
②	Positioning Ring Set Screw	MSST5-12
③	Head Angle Fix Bolt	BT0648
④	Positioning Pin Height Adjustment Screw	BT0516
⑤	Positioning Pin Set Screw	BT0512
⑥	Body Position Block Set Screw	BX0620
⑦	BT / NT Bolt	

Shank	M(mm)	A1(deg.)	ØD(mm)
BT50	56.5	20	40

● : Stock

C This product does not support the internal coolant system

• For more information on positioning block, see **244P**

Designation	L	L1	L2	L3	L4	Q	Q1	A	G	G1	Max	Mounting Tool Shank	kg	Stock
BT50 BT50-HRAG40-230	230	56.5	145	47	277	89	101	80	93	136	3,000	BT/NT 40	18.2	●

(Unit : mm)

Chuck

Arbor/ Modular

Boring Tool

Angular Head

cBN/PCD

Device&Accessory

Standard

1:1 CHAT



BT-MAH

0-90° Tilting Type (Rigid Reinforced Type)



MAS
403-BT

Shank

C

Coolant System

3,000

Max RPM

Milling

Drilling

Corner Rounding

Copy Machining

Inclined Machining

Features of Rigidity Reinforced Type

MAH for Mold Machining

MAH ideal for mold machining by improving the performance of conventional universal type products

- Stability on large mold machining
- Tool diameter (D) 32mm ball end mill usable

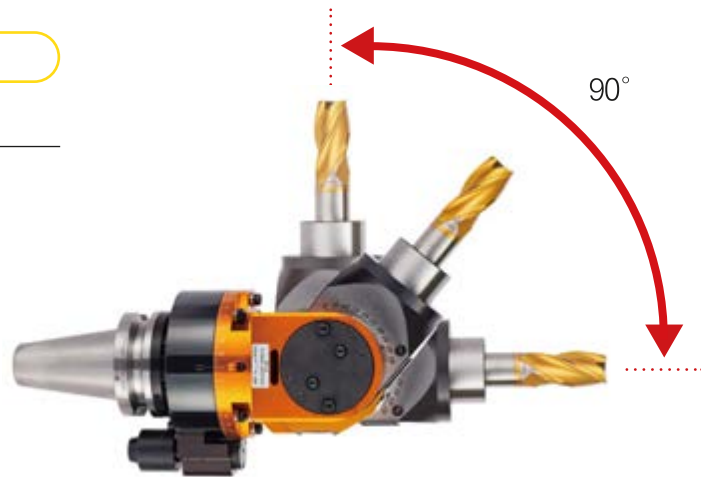

1:1 CHAT



BT-MAH

0-90° Tilting Type (Rigid Reinforced Type)



MAS 403-BT C 3,000 Milling Drilling Corner Rounding Copy Machining Inclined Machining

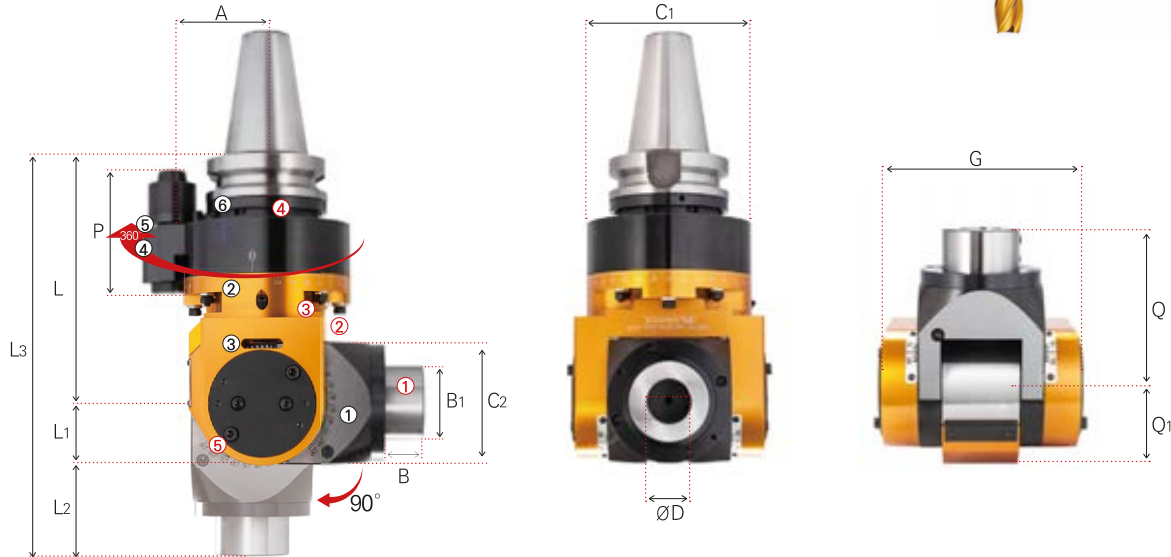

Positioning Pin

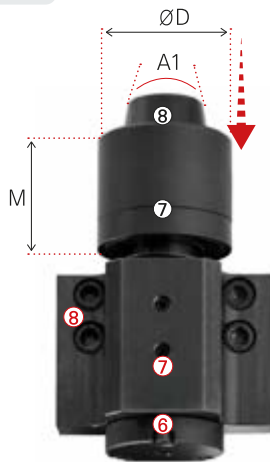

NO	Name
①	Tilt Angle Split Gradation (0 - 90°)
②	Rotation Angle Split Gradation (360° Adjustable)
③	Head
④	Positioning Pin Part
⑤	Jaw Key
⑥	Positioning Ring
⑦	Positioning Cover
⑧	Positioning Pin

NO	Name	Designation
①	Tool Tightening Screw	BT1216
②	Head Fixing Bolt	BT645
③	Head Fixing Bolt	BT640
④	Positioning Ring Set Screw	MSST5-12
⑤	Tilt Axis Fixing Bolt	BH0616
⑥	Positioning Pin Height Adjustment Screw	BT0516
⑦	Positioning Pin Set Screw	BT0512
⑧	Position Block Fixing Bolt	BX0516

Shank	M(mm)	A1(deg.)	ØD(mm)
BT50	56.5	20	40

● : Stock

C This product does not support the internal coolant system

• For more information on positioning block, see **244P**

Designation	ØD	L	L1	L2	L3	C	C1	G	C2	Q	Q1	B	B1	P	A	Max	Tool Mounting	kg	Package Weight (kg)	Stock
BT50 BT50-MAH32-200	32	200	47	78	325	136	95	54	95	125	63	31	60	95	80	3,000	SIDE LOCK	19.6	32.0	●

(Unit : mm)

1:1 CHAT



BT-KAC

45° Angle Type



- MAS
403-BT
- C
- 5,000
- ER Collet
- Slope Machining
- Milling
- Drilling
- Corner Rounding



Features of KAC

Fixed angle type angular head that enables flexible machining

- Adjusting angle up to 360°
- 45-degree fixed type angular head
- For BT40 types, please contact us separately

Precautions

- Do not inject cutting oil direct to the Angular Head body.

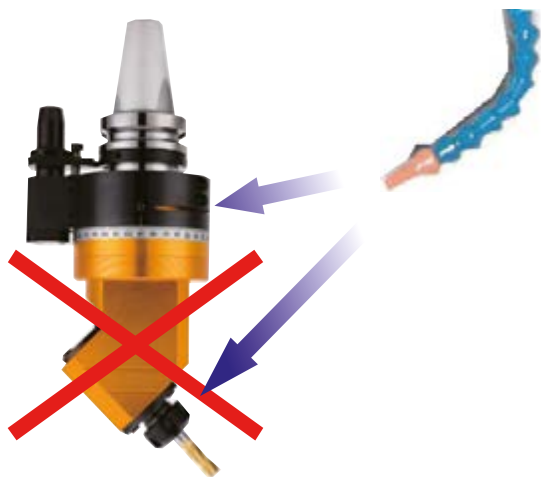

Be sure to give a slope to the cutting edge of a ball end mill when machining it as the ball end mill edge is worn out and the surface roughness of the workpiece becomes defective.

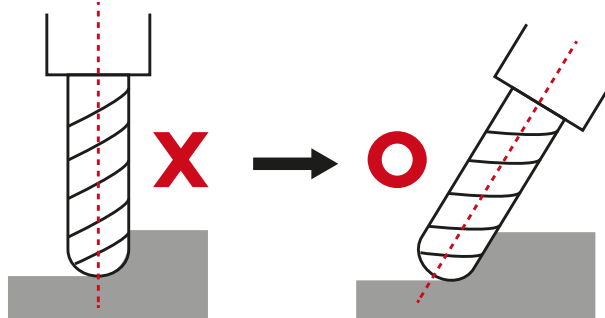

※ To order nuts, please contact us in advance.

SPARE PART	Designation	Main Components		Accessories
		Nut	Spanner	GERC Collet
	KAC10	R16-AH (M20)	S-25	GERC16-ØD
	KAC10	RU20-AH	35-38	GERC20-ØD
	KAC20	RU32-AH	48-52	GERC32-ØD

1:1 CHAT



BT-KAC

45° Angle Type



- MAS 403-BT**
Shank
- C**
Coolant System
- 5,000**
Max RPM
- ER**
ER Collet
- Slope Machining**
- Milling**
- Drilling**
- Corner Rounding**



Positioning Pin

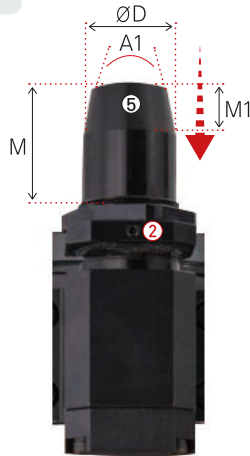

NO	Name
①	Head
②	Rotation Angle Split Gradation (360°)
③	Positioning Pin Part
④	Jaw Key
⑤	Height Adjusting Wrench Hole

NO	Name	Designation	Shank
①	Head Angle Fix Bolt	BX0618	BT40,BT50
②	Set Screw	BTF0404	BT40,BT50
③	Fixing Bolt	SBX0630	BT40,BT50

Shank	M(mm)	M1(mm)	A1(deg.)	ØD(mm)
BT40	Max.: 32 / Min.: 26	10	20	19.6
BT50	Max.: 35 / Min.: 29	15	20	28

● : Stock

C This product does not support the internal coolant system

• For more information on the applicable collet, see **94P**

• For more information on positioning block, see **244P**

Designation	ØD	L	L1	L2	L3	B	G	G1	P	Q	A	Max	Collet	kg	Stock
BT50 BT50-KAC10-240	1.0~10.0	240	57	54	129	28	60	96	25	54	80	5,000	GERC16	9.7	●
BT50-KAC13-240	1.0~13.0	240	57	54	129	28	60	96	25	54	80	5,000	GERC20	10.7	●
BT50-KAC20-250	2.0~20.0	250	57	54	139	50	72	96	30	60	80	3,500	GERC32	11.7	●

(Unit : mm)

1:1 CHAT



BT-SAH

Slim Type



MAS
403-BT

Shank

3,500

Max RPM



Milling



Drilling



Flank Machining



Inner Side Machining



Features

- Angular head for narrow inside machining (min. inner diameter of workpiece : $\varnothing 40$, min. machining width : 32mm)
- MAX 3,500RPM, Spindle : applied rotation ratio = 1:1.37
- Cutting range : $\varnothing 3$, $\varnothing 4$, $\varnothing 6$ mm

NAMING

B50	SAH	6	277
Spindle	Slim Angular Head	Tool Dia.	Length

Machining Features

Min. $\varnothing 40$ mm Hole
(Except Tool Projection)



Min. 32mm Crack
(Except Tool Projection)



Clamping Force

	Measurement	Measured Value (N-m)			
Clamp Torque	2	2.5	3	3.5	4
Clamping Force	Not measurable	5.5	6.5	7	7

※ The moderate clamp torque of collet is 3.5N-m.

Exclusive Collet



● : Stock

Designation	Clamping Range	Stock
SAH6-C3	3	●
SAH6-C4	4	●
SAH6-C6	6	●

How to Clamp



1. Insert the tool with SAH collet
2. Insert the coupled collet into SAH and fix it with a clamping jig
3. Clamping nut using a wrench

1:1 CHAT



BT-SAH

Slim Type



MAS
403-BT

Shank

3,500

Max RPM



Milling



Drilling



Flank Machining



Inner Side Machining

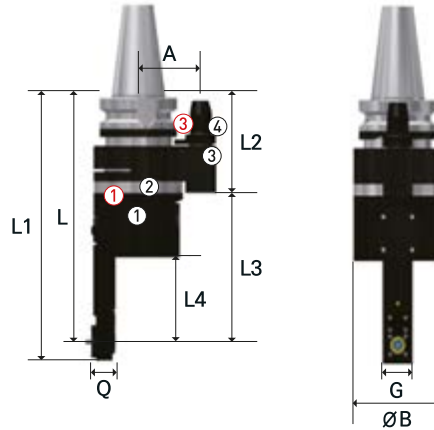

Positioning Pin

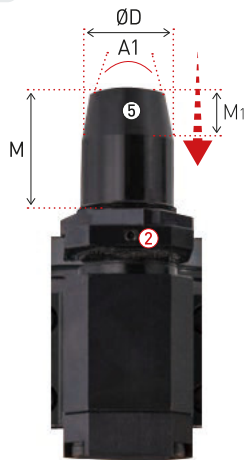

NO	Name
①	Head
②	Rotation Angle Split Gradation (360°)
③	Positioning Pin Part
④	Jaw Key
⑤	Height Adjusting Wrench Hole

NO	Name	Designation	Shank
①	Head Fixing Bolt	BX0618	BT40,BT50
②	Set Screw	BT0404	BT40,BT50
③	Fixing Bolt	BX0630	BT40,BT50

Shank	M(mm)	M1(mm)	A1(deg.)	ØD(mm)
BT50	Max.: 35	15	20	28
	Min.: 29			

● : Stock

• For more information on positioning block, see [244P](#)

Designation	L	L1	L2	L3	L4	A	Q	G	ØB	Rotation Ratio (IN:OUT)	Rotation Direction	Max	Weight (kg)	Stock
BT50-BT50-SAH6-277	277	298	110	167	93.5	80(110)	31.5	40	76	1:1.37	CW:CW	3,500	15.2	●

(Unit : mm)



POSITIONING BLOCK

Positioning Block (For BT40)

How to install the positioning block on the machine

For BT40 Customer Standard Type – Group A (60° Standard Type)

- In case Min. PCD=110mm
- Spindle diameter less than $\varnothing 94$ available
- Keep the minimum distance 55mm between bolts
- In case Max. PCD=135mm
- Spindle diameter less than $\varnothing 112$ available
- Keep the minimum distance 67.5mm between bolts

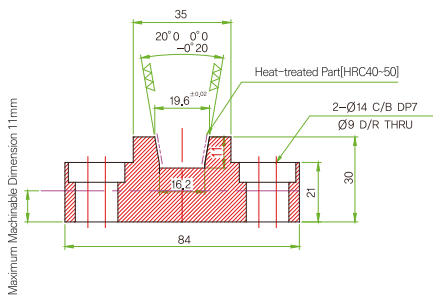
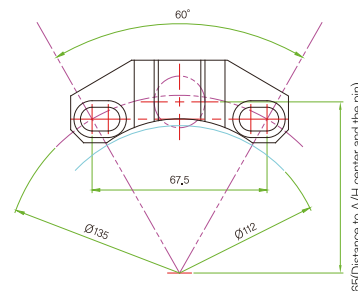
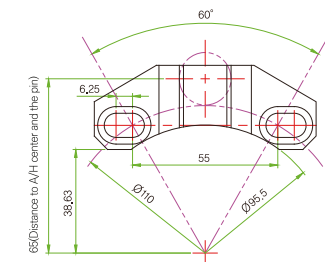

Semi-finishing : Requires Block Height Machining

- The customer must machine the bottom of the block in person to use for use after determining the block height

※ Minimum block height : 19mm (based on the upper side)

- Only the taper part to be heat-treated
- Based on M8 in the case of less than M6, washer supplied

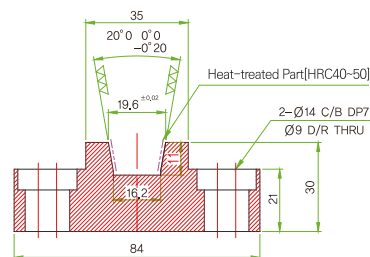
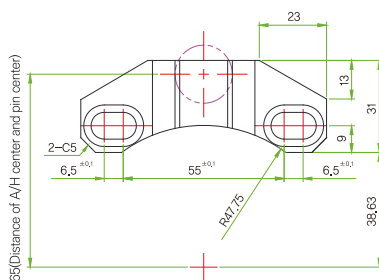

- DINE Inc, provides the positioning block type as default. (Excluding BT30 Angular Head)



POSITIONING BLOCK

Positioning Block (For BT50)

How to install the positioning block on the machine

For BT50 Customer Standard Type – Group A (60° Standard Type)

- In case Min. PCD = 155
- Spindle diameter less than $\varnothing 130$ available
- Keep the minimum distance 77.5mm between bolts

- In case Max. PCD = 235
- Spindle diameter less than $\varnothing 148$ available
- Keep the minimum distance 117.5mm between bolts

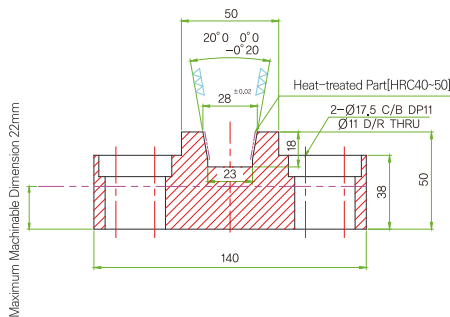
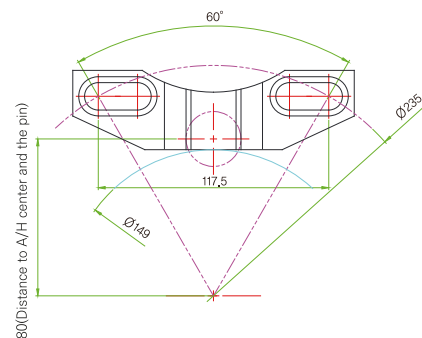
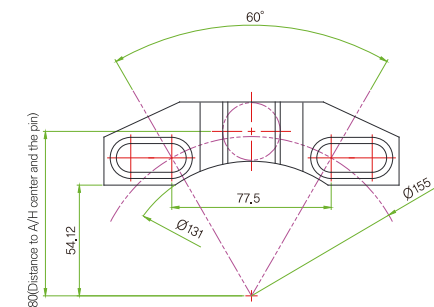

- Semi-finishing : Requires block height machining
- The customer should machine the bottom of the block him/herself for use after determining the block height to prevent interference

※ Minimum block height : 28mm (based on the upper side)

- Only the taper part to be heat-treated
- Based on M10 in the case of less than M8, washer supplied

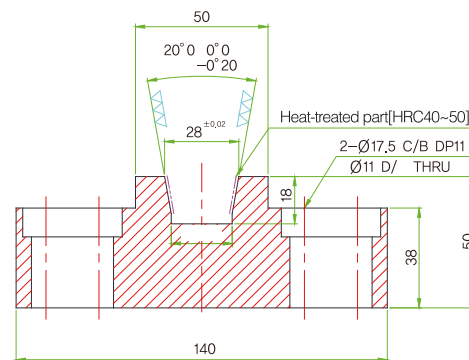
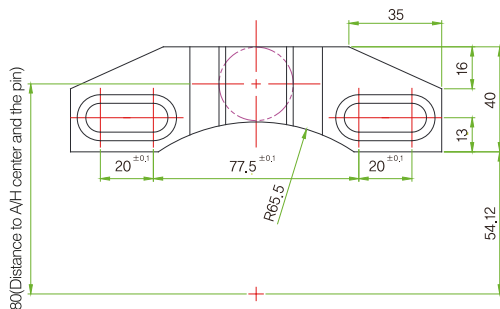

- DINE Inc, provides the positioning block type as default. (Excluding BT30 Angular Head)

1:1 CHAT



ATM NEW

Air Turbine Machine



50,000

Max RPM

5 μ m

Run-out
(Based on spindle)

C

Coolant System

1mm
~6mm

Collet Size

General-2Bar

Air Pressure
(of regulator)

ATC-2.5Bar

Air Pressure
(of regulator)

0.47

Power(HP)

HC

HC Collet



Features

- High-speed turbine rotation structure using compressed air (max. 50,000rpm)
- The conventional MCT can be compatible just by supplying high-pressure compressed air
- High-speed/precision machining is available regardless of the machine's age
- Continuous machining is possible for a long time due to rapid heat discharge

NAMING

B50	ATM	6	228	(ATC)
Spindle	Air Turbine Machine	Tool Dia.	Length	ATC : Auto Tool Change Type NON : General

What is ATM?

The air spindle is able to rotate at a high-speed (50,000 RPM) using compressed air, and realize performance the same as that of a high-speed processor even in a standard (conventional) machining center.

Thermal Deformation Protection

- It prevents an increase in temperature of the spindle using an air blade rotation method
- Prevents the deformation of the Z-axis by thermal deformation of the spindle

Z-axis Change with Rotation Time

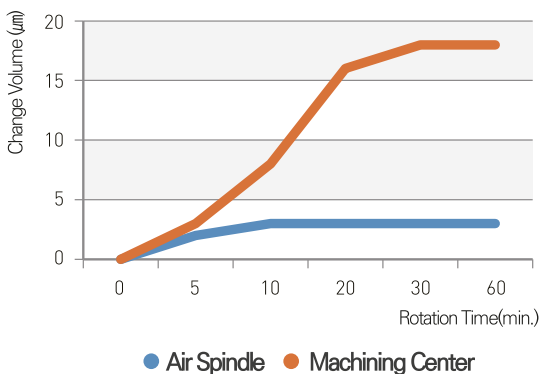

Part Name

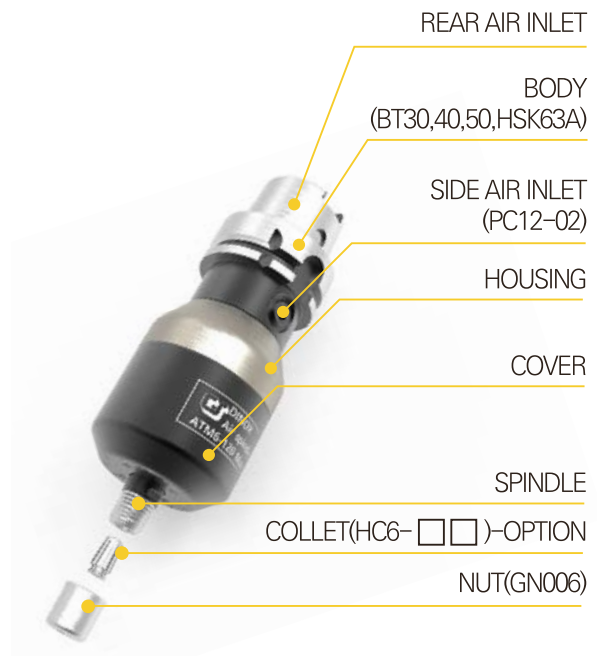

1:1 CHAT



ATM

NEW

Air Turbine Machine



General Type



How to Use

- Use in an equipment able to spray air on the main axis
- Able to perform ATC as there is no external air hose to be connected

Precautions

- When spraying the air on the main axis, be careful about introduction of foreign



How to Use

- Connect an external air hose
- Connect it directly to the regulator and minimize the introduction of foreign substances

Precautions

- Must separate the hose from the product in case of ATC
- Be careful when the main axis rotates

Auto Tool Change Type



How to Use

- It is able to perform ATC and equipment rotation even on equipment with no air main
- The air is supplied on the Positioning Block, so ATC and equipment spindle rotation is possible
- The main axis can rotate at a low-speed, and the tool length can be corrected

Processing Test

Air spindle has a shank and a body in a prefabricated shape, so the shank (BT30, BT40, BT50, HSK63A) can be easily adapted to different types of equipment.

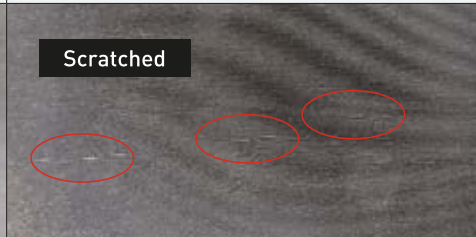
Equipment	Air Spindle (HSK63A-ATM6-170)	Machining Center (Hydraulic Chuck)
Materials	SCM440 (HrC 40)	SCM440 (HrC 40)
RPM	50,000	20,000
Cycle Time	146minutes	276min.
Axial-directional Displacement	5μm	21μm
Surface Roughness		
Note	Improved processing speed and surface roughness	Lowered surface roughness and tool life

Chuck

Arbor/ Modular

Boring Tool

Angular Head

cBN/PCD

Device&Accessory

Standard

1:1 CHAT



BT-ATM

NEW

Air Turbine Machine

50,000

Max RPM

5 μ m

Run-out
(Based on spindle)

C

Coolant System

1mm
~6mm

Collet Size

General-2Bar

Air Pressure
(of regulator)

ATC-2.5Bar

Air Pressure
(of regulator)

0.47

Power(HP)

HC

HC Collet

General Type (Air Spindle)

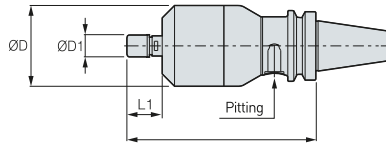

C This product does not support the internal coolant system

- For more information on product features, see **246P**
- For more information on the related parts, see **250P**
- For more information on the applicable collet, see **118P**

	Designation	ØD	ØD1	L	L1	RPM (Based on 2 Bar of Regulator)	Pitting	Stock
BT30	BT30-ATM6-176	72	19.5	176	31.5	MAX 50,000	PC12-02	
BT40	BT40-ATM6-171	72	19.5	171	31.5	MAX 50,000	PC12-02	
BT50	BT50-ATM6-182	72	19.5	182	31.5	MAX 50,000	PC12-02	

(Unit : mm)

ATC Type

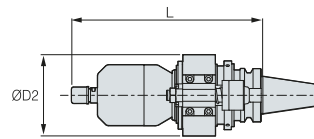
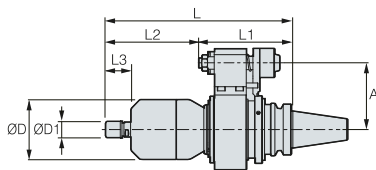

C This product does not support the internal coolant system

- For more information on product features, see **246P**
- For more information on the related parts, see **250P**
- For more information on the applicable collet, see **118P**

	Designation	ØD	ØD1	ØD2	L	L1	L2	L3	A	RPM (Based on 2 Bar of Regulator)	Stock
BT40	BT40-ATM6-227(ATC)	72	19.5	96	227	114	113	32	80	MAX.50,000	
BT50	BT50-ATM6-228(ATC)	72	19.5	96	228	115	113	32	80	MAX.50,000	

(Unit : mm)

1:1 CHAT



HSK-ATM

NEW

Air Turbine Machine

50,000 Max RPM	5μm Run-out (Based on spindle)	C Coolant System	1mm ~6mm Collet Size	General-2Bar Air Pressure (of regulator)	ATC-2.5Bar Air Pressure (of regulator)	0.47 Power(HP)	HC HC Collet
--------------------------	---	----------------------------	------------------------------------	---	---	--------------------------	------------------------

Air Spindle General Type

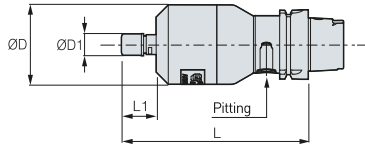

- For more information on product features, see **246P**
- For more information on the related parts, see **250P**
- For more information on the applicable collet, see **118P**

C This product does not support the internal coolant system

HSK63A	Designation	ØD	ØD1	L	L1	RPM (Based on 2 Bar of Regulator)	Pitting	Stock
	HSK63A-ATM6-170	72	19.5	170	31.5	MAX 50,000	PC12-02	

(Unit : mm)

Air Spindle ATC Type

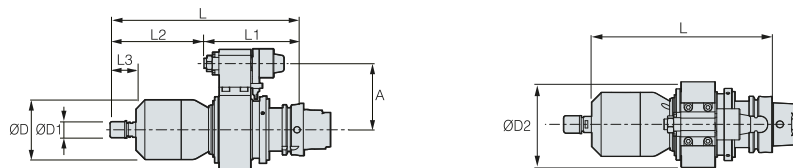

- For more information on product features, see **246P**
- For more information on the related parts, see **250P**
- For more information on the applicable collet, see **118P**

C This product does not support the internal coolant system

HSK63A	Designation	ØD	ØD1	ØD2	L	L1	L2	L3	A	RPM (Based on 2 Bar of Regulator)	Stock
	HSK63A-ATM6-235(ATC)	72	19.5	96	235	122	113	32	80	Max.50,000	

(Unit : mm)



ATU NEW

Angle Adjustment Air Spindle_(Universal Type)



- 50,000
Max RPM
- 5 μ m
Run-out
(Based on spindle)
- C
Coolant System
- 1mm
~6mm
Collet Size
- 3Bar
Air Pressure
(of regulator)
- 0.47
Power(HP)
- HC
Collet

Features

- Air spindle applicable to multi-axis machining by adjusting the angle
- Air injection method can be selected (positioning pin or equipment main axis)
- ATC device available

NAMING

B50	ATU	6	155
Spindle	Air Turbine Universal	Tool Dia.	Length

Product Structure and Characteristics

1) Angle Control

- 1-1) Tilt Angle: $-90^{\circ} \sim +90^{\circ}$
- 1-2) Rotation Angle: $0^{\circ} \sim 360^{\circ}$



2) Air Injection Method

- 2-1) External air method
- 2-2) Equipment main axis method

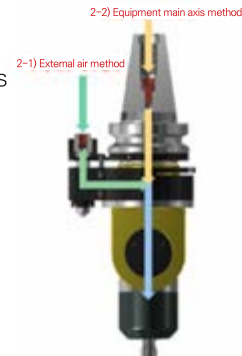

Designation	L	L1	L2	L3	L4	L5	L6	L7
BT50-ATU6-155	155	45	200	55	90	48	35	97

E	F	P	A	B	G	ØB1	ØG1	ØD	MAX.	Proper Air Pressure
46.5	53.5	131.5	80	30.5	116	19.5	114	90	50,000	Around 3 bar

1. When using it, never rotate the main axis.
2. Proper air pressure is based on the Max. RPM and a maximum of 50,000 RPM are available for both external air and main spindle method at approximately 3 bar of pressure.
3. ATC available.
4. When using the ATC, a positioning block is required.
※ Positioning block is customizable.

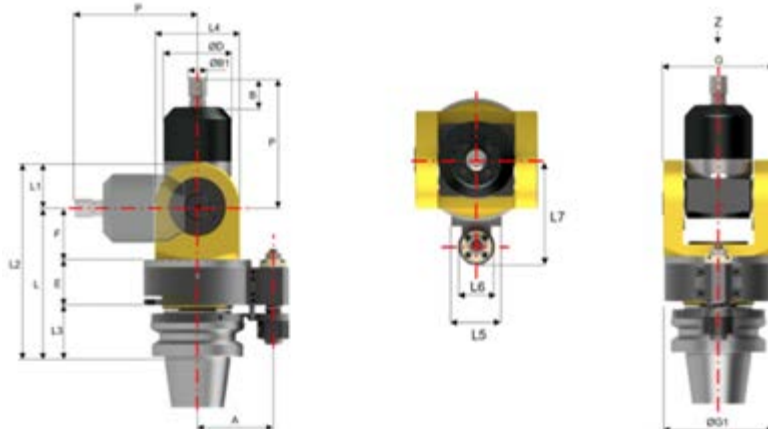

1:1 CHAT



ATM(U) SPARE PART

Air Spindle Related Parts

Spare Part



[ATM]



[ATU]



SPARE PART

Main Components

Images					
Components	Air Spindle	Air Regulator	PC12-03	Spanner	Nut
Quantity	1	1	2	1	1

Item	Air Spindle					
	ATM(U)6 (BT30, 40, 50, HSK63A)				ATM	ATU
	No	Classification	Name	Designation	Quantity	Quantity
Components	1	Basic Specifications	ATM(U)6	□□□-ATM(U)6-□□□	1	1
	2		Nut	GN-06	1	1
	3		Regulator	TPC PP3-03BG	1	1
	4		Fitting	PC12-02	1	-
	5			PC12-03	2	2
	6		Spanner	GSK6-SPANNER	1	1
	7			S16 SPANNER	1	1
	8			S17 SPANNER	-	1
	9		Wrench	LW-1.5	-	1
	10			LW-2.5	-	1
	11			LW-3.0	-	1
	12			LW-6.0	-	1

Accessories

Designation	Image	Out Dia.	L	Max. Tool Dia.	Distance	Positioning Block
HC6ØD(P)		10.5	25	6	1	



cBN/PCD

DINE TOTAL TOOLING SOLUTION

How to Indicate the Model	
No. of Insert (ISO)	254
cBN Spec	256
PCD Spec	260
cBN Features	262
cBN Heat-treated Steel	266
cBN Cast Iron	272
cBN Sintered Alloy	274
DNC100	276
DNC250	277
DNC300	278
DNC350	279
DB1000	280
DB2000	281
DB7000	282
DB7500	283
cBN Chip Breaker (RA, GA)	284
cBN Technical Data	285
cBN Edge Treatment	289
cBN Re-grinding	293
PCD Chip Breaker (UC)	294
PCD Technical Data	295



How to indicate the model No. of insert(ISO)

C

N

G

M

1

2

3

4

Insert Shape

Major Clearance Angle

Tolerance

Cross-sectional Shape

1 Insert Shape

C **N** **G** **M** 12 04 08 - GA

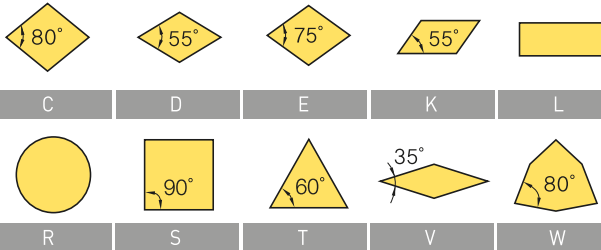

2 Major Clearance Angle

C **N** **G** **M** 12 04 08 - GA

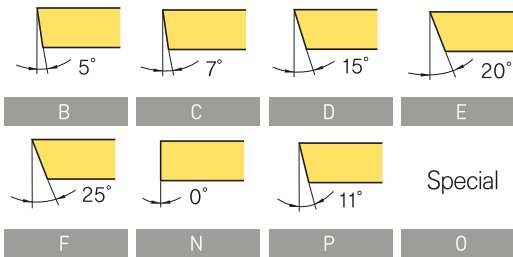

3 Tolerance

C **N** **G** **M** 12 04 08 - GA

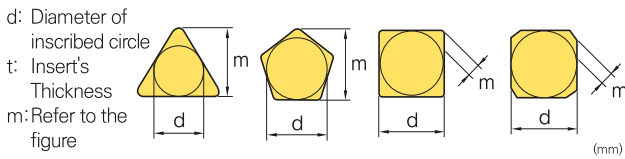

Class	d	m	t
A	±0.025	±0.005	±0.025
C	±0.025	±0.013	±0.025
H	±0.013	±0.013	±0.025
E	±0.025	±0.025	±0.025
G	±0.025	±0.025	±0.13
J*	±0.05 ~ ±0.15	±0.005	±0.025
K*	±0.05 ~ ±0.15	±0.013	±0.025
L*	±0.05 ~ ±0.15	±0.025	±0.025
M*	±0.05 ~ ±0.15	±0.08 ~ ±0.20	±0.13
N*	±0.05 ~ ±0.15	±0.08 ~ ±0.18	±0.025
U*	±0.08 ~ ±0.25	±0.13 ~ ±0.38	±0.13

* Side is the one of the sintered parts

Tolerance Definition of C, H, R, T, and W Types of Inscribed Circle (Exceptions)

d	Tolerance of d		Tolerance of m	
	J, K, L, M, N	U	M, N	U
6.35	±0.05	±0.08	±0.08	±0.13
9.525	±0.05	±0.08	±0.08	±0.13
12.7	±0.08	±0.13	±0.13	±0.20
15.875	±0.10	±0.18	±0.15	±0.27
19.05	±0.10	±0.18	±0.15	±0.27
25.4	±0.13	±0.25	±0.18	±0.38

Tolerance Definition of D-type Inscribed Circle (Exceptions)

d	Tolerance of d	Tolerance of m
6.35	±0.05	±0.11
9.525	±0.05	±0.11
12.7	±0.08	±0.15
15.875	±0.10	±0.18
19.05	±0.10	±0.18

4 Cross-sectional Shape

C **N** **G** **M** 12 04 08 - GA

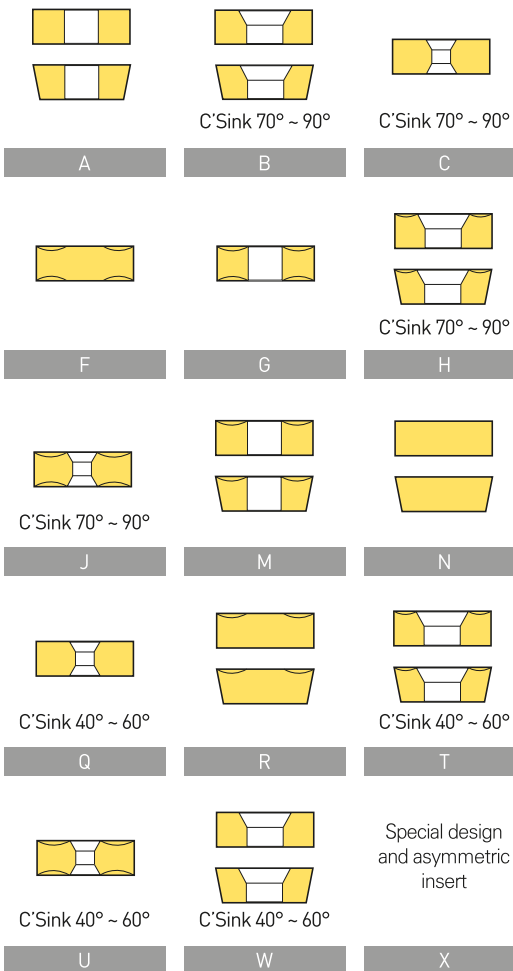



How to indicate the model No. of insert(ISO)

12

04

08

GA

5

6

7

8

Inscribed Circle Diameter

Cutting Edge Height

Nose "r" Size

Chip Breaker

5

Inscribed Circle Diameter

C N G M **12** 04 08 - GA

() small symbol

Symbols							Inch	IC
C	d	S	T	R	V	W		
3	4	3	6	3	-	2	1.2(5)	3.97
4	5	4	8	4	8	S3	1.5(6)	4.76
5	6	5	9	5	9	3	1.8(7)	5.56
-	-	-	-	6	-	-	-	6.00
6	7	6	11	6	11	4	2	6.35
8	9	7	13	7	13	5	2.5	7.94
-	-	-	-	8	-	-	-	8.00
9	11	9	16	9	16	6	3	9.53
-	-	-	-	10	-	-	-	10.00
11	13	11	19	11	19	7	3.5	11.11
-	-	-	-	12	-	-	-	12.00
12	15	12	22	12	22	8	4	12.70
14	17	14	24	14	24	9	4.5	14.29
16	19	15	27	15	27	10	5	15.88
-	-	-	-	16	-	-	-	16.00
17	21	17	30	17	30	11	5.5	17.46
19	23	19	33	19	33	13	6	19.05
-	-	-	-	20	-	-	-	20.00
22	27	22	38	22	38	15	7	22.23
-	-	-	-	25	-	-	-	25.00
25	31	25	44	25	44	17	8	25.40
32	38	31	54	31	54	21	10	31.75
-	-	-	-	32	-	-	-	32.00

6

Cutting Edge Height

C N G M 12 **04** 08 - GA

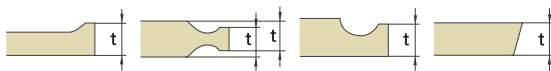

Symbol		Nose "r"	
Metric	Inch	M, N	Inch
1	1(2)	1.59	1/16
T0	1.125	1.79	9/128
T1	1.2	1.98	5/64
2	1.5(3)	2.38	3/32
T2	1.75	2.78	7/64
3	2	3.18	1/8
T3	2.5	3.97	5/32
4	3	4.76	3/16
5	3.5	5.56	7/32
6	4	6.35	1/4
7	5	7.94	5/16
9	6	9.52	3/8
11	7	11.11	7/16
12	8	12.70	1/2

() small symbol

7

Nose "r" Size

C N G M 12 04 **08** - GA



Symbol		Nose "r"	
Metric	Inch	M, N	Inch
1	0	0.1	0.004
2	0.5	0.2	0.008
4	1	0.4	1/64
8	2	0.8	1/32
12	3	1.2	3/64
16	4	1.6	January 16th
20	5	2	5/64
24	6	2.4	3/32
28	7	2.8	7/64
32	8	3.2	1/8
00	-	Circular Insert (Inch Type)	
M0	-	Circular Insert (Metric Type)	

8

Chip Breaker

C N G M 12 04 08 - **GA**

cBN	Roughing	Finishing	PCD
			General-purpose
	RA	GA	UC

1:1 CHAT



cBN Spec

cBN Multi-corner Type (Negative/Positive)

※T-2NU-□□□□△△△△△△ designation package unit is 10EA.

● : Stock

Drawing	Designation	Grade										W (Weight)	mm					
		DNC100	DNC250	DNC300	DNC350	DNC400	DB1000	DB2000	DBN250	DBN350	DBN700A		DBNX20	S (Cutting Edge Length)	IC (Inscribed Circle)	T (Thickness)	r (Nose)	ØD (Hole Diameter)
	2NU-CNGA120404	●	●	●	●	-	●	-	-	-	●	-	9.9	2.7	12.7	4.76	0.4	5.16
	2NU-CNGA120404F	-	●	-	●	-	-	-	-	-	-	-	9.9	2.7	12.7	4.76	0.4	5.16
	2NU-CNGA120404T	-	●	-	●	-	●	-	-	-	-	-	9.9	2.7	12.7	4.76	0.4	5.16
	2NU-CNGA120404W	-	●	-	-	-	-	-	-	-	-	-	9.9	2.7	12.7	4.76	0.4	5.16
	2NU-CNGA120404WF	-	●	-	-	-	-	-	-	-	-	-	9.9	2.7	12.7	4.76	0.4	5.16
	2NU-CNGA120408	●	●	●	●	-	●	●	-	-	●	-	9.9	2.6	12.7	4.76	0.8	5.16
	2NU-CNGA120408F	-	●	-	●	-	-	-	-	-	-	-	9.9	2.6	12.7	4.76	0.8	5.16
	2NU-CNGA120408T	-	●	-	●	-	●	-	-	-	-	-	9.9	2.6	12.7	4.76	0.8	5.16
	2NU-CNGA120408W	-	●	-	●	-	●	-	-	-	●	-	9.9	2.6	12.7	4.76	0.8	5.16
	2NU-CNGA120408WF	-	-	-	-	-	-	-	●	-	-	-	9.9	2.6	12.7	4.76	0.8	5.16
	2NU-CNGA120412	●	●	●	●	-	-	-	-	-	-	-	9.9	2.6	12.7	4.76	1.2	5.16
	2NU-CNGA120412F	-	●	-	●	-	-	-	-	-	-	-	9.9	2.6	12.7	4.76	1.2	5.16
	2NU-CNGA120412T	-	●	-	●	-	-	-	-	-	-	-	9.9	2.6	12.7	4.76	1.2	5.16
	2NU-CNGA120412W	-	●	-	-	-	-	-	-	-	●	-	9.9	2.6	12.7	4.76	1.2	5.16
	2NU-CNGA120412WT	-	-	-	-	-	●	-	-	-	-	-	9.9	2.6	12.7	4.76	1.2	5.16
	T-2NU-CNGA120404	-	●	-	-	-	-	-	-	-	-	-	9.9	2.7	12.7	4.76	0.4	5.16
T-2NU-CNGA120408	-	●	-	●	-	-	-	-	-	-	-	9.9	2.6	12.7	4.76	0.8	5.16	
	4NU-CNGA120404	-	●	-	-	-	-	-	-	-	-	9.9	2.7	12.7	4.76	0.4	5.16	
	4NU-CNGA120408	-	●	-	●	-	-	-	-	-	-	9.9	2.6	12.7	4.76	0.8	5.16	
	4NU-CNGA120412	-	●	-	-	-	-	-	-	-	-	9.9	2.6	12.7	4.76	1.2	5.16	
	2NU-DNGA150404	-	●	●	●	-	-	●	●	-	-	12.3	2.6	12.7	4.76	0.4	5.16	
	2NU-DNGA150404F	-	●	-	●	-	-	-	-	-	-	12.3	2.6	12.7	4.76	0.4	5.16	
	2NU-DNGA150404T	-	●	-	●	-	-	-	-	-	-	12.3	2.6	12.7	4.76	0.4	5.16	
	2NU-DNGA150408	-	●	●	●	-	●	●	-	-	-	12.3	2.2	12.7	4.76	0.8	5.16	
	2NU-DNGA150408F	-	●	-	●	-	-	-	-	-	-	12.3	2.2	12.7	4.76	0.8	5.16	
	2NU-DNGA150408T	-	●	-	●	-	-	-	-	-	-	12.3	2.2	12.7	4.76	0.8	5.16	
	2NU-DNGA150412	-	●	-	●	-	●	●	-	-	-	12.3	2.5	12.7	4.76	1.2	5.16	
	2NU-DNGA150412F	-	●	-	●	-	-	-	-	-	-	12.3	2.5	12.7	4.76	1.2	5.16	
	2NU-DNGA150412T	-	●	-	●	-	-	-	-	-	-	12.3	2.5	12.7	4.76	1.2	5.16	
	2NU-DNGA150604	●	●	-	●	-	-	-	-	-	-	15.4	2.5	12.7	6.35	0.4	5.16	
2NU-DNGA150608	●	●	-	●	-	-	-	-	-	-	15.4	2.5	12.7	6.35	0.8	5.16		
	4NU-DNGA150404	-	●	-	●	-	-	-	-	-	-	12.3	1.8	12.7	4.76	0.4	5.16	
	4NU-DNGA150408	-	●	-	●	-	-	-	-	-	-	12.3	2.9	12.7	4.76	0.8	5.16	
	4NU-DNGA150412	-	●	-	●	-	-	-	-	-	-	12.3	3	12.7	4.76	1.2	5.16	
	4NU-DNGA150608	-	●	-	-	-	-	-	-	-	-	15.4	2.9	12.7	6.35	0.8	5.16	
	4NU-SNGA120404	-	●	-	-	-	-	-	-	-	-	9.9	3.1	12.7	4.76	0.4	5.16	
	4NU-SNGA120408	-	●	-	-	-	-	-	-	●	-	9.9	3.1	12.7	4.76	0.8	5.16	
	3NU-TNGA160404	-	●	-	●	-	●	●	-	●	-	7.2	2.5	9.53	4.76	0.4	3.81	
	3NU-TNGA160404T	-	●	-	-	-	-	-	-	-	-	7.2	2.5	9.53	4.76	0.4	3.81	
	3NU-TNGA160408	-	●	-	●	-	-	-	-	●	-	7.2	2.3	9.53	4.76	0.8	3.81	
	3NU-TNGA160408F	-	●	-	-	-	-	-	-	-	-	7.2	2.3	9.53	4.76	0.8	3.81	
	3NU-TNGA160408T	-	●	-	-	-	-	-	-	-	-	7.2	2.3	9.53	4.76	0.8	3.81	
	3NU-TNGA160412	-	-	-	●	-	-	-	-	-	-	7.2	2.0	9.53	4.76	1.2	3.81	

1:1 CHAT



cBN Spec

cBN Multi-corner Type (Negative/Positive)

※ T-2NU-□□□□△△△△△△△△ designation packaging unit is 10EA.

● : Stock

Drawing	Designation	Grade										W (Weight)	mm				
		DNC100	DNC250	DNC300	DNC350	DNC400	DB1000	DB2000	DBN250	DBN350	DBN700A		DBNX20	S (Cutting Edge Length)	IC (Inscribed Circle)	T (Thickness)	r (Nose)
	2NU-VNGA160404					-	-	-	-	-	-	10.2	3.5	9.53	4.76	0.4	3.81
	2NU-VNGA160404F	-	-	-	-	-	-	-	-	-	-	10.2	3.5	9.53	4.76	0.4	3.81
	2NU-VNGA160404T	-	-	-	-	-	-	-	-	-	-	10.2	3.5	9.53	4.76	0.4	3.81
	2NU-VNGA160408	-	-	-	-	-	-	-	-	-	-	10.2	2.6	9.53	4.76	0.8	3.81
	2NU-VNGA160408F	-	-	-	-	-	-	-	-	-	-	10.2	2.6	9.53	4.76	0.8	3.81
	2NU-VNGA160408T	-	-	-	-	-	-	-	-	-	-	10.2	2.6	9.53	4.76	0.8	3.81
	T-2NU-VNGA160408	-	-	-	-	-	-	-	-	-	-	10.2	2.6	9.53	4.76	0.8	3.81
	2NU-CCGW060202	-	-	-	-	-	-	-	-	-	-	0.9	2.8	6.35	2.38	0.2	2.8
	2NU-CCGW060202T	-	-	-	-	-	-	-	-	-	-	0.9	2.8	6.35	2.38	0.2	2.8
	2NU-CCGW060204	-	-	-	-	-	-	-	-	-	-	0.9	2.7	6.35	2.38	0.4	2.8
	2NU-CCGW060204F	-	-	-	-	-	-	-	-	-	-	0.9	2.7	6.35	2.38	0.4	2.8
	2NU-CCGW060204T	-	-	-	-	-	-	-	-	-	-	0.9	2.7	6.35	2.38	0.4	2.8
	2NU-CCGW060208	-	-	-	-	-	-	-	-	-	-	0.9	2.6	6.35	2.38	0.8	2.8
	2NU-CCGW09T302	-	-	-	-	-	-	-	-	-	-	4.6	2.7	6.35	2.38	0.2	4.4
	2NU-CCGW09T304	-	-	-	-	-	-	-	-	-	-	4.6	2.7	9.53	3.97	0.4	4.4
	2NU-CCGW09T304T	-	-	-	-	-	-	-	-	-	-	4.6	2.7	9.53	3.97	0.4	4.4
	2NU-CCGW09T308	-	-	-	-	-	-	-	-	-	-	4.6	2.6	9.53	3.97	0.8	4.4
	2NU-CCGW09T308T	-	-	-	-	-	-	-	-	-	-	4.6	2.6	9.53	3.97	0.8	4.4
	2NU-CCGW09T308W	-	-	-	-	-	-	-	-	-	-	4.6	2.6	9.53	3.97	0.8	4.4
	2NU-DCGW070204	-	-	-	-	-	-	-	-	-	-	1.3	2.6	6.35	2.38	0.4	2.8
	2NU-DCGW070208	-	-	-	-	-	-	-	-	-	-	1.3	2.2	6.35	2.38	0.8	2.8
	2NU-DCGW070208T	-	-	-	-	-	-	-	-	-	-	1.3	2.2	6.35	2.38	0.8	2.8
	2NU-DCGW11T302	-	-	-	-	-	-	-	-	-	-	4.8	2.6	9.53	3.97	0.2	4.4
	2NU-DCGW11T304	-	-	-	-	-	-	-	-	-	-	4.8	2.6	9.53	3.97	0.4	4.4
	2NU-DCGW11T304F	-	-	-	-	-	-	-	-	-	-	4.8	2.6	9.53	3.97	0.8	4.4
	2NU-DCGW11T304T	-	-	-	-	-	-	-	-	-	-	4.8	2.6	9.53	3.97	0.4	4.4
	2NU-DCGW11T308	-	-	-	-	-	-	-	-	-	-	4.8	2.2	9.53	3.97	0.8	4.4
	2NU-DCGW11T308T	-	-	-	-	-	-	-	-	-	-	4.8	2.2	9.53	3.97	0.8	4.4
	T-2NU-DCGW11T304	-	-	-	-	-	-	-	-	-	-	4.8	2.6	9.53	3.97	0.4	4.4
	T-2NU-DCGW11T308	-	-	-	-	-	-	-	-	-	-	-	-	-	-	-	-
	3NU-TCGW090204	-	-	-	-	-	-	-	-	-	-	0.9	2.5	5.56	2.38	0.4	2.5
	3NU-TCGW090204F	-	-	-	-	-	-	-	-	-	-	0.9	2.5	5.56	2.38	0.4	2.5
	3NU-TCGW090204T	-	-	-	-	-	-	-	-	-	-	0.9	2.5	5.56	2.38	0.4	2.5
	3NU-TPGW110304	-	-	-	-	-	-	-	-	-	-	2.3	2.5	6.35	3.18	0.4	3.4
	3NU-TPGW110304F	-	-	-	-	-	-	-	-	-	-	2.3	2.5	6.35	3.18	0.4	3.4
	3NU-TPGW110304T	-	-	-	-	-	-	-	-	-	-	2.3	2.5	6.35	3.18	0.4	3.4
	3NU-TPGW110308	-	-	-	-	-	-	-	-	-	-	2.3	2.5	6.35	3.18	0.4	3.4
	3NU-TPGW110308F	-	-	-	-	-	-	-	-	-	-	2.3	2.5	6.35	3.18	0.4	3.4
	3NU-TPGW110308T	-	-	-	-	-	-	-	-	-	-	2.3	2.5	6.35	3.18	0.4	3.4
	3NU-TPGN160308	-	-	-	-	-	-	-	-	-	-	2.3	2.3	6.35	3.18	0.8	-
	3NU-TPGN160304	-	-	-	-	-	-	-	-	-	-	4.8	2.5	9.53	3.18	0.4	-
	3NU-TPGN160308	-	-	-	-	-	-	-	-	-	-	4.8	2.3	9.53	3.18	0.8	-
		-	-	-	-	-	-	-	-	-	-	-	-	-	-	-	-



cBN Spec

cBN Multi-corner Type (Negative/Positive)

● : Stock

※ T-2NU-□□□□△△△△△△△△△△ designation packaging unit is 10 EA.

○ : To be discontinued after inventory depletion

Drawing	Designation	Grade										W (Weight)	mm				
		DNC100	DNC250	DNC300	DNC350	DNC400	DB1000	DB2000	DBN250	DBN350	DBN700A		DBNX20	S (Cutting Edge Length)	IC (Inscribed Circle)	T (Thickness)	r (Nose)
	3NU-TPGB110304	-	-	-	-	-	-	-	-	-	-	2.0	2.5	6.35	3.18	0.4	3.4
	3NU-TPGB110308F	-	○	-	-	-	-	-	-	-	-	2.0	2.3	6.35	3.18	0.8	3.4
	3NU-TPGB110308T	-	○	-	-	-	-	-	-	-	-	2.0	2.3	6.35	3.18	0.8	3.4
	2NU-VBGW160402	-	●	-	-	-	-	-	-	-	-	8.6	3.5	9.53	4.76	0.2	4.4
	2NU-VBGW160404	●	●	-	●	-	●	-	●	-	-	8.6	3.5	9.53	4.76	0.4	4.4
	2NU-VBGW160404F	-	●	-	-	-	-	-	-	-	-	8.6	3.5	9.53	4.76	0.4	4.4
	2NU-VBGW160404T	-	●	-	-	-	-	-	-	-	-	8.6	3.5	9.53	4.76	0.4	4.4
	2NU-VBGW160408	●	●	-	●	-	-	●	●	-	-	8.6	2.6	9.53	4.76	0.8	4.4
	2NU-VBGW160408F	-	●	-	-	-	-	-	-	-	-	8.6	2.6	9.53	4.76	0.8	4.4
	2NU-VBGW160408T	-	●	-	-	-	-	-	-	-	-	8.6	2.6	9.53	4.76	0.8	4.4
T-2NU-VBGW160408	-	-	-	-	-	-	-	-	-	-	8.6	2.6	9.53	4.76	0.8	4.4	
	2NU-VCGW160404	-	●	-	●	-	-	-	-	-	-	8.6	3.5	9.53	4.76	0.4	4.4
	2NU-VCGW160404F	-	●	-	-	-	-	-	-	-	-	8.6	3.5	9.53	4.76	0.4	4.4
	2NU-VCGW160404T	-	●	-	-	-	-	-	-	-	-	8.6	3.5	9.53	4.76	0.4	4.4
	2NU-VCGW160408	-	●	-	-	-	-	-	-	-	-	8.6	2.6	9.53	4.76	0.8	4.4
	2NU-VCGW160408F	-	●	-	-	-	-	-	-	-	-	8.6	2.6	9.53	4.76	0.8	4.4
	2NU-VCGW160408T	-	●	-	-	-	-	●	-	-	-	8.6	2.6	9.53	4.76	0.8	4.4
T-2NU-VCGW160404	-	●	-	-	-	-	-	-	-	-	8.6	3.5	9.53	4.76	0.4	4.4	
T-2NU-VCGW160408	-	●	-	-	-	-	-	-	-	-	8.6	2.6	9.53	4.76	0.8	4.4	
	CNMA120404	-	-	-	-	-	-	●	-	-	-	9.89	4.5	12.7	4.76	0.4	5.16
	CNMA120408	-	-	-	-	-	-	●	-	●	-	9.89	4.5	12.7	4.76	0.8	5.16
	T-CNMA120408	-	-	-	-	-	-	●	-	-	-	9.89	4.5	12.7	4.76	0.8	5.16
	DNMA150404	-	-	-	-	-	-	●	-	-	-	12.2	3.7	12.7	4.76	0.4	5.16
	DNMA150408	-	-	-	-	-	-	●	-	-	-	12.2	3.4	12.7	4.76	0.8	5.16
	TNMA160404	-	-	-	-	-	-	●	-	-	-	7.2	3.7	9.53	4.76	0.4	3.81
	TNMA160408	-	-	-	-	-	-	●	-	-	-	7.2	3.5	9.53	4.76	0.8	3.81
	T-VNMA160404	-	-	-	-	-	-	●	-	-	-	10.2	4.9	9.53	4.76	0.4	3.81
	VNMA160404	-	-	-	-	-	-	●	-	-	-	10.2	5.8	9.53	4.76	0.4	3.81
	VNMA160408	-	-	-	-	-	-	●	-	-	-	10.2	5.8	9.53	4.76	0.8	3.81
	CCMW09T304	-	-	-	-	-	-	●	-	-	-	4.5	4.3	9.53	3.97	0.4	4.4

1:1 CHAT



cBN Spec

cBN Multi-corner Type (Negative/Positive)

● : Stock

※T-2NU-□□□□△△△△△△ designation package unit is 10 EA.

○ : To be discontinued after inventory depletion

Drawing	Designation	Grade										W (Weight)	mm				
		DNC100	DNC250	DNC300	DNC350	DNC400	DB1000	DB2000	DBN250	DBN350	DBN700A		DBNX20	S (Cutting Edge Length)	IC (Inscribed Circle)	T (Thickness)	r (Nose)
	DCGW11T308	-	-	-	-	-	-	●	-	-	-	4.8	3.2	9.53	3.97	0.8	4.4
	T-DCGW11T308	-	-	-	-	-	-	●	-	-	-	4.8	3.2	9.53	3.97	0.8	4.4
	VBMW160404	-	-	-	-	-	-	●	-	-	-	8.6	3.5	9.53	4.76	0.4	4.4
	VBMW160408	-	-	-	-	-	-	●	-	-	-	8.6	3.5	9.53	4.76	0.8	4.4
	4NS-CNGA120408	-	-	-	-	○	-	-	-	-	-	9.7	3	12.7	4.76	0.8	5.16
	4NS-CNGA120412	-	-	-	-	○	-	-	-	-	-	9.7	2.9	12.7	4.76	1.2	5.16
	4NS-DNGA150608	-	-	-	-	○	-	-	-	-	-	15.1	2.83	12.7	6.35	0.8	5.16
	4NS-DNGA150612	-	-	-	-	○	-	-	-	-	-	15.1	2.46	12.7	6.35	1.2	5.16
	T-TPGW110304	-	-	-	-	-	-	-	-	-	-	2.0	3.7	6.35	3.18	0.4	3.4
	TPGW110304	-	-	-	-	-	-	●	-	-	-	2.0	3.7	6.35	3.18	0.4	3.4
	TPGW110308	-	-	-	-	-	-	●	-	-	-	2.0	3.5	6.35	3.18	0.8	3.4

Chuck

Arbor/Modular

Boring Tool

Angular Head

cBN/PCD

Device&Accessory

Standard

1:1 CHAT



PCD Spec

PCD Insert (Negative/Positive)

※ T-2NU-□□□□△△△△△△△△△△ designation packaging unit is 10EA.

● : Stock

Drawing	Designation	Grade		mm				
		DP150	W (Weight)	S (Cutting Edge Length)	IC (Inscribed Circle)	T (Thickness)	r (Nose)	∅D (Hole Diameter)
	CNMM120404	●	9.9	4.3	12.7	4.76	0.4	5.16
	CNMM120408	●	9.9	4.2	12.7	4.76	0.8	5.16
	CCMW120404	●	8	4.3	12.7	4.76	0.4	5.16
	DNMM150404	●	12.2	3.5	12.7	4.76	0.4	5.16
	DNMM150408	●	12.2	3.2	12.7	4.76	0.8	5.16
	CCMT060202	●	0.9	2.8	6.35	2.38	0.2	2.8
	CCMT060204	●	0.9	2.7	6.35	2.38	0.4	2.8
	CCMT09T304	●	3.4	4.3	9.53	3.97	0.4	4.4
	CCMT09T308	●	3.4	4.2	9.53	3.97	0.8	4.4
	DCMT070202	●	1.2	3.7	6.35	2.38	0.2	2.8
	DCMT070204	●	1.2	3.5	6.35	2.38	0.4	2.8
	DCMT11T302	●	4.5	3.5	9.53	3.97	0.2	4.4
	DCMT11T304	●	4.5	3.5	9.53	3.97	0.2	4.4
	DCMT11T304	●	4.5	3.2	9.53	3.97	0.8	4.4
	DCGT11T304	●	4.5	3.5	9.53	3.97	0.4	4.4

1:1 CHAT



PCD Spec

PCD Insert (Negative/Positive)

※T-2NU-□□□□△△△△△△ designation packaging unit is 10EA.

● : Stock

Drawing	Designation	Grade		W (Weight)	mm				
		DP150			S (Cutting Edge Length)	IC (Inscribed Circle)	T (Thickness)	r (Nose)	∅D (Hole Diameter)
	TPGW080204	●		0.6	-	6.35	2.38	0.4	2.4
	TPGW090204	●		0.8	3.2	5.56	2.38	0.4	2.5
	TPGW110304	●		1.4	3.7	6.35	3.18	0.4	3.4
	TPGW110308	●		1.4	3.5	6.35	3.18	0.8	3.4
	VBMT110304	●		2.5	5.8	6.35	3.18	0.4	3.4
	VBMT110308	●		2.5	4.9	6.35	3.18	0.8	3.4
	VBMT160404	●		8.6	5.8	9.53	4.76	0.4	4.4
	VBMT160408	●		8.6	4.9	9.53	4.76	0.8	4.4
	VCMT110304	●		2.4	5.8	6.35	3.18	0.4	3.4
	VBGW160404	●		8.6	5.8	12.7	4.76	0.4	4.4
	VCMT160404	●		8.3	5.8	9.53	4.76	0.4	4.4
	VCMT160408	●		8.3	5.9	9.53	4.76	0.8	4.4
	TPGN110304	●		1.9	3.7	6.35	3.18	0.4	-
	TPGN110308	●		1.9	3.5	6.35	3.18	0.8	-
	SPGN090304	●		3.6	4.1	9.53	3.18	0.4	-

Chuck

Arbor/Modular

Boring Tool

Angular Head

cBN/PCD

Device&Accessory

Standard

1:1 CHAT



cBN Features



Features

DINOX cBN features very excellent hardness and thermal resistance by adding special ceramic bonding material to cBN, its main ingredient, and sintering them at an ultrahigh pressure high temperature. It also provides optimal conditions for productivity improvement through high-speed processing of cast iron and heat-treated steel due to its excellent strength and wear resistance.

High Accuracy

Wear Resistance

Productivity Improvement

cBN Type

Re-polishing Type	One Use Type	Multi-corner Type	Multi-corner Type(Coated)	NS Type	NT Type

Re-grinding Type

- Stable and long tool life
- Excellent wear resistance, high hardness
- 3-4 time re-polishing is possible, which reduces tool expenses

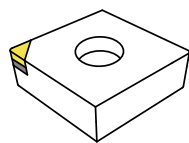

e.g.) CNGA120408

Multi-corner Type (Coated/Uncoated)

- Simple corner management
- Strong welding surface
- Possible to create an effect of several cBNs with one insert



Coated cBN

Uncoated cBN

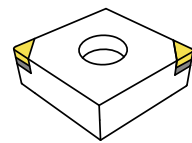

e.g.) 2NU-CNGA120408

NS Type

- Specialized high depth of cut
- Excellent machining performance in spite of variable depth of cut

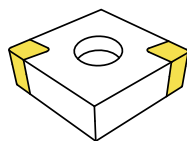
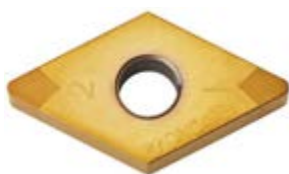

e.g.) 4NS-CNGA120408

NT Type

- High depth of cut versus general brazing type
- Economical cBN

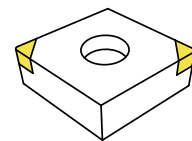

e.g.) 2NT-CNGA120408

- ※ High depth of cut and high feed available; excellent machining performance in spite of variable depth of cut
- ※ Universal machining available; stable and efficient machining versus general brazing inserts

1:1 CHAT



cBN Features



Applications by Grade and Textural Characteristics

Textural Characteristics	Texture	cBN Content	Grade Name	Workpiece, Applications	Features
Mostly cBN particles combine by themselves		High ▲	DB7000 DB7500	Cemented Carbide Alloy, Chilled Cast Iron, White Cast Iron, Iron Metal Sintered Alloy, Heat-resistant Alloy, Cast Iron	<ul style="list-style-type: none"> High cBN content and texture where cBN particles strongly combine by themselves Suitable for cutting machining of high-hardness materials such as cast iron, heat-resistant alloy, Cemented carbide alloy, etc.
Mostly cBN particles combine by means of bonding material		Low ▼	DB1000, DB2000, DBN250, DBN350, DBN500, DBNX20, DBNX25 DNC100, DNC250, DNC300, DNC350 DNC400	Alloy Steel, Titanium Steel, Carbon Tool Steel, Bearing Steel, Dice Steel, Ductile Cast Iron	<ul style="list-style-type: none"> cBN particles strongly combine by special ceramic bonding material Features excellent wear resistance and tenacity in cutting heat-treated steel due to its high cBN retention capacity

Grade Map

Workpiece	Type	High-speed Continuous	Continuous	Light/Medium Interrupted	Heavy Interrupted	
	Usage Classification	H01	H10	H20	H30	
	Coated cBN	DNC100		DNC250	DNC300	DNC350
		DB1000		DB2000	DBNX20	DBNX25
		DB7500		DB7000		
	Usage Classification	1	10	20	30	
	Uncoated cBN	DB7500		DB7000		
		DBN500		DB7000	DBNS800	
		DB7000		DBNS800		
	Usage Classification	K01	K10	K20	K30	
	Uncoated cBN	DBN500		DB7000	DBNS800	
		DB7000		DBNS800		
		DB7000		DBNS800		
	Usage Classification	S01	S10	S20	S30	
	Uncoated cBN	DB7000		DBNS800		
		DB7000		DBNS800		
		DB7000		DBNS800		



1:1 CHAT



cBN Feature

Coating Information

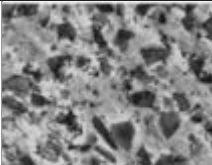
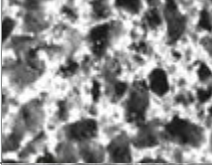
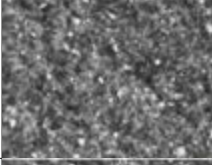
Coated cBN Features

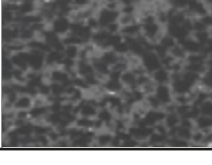
Classification	Grade	Texture	Binder	cBN Content(%)	Grain Size(μm)	Hardness(Gpa)
	DNC100		TiN	50~55	2	31~34
	DNC250		TiC	65~70	6	32~34
	DNC300		TiN	65~70	4	29~31
	DNC350		TiN	60~65	1	33~35
	DNC400		TiN	65	3	-

Coated Thin-film Characteristics

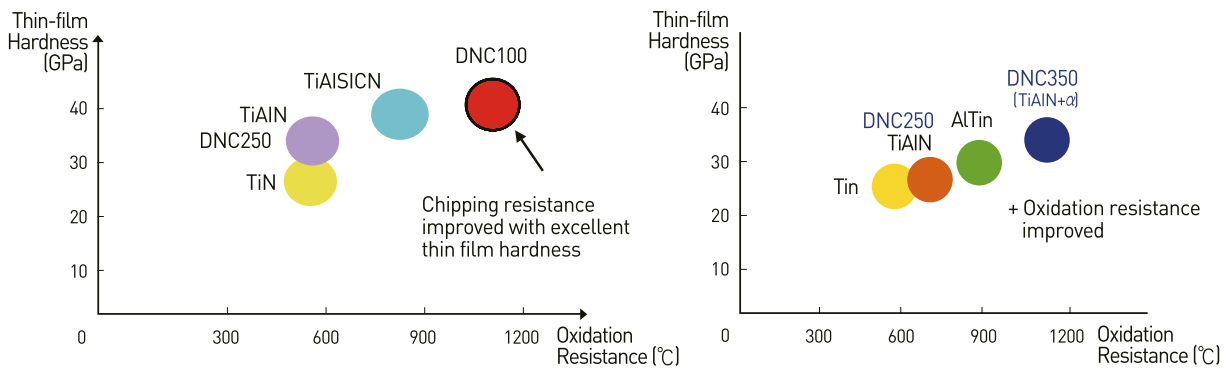

1:1 CHAT



cBN Series Feature

Uncoating Information

Uncoated cBN Features

Classification	Grade	Texture	Binder	cBN Content(%)	Grain Size(μm)	Hardness(Gpa)
	DB1000		TiCN	40 - 45	1	27 - 31
	DB2000		TiN	50 - 55	2	31 - 34
	DBNX20		TiN	55 - 60	3	31 - 33
	DBNX25		TiN	65 - 70	4	29 - 31
	DBN250		TiN	50 - 55	2	31 - 34
	DBN350		TiN	60 - 65	1	33 - 35
	DB7000		CO compound	90 - 95	2	41 - 44
	DB7500		CO compound	90 - 95	1	41 - 44
	DBN500		TiC	65 - 70	6	32 - 34
	DBNS800		Al compound	85 - 90	8	39 - 42
	DB7000		CO compound	90 - 95	2	41 - 44
	DBNS800		Al compound	85 - 90	8	39 - 42
	DB7000		CO compound	90 - 95	2	41 - 44

Chuck

Arbor/Modular

Boring Tool

Angular Head

cBN/PCD



















Device&Accessory

Standard



cBN Heat-treated Steel

Features and Cutting Conditions of cBN Grade

Classification	Coating	Grade	Insert Color	Applications	Cutting Conditions							
					Cutting Speed (m/min)					Feed (mm/rev)	Depth of Cut (mm)	
					0	50	100	150	200			250
	Coated	DNC100	 Dark Gray	For high-speed, continuous machining	180				300	0.03 -0.30	0.03 -0.30	
		DNC250	 Gold	For continuous, light interrupted machining	120				220	0.05 -0.30	0.05 -0.30	
		DNC300	 Dark Gray	For light/medium interrupted machining	90				250	0.05 -0.20	0.05 -0.25	
		DNC350	 Dark Gray	For medium/heavy interrupted machining	90				150	0.05 -0.30	0.05 -0.50	
		DNC400	 Gold	For light/medium interrupted machining	80				200	0.05 -0.30	0.05 -0.50	
	Uncoated	DBNX20			For high-efficiency machining	120				150	0.03 -0.30	0.03 -0.50
		DBNX25			For high-speed interrupted machining	150				200	0.03 -0.30	0.03 -0.50
		DBN250			For light/medium interrupted machining	80				120	0.03 -0.20	0.03 -0.30
		DBN350			For heavy interrupted machining	80				110	0.03 -0.20	0.03 -0.30
		DB1000			For high-speed, continuous machining	130				250	0.03 -0.15	0.03 -0.20
		DB2000			For light/medium interrupted machining	80				200	0.03 -0.20	0.03 -0.30

Comparison of Coated and Uncoated cBNs

Machining Information

Vc(m/min)	f(mm/rev)	ap(mm)	No. of Machining Ops.	Cutting Distance	Workpiece	Heat-treated	Hardness	Size
200	0.1	0.1	20 times	30m	SCM415 round rod	Carburizing heat treatment	58-62	Ø105*150

Wear Loss (Coating Superior)



Surface Roughness (Uncoating Superior)

Grade	Surface Roughness		
	8 times	12 times	20 times
Uncoated cBN	Ra 0.431	Ra 0.477	Ra 0.492
Coated cBN	Ra 0.579	Ra 0.631	Ra 0.792

※The details may vary according to machining environments.



cBN Heat-treated Steel

Applicable Area

- **Coated cBN** : Suitable for all heat-treated steel machining as it is excellent in high-speed and high-efficiency machining.
- **Uncoated cBN** : Suitable for machining of high-hardness heat-treated steel or parts to which cutting speed is limited.

Series	Usable Area
Coated cBN	<ul style="list-style-type: none"> • Ideal for heat-treated steel machining • Machining requiring high speed and high-precision • Machining requiring high-efficiency such as carburized layer removal
Uncoated cBN	<ul style="list-style-type: none"> • Small parts not requiring high cutting speed • Machining materials including much hard particles such as mold parts • Applicable even in case of an unstable machine setup

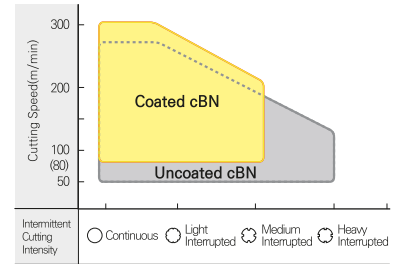

Coated cBN

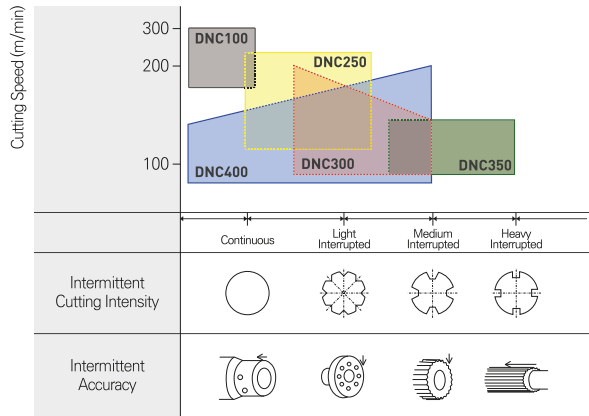

Uncoated cBN

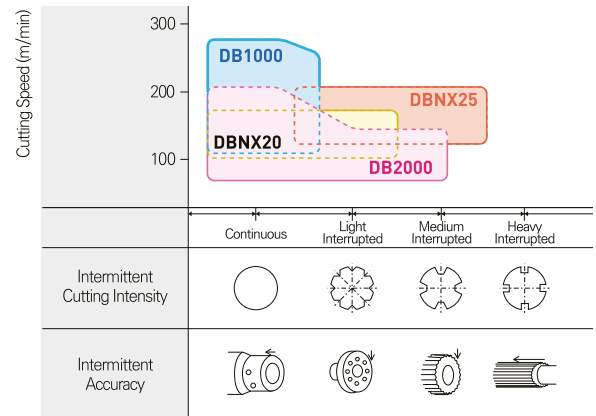

Recommended Machining Works

Outer Diameter Machining

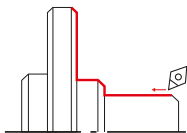

Inner Diameter (Curved surface) Machining

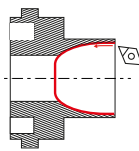

Width Decision Groove Machining

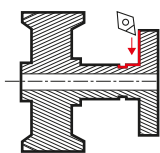

Cross-sectional Machining

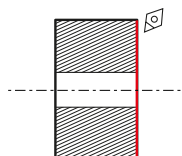

Dice Steel

Uncoated cBN

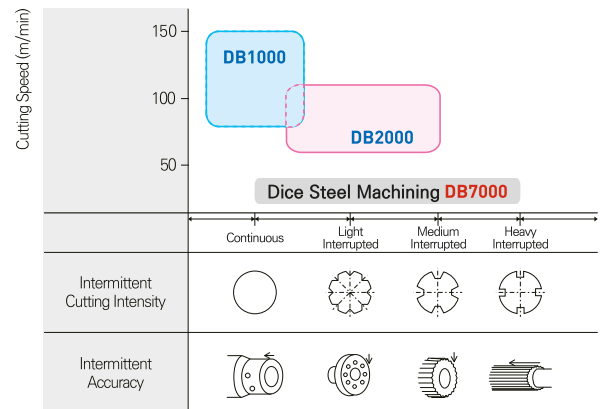



cBN Heat-treated Steel

Cases of Coated Machining

Machining Example

DNC250

Grade	DNC250	Competitor cBN
Insert	2NU-DNGA150408	
Workpiece	H6 Swash Plate(FCD55 Plate)	
Cutting Speed (m/min)	180	
Feed (mm/rev)	0.06	
Depth of Cut (mm)	0.05 - 0.10	
Dry/Wet Cutting	Wet Cutting	

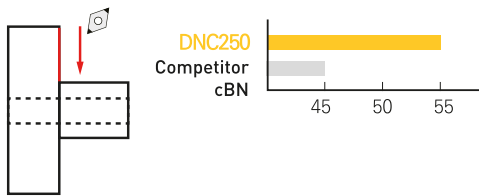

DNC250

Grade	DNC250	Competitor cBN
Insert	3NU-TNGA160408	
Workpiece	Shaft UD Brake(SCR420HB)	
Cutting Speed (m/min)	160	
Feed (mm/rev)	0.08	
Depth of Cut (mm)	0.425	
Dry/Wet Cutting	Wet Cutting	

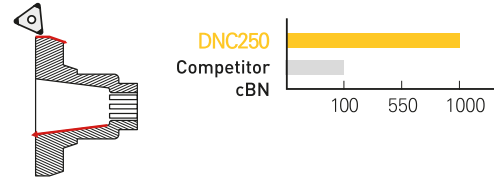

DNC250

Grade	DNC250	Competitor cBN
Insert	2NU-VCGW160408	
Workpiece	Trans driver gear(SCM422)	
Cutting Speed (m/min)	90	
Feed (mm/rev)	0.15	
Depth of Cut (mm)	0.15	
Dry/Wet Cutting	Wet Cutting	

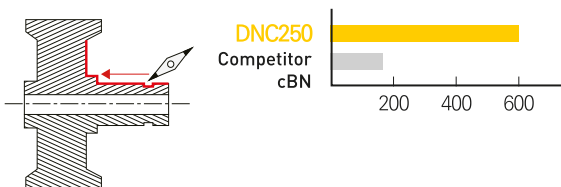

DNC250

Grade	DNC250	Competitor cBN
Insert	2NU-VNGA160408	
Workpiece	Clutch Body(SCR420 8903)	
Cutting Speed (m/min)	140	
Feed (mm/rev)	0.12	
Depth of Cut (mm)	0.025/0.075	
Dry/Wet Cutting	Wet Cutting	

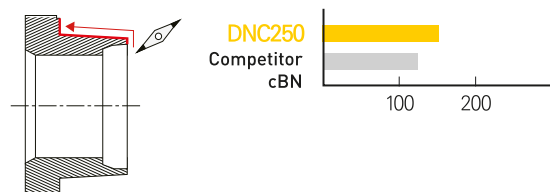

DNC350

Grade	DNC350	Competitor cBN
Insert	2NU-CNGA120408	
Workpiece	Anulus Gear (SCR420)	
Cutting Speed (m/min)	200	
Feed (mm/rev)	0.05 - 0.08	
Depth of Cut (mm)	0.4	
Dry/Wet Cutting	Wet Cutting	

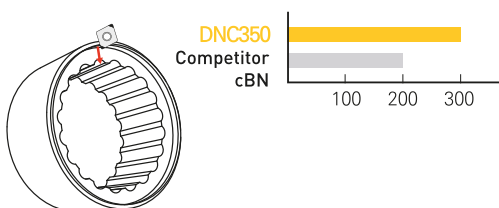

DNC350

Grade	DNC350	Competitor cBN
Insert	2NU-CNGA120404	
Workpiece	Retainer(SAPH440-P)	
Cutting Speed (m/min)	150	
Feed (mm/rev)	0.2	
Depth of Cut (mm)	0.10-0.20	
Dry/Wet Cutting	Wet Cutting	

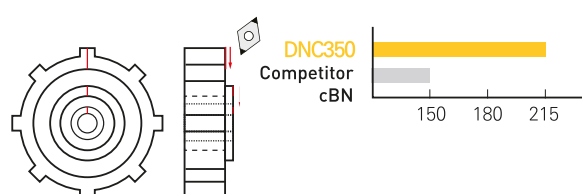

※The details may vary according to machining environments.

1:1 CHAT



cBN Heat-treated Steel

Uncoated Grade Machining Example

Machining Example

DB1000

Grade	DB1000	Competitor cBN
Insert	NU-TPGW110304	
Workpiece	Inner Diameter Boring Machining(SUJ2)	
Cutting Speed (m/min)	120	
Feed (mm/rev)	0.06	
Depth of Cut (mm)	0.2	
Dry/Wet Cutting	Wet Cutting	

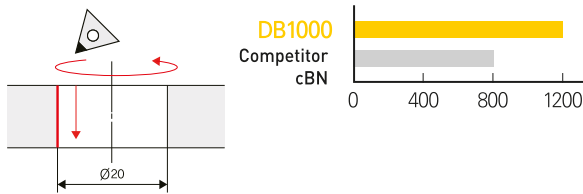

DB1000

Grade	DB1000	Competitor cBN
Insert	2NU-CNGA120408	
Workpiece	Shaft(SCM440H)	
Cutting Speed (m/min)	282	
Feed (mm/rev)	0.1	
Depth of Cut (mm)	0.1	
Dry/Wet Cutting	Wet Cutting	

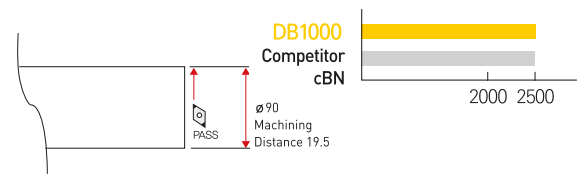

DB1000

Grade	DB1000	Competitor cBN
Insert	2NU-CNGA120412-W	
Workpiece	Reactor	
Cutting Speed (m/min)	210	
Feed (mm/rev)	0.15	
Depth of Cut (mm)	0.23	
Dry/Wet Cutting	Wet Cutting	

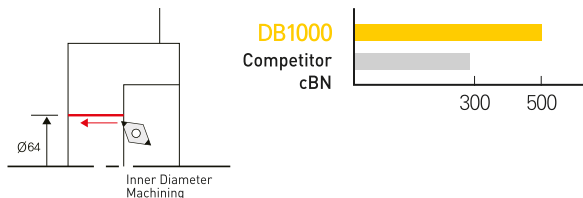

DB2000

Grade	DB2000	Competitor cBN
Insert	2NU-DNGA150408	
Workpiece	Poly Slide(SCM415H CVT)	
Cutting Speed (m/min)	150	
Feed (mm/rev)	0.1	
Depth of Cut (mm)	0.2	
Dry/Wet Cutting	Wet Cutting	

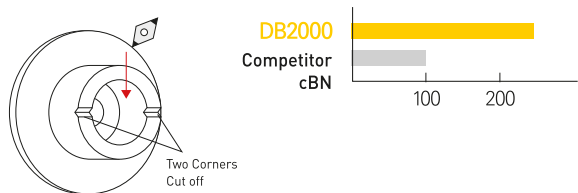

DB2000

Grade	DB2000	Competitor cBN
Insert	2NU-DNGA150408	
Workpiece	Plunger(SKD11)	
Cutting Speed (m/min)	100	
Feed (mm/rev)	0.03 - 0.25	
Depth of Cut (mm)	0.04	
Dry/Wet Cutting	Wet Cutting	

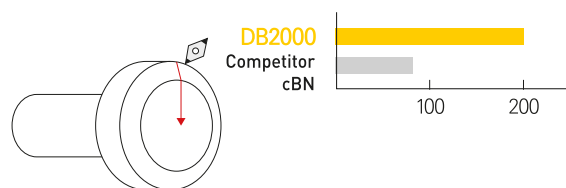

DB2000

Grade	DB2000	Competitor cBN
Insert	NU-TPGW110308	
Workpiece	Clunch Parts(SCM415H)	
Cutting Speed (m/min)	135	
Feed (mm/rev)	0.08	
Depth of Cut (mm)	0.15	
Dry/Wet Cutting	Wet Cutting	

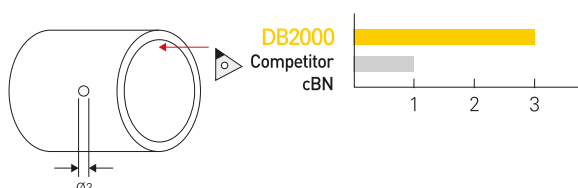

※The details may vary according to machining environments.

1:1 CHAT



cBN Heat-treated Steel

Uncoated Grade Machining Example

Machining Example

DBNX20

Grade	DBNX20	Competitor cBN
Insert	VBMW160412	
Workpiece	BH-RR Outer Wheel	
Cutting Speed (m/min)	130	
Feed (mm/rev)	0.1	
Depth of Cut (mm)	0.2	
Dry/Wet Cutting	Wet Cutting	

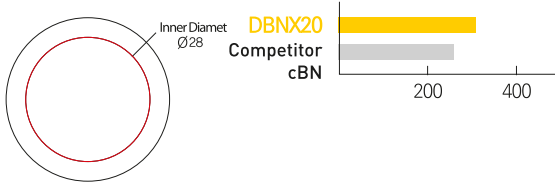

DBNX20

Grade	DBNX20	Competitor cBN
Insert	2NU-CNGA120408	
Workpiece	Reactor	
Cutting Speed (m/min)	221~248	
Feed (mm/rev)	0.1	
Depth of Cut (mm)	0.2	
Dry/Wet Cutting	Wet Cutting	

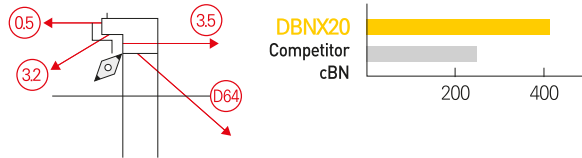

DBNX20

Grade	DBNX20	Competitor cBN
Insert	2NU-DNGA150612	
Workpiece	Transmission Bearing(STB2)	
Cutting Speed (m/min)	137	
Feed (mm/rev)	0.18~0.20	
Depth of Cut (mm)	0.08~0.10	
Dry/Wet Cutting	Wet Cutting	

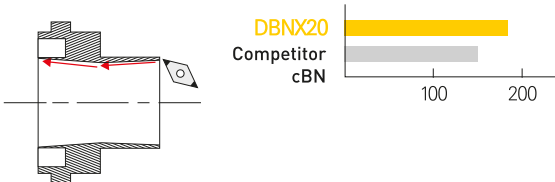

DBNX20

Grade	DBNX20	Competitor cBN
Insert	NU-TNMA160408	
Workpiece	Flange(HrC62 SCM415)	
Cutting Speed (m/min)	150	
Feed (mm/rev)	0.1	
Depth of Cut (mm)	0.12	
Dry/Wet Cutting	Wet Cutting	

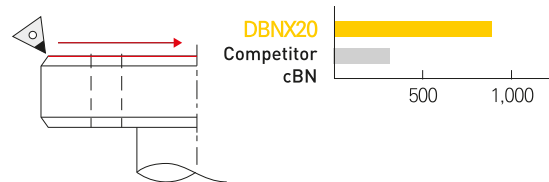

DBNX20

Grade	DBNX20	Competitor cBN
Insert	CNMA120408	
Workpiece	Chain Sprocket (Sintered Alloy)	
Cutting Speed (m/min)	200	
Feed (mm/rev)	0.1	
Depth of Cut (mm)	0.1	
Dry/Wet Cutting	Wet Cutting	



DBNX20

Grade	DBNX20	Competitor cBN
Insert	2NU-DNGA150412	
Workpiece	Bearing Outer Wheel(S55 CR)	
Cutting Speed (m/min)	190	
Feed (mm/rev)	0.15	
Depth of Cut (mm)	0.2	
Dry/Wet Cutting	Wet Cutting	



※The details may vary according to machining environments.

1:1 CHAT



cBN Heat-treated Steel

Uncoated Grade Machining Example

Machining Example

DBNX25

Grade	DBNX25	Competitor cBN
Insert	2NU-CNGA120412-W	
Workpiece	Reactor	
Cutting Speed (m/min)	200-220	
Feed (mm/rev)	0.12-0.16	
Depth of Cut (mm)	0.12-0.16	
Dry/Wet Cutting	Wet Cutting	

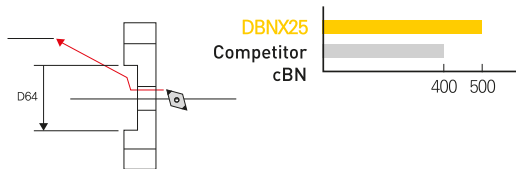

DBNX25

Grade	DBNX25	Competitor cBN
Insert	NU-TNMA160408	
Workpiece	Gear(HrC60 SCM420)	
Cutting Speed (m/min)	150	
Feed (mm/rev)	0.12	
Depth of Cut (mm)	0.2	
Dry/Wet Cutting	Wet Cutting	

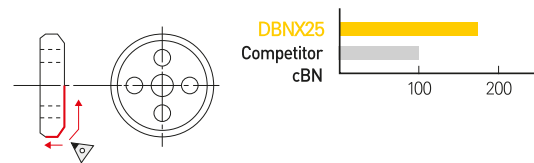

DBN250

Grade	DBN250	Competitor cBN
Insert	3NU-TPGB110308	
Workpiece	Sprocket Crank Shaft(SCM415)	
Cutting Speed (m/min)	120-180	
Feed (mm/rev)	0.18	
Depth of Cut (mm)	0.12	
Dry/Wet Cutting	Wet Cutting	



DBN350

Grade	DBN350	Competitor cBN
Insert	NU-CNMA120412	
Workpiece	Gear Shaft(SCR420H)	
Cutting Speed (m/min)	125	
Feed (mm/rev)	0.15	
Depth of Cut (mm)	0.3	
Dry/Wet Cutting	Wet Cutting	

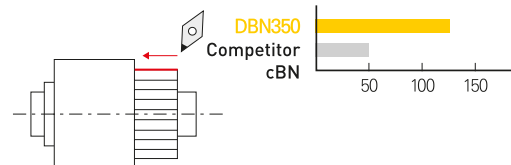

※The details may vary according to machining environments.

1:1 CHAT



cBN Cast Iron



Features and Cutting Conditions of cBN Grade

Applications	Workpiece	Grade	Cutting Conditions							
			Cutting Speed (m/min)					Feed (mm/rev)	Depth of Cut (mm)	
			100	500	1000	1500	2000			
Turning	Gray Cast Iron	DBNS800	200	[Bar from 200 to 2000]			2000	0.1 ~ 1.0	≤ 4.0	
		DBN500	200	[Bar from 200 to 700]			700	0.1 ~ 0.5	≤ 1.0	
		DB7000	500		[Bar from 500 to 2000]			2000	0.1 ~ 0.5	≤ 1.0
	Alloy Cast Iron	DBNS800	200	[Bar from 200 to 1000]			1000	0.1 ~ 0.8	≤ 2.0	
		DBN500	100	[Bar from 100 to 350]			350	0.1 ~ 0.4	≤ 0.5	
	Ductile Cast Iron	DB1000	250	[Bar from 250 to 500]			500	0.1 ~ 0.2	≤ 0.2	
		DB7000	80	[Bar from 80 to 200]			200	0.1 ~ 0.4	≤ 0.5	
Milling	Gray Cast Iron	DBN700	800		[Bar from 800 to 2000]			2000	0.1 ~ 0.5	≤ 0.5
		DBNS800	800		[Bar from 800 to 2000]			2000	0.1 ~ 1.0	≤ 4.0

Applicable Area

Gray Cast Iron (FC)

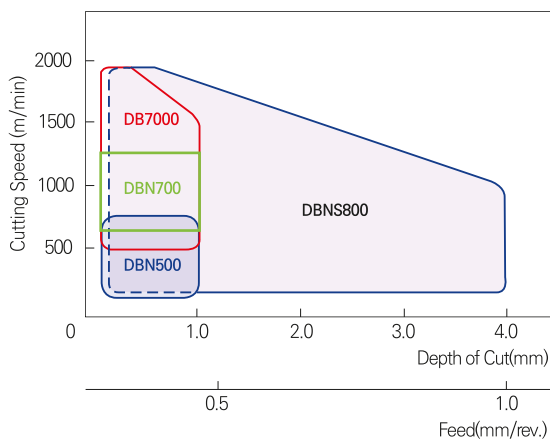

Ductile Cast Iron (FCD)

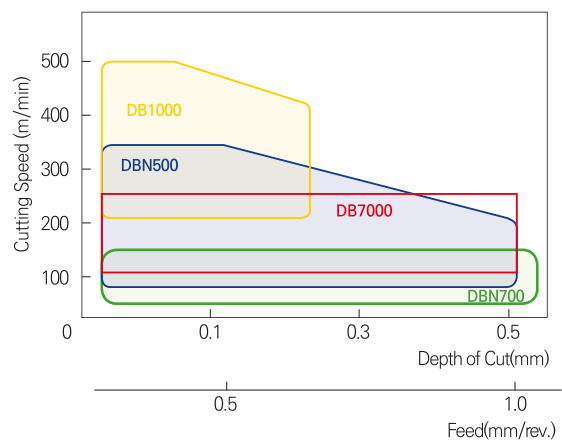

1:1 CHAT



cBN Cast Iron



cBN Grade Features

Classification	Coating	Grade	Insert Color	Applications	Features
	Uncoated	DBN500		FC, FCD Cutting, High-hardness VSR Cutting, High-hardness Roll Grinding Cutting	For cast iron cutting, cBN sintered body formation is optimized and wear resistance and damage resistance are excellent
		DBN700		High-speed Cutting of FC / Cutting of Milling of FC, Cutting of Iron Metal Heat-treated Parts Cutting of High-hardness Roll / Cutting of Heat-resistant Alloy	Grades whose material strength and thermal conductivity are improved by greatly increasing cBN content and optimizing sintered tissues
		DB7000		Foundry Machining	For cast-iron difficult-to-cut materials machining, wear resistance and damage resistance are excellent
		DBNS800		Large Depth of Cut Machining, High-precision Grinding Machining	The solid structure capable to be used cutting knife of entire insert, which responds brazing type machining and high-speed grinding unlike conventional brazing type

Machining Example

DBN500

Grade	DBN500	Competitor cBN
Insert	SPGN090308	
Workpiece	Crank Bore (FC250 = FCD450 Inner Boring)	
Cutting Speed (m/min)	150	
Feed (mm/rev)	0.15	
Depth of Cut (mm)	0.5	
Dry/Wet Cutting	Wet Cutting	



DBN500

Grade	DBN500	Competitor cBN
Insert	CNMA120412	
Workpiece	Compressor Comp (FC250 Facing, Interrupted)	
Cutting Speed (m/min)	400	
Feed (mm/rev)	0.07	
Depth of Cut (mm)	0.15	
Dry/Wet Cutting	Wet Cutting	

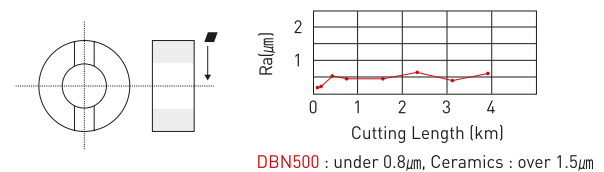

DBN700

Grade	DBN700	Competitor cBN
Insert	Special Bite	
Workpiece	VSR Intake (Hv250-330 Plunge Cutting)	
Cutting Speed (m/min)	95	
Feed (mm/rev)	0.08	
Depth of Cut (mm)	0.2	
Dry/Wet Cutting	Dry cutting	



DBN700

Grade	DBN700	Competitor cBN
Insert	SPGN090308 / TNGA150408	
Workpiece	Fly Wheel (FC300 Facing)	
Cutting Speed (m/min)	600	
Feed (mm/rev)	0.15	
Depth of Cut (mm)	0.2	
Dry/Wet Cutting	Wet Cutting	



※The details may vary according to machining environments.

1:1 CHAT



cBN Sintered Alloy



Features and Cutting Conditions of cBN Grade

*First Recommended

Classification	Coating	Grade	Insert Color	Applications	Features
Sintered Parts	Uncoated	DB7000		High-density Heat-treated Parts	Features excellent wear resistance and damage resistance in sintered alloy machining to stably implement a long service life
		DB7500*		High-density Heat-treated Parts	Appropriate for sintered alloy deburring machining by maintaining the best cutting performance

Workpiece	Grade	Cutting Conditions					Feed (mm/rev)	Depth of Cut (mm)
		Cutting Speed (m/min)						
		100	150	200	250	300		
General Sintered Alloy	DB7000	80	[Bar from 100 to 300]			300	0.1 ~ 0.3	≤0.25
	DB7500*	80	[Bar from 100 to 300]			300	0.1 ~ 0.15	≤0.25

Workpiece	Grade	Cutting Conditions					Feed (mm/rev)	Depth of Cut (mm)
		Cutting Speed (m/min)						
		100	150	200	250	300		
High-density Heat-treated Sintered Alloy	DB7000	80	[Bar from 100 to 200]		200		0.1 ~ 0.3	≤0.2
	DB7500*	80	[Bar from 100 to 200]		200		0.1 ~ 0.15	≤0.2

Applicable Area

General Sintered Alloy

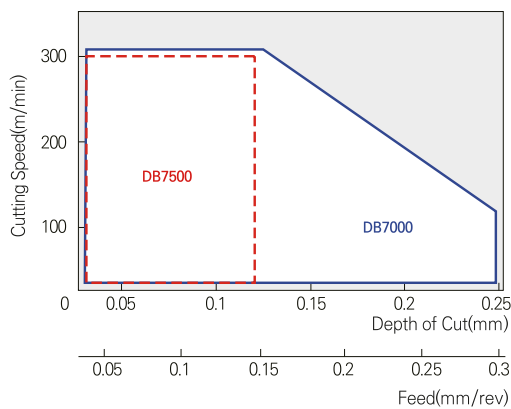

High-density Heat-treated Sintered Alloy

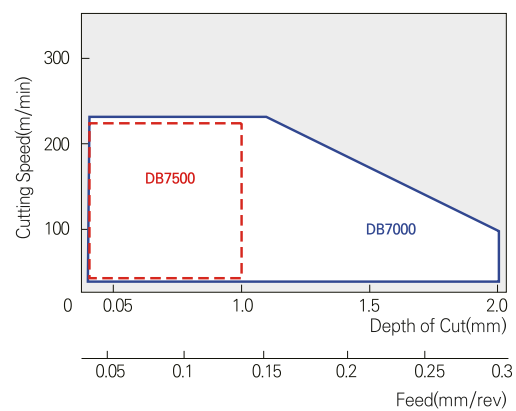

1:1 CHAT



cBN Sintered Alloy



cBN Cutting Performance

Cutting Performance Comparison by Tool Materials

Workpiece	SMF4040
Details of Machining	Groove of $\varnothing 80$ - $\varnothing 100$, porous steel control face machining (after machining of 40pass)
Tool Designation	TNGA160404 / DB7000
Cutting Conditions	$f=0.1\text{mm/rev}$, $a_p=0.1\text{mm}$, wet type

For general sintered alloys, machining with cemented carbide or cermet-coated tools can be performed at up to $V_c=100\text{ m/min}$. However, beyond approximately 120m/min , wear occurs rapidly, leading to the surface roughness degradation and formation of machining burrs. cBN is excellent in maintaining surface roughness, wear resistance, and burr suppression in high-speed ranges, ensuring stable machining performance.

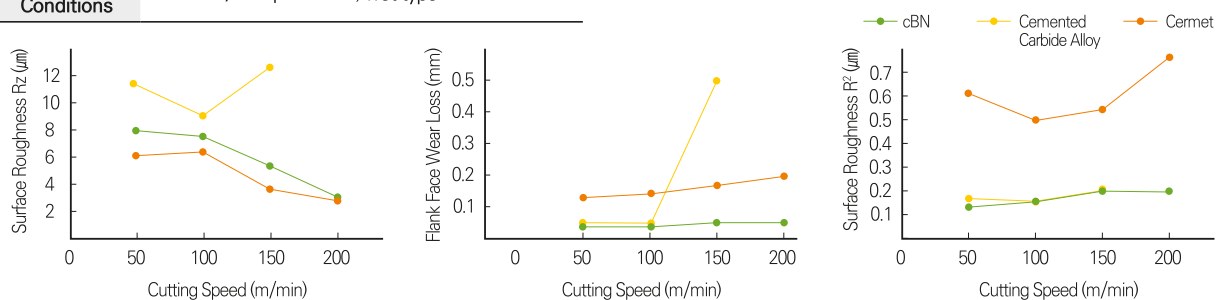

Valve Seat Ring (VSR)

VSR is divided into VSR for Intake (IN) and VSR for Exhaust (EX). Generally, VSR for EX is of high-hardness

Recommended Grade

	Gasoline Engine VSR Material	Diesel Engine VSR Material
Flange Cutting	DB7000 DBN350	DB7000 DBN350
Traverse Cutting	DB7000 DBN500	DB7000 DBN500
Workpiece Hardness(HV)	Low ◀ HV300 ▶ High	Low ◀ HV300 ▶ High

Recommended Conditions

Cutting Speed (m/min)	Feed (mm/rev)	Depth of Cut (mm)
50~100	0.03~0.2	0.05~0.5

Cutting Example

The tool service life was increased more than two fold versus conventional one when machining with DB7000 whose damage resistance is excellent.

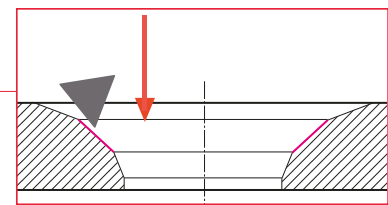

Recommended Conditions

Workpiece	Sintered Alloy (150-250HV)
Details of Machining	VSR(IN) 45 Surface Grinding Machining
Tool Designation	TBGN060104[DB7000]
Cutting Conditions	$V_c=100\text{m/min}$, $f=0.08\text{mm/rev}$ Wet Type

1:1 CHAT



DNC100

Coated cBN



Coating



Heat-treated Steel



Max Depth



Continuous



Features

- Primary recommended grade for high-speed, continuous machining
- Excellent heat resistance due to high oxidation temperature
- Coating with high-hardness, oxidation and chipping resistance applied

Grade	Texture	Binder	cBN Content (%)	Grain Size (μm)	Hardness (Gpa)
DNC100		TiN	50 - 55	2	31 - 34

Performance Comparison Test

Wear Resistance Comparison Test in High-speed Machining

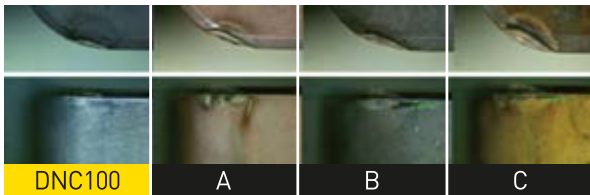

Cutting Conditions

Insert Designation	2NU-CNGA120408
Test Holder	DCLNL2525-M12
Workpiece	SCM415 [58~62HrC]
Cutting Speed (m/min)	300
Feed (mm/rev)	0.1
Depth of Cut (mm)	0.1
Dry/Wet Cutting	Dry Cutting

Wear Loss

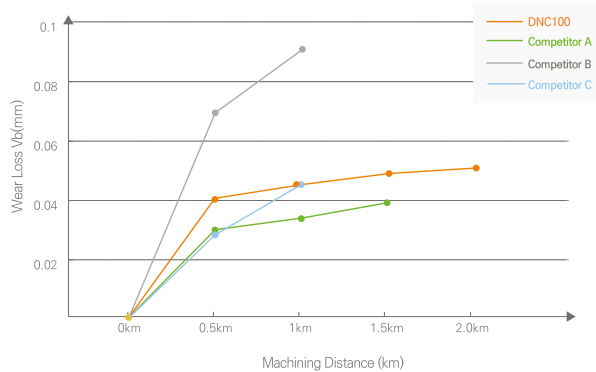

Applicable Area

Cutting Speed (m/min)	300	<div style="border: 1px solid black; padding: 2px; display: inline-block;">DNC100</div>			
	180				
Intermittent Cutting Intensity	Continuous	Light Interrupted	Medium interrupted	Heavy Interrupted	
	Intermittent Accuracy				

Recommended Cutting Conditions

- Improved oxidation and wear resistance through the application of high-hardness coating
- Significantly improved resistance to chipping, fracture, and wear

Cutting Speed (m/min)	180	300
Feed (mm/rev)	0.03	0.3
Depth of cut (mm)	0.03	0.3

1:1 CHAT



DNC250

Coated cBN



Coating
Heat-treated Steel
Max Depth 0.3mm
Continuous
Light Interrupted



Features

- Grade first recommended for continuous machining
- General-purpose cBN that enables machining ranging from Continuous cutting to Light interrupted cutting by PVD coating application
- Wear resistance improved

Grade	Texture	Binder	cBN Content(%)	Grain Size(μm)	Hardness (Gpa)
DNC250		TiC	65 - 70	4	32 - 34

Machining Example

Grade	DNC250	Competitor cBN
Insert	3NU-TNGA160408	
Workpiece	Shaft UD Brake(SCR420HB)	
Cutting Speed (m/min)	160	
Feed (mm/rev)	0.08	
Depth of Cut (mm)	0.425	
Dry/Wet Cutting	Wet Cutting	

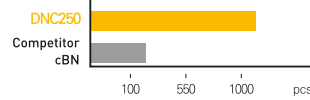
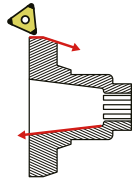

Grade	DNC250	Competitor cBN
Insert	2NU-CNGA120408	
Workpiece	Hardness : Hrc40-50(SCM92 0HVS I)	
Cutting Speed (m/min)	280	
Feed (mm/rev)	0.08-0.15	
Depth of Cut (mm)	0.2	
Dry/Wet Cutting	Wet Cutting	

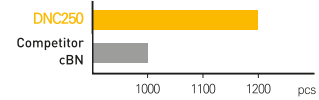
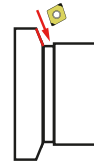

Applicable Area

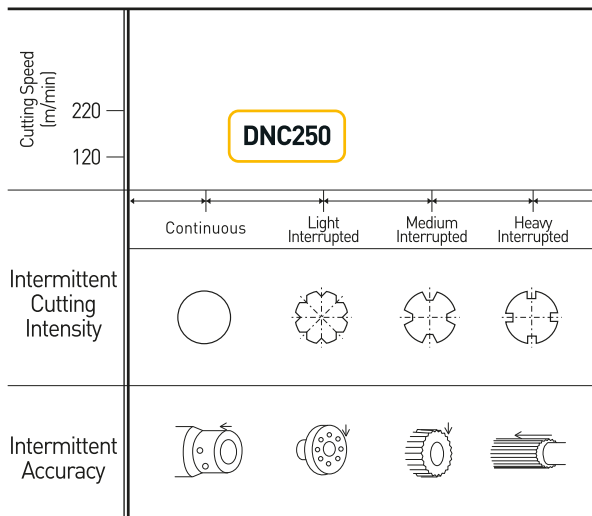

Recommended Cutting Conditions

Cutting Speed (m/min)	120	220
Feed (mm/rev)	0.05	0.3
Depth of Cut (mm)	0.05	0.3

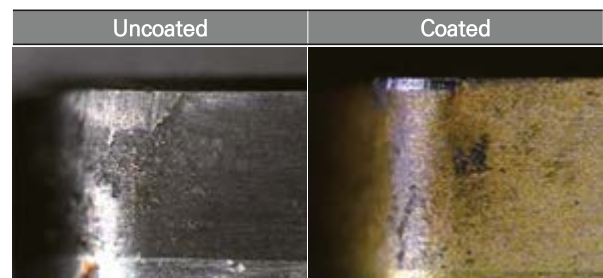

※The details may vary according to machining environments.

1:1 CHAT



DNC300

Coated cBN

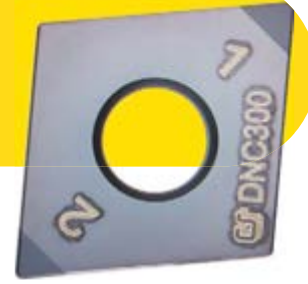

	H	0.3mm		
Coating	Heat-treated Steel	Max Depth	Light Interrupted	Medium Interrupted



Features

- Grade first recommended for machining ranging from Light interrupted to Medium interrupted
- Improved resistance to chipping and wear versus rival products
- Minimized coating peeling due to its stable coating

Grade	Texture	Binder	cBN Content(%)	Grain Size(μm)	Hardness (Gpa)
DNC300		TiN	65 - 70	4	29 - 31

Performance Comparison

[Interruption] V90 F0.1 D0.1 / SCR420H(HrC58-62) / DRY (4PATH = 0.21KM)

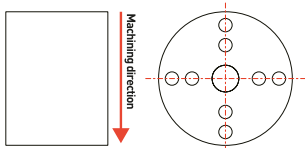

DNC300	Conventional cBN
Stable	Coated Thin Film

[Outer Diameter Interruption] V120 F0.1 D0.1 / 9PATH

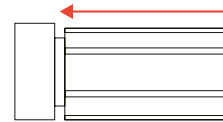

DNC300		Competitor A cBN	
KT	VB	KT	VB
Superior performance due to less VB wear loss of DNC 300			

Machining Example

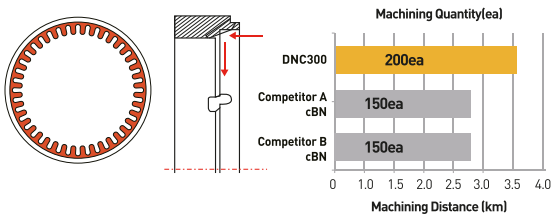

Grade	DNC300	Competitor A cBN	Competitor B cBN
Insert	CNGA120408		
Workpiece	Heat-treated steel(HrC57.8)		
Cutting Speed (m/min)	160		
Feed (mm/rev)	0.08		
Depth of Cut (mm)	0.2~0.3		
Dry/Wet Cutting	Wet Cutting		

Applicable Area

Cutting Speed (m/min)	DNC300			
	Continuous	Light Interrupted	Medium Interrupted	Heavy Interrupted
Intermittent Cutting Intensity				
Intermittent Accuracy				

Recommended Cutting Conditions

- Wear resistance and oxidation resistance are improved with high-hardness thin film adopted
- Significantly improved resistance to chipping, fracture, and wear

Cutting Speed (m/min)	90	200
Feed (mm/rev)	0.05	0.3
Depth of Cut (mm)	0.05	0.25

※The details may vary according to machining environments.

1:1 CHAT



DNC350

Coated cBN



Coating	Heat-treated Steel	Max Depth	Light Interrupted	Heavy Interrupted



Features

- Grade first recommended for interrupted cutting
- Maintains functionality and precision for a long time due to its advanced coating technology
- Economical due to its longer service life

Grade	Texture	Binder	cBN Content(%)	Grain Size(μm)	Hardness (Gpa)
DNC350		TiN	60 - 65	1	33 - 35

Machining Example

Grade	DNC350	Competitor cBN
Insert	2NU-CNGA120408	
Workpiece	SCM415(Hrc58-60)	
Cutting Speed (m/min)	120	
Feed (mm/rev)	0.1	
Depth of Cut (mm)	0.1	
Dry/Wet Cutting	Dry Cutting	



*Workpiece shape

Wear Loss

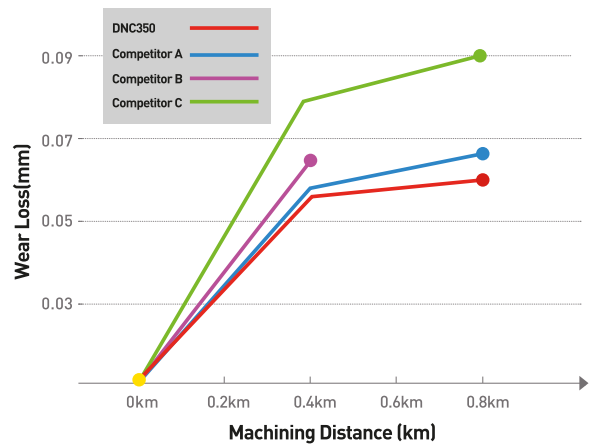

Applicable Area

Cutting Speed (m/min)	DNC350			
	Continuous	Light Interrupted	Medium Interrupted	Heavy Interrupted
Intermittent Cutting Intensity				
Intermittent Accuracy				

Recommended Cutting Conditions

Cutting Speed (m/min)	90 - 150
Feed (mm/rev)	0.05 - 0.3
Depth of Cut (mm)	0.05 - 0.25

※The details may vary according to machining environments.

1:1 CHAT



DB1000

Uncoated cBN



H

Heat-treated Steel

0.3mm

Max Depth



Continuous



Features

- Grade for high-speed machining with the best wear resistance among Uncoated cBNs
- Features an excellent tool service life in the continuous cutting Light interrupted machining
- Focuses on wear resistance and improves fracture resistance
- Improves heat resistance and strength by high-purity TiCN ceramic bonding materials

Grade	Texture	Binder	cBN Content(%)	Grain Size(μm)	Hardness (Gpa)
DB1000		TiCN	40-45	1	27-31

Newly Developed High-purity Ceramic Bonding Material

Existing Grades

Impurities included in the ceramic binders of existing grades leads to a decrease in the strength and heat resistance of the sintered body, resulting in cracks and wear.

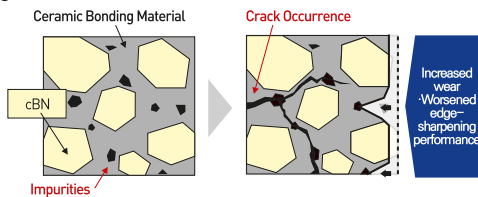

DB1000

DB1000 enhanced heat resistance and strong tenacity by reducing impurities to the very limit using the newly developed 「high-purity ceramic bonding material」!

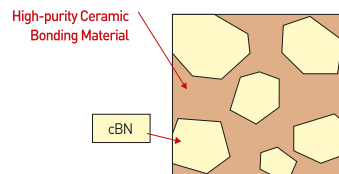

Cutting Performance

Dimension Accuracy Comparison (Continuous Cutting)

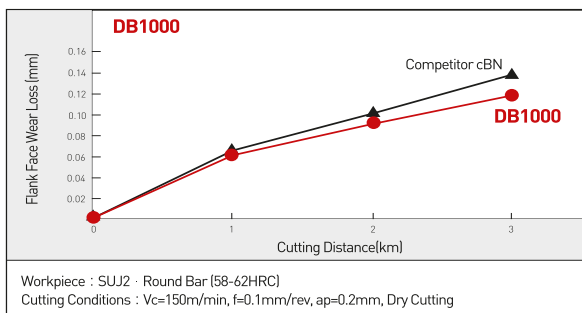

Machining Precision

Wear Resistance (Continuous Cutting)

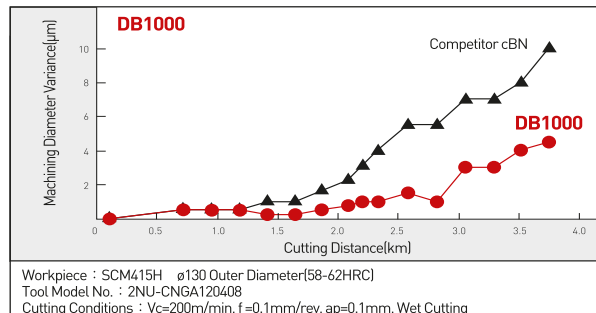

Applicable Area

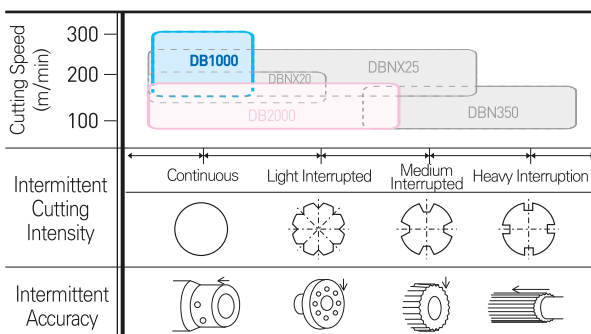

Recommended Cutting Conditions

Cutting Speed (m/min)	130 - 250
Feed (mm/rev)	0.03 - 0.15
Depth of Cut (mm)	0.03 - 0.2

※ Cutting Oil: Continuous machining dry/wet, Interrupted machining dry

※The details may vary according to machining environments.

1:1 CHAT



DB2000

Uncoated cBN



H Heat-treated Steel
0.3mm Max Depth
Continuous Continuous
Medium Interrupted Medium Interrupted



Features

- General-purpose grade that responds to overall heat-treated steel – Realizes a stable tool service life ranging from continuous cutting to Light / Medium interrupted machining
- Highly compatible with fracture resistance and wear resistance – Both properties greatly improved by the use of the high-purity ceramic bonding material
- Achieves a stable surface roughness based on edge-sharpening performance

Grade	Texture	Binder	cBN Content(%)	Grain Size(μm)	Hardness (Gpa)
DB2000		TiN	50 - 55	2	31 - 34

Newly Developed High-purity Ceramic Bonding Material

Conventional Grade

Impurities included in conventional grade ceramic bonding materials decreased the strength and heat resistance of sintered parts, becoming the cause of cracks (fracture) and wear.

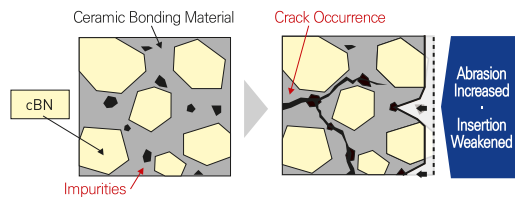

DB2000

DB2000 realizes enhanced heat resistance and strong tenacity by reducing impurities to the very limit using the newly developed 「high-purity ceramic bonding material」!

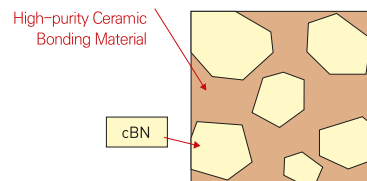

Cutting Performance

Wear Resistance (Continuous Machining)

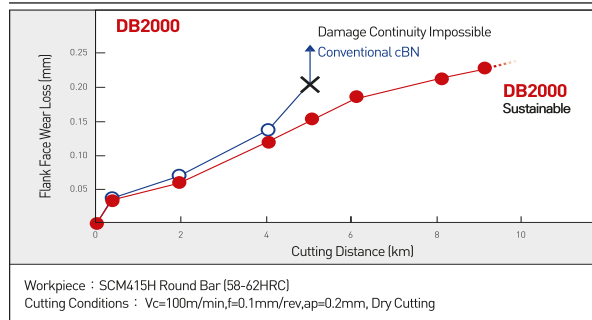

Machining Precision

Surface Roughness Comparison (Continuous Machining)

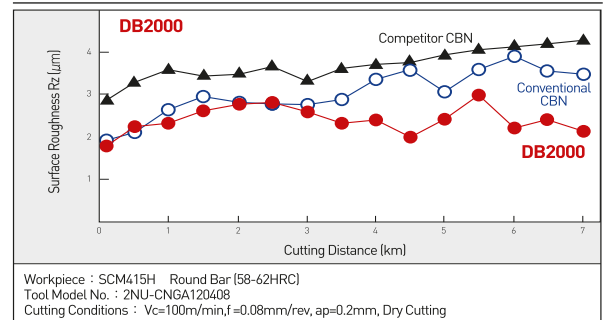

Applicable Area

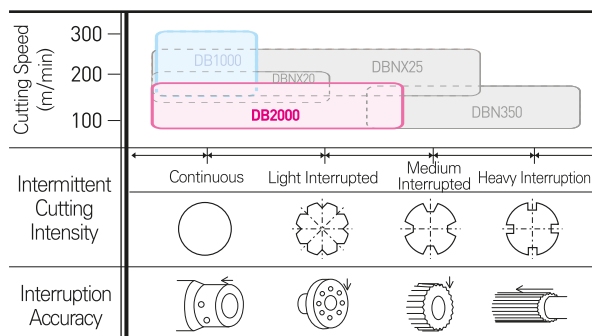

Recommended Cutting Conditions

Cutting Speed (m/min)	80 - 200
Feed (mm/rev)	0.03 - 0.2
Depth of Cut (mm)	0.03 - 0.3

※ Cutting Oil: Continuous Machining Dry/Wet, Interrupted Machining Dry

※The details may vary according to machining environments.

1:1 CHAT



DB7000

Uncoated cBN



K	0.5mm	Sintered Parts		
Cast Iron	Max Depth	Sintered Parts	Continuous	Light Interrupted



Features

- Ideal for high-speed grinding machining of cast iron
- Suppresses heat crack and realizes excellent damage resistance by high-speed machining of gray cast iron
- Realizes highly efficient sintered alloy machining
- Provides a stably longer service life in case of machining of sintered alloys with diverse shape hardness by meeting the requirements for cutting edge treated products of high standard+2 types
- Responds to various difficult-to-cut materials
- Features high performance for difficult-to-cut materials such as rolls, high-speed tools, and heat resistant alloys, etc.

Grade	Texture	Binder	cBN Content(%)	Grain Size(μm)	Hardness (Gpa)
DB7000		CO Compound	90 - 95	2	41 - 44

Tissue that Acidized cBN Sintered Parts

Provides an excellent damage resistance and an enhanced inter-cBN particle coherence by sintering intermediate particle cBNs in high-density to realize the best content Ensures a long service life and stable machining in highspeed grinding of hard-to-cut materials of cast iron sintered alloys

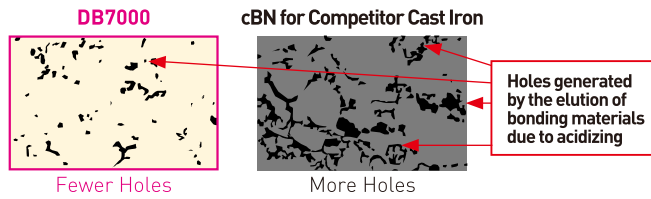

Cutting Performance

Cast Iron Milling Machining

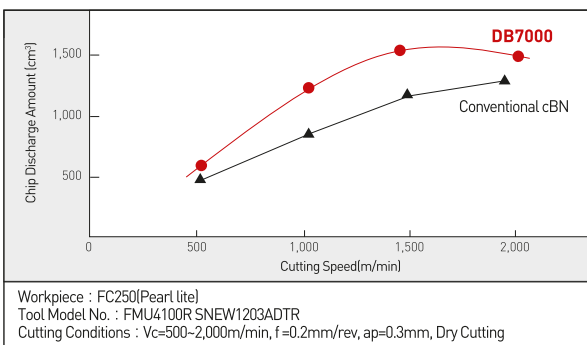

Cast Iron Turning Machining

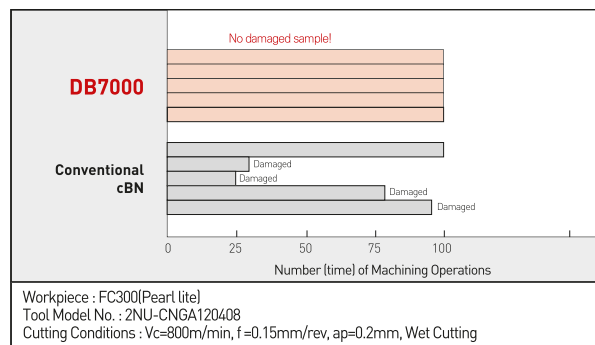

Cast Iron Turning Machining

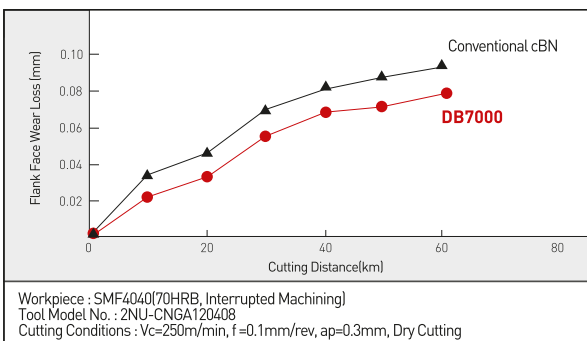

Recommended Cutting Edge Treatment

Item	TYPE	Honing	Negaland	Angle
Sharp	F	—	—	—
Standard	—	—	0.12	15°
Reinforced	T	—	0.12	25°

※The details may vary according to machining environments.

1:1 CHAT



DB7500

Uncoated cBN



Sintered Parts 0.5mm Continuous Light Interrupted
 Sintered Parts Max Depth Continuous Light Interrupted Parts



Features

- Ideal for grinding machining of sintered alloys
- Realizes excellent surface roughness and machined surface quality
- Various shapes of sintered parts can cutting by various cutting edge treatment
- The F type, designed for cutting performance in machining sintered alloys, suppresses burrs and improves machining precision.
- The T type, with reinforced cutting edges, demonstrates stable chipping resistance even during interrupted machining.

Grade	Texture	Binder	cBN Content(%)	Grain Size(μm)	Hardness (Gpa)
DB7500		CO compound	90 - 95	1	41 - 44

Cutting Performance

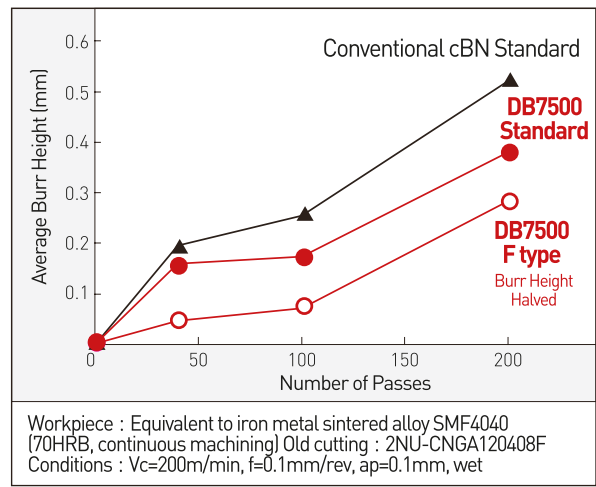
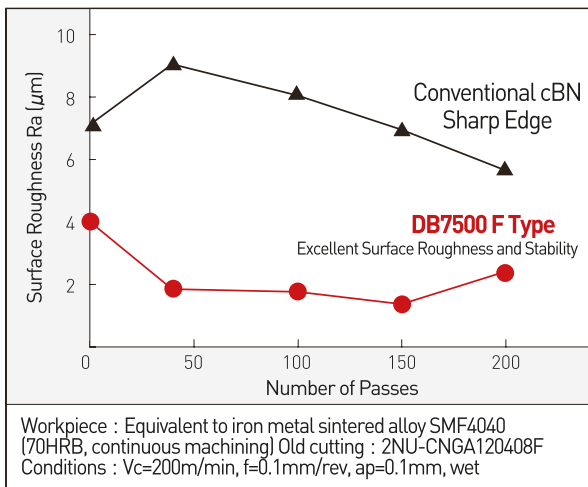

Feed-burr Relationship

Workpiece : WT Cross Section
 Tool Model No. : 3NU-TNGA160404
 Cutting Conditions : Vc=200m/min, f=0.1mm/rev, ap=0.1mm, Wet Cutting

	F type	Standard Type	T Type
A			
B			

* If Feed is more than 0.1mm/rev, the T type is superior to the standard type in terms of cutting taste and burr can be inhibited.

Recommended Cutting Edge Treatment

In case of chipping and damage, the T type is recommended for higher cutting edge strength.

Item	TYPE	Honing	Negaland	Angle
Sharp	F	—	—	—
Standard	—	—	0.12	15°
Reinforced	T	—	0.12	25°

※The details may vary according to machining environments.

1:1 CHAT



RA,GA Chip Breaker

cBN Chip Breaker



Coating



Chip Breaker



0.5mm

Max Depth



Features

- Smooth chip evacuation with the use of chip breakers
- Proper for automation
- RA chip breaker is for roughing
- GA chip breaker is for finishing

Example of Use

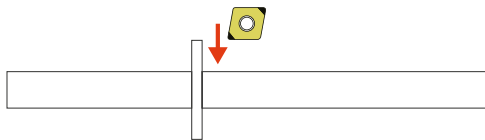

General-type cBN



GA Chip Breaker

Applicable Area

Grade	DNC350(GA)	Competitor cBN
Insert	2NU-CNGM120412-GA	
Workpiece	Input Shaft (SCM920 HVSI)	
Cutting Speed (m/min)	145	
Feed (mm/rev)	0.1	
Depth of Cut (mm)	0.4 ~ 0.5	
Dry/Wet Cutting	Wet Cutting	

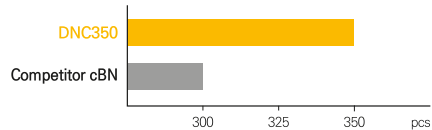

Chip Breaker

GA Type

Chip breaker suitable for finishing

RA Type

Chip breaker suitable for roughing

Chip Breaker Features

Superior design fit for chip breaking to induce easy curling

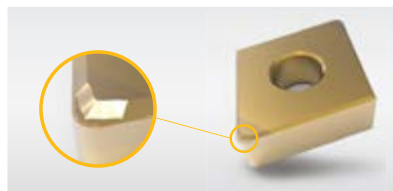
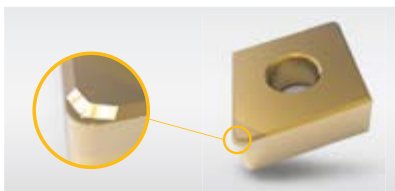

Chip Breaker Comparison

GA Chip Breaker

Cutting Speed=150m/min
Feed=0.15mm/rev
Depth of Cut=0.15mm



RA Chip Breaker

Cutting Speed=150m/min
Feed=0.15mm/rev
Depth of Cut=0.3mm



Applicable Area

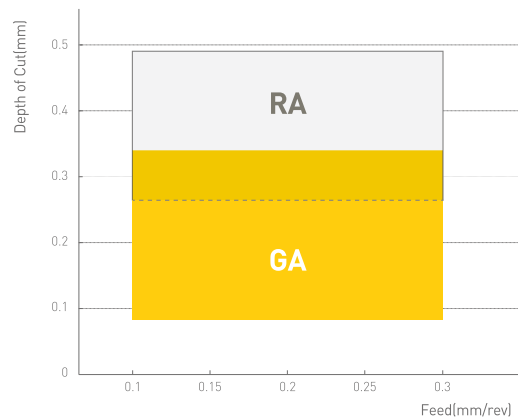

※The details may vary according to machining environments.



cBN Technical Data

Manufacturing Process of cBN

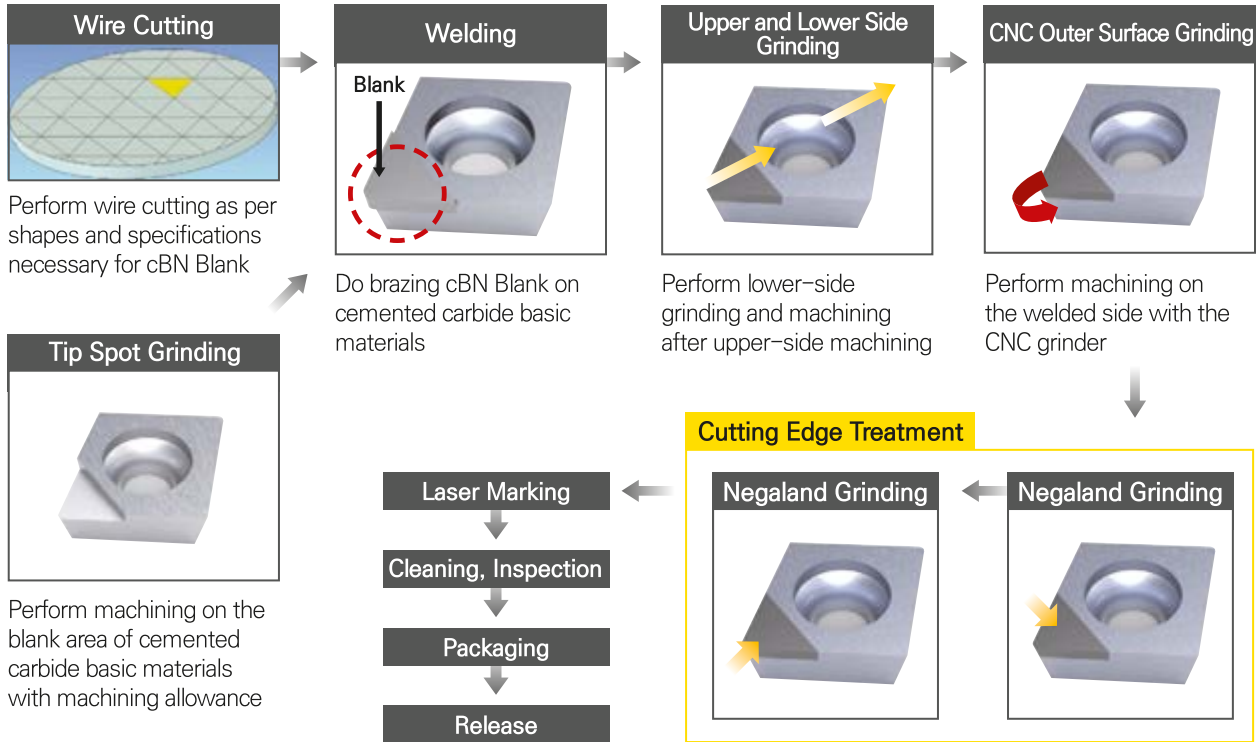

Cutting speed change and tool materials development in history

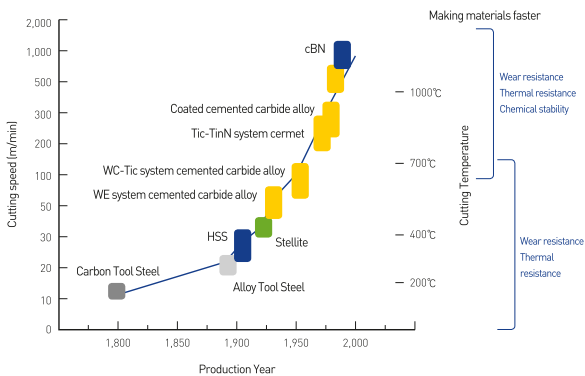

Hardness and intensity of tool materials

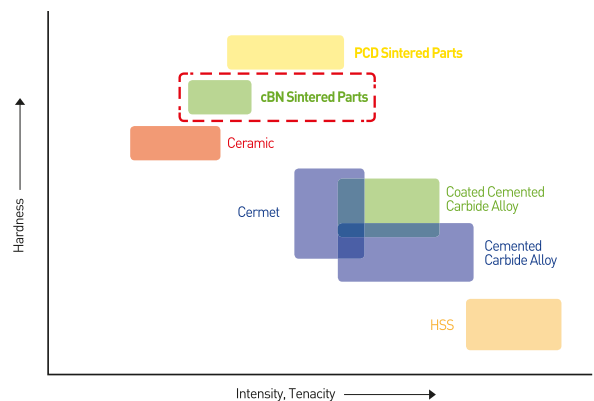



cBN Technical Data

Main Characteristics of cBN

Main Characteristics I of cBN

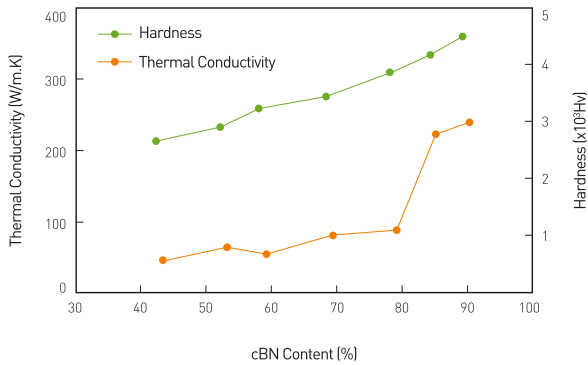

Main Characteristics II of cBN

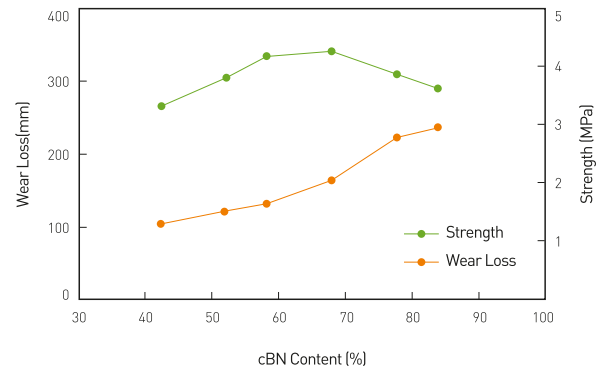









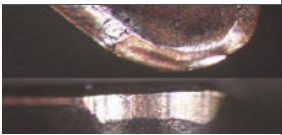
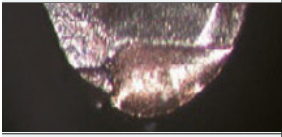

cBN Machining Workpieces and Advantages of Machining

Workpiece	Representative Parts	Advantages of Machining	Corresponding Grade
Heat-treated Steel	Transmission Gear Driving Shaft Shafts Valves Hydraulic Parts, etc.	<ul style="list-style-type: none"> Improved workpiece phenomenon accuracy Responding to machining of composite parts and micro parts Machining efficiency improved, grinding/polishing minimized Investment equipment cost reduced Environmental measures 	DNC100,DNC250 DNC300,DNC350 DNC400 DB1000, DB2000 DBN250, DBN350 DBNX20, DBNX25
Casting	Engine Block Cases Brake Disks, etc.	<ul style="list-style-type: none"> Responding to high-speed machining Responding to hard-to-cut material casting Machining efficiency improved 	DBNS800, DBN500 DB7000
Sintered Alloy	WT(VTC) Parts Various Sprocket Rotas Oil Pump Parts Valve Seats	<ul style="list-style-type: none"> Improved workpiece phenomenon accuracy Responding to heat-treatment sintered parts and composite parts Capacity utilization (longer tool service life) High-speed, high-efficiency machining 	DBN500 DB7000, DB7500
Heat-resistant Alloy	Jet Engine Parts, etc.	<ul style="list-style-type: none"> Machining efficiency improved Workpiece machining surface roughness improved 	DBNX20

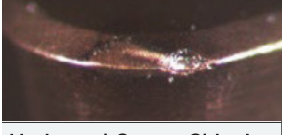
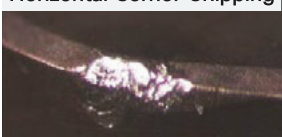

cBN Technical Data

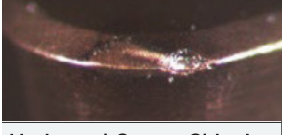
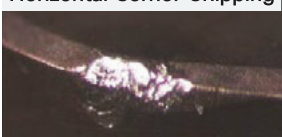
Causes of and Measures for Tool Damage

Insert Damage Type	Causes	Measures																
Flank Face Wear 	<ul style="list-style-type: none"> • Insufficient of wear resistance of tool grade • High cutting speed • Low feed rate 	<ul style="list-style-type: none"> • Select high wear resistance grade • Decreases cutting speed • Reduce to less than Vc 200m/min. (Measures to increase feed and decrease machining distance are effective.) • Enlarge clearance angle 																
Crater Wear 	<ul style="list-style-type: none"> • Insufficient of crater wear resistance of tool grade • Too high cutting speed • Low feed rate 	<ul style="list-style-type: none"> • Change to high-sufficiency machining grade • Reduces cutting speed and feeds 																
Crater Damage 			Flaking Damage 	<ul style="list-style-type: none"> • Insufficient tenacity of tool grade • High radial cutting force 	<ul style="list-style-type: none"> • Use high tenacity grade • Increase cutting edge strength (Enlarge Negaland angle and perform honing) 	Corner Wear 	<ul style="list-style-type: none"> • Tough surface at the machining area • Wear due to chips 	<ul style="list-style-type: none"> • Change to grade with strong resistance to corner wear • Increase cutting speed (more than 150m/min) • Apply various feeds • Enlarge the Negaland angle and perform honing operation 	Previous Corner Chipping 	<ul style="list-style-type: none"> • Great impact on the front cutting edge and large number of times 	<ul style="list-style-type: none"> • Change to a grade with high resistance to damage • Increase feed (Impact of interruption reduced and chipping inhibited) • Enlarge the Negaland angle and perform honing operation 	Horizontal Corner Chipping 	<ul style="list-style-type: none"> • Great impact on the horizontal cutting edge and large number of times 	<ul style="list-style-type: none"> • Change to a grade with high resistance to damage • Decrease feed • Enlarge horizontal cutting edge angle • Increase R size • Enlarge the Negaland angle and perform honing operation 	Crack 	<ul style="list-style-type: none"> • Large heat impact 	<ul style="list-style-type: none"> • In case of wet cutting machining > dry cutting recommended • Change to high thermal conductivity grade • Decrease Vc, f, ap to reduce machining load 	Built Up Edge 
Flaking Damage 	<ul style="list-style-type: none"> • Insufficient tenacity of tool grade • High radial cutting force 	<ul style="list-style-type: none"> • Use high tenacity grade • Increase cutting edge strength (Enlarge Negaland angle and perform honing) 																
Corner Wear 	<ul style="list-style-type: none"> • Tough surface at the machining area • Wear due to chips 	<ul style="list-style-type: none"> • Change to grade with strong resistance to corner wear • Increase cutting speed (more than 150m/min) • Apply various feeds • Enlarge the Negaland angle and perform honing operation 																
Previous Corner Chipping 	<ul style="list-style-type: none"> • Great impact on the front cutting edge and large number of times 	<ul style="list-style-type: none"> • Change to a grade with high resistance to damage • Increase feed (Impact of interruption reduced and chipping inhibited) • Enlarge the Negaland angle and perform honing operation 																
Horizontal Corner Chipping 	<ul style="list-style-type: none"> • Great impact on the horizontal cutting edge and large number of times 	<ul style="list-style-type: none"> • Change to a grade with high resistance to damage • Decrease feed • Enlarge horizontal cutting edge angle • Increase R size • Enlarge the Negaland angle and perform honing operation 																
Crack 	<ul style="list-style-type: none"> • Large heat impact 	<ul style="list-style-type: none"> • In case of wet cutting machining > dry cutting recommended • Change to high thermal conductivity grade • Decrease Vc, f, ap to reduce machining load 																
Built Up Edge 	<ul style="list-style-type: none"> • Too low cutting speed • Strong affinity of the workpiece with the tool 	<ul style="list-style-type: none"> • Increase cutting speed • Select a shape whose slope angle is larger than the workpiece • Select a grade whose tenacity is better than the workpiece 																



cBN Technical Data

Heat-treated Steel High-precision Machining Points

Out of Roundness

Clamping the workpiece evenly as possible

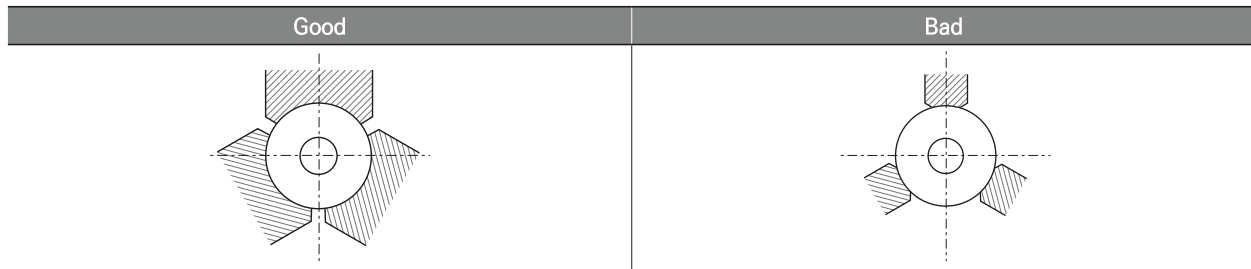

Cylindricity

Clamping near the machining area

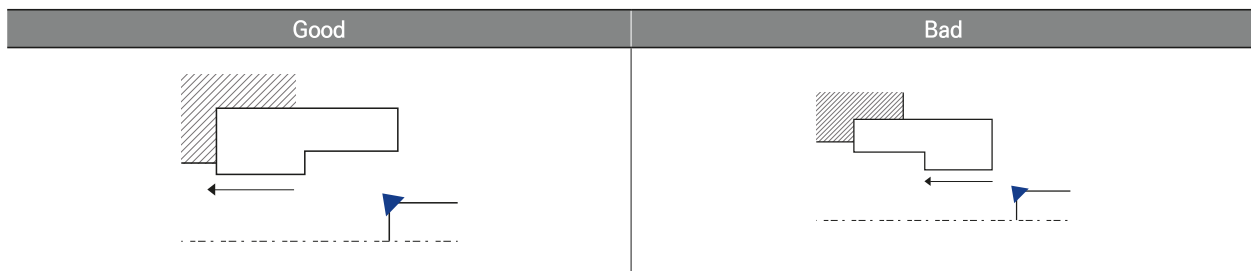

Relationship of Chucking Pressure and Out-of-roundness

Machining Conditions

- Machine: N/C lathe
- Workpiece: SUJ2 HRC60
- Chuck: 3Jaw
- Tool : DBN250, TPGW160404

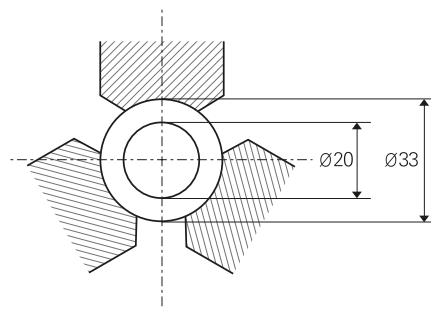

Cutting Conditions

- Cutting Speed=150m/min
- Feed=0.04mm/rev
- Depth of Cut = 0.1mm
- Wet Cutting

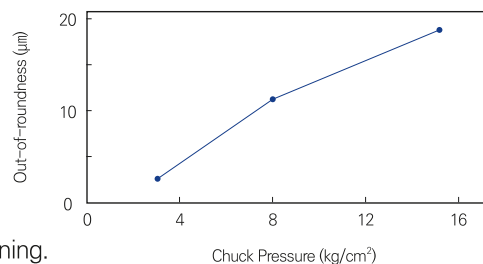

※ An appropriate chuck pressure is necessary for an excellent machining.



cBN Edge Treatment

cBN Wiper Insert

Shape

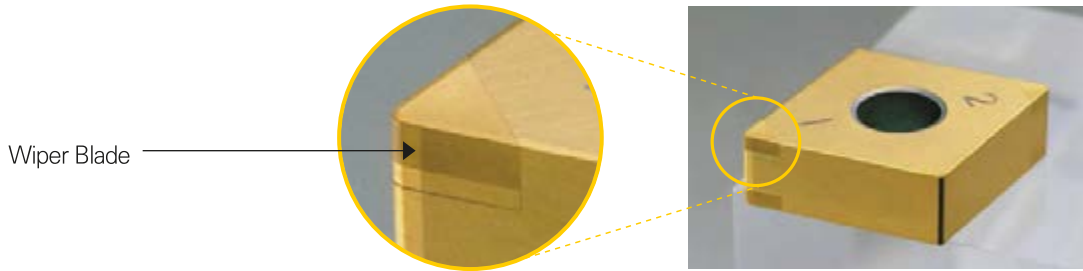

Purpose

CT reduction — Tool service life increased — High surface roughness required

Features and Performance of Wiper Insert

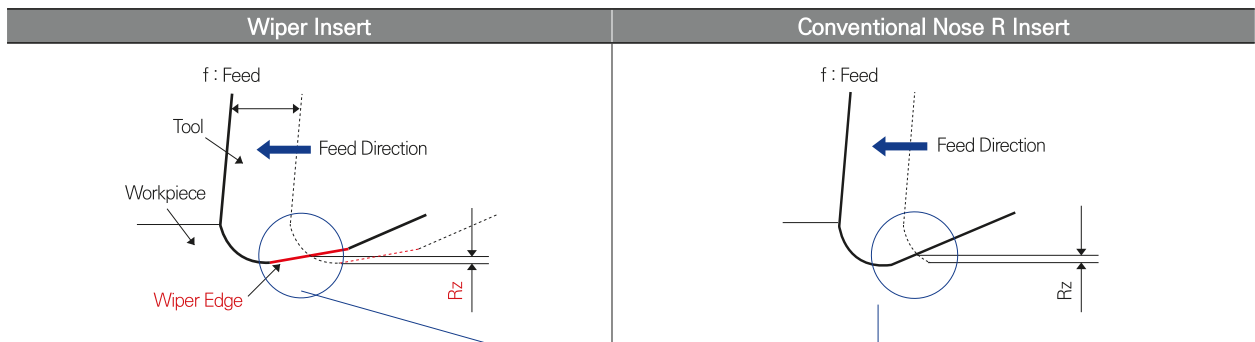

Features

- Surface roughness improved
- High efficiency machining based on high feed (when the surface roughness is the same)

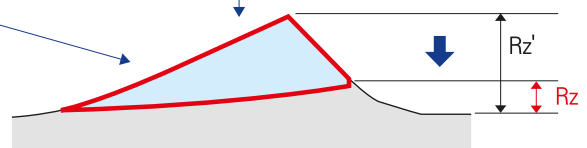

※ According to wiper cutting edge, the surface roughness Rz is getting smaller even in case of cutting with the same feed.

Theoretical Surface Roughness of Wiper Insert

Based on the wiper effect, surface roughness was increased 3~5 times on the same conditions!

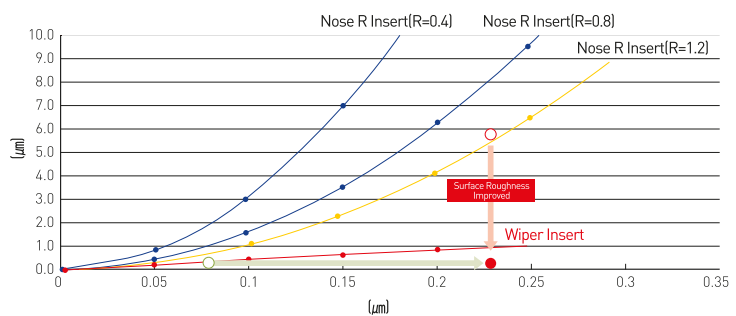

※The details may vary according to machining environments.



cBN Edge Treatment

cBN Cutting Edge Treatment

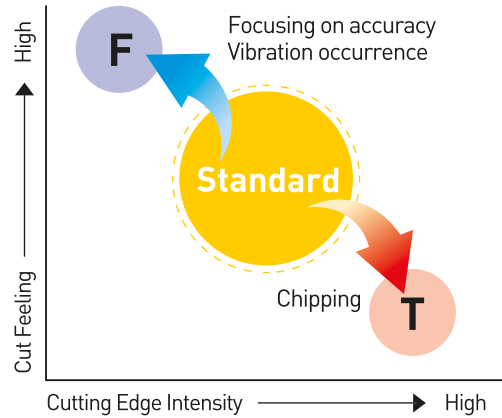
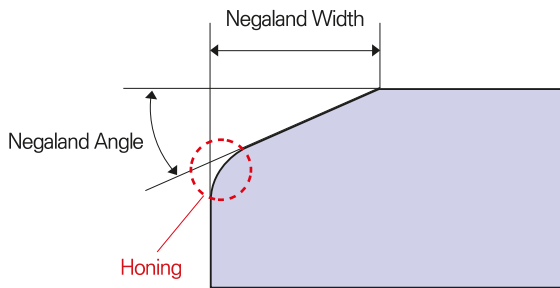

CNGA120408F / CNGA120408 / CNGA120408T

Item	Marking	Heat-treated Steel			Cast Iron/Sintered Alloy		
		Honing	Negaland Width	Negaland Angle	Honing	Negaland Width	Negaland Angle
Sharp	F	0	0.12	15-degrees	-	-	-
Standard*	None	0	0.12	25-degrees	N/A	0.12	15-degrees
Reinforced	T	0	0.12	35-degrees	N/A	0.12	25-degrees

- First recommended cutting edge treatment: standard type*
- Apply sharp / reinforcement types according to machining conditions

Adjust negaland width and angle and honing amount appropriately for machining

Characteristics of cBN Honing

- SCM415 \varnothing 10 Inner diameter machining 2NU-CNGA120408 DBNX20
- Cutting Speed=70m/min Feed=0.03mm/rev Depth of Cut=0.05mm Dry Cutting
- Giving honing increases cutting resistance to weaken machining accuracy but tends to improve surface roughness.

Comparison of cylindricity as per cutting edge shape

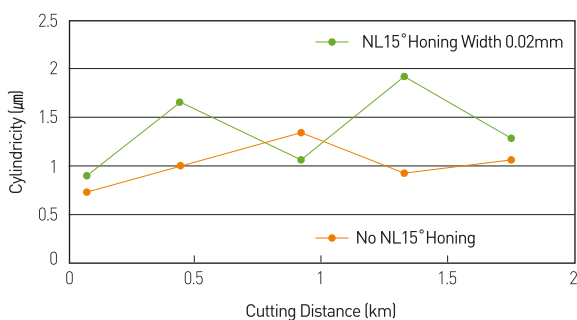

Comparison of surface roughness as per cutting edge shape

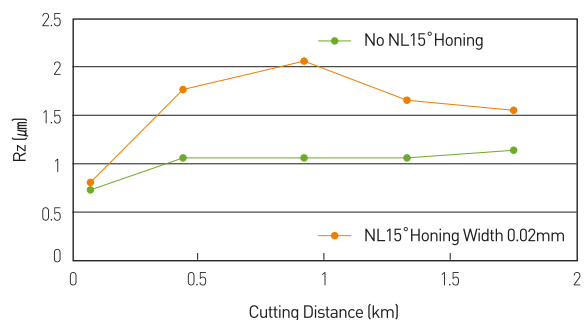

※The details may vary according to machining environments.



cBN Edge Treatment

cBN Test Comparison – Negaland

The smaller negaland angle is, the smaller cutting resistance is.

Comparison of Cutting Resistance

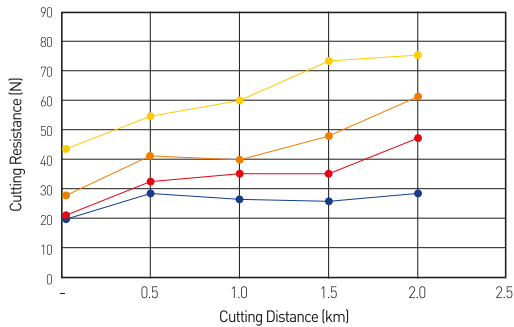

※ TEST Information

- Cutting Conditions :
 - Cutting Speed 90m/min
 - Feed 0.06mm/rev
 - Depth of Cut = 0.08mm
- Workpiece: SCM420(HRC55~57)
- Holder: DCLNR2525
- Insert: CNMA120408 / DBN250
(Standard Cutting Edge : Negaland Angle 25°)

cBN (Effect of Negaland)

Dimensional Accuracy

Dimension accuracy increases as the cutting edge angle is getting smaller.

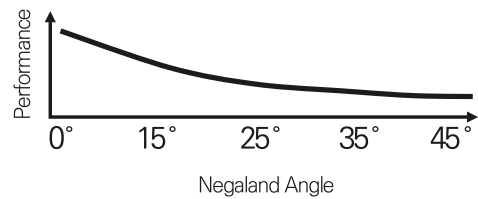

Chipping Resistance

Cutting edge strength increases as the cutting edge angle is getting larger.

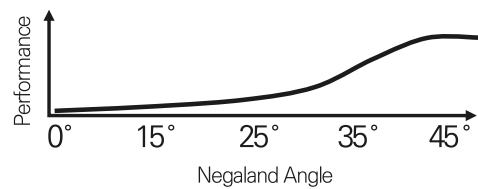

Surface Roughness

Surface roughness decreases as the cutting edge angle is getting larger.

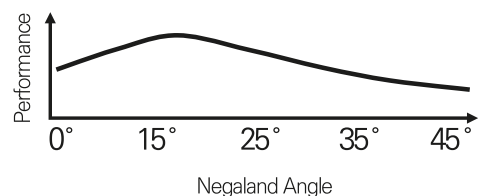



cBN Edge Treatment

cBN Test Comparison – Cutting Edge Treatment (Standard Type/F Type/T Type)

Workpiece(Round Bar) Information	
Size	Ø105X 150(mm)
Material	SCM415
Heat-treated	Carburization
Hardness	HRC58~62

Insert Information 2NU-CNGA120408			
Grade	Cutting Edge Treatment	Negaland	Honing
DB1000	Standard Type	0.12 X 25°	0.010
DB1000	FType	0.12 X 15°	0.010
DB1000	TType	0.12 X 35°	0.010

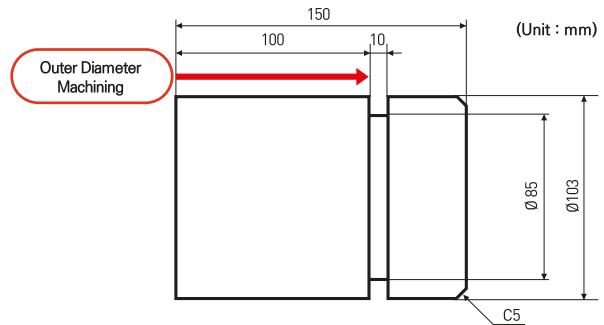

Results Analysis

- Wear Loss : T Type > Standard Type > F Type
- Surface Roughness : Standard Type > T Type > F Type
 - With 20 times of machining, surface roughness is machined at 8/12/20 times.
- Remarks :
 - Theoretically, F type (sharp type) is excellent in surface roughness, but under the machining condition of $V=200/f=0.1/ap=0.1$, the surface roughness due to initial chipping occurrence of F type is shown inferior.

Comparison of Surface Roughness			
Grade	8-times Machining	12-times Machining	20-times Machining
DB1000	Ra 0.431	Ra 0.477	Ra 0.492
DB1000F	Ra 0.629	Ra 0.754	Ra 0.821
DB1000T	Ra 0.496	Ra 0.545	Ra 0.584

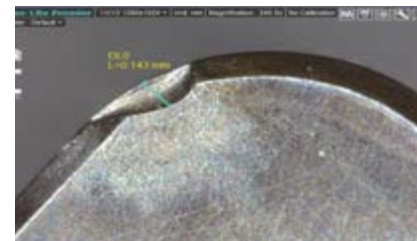
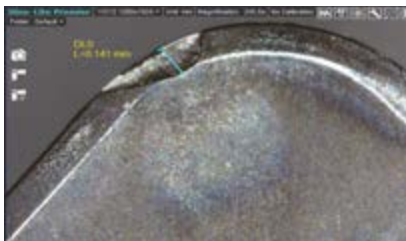
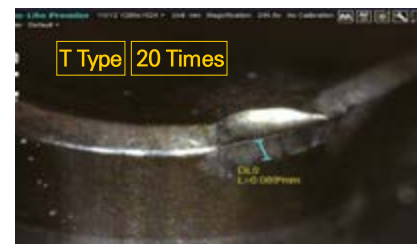
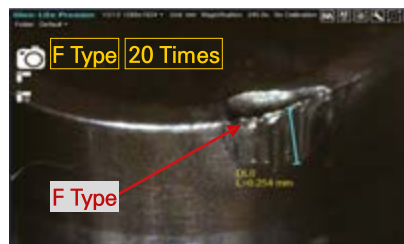
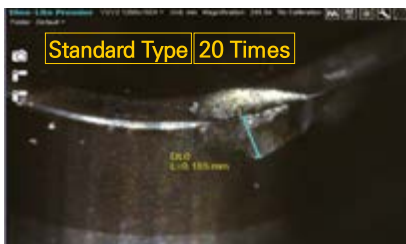



cBN Re-grinding

How to Select Re-grinding

1. Check for abnormality or brokenness through inspection
2. Classify re-grinding according to the size of an inscribed circle

Designation	Inscribed Circle			
	New Product(Before use)	Class B	Class C	Class D
CNMA1204 □□	12.7	12.5	12.3	12.1
DNMA1504 □□	12.7	12.5	12.3	12.1
VNMA1504 □□	9.525	9.4	9.3	9.2
DCGW11T3 □□	9.525	9.3	9.1	X
CCGW09T3 □□	9.525	9.3	9.1	X

Unit: mm

Machining Example

CNMA120408 → 0.2mm machined at one time machining

New Product (Before Use) / Re-grinding: 0 time /
Inscribed Circle: 12.7mm

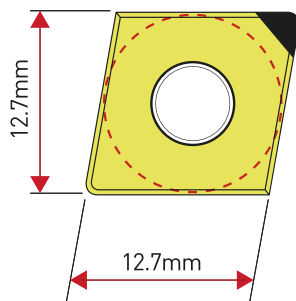

Class B / Re-grinding: 1 time / Inscribed Circle: 12.5mm

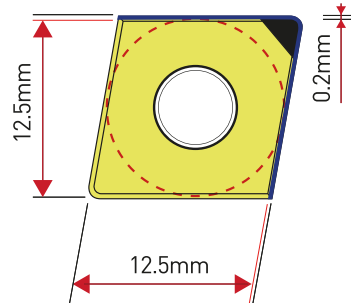

Class C / Re-grinding: 2 times / Inscribed Circle: 12.3mm

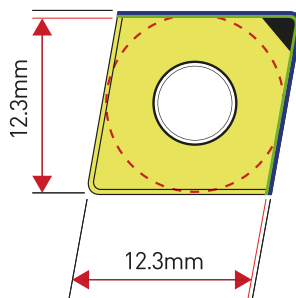

Class D / Re-grinding: 3 times / Inscribed Circle: 12.1mm

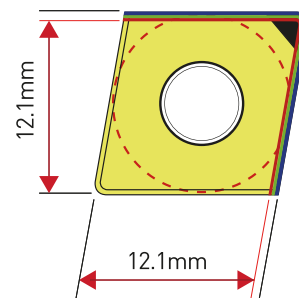

1:1 CHAT



PCD Chip Breaker(UC)

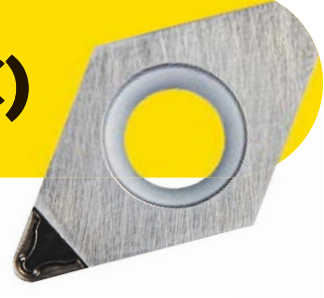

Features

- Productivity improved by resolving chip troubles
- Stable capacity to break chips in the large cutting area
- Excellent in machining aluminium and copper alloys
- Provides very high hardness and excellent wear resistance due to high-density combination of diamond polycrystallines

Performance Comparison Test

- Tool Designation: DCMT11T304-UC
- Workpiece: AL6061 (\varnothing 100*160L Outer Diameter Machining)
- Cutting Conditions: $V_c=500\text{m/min}$, $f=0.15\text{mm/rev}$, $a_p=0.2\text{mm}$, Dry Cutting

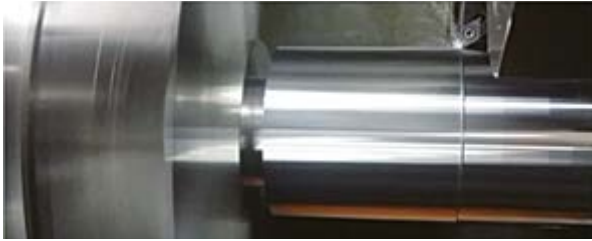

General Type PCD



UC Chip Breaker

Chip Breaker

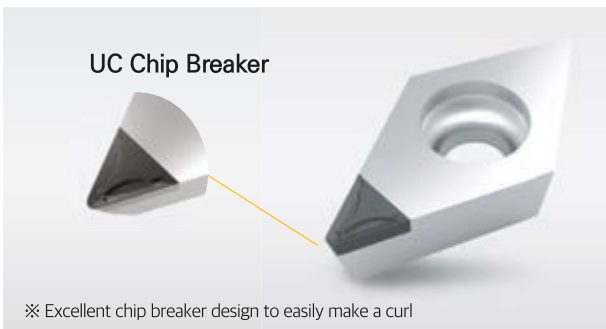

Applicable Area

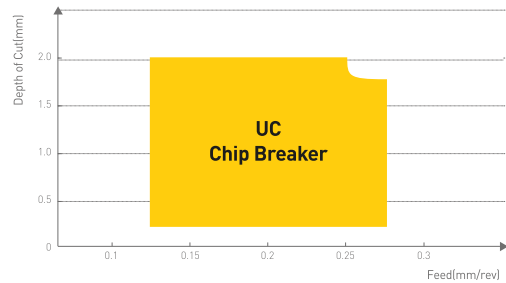

Shape of Chip

- Tool Designation: DCMT11T304-UC
- Workpiece: AL6061 (\varnothing 100*160L Outer Diameter Machining)
- Cutting Conditions: $V_c=500\text{m/min}$ Dry Cutting

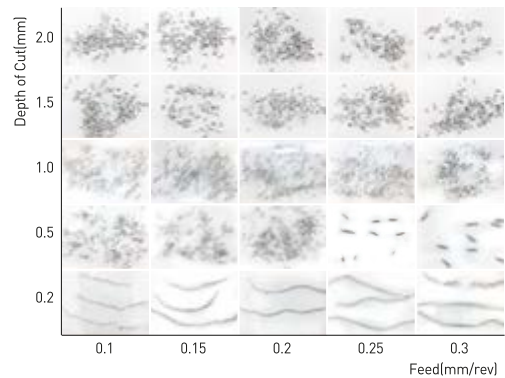

Comparison of Chip Rear Discharge

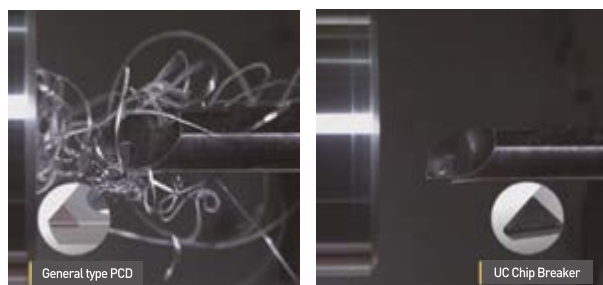



PCD Technical data

PCD Features

DINE PCD products provide very high accuracy and excellent wear resistance as they are manufactured by the ultrahigh temperature and ultrahigh pressure manufacturing process to combine diamond polycrystallines in high density. In addition, diamond crystal grain size control technology allows a wider range of machining applications. DINE PCD products provide excellent workpiece surface roughness, high machining accuracy and long tool service life.

- Excellent in machining aluminium alloys and copper alloys
- Excellent in machining ceramic, high Si-aluminium alloy, stone, etc.
- Excellent in machining rubber, carbon, graphite, wood, etc.

PCD Shape

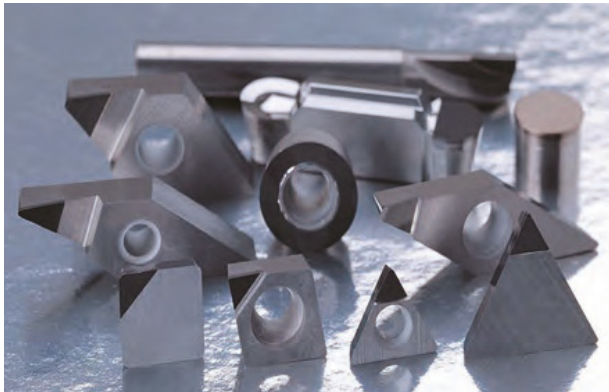

TN□□

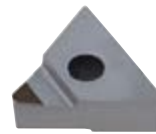

CC□□



SP□□

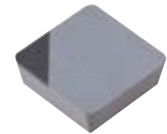

PCD Tool Technology Guide

1. PCD = Polycrystalline Diamond = Particle Sintered Diamond
2. Composition : [Diamond Crystal Grain + Diamond Additives (Metal, Ceramic)]
Sintering by high temperature and pressure (1200°C, 50K atm)
3. Particle Size : Ultrafine Particle (0.5μm) < Fine-grained Particle (10μm) < Rough Particle (More than 25μm)

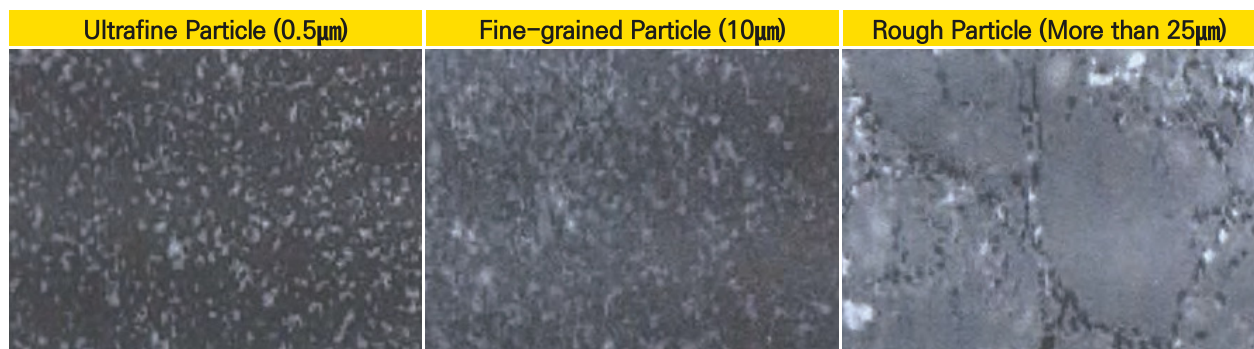

4. Application : Nonferrous Metals, Glass Fiber, Woodwork, High-hardness Plastic
5. Specification
 - 1) Rough Particle => High Density and Thermal Conductivity – Excellent wear resistance but weak surface roughness
 - 2) Cutting edge oxidation occurs in case of machining high-hardness materials at low oxidation temperature



PCD Technical Data

PCD

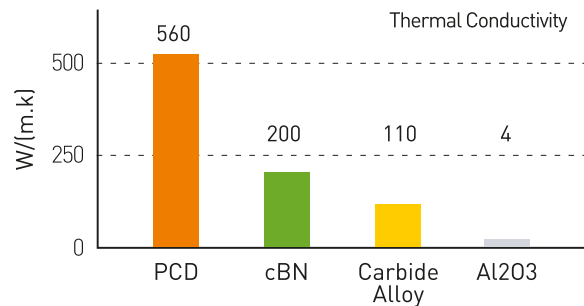
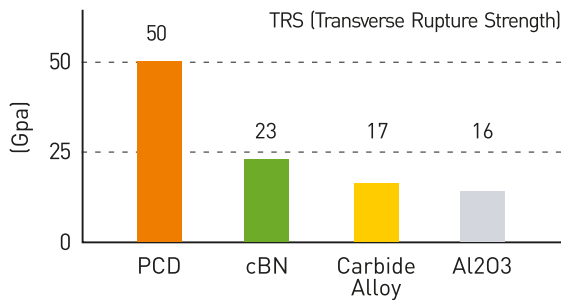

Comparison of cBN and PCD

		cBN	PCD
Thermal Stability	In Atmosphere	Stable up to 1300°C	Oxidized from 700°C
	In Vacuum	Stable up to 1500°C	Stable up to 1400°C
Applications		Heat-treated Steel, High-hardness Materials	Nonferrous Metals, Glass Fiber, Woodwork, High-hardness Plastic

PCD Grade

Grade	Features	Applications	Particle Size (μm)	Particle	Hardness (Hv)	Deflective Strength (kgf/mm ²)
DP90	The largest grade diamond content by sintering rough diamond particles; Excellent wear resistance	High silicon Al alloy machining, Al composite material machining, cemented carbide alloy machining, rough boring of cemented carbide alloy, ceramic semi-sintered parts, and compound products, ceramic sintered parts machining, stone and rock machining	≥25		10,000 ~ 12,000	110
DP150	The same-size grade diamond particle by sintering finegrained diamond particles; good coherent grade with workpiece machinability and wear resistance	General grinding machining of nonferrous metals; grinding surface machining of cemented carbide alloys, ceramic sintered parts, and compound products; crosssectional machining of FRP, hard rubber, graphite, wood, and mineral board, etc.	10		10,000 ~ 12,000	200
DP200	Good sharpness and excellent tenacity of grade cutting edge by sintering ultrafine diamond particles	General grinding machining of nonferrous metals; grinding surface machining of cemented carbide alloys, ceramic sintered parts, and compound products; crosssectional machining of FRP, hard rubber, graphite, wood, and mineral board, etc.	0.5		8,000 ~ 10,000	220



PCD Technical Data

Machining Example

Workpiece	Cutting Speed (m/min)	Feed (mm/rev)	Depth of Cut (mm)	Recommended Grade	
				1st	2nd
Aluminum Alloy (4%~8%Si)	1000~3,000	0.1~0.6	~3	DP150	DP200
Aluminum Alloy (9%~14%Si)	600~2,500	0.1~0.5	~3	DP150	DP200
Aluminum Alloy (15%~18%Si)	300~700	0.1~0.4	~3	DP150	DP200
Copper Alloy	~1,000	0.05~0.2	~3	DP150	DP200
Reinforced Plastic	~1,000	0.1~0.3	~2	DP150	DP200
Wood	~4,000	0.1~0.4	-	DP150	DP200
Cemented Carbide	10~30	~0.2	~0.5	DP90	DP150

Continuous Machining Test (Workpiece:Al-25%Si)

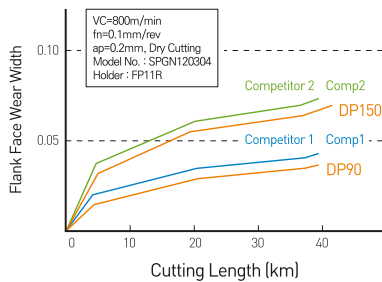

Interrupted Machining Test (Workpiece:Al-20%Si)

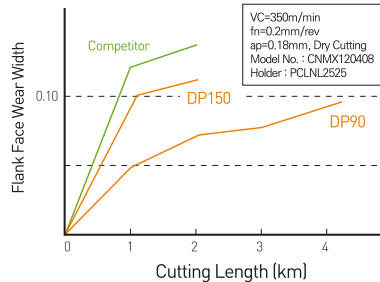

Continuous Machining Test (Workpiece:Al-25%Si)

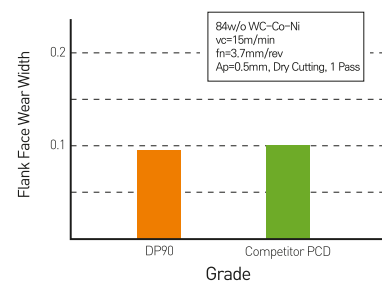

Machining Example

DP150

Grade	DP150	Competitor A PCD
Insert	DCMT11T304-UC	
Workpiece	Compressor Piston(AL A4000)	
Cutting Speed (m/min)	400~450	
Feed (mm/rev)	0.12	
Depth of Cut (mm)	1.0 ~ 1.5	
Dry/Wet Cutting	Wet Cutting	

DP200

Grade	DP200	Competitor A PCD
Insert	NF-SEN09T3ADTR	
Workpiece	Ring Spec. Outer Diameter(AL6061)	
Cutting Speed (m/min)	380	
Feed (mm/rev)	0.1	
Depth of Cut (mm)	0.15	
Dry/Wet Cutting	Dry/Wet Cutting	

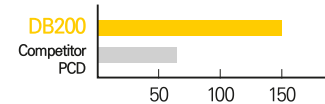
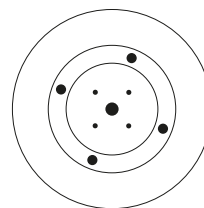
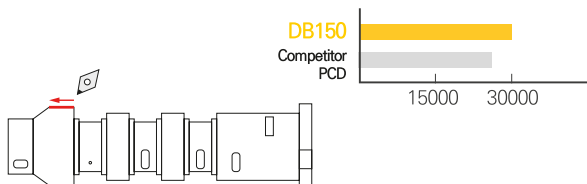



How to Indicate the Model No. of Insert

How to Indicate cBN Cutting Edge

Designation Example

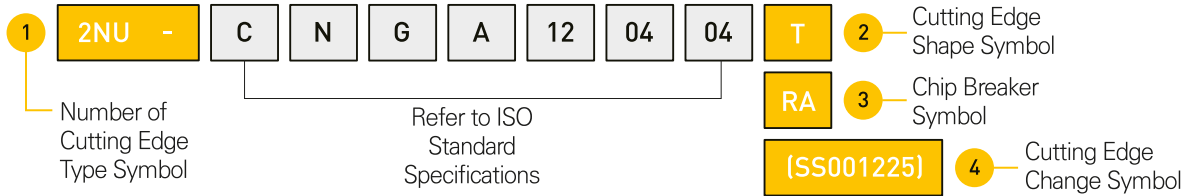

① Number of Cutting Edge Type Symbol

Symbol	Symbol Description		Shape	Item	Symbol Description		Shape
Number of Cutting Edge	None	1 Corner Type		Symbol	None	Re-grinding Type	
	2	Multi-corner Type			NU	One-use Type, Corner Type	
	3	Multi-corner Type			NT	NT Type	
	4	Multi-corner Type			NS	Full Solid Type	

② Cutting Edge Shape Symbol

Item	Symbol Meaning	Symbol Description		
None	Standard Type	ISO Standard Insert		
F	Low Resistance Type	Workpiece	Standard	F
		Heat-treated Steel Grade	25°	15°
		Cast Iron Grade	15°	0°
		Wiper Insert	15°	-
T	Cutting Edge Reinforced Type	Workpiece	Standard	T
		Heat-treated Steel Grade	25°	35°
		Cast Iron Grade	15°	25°
		Wiper Insert	15°	25°
W	Wiper Type	Wiper Insert		

③ Chip Breaker

	Roughing	Finishing		General-purpose
cBN			PCD	
	RA	GA		UC

④ Cutting Edge Change Symbol

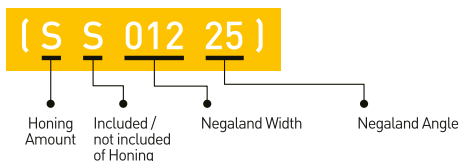

Honing Amount		Honing		Negaland Width	Negaland Angle
S	Small	S	Existence	0.12mm	25°
M	Medium	T	Non-existence	0.15mm	35°
L	Large			0.20mm	



Device & Accessory

DINE TOTAL TOOLING SOLUTION

PVT	300
PVTM	301
DVT	303
MVT	303
FVT	304
QPT	306
TAPER CLEANING DEVICE	307
MH-300	308
TOOL SHRINK BASIC	309
CLEAN-TEC FAN	312
PRECISION MICRO ADJUSTING CARTRIDGE	313
PSBW	313
TTC	314
TSC	314
TMB	315
DIGITAL 3D TASTER	316
3D TASTER 2007	316
HDG	317
DZH	318
DZP	318
DZOP	319
DOP	319
ROT	320
TB	321
SC	321
NTSS	322
PULL STUD BOLT	323
PSB-T (PULL STUD BOLT-T)	324

1:1 CHAT



PVT

MC Power Vise_PVT (Standard Type)



※ Based on PVT-160

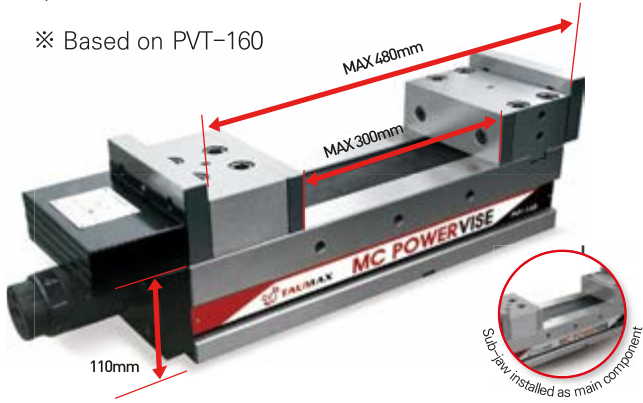

Features

- Apparatus type power increase device adopted
- Designed to minimize workpiece floating
- Height tolerance: 0.01mm, Can be used in parallel
- Built-in IN (18T) sub-jaw
- Durability enhanced by using high stiffness



Clamping Force

Grasp Step	Spec	PVT-100	PVT-130	PVT-160	PVT-200
Step1		1,000	1,500	2,000	2,500
Step2		2,000	2,500	3,000	3,500
Step3		3,000	3,500	4,000	4,500
Step4		3,500	4,500	5,000	5,500

(Unit: kgf)

How to Use



- 1 Fix the grip after tightening by the main handle
- 2 Pull the clamping force control grip toward the handle
- 3 Rotate the clamping force control grip from side to side to set the clamping force.

Main Components

Handle	Ratchet Handle	Internal Sub-jaw	Accessory

※ Handle and ratchet handle are not sold separately

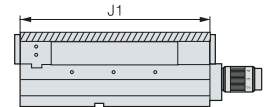
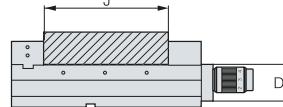
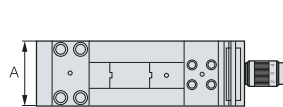
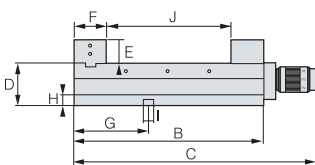

Designation	A	B	C	D	E	F	G	H	I	J	J1	Clamping Force(kgf)	Package Weight(kg)	Stock
PVT-100	100	310	442	85	50	75	110	25	18	150	300	3,500	28.5	●
PVT-130	130	410	542	100	55	80	135	25	18	240	400	4,500	45.5	●
PVT-160	160	490	622	110	60	85	200	25	18	300	480	5,000	68.3	●
PVT-200	200	530	662	110	60	85	220	25	18	350	520	5,000	91.4	●

(Unit : mm)

1:1 CHAT



PVTM

MC Power Vise_PVTM (Entry Type)



Features

- Easy-to-use entry type power vise
- Apparatus type power increase device adopted
- Height tolerance : 0.01mm, Can be used in parallel
- Built-in IN (18T) sub-jaw

※ Based on PVTM-160

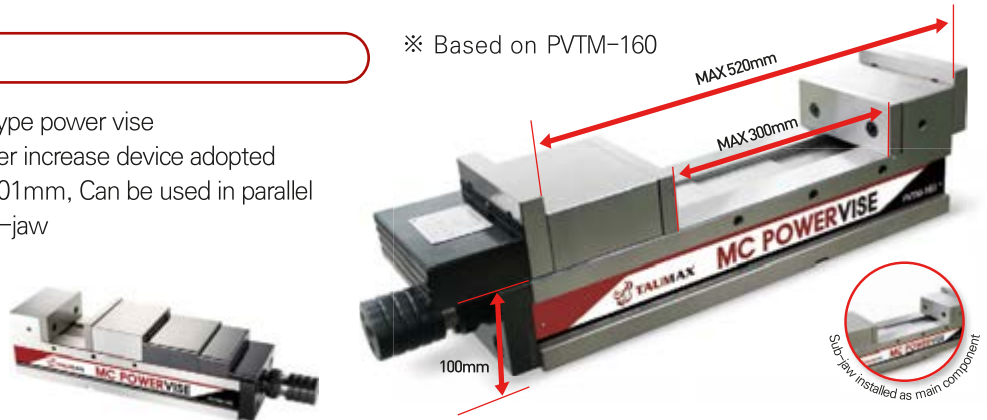

Clamping Force

Grasp Step	Spec			
	PVTM-100	PVTM-130	PVTM-160	PVTM-200
Step1	1,500	2,000	2,000	2,000
Step2	2,500	3,000	3,000	3,000
Step3	3,000	4,000	4,000	4,000
Step4	3,500	4,500	5,000	5,000

(Unit: kgf)

How to Use

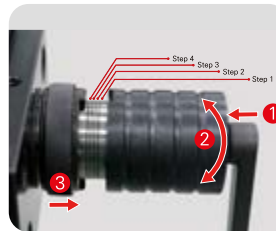

- 1 Push it to the workpiece using the ratchet handle, a main component
- 2 Apply instantaneous torque(rotation) to increase grasping power Pull out the workpiece by turning the ratchet handle in the opposite direction after machining
- 3 Be sure to use the clutch to clamp any hard workpiece (mild steel, aluminium, copper, acryl, etc.). Otherwise, the material of the workpiece may be strained.

Main Components

Handle	Ratchet Handle	Internal Sub-jaw	Accessory

※ Handle and ratchet handle are not sold separately

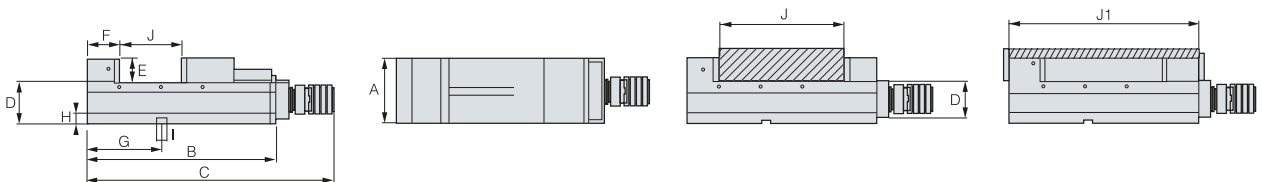

Designation	A	B	C	D	E	F	G	H	I	J	J1	Clamping Force(kgf)	Package Weight(kg)	Stock
PVTM-100	100	395	530	85	50	60	110	25	18	200	370	3,500	28	●
PVTM-130	130	470	605	100	55	75	160	25	18	250	450	4,500	45	●
PVTM-160	160	545	680	100	60	80	200	25	18	300	520	5,000	68	●
PVTM-160L	160	750	885	100	63	90	200	25	18	500	740	5,000	90	●
PVTM-200	200	615	740	110	60	95	220	25	18	350	590	5,000	91	●

(Unit : mm)

1:1 CHAT



ACCESSORIES

Power Vise Accessories



Guide Key

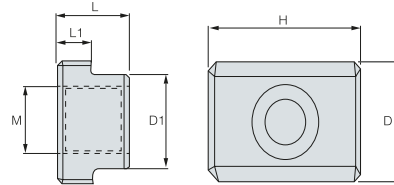

Designation	D1	D	H	M	L	L1
KEY-14MM	14	18	25	M6	12	6
KEY-18MM	18	18	25	M6	12	6

※ For 22mm guide key, please inquire us separately.

(Unit : mm)

IN/OUT Sub-jaw & Movable Jaw/Fixed Jaw



Item	Designation	Compatibility Classification
In/Out Sub-jaw	PVT-000 INSIDE JAWS	PVTM
	PVT-000 OUTSIDE JAWS	PVTM
Upper End Block	PVT-000 FIXED BLOCK	PVT
	PVT-000 SLIDER BLOCK	PVT

※ OUT sub-jaws are for separate purchase.

※ In sub-jaws can be compatible between standard type and entry type only in the models of 100 and 130.

Clamp Set

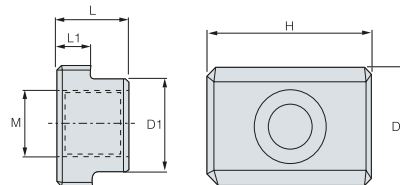

Designation	D1	D	H	M	L	L1	Compatible	Components
Clamp Set (T-NUT & Screw)	14	22	28	M12*1.75(S)	16	8	PVTM-100	T-NUT/ Washer Clamp/ Bolt 4EA
	16	25	28	M12*1.75(M)	16	8	PVTM-100,130	
	18	28	31	M12*1.75(L)	19	11	PVTM-160,200	

(Unit : mm)

1:1 CHAT



DVT

Double Lock & Anglock Vise_Double Vise TAUMAX

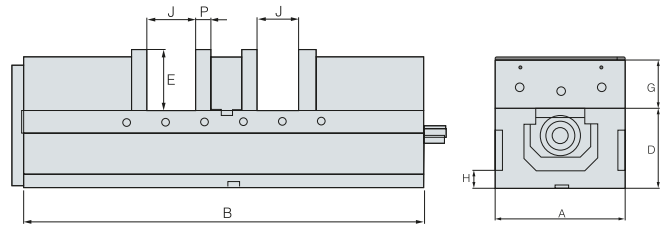

Features

- 5 ways of clamping by changing jaws position
- Max opening 70mm for each jaws, 136mm max for single piece clamping
- High-hardened / Heat-treated steel body with Hrc hardness 50, height tolerance 0.01mm
- Anti-lifting structure

Designation	A	B	D	E	G
DVT-160	160	500	160	63	60
	H	P	J	Package Weight(kg)	Stock
	23	18	70	64	●

(Unit : mm)

Main Components

Serrated Jaws	Wrench	Clamp x4 Guide Key x2	Screw Support Block

You can clamp the workpiece by the below five methods.

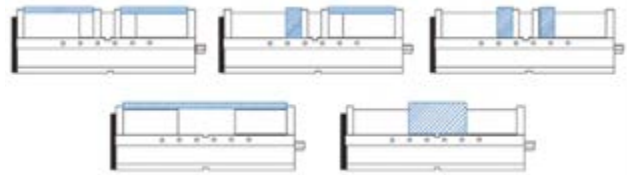

1:1 CHAT



MVT

MC Machine Vise TAUMAX

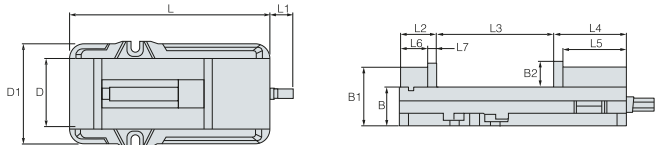

Designation	L	L1	L2	L3	L4	L5	L6	L7	D
MVT-154	438	56	70	225	141	123	52	18	154
	D1	B	B1	B2	Width	Clamping Force(kgf)	Package Weight(kg)	Stock	
	230	73	111	44.5	6inches	1,000	31	●	

(Unit : mm)

Features

- Handy for use, versatile
- Provides a wide machining range (Max. opening width: 225mm)
- Durability improved with hard materials
- Height tolerance considered, Can be used in parallel

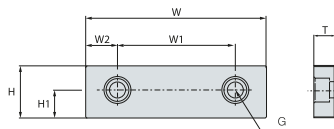

Designation	W	W1	W2	H
MVT-154 Sub Jaws	152	98.4	26.7	44.5
	H1	G	T	
	23.8	M12x1.75P	18	

(Unit : mm)

Main Components

Wrench	Inside Jaws

Accessories



Designation	Compatible
Swivel Base for MVT-154	MVT-154

1:1 CHAT



FVT

Centering Vise



Features



- Best economic clamping solution for machining
- Heat-treated / High alloy steel base structure to provide excellent wear-resistance and high anti-tension
- Optimized to be used on high-quality machining process
- Standard serrated jaw with a clamping width of 3.5mm; Alternative jaws are available upon customers' request
- Maximum clamping force 1,200kgf at 75kN
- Height tolerance within 0.01mm
- Repeatability within 0.01mm or less for versatile and high level machining
- Easy to assemble and disassemble thanks to its modular structure



Main Components

Self-Centering Vise	Wrench, Clamp x4, Guide Key x2	User Manual
		

Features

Handy Replace of Parts thanks to Modular Structure	Minimized Interference	Wide Variety of Jaws
		

※ Jaws are not included in vise, so please choose types of jaws which you are going to use.

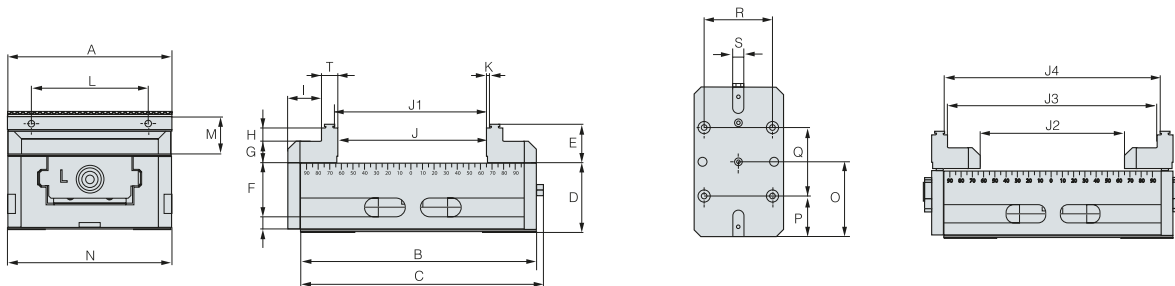

Designation	A	B	C	D	E	F	G	H	I	T	K	L	M
FVT-77	77	130	135	38	27	10	13	11	23	12	3	135	19
FVT-125	125	210	215	57	32	12	18	11	28	14	3	90	24

Designation	NO	O	P	Q	R	S	J	J1	J2	J3	J4	Clamping Force(kgf)	Package Weight(kg)	Stock
FVT-77	78	65	39	52	52	16	60	66	60	106	112	1,000	4	●
FVT-125	126	104	57	96	96	16	126	132	126	182	188	1,500	11	●

(Unit : mm)

1:1 CHAT



ACCESSORIES

Jaws_Sub Jaws



Serrated Jaws

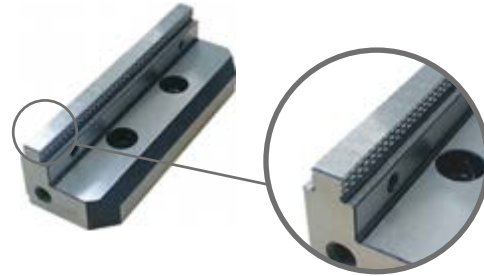
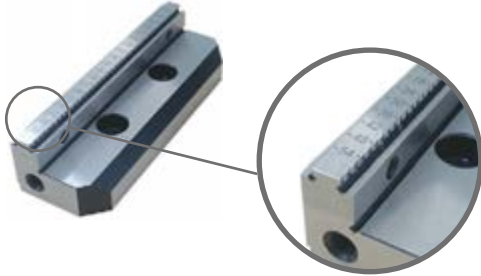

Single Serrated Jaws

- Teeth height 3mm
- Material : SCM440
- Versatile
- Minimize interference and excellent clamping assistance thanks to its serrate

3 Steps Serrated Jaws

- Teeth height 7mm
- Material : SCM440
- Effective on thick and heavy weight material

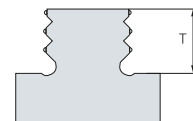
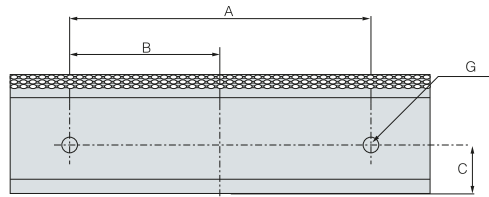
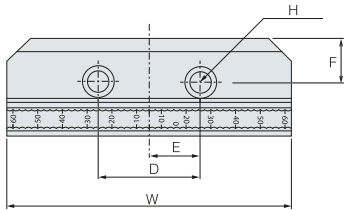

For	Designation	A	B	C	D	E	F	G	H	T	W	Material	Package Weight(kg)	Stock
FVT-77	Single Serrated Jaws	60	30	16	24	12	16	M4x0.7	∅6.5	3	77	SCM440	1	●
	3 Steps Serrated Jaws	60	30	16	24	12	16	M4x0.7	∅6.5	7	77	SCM440	1	●
FVT-125	Single Serrated Jaws	90	45	15	45	22.5	19	M5x0.8	∅9	3	125	SCM440	1	●
	3 Steps Serrated Jaws	90	45	15	45	22.5	19	M5x0.8	∅9	7	125	SCM440	1	●

(Unit : mm)

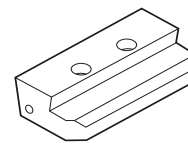
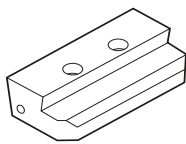

General Sub-jaw

- Material : AL -6061
- Both sides available for use
- For soft material
- Customer can customize easily as necessary
- Wide width 60mm for user customizing

General Sub-jaw

- Material : SCM440
- Both sides available for use
- For general material clamping
- Customer can customize easily as necessary
- Wide width 60mm for user customizing

1:1 CHAT



QPT

NEW

Quick Point System for 5-axis Vise



QPTA-96



QPTB-96

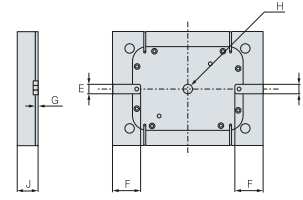
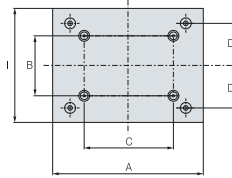

Features

- Fast and easy vise floating enabled with four stud bolts
- Supports up to 6 tons with a 96mm distance between bolts and four pull-stud bolts
- Easy vise clamping with a mechanical pin system using a single wrench clamping
- Height tolerance within 0.01mm when clamping
- Compatible with 4-axis rotary and 5-axis tilting/rotary beds

Designation	A	B	C	D	E	F	G	H	I	J	Clamping Force(kgf)	Package Weight(kg)	Stock	Item
QPTA-96	192	96	150	63	20	35	6	12	192	27	6000	7.0		T Nut-fixed Type
QPTB-96	192	96	150	63	20	35	6	12	192	27	6000	6.4		Screw-fixed Type

(Unit : mm)

Main Components

Ratchet Handle x1



M10x35L Screw x4



Pull Stud Bolt x4



Accessory



1:1 CHAT



TAPER CLEANING DEVICE

Taper Cleaning Device



Features

- Improves accuracy by cleaning Taper
- Increases the life cycle of tool
- Protects the spindle of equipment
- Maintains accuracy of the contact surface for a long time
- Compact design and timer function



Item	Designation	Diameter	Height	kg	Compatible	Power Supply	Stock	Power Consumption
Lower Basis	Taper Cleaning Drive Unit	300	140	11	-	110-240VAC	●	Max.150 W
Upper Cleaning Part	Cleaning Attachment ISO 30	230	160-190	10	BT/SK/CAT30	-	●	-
	Cleaning Attachment ISO 40				BT/SK/CAT40	-	●	-
	Cleaning Attachment ISO 50				BT/SK/CAT50	-	●	-
	Cleaning Attachment HSK-63				HSK-63	-		-
	Cleaning Attachment HSK-100				HSK-100	-		-

(Unit : mm)

Accessory

Item	Designation	Compatible
Spare Brush	Spare Brush ISO 30	BT/SK/CAT30
	Spare Brush ISO 40	BT/SK/CAT40
	Spare Brush ISO 50	BT/SK/CAT50
	Spare Brush HSK-63	HSK-63
	Spare Brush HSK-100	HSK-100



1:1 CHAT



MH-300 ^{NEW}

Shrinking Device



Features

- Compatible for steel and SUS holders
- Presets for 10 frequently used tool diameters can be saved
- Interchangeable heating coils for small(35mm) and large(58mm) diameters
- Standard BT30/BT40/HSK63 compatible, other shanks available (optional)
- Prevents overheating and enables manual cooling through settings

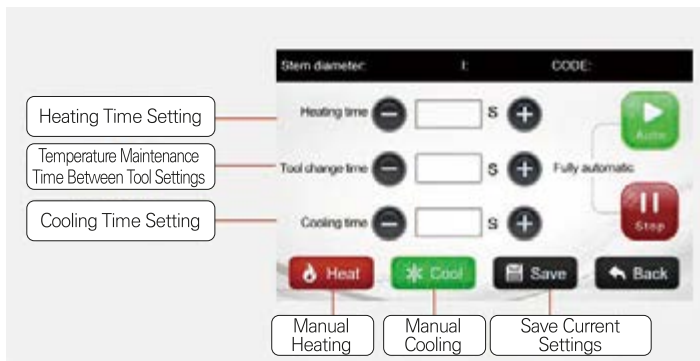

Designation	WxLxH(mm)	Power Supply	Max. Frequency (KHz)	Max. Power Consumption (kW)	Axis Operation Range (mm)	Basic Applicable Hole Diameter (mm)	Packaging Weight (kg)	Stock
MH-300	500*430*750mm	Single phase AC 220V (50Hz)	40	3.2	440	Ø3-Ø12	28	●

1:1 CHAT



ACCESSORIES

Accessories



Item	Designation	Size(mm)	Provision Status	Stock
Heating Coil	Induction Coil (Thin)	Ø35 (for hole diameter of Ø3-Ø12)	Standard	●
	Induction Coil (Thick)	Ø58 (for hole diameter of Ø3-Ø32)	Option	●
Adapter	Flange Ring BT30	BT30	Standard	●
	Flange Ring BT40/HSK-A63	BT40, HSK-A63	Standard	●
	Flange Ring HSK-AE50/F63	HSK-A50, E50, F63	Option	●
Stopper	STP-4,6,8,10,12	Ø4,6,8,10,12	Standard	●

※ Induction Coil (Thin) basically installed

1:1 CHAT



TOOL SHRINK BASIC NEW

Shrinking Device

TOOL SHRINK BASIC is a product that uses maximum 16kW of power for a safe and quick shrink-fitting process.

Features

- It is equipped with a “smart coil” that adjusts power and time according to the thickness of the tool holder, automatically adjusting heating time and power optimized for each holder
- Improved holder life by automatically adjusting the amount of power from 7 to 16kW to prevent overheating of the holder
- Applicable at Ø3-Ø32 without coil replacement, fast shrinking is possible regardless of holder material (normal steel , SUS) or tool material (HSS, hard metal)
- Easy keypad use
- High concentricity
- Customization of heating using Wi-Fi is possible through Evo-Pi PC
- Online support service is available



Designation	Volume [WxLxH (mm)]	Power Consumption (kW)	Power Supply (V)	Basic Shank	Basic Cooling Time	Applied Tool Outer Diameter (mm)	Pressure (bar)	Weight (kg)
TOOL SHRINK BASIC	955x317x920(device) 1061x317x920(support installed)	7~16	3phase 380 (50-60Hz)	BT40, 50 HSK63A, 100A	5-7minutes (based on air cooling)	Ø3-Ø32mm	3~6	46

Basic Accessories

TOOL SHRINK BASIC Body	Basic Adapter	Air Cooling Conditioner	Heat-resistant Gloves
			

1:1 CHAT



ACCESSORIES

Accessories

	<p>Cooling Adapter</p>	<p>SK30, SK40, SK50 HSK-E25 ACE 32, 40, 50, 63, 80</p>
	<p>Heat Focusing Stopper</p>	<p>Ø3-Ø6 Ø8-Ø14 Ø16-Ø18 Ø20-Ø25 Ø32</p>
	<p>Cooling Manager A(Power-Air)</p>	
	<p>Cooling Box for 5 Shrink Holders</p>	
	<p>Adapter Ring</p>	<p>SK30, SK40, SK50 HSK-E25 ACE 32, 40, 50, 63, 80</p>

Chuck

Arbor/Modular

Boring Tool

Angular Head

cBN/PCD

Device&Accessory

Standard

1:1 CHAT



CLEAN-TEC FAN

Cleaning Fan



Coolant System

Features

- Removes chips without opening/closing the door of CNC equipment
- Improved stability through operations without operator intervention
- Electricity cost reduction by eliminating compressed air
- Increased production efficiency through the compatibility with ATC and the connection with automated facilities



Designation	ØD(Unfolded)	Ø Shank	Max.RPM	Package Weight(kg)	Stock
Clean-Tec 160	160	20	12,000	0.2	●
Clean-Tec 260	260	20	8,000	0.2	●
Clean-Tec 330	330	20	8,000	0.5	●

(Unit : mm)

1:1 CHAT



ACCESSORIES

Accessories



Photograph of Use



Designation	Components	Compatible
Spare Part Kit for Clean-Tec 160	Blade/Spring 4EA	Clean-tec 160
Spare Part Kit for Clean-Tec 260	Blade/Spring 4EA	Clean-tec 260
Spare Part Kit for Clean-Tec 330	Blade/Spring 4EA	Clean-tec 330

(Unit : mm)

1:1 CHAT



PRECISION MICRO ADJUSTING CARTRIDGE

Precision Micro Adjusting Cartridge

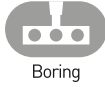

Boring



Features

- Both left-hand and right-hand versions available, internal coolant type
- Available minimum boring diameter: 28.00mm
- 90-degree, 95-degree lead angle versions
- Unit diameter adjustable up to 0.01mm within the radial adjustment 0.3mm(1 gradation adjustment radius: 0.005mm)
- Axial range adjustable : 1.0mm

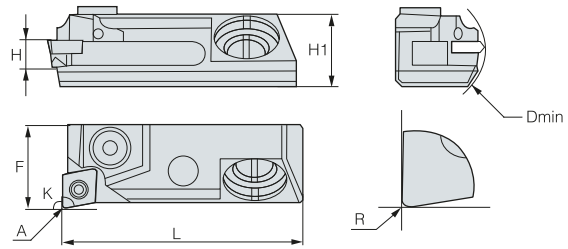

Designation	K	H	F	L	H1	Dmin	R	Applicable Insert	Package Weight(kg)	Stock
TMCR90-F16-CC06	90°	8.8	16	45.8	13.5	28	0.4	CC.0602.	1	●
TMCL90-F16-CC06	90°	8.8	16	45.8	13.5	28	0.4	CC.0602.	1	
TMCR95-F16-CC06	95°	8.8	16	45.8	13.5	28	0.4	CC.0602.	1	
TMCL95-F16-CC06	95°	8.8	16	45.8	13.5	28	0.4	CC.0602.	1	●
TMCR90-F16-TP09	90°	8.8	16	45.8	13.5	28	0.4	TP.0902.	1	●
TMCL90-F16-TP09	90°	8.8	16	45.8	13.5	28	0.4	TP.0902.	1	
TMCR/L95-F16-TP09	95°	8.8	16	45.8	13.5	28	0.4	TP.0902.	1	
TMCR90-F20-TC11	90°	8.8	20	45.8	13.5	36	0.4	TC.1102.	1	●
TMCL90-F20-TC11	90°	8.8	20	45.8	13.5	36	0.4	TC.1102.	1	
TMCR/L95-F20-TC11	95°	8.8	20	45.8	13.5	36	0.4	TC.1102.	1	
TMCR/L90-F20-TP11	90°	8.8	20	45.8	13.5	36	0.4	TP.1103.	1	
TMCR/L95-F20-TP11	95°	8.8	20	45.8	13.5	36	0.4	TP.1103.	1	
TMCR90-F22-CC09	90°	7.5	22	54.8	17.0	34	0.4	CC.09	1	
TMCR120-F16-DC07	120°	5.0	16	48.6	13.5	34	0.4	DC.07	1	

(Unit : mm)

1:1 CHAT



PSBW

Pull Stud Bolt Wrench



Features

- Fully compatible with pull stud bolts of each specification
- Solid design
- Conveniently fasten and disassemble pull stud bolts without using an adjustable spanner

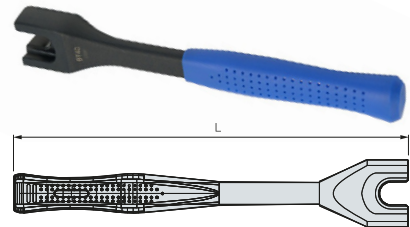
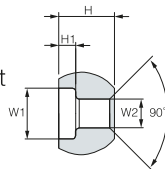

Designation	L	H	H1	W1	W2	Torque (N·m)	Package Weight(kg)	Stock
PSBW-30	210	16	5	13	7	≤80	0.5	●
PSBW-40	230	25	6	19	10	≤150	0.5	●
PSBW-50	280	33	10	30	17	≤280	1	●
PSBW-40(PS-805)	230	20.5	7	19	14	≤150	0.5	●
PSBW-40(PS-G51)	240	13	5	19	13	≤150	0.5	●
PSBW-50(PS-G41)	290	17	8	30	21	≤280	1	●

(Unit : mm)

1:1 CHAT



TTC

Tool Setting Stand



Features

- For cutting tool and pull stud bolt tightening
- Enables more convenient and easier tightening in case of tool tightening using a 45-degree type
- Provides work stability by heavier load (3kg) than rival products

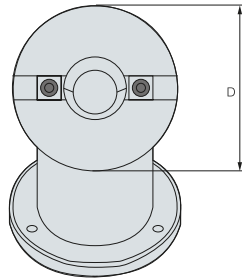
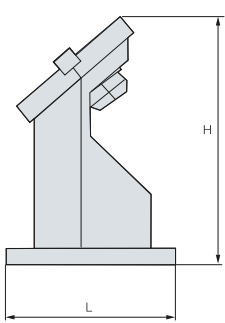

Designation	Compatible	L	H	D	Package Weight(kg)	Stock
TTC30	BT30, NT30	119	169	114	3	●
TTC40	BT40, NT40	119	169	114	3	●
TTC50	BT50, NT50	119	169	114	3	●

(Unit : mm)

1:1 CHAT



TSC

NEW

T-Slot Cover



Features

- Silicon material can be used after cutting it into the required size
- Flameproof treatment enables excellent corrosion resistance and allows for long-term use
- Optimized design for the T slot shape



Designation	Width (mm)	Total Length (m)	Material	Compatible (mm)	Package Weight(kg)	Stock
TSC-14	14	3	Silicon	14 slot	0.5	●
TSC-18	18	5		18 slot	0.9	●

1:1 CHAT



TMB

Magnetic Base



Features

- Strong adsorptive power (80kgf)
- Smooth and precise joint movement
- Ensures lightness and precision as a multi-joint model with a full aluminum body



TMB-B



TMB-BV



TMB-330

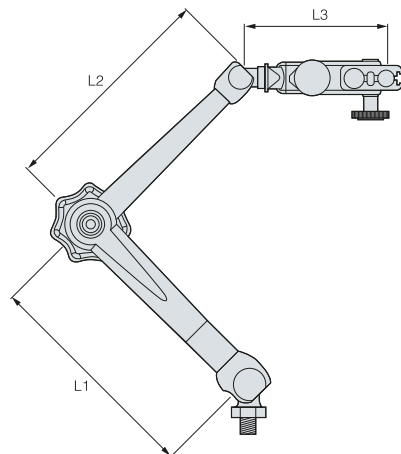
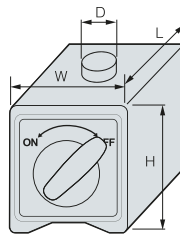
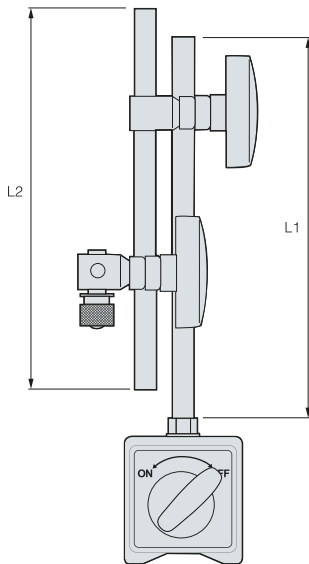

Designation	Item	Adsorptive Power(kgf)	L1	L2	L3	(L*W*H)	D	Package weight(kg)	Stock
TMB-B	Basic Type	80	170*Ø12	160*Ø10	-	60*50*55	M8*1.25	2	●
TMB-BV	Basic Type (Fine Adjustment)	80	170*Ø12	160*Ø10	-	60*50*55	M8*1.25	2	●
TMB-330	Multi-joint Type	80	130*Ø12	130*Ø10	70	60*50*55	M8*1.25	2	●

(Unit : mm)

Chuck

Arbor/Modular

Boring Tool

Angular Head

cBN/PCD

Device&Accessory

Standard

1:1 CHAT



DIGITAL 3D TASTER

Digital 3D Taster

Features

- High measurement accuracy: 0.01mm
- Display indication unit: : 0.005mm
- Easy to check measured values through a highly visible display
- Omnidirectional movement and measurable stylus
- Highly waterproof and shockproof structure (IP65 class)
- Convenient and simple concentricity adjustment
- Compatible with conventional styluses
- -, + indicated according to movement direction based on zero reference
- Built-in CR2032 battery



• ● : Stock

X,Y,Z axes Driving range	Measurement Unit	Display Range	Zero Accuracy	Zero Repetitive Accuracy	Clamping Shank	Battery Classifications	Weight(g)	Stock
-2/ to 4	0.005 (5µm)	±2	±0.01	±0.005	Ø16	CR2032	520	●

(Unit : mm)

1:1 CHAT



3D TASTER 2007

3D Taster

Features

- High measurement accuracy: 0.01mm
- Easy zero adjustment
- Highly waterproof and vibration proof structure (IP67 class)
- Screw-type stylus prevents the stylus from falling out by vibration and shock
- Simple and accurate radial run-out measurement radial run-out measured directly from the lower part of the scanning arm
- Radial direction and axial direction measurable with one indicator

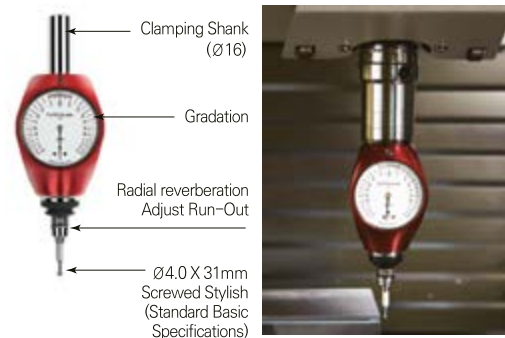

• ● : Stock

Measurement Unit	Measurement Precision	Clamping Shank	Weight(g)	Stock
0.01	0.01	Ø16	397	●

(Unit : mm)

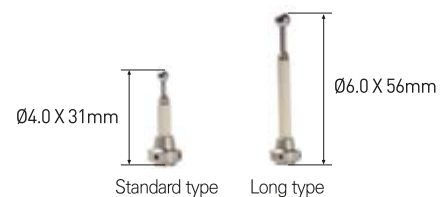

1:1 CHAT



HDG

Hydraulic Expansion Chuck Gauge

Features

- Able to minimize the error rate due to lowered clamping force of the hydraulic chuck
- A gauge for a hydraulic chuck that is able to determine whether the clamping force is normal or not before processing
- Able to prevent defective processing caused by tool fallout

NAMING

HDG
Hydraulic Expansion Chuck Gauge

20
Tool Dia.

How to Measure Clamping Force

How to check if the hydraulic chuck is out of order by using HDG

1. Assemble the head fitting the hydraulic chuck's internal diameter with the body
2. Insert into the hydraulic chuck and set to "0" on the dial gauge.
3. After clamping the hydraulic chuck, check if the clamping force of the hydraulic chuck is normal or not based on the movement of the dial gauge.

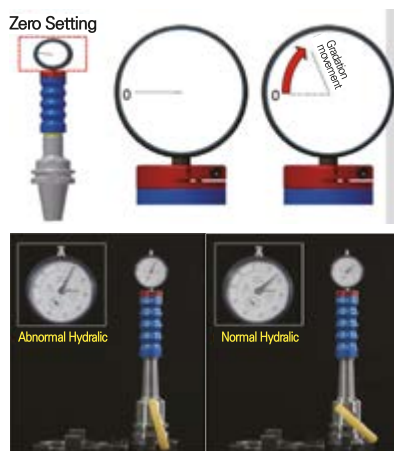

- ※ After observing an increased volume, always check the table and determine whether to use the hydraulic chuck or not
- ※ Not compatible with other companies' hydraulic chucks

● : Stock

- ※ The measured value is based on the DINOX hydraulic chuck, and there may be a difference in specific values of other companies' products.
- ※ If the value is measured below the inspection range, please contact the place of purchase.

Designation	Hydraulic Chuck Tool Dia	Usable Range	Inspection Range	Stock
HDG-6	Ø6	More than 80	70µm~80µm	●
HDG-7	Ø7	More than 80	70µm~80µm	●
HDG-8	Ø8	More than 80	70µm~80µm	●
HDG-9	Ø9	More than 120	110µm~120µm	●
HDG-10	Ø10	More than 100	90µm~100µm	●
HDG-12	Ø12	More than 120	110µm~120µm	●
HDG-14	Ø14	More than 150	140µm~150µm	●
HDG-16	Ø16	More than 150	140µm~150µm	●
HDG-18	Ø18	More than 150	140µm~150µm	●
HDG-20	Ø20	More than 160	150µm~160µm	●
HDG-25	Ø25	More than 190	180µm~190µm	●
HDG-32	Ø32	More than 160	150µm~160µm	●



Operation

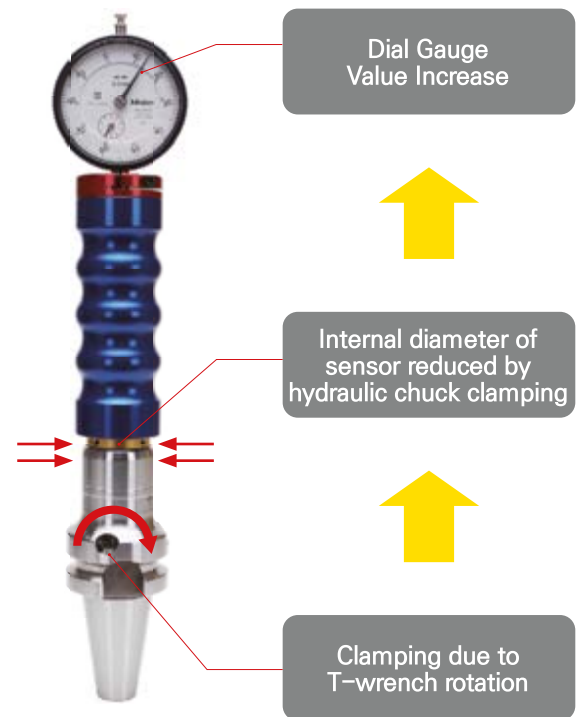

Chuck

Arbor/Modular

Boring Tool

Angular Head

cBN/PCD

Device&Accessory

Standard

1:1 CHAT



DZH

DINE Z Axial Height Gauge

Features

- For setting up the tool Z axis of MCT
- Design setting height : $50.00 \pm 0.005\text{mm}$
- Wide plane face, easy operation
- Relatively less spring ejection and designed to prevent the milling cutter or bite from breaking
- Using a polished parallel plate enables an easy setting.
- Good parallelization degree, quick use response to each direction, and good accuracy
- Easy adjustment of the height of the measuring stand.
- Using a hexagonal wrench enables an immediate zero (0) adjustment.
- Magnetic attachment type



- ● : Stock

Designation	Height(mm)	Weight(kg)	Size(mm)	Stock
DZH-50	50.00 ± 0.005	1.2	$\varnothing 63 \times 50$	●

1:1 CHAT



DZP

Dine Z Axial Setting Height Gauge

Features

- For setting up the tool Z axis of MCT
- Design setting height: $100.00 \pm 0.005\text{mm}$
- Wide plane face, easy operation
- Enables relatively less spring ejection; prevents the milling cutter or bite from breaking
- Using a polished parallel plate enables an easy setting.
- Good parallelization degree, quick use response to each direction, and good accuracy
- Magnetic attachment type



- ● : Stock

Designation	Height(mm)	Weight(kg)	Size(mm)	Stock
DZP-100	100.00 ± 0.005	0.73	$\varnothing 50 \times 100$	●

1:1 CHAT



DZOP

Dine Z Axial P Reset Gauge

Features

- For setting up the tool Z axis of MCT
- Design height : 50.00
- Wide plane face, easy operation
- Relatively less spring ejection and designed to prevent the milling cutter or bite from breaking
- Using a polished parallel plate enables an easy setting
- Good parallelization degree, quick use response to each direction, and good accuracy
- It emits light when touched
- Magnetic attached type



- ● : Stock

Designation	Height(mm)	Weight(kg)	Size(mm)	Stock
DZOP-50	50	0.6	Ø53X50	●

1:1 CHAT



DOP

Dine Optical Edge Finder

Features

- Long-time no rust as it is waterproof treated on the whole
- Note : An optical laser type cardiopulmonary system is not suitable for rotation applications
- It sounds an alarm when touched



- ● : Stock

Designation	Weight(kg)	Accuracy(mm)	Size(mm)	Stock
DOP-20B	0.3	±0.005	Ø20X158	●

Chuck

Arbor/Modular

Boring Tool

Angular Head

cBN/PCD

Device&Accessory

Standard

1:1 CHAT



ROT

Run-out Tester

ISO



Shank

200mm=3μm

Features

- **Compatible with various shanks; provides diverse lineups**
 - Compliant with ISO30~ISO50 (ISO: BT,SK, NT,CAT) affordable general type and multi-type that can measure the cutting edge height and outer diameter simultaneously



Designation

Designation		Main Components				Accessories	
ROTS	ROTM	Shank	Body	Housing	Retainer	ARM	Indicator
ROTS-ISO15	ROTM-ISO15	ISO15	ROTM-BD (Multi-type)	ROT-HS-ISO15	ROT-RTB-ISO15	MB-1030-2	DIAL GAUGE (0.002mm)
ROTS-ISO20	ROTM-ISO20	ISO20		ROT-HS-ISO20	ROT-RTB-ISO20		
ROTS-ISO25	ROTM-ISO25	ISO25		ROT-HS-ISO25	ROT-RTB-ISO25		
ROTS-ISO30	ROTM-ISO30	ISO30	ROTS-BD (General type)	ROT-HS-ISO30	ROT-RTB-ISO30		
ROTS-ISO40	ROTM-ISO40	ISO40		ROT-HS-ISO40	ROT-RTB-ISO40		
ROTS-ISO50	ROTM-ISO50	ISO50		ROT-HS-ISO50	ROT-RTB-ISO50		

Simple Measurements



- ① After Inserting the Tool
- ② Check R/O by turning the tool

※ Measure run-out easily by inserting and turn the tool

Convenient Horizontal Adjustment Function (ROTM)

Can check horizontality by the level installed.



ROTS – General Type (~Ø150)

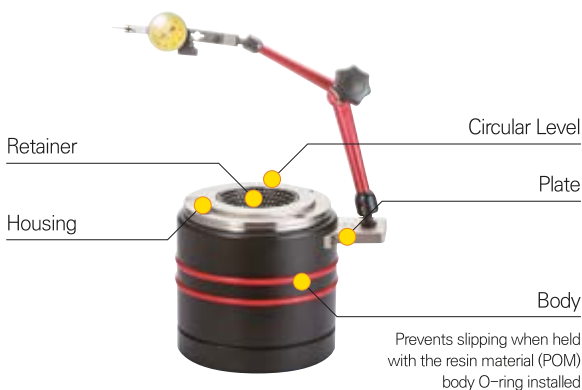

ROTM – Multi Type (~Ø400)



1:1 CHAT



TB

Test Bar

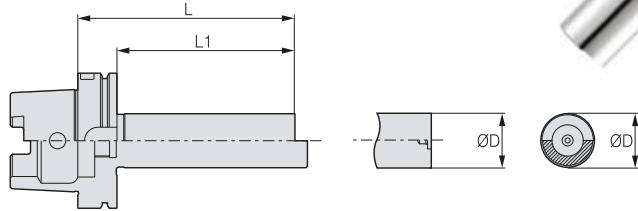

● : Stock

Shank	Designation	ØD	L	L1	Stock
BT	BTN30-TB30-200	30	200	198	●
BT	BTN40-TB50-300	50	300	298	●
BT	BTN50-TB50-300	50	300	298	●
HSK	HSK40A-TB25-200	25	200	180	
HSK	HSK50A-TB32-250	32	250	224	
HSK	HSK63A-TB40-300	40	300	274	●
HSK	HSK100A-TB40-350	40	350	321	●

(Unit : mm)

1:1 CHAT



SC

Spindle Cleaner

Features

- Made from sheepskin. By cleaning the inside of the spindle, it prevents spindle damage and static electricity, extending the life of the spindle.



● : To be switched to NP order after stock depletion

● : Stock

Designation	Shank	Weight(Kg)	Package Weight(kg)	Stock
SC-BT30	BT30	0.06	0.08	●
SC-BT40	BT40	0.07	0.1	●
SC-BT50	BT50	0.16	0.2	●
SC-HSK50	HSK50	0.08	0.12	●
SC-HSK63	HSK63	0.1	0.13	●
SC-HSK100	HSK100	0.5	0.7	●

1:1 CHAT



NTSS

New Tool Setting Stand

Features

- Made of aluminum alloy
- Two types Vertical or Horizontal available
- All of BT, CAT, SK available

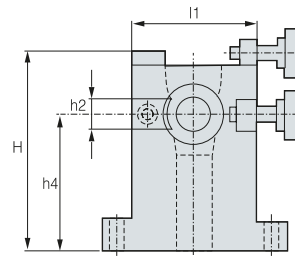
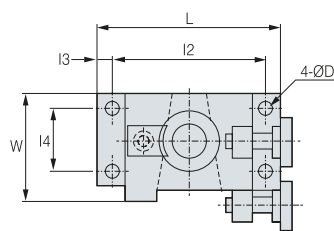

• ● : Stock

Designation	Shank	L	I1	I2	I3	I4	H	W	Package Weight(kg)	Stock
NTSS-30	BT30	95	65	80	7.5	33	100	58	1	●
NTSS-40	BT40	118	77	99	9.2	44	130	75	1.7	●

(Unit : mm)

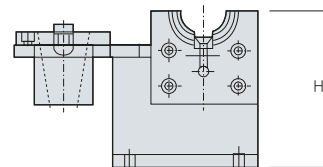
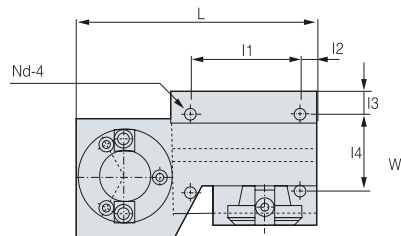

• ● : Stock

Designation	Shank	L	I1	I2	I3	I4	H	W	Package Weight(kg)	Stock
NTSS-50	BT50	275	113	20	24	105	200	150	11.4	●

(Unit : mm)

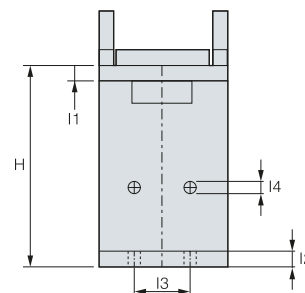
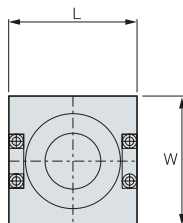

• ● : Stock

Designation	Shank	L	I1	I2	I3	I4	H	W	Package Weight(kg)	Stock
NTSS-HSK63A	HSK63A	106	11	11	50	9	160	106	4.1	●

(Unit : mm)

A yellow protractor and ruler are shown on a grid background. The protractor is positioned diagonally, with its center at the bottom left. The ruler is placed horizontally across the top of the protractor. The background is a dark grid with a yellow diagonal stripe running from the top right to the bottom left.

Standard

DINE TOTAL TOOLING SOLUTION

BOTTLE GRIP TAPER MAS403-BT	326
CAT SHANK	326
SK/NT	327
HSK	328
MORSE TAPER	329
SPARE PARTS	330

1:1 CHAT



BOTTLE GRIP TAPER MAS403-BT

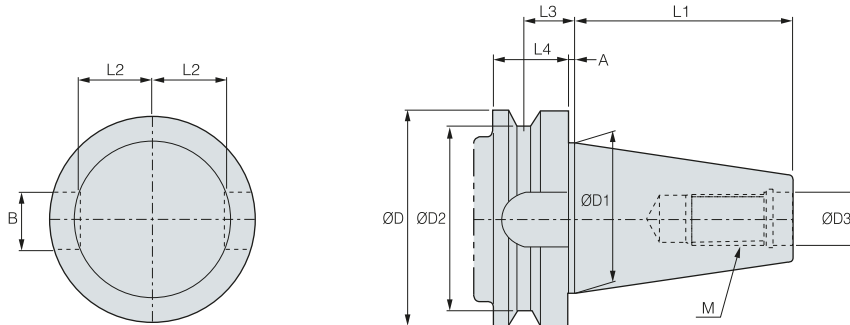

Shank	ØD	ØD1	ØD2	ØD3	L1	L2	L3	L4	A	B	M
BT30	46	31.75	38	12.5	48.4	16.3	13.6	20	2	16.1	M12 x 1.75
BT40	63	44.45	53	17	65.4	22.6	16.6	25	2	16.1	M16 x 2
BT50	100	69.85	85	25	101.8	35.4	23.2	35	3	25.7	M24 x 3
BT60	155	107.95	135	31	161.8	60.1	28.2	45	3	25.7	M30 x 3.5

(Unit : mm)

1:1 CHAT



CAT SHANK (ANSI/ASME B5.50-1985)

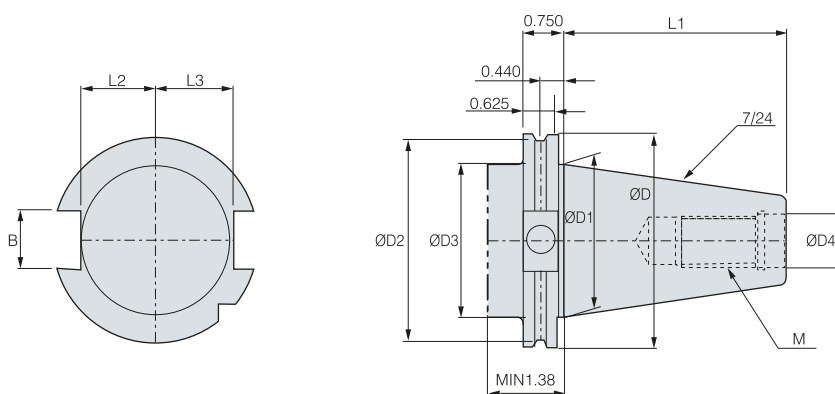

Shank	ØD	ØD1	ØD2	ØD3	ØD4	L1	L2	L3	B	M
CAT30	1.812	1.25	1.531	1.25	0.516	1.875	0.64	0.735	0.645	UNC 0.500-13
CAT40	2.500	1.75	2.219	1.75	0.641	2.687	0.89	0.985	0.645	UNC 0.625-11
CAT50	3.875	2.75	3.594	2.75	1.031	4.0	1.39	1.485	1.02	UNC 1.000-8
CAT60	5.500	4.25	5.219	4.25	1.281	6.375	2.14	2.235	1.02	UNC 1.250-7

(Unit : mm)

1:1 CHAT



DIN 69871-1 A/B, ISO 7388/1 : 1983(E)

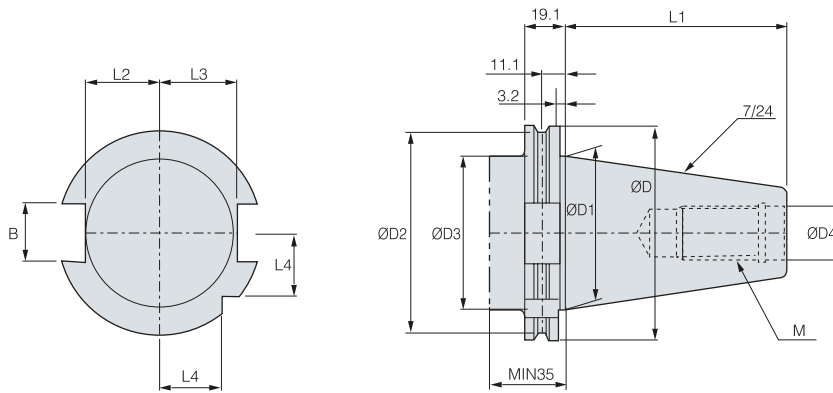

Shank	ØD	ØD1	ØD2	ØD3	ØD4	L1	L2	L3	L4	B	M
SK30	50	31.75	44.3	45	13	47.8	16.4	19	15	16.1	M12 x 1.75
SK40	63.55	44.45	56.25	50	17	68.4	22.8	25	18.5	16.1	M16 x 2.0
SK50	97.5	69.85	91.25	80	25	101.75	35.5	37.7	30	25.7	M24 x 3.0

(Unit : mm)

1:1 CHAT



DIN 2080, JIS B 6101, ISO 297 : 1988(E)

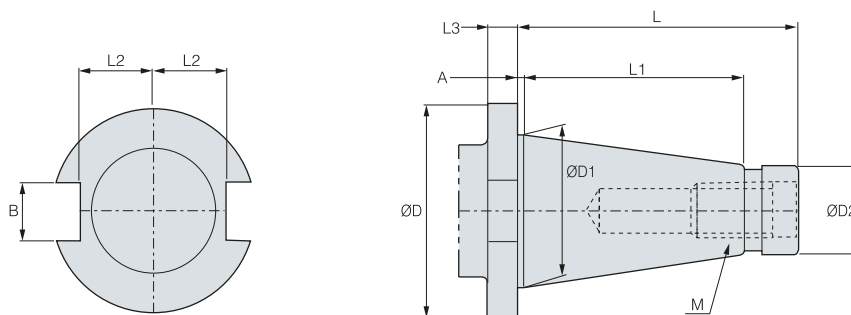

Shank	ØD	ØD1	ØD2	L	L1	L2	L3	A	B	M
NT30	46	31.75	17.4	68.4	48.4	16.2	10	1.6	16.1	UNC 1/2-13
NT40	63	44.45	25.3	93.4	65.4	22.5	10	1.6	16.1	UNC 5/8-11
NT50	100	69.85	39.6	126.8	101.8	35.3	14	3.2	25.7	UNC 1-8
NT60	155	107.95	60.2	206.8	161.8	60	15	3.2	25.7	UNC 1,1/4-7

(Unit : mm)

Chuck

Arbor/Modular

Boring Tool

Angular Head

cBN/PCD

Device&Accessory

Standard

1:1 CHAT



MORSE TAPER (Tang Type)

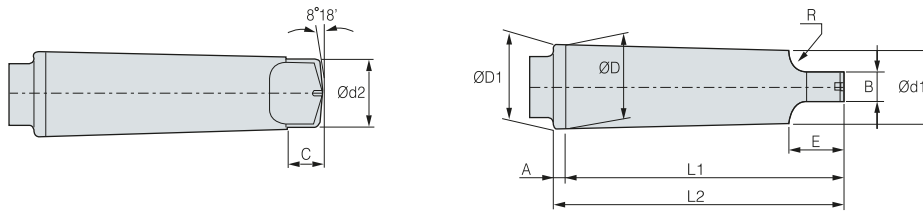

Shank	Taper	Taper Angle(α)	$\varnothing D$	A	$\varnothing D1$	$\varnothing d1$	L1	L2	$\varnothing d2$	B	C	E	R	r
MT0	1/19.212	1°29'27"	9.045	3	9.201	6.104	56.5	59.5	6	3.9	6.5	10.5	4	1
MT1	1/20.047	1°25'43"	12.065	3.5	12.24	8.972	62	65.5	8.7	5.2	8.5	13.5	5	1.2
MT2	1/20.020	1°25'50"	17.78	5	18.03	14.034	75	80	13.5	6.3	10	16	6	1.6
MT3	1/19.922	1°26'16"	23.825	5	24.076	19.107	94	99	18.5	7.9	13	20	7	2
MT4	1/19.254	1°29'15"	31.267	6.5	31.605	25.164	117.5	124	24.5	11.9	16	24	8	2.5
MT5	1/19.002	1°30'26"	44.399	6.5	44.741	36.531	149.5	156	35.7	15.9	19	29	10	3
MT6	1/19.180	1°29'36"	63.348	8	63.765	52.399	210	218	51	19	27	40	13	4
MT7	1/19.231	1°29'22"	83.058	10	83.578	68.186	286	296	66.8	28.6	35	54	19	5

(Unit : mm)

1:1 CHAT



MORSE TAPER (Screw Type)

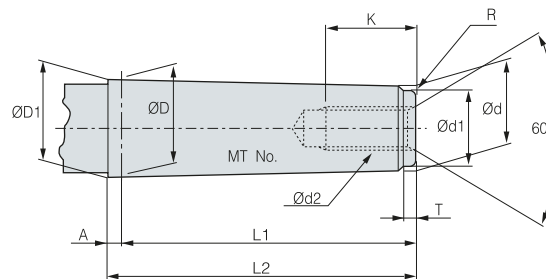

Shank	Taper	Taper Angle(α)	$\varnothing D$	A	$\varnothing D1$	d	L1	L2	$\varnothing d1$	d2	K	T	R
MT0	1/19.212	1°29'27"	9.045	3	9.201	6.442	50	53	6.4	-	-	4	0.2
MT1	1/20.047	1°25'43"	12.065	3.5	12.230	9.396	53.5	57	9.4	M6	16	5	0.2
MT2	1/20.020	1°25'50"	17.780	5	18.030	14.583	64	69	14.6	M10	24	5	0.2
MT3	1/19.922	1°26'16"	23.825	5	24.076	19.759	81	86	19.8	M12	28	7	0.6
MT4	1/19.254	1°29'15"	31.267	6.5	31.605	25.943	102.5	109	25.9	M16	32	9	1
MT5	1/19.002	1°30'26"	44.399	6.5	44.741	37.584	129.5	136	37.6	M20	40	9	2.5
MT6	1/19.180	1°29'36"	63.348	8	63.765	53.859	182	190	53.9	M24	50	12	4
MT7	1/19.231	1°29'22"	83.058	10	83.578	70.058	250	260	70	M33	80	18.5	5

(Unit : mm)

Chuck

Arbor/Modular

Boring Tool

Angular Head

cBN/PCD

Device&Accessory

Standard



SPARE PARTS

Clamp Bolt (FMA, FMC, TBC, FBC, DBC)

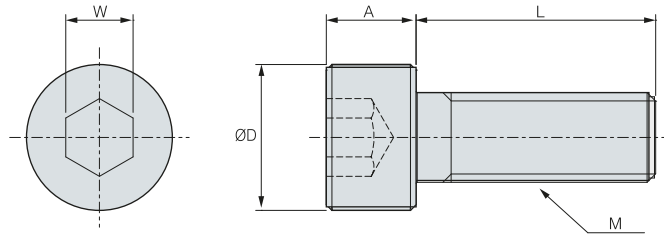

Designation	M	A	L	ØD	W
BX0310	M3x0.5	3	10	5.5	2.5
BX0412	M4x0.7	4	15	7	3
BX0416	M4x0.7	4	16	7	3
BX0515	M5x0.8	5	15	8.5	4
BX0516	M5x0.8	5	16	8.5	4
BX0616	M6x1.0	6	16	10	5
BX0620	M6x1.0	6	20	10	5
BX0625	M6x1.0	6	25	10	5
BX0630	M6x1.0	6	30	10	5
BX0820	M8x1.25	8	20	13	6
BX0825	M8x1.25	8	25	13	6
BX0830	M8x1.25	8	30	13	6
BX1020	M10x1.5	8	20	16	8
BX1030	M10x1.5	8	30	16	8
BX1035	M10x1.5	8	35	16	8
BX1230	M12x1.75	12	30	18	10
BX1235	M12x1.75	12	35	18	10
BX1640	M16x2.0	16	40	24	14
BX1645	M16x2.0	16	45	24	14

(Unit : mm)

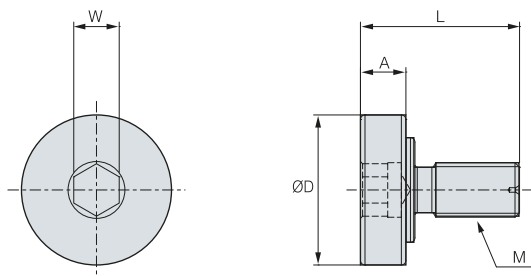

Designation	M	A	L	ØD	W
MBA-M8	M8x1.25	7	26	20	6
MBA-M10	M10x1.5	9	32	28	8
MBA-M12	M12x1.75	10	35	33	70
MBA-M16	M16x2.0	10	50	40	14
MBA-M20	M20x2.5	14	54	50	17
MBA-M24	M24x3.0	14	62	65	19

(Unit : mm)



SPARE PARTS

Taper Screw (SLA, FF, MD, EXT, RDC)

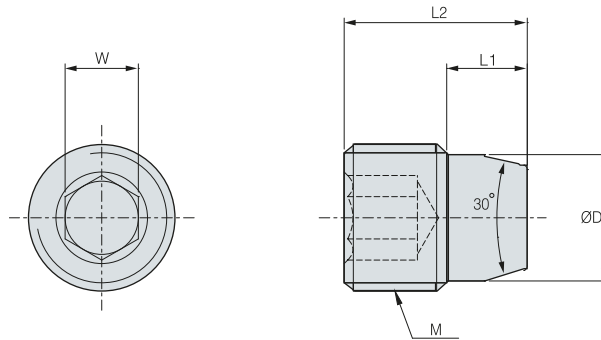

Designation	M	L1	L2	ØD	W
BTT0506F	M5x0.5	2.8	5.5	4.1	2.5
BTT0608F	M6x0.75	3.8	8	4.9	9
BTT0810F	M8x0.75	4.8	10	6.9	4
BTT1013F	M10x1.0	5.75	13	8.5	5
BTT1215F	M12x1.0	6.8	16	10.5	6
BTT1620F	M16x1.5	8.8	20	13.8	8
BTT1626F	M16x1.5	10.75	26	13.8	8
BTT1631F	M16x1.5	10.75	31	13.8	8

(Unit : mm)

Set Screw (TBC/FBC)

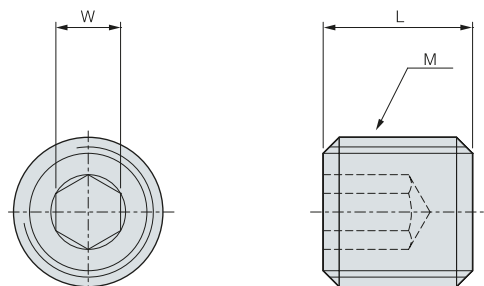

Designation	M	L1	W
BT0645	M6x1.0	45	3
BT0660	M6x1.0	60	3

(Unit : mm)



SPARE PARTS

Clamp Bolt (FBB BITE)

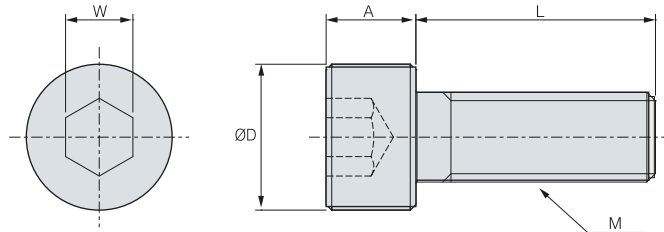

Designation	M	A	L	ØD	W
BXC0304	M3x0.5	2	5	5.5	2
BXC0405	M4x0.7	2.8	6	7	2.5
BXC0506	M5x0.8	3.5	6	8.5	3
BXC0610	M6x1.0	4	10	10	4
BXC0810	M8x1.25	5	10	13	5
BTT1620F	M16x1.5	8.8	20	13.8	8

(Unit : mm)

Insert Screw

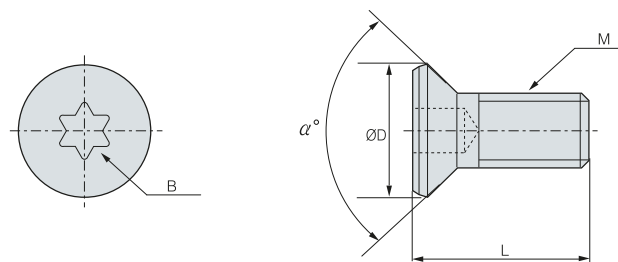

Designation	M	L	ØD	B	α°	[N.m]
BFTX0203A	2x0.4	3	2.7	T6	90	0.5
BFTX0204A	2x0.4	4.3	2.7	T6	90	0.5
BFTX0307A	3x0.5	6.8	4.3	T10	90	2.0
BFTX0410A	4x0.7	10.3	5.6	T15	90	3.4
BFTX02506N	2.5x0.45	5.5	3.45	T8	60	1.5

(Unit : mm)



INDEX

Index

NUMBER				
	□NU-CNGA□□□□□□	cBN/PCD	cBN Series	256
	□NU-DNGA□□□□□□	cBN/PCD	cBN Series	256
	□NU-VNGA□□□□□□	cBN/PCD	cBN Series	257
	2NU-CCGW□□□□□□	cBN/PCD	cBN Series	257
	2NU-DCGW□□□□□□	cBN/PCD	cBN Series	257
	2NU-VBGW□□□□□□	cBN/PCD	cBN Series	258
	2NU-VCGW□□□□□□	cBN/PCD	cBN Series	258
	3D-TASTER 2007	Device&Accessory	3D Taster	316
	3NU-TCGW□□□□□□	cBN/PCD	cBN Series	257
	3NU-TNGA□□□□□□	cBN/PCD	cBN Series	256
	3NU-TPGB□□□□□□	cBN/PCD	cBN Series	258
	3NU-TPGN□□□□□□	cBN/PCD	cBN Series	257
	3NU-TPGW□□□□□□	cBN/PCD	cBN Series	257
	4NS-CNGA□□□□□□	cBN/PCD	cBN Series	259
	4NS-DNGA□□□□□□	cBN/PCD	cBN Series	259
	4NU-SNGA□□□□□□	cBN/PCD	cBN Series	256
	5-AXIS CENTERING VISE-FVT	Device&Accessory	5-Axis Centering Vise	304
A	ANGULAR HEAD	Angular Head	Angular Head	228
	Air Turbine Machine(ATM)	Angular Head	Air Spindle	246
	Air Turbine Spindle Universal Type (ATU)	Angular Head	Air Spindle (ATU)	250
B	BB BITE	Boring Tool	BB Bite (For SMB, SMH, KMB)	215
	BCF	Boring Tool	Micro Boring Bar	223
	BH	Boring Tool	Boring Bite	217
	BKA	Boring Tool	FZ Micro Boring Bar	218
	BORING INSERT	Boring Tool	Boring Insert	226
	BSA	Boring Tool	Boring Bar	216
	BSA SPARE PART	Boring Tool	Boring Bar Related Parts	216
C	CAT SHANK	Standard	CAT Shank Specifications	326
	cBN LIST	cBN/PCD	cBN Series	256
	cBN SERIES(Fiture)	cBN/PCD	cBN Series Features	262
	cBN TECHNICAL DATA	cBN/PCD	cBN Technical Data	285
	cBN(For Cast Iron)	cBN/PCD	For cBN Cast Iron	272
	cBN(For Heat Treatment Steel)	cBN/PCD	cBN for Heat Treatment Machining	266
	cBN(For Sintered Metal)	cBN/PCD	cBN Sintered Parts	274
	CCMT□□□□□□	cBN/PCD	PCD Series	260
	CCMW□□□□□□	cBN/PCD	cBN Series	258
	CLEAN-TEC FAN	Device&Accessory	Clean-Tec Fan	312
	CLEAN-TEC FAN SPARE PART	Device&Accessory	Clean-Tec Fan Related Parts	312
	CNMA□□□□□□	cBN/PCD	cBN Series	258
	CNMM□□□□□□	cBN/PCD	PCD Series	260
	CNMW□□□□□□	cBN/PCD	PCD Series	260
D	DB1000	cBN/PCD	Uncoated cBN	280
	DB2000	cBN/PCD	Uncoated cBN	281
	DB7000	cBN/PCD	Uncoated cBN	282
	DB7500	cBN/PCD	Uncoated cBN	283
	DBC	Boring Tool	Boring Tool (Rough-boring)	188
	DBC SPARE PART	Boring Tool	Balance Cut Tool Related Parts	192
	DBC(Modular Type)	Boring Tool	Boring Tool (Modular Type)	190
	DBCA	Boring Tool	Two-way Controllable DBCA	178
	DBCA SPARE PART	Boring Tool	Two-way Controllable DBCA Related Parts	192
	DBCA(Helical Type)	Boring Tool	Two-way Controllable (Helical Type)	180
	DBCA(Straight Type)	Boring Tool	Two-way Controllable DBCA (Straight Type)	184
	DC	Chuck	Straight Collet	77
	DCGT□□□□□□	cBN/PCD	PCD Series	260
	DCGW□□□□□□	cBN/PCD	cBN Series	259
	DCJ	Chuck	Jetcoolant Collet for Milling Chuck	76
	DCL	Chuck	Non-slip Milling Chuck Collet	74
	DCL SPARE PART	Chuck	Non-slip Milling Chuck Collet Related Parts	75



INDEX

Index

DCMT□□□□□□	eBN/PCD	PCD Series	260
DCS	Chuck	Straight Collet	78
DHC	Chuck	Hydraulic Expansion Chuck Collet	48
DHE	Chuck	Hydraulic Expansion Chuck	34
DHE SPARE PART	Chuck	Hydraulic Expansion Chuck Related Parts	41
DHE/G	Chuck	Hydraulic Chuck for Grinder	46
DHE/G SPARE PART	Chuck	Hydraulic Chuck for Grinder Related Parts	47
DHE/S	Chuck	Slim Hydraulic Expansion Chuck	42
DHE/S SPARE PART	Chuck	Slim Hydraulic Expansion Chuck Related Parts	45
DHJ	Chuck	Hydraulic Expansion Chuck Jet Coolant Collet	49
DIGITAL 3D-TASTER	Device&Accessory	Digital 3D Taster	316
DIN 2080, JIS B 6101, ISO 297 : 1988[E]	Standard	NT Shank Specifications	327
DIN 69871-1 A/B, ISO 7388/1 : 1983[E]	Standard	SK Shank Specifications	327
DIN 69893-1, ISO 12164-1 : 2001	Standard	HSK Shank Specifications	328
DJT	Chuck	Drill Chuck Arbor	79
DNC100	eBN/PCD	Coated cBN	276
DNC250	eBN/PCD	Coated cBN	277
DNC300	eBN/PCD	Coated cBN	278
DNC350	eBN/PCD	Coated cBN	279
DNMA□□□□□□	eBN/PCD	cBN Series	258
DNMM□□□□□□	eBN/PCD	PCD Series	260
DMC	Chuck	Dine Milling Chuck	73
DOP	Device&Accessory	Optical Edge Finder	319
DSC	Chuck	Shrinking Chuck	52
DSC SPARE PART	Chuck	Shrinking Chuck Related Parts	63
DSC/M(Mono Curve Type)	Chuck	Shrinking Chuck Mono Curve Type	57
DSC/M(Mono Slim Type)	Chuck	Shrinking Chuck Mono Slim Type	61
DSC/M(Mono Type)	Chuck	Shrinking Chuck Mono Type	60
DSK	Chuck	Slim Collet Chuck	108
DSK SPARE PART	Chuck	Slim Collet Chuck Related Parts	111
DST(PAT.)	Chuck	High-speed Tapping Chuck	128
DTN	Chuck	Tapping Chuck	124
DVT	Device&Accessory	Double Vise	303
DZC	Chuck	Zero Fit Collet	50
DZH	Device&Accessory	Z axial Height Gauge	318
DZOP	Device&Accessory	Z axial P Reset Gauge	319
DZP	Device&Accessory	Z axial Setting Height Gauge	318

E

ER COLLET	Chuck	ER Collet	100
ER COLLET SET	Chuck	ER Collet Set	102
ER/L	Chuck	Non-slip Collet Chuck Collet	104
ER/T	Chuck	ER Collet	103
ER/P	Chuck	ER Collet (Precision Type)	100
EXT	Arbor/ Modular	Extension Bar	162

F

FBB BITE	Boring Tool	Boring Bite	177
FBC	Boring Tool	Wide Diameter Boring for Fine Boring	203
FBC BITE	Boring Tool	Wide Diameter Boring Bite	206
FBC SPARE PART	Boring Tool	Wide Diameter Boring for Fine Boring Related Parts	205
FBH/B	Boring Tool	Back Boring Balanced Type	164
FBH/B SPARE PART	Boring Tool	Micro Boring Balanced Type Related Part	172
FBH/D	Boring Tool	Micro Boring Damping Type	173
FBH/D SPARE PART	Boring Tool	Micro Boring Damping Type Related Part	172
FF	Boring Tool	Micro Boring Unit	225
FF UNIT SPARE PART	Boring Tool	FF Unit Related Part	225
FMA	Arbor/ Modular	Face Mill Arbor	144
FMA SPARE PART	Arbor/ Modular	Face Mill Arbor Related Parts	146
FMC	Arbor/ Modular	Face Mill Arbor	148
FMC SPARE PART	Arbor/ Modular	Face Mill Arbor Related Parts	151
FMD	Arbor/ Modular	Basic Holder	206
FZ UNIT	Boring Tool	FZ Micro Boring Unit	221
FZ UNIT SPARE PART	Boring Tool	FZ Unit Related Parts	222



INDEX

Index

G	GERC	Chuck	GERC Coating Collet	94
	GERC COLLET SET	Chuck	GERC Collet Set	98
	GSK	Chuck	High-speed Slim Collet Chuck	112
	GSK SPARE PART	Chuck	High-speed Slim Collet Chuck Related Parts	117
H	HC COLLET	Chuck	HC Slim Collet	118
	H DG	Device&Accessory	Hydraulic Expansion Chuck Gauge	317
	HRAG	Angular Head	Rigidity-reinforced Angular Head (90° Fixed Type)	236
I	INSERT	Boring Tool	FZ, FF Unit Insert	222
	INSERT CODE SYSTEM(ISO)	cBN/PCD	How to indicate the model no. of insert	254
K	KAC	Angular Head	Fixed Angle-type Angular Head (45°)	240
	KAG	Angular Head	Attachment-type Angular Head (90°)	234
	KAH	Angular Head	Collet-type Angular Head (90°)	230
	KHU	Angular Head	Collet-type Angular Head (0°~90°)	232
	KMB	Boring Tool	Micro Boring	209
	KMB SPARE PART	Boring Tool	Micro Boring Related Parts	214
M	MAGNETIC BASE(TMB)	Device&Accessory	Magnetic Base	315
	MAH	Angular Head	Rigidity-reinforced Angular Head	238
	MAS403-BT	Standard	BT Shank Specifications	326
	MC MACHINE VISE-MVT-154	Device&Accessory	Machine Vise (Standard Type)	303
	MC POWER VISE-PVT	Device&Accessory	Power Vise (Standard Type)	300
	MC POWER VISE-PVTM	Device&Accessory	Power Vise (Entry Type)	301
	MD	Arbor/Modular	Modular Arbor	154
	MD SPARE PART	Arbor/Modular	Modular Arbor Related Parts	160
	MH-300	Device&Accessory	Shrink Fit Device	308
	MH-300 ACCESSORIES	Device&Accessory	Shrink Fit Device Related Parts	308
	MORSE TAPER(SCREW TYPE)	Standard	Morse Taper (Screw Type)	329
	MORSE TAPER(TANG TYPE)	Standard	Morse Taper (Tang Type)	329
	MTA	Arbor/Modular	Morse Taper Arbor	143
	N	NOTCHED ENDMILL	Chuck	Notched End Mill
NPM		Chuck	New Power Milling Chuck	64
NPM SET		Chuck	New Power Milling Chuck Set	71
NPM SPARE PART		Chuck	New Power Milling Chuck Related Parts	72
NPU		Chuck	Drill Chuck	120
NPU SPARE PART		Chuck	Drill Chuck Related Parts	122
NTSS		Device&Accessory	Tool Setting Stand	322
O		OFH	Chuck	Floating Holder
P	PCD SERIES	cBN/PCD	PCD Series	260
	PCD TECHNICAL DATA	cBN/PCD	PCD Technical Data	295
	POSITIONING BLOCK	Angular Head	Positioning Block	244
	PRECISION MICRO ADJUSTING CARTRIDGE	Device&Accessory	Precision Boring Adjusting Cartridge	313
	PULLSTUD BOLT WRENCH	Device&Accessory	Pull Stud Bolt Wrench	313
	PULLSTUD BOLT	Device&Accessory	Pull Stud Bolt	323
	PULLSTUD BOLT-T	Device&Accessory	Pull Stud Bolt-T	324
Q	QPT	Device&Accessory	Quick Point System	306
R	RA, GA CHIPBREAKER	cBN/PCD	RA, GA Chip Breaker	284
	RDC	Arbor/Modular	Reducer Bar	162
	ROT	Device&Accessory	Run-out Tester	320
	RTJW	Chuck	Jet Coolant Disk	106



INDEX

Index

S

SAH	Angular Head	Slim Angular Head	242
SC	Device&Accessory	Spindle Cleaner	321
SDC/PL	Chuck	ER Collet Chuck	89
SDC/PL SPARE PART	Chuck	ER Collet Chuck Related Parts	92
SDC/P	Chuck	ER Collet Chuck	80
SDC/P SPARE PART	Chuck	ER Collet Chuck Related Parts	86
S-FBH/B	Boring Tool	Micro Boring Balanced Type	170
SLA	Arbor/ Modular	Side Lock Arbor	138
SLA SPARE PART	Arbor/ Modular	Side Lock Arbor Related Parts	141
SMB	Boring Tool	Small Micro Boring Bar	207
SMB SPARE PART	Boring Tool	Small Micro Boring Bar Related Parts	214
SMH	Boring Tool	Small Micro Boring Bar(Precision Type)	211
SMH SET	Boring Tool	Small Micro Boring Set	213
SMH SPARE PART	Boring Tool	Small Micro Boring Bar(Precision Type) Related Parts	214
SPGN□□□□□□	cBN/PCD	PCD Series	261
S-SDC	Chuck	Collet Chuck Straight Type	87
STER	Chuck	Synchro Tapping ER Collet	135

T

T- 2NU-VBGW□□□□□□	cBN/PCD	cBN Series	258
T-□NU-VNGA□□□□□□	cBN/PCD	cBN Series	257
T-2NU-DCGW□□□□□□	cBN/PCD	cBN Series	257
T-2NU-VCGW□□□□□□	cBN/PCD	cBN Series	258
TAPER CLEANING DEVICE	Device&Accessory	Taper Cleaning Device	307
TAPER CLEANING DEVICE SPARE PART	Device&Accessory	Taper Cleaning Device Related Parts	307
TB	Device&Accessory	Tester Bar	321
TBC	Boring Tool	Wide Diameter Boring for Rough Boring	200
TBC SPARE PART	Boring Tool	Wide Diameter Boring for Rough Boring Related Parts	202
TBCA	Boring Tool	Aluminium Wide Boring Tool	194
TC	Chuck	Taper Collet	79
TCA	Chuck	Tap Adapter	127
T-CNMA□□□□□□	cBN/PCD	cBN Series	258
T-DCGW□□□□□□	cBN/PCD	cBN Series	259
TEH	Chuck	Tap Extension Holder	132
TER	Chuck	ER Tap Collet	131
TFMA	Arbor/ Modular	Face Mill Arbor	147
TFMC	Arbor/ Modular	Face Mill Arbor	152
TFMC-L	Arbor/ Modular	Long Face Mill Arbor	153
THPU	Chuck	Hex Key Drill	123
TNMA□□□□□□	cBN/PCD	cBN Series	258
TMD	Arbor/ Modular	Modulat Arbor	161
TMTA	Arbor/ Modular	Morse Taper Arbor	143
TNPU	Chuck	Drill Chuck Arbor	123
TOOL SHRINK BASIC	Device&Accessory	Tool Shrink Basic	309
TOOL SETTING STAND(TTC)	Device&Accessory	Tool Setting Stand	314
TSC	Device&Accessory	T-slot Cover	314
TSK	Chuck	High-speed Slim Collet Chuck	117
TSLA	Arbor/ Modular	Side Lock Arbor	142
TXER	Chuck	ER Collet Chuck	93
TPGB□□□□□□	cBN/PCD	cBN Series	258
TPGN□□□□□□	cBN/PCD	PCD Series	261
TPGW□□□□□□	cBN/PCD	PCD Series	261
T-VNMA□□□□□□	cBN/PCD	cBN Series	258

U

UC CHIPBREAKER	cBN/PCD	UC Chip Breaker	294
----------------	---------	-----------------	-----

V

VBGW□□□□□□	cBN/PCD	PCD Series	261
VBMT□□□□□□	cBN/PCD	PCD Series	261
VBMW□□□□□□	cBN/PCD	cBN Series	259
VCMT□□□□□□	cBN/PCD	PCD Series	261
VNMA□□□□□□	cBN/PCD	cBN Series	258



Head Office (15118) 24, MTV , Siheung-si, Gyeonggi-do, Republic of Korea (Jeongwang-dong) | T. +82-31-488-6200

Branch Office in China T. +86-532-8588-5907 | E. dine@dinox.com.cn
4th/5th Floor, 88 Building, Beijing Capital Airport International Center, No.6th Changchengnan Road, Chengyang District, Qingdao, Shandong Province, China (post code : 266108)

Branch Office in Vietnam T. +84-24-7300-6991 | E. sales@dine.com.vn
4th Floor, Tower B, Golden Palace Building, Me Tri ward, Nam Tu Liem district, Hanoi, Vietnam

Branch Office in Thailand T. +66-02-108-8911~3 | E. dine.thai@dine.co.kr
1/38 Bangna Thani Building 19B th Floor, Bangna-Trad 34 Alley, Bangna Tai Sub-district, Bangna District, Bangkok [10260]

Branch Office in Spain T. +34-911-09-59-35 | E. dms@dine.com
Avda. de los Montes de Oca, 19, Nave 3, 28703, San Sebastian de los Reyes, Madrid

www.dine.co.kr E-mail: dine@dine.co.kr