

# Cutting Tools

# 2022-23



Aerospace Industry



Automotive Industry



Shipbuilding Industry



Railway Industry

# Index



Grades & Chip Breakers



Turning



Multi Functional Tools



Threading



Milling



Drill



Tooling System



Parts



Technical Information



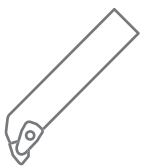
Old-Fashioned  
Product Information



Index



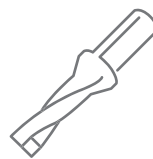
# 2022-2023 KORLOY CUTTING TOOLS



Turning



Milling



Holemaking



Endmilling

# CONTENTS

## GRADES&CHIP BREAKERS

### **A** Grades

**A02** KORLOY grades system

### Turning Grades

**A04** Turning grade selections

**A05** CVD coated grades

**A10** PVD coated grades

**A12** Uncoated Carbide grades

**A13** Cermet grades

**A15** Coated Cermet grades

### Milling Grades

**A16** Milling grade selections

**A17** CVD coated grades

**A18** PVD coated grades

**A23** Uncoated Carbide grades

**A24** Cermet grades

### **A** Solid Endmills & Solid Drills

**A25** Solid Endmills grade selections

**A26** Solid Endmills grades

**A27** Solid Drills grade selections

**A28** Solid Drills grades

### Others (Turning/Milling/Endmills)

**A29** Diamond coated grades

**A30** DLC coated grades

**A31** cBN inserts grades

**A36** PCD inserts grades

### Chip Breakers

**A37** Chip Breaker for Turning

**A42** Chip Breaker for Milling

**A49** Chip Breaker for Drilling

## TURNING

### **B** Turning Chip Breakers

**B02** Application range of KORLOY main Chip Breakers

**B04** Recommended Chip Breakers for workpiece

**B16** Feature of Chip Breakers

### Inserts

**B34** Turning Insert Code System (ISO)

**B36** Turning Insert (Negative)

**B73** Turning Insert (Positive)

**B102** Aluminum Insert (Positive)

**B110** cBN Inserts

**B113** PCD Inserts

### Save Turn

**B114** Technical Information for Save Turn

**B115** Save Turn (Insert)

**B116** Save Turn (Holder)

**B119** Save Turn (Boring Bar)

### Auto Tools

**B121** Technical Information for Auto tools

**B122** ISO type

**B127** KHP Coolant

**B136** Blade type

**B139** Multi Utility type

**B142** KGT/MGT type

**B145** MSB Tool

**B151** Sleeve

### Multi Turn

**B152** Technical Information for Multi Turn

**B154** Multi Turn

### **B** Bearing Solutions

**B155** Technical Information for Bearing Solutions

**B156** Bearing Solutions

**B161** Special Order Form for Bearing Inserts

### External Tool Holder

**B162** External tool Holder Code System (ISO)

**B163** Index for External Holder

**B166** Instruction of External Holder assembly

**B167** Double Clamp System

**B172** Lever Lock System

**B179** Wedge Clamp System

**B181** Clamp on System

**B183** Multi Lock System

**B190** Screw on System

**B197** Ceramic Holder

### High Pressure Coolant

**B199** Technical Information for KHP Coolant

**B202** KHP Coolant

### Boring Bar

**B204** Boring Bar Code System (ISO)

**B205** Index for Boring Bar

**B207** Instructions of Boring Bar assembly

**B208** Double Clamp System

**B210** Lever Lock System

**B212** Clamp on System

**B213** Multi Lock System

**B215** Screw on System

**B225** Compact Mini

## TURNING

### **B** HSK/KM Tooling system

- B228** Technical Information for HSK/KM Tooling System
- B230** Index for HSK/KM Tooling System
- B231** HSK Tooling system
- B237** KM Tooling system

### **B** Cartridges

- B241** Cartridge Code System (ISO)
- B242** Index for Cartridge
- B243** Clamp on System
- B245** Screw on System

## MULTI FUNCTIONAL TOOLS

### **C** Application Example

- C02** Application Example
- C04** Technical Information for Multi Functional tools

### **C** K Notch

- C55** Technical Information for K Notch
- C57** K Notch

### **KGT**

- C07** Technical Information for KGT
- C12** KGT
- C25** KGT Blade for Parting off

### **Saw Man**

- C60** Technical Information for Saw Man
- C61** Saw Man

### **MGT**

- C26** Technical Information for MGT
- C28** MGT
- C36** MGT (Face grooving)

### **Saw Man-X**

- C63** Technical Information for Saw Man-X
- C65** Saw Man-X

### **KGT/MGT Cartridge**

- C39** Technical Information for KGT/MGT Cartridge
- C40** KGT/MGT Cartridge Holder
- C41** KGT Cartridge
- C42** MGT Cartridge

### **Fine Tools**

- C67** Technical Information for Fine Tools
- C68** Fine Tools

### **MGT Aluminum Wheel Series**

- C43** Technical Information for MGT Aluminum Wheel
- C44** MGT Aluminum Wheel

### **Grooving/Parting off**

- C70** IGH
- C70** DBH
- C71** GFIP

### **TB/TB-M**

- C47** Technical Information for TB/TB-M
- C51** TB/TB-M

### **Special Order Form**

- C72** Special Order Form for MGT
- C73** Special Order Form for V-Pulley Insert

## THREADING

### **D** Threading Code System

- D02** Threading Holder/Insert Code System

### **Technical Information for Threading**

- D03** Technical Information for Threading
- D09** Threading Insert with Chip Breaker

### **D** Thread Inserts

### **Thread Inserts**

- D10** Partial profile 60°
- D11** Partial profile 55°
- D12** ISO Metric

- D16** American UN (UN, UNC, UNF, UNEF, UNS)
- D18** Whitworth (BSW, BSF, BSP, BSB)
- D22** British Standard Pipe Thread (BSPT)
- D22** National Pipe Thread (NPT)
- D23** National Pipe Threads-Dryseal (NPTF)
- D23** Round DIN405 (RD)
- D24** Trapez DIN103 (TR)
- D24** American ACME (ACME)
- D25** Stub ACME (STACME)



# CONTENTS

---

## THREADING

### **D** Thread Inserts

- D26** UNJ (Unified Constant Thread)
- D28** American Buttress (ABUT)
- D28** British Buttress (BBUT)
- D29** Metric Buttress (SAGE)/API
- D30** API Buttress Casing (BUT)
- D30** API Round Casing & Tubing (APIRD)
- D30** Extreme Line Casing (EL)

### **D** Thread Holders

- D31** External Holder
- D32** Internal Holder
- D33** Vertical Type Holder

### Thread Milling

- D34** Technical Information for Thread Milling
- D44** Thread Milling Insert
- D49** Thread Milling Holder

## MILLING

### **E** Insert

- E02** Milling Insert Code System (ISO)
- E04** Milling Inserts
- E34** KORLOY Cutters
- E42** KORLOY Shanks
- E45** KORLOY Modular Adaptors

### Face Milling Cutters

- E47** Mill-max (ISO)/Mill-max Plus (E48, E54)
- E57** Mill-max Heavy
- E59** Turbo Mill
- E62** Double Mill
- E64** Power Buster
- E71** Rich Mill
- E147** Aero Mill/Aero Mill-Plus/Aero Mill-Mini
- E156** PCD face cutter

### Cutters for Molds

- E157** Alpha Mill/Alpha Mill Nick
- E193** Alpha Mill-X
- E201** Future Mill/Future Mill P-Positive
- E254** Triple Mill
- E262** HFMD
- E277** HFM
- E284** HRMDouble
- E300** HRM
- E307** Tank Mill
- E308** TP2P
- E317** Laser Mill/GBE/BRE
- E337** HAVE(Multi-edge, Single-edge)
- E341** Technical Information for BT/HSK Tooling System
- E342** BT Tooling System (Alpha Mill, Mono-Tool)
- E353** HSK Tooling System (Alpha Mill, Mono-Tool, Pro-V Mill)
- E364** O-ring Cutter
- E366** Chamfer Tool (Multi-functional, Solid)
- E374** T-Cutter(TFE)

### **E** Milling Cutter for Aluminum

- E375** Technical Information for Pro-A Mill/Pro-X Mill/Pro-L Mill/Pro-XL Mill/Pro-V Mill
- E385** Pro-A Mill
- E388** Pro-X Mill
- E394** Pro-L Mill
- E398** Pro-XL Mill
- E399** Pro-V Mill
- E401** Modular Adaptor (MAT/BT/HSK)

### Side Milling Cutters

- E405** Technical Information for Side Milling Cutters
- E407** Side Milling Cutters
- E411** Side Cutter
- E414** Wind Mill

### Milling Cutter for Cast iron at high feed

- E418** Technical information for High feed Cutter
- E420** Technical information for Cube Mill
- E421** Technical information for Couple Mill
- E423** Technical information for Shave Mill
- E425** Technical information for Shave Mill Ultra

### Detail Information of Milling Cutter and Arbor

- E426** Actual Designation of Milling Cutter and Arbor

### Gear Tools

- E429** Technical information for Gear Cutter Tools
- E430** Gear Cutter Table
- E431** Gear Cutter
- E439** Gear Cutter Order Form
- E440** Indexable HOB
- E441** Indexable HOB Cutter Order Form

## DRILL

### **F** Technical Information for Drills

- F02** KORLOY Drills
- F03** Available Insert

### Indexable Drills

- F05** King Drill
- F20** King Drill (for through coolant system with a lathe)
- F24** King Drill (for large diameter drilling)
- F26** KED Plus Drill
- F37** TPDC Plus Drill

### **F** Indexable Drills

- F54** TPDB Plus Drill
- F63** TPDB-F
- F68** TPDB-H
- F75** Technical information for WPDC
- F78** Center Drill
- F79** WPDC

### Reamer

- F82** Indexable Reamer

## TOOLING SYSTEM

### **G** Tooling System

- G02** Tooling System Index
- G04** DHE/S
- G07** DHE
- G11** DHC/DHJ Collet
- G12** DSC
- G20** NPM
- G23** DCS/DC/TC
- G24** Collet Chuck Series
- G25** SDC/P
- G30** DSK
- G32** GSK
- G34** GERC
- G36** ER
- G37** ER/L
- G38** RTJW
- G40** NPU
- G41** DST
- G43** TER Tap Collet
- G44** DTN
- G46** TCA Tap Adaptor
- G47** SLA

### **G** Tooling System

- G49** FMA
- G50** FMC
- G52** MD
- G54** EXT Bar
- G54** RDC Bar
- G55** FBH/B
- G62** DBCA
- G66** DBC
- G68** SMB
- G70** KMB
- G72** SMH
- G74** TBCA
- G79** TBC
- G82** FBC
- G85** SAH
- G86** Angular Head
- G94** DZC
- G95** DCJ
- G96** DCL
- G97** DAMPING PRO
- G104** Others

## PARTS

### **H** Parts

- H02** Shim
- H03** Cartridge/Chip Breaker
- H03** Chip Cover/Clamp
- H04** Coolant Bolt/Wrench Bolt
- H04** Lever
- H05** Locator/Nut

### **H** Parts

- H05** Pin/Screw
- H06** Shim Pin
- H07** Spring/Wrench
- H07** Stop Ring/Washer
- H07** Stopper/Nozzle

# CONTENTS

---

## TECHNICAL INFORMATION

### **I** General Information I

- I 02 Workpiece material grades
- I 06 Steel, Non-ferrous metal symbol list
- I 07 SI unit conversion table
- I 08 Hardness calculating table
- I 09 Properties of Korloy grades

### Technical Information

- I 10 Technical Information for Turning
- I 20 Technical Information for Milling

### **I** Technical Information

- I 24 Technical Information for Tapers
- I 27 Technical Information for Endmills
- I 30 Technical Information for Drill

### General Information II

- I 36 The comparison of chip breakers
- I 37 KORLOY Grades
- I 40 The comparison of grades for Turning/Milling

## OLD-FASHIONED PRODUCT INFORMATION

### **J** Old-fashioned product information

- J02 Grade
- J02 External Holder
- J02 Fine Tool
- J03 Threading Tool

### **J** Old-fashioned product information

- J03 Mill-Max
- J04 Cen-Mill
- J04 Jip Drill
- J04 LPD/SPD/NPD

## INDEX

### **K** Index



# SAFETY GUIDE OF CARBIDE PRODUCTS

**KORLOY Inc. is continuously trying to develop safer and higher quality products**  
**Please be aware of the safety guidelines below prior to using KORLOY Inc. products**

- It is generally accepted that the proper handling of cemented carbide tools requires awareness of safety as noted above. For more information, please contact us.
- KORLOY does not accept any responsibility for any accident caused by inappropriate use, abuse of tools, or changes to the products.

## 1. PL (Product Liability)

In accordance with the PL (Product Liability) law, we have attached a WARNING label on the case of KORLOY products. There is no warning on the surface of the tools. Please read this safety guidelines before using carbide tools and provide safety education to all users.

## 2. Basic characteristics of CEMENTED CARBIDE tools

Cemented carbide tools are made of carbides, nitrides, carbonitrides, oxides of Tungsten (W), Titanium (Ti), Alluninyum (Al), Silicon (Si), Tantalum (Ta), Boron (B) etc and metal omponent like Cobalt (Co), Nickel (Ni), Chrom (Cr), Molybdenum (Mo) as binder. Cemented carbides tools have high hardness and specific gravity. Generally there's no smell but according to usage and treatment, appearance and color could be changed

## 3. Precaution for CEMENTED CARBIDE tools

- 1) Cemented carbides are extremely hard and brittle at the same time. Impact shock or excessive clamping power could cause fracture or breaking of the tool.
- 2) Cemented carbides have large sepcific gravity, thus they require special attention as a heavy material when you handle big sizes or large quantities.
- 3) Cemented carbides have different thermal expansion coefficient with steel and ferrous materials. Shrink fit or swell fit products may cause trouble if they are used at undesirable conditions like extremely high or low temperatures.
- 4) There are several cemented carbide products having sharp cutting edges.Be careful not to handle the tools with bare hands which may cause cuts or injury, especially when removing the tools from the case, do not touch the cutting edge and be careful not to drop it.
- 5) Storing carbide tools in a corrosive atmosphere may cause erosion which can reduce toughness.
- 6) Please refer to the catalouge safety guidance prior to handling the tools.
- 7) Do not absue tools under inappropriate conditions.

## 4. Precaution for machining (grinding, welding, EDM) of CEMENTED CARBIDE tools

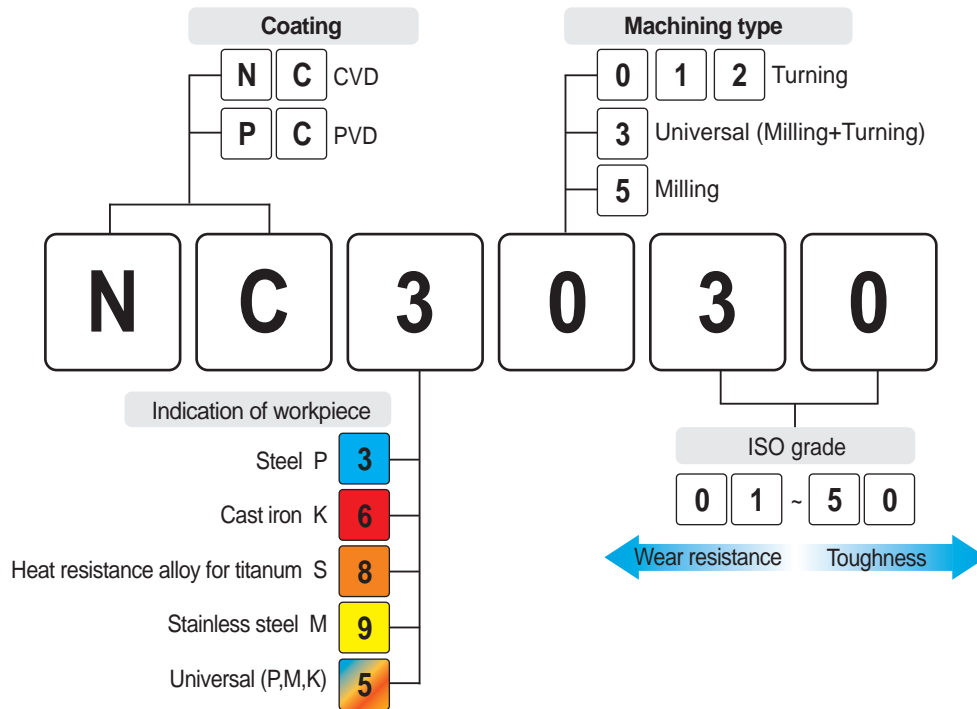
- 1) Surface condition can affect the toughness of the tool, so it is recommended to use a diamond grinding wheel.
- 2) Grinding of cemented carbide creates mist and dust. It contains harmful compositions like Cobalt (Co), thus it is recommended to use a mask, mist collection, and other protective facilities. If the dust gets in your skin or eye, rinse immeditely with continously running water.
- 3) In case of grinding with coolant, coolant contains harmful metal components which cause environmental problems. Handle the coolant according to the manufacturer's recommendations.
- 4) Check for cracks after re-grinding carbide tool and reuse.
- 5) Marking with laser or electric pen may cause cracks on the carbide tool. The crack can shortened tool life.
- 6) EDM of carbide may cause residual cracks on the carbide tool, so if necessary , remove the crack with a grinding process.
- 7) Brazing of carbide tools at extremely high or low temperatures compare with the melting point of brazing materials may cause loosening or breakage.
- 8) Overheating a oil base coolant may cause a fire or flames, thus be prepared for fire prevention.

## 5. METALCUTTING SAFETY

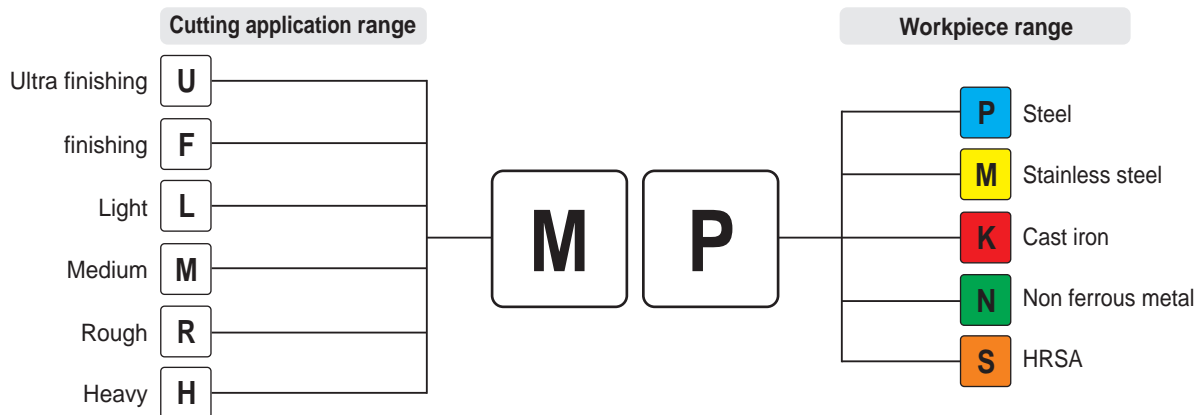
	DANGEROUS FACTOR	SAFETY COUNTERPLAN
Cutting tools	• Sharp cutting edge of cutting tools may cut your bare-hand	• Use gloves when pulling out the insert from the case or mounting it on the machine
	• Inappropriate conditions or usage may cause fragmentation and expel parts of tools which may cause injury	• Use glasses or safety cover for your safety • Use the tools within the recommended range • Please refer to catalogue and safety guidelines first
	• Severe load on tool and premature wear of cutting edge may bring excessive cutting force on tool, causing fracture of the tool and may cause injury	• Use glasses or safety cover for your safety • Change the tool as required before excessive wear or fracture
	• Chips evacuated during cutting are hot and sharp and maycause burns and cuts	• Use glasses or safety cover for your safety • Stop machining and put safety glove on and use a hook tool to remove chips
	• Touching the workpiece immediately after cutting may cause burns	• Use gloves or safety cover for your safety
	• Be aware of sparks, fire, or explosion of hot chips generated during the cutting operation	• Do not use at the place where having explosive materials • Prepare for fire extinguishments
	• In case of high RPM machining, vibration and chattering may occur due to the improper balance of the machine	• Use glasses or safety cover for your safety • Check first if there's any chattering, vibration or strange noises prior to your main cutting operation
	• Touching a burr remaining on the workpiece with a bare-hand may cause a cut	• Do not touch the burr with bare-hand      · Use gloves or safety cover for your safety
	• Loose clamping of the workpiece may cause the tool to fracture and result in damage to the cutter body and possible injury	• Clamp the workpiece tightly
Indexable tools	• Tools are operated to right-hand direction normally • Left-hand direction operation can cause fracture of tool and body damage	• Do not use left-hand direction without notice • Check the package of product to check the availability of left-hand operation
	• Loose clamping of inserts and parts may result in ejection of the tool during cutting and may cause serious injury	• Check the clamping of inserts and parts prior to machining,and use original parts only
	• Over loaded clamping of inserts by a lever (such as a pipe) may cause dangerous fracturing of parts and inserts	• Do not use lever inappropriately
Rotating tools	• In case of high speed machining, parts and inserts can be forced out by centrifugal force	• Use within recommended condition      · Use glasses or safety cover for your safety
	• Since cutter has sharp cutting edges touching with a bare-hand may cause a cut	• Use gloves or safety cover for your safety
	• It is dangerous to use glove with rotating machine • Contact with body or clothes is dangerous with rotating parts	• Do not wear gloves when you work with rotating machine • Keep your body and clothes away from rotating machine
	• Vibration generated by balancing trouble may cause a fracture and ejection of the tool which may cause serious injury	• RPM should be controled within recommended condition • Check the balance of rotating part periodically
	• In case of drilling, the uncut bottom core can fly out of the part with high speed and cause serious injury	• Use gloves or safety cover for your safety
Brazed tools	• The edges of small diameter drill are sharp and easy to break	• Concentrate on safety regulation in using tools. • Use glove or safety cover for your safety.
	• Fragmentation and ejection of brazed carbide tip may cause injury	• Check the brazed tip before using • Do not use at high temperature cutting condition
ETC	• There's a possibility of breaking the carbide tip after several brazing	• Do not use brazing a tip that has been brazed several times
	• Abusing may cause fragmentation of tool and is very dangerous	• Stick to safety regulations and guidelines

# KORLOY Inc. Code System

## Grade name for coated carbide



## Chip breaker



The same chip breaker code is used for both negative type and positive type.

## Terminology of tool formula

TERM	CODE	UNIT
Tool diameter	D	mm
Cutting speed	vc	m/min
Revolution per minute	n	min <sup>-1</sup>
Feed per minute	vf	mm/min
Feed per revolution	fn	mm/rev
Feed per tooth	fz	mm/t
Tooth	z	
Axial depth of cut	ap	mm
Radial depth of cut	ae	mm
Peak feed	pf	mm

TERM	CODE	UNIT
Horse power requirement	Pc	kW
Specific cutting resistance	kc	MPa
Torque	Mc	N.m
Thrust	Tc	N
Cycle time	tc	min
Tool life	T	min
Flank wear	V <sub>B</sub>	mm
Crater wear	K <sub>t</sub>	mm
Nose radius	r	mm

# Introduction of Digital Catalogue

## 1. Connect to the digital catalogue on PC or mobile

<https://catalog.korloy.com>

- Special tooling  
For special tooling such as gear, edge miller, railway, non-standard indexable & facemill

## 2. Guideline for main screen

**PC**

**Grade guide**  
Explanation of standard grades on the catalogue

**My assembly**  
Vivid assembly

**Log in/ registration**  
E-mail/password

**Language**  
Switch to the selected language

**Measurement unit**  
Metric/inch

**Current(UNUSED)**  
KRW/USD/EUR

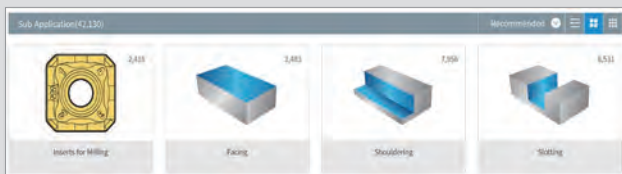
**Mobile**

**Search items**  
Search necessary item with its grade or designation

**Main application**  
Select the main application of necessary items.

## 3. Details

### Sub application



### Item group



### Item

Cart	K.P. Code	Designation	DC	DCX	CCT	APMX	DCOR-MS	LF	DNMS	WT	MBD	HAND
1	06-09883	RM14XCM50R-22-5-X06	50	58.562	0005	3.5	22	40	42	0.34	R	
2	06-09883	RM14XCM50R-22-5-X06	50	58.562	0006	3.5	22	40	42	0.34	R	
3	06-09883	RM14XCM50R-22-5-X06	50	58.562	0006	3.5	22	40	42	0.34	R	

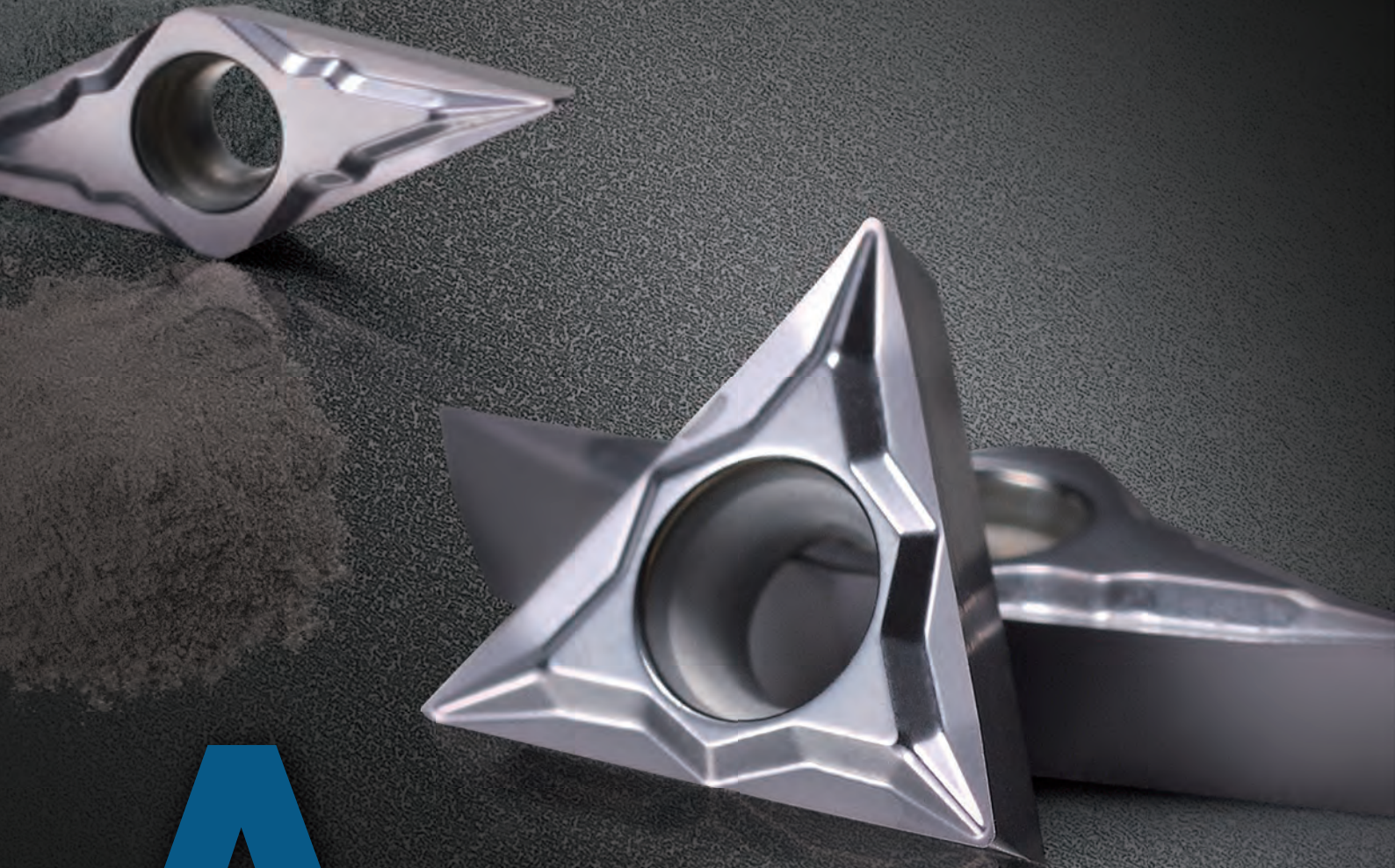
### Item data, 2/3D modeling, etc.

Cart	K.P. Code	Designation	DC	DCX	CCT	APMX	DCOR-MS	LF	DNMS	WT	MBD	HAND
1	06-09883	RM14XCM50R-22-5-X06	50	58.562	0005	3.5	22	40	42	0.34	R	



# GRADES & CHIP BREAKERS

KORLOY's new grades are designed with optimal substrates for each application and are PVD coated for high temperature, high hardness and oxidation resistance, or CVD coated for high temperature and wear resistance. Additionally, the improved post-coating treatment provides superior surface finishes to ensure the highest levels of quality and productivity.



# A



### Grades

**A02** KORLOY grades system

### Turning Grades

**A04** Turning grade selections  
**A05** CVD coated grades  
**A10** PVD coated grades  
**A12** Uncoated Carbide grades  
**A13** Cermet grades  
**A15** Coated Cermet grades

### Milling Grades

**A16** Milling grade selections  
**A17** CVD coated grades  
**A18** PVD coated grades  
**A23** Uncoated Carbide grades  
**A24** Cermet grades

### Solid Endmills & Solid Drills Grades

**A25** Solid Endmills grade selections  
**A26** Solid Endmills grades  
**A27** Solid Drills grade selections  
**A28** Solid Drills grades

### Others (Turning/Milling/Endmills)

**A29** Diamond coated grades  
**A30** DLC coated grades  
**A31** cBN inserts grades  
**A36** PCD inserts grades

### Chip Breakers

**A37** Chip Breaker for Turning  
**A42** Chip Breaker for Milling  
**A49** Chip Breaker for Drilling

## Grades system

### ➤ Cutting tool

Uncoated carbide	P	Steel	ST10	ST20	ST30A
	M	Stainless steel	U20		
	K	Cast iron	H01	H05	G10
	S	Titanium alloy	H01	H05	
	N	Aluminum ally/Copper ally	H01	H05	
	H	Hardened steel	H01		

Coated carbide for turning	P	Steel	NC3215	NC3225	NC3120	NC3030	NC5330	PC5300	PC5400	PC3035			
	M	Stainless steel	PC8105	PC8110	PC8115	PC8120	NC9115	NC9125	NC5330	NC9135	PC5300	PC9030	PC5400
	K	Cast iron	NC6310	NC6315	NC5330	PC5300	PC5400						
	S	Heat resistant alloy	PC8105	PC8110	PC8115	PC8120	NC9125	NC9135	PC5300	PC5400			
	N	Non-ferrous metal	ND3000	PD1005	PD1010								
	H	Hardened steel	PC8105	PC8110	PC8115								

Multi-functional	P	Steel	NC3210	NC3225	NC3030	NC5330	PC3035
	M	Stainless steel	PC9030	PC5300			
	K	Cast iron	NC6315	PC5300			
	S	Heat resistant alloy	PC8110	PC5300			
	N	Non-ferrous metal	H01	H05			
	H	Hardened steel	PC8110	PC5300			

Coated carbide for milling	P	Steel	NC5330	NCM535	PC3700	PC5300	PC5400	NCM545
	M	Stainless steel	NC5330	PC5300	PC9530	PC5400	PC9540	
	K	Cast iron	PC6510	NC5330	NCM535	PC5300	PC5400	NCM545
	S	Heat resistant alloy	PC5300	PC5400	PC9540			
	N	Non-ferrous metal	ND3000	PD1005	PD1010			
	H	Hardened steel	PC2005	PC2010	PC2015	PC210F	PC2505	PC2510

Coated carbide for drills, endmills	P	Steel	PC3700	PC5300	PC5335	PC9530	PC9540	NC5330	NCM535
	M	Stainless steel	PC5300	PC5335	PC9530	PC9540			
	K	Cast iron	PC6510	PC5300					
	S	Heat resistant alloy	PC5300	PC9530	PC9540				
	N	Non-ferrous metal	H01						





# Grades system

## ➤ Cutting tool

Turning cermet	P	Steel	CN1500	CN2500
	K	Cast iron	CN1500	CN2500

Coated carbide for turning cermet	P	Steel	CC1500	CC2500
	K	Cast iron	CC1500	CC2500

Milling cermet	P	Steel	CN2500	CN30
----------------	---	-------	--------	------

Solid endmills	P M K	Steel	PC203F	PC215F	PC303S	PC310U	PC315E	PC320	PC320S
	S	Heat resistant alloy	PC320	PC320S	SL				
	H	Hardened steel	PC203F	PC303S	PC310U				
	N	Non-ferrous metal	ND3000	ND2100	PD1005	PD1010	PC210C	H01	H05S

Solid drills	P M K	Steel	PC325U	PC215G	PC315G	PC230F
	S	Heat resistant alloy	PC325T			
	N	Non-ferrous metal	FG2	FA1	ND2100	

cBN	K	Cast iron	DBN500	DBN700A			
	S	Heat resistant alloy	DBN700				
	H	Hardened steel	DB1000	DB2000	DBNX20	DBN250	DBN350

Coated cBN	H	Hardened steel	DNC100	DNC250	DNC350	DNC400
------------	---	----------------	--------	--------	--------	--------

PCD	N	Non-ferrous metal	DP90	DP150	DP200
-----	---	-------------------	------	-------	-------

## ➤ Wear resistance tool

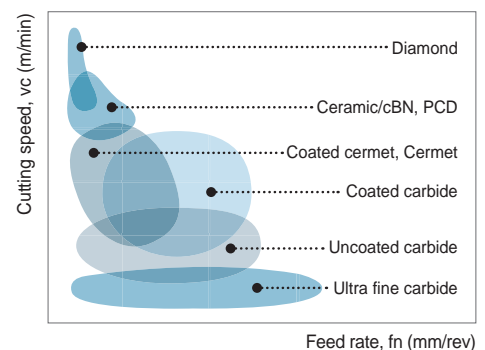
Ultra fine grain cemented carbide	Z	Ultra fine grain cemented carbide	FS1	FA1	FCC
-----------------------------------	---	-----------------------------------	-----	-----	-----

Uncoated carbide	V	Wear parts	D1	D2	D3	G5
	I	Corrosion resistance	IN10	IN20	IN40	

## ➤ Mining tool

Uncoated carbide	E	General	GR10	GR20	GR30	GR35	GR40
------------------	---	---------	------	------	------	------	------

## ➤ Application range



Feed rate,  $f_n$  (mm/rev)

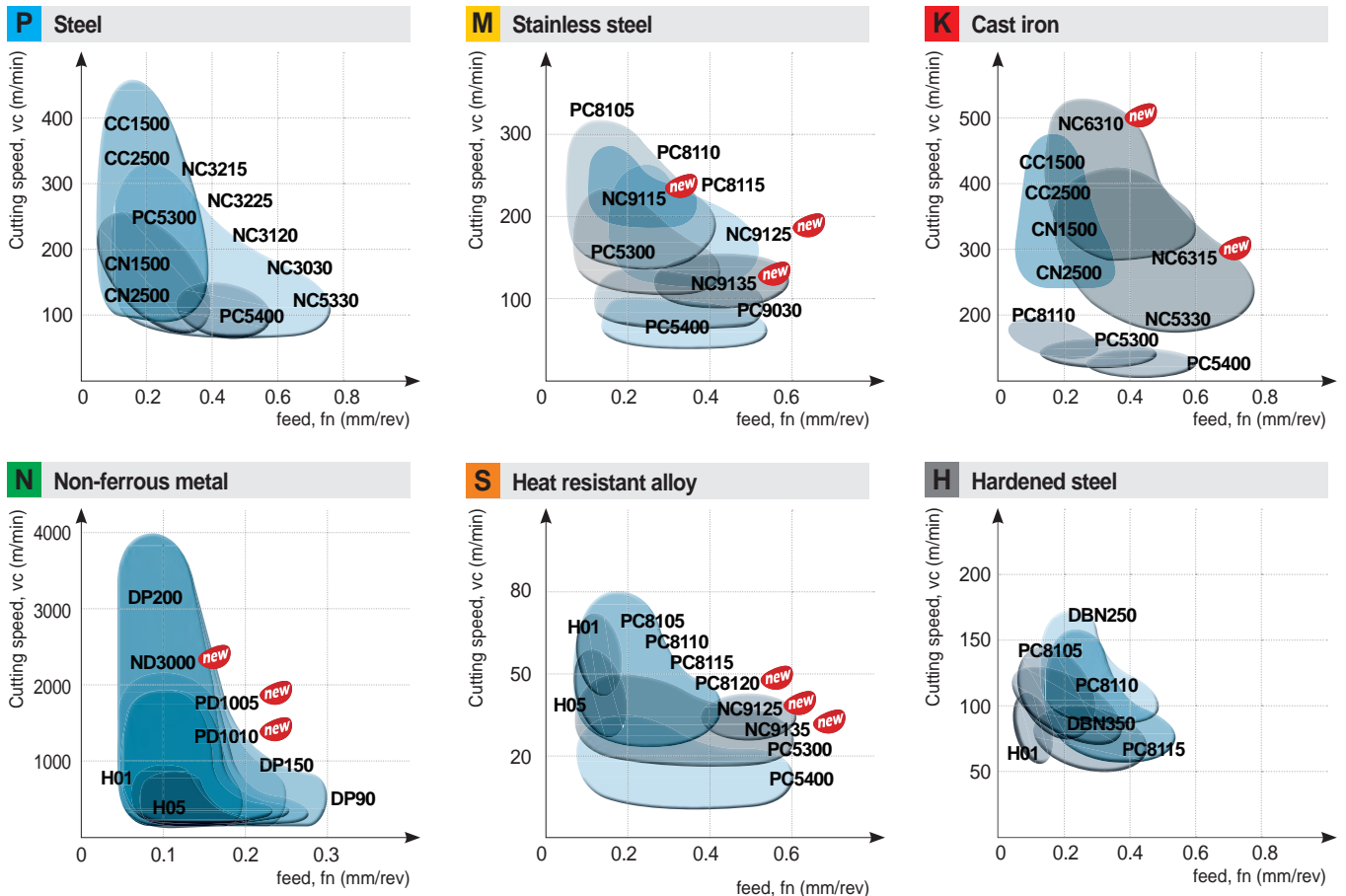


## Turning grade selections

### Selection system

Workpiece	P					M				K				S				N			H								
	ISO	P01	P10	P20	P30	P40	P50	M10	M20	M30	M40	K01	K10	K20	K30	S01	S10	S20	S30	N01	N10	N20	N30	H01	H10	H20	H30		
Coated carbide			NC3215					PC8105				NC6310 <i>new</i>			PC8105					ND3000 <i>new</i>							PC8105		
			NC3225					PC8110					NC6315		PC8110						PD1005 <i>new</i>						PC8110		
			NC3120					PC8115							PC8115													PC8115	
				NC3030				NC9115 <i>new</i>						NC5330		PC8120 <i>new</i>						PD1010 <i>new</i>					PC8115		
				NC5330				NC9125 <i>new</i>						PC5300		NC9125 <i>new</i>												PC8115	
				PC5300				NC9135 <i>new</i>								NC9135 <i>new</i>													
					PC5400			PC5300								PC5400													
								PC9030																					
									PC5400																				
Cermets		CC1500											CC1500																
		CC2500											CC2500																
		CN1500											CN1500																
			CN2500										CN2500																
cBN / PCD												DBN700			DB7000						DP90					DNC100			
												DBN800									DP150					DNC250			
												DBN500									DP200					DNC400			
																										DNC350			
Uncoated carbide		ST10						U20				H01			H01						H01					H01			
			ST20									H05			H05							H05							
				ST30A																									
													G10																

### Application range of turning grades



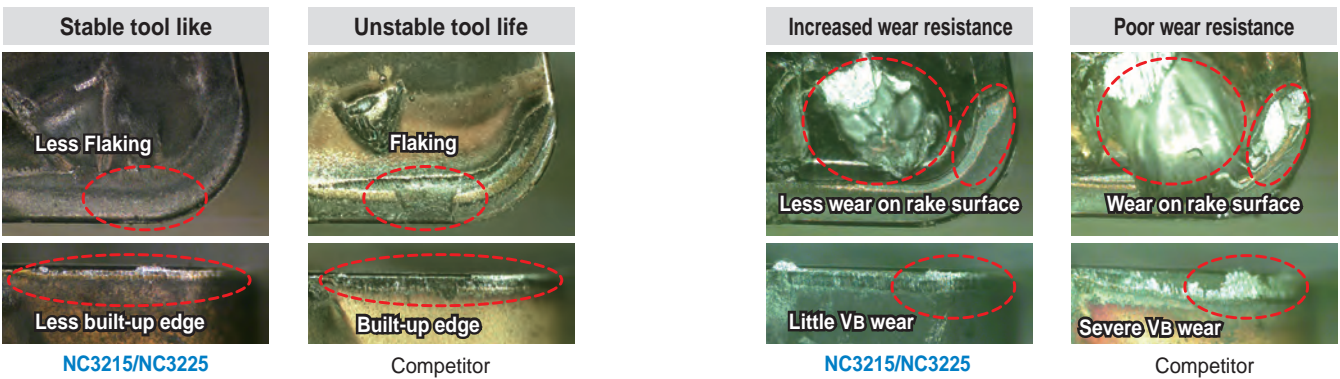
**CVD coated grades**

# NC3215/NC3225

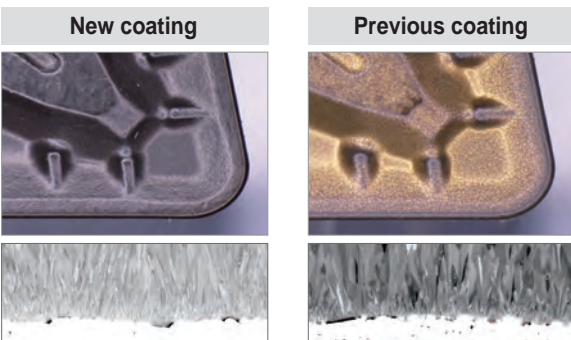
- Universal grade especially for machining forged automobile components and bearing steel both in continuous and interrupted cutting
- Available for all kinds of steels - carbon steel, alloy steel, rolled steel, tool steel, mild steel, bearing steel and other special kinds of steel
- New coating technology increases welding resistance and chipping resistance, which leads to longer tool life.

**Features**

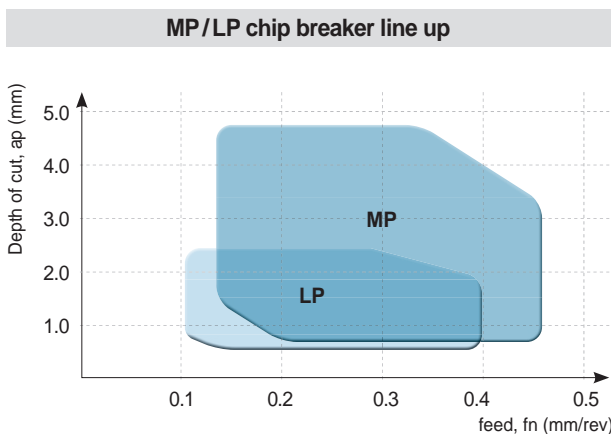
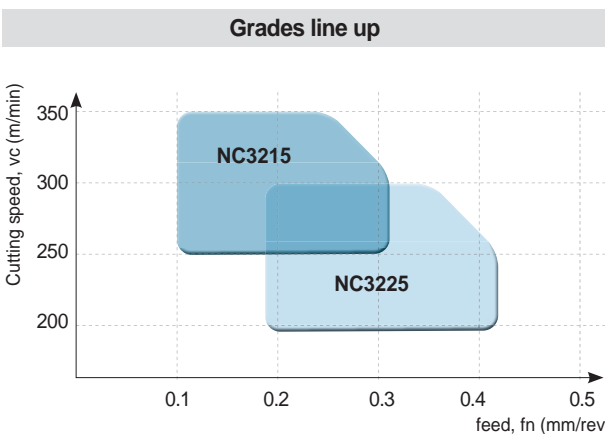
- Stable tool life  
→ Higher production stability
- Longer tool life & Higher removal rate  
→ High cutting conditions and shorter cutting time available
- Ideal combination of a grade and chip breakers  
→ Prolongs tool life  
→ Wide applications ranging from roughing to finishing



• Disperse cutting force → Reduce chipping → Increase tool life → Improved productivity



**Application range**



## CVD coated grades

CVD coated grade for high efficiency and quality turning of cast iron

# NC6310 **new** / NC6315 **new**

- CVD coating with improved wear resistance and chipping resistance.
- Solutions for the most common issues in cast iron machining: Preventing excessive wear on rake and flank surfaces of insert, chipping and burr

### Features of NC6310

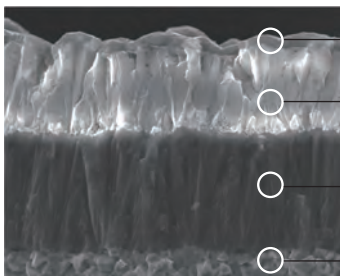
Normal wear on rake surface and nose radius



NC6310

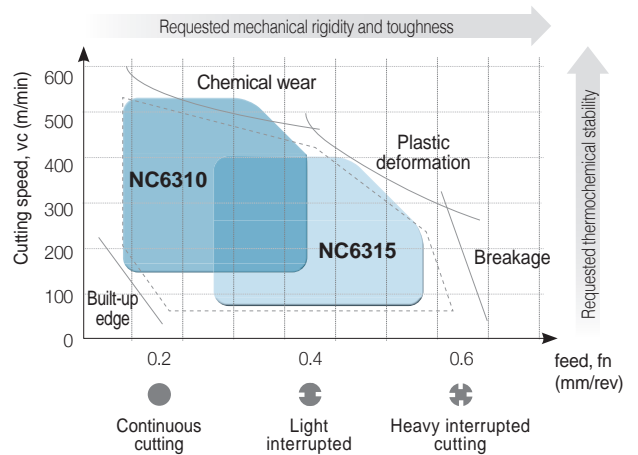


Existing grade (K10)



- Titanium layer with excellent lubrication identifying wear
- Alumina layer specialized for heat resistance
- Titanium layer with improved fracture resistance
- Functional substrate optimized for high speed cast iron machining

### Recommended machining range for each grade

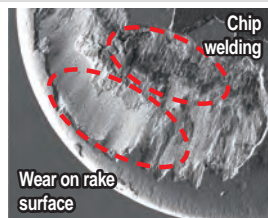


### Features of NC6315

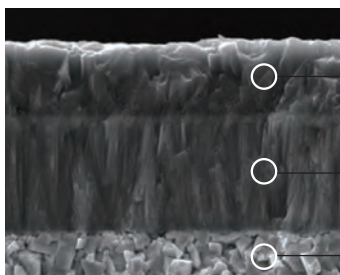
Improved flaking resistance and wear resistance on rake surface



NC6315



Existing grade (K15)



- Alumina layer with better surface finish and improved wear resistance and welding resistance
- Titanium layer with improved fracture resistance
- Functional substrate optimized for high feed and heavy interrupted cast iron machining

Normal wear on flank surface



NC6315



Existing grade (K15)



**CVD coated grades**

Turning grades for stainless steel

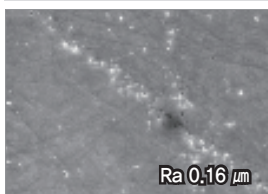
NC9115 **new** / NC9125 **new** / NC9135 **new**

- Optimized for reducing built-up edges, notch wear, plastic deformation and burrs, and for machining stainless steel
- Ideal combination of a grade and MM/RM chip breakers for stable tool life and wide applications ranging from roughing to finishing
- Stable tool life even at high speeds, feeds and depth of cuts (for STS316, vc over 150 m/min available), shortening cutting time
- Excellent versatility responding to workpiece change, covering the austenite, the martensite and the ferrite
- NC9115 is for P20 class, mild steel and forged steel machining.

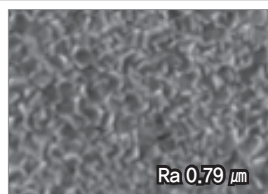
**Features**

- Improved surface finish thanks to the new lubricative CVD coating

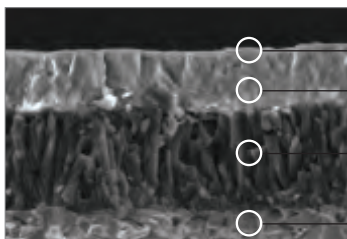
**Lubricative coating layer to prevent built-up edge**



NC9100 Series



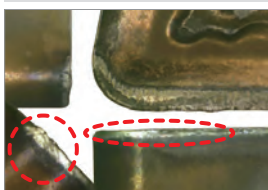
Existing coating



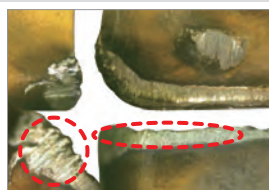
- Top coat with improved welding resistance
- Alumina coating layer for high speed cutting
- Titanium coating layer with stronger resistance to chipping
- Tough substrate optimized for continuous cutting and both light & heavy interruption

- Lubricative coating layers → Improves welding resistance

**Inhibited built-up edge and blade damage**



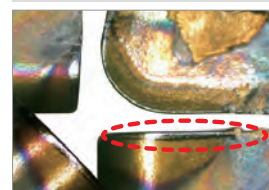
NC9125 (M25)



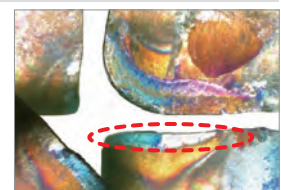
Competitor (M25)

- Coated layers of stronger chipping resistance and the substrate of high toughness → Inhibits notch wear creation

**Inhibited wear on notch and relief surface**



NC9135 (M35)



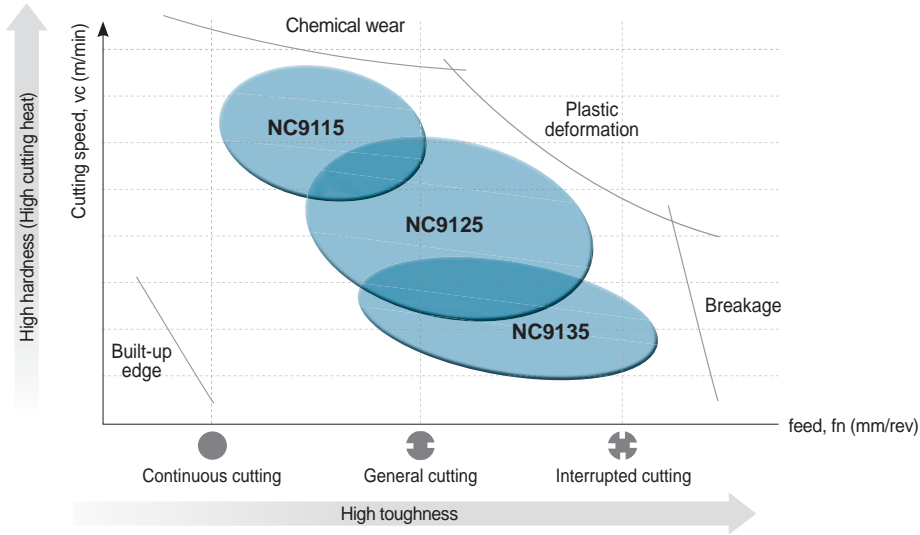
Competitor (M35)





## CVD coated grades

### Grades line up



### Recommended grade and chip breaker per stainless steel type

#### [Austenitic stainless steel]

Grade	Cutting speed (m/min)				
	50	100	150	200	250
NC9115				160	220
NC9125			150	200	
NC9135		100	150		

#### [Duplex stainless steel]

Grade	Cutting speed (m/min)				
	50	100	150	200	250
NC9115			120	160	
NC9125		100	140		
NC9135		60	100		

#### [Ferritic / Martensitic stainless steel]

Grade	Cutting speed (m/min)				
	50	100	150	200	250
NC9115			150		250
NC9125			120	220	
NC9135		100	150		

#### [Precipitation hardened (PH) stainless steel]

Grade	Cutting speed (m/min)				
	50	100	150	200	250
NC9115	50	110			
NC9125	40	110			
NC9135	30	100			





## Selection system of CVD coated grade

Workpiece	Machining types	Recommended grade	Recommended cutting speed (m/min)	ISO	Application range
P Steel	Continuous cutting	NC3215	295 (170~420)	P10	
	Interrupted cutting	NC3225	260 (150~370)	P15	← NC3215
		NC3120	260 (120~370)	P20	NC3225 →
		NC3030	205 (120~290)	P30	NC3120 →
		NC5330	185 (110~260)	P35	NC3030 → NC5330
M Stainless steel	Continuous cutting	NC9115 <sup>new</sup>	240 (220~260)	M10	← NC9115 <sup>new</sup>
		NC9125 <sup>new</sup>	210 (190~230)	M20	NC9115 <sup>new</sup> → NC9125 <sup>new</sup> → NC5330
	Interrupted cutting	NC9135 <sup>new</sup>	180 (160~200)	M30	NC9125 <sup>new</sup> →
				M40	NC9135 <sup>new</sup>
K Cast iron	Continuous cutting	NC6310 <sup>new</sup>	380 (300~500)	K10	← NC6310 <sup>new</sup>
	Interrupted cutting	NC6315	280 (200~400)	K20	NC6310 <sup>new</sup> → NC6315
		NC5330	190 (110~270)	K30	NC6315 → NC5330
S HRSA	Continuous cutting	NC9125 <sup>new</sup>	40 (20~60)	S10	← NC9125 <sup>new</sup>
	Interrupted cutting	NC9135 <sup>new</sup>		S20	NC9125 <sup>new</sup> → NC9135 <sup>new</sup>

## The features of CVD coated grades

CVD Coated grades	ISO	Features
NC3215	P10~P15	<ul style="list-style-type: none"> <li>Continuous machining of general steel and forged steel at high speed</li> <li>Substrate with excellent thermal crack/plastic deformation resistance, coating with improved chipping resistance for continuous machining • MT-TiCN + Al<sub>2</sub>O<sub>3</sub> + TiN</li> </ul>
NC3225	P20~P25	<ul style="list-style-type: none"> <li>Universal grade for general steel and forged steel</li> <li>1st recommended grade for general machining with the use of high toughness substrate and coating layer with improved welding/chipping resistance • MT-TiCN + Al<sub>2</sub>O<sub>3</sub> + TiN</li> </ul>
NC3120	P20~P25	<ul style="list-style-type: none"> <li>Medium to roughing for steel</li> <li>Combining excellent fracture resistance substrate with chipping resistance and heat resistance Al<sub>2</sub>O<sub>3</sub> increased stability</li> <li>MT-TiCN + TiC + Al<sub>2</sub>O<sub>3</sub></li> </ul>
NC3030	P25~P35	<ul style="list-style-type: none"> <li>Medium to low speed machining of steel and interrupted roughing</li> <li>Harmony between substrate with excellent wear/fracture resistance and Al<sub>2</sub>O<sub>3</sub> film with excellent thermal/chipping resistance</li> <li>Increased stability in wide ranges of cutting conditions • MT-TiCN + TiC + Al<sub>2</sub>O<sub>3</sub> + TiN</li> </ul>
NC5330	P30~P35 M25~M35 K15~K25 S15~S25	<ul style="list-style-type: none"> <li>Stainless Steel - General cutting for mild steel &amp; forging steel</li> <li>Excellent cutting performance in hard to cut materials which are vulnerable to built up edge, due to the high tough substrate with improved fracture resistance and the coated layers</li> <li>MT-TiCN + Al<sub>2</sub>O<sub>3</sub> + TiN</li> </ul>
NC9115 <sup>new</sup>	M10~M20	<ul style="list-style-type: none"> <li>High speed cutting for ferritic and martensitic stainless steels</li> <li>MT-TiCN + Al<sub>2</sub>O<sub>3</sub> + TiN</li> </ul>
NC9125 <sup>new</sup>	M20~M30	<ul style="list-style-type: none"> <li>General cutting of stainless steel and heat resistant alloys</li> <li>MT-TiCN + Al<sub>2</sub>O<sub>3</sub> + TiN</li> </ul>
NC9135 <sup>new</sup>	M30~M40	<ul style="list-style-type: none"> <li>Interrupted cutting of stainless steel and heat resistant alloys</li> <li>MT-TiCN + Al<sub>2</sub>O<sub>3</sub> + TiN</li> </ul>
NC6310 <sup>new</sup>	K01~K10	<ul style="list-style-type: none"> <li>High speed and continuous cutting of grey cast iron</li> <li>Increased tool life due to coating layer with high wear resistance</li> <li>MT-TiCN + Al<sub>2</sub>O<sub>3</sub> + TiN</li> </ul>
NC6315	K10~K20	<ul style="list-style-type: none"> <li>Universal grade for ductile and gray cast Iron</li> <li>Excellent performance thanks to the alumina (Al<sub>2</sub>O<sub>3</sub>) coating's improved grip on the tough substrate</li> <li>MT-TiCN + Al<sub>2</sub>O<sub>3</sub></li> </ul>



## PVD coated grades

Turning grade for heat resistant alloy and stainless steel

### PC8105

- Micro grain carbide minimizes chipping of cutting edge due to enhanced edge strength
- Latest PVD coating technology with high hardness and high temperature oxidation resistance
- Excellent tool life when finishing heat resistant alloys and stainless steels at high speeds

### PC8115

- Ultra fine matrix technology increases wear resistance and chipping resistance.
- PVD coating technology with high hardness and oxidation resistance at high temperature
- Strong cutting edge and excellent chipping resistance guarantees stable machining
- Long tool life when machining heat resistant alloy and stainless steel at middle to low speed and medium cutting to roughing

### PC8110

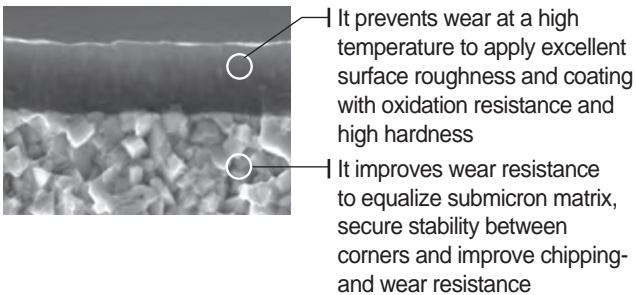
- Substrate with superior wear resistance and plastic deformation resistance at high temperature
- PVD coating technology with high hardness and oxidation resistance at high temperature
- Long tool life when machining heat resistant alloy and stainless steel at high speed

### PC8120 new

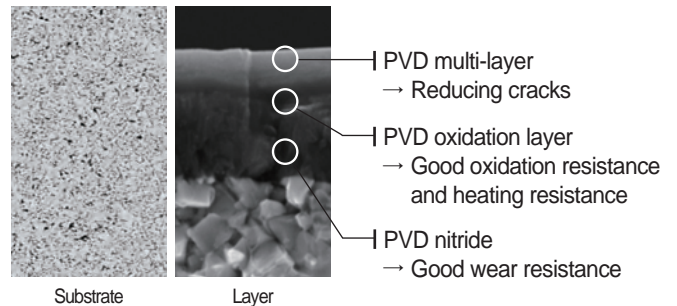
- Control technology for uniform ultra-fine substrate increases wear resistance and chipping resistance.
- The new PVD dioxide film enhances oxidation resistance and heating resistance.
- Special technology of coating surface treatment prevents chipping and realizes stable machining.

## Features

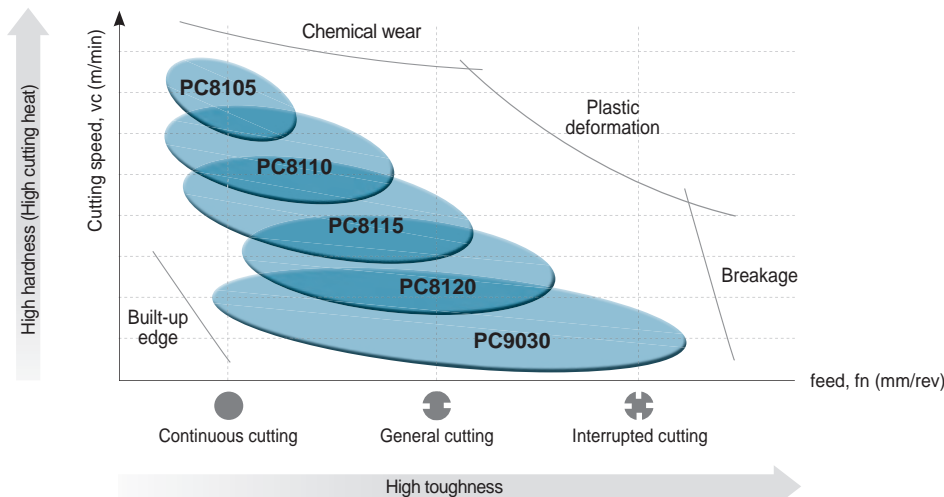
### Features of PC8105/10/15 series



### PC8120



## Grades line up



## Selection system of PVD coated grade

Workpiece	Machining types	Recommended grade	Recommended cutting speed (m/min)	ISO	Application range
P Steel	Continuous cutting	PC5300	175 (100~250)	P30	PC5300
	Interrupted cutting		145 (80~120)	P40	
M Stainless steel	Continuous cutting	PC5400	125 (80~160)	P50	PC5400
		PC8105	175 (120~230)	M01	PC8105
		PC8110	160 (110~210)	M10	
	PC8115/8120 <sup>new</sup>	150 (100~200)	M20		
	Interrupted cutting	PC5300	135 (80~190)	M30	PC5300
		PC9030	130 (80~180)	M40	PC9030
		PC5400	110 (80~140)	M50	PC5400
PC8115		150 (100~200)	M20	PC8115	
K Cast iron	Continuous cutting	PC8110	135 (95~180)	K10	PC8110
		PC5300	105 (75~140)	K30	PC5300
	Interrupted cutting	PC5400	90 (65~120)	K40	PC5400
		PC8105	55 (40~70)	S01	PC8105
S Heat resistant alloy	Continuous cutting	PC8110	50 (35~65)	S10	PC8110
		PC8115/8120 <sup>new</sup>	45 (30~60)	S20	PC8115
		PC5300	40 (20~60)	S30	PC8120 <sup>new</sup>
	Interrupted cutting	PC5400	35 (20~50)	S40	PC5300
		PC8110	100 (70~130)	H05	PC8110
		PC8115	90 (65~115)	H10	PC8115

## The features of PVD coated grades

PVD Coated grades	ISO	Features
PC8105	M05~M15 S01~S10 H01~H05	<ul style="list-style-type: none"> <li>For high speed and continuous finishing of hard-to-cut materials and STS</li> <li>Excellent cutting performance with high wear resistance and oxidation resistance</li> <li>Ultra fine substrate and the new TiAlN coating layer</li> </ul>
PC8110	M10~M20 K10~K20 S05~S15 H05~H10	<ul style="list-style-type: none"> <li>For high speed and continuous medium cutting of hard-to-cut materials and STS</li> <li>Excellent tool life with high wear/plastic deformation resistance at high temperature</li> <li>New TiAlN coating layer and substrate with excellent thermal resistance</li> </ul>
PC8115	M15~M25 S10~S20 H10~H15	<ul style="list-style-type: none"> <li>For medium to low speed and medium to rough cutting of hard-to-cut materials and STS</li> <li>Excellent tool life with high wear resistance and chipping resistance</li> <li>Ultra fine substrate and the new TiAlN coating layer</li> </ul>
PC8120 <sup>new</sup>	M15~M25 S10~S20	<ul style="list-style-type: none"> <li>For hard-to-cut materials and STS roughing</li> <li>Applied ultra-fine substrate and new PVD oxidation layer</li> <li>Better chipping resistance and fracture resistance than PC8115</li> </ul>
PC5300	P30~P40 M20~M30 K20~K25 S15~S25	<ul style="list-style-type: none"> <li>Universal grade for stainless, HRSA, steel and interrupted cast iron machining</li> <li>High chipping and welding resistance for longer tool life</li> <li>New TiAlN coating and ultra fine grain substrate adopted</li> </ul>
PC9030	M25~M35	<ul style="list-style-type: none"> <li>Medium, roughing and heavy interrupted cutting for stainless steel</li> <li>TiAlN coating and ultra fine grain substrate adopted</li> <li>High chipping and welding resistance for stable machining</li> </ul>
PC5400	P35~P45 M30~M40 K30~K35 S25~S35	<ul style="list-style-type: none"> <li>For medium cutting for hard-to-cut materials, stainless steel, steel, and cast iron at medium or low speed</li> <li>Stable machinability with chipping resistance, fracture resistance and welding resistance</li> <li>Ultra fine substrate with high toughness and new AlCrN layer</li> </ul>



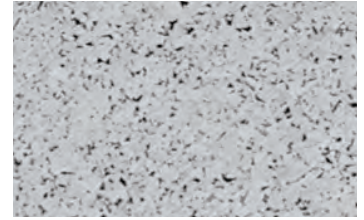
# A Turning Grades

## Uncoated carbide grades

### Uncoated carbide grades for turning application of titanium

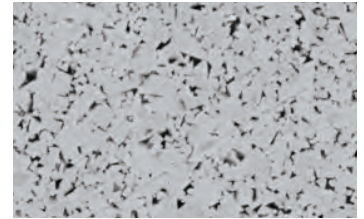
#### H01

- Increased wear resistance and chipping resistance with the use of ultra fine substrate
- Improved welding resistance and chipping resistance with the use of special surface treatment and sharp cutting edge of VP chip breaker
- Excellent tool life when finishing titanium alloy at high speed

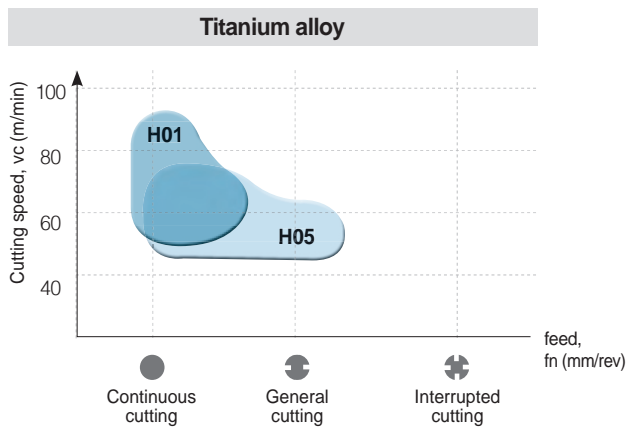


#### H05

- The 1st recommended grade for machining titanium alloy in a variety of cutting conditions
- Improved welding resistance and chipping resistance with the use of special surface treatment and sharp cutting edge of VP chip breaker
- Ideal for medium cutting of titanium alloy



### Grades line up



### Selection system of uncoated carbide grades

Workpiece	Recommended grade	Recommended cutting speed (m/min)	ISO	Application range
P Steel	ST10	110 (70~140)	P10	ST10
	ST20	80 (50~110)	P20	ST20
	ST30A	70 (40~90)	P30	ST30A
M Stainless steel	U20	70 (40~90)	M25	U20
K Cast iron	H01	105 (60~140)	K01	H01
	H05	105 (60~140)	K10	H05
	G10	90 (50~120)	K20	G10
N Aluminum alloy Copper alloys	H01	600 (450~750)	N10	H01
	H05	425 (320~530)	N20	H05
S Titanium alloy	H01	55 (40~70)	S01	H01
	H05	50 (35~65)	S10	H05
H High hardness steel	H01	80 (55~105)	H10	H01

### Main composition and application range

Workpiece	Composition	Features	Workpiece
P	WC-TiC-TaC-Co	Heat resistance, excellent plastic deformation resistance	Carbon steel, Alloy steel, Stainless steel
M	WC-TiC-TaC-Co	General tools stable heat resistance with strength	Carbon steel, Alloy steel, Stainless steel, Cast steel
K	WC-Co	High strength and superior wear resistance	Cast iron, Non-ferrous metal, Plastic, etc
S	WC-Co	Excellent wear resistance and chipping resistance	Titanium alloy



## 🔍 The physical properties of uncoated carbide grades

Workpiece	Grade	Hardness (HRA)	TRS (kgf/mm <sup>2</sup> )	Young's modulus (10 <sup>3</sup> kgf/mm <sup>2</sup> )	Thermal expansion coefficient (10 <sup>-6</sup> /°C)	Thermal conductivity (cal/cm · sec·°C)
P	ST10	92.1	175	48	6.2	25
	ST20	91.9	200	56	5.2	45
	ST30A	91.3	230	53	5.2	-
M	U20	91.1	210	-	-	88
	ST30A	91.3	230	53	5.2	-
K	H01	92.9	210	66	4.7	109
	G10	90.9	250	63	-	105
S	H01	92.9	210	66	4.7	109
	H05	91.8	250	-	-	-

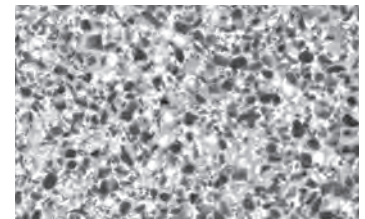
1KPa = 102kgf/m<sup>2</sup>, 1w/mk = 2.39×10<sup>-3</sup>cal/cm·sec·°C

## Cermets grades

### Solution for turning application of steel

## CN1500

- For continuous machining of cold/hot forged steel and Sintered ferrous alloy at high speed and low depth of cut
- Excellent wear resistance and crater resistance
- Improved surface roughness acquired by optimized cutting edges



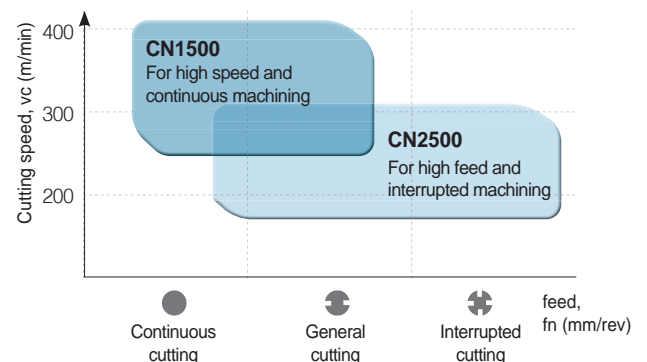
## CN2500

- For high interrupted machining of cold/hot forged steel and Sintered ferrous alloy at high feed and high depth of cut
- Excellent resistance against chipping, fracture and thermal crack
- Improved surface roughness acquired by optimized cutting edges

## 🔍 Recommended cutting condition

Division	Workpiece	Grade	Recommended cutting speed (m/min)		
			Minimum	Recommended	Maximum
Turning	SM10C, SS440	CN1500	150	<b>270</b>	400
		CN2500	130	<b>240</b>	350
	SM45C	CN1500	150	<b>250</b>	350
		CN2500	130	<b>220</b>	300
	SCM440, Sintered Fe ferrous alloy	CN1500	120	<b>220</b>	300
		CN2500	100	<b>200</b>	250

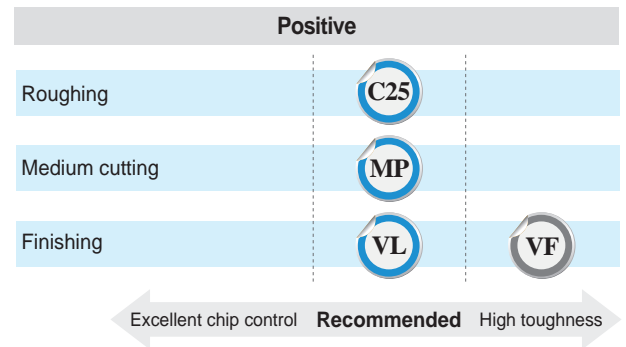
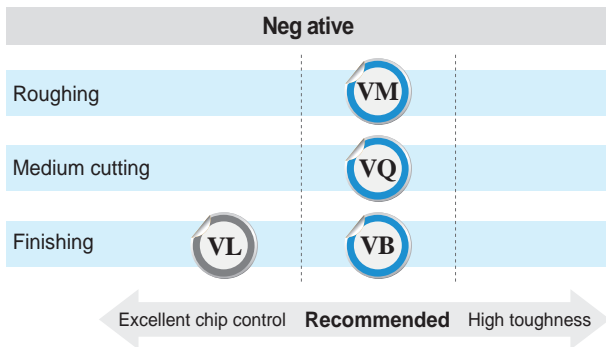
## 🔍 Grades line up



# A Turning Grades

## Cermet grades

### Chip breakers line up



### Selection system of cermet grades

Workpiece	Machining types	Recommended grade	Recommended cutting speed (m/min)	ISO	Application range
P	Steel	Continuous cutting	250 (150~350)	P10	
		Interrupted cutting	220 (130~300)	P20	
				P30	

### Comparison of chip breakers

Insert types	Machining types	Application range	Chip breakers				
			KORLOY	Competitor A	Competitor B	Competitor C	Competitor D
Nega type	Continuous cutting	For machining mild steel with enhanced chip control	VL	FA	GP	TF	FA
	General cutting	For low interrupted cutting with stronger cutting edges than VG chip breaker	VB	FG	XP CQ	TSF TS	LU SE
	General cutting	For medium cutting to finishing at low interruption	VQ	MC	HQ	AS, ZM	SU
	Interrupted cutting	For medium cutting to roughing at high interruption	VM	MT	HS	TM	GU
Posi type	Continuous cutting	For machining mild steel with enhanced chip control	VL	FA	GP	PF	FP
	Continuous cutting	Enhanced chip control when machining internal diameter with stronger cutting edges than VL chip breaker	VF	FG-PC	HQ	PS	LU
	General cutting	For medium cutting to finishing at low interruption	MP	FG	HQ	PS	LU
	Interrupted cutting	For medium cutting to roughing at high interruption	C25	MT	GK	24	SC





## Coated cermet grades

Coated cermet for machining carbon steel, alloy steel and sintered ferrous components

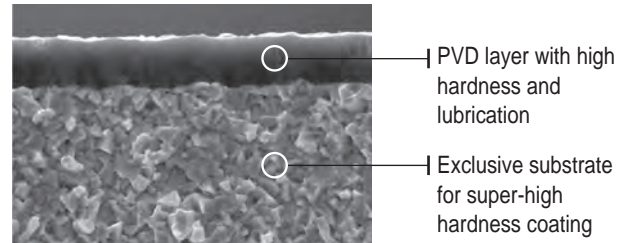
### CC1500 **new**

- Maximized resistance to built-up edge and oxidation in continuous cutting at high speeds and low depth of cuts
- Superior wear resistance vs. existing tools in continuous cutting of carbon steel and alloy steel

### CC2500 **new**

- Maximized resistance to built-up edge and oxidation in interrupted cutting at high feeds and high depth of cuts
- Superior impact resistance vs. existing tools in interrupted cutting of carbon steel and alloy steel

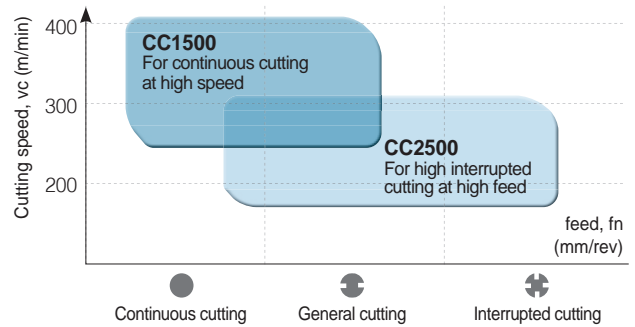
#### Features



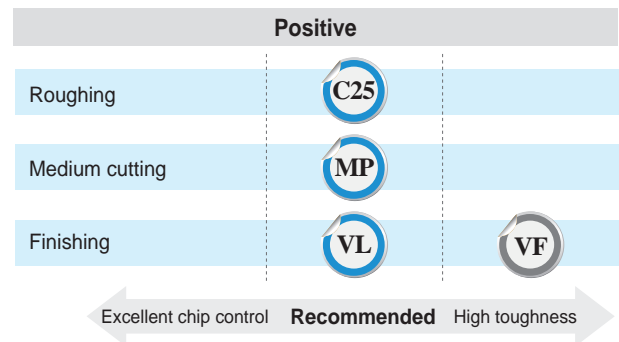
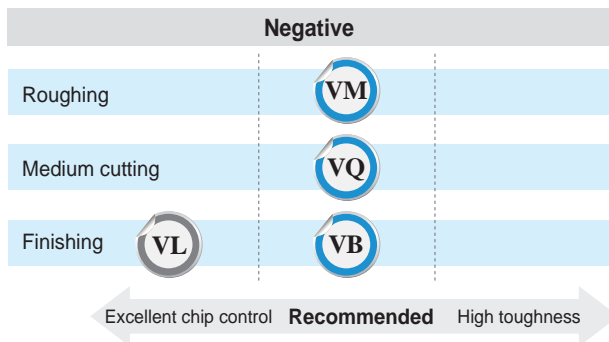
#### Recommended cutting condition

Division	Workpiece	Grade	Recommended cutting speed (m/min)		
			Minimum	Recommended	Maximum
Turning	SM10C, SS440	CC1500	200	350	450
		CC2500	180	290	400
	SM45C	CC1500	200	300	400
		CC2500	180	270	350
	SCM440, Sintered Fe ferrous alloy	CC1500	180	270	350
		CC2500	150	250	300

#### Grades line up



#### Chip breakers line up



#### Selection system of coated cermet grades

Workpiece	Machining types	Recommended grade	Recommended cutting speed (m/min)	ISO	Application range
P Steel	Continuous cutting	CC1500	325 (200~450)	P10	CC1500
	Interrupted cutting	CC2500	265 (180~350)	P20, P30	CC2500
K Cast iron	Continuous cutting	CC1500	270 (180~350)	K10	CC1500
	Interrupted cutting	CC2500	250 (150~300)	K20	CC2500

#### The features of coated cermet grade

Coated cermet	ISO	Features
CC1500	P10~P20 / K05~K15	• PVD coated Cermet • Light cutting for steel and cast iron in high speed machining • Optimized for precision boring
CC2500	P20~P30 / K10~K20	• PVD coated Cermet • Light cutting for steel and cast iron in medium or high speed machining • Dry and wet cutting are available

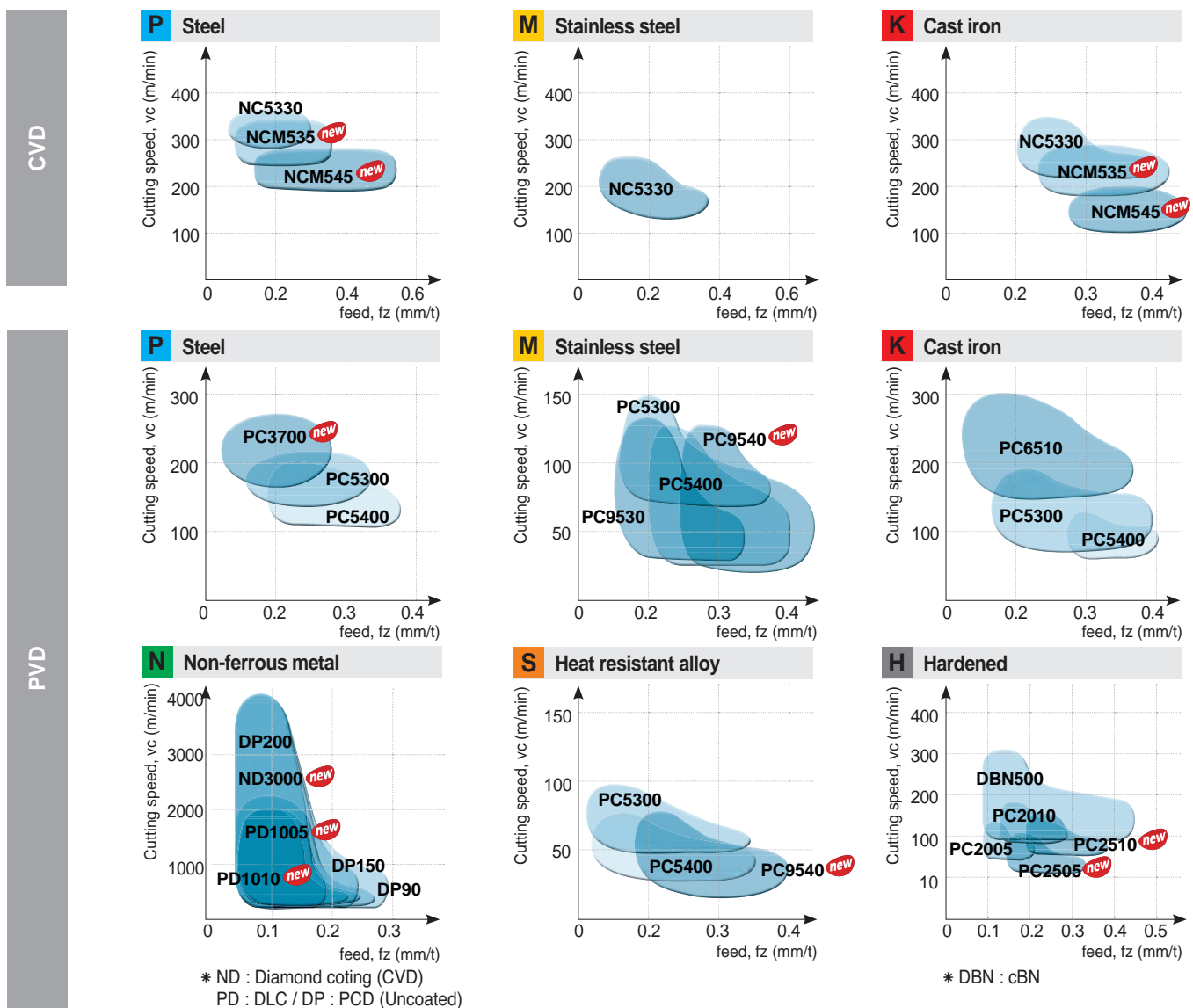


## Milling grade selections

### Selection system

피삭재	P Steel				M Stainless steel				K Cast iron				S HRSA				N Nonferrous			H Hardened						
ISO	P10	P20	P30	P40	P50	M10	M20	M30	M40	K01	K10	K20	K30	K40	S10	S20	S30	S40	N01	N10	N20	N30	H01	H10	H20	H30
Coated carbide			NC5330					NC5330		PC6510								PC5300		ND3000 <i>new</i>					PC2005	
			PC3700 <i>new</i>					PC5300		NC5330								PC5400		PD1005 <i>new</i>					PC2505 <i>new</i>	
			NCM535 <i>new</i>					PC9530		PC5300								PC9540 <i>new</i>		PD1010 <i>new</i>					PC2010	
			PC5300					PC5400		NCM535 <i>new</i>															PC2510 <i>new</i>	
			NCM545 <i>new</i>					PC9540 <i>new</i>		PC5400															PC2015	
			PC5400							NCM545 <i>new</i>															PC210F	
Cermet		CN2500																								
		CN30																								
cBN / PCD																				DP90					DBN500	
																				DP150						
																				DP200						
Uncoated carbide		ST20						U20		H01																
		ST30A								H05																
										G10																
																				H01						
																				H05						

### Application range



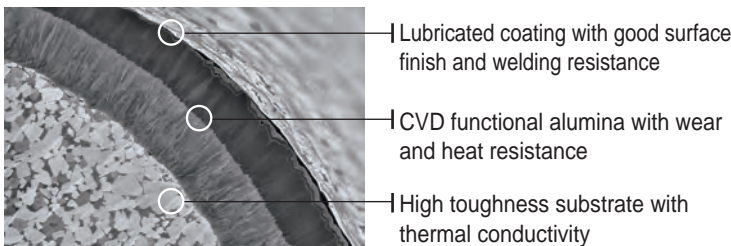
# CVD coated grades

Milling Solutions for Steel and Cast Iron

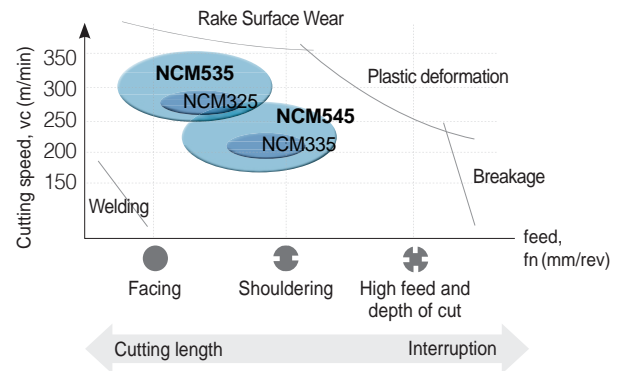
## NCM535 <sup>new</sup> / NCM545 <sup>new</sup>

- Improved chipping resistance / heat and crack resistance: Applied after treatment with good chipping resistance and heat and crack resistance
- Improved wear and heat resistance: Applied high toughness substrate and high functional CVD alumina

### Features



### Guideline for grade application



### Selection system of CVD coated grades

Workpiece	Machining types	Recommended grade	Recommended cutting speed (m/min)	ISO	Application range
P Steel	Continuous cutting	NC5330	200 (150~250)	P20	NC5330
	Continuous cutting	NCM535 <sup>new</sup>	300 (200~400)	P30	
	Interrupted cutting	NCM545 <sup>new</sup>	200 (150~250)	P40	NCM535 <sup>new</sup>
M Stainless steel	Continuous cutting	NC5330	150 (120~180)	M10	NC5330
K Cast iron	Continuous cutting	NC5330	200 (150~250)	K10	NC5330
		NCM535 <sup>new</sup>	250 (200~300)	K20	

### The features of CVD milling grades

CVD Coated grades	ISO	Features
NC5330	P20~P30 M20~M30 K15~K25	<ul style="list-style-type: none"> <li>• For high speed milling of steel and stainless steel</li> <li>• Superior wear resistance and chipping resistance grade for steel and stainless steel</li> <li>• MT-TiCN + Al<sub>2</sub>O<sub>3</sub> + TiN</li> </ul>
NCM535 <sup>new</sup>	P30~P40 K20~K30	<ul style="list-style-type: none"> <li>• Rising CVD milling grade for high productivity in large steel and cast iron machining at high speed</li> <li>• High toughness and thermal conductivity substrate and high functional CVD coating layer with heat resistance</li> <li>• High chipping resistance and heat and crack resistance from excellent after treatment</li> <li>• MT-TiCN + Al<sub>2</sub>O<sub>3</sub></li> </ul>
NCM545 <sup>new</sup>	P40~P50 K30~K40	<ul style="list-style-type: none"> <li>• For steel and cast iron milling with high toughness</li> <li>• High toughness substrate and high functional CVD coating layer</li> <li>• High chipping resistance and heat and crack resistance from excellent after treatment</li> <li>• MT-TiCN + Al<sub>2</sub>O<sub>3</sub></li> </ul>



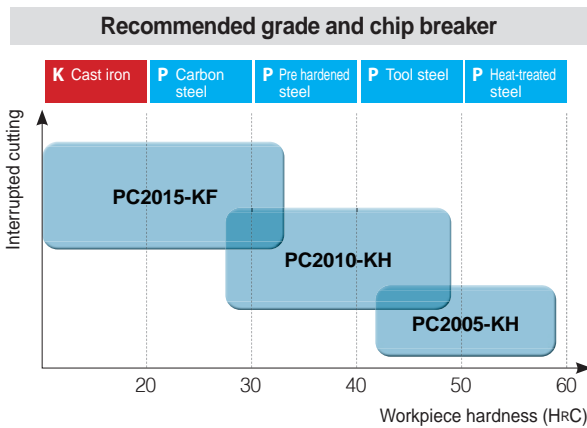
## PVD coated grades

### PVD coated grades for finishing high hardened steel

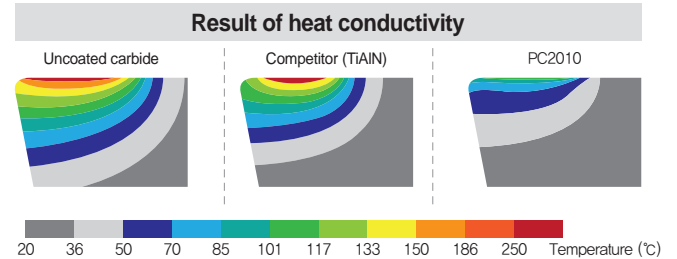
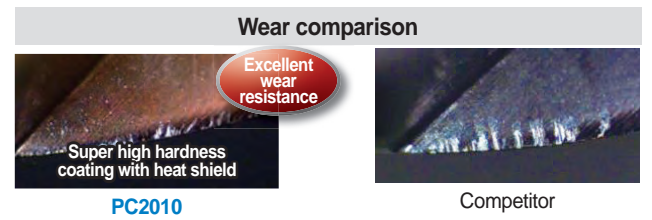
# PC2005 / PC2010 / PC2015

- Finishing grade lineup for tool steel and plastic die steel
- PC2005 with extremely hard substrate and coatings
- PC2010 with high hardened cutting edges, ideally suited for pre-hardened steel and interrupted cutting
- PC2015 for carbon steel and casting machining, demonstrating excellent performance in hard-to-cut materials

#### Application guideline per workpiece



#### Features



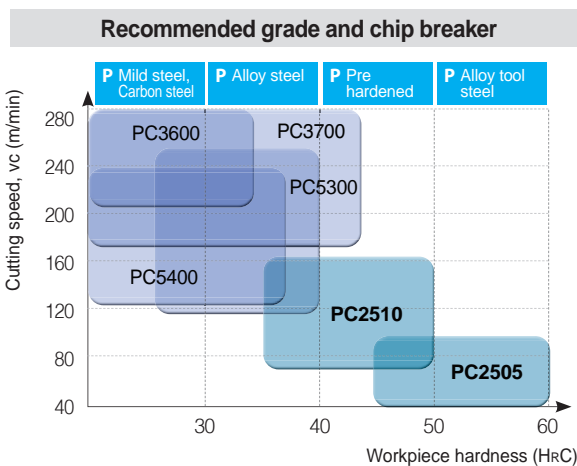
- Heat shield coating was applied to prevent thermal crack.
- Ultra fine WC was combined with high contents cobalt to be optimized for machining pre hardened steel.

### PVD coated grades for roughing high hardened steel

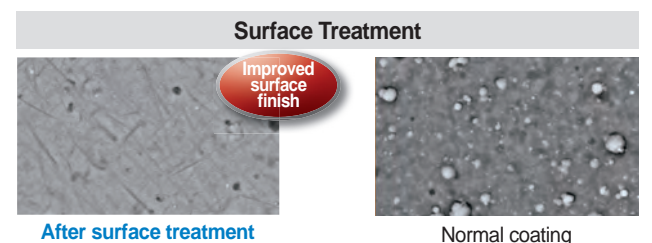
# PC2505 <sup>new</sup> / PC2510 <sup>new</sup>

- Roughing grade series for high hardened steel
- PC2505 with excellent wear resistance, ideal for machining die steel and high hardened steels over HRC50
- PC2510 with stabilized toughness, ideal for interrupted cutting of high hardened steel and wet cutting accompanied by massive thermal shock

#### Application guideline per workpiece



#### Features



# PVD coated grades

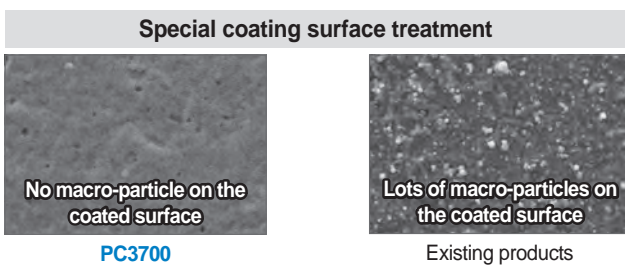
## Milling grade specialized for steel

# PC3700 new

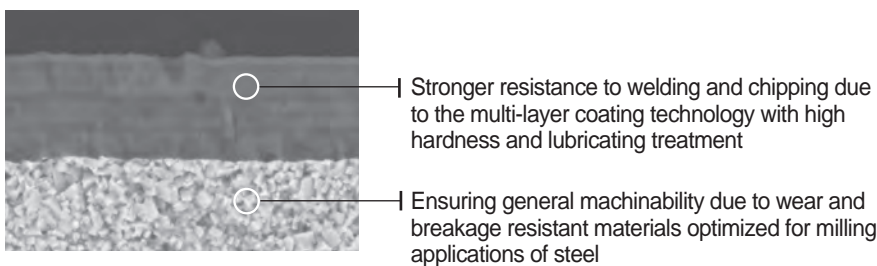
- Excellent chip removal rate due to a tough substrate specialized for steel, and lubricative PVD coating of high-hardness
- A highly chipping-resistant grade for minimized deviation and extended tool life under various cutting conditions

### Features

- Smooth surface due to special surface treatment  
→ Smooth chip evacuation, improved chipping resistance and surface finish of the workpiece

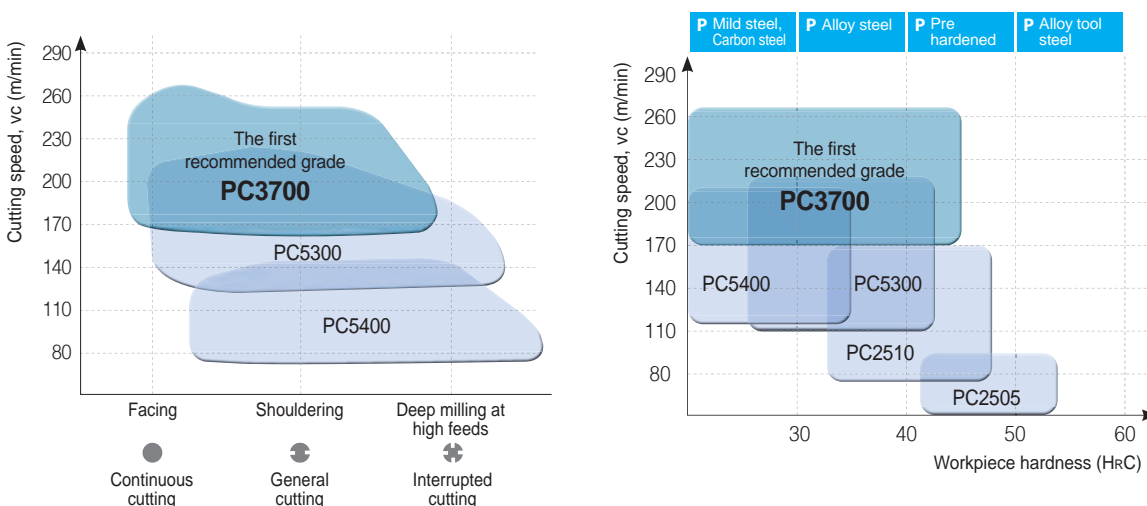


- Substrate for general milling applications of steel and PVC coating treatment



### Application range

#### Recommended grades and cutting conditions for p-type milling application





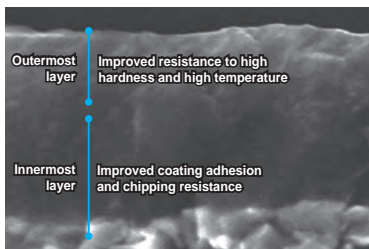
## PVD coated grades

### Universal PVD grade

# PC5300

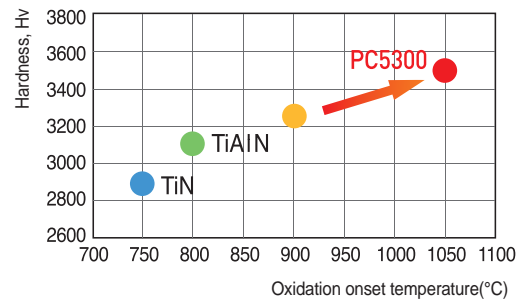
- Advanced PVD coating with high hardness and high temp stability
- High tough substrate and coating films produce excellent surface finish
- Universal tooling capability covering P, M, K, S with this single grade, PC5300
- Stable machining resulting from excellent edge hardness and chipping resistance

### Features



- Latest PVD coating technology developed by KORLOY
- New concept of coating equipped with high temperature oxidation resistance and high hardness

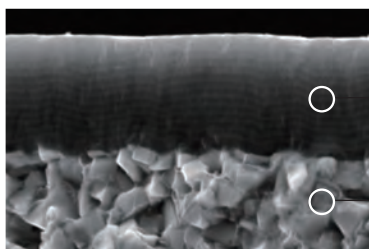
### High temp properties



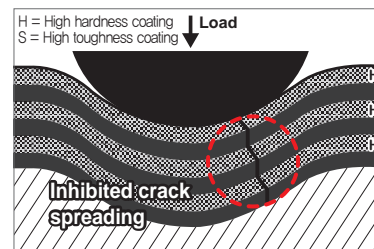
# PC5400

- New PVD coating layer with high toughness and lubrication
- High adhesive strength and toughness between the substrate and coating layer
- Excellent cutting edge strength and chipping resistance ensure stable machinability for P, M, K, S.

### Features



- Improved lubrication
- High toughness and strong adhesion
- Ultrafine substrate of high toughness



### Crack creation on the coating surface after leaving an indentation by 60kg



Normal coating



High toughness coating





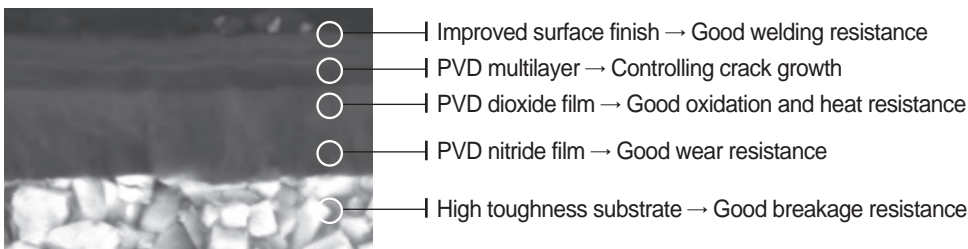
## PVD coated grades

Optimal PVD grade for medium to rough cutting and highly interrupted milling in stainless steel

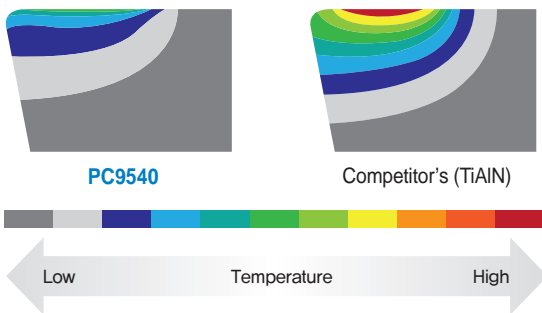
# PC9540 new

- Longer tool life due to higher breakage resistance applying high toughness substrate controlling crack growth
- Excellent and new PVD dioxide film with oxidation and heat resistance overcoming the limit of hard-to-cut materials machining
- Stable machinability by preventing welding and chipping due to applying special coating surface treatment

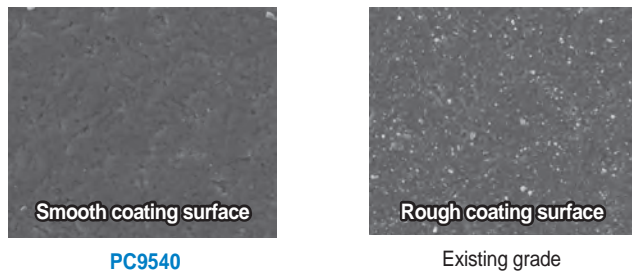
### Features



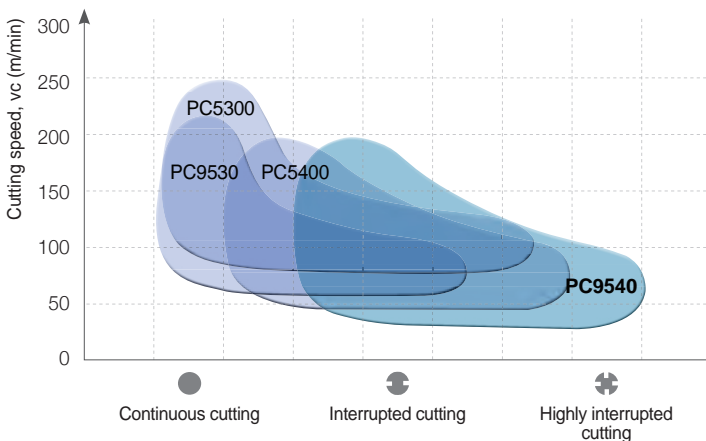
#### New PVD dioxide film (comparison of thermal conductivity)



#### Special coating surface treatment technology



### Application range



## Selection system of PVD coated grades

Workpiece	Machining types	Recommended grade	Recommended cutting speed (m/min)	ISO	Application range
P Steel	Continuous cutting	PC3600	235 (180~290)	P20	
		PC3700 <sup>new</sup>	235 (180~290)	P30	
	Interrupted cutting	PC5300	195 (150~240)	P40	
		PC5400	145 (80~210)	P50	
M Stainless steel	Continuous cutting	PC5300	130 (100~160)	M20	
		PC9530	130 (100~160)	M30	
	Interrupted cutting	PC5400	120 (95~155)	M40	
		PC9540 <sup>new</sup>	110 (80~140)	M50	
K Cast iron	Continuous cutting	PC6510	180 (140~230)	K01 K10	
		PC5300	145 (110~180)	K20	
	Interrupted cutting	PC5400	125 (85~160)	K30	
S HRSA	Continuous cutting	PC5300	55 (40~70)	S10 S20	
		PC5400	40 (30~50)	S30	
	Interrupted cutting	PC9540 <sup>new</sup>	40 (30~50)	S40	
H High hardness steel	Continuous cutting	PC2005	60 (40~80)	H01	
		PC2010	55 (40~70)	H10	
		PC2015	50 (35~65)	H20	
		PC210F	50 (35~65)	H30	

## The features of PVD coated grades

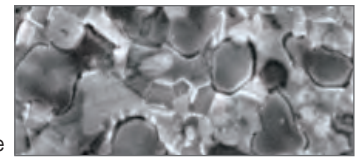
PVD Coated grades	ISO	Features
PC3600	P20~P30	<ul style="list-style-type: none"> <li>Milling grade for medium and roughing of steel</li> <li>New coating layer with superior wear resistance and oxidation resistance with high toughness substrate</li> </ul>
PC3700 <sup>new</sup>	P30~P40	<ul style="list-style-type: none"> <li>Exclusive grade for milling grade</li> <li>Lubricated and high hardness multi-layered coating</li> </ul>
PC5300	P30~P40 M20~M30 S15~S25	<ul style="list-style-type: none"> <li>Superior universal grade for steel, cast iron, hard to cut material, stainless steel</li> <li>New coating and ultra fine grain provide wear resistance and oxidation resistance</li> <li>TiAlN Series new coating</li> </ul>
PC5400	P35~P45 M30~M40 S25~S35	<ul style="list-style-type: none"> <li>Universal grade for interrupted machining of steel, cast iron, hard-to-cut materials and stainless steel with stable machinability</li> <li>New coating layer with high toughness and lubrication on ultra fine grain substrate with high toughness</li> <li>AlCrN series new coating</li> </ul>
PC6510	K05~K15	<ul style="list-style-type: none"> <li>High speed milling grade for cast iron and aluminum</li> <li>K-Gold coating</li> </ul>
PC9530	M25~M35 S20~S30	<ul style="list-style-type: none"> <li>Medium to rough cutting of hard to cut materials such as stainless steel, Cr-Ni steel, etc.</li> <li>The toughest sub-micron substrate provides excellent cutting performance at high feed</li> <li>TiAlN coating</li> </ul>
PC9540 <sup>new</sup>	M35~M45 S30~S40	<ul style="list-style-type: none"> <li>Exclusive high toughness grade for stainless steel milling</li> <li>PVD dioxide film with good heat resistance</li> </ul>
PC2005	H01~H10 P01~P10 K01~K10	<ul style="list-style-type: none"> <li>Exclusive for Laser Mill in milling of high hardness workpieces and press mold steel</li> <li>Utmost wear resistance due to high hardness substrate and coating</li> <li>Ultra high hardness K-Brown coating</li> </ul>
PC2010	H05~H15	<ul style="list-style-type: none"> <li>Exclusive for Laser Mill in milling of pre hardened steel and plastic mold steel</li> <li>High hardness enhanced cutting edges due to ultra fine WC and high contents binder for expanding application range to high hardness steel and pre hardened steel</li> <li>Ultra high hardness K-Brown coating</li> </ul>
PC2015	H10~H20	<ul style="list-style-type: none"> <li>Exclusive for Laser Mill in milling of carbon steel and cast</li> <li>Highly lubricative K-SILVER coating</li> <li>Lubricative coating layer and high contents substrate for machining mild steel and hard-to-cut cast materials</li> </ul>
PC210F	H10~H20 P25~P35 K15~K25 M15~M25 S10~S20	<ul style="list-style-type: none"> <li>High speed milling grade for hardened steel, cast iron, and stainless steel(Laser Mill)</li> <li>New coating and ultra fine grain provide wear resistance and oxidation resistance</li> <li>TiAlN Series new coating</li> </ul>
PC2505 <sup>new</sup>	H01~H10	<ul style="list-style-type: none"> <li>Roughing grade for high hardened steel and pressed die steel</li> <li>Excellent wear resistance ideal for machining die steel and high hardened steel over HRC50</li> </ul>
PC2510 <sup>new</sup>	H05~H15	<ul style="list-style-type: none"> <li>Roughing grade for pre-hardened steel and plastic die steel</li> <li>Stabilized toughness ideal for interrupted cutting of high hardened steel and wet cutting accompanied by massive thermal shock</li> </ul>



# Uncoated carbide grades

## Features

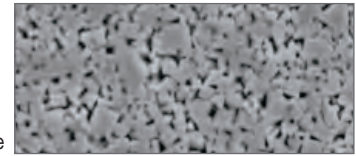
- Due to KORLOY's advanced sintering technology, our uncoated carbide grades have a fine alloy structure which is necessary to get superior quality from a uncoated cutting tool



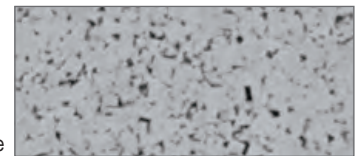
P type

## Advantages

- Consist of P,M,K carbide grades and can be used in all kinds of workpiece
- Excellent quality at machining with coolant, due to the superior thermal crack resistance of the carbide
- Due to the special design of carbides, it has fine micro structure and low affinity with workpiece
- It has excellent toughness and produces lower cutting loads



M type



K type

## Selection system of uncoated carbide grade

Workpiece	Grade	Recommended cutting speed (m/min)	ISO	Application range
P	Steel	ST20	90 (70~110)	P20
		ST30A	80 (60~100)	P30
M	Stainless steel	U20	90 (70~110)	M20
				M30
K	Cast iron	H01, H05	150 (110~190)	K10
		G10	120 (90~150)	K20
N	Aluminum alloy	H01	600 (450~750)	N10
	Copper alloys	H05	425 (320~530)	N20

## Main composition and application range

Workpiece	Composition	Features	Workpiece
P	WC-TiC-TaC-Co	Excellent thermal shock resistance and plastic deformation resistance	Carbon steel, Alloy steel, Stainless steel
M	WC-TiC-TaC-Co	General grades with thermal shock resistance and hardness	Carbon steel, Alloy steel, Stainless steel, Cast steel
K	WC-Co	High hardness and superior wear resistance	Cast iron, Non-ferrous metal, Non metal

## The physical properties of uncoated carbide grades

Workpiece	Grade	Hardness (HRA)	TRS (kgf/mm <sup>2</sup> )	Young's modulus (10 <sup>3</sup> kgf/mm <sup>2</sup> )	Thermal expansion coefficient(10 <sup>-6</sup> /°C)	Thermal conductivity (cal/cm·sec·°C)
P	ST10	92.1	175	48	6.2	25
	ST20	91.9	200	56	5.2	45
	ST30A	91.3	230	53	5.2	-
M	U20	91.1	210	-	-	88
K	H01	92.9	210	66	4.7	109
	G10	90.9	250	63	-	105

1KPa = 102kgf/m<sup>2</sup>, 1w/mk = 2.39×10<sup>-3</sup>cal/cm·sec·°C



## Cermet grades

### Features

- High hardness substrate ensures long tool life in high speed milling
- High toughness cutting edge ensures long tool life even in high impact machining
- Chemically stable substrate provides excellent surface finish of the workpiece

### Selection system of cermet grades

Workpiece	Machining types	Grade	Recommended cutting speed (m/min)	ISO	Application range	
P	Steel	Continuous cutting	CN2500	250 (200~300)	P20	
		Interrupted cutting	CN30	150 (100~200)	P30	

### The features of cermet grades

Cermet Grade	ISO	Features
CN2500	P20~P30	<ul style="list-style-type: none"> <li>• Universal grade from finishing to roughing of steel</li> <li>• Functionally gradient material</li> </ul>
CN30	P25~P35	<ul style="list-style-type: none"> <li>• For milling of steel</li> <li>• Cermet with high toughness</li> </ul>

### The physical properties of cermet grades

Workpiece	Grade	Hardness (Hv)	TRS (kgf/mm <sup>2</sup> )	SG (g•cm <sup>-3</sup> )
P	CN2500	< 1800	210 <	6.8~7.0
	CN30	< 1500	240 <	7.0~7.3



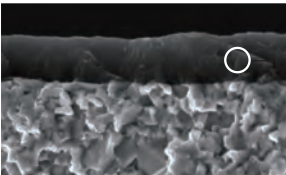


**Solid endmills grade selection**

# PC303S/PC310U

- Ultrafine substrate & high hardness coatings for excellent wear resistance
- Special surface treatment provides higher chipping resistance

**Features**

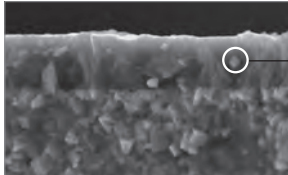


Exceptional wear resistance resulting from extremely hard coating layers

# SL

- Applied high lubrication coating and special surface treatment technology

**Features**

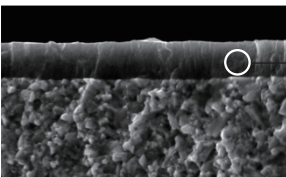


Enhanced welding resistance, chipping resistance and machining stability due to surface treatment technology

# PC315E

- Fine substrate & lubricative coatings for stable machinability

**Features**

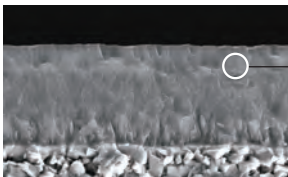


Lubricative coatings for excellent machinability

# PC305H

- Enhanced wear resistance and stability from frictional heat due to high hardness substrate and high hardness coating

**Features**



Applied layer of AlTiSiN series

**Selection system**

Workpiece	Grade	ISO	Application range
P Steel	PC303S	P01	
	PC310U	P10	◀ PC303S ▶ ◀ PC203F ▶ ◀ PC305H ▶ ◀ PC310U ▶
	PC315F	P20	
	PC320	P30	◀ PC315E ▶ ◀ PC320 ▶ ◀ PC215F ▶ ◀ PC215F ▶
M Stainless steel	PC303S	M01	
	PC310U	M10	◀ PC303S ▶ ◀ PC203F ▶ ◀ PC305H ▶ ◀ PC310U ▶
	PC320S	M20	◀ PC320S ▶ ◀ PC315E ▶ ◀ PC320 ▶ ◀ PC215F ▶
	PC315E	M30	
K Cast iron	PC303S	K01	
	PC310U	K10	◀ PC303S ▶ ◀ PC203F ▶ ◀ PC305H ▶ ◀ PC310U ▶
	PC315E	K20	◀ PC315E ▶ ◀ PC320 ▶ ◀ PC215F ▶
	PC320	K30	
S HRSA	PC320S	S20	◀ PC320S ▶ ◀ PC315E ▶ ◀ PC320 ▶ ◀ PC215F ▶ ◀ SL ▶
	PC315E	S30	
N Nonferrous	ND3000 <sup>new</sup>	N01	◀ ND3000 <sup>new</sup> ▶
	ND2100 <sup>new</sup>	N05	◀ ND2100 <sup>new</sup> ▶ ◀ PD1005 <sup>new</sup> ▶
	PD3000	N10	◀ PD3000 ▶ ◀ ND2100 <sup>new</sup> ▶ ◀ PD1005 <sup>new</sup> ▶ ◀ PD1010 <sup>new</sup> ▶ ◀ H01 ▶ ◀ H05S ▶ ◀ PC210C ▶
	H01	N20	
H High hardness steel	PC303S	H01	
	PC203F	H10	◀ PC303S ▶ ◀ PC203F ▶ ◀ PC305H ▶ ◀ PC310U ▶
	PC310U	H20	





## Solid endmills grade

### Grade information for each product

Item	Grade	
	Coated	Uncoated
H-Star Endmill	PC305H	-
V Endmill	PC215F	-
Z Endmill	PC315E	-
F Endmill	PC203F	-
T Endmill	PC2510, ND3000	H01
I+ Endmill	PC320	-
Z+ Endmill	PC320U	-
S+ Endmill	PC320S	-

Item	Carbide		HSS	
	Coated	Uncoated	Coated	Uncoated
R+ Endmill	PC10T, PC20T PC30T, PC40T	FN30T	HC10T, HC20T, HC30T	HN20T, HN30T
Aluminum Solid Endmill	PD1005, PD1010	H01	-	-
A+ Endmill	-	H05S	-	-
M+ Endmill	PC40T	-	-	-
C-Max	PC210C	-	-	-
Super Endmill	SL	-	-	-
D Endmill	ND3000	-	-	-
Composite Router Endmill	ND2100	-	-	-
Brazed Endmill	PC221F	FCC	-	-

### The features of Coated grades

Workpiece	ISO	Features
PC305H	P05~P15, M05~M15, K05~K15, H05~H15	<ul style="list-style-type: none"> <li>Grade with higher Si, enhanced wear resistance and stability from frictional heat due to applying the new AlTiSiN series layer</li> </ul>
PC315E PC320	P20~P35, K20~K35	<ul style="list-style-type: none"> <li>Excellent wear/welding resistance in high speed machining due to the combination of ultra fine substrate and PVD coating</li> <li>For low/medium speed machining of general steel</li> <li>New film applied with excellent chipping/wear resistance</li> </ul>
PC320S	M20~M30, S20~S30	<ul style="list-style-type: none"> <li>Low to medium speed cutting of stainless steel and heat resistant alloys</li> <li>Advanced coating layers with increased resistance to built-up edge and oxidation</li> <li>Excellent resistance to wear and built-up edge at high speeds due to the ultrafine substrate and dedicated coating layers</li> </ul>
SL	S20~S30	<ul style="list-style-type: none"> <li>Exclusive Endmill for Inconel</li> <li>Coating layer with oxidation resistance and high hardness</li> <li>Reducing fracture on cutting edge and enhancing wear resistance</li> </ul>
PC210C	N10~N20	<ul style="list-style-type: none"> <li>Medium to high speed cutting of copper and copper electrode</li> <li>Medium to high speed cutting of acrylic materials</li> <li>K-Silver coating with excellent lubrication and wear and chipping resistant substrate</li> </ul>
ND3000* 	N01~N05	<ul style="list-style-type: none"> <li>For electrode machining of graphite at medium to high speeds</li> <li>Dia. coating layer with high wear resistance and lubrication</li> </ul>
ND2100* 	N03~N08	<ul style="list-style-type: none"> <li>For composite materials</li> <li>Diamond-coated layers with excellent adhesion</li> </ul>
PD1005	N05~N10	<ul style="list-style-type: none"> <li>For Non-ferrous metals(Aluminum alloy) machining</li> <li>DLC(Diamond Like Carbon) coating layer with high wear resistance and lubrication</li> </ul>

\* : CVD

### Features of KORLOY endmills

Index	Features
<b>H-Star Endmill</b> (Endmill for high hardness steel)	<ul style="list-style-type: none"> <li>Carbide endmill for high hardness (HrC50~63) steel</li> <li>Suitable for precision cutting due to high precision tolerance on radius and tool diameter</li> </ul>
<b>Z Endmill / I+ Endmill</b> (Endmill for general cutting)	<ul style="list-style-type: none"> <li>Excellent in machining various workpieces such as carbon steel, alloy steel, cast iron, pre hardened steel, etc. under HRC45</li> <li>Longer tool life with the use of ultra fine substrate and new coating technology</li> </ul>
<b>T Endmill</b> (For dental purpose)	<ul style="list-style-type: none"> <li>Endmill for dental prostheses made of zirconia, titanium, Co-Cr, wax, PMMA, and glass ceramic</li> <li>Custom-made tools for each type of milling machines for dental purpose</li> </ul>
<b>Z+ Endmill</b>	<ul style="list-style-type: none"> <li>Universal endmill applicable to a variety of workpiece materials under HrC47</li> <li>Roughing and finishing availability</li> <li>Improved tool life thanks to the new substrate and the most advanced coating</li> <li>Inhibited chipping and longer cutting time due to the optimized blade design</li> </ul>
<b>SSEA / A+ Endmill</b> (Endmill for aluminum)	<ul style="list-style-type: none"> <li>Suitable for high speed machining in aluminum and other Non-ferrous materials</li> <li>Can accomplish excellent surface finishing, superior chip removal in high feed rate</li> </ul>
<b>M+ Endmill</b> (Multi-functional endmill)	<ul style="list-style-type: none"> <li>Various cutting with one Endmill: Drilling, Ramping, Slotting and Side Milling</li> <li>Reducing cutting resistance and enhancing surface finish due to high tool rigidity</li> </ul>
<b>S+ Endmill</b> (Endmill for hard-to-cut materials)	<ul style="list-style-type: none"> <li>Sharp cutting edge and high rake angle with streamline chip pocket shows good cutting performance in stainless steel machining where work hardening is a problem</li> </ul>
<b>R+ Endmill</b>	<ul style="list-style-type: none"> <li>High efficient roughing endmill for medium to rough cutting</li> <li>Excellent machining efficiency thanks to the high efficient roughing edge design</li> <li>Reduced cutting force thanks to specifically designed corners, and irregular flute spacing and lead angle</li> </ul>
<b>D Endmill</b>	<ul style="list-style-type: none"> <li>Diamond-coated endmill for graphite and ceramic</li> <li>Excellent wear resistance thanks to the diamond coating of high hardness and high purity</li> <li>Optimized for high speed and heavy duty cutting thanks to the strong grip of coating</li> <li>Excellent cutting performance and finish thanks to the optimized blade design of high rake</li> </ul>
<b>Composite Router Endmill</b>	<ul style="list-style-type: none"> <li>Router endmill for machining composite materials (CFRP &amp; GFRP)</li> <li>Minimized machining defects thanks to its design to prevent flaking, peeling off and burrs</li> <li>Excellent resistance to wear and flaking thanks to the nano-crystalline diamond coating of high hardness and high purity</li> </ul>
<b>C-Max</b>	<ul style="list-style-type: none"> <li>Ideally suited for machining copper, brass, bronze, and Non-ferrous materials thanks to the optimized combination between K-Silver coating with excellent lubrication and resistance to wear and chipping, and the dedicated substrate</li> </ul>
<b>Super Endmill</b>	<ul style="list-style-type: none"> <li>High lubricated coating and special surface treatment</li> <li>Improved welding and chipping resistance and machining stability due to surface treatment technology</li> </ul>



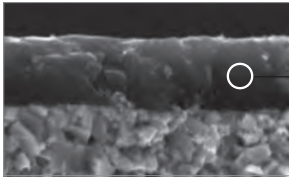
## Solid drills grades selection

### Grades for Mach Solid Drill (MSD)

# PC325U

- Special surface treatment provides improved lubrication and reduced cutting loads
- Stable tool life thanks to increased welding resistance

#### Features



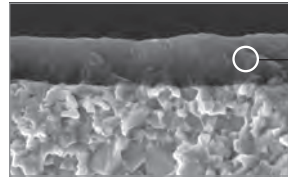
Increased welding resistance in medium to high speed cutting due to highly lubricative coating layers  
Increased wear resistance in carbon steel machining

### Grades for Mach Solid Drill (MSD)

# PC325T **new**

- Good wear resistance in HRSA machining at high temperature
- Good surface finish reduces friction resistance and increases chip evacuation

#### Features



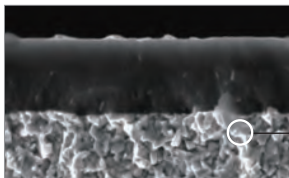
High heat and oxide resistance increase tool life  
Increased wear.  
Good surface finish coating layer ensures lubrication and high quality in machining.

### Grades for Mach Long Drill (MLD)

# PC215G/PC315G

- Improved wear resistance due to the ultrafine substrate
- Reduced friction resistance and smooth chip flow due to improved coating lubrication

#### Features



Exceptional wear resistance due to the ultrafine substrate

#### Selection system

Workpiece	Grade	ISO	Application range			
P Steel	PC215G	P01				
	PC315G	P10				
	PC325U	P20	PC215G	PC315G	PC325U	PC230F
	PC230F	P30				
M Stainless steel	PC215G	M01				
	PC315G	M10				
	PC205F	M20	PC215G	PC315G	PC325U	
	PC325U	M30				
K Cast iron	PC215G	K01				
	PC315G	K10				
	PC205F	K20	PC215G	PC315G	PC325U	
	PC325U	K30				
N Nonferrous	ND2100 <b>new</b>	N05	ND2100 <b>new</b>			
	FG2	N10		FG2	FA1	
	FA1	N20				
S HRSA	PC325T <b>new</b>	S20	PC325T <b>new</b>			
		S30				



## Solid drills grades

### Grade information for each product

Item	Grade	
	Coated	Uncoated
MSD Plus	PC325U	FG2
MSD Plus-S	PC325T	-
MSD Plus CFRP	ND2100	-
MSFD	PC325U	-
MLD Plus	PC215G, PC315G	FG2
VZD	PC230F	-
ESD Plus	PC325U	FG2
SSD Plus	-	FA1, FG2

### The features of PVD coated grades

Workpiece	ISO	Features
PC325U	P20~P35 M20~M30 K20~K35	<ul style="list-style-type: none"> <li>• Universal grade for machining steel, cast iron, stainless steel, etc.</li> <li>• Stable cutting performance with excellent wear/chipping resistance</li> <li>• Increased welding resistance due to lubricative new coating at medium to high speed</li> </ul>
PC325T <small>new</small>	M20~M30 S20~S30	<ul style="list-style-type: none"> <li>• Good wear resistance realizes HRSA machining at high temperature</li> <li>• Good wear and chipping resistance ensure stable machinability</li> </ul>
PC215G	P15~P30 M15~M25 K15~K30	<ul style="list-style-type: none"> <li>• Universal grade for machining steel, cast iron, etc.</li> <li>• Stable cutting performance with excellent wear/chipping resistance</li> </ul>
PC315G	P15~P30 M15~M25 K15~K30	<ul style="list-style-type: none"> <li>• Universal grade for machining steel, cast iron, stainless steel, etc.</li> <li>• Stable cutting performance with excellent wear/chipping resistance</li> <li>• Increased welding resistance due to lubricative new coating at medium to high speed</li> </ul>
PC230F	P25~P35	<ul style="list-style-type: none"> <li>• For machining general steel at medium to high speed</li> <li>• Stable cutting performance with excellent wear/chipping resistance</li> </ul>
ND2100 <small>new</small>	N05~N10	<ul style="list-style-type: none"> <li>• For machining composite materials</li> <li>• Diamond-coated layers with excellent adhesion</li> </ul>
FG2 / FA1	N05~N25	<ul style="list-style-type: none"> <li>• Increased wear/chipping resistance with the use of ultra fine substrate</li> </ul>

### Features of KORLOY drills

Index	Features
MSD Plus	<ul style="list-style-type: none"> <li>• Increased welding resistance in medium to high speed cutting due to highly lubricative coating layers</li> <li>• Increased wear resistance in carbon steel machining</li> <li>• Reduced friction resistance around corners and flutes</li> </ul>
MSD Plus-S	<ul style="list-style-type: none"> <li>• Exclusive for HRSA grooving with good wear resistance at high temperature and chipping resistance.</li> <li>• New coating layer with good surface finish reduces frictional resistance and increases chip evacuation.</li> <li>• Preventing chipping on the cutting edge and fracture of tool ensures high productivity.</li> </ul>
MSD Plus CFRP	<ul style="list-style-type: none"> <li>• The best tool for hole making of CFRP workpieces</li> <li>• Excellent wear resistance due to the diamond-coated grade</li> <li>• Reduced burr creation in CFRP machining due to high rake cutting edges</li> </ul>
MSFD	<ul style="list-style-type: none"> <li>• High quality hole making capability with 180° point angle</li> <li>• Improved anti-chipping and welding resistance by edge honing and chamfering</li> <li>• Minimized creation of burrs compared to general drills</li> </ul>
MLD Plus	<ul style="list-style-type: none"> <li>• Higher rigidity due to straight-edge design</li> <li>• Smooth chip flow due to wider chip pockets and improved surface finish on flutes</li> <li>• Double margin system for stable machinability</li> </ul>
ESD Plus	<ul style="list-style-type: none"> <li>• Lubricative coating layer improves welding resistance at middle to high speed.</li> <li>• Increase wear resistance in machining carbon steel</li> <li>• Increased welding resistance and wear resistance with new PC325U grade applied.</li> </ul>
SSD Plus	<ul style="list-style-type: none"> <li>• New shape increases chip control</li> <li>• Surface finish and improved shape realize high quality of machining</li> <li>• Stable tool life increases productivity</li> </ul>



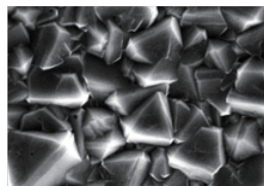
# Diamond coated grades

## Grade for graphite and ceramic

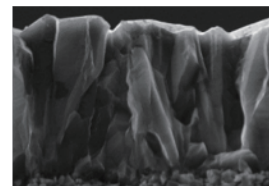
### ND3000 **new**

- SP3-crystalline diamond coatings of high purity and high hardness
- Improved adhesion between coated layers and the substrate that is specialized for diamond coatings
- Excellent tool life when machining graphite and ceramic

Surface of ND3000



Cross section of ND3000's coated layers

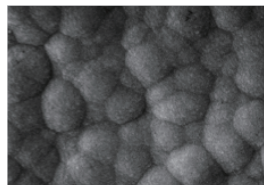


## Grade for composite materials

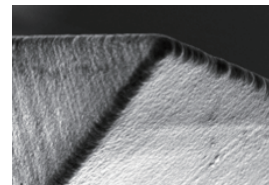
### ND2100 **new**

- Improved surface finish and wear resistance due to the control technology of nano-crystalline diamond particles
- Improved flaking resistance due to the substrate that is specialized for diamond coatings
- High quality and high precision machining availability thanks to sharp edges
- Excellent tool life when machining composite materials

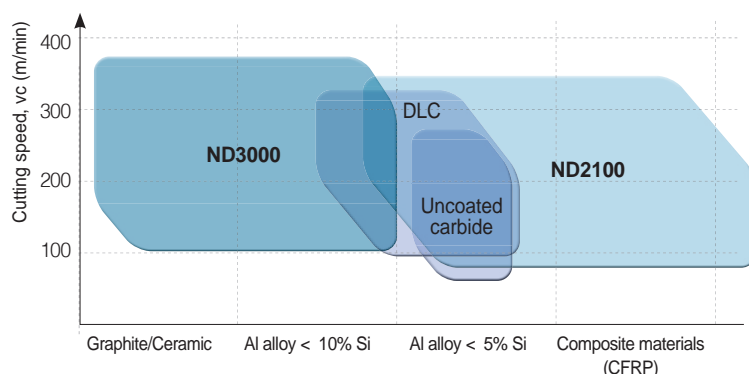
Surface of ND2100



Sharp edges of ND2100



## Application range



## Selection system

Workpiece		Grade	ISO	Application range	
<b>N</b> Nonferrous	Graphite/Ceramic	ND3000 <b>new</b>	N01	[ND3000 <b>new</b> ]	
	Al alloy	ND3000 <b>new</b> ND2100 <b>new</b>	N05	[ND3000 <b>new</b> ]	[ND2100 <b>new</b> ]
	Composite materials	ND2100 <b>new</b>	N10	[ND2100 <b>new</b> ]	

## The features of diamond coated grades

Grade	ISO	Features
ND3000 <b>new</b>	N01~N05	<ul style="list-style-type: none"> <li>• For continuous roughing of graphite, ceramic, and Al alloy at high speeds</li> <li>• Exceptional cutting performance due to high resistance to wear and flaking</li> <li>• High hardness diamond coatings of high purity SP3-crystalline structure</li> </ul>
ND2100 <b>new</b>	N05~N10	<ul style="list-style-type: none"> <li>• For continuous finishing of composite materials and Al alloy at high speeds</li> <li>• Stable machinability due to durable sharp edges</li> <li>• Nano-crystalline diamond coatings under particle control</li> </ul>





## DLC coated grades

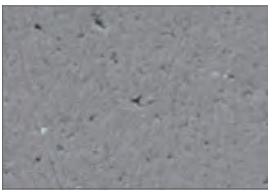
### DLC-Coated Inserts for Non-Ferrous Metals

# PD1005 <sup>new</sup> / PD1010 <sup>new</sup>

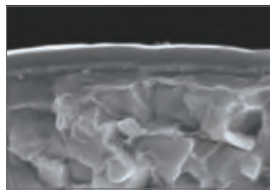
- High hardness and low friction DLC coating technology
- Lubrication and maximized wear resistance increases machinability and machining quality.
- Optimal substrate for each workpiece ensures stable and long tool life
- For non-ferrous metals such as aluminum, Al-Si alloy, copper and etc. machining

### Features

#### Smooth coating surface

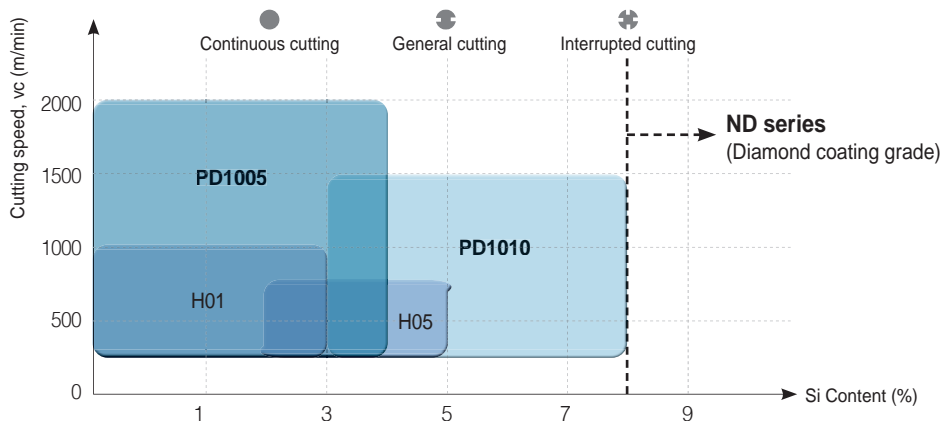


#### Hard DLC coating



Grade	Wear resistance and Welding resistance	Surface finish	Chip curl
Carbide non coated			
DLC PD1010			

### Application range



### Selection system

Workpiece		Grade	ISO	Application range
N	Non-ferrous metals	Aluminum and copper (Soft non-ferrous metals)	PD1005	
		Aluminum alloy	PD1005 PD1010	
		Al-Si alloy (Hardened non-ferrous metals)	PD1010	N15

### The features of DLC coating grades

Grade	ISO	Features
PD1005 <sup>new</sup>	N05	<ul style="list-style-type: none"> <li>• For high speed and continuous machining of Aluminum and copper</li> <li>• High wear and welding resistance realize good machinability</li> <li>• High performance of DLC coating with high hardness and low friction</li> </ul>
PD1010 <sup>new</sup>	N10	<ul style="list-style-type: none"> <li>• For medium to high and interrupted machining of aluminum alloy and Al-Si alloy</li> <li>• Stable tool life due to substrate with chipping resistance</li> <li>• High performance DLC coating with high hardness and low friction</li> </ul>



## cBN inserts grades

- Features**
- Excellent hardness and thermal resistance by sintering KORLOY's main constituents and special ceramic binder at high pressure and high temperature
  - Excellent hardness and wear resistance for higher productivity in machining cast iron and heat-treated alloy at high speed

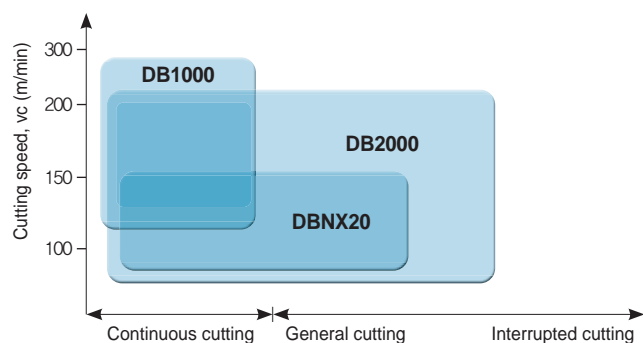
► Insert type

High precision		Wear resistance		Productivity	
For regrinding type	One use type	Multi-corner type	Multi-corner type (coated)	Solid type	Grooving type

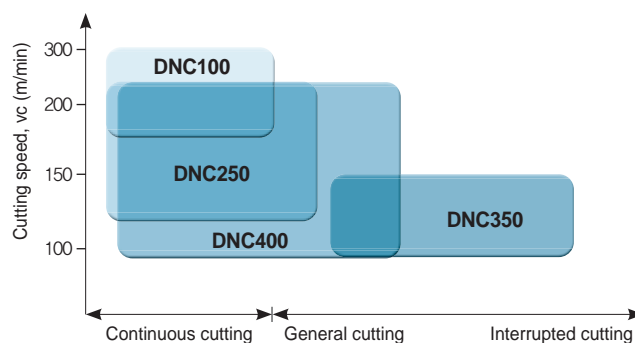
### cBN inserts

Multi edge coated type		One use type	
<ul style="list-style-type: none"> <li>• Easy handling of corners</li> <li>• Strong Brazing</li> <li>• Excellent tool life compared to non-coated inserts</li> </ul>		<ul style="list-style-type: none"> <li>• Economic price</li> <li>• Easy handling of tools</li> <li>• A wide variety of series</li> <li>• Smaller than expensive cBN and dramatic cost down</li> <li>• Strong weld face and stable cutting performance</li> </ul>	
Multi edge type		Regrinding type	
<ul style="list-style-type: none"> <li>• Price per edge is more reasonable compare to normal single cornered, one-used type</li> <li>• Insert with several brazed cBN</li> <li>• Wide application of continuous to interrupted machining</li> </ul>		<ul style="list-style-type: none"> <li>• Long tool life</li> <li>• Excellent wear resistance, High hardness</li> <li>• Saved tool cost due to the regrinding insert 3~4 time</li> </ul>	













### cBN application range



### Coated cBN application range



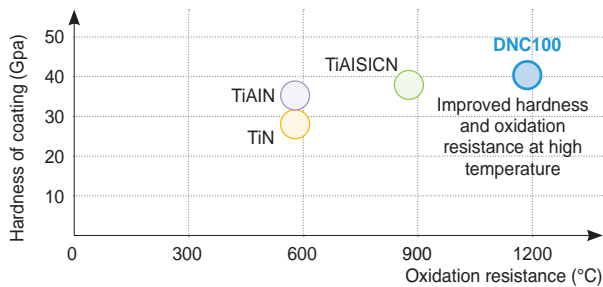
## ▶ Cutting condition of cBN grades

Workpiece	Grades	Insert color	Application	Cutting speed, vc (m/min)	Feed, fn (mm/rev)	Depth of cut, ap (mm)
H High hardness steel	Coated	DNC100	Continuous cutting at high speed	180  300	0.03~0.3	0.03~0.3
		DNC250	Continuous and low interrupted cutting at high speed	120  220	0.05~0.3	0.05~0.3
		DNC300	Medium and low interrupted cutting	90  250	0.05~0.2	0.05~0.2
		DNC350	Medium and high interrupted cutting	90  150	0.05~0.3	0.05~0.3
		DNC400	Continuous and medium interrupted cutting	90  220	0.05~0.3	0.05~0.5
	Non coated	DB1000	Continuous cutting at high speed	130  250	0.03~0.15	0.03~0.2
		DB2000	Medium and low interrupted cutting	80  200	0.03~0.2	0.03~0.3
		DBNX20	Highly efficient cutting	120  150	0.03~0.3	0.03~0.5
		DBN250	Medium and low interrupted cutting	80  120	0.03~0.2	0.03~0.3
		DBN350	High interrupted cutting	120  220	0.03~0.2	0.03~0.3
S HRSA	DB7000	Continuous cutting at high speed	100  300	0.05~0.2	0.1~1.0	
K Cast iron	DBN700A	Continuous cutting at high speed	500  2000	0.10~0.4	0.1~0.4	

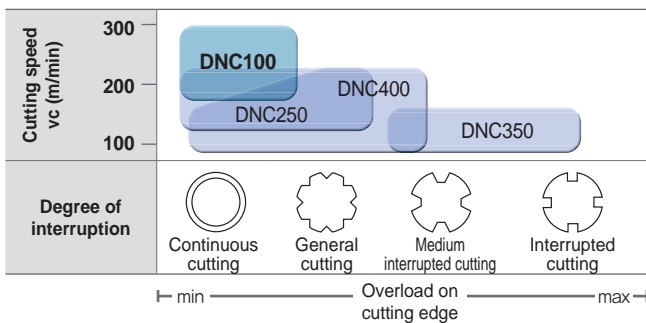
## Coated cBN DNC100

### ▶ Features




- Excellent thermal resistance
- Coating layer with high hardness, oxidation resistance and chipping resistance



### ▶ Application range



### ▶ Recommended cutting condition

Cutting speed vc (m/min)	180  300
Feed fn (mm/rev)	0.03  0.3
Depth of cut per time ap (mm)	0.03  0.3

- Increased oxidation resistance and wear resistance due to high hardness coating layer
- Dramatically improved fracture resistance and chipping resistance

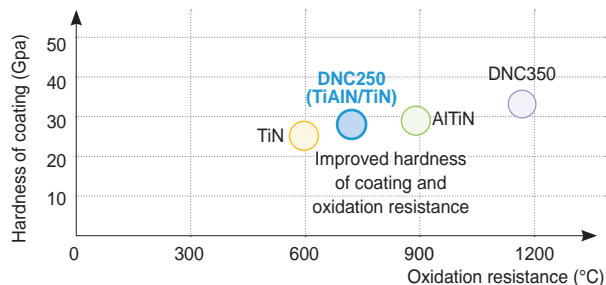


Multi-corner coated cBN for high efficient cutting of heat-treated alloy

# DNC250

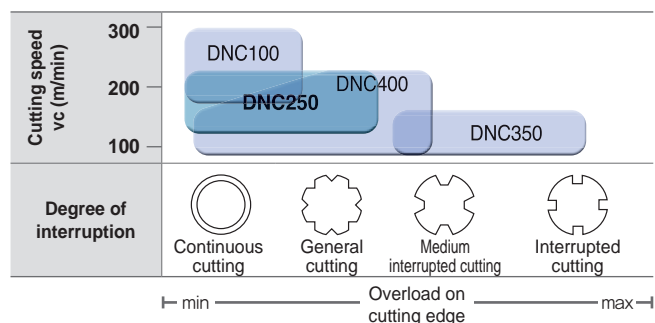
**Features**

- Stable and long tool life
- Cost effective by multi-cornered one-use insert



- Advanced PVD coating
- High hardness and lubricative coating
- Improved wear resistance

**Application range**



**Recommended cutting condition**

Cutting speed $v_c$ (m/min)	120 — 220
Feed $f_n$ (mm/rev)	0.05 — 0.3
Depth of cut per time $a_p$ (mm)	0.05 — 0.3

Coated cBN

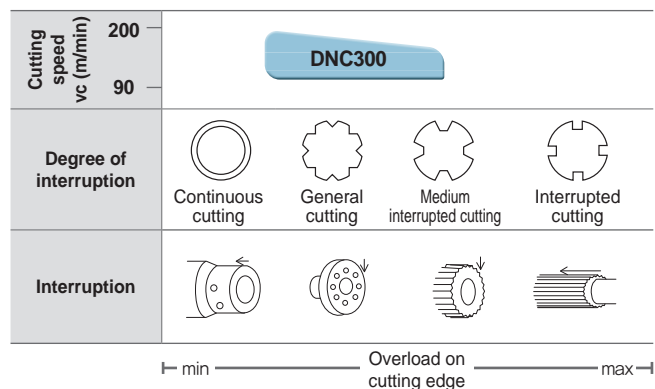
# DNC300

**Features**

- 1st recommended grade for low to medium interrupted cutting
- Enhanced chipping resistance and wear resistance comparing to competitor's grade
- Minimizing flaking of coating by stable coating



**Application range**



**Recommended cutting condition**

Cutting speed $v_c$ (m/min)	90 — 200
Feed $f_n$ (mm/rev)	0.05 — 0.3
Depth of cut per time $a_p$ (mm)	0.05 — 0.25

- Enhanced oxidation resistance and wear resistance due to high hardness layer
- Highly increased chipping resistance, fracture resistance and wear resistance

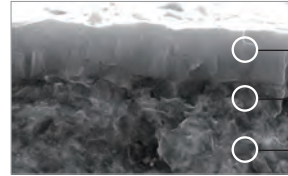
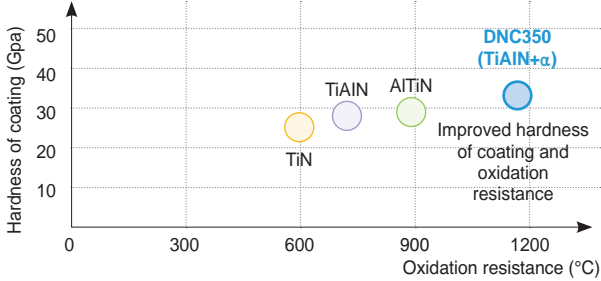


## Coated cBN for high interrupted cutting

# DNC350

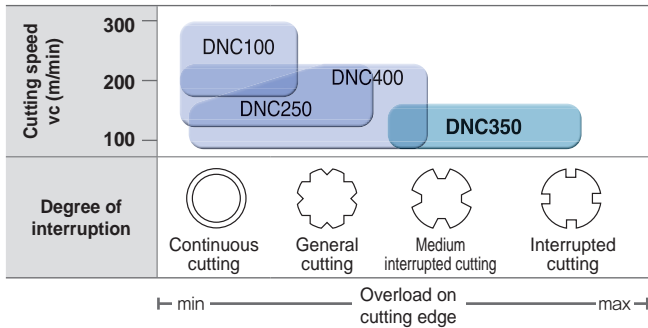
### Features

- Excellent tool life and productivity in interrupted cutting
- New PVD coating applied with high hardness and oxidation resistance



- High hardness and oxidation-resistant coating
- High tough coating
- Fine cBN + High tough substrate

### Application range



### Recommended cutting condition

Cutting speed $v_c$ (m/min)	90 — 150
Feed $f_n$ (mm/rev)	0.05 — 0.3
Depth of cut per time $a_p$ (mm)	0.05 — 0.3

## Solid type coated cBN

# DNC400 new

### Features

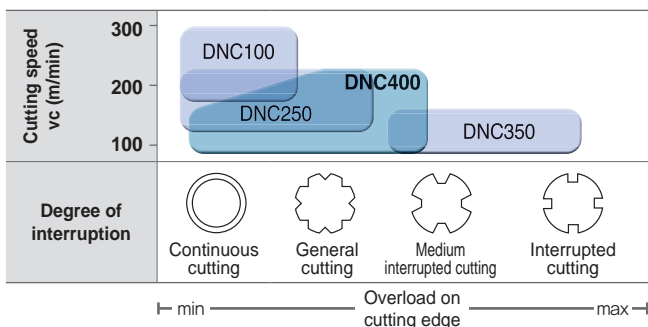
- For machining heat-treated steel in continuous and medium interrupted cutting
- Longer tool life due to coating layer
- Solid type for universal purpose

### Features of solid type cBN

- Increased productivity at high speed and high depth of cut
- Ideal for removing cemented layer and the welds
- Better welding stability due to 3-face blazing
- Excellent cutting performance at varying depth of cuts



### Application range



### Recommended cutting condition

Feed $f_n$ (mm/rev)	DNC400	0.05 — 0.3
	DNC250	0.05 — 0.3
	DNC350	0.05 — 0.3
Depth of cut per time $a_p$ (mm)	DNC400	0.05 — 0.5
	DNC250	0.05 — 0.3
	DNC350	0.05 — 0.3





## Non-coated cBN DB1000

- Features**
- Non-coated cBN with the highest wear resistance at high speed
  - Excellent tool life in continuous to light interrupted cutting
  - Improved fracture resistance along with high wear resistance  
- Higher thermal resistance and hardness due to pure TiCN ceramic binder

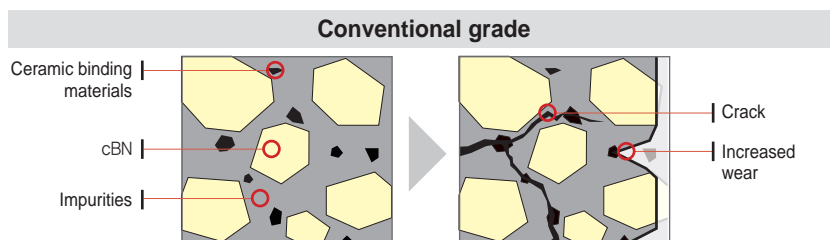
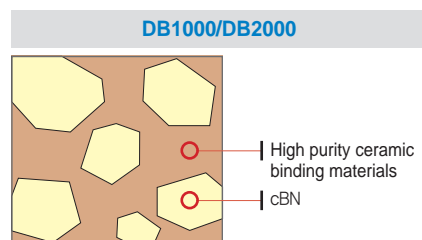


## Non-coated cBN DB2000

- Features**
- Universal grade for overall machining of heat-treated  
- Stable tool life in continuous to low/medium interrupted cutting
  - Both fracture resistance and wear resistance acquired with the use of pure ceramic binder
  - Stable surface roughness



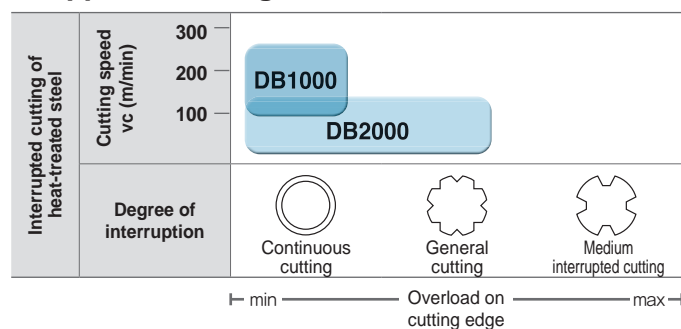
### New technology of high purity ceramic binding materials



DB2000 dramatically minimizes impurities with the use of high purity ceramic binding materials and enhances thermal resistance and toughness.

Impurities included in conventional grade's ceramic binder caused inferior thermal resistance and hardness of sintered compounds, which led to crack (fracture) and wear

### Application range



### Recommended cutting condition (DB1000)

Cutting speed $v_c$ (m/min)	130 ————— 250
Feed $f_n$ (mm/rev)	0.03 ————— 0.15
Depth of cut $a_p$ (mm)	0.03 ————— 0.2

### Recommended cutting condition (DB2000)

Cutting speed $v_c$ (m/min)	80 ————— 200
Feed $f_n$ (mm/rev)	0.03 ————— 0.2
Depth of cut $a_p$ (mm)	0.03 ————— 0.3

## PCD inserts grades

### Features

KORLOY PCD products are manufactured by using high quality PCD tips under ultra high temperatures and pressure. The PCD tip is welded on the qualified KORLOY carbide insert  
KORLOY high quality PCD products meet a wide range of application needs in turning, milling, and endmills.

- Excellent tool life for aluminum alloy and copper alloy
- Excellent tool life for Ceramic, high-silicon aluminum and rock or stone
- Excellent tool life for rubber, carbon, graphite and wood

### PCD grade

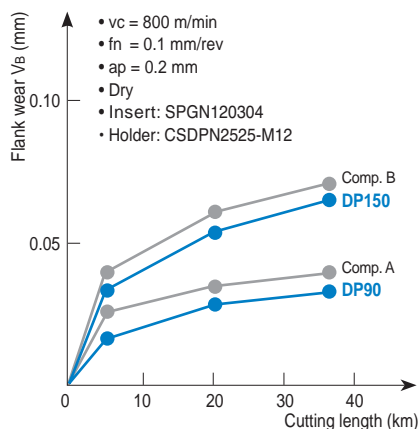
Grade	Features	Application	Grain size (μm)	Hardness (Hv)	TRS (kgf/mm <sup>2</sup> )
DP90	Coarse diamond grain has been used to get excellent wear resistance enough to machine cemented-carbide, high Si aluminum alloy	Cemented carbide Ceramic roughing High Si aluminum alloy Rock, Stone	25~30	50~65	≒1.10
DP150	By use of fine diamond grain having good bonding property, it is suitable for machining of Non-ferrous metal, graphite	High Si aluminum alloy Copper, Bronze alloy Rubber, Wood, Carbon	5~10	50~60	≒1.95
DP200	By use of ultra fine diamond grain, it is possible to make sharp cutting edge. Thus it is appropriate grade to machine Non-ferrous material	Plastic Wood Precise finishing of aluminum	~2	45~55	≒2.45

### Recommended cutting condition

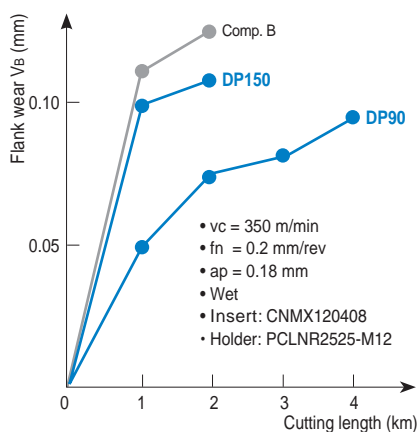
Workpiece	Cutting speed (m/min)	Feed (mm/rev)	Depth of cut (mm)	Recommended grade	
				1 <sup>st</sup>	2 <sup>nd</sup>
Aluminum alloy (4%~8% Si)	1000~3000	0.1~0.6	~3	DP150	DP200
Aluminum alloy (9%~14% Si)	600~2500	0.1~0.5	~3	DP150	DP200
Aluminum alloy (15%~18% Si)	300~700	0.1~0.4	~3	DP150	DP200
Copper, Bronze alloy	~1000	0.05~0.2	~3	DP150	DP200
Reinforced plastic	~1000	0.1~0.3	~2	DP150	DP200
Wood	~4000	0.1~0.4	-	DP150	DP200
Cemented carbide	10~30	~0.2	~0.5	DP90	DP150

### Cutting performance

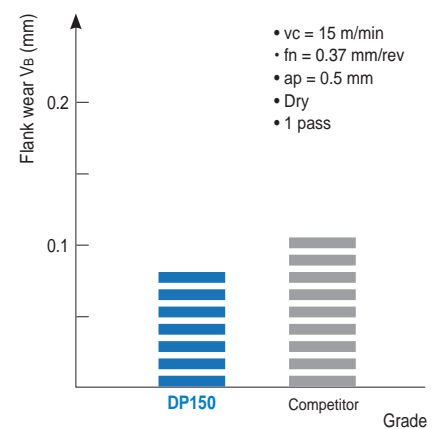
Continuous cutting test (Workpiece: Al-25%Si)



Interrupted cutting test (Workpiece: Al-20%Si)



Cutting test of cemented carbide





## Chip breaker for turning

Geometry	Cutting edge	Application range											Features												
		feed rate $f_n$ (mm/rev)																							
		0.04	0.063	0.10	0.16	0.25	0.4	0.63	1.0	1.6	2.5	4.0		6.3											
depth of cut ap (mm)																									
											0.1	0.16	0.25	0.4	0.63	1.0	1.6	2.5	4.0	6.3	10.0	11.6	13		
V series	VP1																								<b>For Finishing</b> <ul style="list-style-type: none"> <li>High positive cutting edge</li> <li>Reduced contract chip minimizes temperature to improve tool life</li> </ul>
	VP2																								<b>For Medium to finish cutting</b> <ul style="list-style-type: none"> <li>Stable chip control and high machinability in copying with various depths of cut</li> </ul>
	VP3																								<b>For Medium cutting</b> <ul style="list-style-type: none"> <li>High positive cutting edge with wide land</li> <li>Stable cutting performance in interrupted machining with high toughness</li> <li>Stable machinability and chip control in machining with high depth of cut</li> </ul>
	VP4																								<b>For Roughing</b> <ul style="list-style-type: none"> <li>The first recommended chip breaker for inconel cutting</li> <li>High hard and resistant rake angle to prevent notch wear in roughing of rugged surfaces</li> </ul>
	VR																								<b>For Roughing</b> <ul style="list-style-type: none"> <li>High feed machining with the combination of wide land and pockets</li> <li>Shallow chip breaker design prevents chip blocking at high feed</li> <li>Decreased wear on major cutting edge due to special treatment on blade</li> </ul>
-P series	LP																								<b>For Medium to finish cutting</b> <ul style="list-style-type: none"> <li>Angle land decreases cutting resistance for better surface roughness</li> <li>Special dot design prevents chip blocking by clear chip breaking</li> </ul>
	MP																								<b>For Medium cutting</b> <ul style="list-style-type: none"> <li>Increased productivity due to excellent chip control in various conditions</li> <li>Stable tool life by reducing cutting load at high speed and high feed</li> </ul>
	CP																								<b>For Medium to finish cutting</b> <ul style="list-style-type: none"> <li>Chip breaker with strong cutting edge in high interrupted finishing and medium cutting</li> <li>Effective chip control in low depth of cut to high depth of cut due to 2-step rear angle</li> </ul>

Notice: Application ranges are based on main cutting material

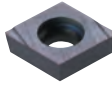
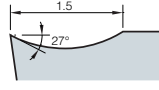
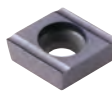
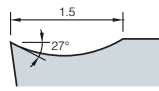

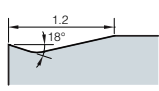

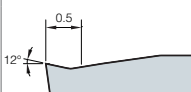

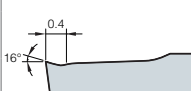

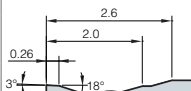

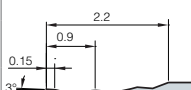

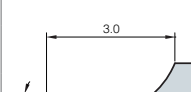

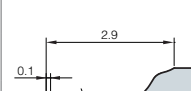








# Chip breaker for turning



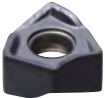

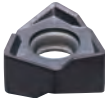











Geometry	Cutting edge	Application range													Features	
		feed rate $f_n$ (mm/rev)														
		0.04	0.063	0.10	0.16	0.25	0.4	0.63	1.0	1.6	2.5	4.0	6.3			
		depth of cut ap (mm)														
		0.1	0.16	0.25	0.4	0.63	1.0	1.6	2.5	4.0	6.3	10.0	11.6	13		
Auto tool series	<b>KF</b>			0.01-0.12	0.01-1.0										<b>For Finishing</b>	<ul style="list-style-type: none"> <li>Shallow depth of cut with sharp edge</li> <li>Longer tool life at high speed cutting due to low cutting force</li> <li>Good surface finish</li> </ul>
	<b>KM</b>			0.04-0.15	0.05-1.5										<b>For Medium to finish cutting</b>	<ul style="list-style-type: none"> <li>Improved chip control makes tool life long and better machining</li> </ul>
	<b>VP1</b>			0.05-0.3	0.5-4.0										<b>For Medium cutting</b>	<ul style="list-style-type: none"> <li>For medium cutting with strong cutting edge</li> <li>For wide range of cutting by optimal width of chip breaker for each cutting depth</li> </ul>
	<b>MS</b>			0.03-0.25	0.3-3.0										<b>For medium cutting (for surface roughness)</b>	<ul style="list-style-type: none"> <li>Reduced welding and cutting heat by sharp cutting edge</li> <li>Enhanced chip evacuation in low to high feed cutting</li> </ul>
	<b>FS</b>			0.01-0.20	0.1-2.0										<b>For Finishing</b>	<ul style="list-style-type: none"> <li>For various workpiece (P, M, S) cutting</li> <li>Good surface finish and low cutting load due to sharp cutting edge</li> </ul>
Wiper series	<b>LW</b>			0.15-0.60	1.0-5.0									<b>For Medium cutting</b>	<ul style="list-style-type: none"> <li>Guarantees excellent surface roughness and good chip controls at high feed machining</li> </ul>	
	<b>VW</b>			0.15-0.50	0.5-3.5									<b>For Medium to finish cutting</b>	<ul style="list-style-type: none"> <li>Improved surface roughness at shallow depth of cut and high feed due to strong cutting edge</li> </ul>	
Shaft series	<b>SR</b>			0.12-0.45	1.0-4.5									<b>For Medium to finish cutting</b>	<ul style="list-style-type: none"> <li>Shallow depth of cut with sharp edge</li> <li>Longer tool life at high speed cutting due to low cutting force</li> <li>Good surface finish</li> </ul>	
	<b>SH</b>			0.15-0.50	1.5-5.0									<b>For Medium cutting</b>	<ul style="list-style-type: none"> <li>Good chip flow increases tool life and machinability.</li> </ul>	

Notice: Application ranges are based on main cutting material





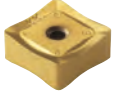















## Chip breaker for milling

Geometry	Cutting edge	Application range														Features								
		feed rate $f_n$ (mm/rev)																						
		0.05	0.10	0.15	0.20	0.25	0.30	0.35	0.40	0.80	1.20	1.40	1.60											
depth of cut $a_p$ (mm)																								
0.1														0.5	1	2	3	4	5	6	8	10	15	20
Rich Mill series-RM6	MA			<div style="display: flex; justify-content: space-between;"> <div style="background-color: #ADD8E6; padding: 2px;">0.05-0.20</div> <div style="background-color: #90EE90; padding: 2px;">1.0-8.2</div> </div>														<b>For Aluminum machining</b> <ul style="list-style-type: none"> <li>Specialized sharp cutting edge for aluminum machining ensures machinability.</li> <li>Buffing treatment on the surface realizes good chip flow and welding resistance.</li> </ul>						
	ML			<div style="display: flex; justify-content: space-between;"> <div style="background-color: #ADD8E6; padding: 2px;">0.05-0.25</div> <div style="background-color: #90EE90; padding: 2px;">1.0-8.2</div> </div>														<b>For Machining hard-to-cut materials</b> <ul style="list-style-type: none"> <li>Low cutting load chip breaker for light cutting</li> <li>Long tool life and high quality of machining in hard-to-cut material cutting</li> </ul>						
	MM			<div style="display: flex; justify-content: space-between;"> <div style="background-color: #ADD8E6; padding: 2px;">0.05-0.25</div> <div style="background-color: #90EE90; padding: 2px;">1.0-8.2</div> </div>														<b>For General cutting</b> <ul style="list-style-type: none"> <li>Optimally designed shape for general shoulder milling in various cutting ranges</li> </ul>						
Rich Mill series-RM8	MA			<div style="display: flex; justify-content: space-between;"> <div style="background-color: #ADD8E6; padding: 2px;">0.05-0.35</div> <div style="background-color: #90EE90; padding: 2px;">0.3-6.0</div> </div>														<b>For Aluminum machining</b> <ul style="list-style-type: none"> <li>Sharp cutting edge and lubricated top face show excellent chip flow and welding resistance in aluminum machining</li> </ul>						
	MF			<div style="display: flex; justify-content: space-between;"> <div style="background-color: #ADD8E6; padding: 2px;">0.05-0.35</div> <div style="background-color: #90EE90; padding: 2px;">0.3-6.0</div> </div>														<b>For Light cutting</b> <ul style="list-style-type: none"> <li>Low cutting force chip breaker design ensures longer tool life and excellent machining in difficult-to-cut material and light machining</li> </ul>						
	ML			<div style="display: flex; justify-content: space-between;"> <div style="background-color: #ADD8E6; padding: 2px;">0.05-0.30</div> <div style="background-color: #90EE90; padding: 2px;">0.3-6.0</div> </div>														<b>For Machining hard-to-cut materials</b> <ul style="list-style-type: none"> <li>Chip breaker with low cutting load resistance ensures long tool life and high quality in light and hard-to-cut material cutting.</li> </ul>						
	MM			<div style="display: flex; justify-content: space-between;"> <div style="background-color: #ADD8E6; padding: 2px;">0.10-0.40</div> <div style="background-color: #90EE90; padding: 2px;">0.5-6.0</div> </div>														<b>For General cutting</b> <ul style="list-style-type: none"> <li>Suitable geometry design for general milling has wider ranges of machining</li> </ul>						
Rich Mill series-RMT8	MF			<div style="display: flex; justify-content: space-between;"> <div style="background-color: #ADD8E6; padding: 2px;">0.05-0.20</div> <div style="background-color: #90EE90; padding: 2px;">0.5-5.0</div> </div>														<b>For Light cutting</b> <ul style="list-style-type: none"> <li>Low cutting force chip breaker design ensures longer tool life and excellent machining in difficult-to-cut material and light machining</li> </ul>						

Notice: Application ranges are based on main cutting material



## Chip breaker for milling

















Geometry	Cutting edge	Application range														Features								
		feed rate $f_n$ (mm/rev)																						
		0.05	0.10	0.15	0.20	0.25	0.30	0.35	0.40	0.80	1.20	1.40	1.60											
depth of cut $a_p$ (mm)																								
0.1														0.5	1	2	3	4	5	6	8	10	15	20
Rich Mill series-RMT8	MM			<div style="background-color: #ADD8E6; padding: 2px;">0.05-0.30</div> <div style="background-color: #90EE90; padding: 2px;">0.5-8.0</div>														<p><b>For General cutting</b></p> <ul style="list-style-type: none"> <li>Suitable geometry design for general milling has wider ranges of machining</li> </ul>						
	ML			<div style="background-color: #ADD8E6; padding: 2px;">0.05-0.30</div> <div style="background-color: #90EE90; padding: 2px;">1.0-3.0</div>														<p><b>For Machining hard-to-cut materials</b></p> <ul style="list-style-type: none"> <li>Stable tool life and good cutting quality in hard-to-cut material cutting due to double reverse positive relief surface and low cutting load chip breaker</li> </ul>						
Rich Mill series-RM8-X	MM			<div style="background-color: #ADD8E6; padding: 2px;">0.05-0.30</div> <div style="background-color: #90EE90; padding: 2px;">1.0-3.0</div>														<p><b>For high hardness cutting</b></p> <ul style="list-style-type: none"> <li>Stable tool life and good cutting quality due to double reverse positive relief surface and high rigidity chip breaker</li> </ul>						
	MM			<div style="background-color: #ADD8E6; padding: 2px;">0.10-0.30</div> <div style="background-color: #90EE90; padding: 2px;">1.0-3.0</div>														<p><b>For General cutting</b></p> <ul style="list-style-type: none"> <li>For general cutting range with optimal shape for general milling</li> </ul>						
Rich Mill series-RM14	ML			<div style="background-color: #ADD8E6; padding: 2px;">0.05-0.30</div> <div style="background-color: #90EE90; padding: 2px;">1.0-3.0</div>														<p><b>For HRSA cutting</b></p> <ul style="list-style-type: none"> <li>Excellent cutting performance in heat resistance STS cutting from neutral type flat cutting edge and sharp chip breaker</li> </ul>						
	ML			<div style="background-color: #ADD8E6; padding: 2px;">0.05-0.30</div> <div style="background-color: #90EE90; padding: 2px;">1.0-3.0</div>														<p><b>For cast iron and STS cutting</b></p> <ul style="list-style-type: none"> <li>Excellent cutting performance in general STS and cast iron cutting from right-handed helix cutting edge and sharp chip breaker</li> </ul>						
Rich Mill series-RM16	MA			<div style="background-color: #ADD8E6; padding: 2px;">0.05-0.30</div> <div style="background-color: #90EE90; padding: 2px;">0.3-5.5</div>														<p><b>For Aluminum machining</b></p> <ul style="list-style-type: none"> <li>Sharp cutting edge design ensures low cutting resistance and excellent machining in difficult-to-cut materials, aluminum and light machining</li> </ul>						
	MF			<div style="background-color: #ADD8E6; padding: 2px;">0.05-0.40</div> <div style="background-color: #90EE90; padding: 2px;">0.3-5.5</div>														<p><b>For Light cutting</b></p> <ul style="list-style-type: none"> <li>Low cutting force chip breaker design ensures longer tool life and excellent machining in difficult-to-cut material and light machining</li> </ul>						

Notice: Application ranges are based on main cutting material











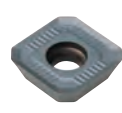

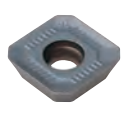

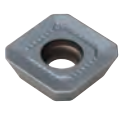





## Chip breaker for milling

Geometry	Cutting edge	Application range																Features								
		feed rate $f_n$ (mm/rev)																								
		0.05	0.10	0.15	0.20	0.25	0.30	0.35	0.40	0.80	1.20	1.40	1.60													
depth of cut $a_p$ (mm)																										
0.1																0.5	1	2	3	4	5	6	8	10	15	20
Rich Mill series-FM16	ML			0.05~0.35 0.3~5.5																<p><b>For Machining hard-to-cut materials</b></p> <ul style="list-style-type: none"> <li>Low cutting resistance for excellent tool life and surface roughness in machining hard-to-cut materials</li> </ul>						
	MM			0.10~0.45 0.5~5.5																<p><b>For General cutting</b></p> <ul style="list-style-type: none"> <li>Suitable geometry design for general milling has wider ranges of machining</li> </ul>						
	W			0.05~0.30 0.3~2.0																<p><b>For Finishing of milling (Wiper)</b></p> <ul style="list-style-type: none"> <li>Wiper insert provides improved surface roughness due to special cutting edge</li> </ul>						
Rich Mill series-RMR	ML			0.05~0.40 1.0~3.0																<p><b>For Machining hard-to-cut materials</b></p> <ul style="list-style-type: none"> <li>Stable tool life and cutting performance in hard-to-cut material cutting from hard clamping side preventing reverse positive revolution and low cutting resistance chip breaker</li> </ul>						
Alpha Mill series	MA			0.10~0.40 0.5~16																<p><b>For Aluminum machining</b></p> <ul style="list-style-type: none"> <li>Sharp cutting edge and lubricated top face show excellent chip flow and welding resistance in aluminum machining</li> </ul>						
	MF			0.05~0.15 0.5~16																<p><b>For Light cutting</b></p> <ul style="list-style-type: none"> <li>Low cutting force chip breaker design ensures longer tool life and excellent machining in difficult-to-cut material and light machining</li> </ul>						
	MM			0.10~0.25 0.5~16																<p><b>For General cutting</b></p> <ul style="list-style-type: none"> <li>Suitable geometry design for general milling has wider ranges of machining</li> </ul>						
	ML			0.05~0.15 0.5~16																<p><b>For Hard-to-cut material machining</b></p> <ul style="list-style-type: none"> <li>The chip breaker with low cutting resistance ensures superior machinability in hard-to-cut materials</li> </ul>						

Notice: Application ranges are based on main cutting material






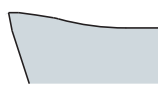




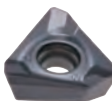
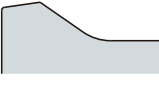






## Chip breaker for milling

Geometry	Cutting edge	Application range													Features				
		feed rate $f_n$ (mm/rev)																	
		0.05	0.10	0.15	0.20	0.25	0.30	0.35	0.40	0.80	1.20	1.40	1.60						
depth of cut ap (mm)																			
0.1	0.5	1	2	3	4	5	6	8	10	15	20								
Alpha Mill series	<b>MN</b> 		<div style="display: flex; justify-content: space-between;"> <div style="background-color: #ADD8E6; padding: 2px;">0.10-0.25</div> <div style="background-color: #90EE90; padding: 2px;">0.5-16</div> </div>													<b>For Roughing (nick)</b>  <ul style="list-style-type: none"> <li>Design for easy chip cutting ensures high machinability in toughing.</li> </ul>			
			Alpha Mill-X series	<b>MM</b> 		<div style="display: flex; justify-content: space-between;"> <div style="background-color: #ADD8E6; padding: 2px;">0.05-0.35</div> <div style="background-color: #90EE90; padding: 2px;">1.0-16.5</div> </div>													<b>For General cutting</b>  <ul style="list-style-type: none"> <li>Shape for general milling with most cutting range</li> </ul>
Alpha Mill-X series	<b>ML</b> 					<div style="display: flex; justify-content: space-between;"> <div style="background-color: #ADD8E6; padding: 2px;">0.05-0.30</div> <div style="background-color: #90EE90; padding: 2px;">1.0-16.5</div> </div>													<b>For Hard-to-cut material machining</b>  <ul style="list-style-type: none"> <li>Chip breaker for cutting with low cutting load guarantees long tool life and qualified machining in light cutting and HRSA machining.</li> </ul>
			Future Mill series	<b>MF</b> 		<div style="display: flex; justify-content: space-between;"> <div style="background-color: #ADD8E6; padding: 2px;">0.05-0.20</div> <div style="background-color: #90EE90; padding: 2px;">0.5-5.0</div> </div>													<b>For Light cutting</b>  <ul style="list-style-type: none"> <li>Special design for light cutting of gummy materials like stainless steel and hard to machine material provide fine surface finish and longer tool life</li> </ul>
Future Mill series	<b>MM</b> 					<div style="display: flex; justify-content: space-between;"> <div style="background-color: #ADD8E6; padding: 2px;">0.05-0.30</div> <div style="background-color: #90EE90; padding: 2px;">1.0-5.0</div> </div>													<b>For General cutting</b>  <ul style="list-style-type: none"> <li>Chip breaker design to cover general cutting condition provides wide available application range</li> <li>Ground type and as sintered type is available</li> </ul>
						Future Mill series	<b>MR</b> 		<div style="display: flex; justify-content: space-between;"> <div style="background-color: #ADD8E6; padding: 2px;">0.05-0.35</div> <div style="background-color: #90EE90; padding: 2px;">1.5-5.0</div> </div>										
Future Mill series	<b>MA</b> 								<div style="display: flex; justify-content: space-between;"> <div style="background-color: #ADD8E6; padding: 2px;">0.10-0.35</div> <div style="background-color: #90EE90; padding: 2px;">0.5-5.0</div> </div>										
			Future Mill series P-posi	<b>MA</b> 		<div style="display: flex; justify-content: space-between;"> <div style="background-color: #90EE90; padding: 2px;">0.3-6.0</div> <div style="background-color: #ADD8E6; padding: 2px;">0.30-0.60</div> </div>													<b>For Aluminum machining</b>  <ul style="list-style-type: none"> <li>Excellent surface roughness due to buffed surface in machining aluminum</li> </ul>

Notice: Application ranges are based on main cutting material



## Chip breaker for milling









Geometry	Cutting edge	Application range																Features		
		feed rate $f_n$ (mm/rev)																		
		0.05	0.10	0.15	0.20	0.25	0.30	0.35	0.40	0.80	1.20	1.40	1.60	depth of cut $a_p$ (mm)						
				0.1	0.5	1	2	3	4	5	6	8	10	15	20					
Future Mill series P-posi	ML																0.3-3.0	0.30-0.50	<b>For Hard-to-cut material machining</b> <ul style="list-style-type: none"> <li>Low cutting resistance and high hardness cutting edges for excellent surface roughness in machining titanium and Inconel</li> </ul>	
	MF																	0.12-0.50	0.3-6.0	<b>For Light cutting</b> <ul style="list-style-type: none"> <li>Low cutting resistance for light cutting</li> </ul>
	MM																	0.20-0.70	0.3-6.0	<b>For General cutting</b> <ul style="list-style-type: none"> <li>Universal purpose for most of milling applications</li> </ul>
	None C/B																0.3-0.5	0.30-0.50	<b>For Machining high hardness steel</b> <ul style="list-style-type: none"> <li>Ideal for machining high hardness mold steel and heat resistant alloy</li> </ul>	
Triple Mill series	ML																0.10-0.30	1.0-15.5	<b>For Hard-to-cut material machining</b> <ul style="list-style-type: none"> <li>Stable tool life and cutting performance in hard-to-cut material cutting due to low cutting load chip breaker</li> </ul>	
	MM																0.10-0.30	1.0-15.5	<b>For General cutting</b> <ul style="list-style-type: none"> <li>For general cutting range with optimal shape for general milling</li> </ul>	
HFM	MF															0.1-0.4	0.30-1.0	<b>For Light cutting</b> <ul style="list-style-type: none"> <li>Chip breaker for cutting with low cutting load is optimal for light cutting.</li> </ul>		
	None C/B															0.1-0.4	0.30-0.80	<b>For Machining high hardness steel</b> <ul style="list-style-type: none"> <li>Shape with hard cutting edge is optimal for high hardness alloy steel machining.</li> </ul>		

Notice: Application ranges are based on main cutting material





## Chip breaker for drilling

Geometry	Cutting edge	Application range												Features									
		feed rate $f_n$ (mm/rev)																					
		0.04	0.063	0.10	0.16	0.25	0.4	0.63	1.0	1.6	2.5	4.0	6.3										
depth of cut $a_p$ (mm)																							
												30	60	90	120	150	180	210	240	270	300	330	900
King Drill series	<b>PD</b>			<div style="display: flex; justify-content: space-between;"> <span>0.04-0.20</span> <span>60-300</span> </div>												<p><b>For General cutting</b></p> <ul style="list-style-type: none"> <li>Chip breaker with strong cutting edge for universal applications with steel, stainless steel, and cast iron</li> </ul>							
	<b>LD</b>			<div style="display: flex; justify-content: space-between;"> <span>0.04-0.15</span> <span>40-250</span> </div>												<p><b>For Light cutting</b></p> <ul style="list-style-type: none"> <li>Superior chip control in machining of mild steel, forged steel and stainless steel</li> </ul>							
	<b>RD</b>			<div style="display: flex; justify-content: space-between;"> <span>0.04-0.20</span> <span>60-300</span> </div>												<p><b>Reinforced chipping resistance</b></p> <ul style="list-style-type: none"> <li>Improved central chipping resistance due to reinforced corners of the King Drill central inserts</li> <li>Excellent cutting performance even in machining where there is frequent corner breakage of central inserts</li> <li>e.g. Machining heat-treated steel or stainless steel, and high feed machining, etc.</li> </ul>							
	<b>ND</b>			<div style="display: flex; justify-content: space-between;"> <span>0.04-0.10</span> <span>100-400</span> </div>												<p><b>Non-ferrous metals</b></p> <ul style="list-style-type: none"> <li>Chip breaker with sharp and polished cutting edge for aluminum and Non-ferrous metals. Machining with King Drill ensures good chip flow and resistance to chip welding.</li> </ul>							

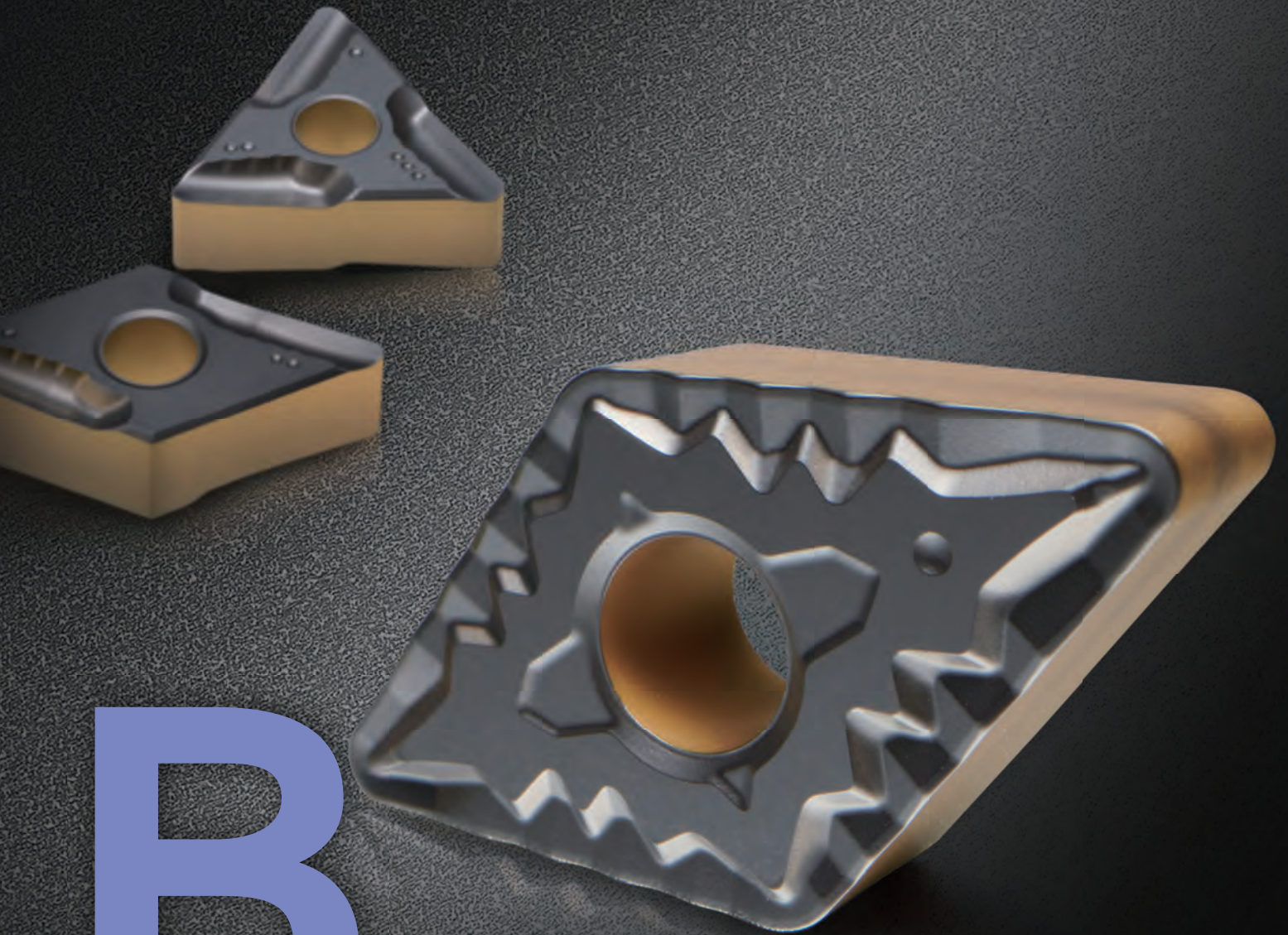
Notice: Application ranges are based on main cutting material





# TURNING

Korloy turning tools cover a wide application range with a full line-up of ISO tools that produce high quality and high precision parts all for manufacturers' requirements.



# B



## Turning Chip Breakers

- B02** Application range of KORLOY Main Chip Breakers
- B04** Recommended Chip Breakers for workpiece
- B16** Feature of Chip Breakers

## Inserts

- B34** Turning Insert Code System (ISO)
- B36** Turning Insert (Negative)
- B73** Turning Insert (Positive)
- B102** Aluminum Insert (Positive)
- B110** cBN Insert
- B113** PCD Insert

## SAVE TURN

- B114** Technical Information for SAVE TURN
- B115** SAVE TURN Insert
- B116** SAVE TURN Holder
- B119** SAVE TURN Boring Bar

## Auto Tools

- B121** Technical Information for Auto Tools
- B122** ISO Type
- B127** KHP Coolant
- B136** Blade Type
- B139** Multi Utility Type
- B142** KGT/MGT Type
- B145** MSB Tool
- B151** Sleeve

## Multi Turn

- B152** Technical Information for Multi Turn
- B154** Multi Turn

## Bearing Solutions

- B155** Technical Information for Bearing Solution
- B156** Bearing Solution
- B161** Special Order Form for Bearing Inserts

## External Tool Holder

- B162** External Tool Holder Code System (ISO)
- B163** Index for External Holder
- B166** Instruction of External Holder
- B167** Double Clamp System
- B172** Lever Lock System
- B179** Wedge Clamp System
- B181** Clamp On System
- B183** Multi Lock System
- B190** Screw On System
- B197** Ceramic Holder

## High Pressure Coolant

- B199** Technical Information for KHP Coolant
- B202** KHP Coolant

## Boring Bar

- B204** Boring Bar Code System (ISO)
- B205** Index for Boring Bar
- B207** Instruction of Boring Bar assembly
- B208** Double Clamp System
- B210** Lever Lock System
- B212** Clamp On System
- B213** Multi Lock System
- B215** Screw On System
- B225** Compact Mini

## HSK/KM Tooling System

- B228** Technical Information for
- B230** HSK / KM Tooling System
- B231** Index for HSK / KM Tooling System
- B237** HSK Tooling System  
KM Tooling System

## Cartridges

- B241** Cartridge Code System (ISO)
- B242** Index for Cartridge
- B243** Clamp On System
- B245** Screw On System

# B Turning Chip Breakers

## Applications range of chip breakers

### ➤ Negative inserts

**Workpiece P**  
Steel

Heavy	<b>GH</b>	<b>VH</b>	<b>VT</b>
Roughing	<b>GR</b>		
Medium cutting	<b>VM</b>	<b>MP</b>	<b>HM</b>
Medium to finishing	<b>VC</b>	<b>LP</b>	<b>CP</b>
Finishing	<b>VL</b>	<b>VB</b>	<b>VF</b>

[Recommended]

**Workpiece K**  
Cast iron

Roughing	<del>VR</del>	<del>RK</del>	<del>MA</del>
Medium cutting		<del>MK</del>	
Medium to finishing		<del>MK</del>	<del>B25</del>
Finishing		<del>MP</del>	

[Recommended]

**Workpiece M**  
Stainless steel

Roughing	<b>RM</b>		
Medium cutting	<b>MP</b>	<b>MM</b>	
Medium to finishing		<b>VP2</b>	
Finishing			

[Recommended]

**Workpiece N**  
Aluminum alloy

Medium to finishing	<b>HA</b>		
---------------------	-----------	--	--

[Recommended]

**Workpiece S**  
Heat resistant alloy

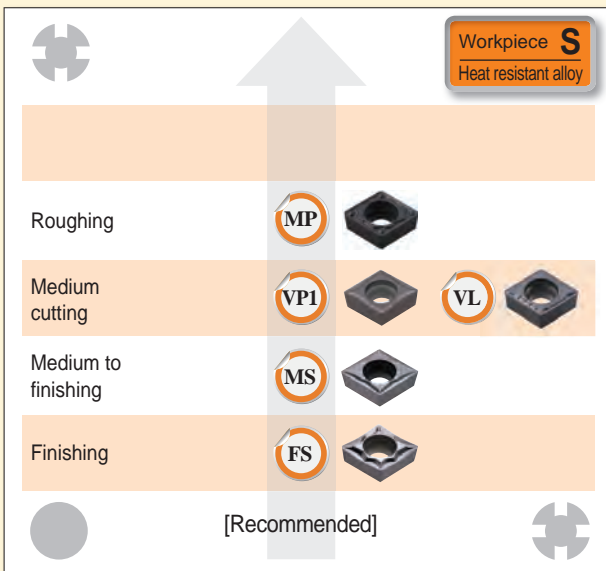
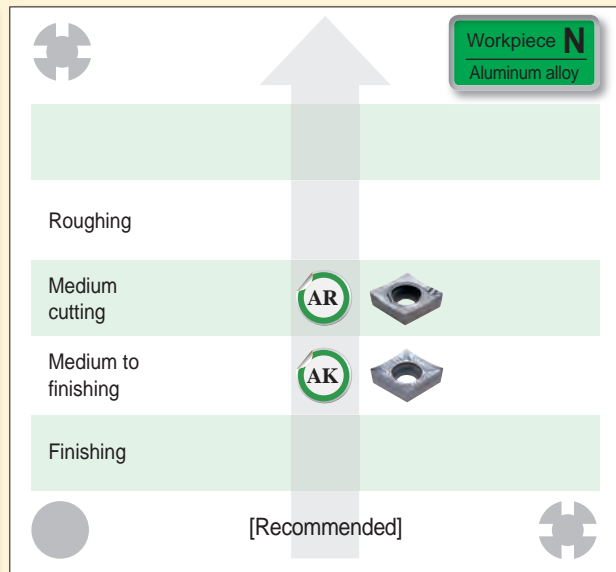
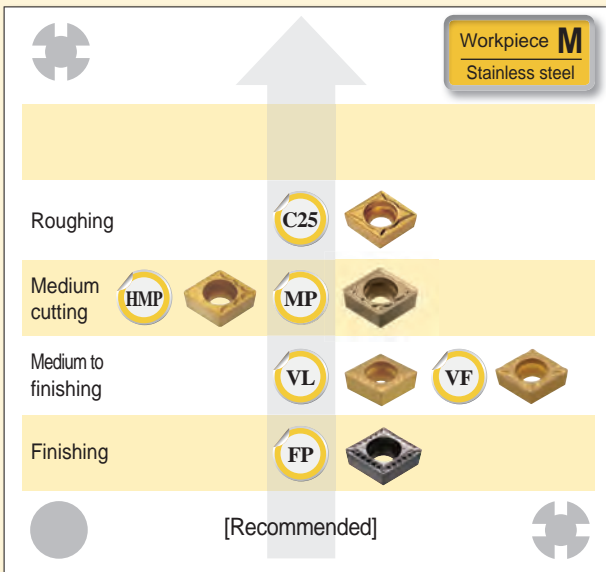
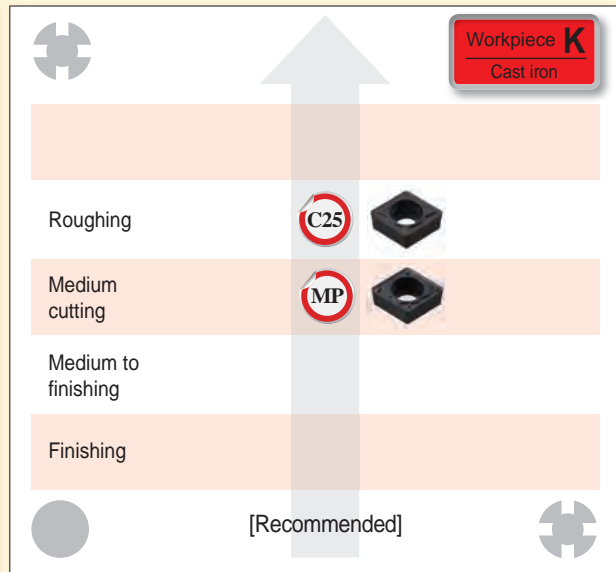
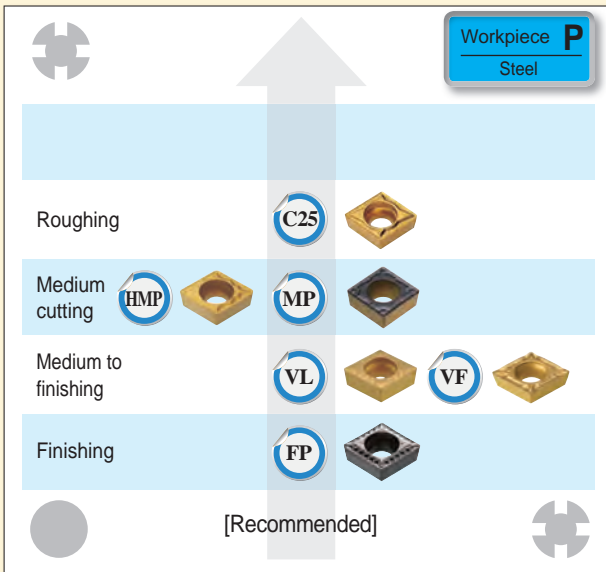
Roughing	<b>VP4</b>		
Medium cutting	<b>VP3</b>		
Medium to finishing	<b>VP2</b>		
Finishing	<b>VP1</b>		

[Recommended]



## Applications range of chip breakers

### Positive inserts



# B Turning Chip Breakers

Workpiece  
**P**  
Steel

## Recommended chip breaker for workpiece

Materials: SM10C, SM15C, SM25C, SS400, SCr415, SCM415, etc. Soft steel

Hardness: under 180HB

Depth of cut (mm)	C/B	Cutting edge	Feed (mm/rev)	Grades	Cutting Speed (m/min)	Insert shape						
Negative	0.2 ~ 0.8 ~ 1.5 Finishing	VL 		0.10 ~ 0.20 ~ 0.35	NC3215 NC3225 CN1500 CN2500	305 250 260 230	CNMG 	DNMG 	SNMG 	TNMG 	VNMG 	WNMG 
	0.5 ~ 1.0 ~ 2.0 Finishing	VB 		0.15 ~ 0.20 ~ 0.40	NC3215 NC3225 CN1500 CN2500	340 250 240 210	CNMG 	DNMG 		TNMG 		WNMG 
	0.5 ~ 1.0 ~ 1.5 Finishing	VF 		0.05 ~ 0.15 ~ 0.35	NC3215 NC3220 NC3225 NC5330	305 270 270 210	CNMG 	DNMG 	SNMG 	TNMG 	VNMG 	WNMG 
	0.5 ~ 1.5 ~ 3.5 Medium to finishing	VC 		0.12 ~ 0.25 ~ 0.45	NC3215 NC3220 NC3225 NC5330	285 250 255 200	CNMG 	DNMG 	SNMG 	TNMG 	VNMG 	WNMG 
	0.5 ~ 1.0 ~ 3.5 Medium to finishing	LP 		0.10 ~ 0.25 ~ 0.40	NC3215 NC3225 NC5330	300 250 200	CNMG 	DNMG 	SNMG 	TNMG 	VNMG 	WNMG 
	0.5 ~ 1.3 ~ 3.5 Medium to finishing	VQ 		0.12 ~ 0.2 ~ 0.42	NC3215 NC3225 NC5330	300 250 200	CNMG 	DNMG 	SNMG 	TNMG 	VNMG 	WNMG 
	0.5 ~ 1.3 ~ 3.5 Medium to finishing	CP 		0.1 ~ 0.28 ~ 0.35	NC3215P NC3225P	285 250	CNMG 	DNMG 	SNMG 	TNMG 	VNMG 	WNMG 
	0.5 ~ 1.5 ~ 4.5 Medium cutting	MP 		0.15 ~ 0.30 ~ 0.45	NC3215 NC3225 NC5330	300 265 200	CNMG 	DNMG 	SNMG 	TNMG 	VNMG 	WNMG 
	1.0 ~ 2.5 ~ 5.0 Medium cutting	VM 		0.10 ~ 0.25 ~ 0.50	NC3215 NC3220 NC3225 NC5330 CN1500 CN2500	295 260 260 205 220 200	CNMG 	DNMG 	SNMG 	TNMG 	VNMG 	WNMG 
	1.5 ~ 2.5 ~ 5.5 Medium cutting	HM 		0.12 ~ 0.28 ~ 0.52	NC3215 NC3225 NC5330	300 265 200	CNMG 	DNMG 	SNMG 	TNMG 	VNMG 	WNMG 

• The first recommended cutting condition



Workpiece  
**P**  
Steel

## Recommended chip breaker for workpiece

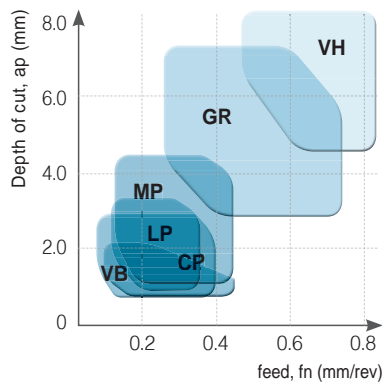
Materials: SM10C, SM15C, SM25C, SS400, SCr415, SCM415, etc. Soft steel

Hardness: under 180HB

Depth of cut (mm)	C/B	Cutting edge	Feed (mm/rev)	Grades	Cutting Speed (m/min)	Insert shape					
						80°	55°	90°	60°	35°	80°
Negative 1.0 ~ 3.0 ~ 4.5 Roughing	GR		0.20 ~ 0.35 ~ 0.50	NC3125 NC3225 NC5330	180~370 150~330 130~280	CNMG  p. B38	DNMG  p. B45	SNMG  p. B52	TNMG  p. B60	WNMG  p. B69	
	GH		0.30 ~ 0.80 ~ 1.30	NC3125 NC3225 NC5330	180~370 150~330 130~280	CNMM  p. B42		SNMM  p. B57			
	VH		0.70 ~ 1.00 ~ 1.40	NC3215 NC3030 NC500H NC5330	50~250 50~150 50~150 50~150	CNMM  p. B42		SNMM  p. B57			
	VT		0.75 ~ 1.20 ~ 1.60	NC3215 NC3030 NC500H NC5330	50~250 50~150 50~150 50~150	CNMM  p. B42		SNMM  p. B57			

• The first recommended cutting condition

### **P** Negative





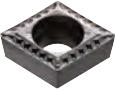
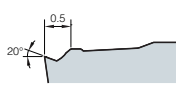

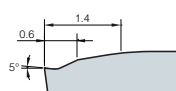

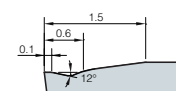
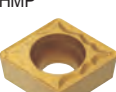
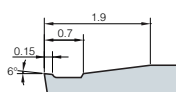

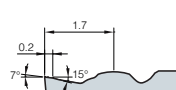

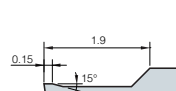
# B Turning Chip Breakers

Workpiece  
**P**  
Steel

## Recommended chip breaker for workpiece

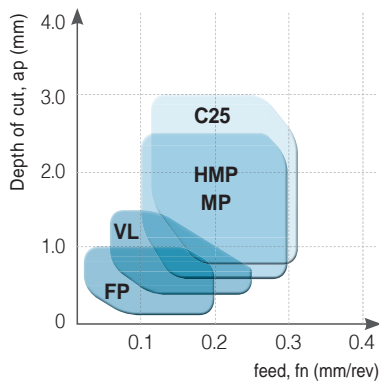
Materials: SM10C, SM15C, SM25C, SS400, SCr415, SCM415, etc. Soft steel

Hardness: under 180HB

Depth of cut (mm)	C/B	Cutting edge	Feed (mm/rev)	Grades	Cutting Speed (m/min)	Insert shape					
						80°	55°	90°	60°	35°	80°
Positive	0.1 ~ 1.0 Finishing	FP 		0.01 ~ 0.20	NC3215 NC3225 CN1500 CN2500	350 270 260 240	CCMT p. B73	DCMT p. B79	SCMT p. B84	TCMT p. B88	VB(C)MT p. B94
	0.1 ~ 1.0 Medium to finishing	VL 		0.05 ~ 0.20	NC3215 NC3220 NC3225 NC5330 CN1500 CN2500	305 270 270 210 260 240	CCMT p. B73	DCMT p. B79	SCMT p. B84	TCMT p. B88	VB(C)MT p. B94
	0.1 ~ 1.5 Medium to finishing	VF 		0.05 ~ 0.25	NC3215 NC3220 NC3225 NC5330 CC1500 CN1500 CN2500	305 270 270 210 260 250 230	CCMT p. B73	DCMT p. B79	SCMT p. B84	TC(P)MT p. B88	VB(C)MT p. B94
	0.6 ~ 2.5 Medium cutting	HMP 		0.10 ~ 0.30	NC3215 NC3220 NC3225 NC5330 CN1500 CN2500	320 285 285 225 240 220	CCMT p. B73	DCMT p. B79	SCMT p. B84	TCMT p. B88	VB(C)MT p. B94
	0.6 ~ 2.5 Medium cutting	MP 		0.10 ~ 0.30	NC3215 NC3225 CN1500 CN2500	300 250 240 200	CCMT p. B73	DCMT p. B79	SCMT p. B84	TC(P)MT p. B88	VB(C)MT p. B94
	0.8 ~ 3.0 Roughing	C25 		0.12 ~ 0.32	NC3215 NC3220 NC3225 NC5330 CN1500 CN2500	320 285 285 225 230 210	CCMT p. B74	DCMT p. B80	SCMT p. B84	TCMT p. B89	

• The first recommended cutting condition

### P Positive


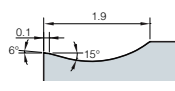





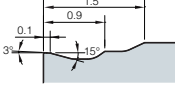







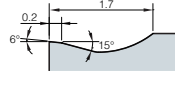






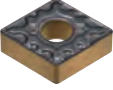
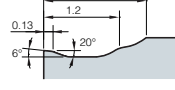






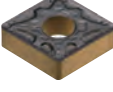
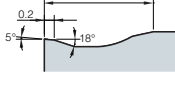






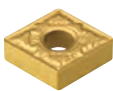
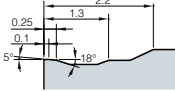







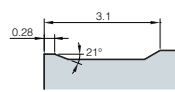






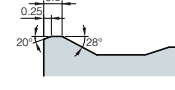


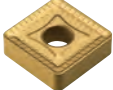
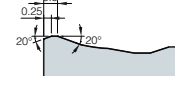




Workpiece  
**P**  
Steel

## Recommended chip breaker for workpiece

Materials: SM45C, SM55C, SCM430, SCM440, etc. General steel

Hardness: under 180~260HB

Depth of cut (mm)	C/B	Cutting edge	Feed (mm/rev)	Grades	Cutting Speed (m/min)	Insert shape						
						80°	55°	90°	60°	35°	80°	
Negative	0.5 ~ 1.0 ~ 2.0 Finishing	VB 		0.15 ~ 0.20 ~ 0.40	NC3215 NC3225 CN1500 CN2500	340 250 230 190	CNMG 	DNMG 		TNMG 		WNMG 
	0.5 ~ 1.0 ~ 1.5 Finishing	VF 		0.08 ~ 0.15 ~ 0.35	NC3215 NC3225 NC5330	305 270 250	CNMG 	DNMG 	SNMG 	TNMG 	VNMG 	WNMG 
	0.5 ~ 1.0 ~ 3.5 Medium to finishing	VC 		0.12 ~ 0.25 ~ 0.45	NC3215 NC3220 NC3225 NC5330	285 255 250 200	CNMG 	DNMG 	SNMG 	TNMG 	VNMG 	WNMG 
	0.5 ~ 1.0 ~ 2.5 Medium cutting	LP 		0.10 ~ 0.25 ~ 0.40	NC3215 NC3225 NC5330	300 250 200	CNMG 	DNMG 	SNMG 	TNMG 	VNMG 	WNMG 
	0.5 ~ 1.5 ~ 4.5 Medium cutting	MP 		0.15 ~ 0.30 ~ 0.45	NC3215 NC3225 NC5330	300 250 200	CNMG 	DNMG 	SNMG 	TNMG 	VNMG 	WNMG 
	1.0 ~ 2.5 ~ 5.0 Medium cutting	VM 		0.15 ~ 0.25 ~ 0.50	NC3215 NC3220 NC3225 NC5330 CN1500 CN2500	260 245 245 205 210 170	CNMG 	DNMG 	SNMG 	TNMG 	VNMG 	WNMG 
	1.0 ~ 3.0 ~ 4.5 Medium to roughing	GR 		0.20 ~ 0.35 ~ 0.50	NC3125 NC3225 NC5330	180~370 150~330 130~280	CNMG 	DNMG 	SNMG 	TNMG 		WNMG 
	6.0 ~ 10.0 ~ 15.0 Heavy (General)	VH 		0.70 ~ 1.00 ~ 1.40	NC3215 NC3030 NC500H NC5330	50~250 50~150 50~150 50~150	CNMM 		SNMM 			
	7.0 ~ 12.0 ~ 17.0 Heavy (High feed cutting)	VT 		0.75 ~ 1.20 ~ 1.60	NC3215 NC3030 NC500H NC5330	50~250 50~150 50~150 50~150	CNMM 		SNMM 			

• The first recommended cutting condition



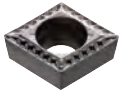
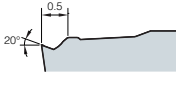





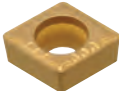
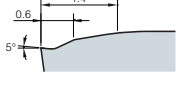






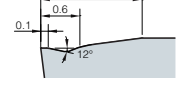





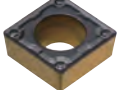
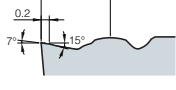






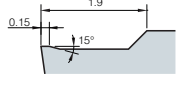




# B Turning Chip Breakers

Workpiece  
**P**  
Steel

## Recommended chip breaker for workpiece

Materials: SM45C, SM55C, SCM430, SCM440, etc. General steel

Hardness: under 180~260HB

Depth of cut (mm)	C/B	Cutting edge	Feed (mm/rev)	Grades	Cutting Speed (m/min)	Insert shape						
						80°	55°	90°	60°	35°	80°	
Positive	0.1 ~ 1.0 0.5 Finishing	FP 		0.01 ~ 0.20 0.06	NC3215 NC3225 CN1500 CN2500	350 270 260 240	CCMT  p. B73	DCMT  p. B79	SCMT  p. B84	TCMT  p. B88	VB(C)MT  p. B94	
	0.4 ~ 1.0 0.5 Medium to finishing	VL 		0.05 ~ 0.25 0.10	NC3215 NC3220 NC3225 NC5330 CN1500 CN2500	345 310 310 240 250 210	CCMT  p. B73	DCMT  p. B79	SCMT  p. B84	TCMT  p. B88	VB(C)MT  p. B94	
	0.1 ~ 1.5 0.5 Medium to finishing	VF 		0.05 ~ 0.25 0.15	NC3215 NC3220 NC3225 NC5330 CC1500 CN1500 CN2500	265 300 300 230 260 240 210	CCMT  p. B73	DCMT  p. B79	SCMT  p. B84	TC(P)MT  p. B88	VB(C)MT  p. B94	
	0.6 ~ 2.5 1.5 Medium cutting	MP 		0.10 ~ 0.30 0.15	NC3215 NC3225	300 250	CCMT  p. B73	DCMT  p. B79	SCMT  p. B84	TC(P)MT  p. B88	VB(C)MT  p. B94	
	0.8 ~ 3.0 2.0 Roughing	C25 		0.12 ~ 0.32 0.15	NC3215 NC3220 NC3225 NC5330 CN1500 CN2500	320 285 285 225 230 200	CCMT  p. B74	DCMT  p. B80	SCMT  p. B84	TCMT  p. B89		

• The first recommended cutting condition

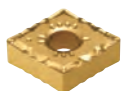
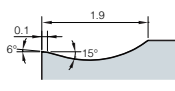





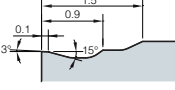







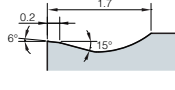






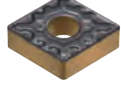
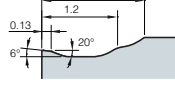







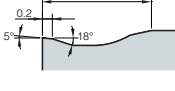







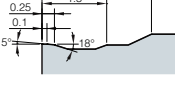







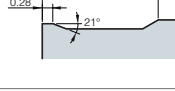






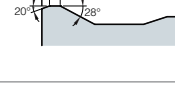



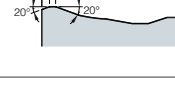




Workpiece  
**P**  
Steel

## Recommended chip breaker for workpiece

Materials: SNC415, SNC815, SNCM240, SNCM439, STS12, STS61, etc  
SCM440, Hardened steel

Hardness: 260~350HB

Depth of cut (mm)	C/B	Cutting edge	Feed (mm/rev)	Grades	Cutting Speed (m/min)	Insert shape						
						80°	55°	90°	60°	35°	80°	
Negative	0.5 ~ 1.0 ~ 2.0 Finishing	VB 		0.15 ~ 0.20 ~ 0.40	NC3215 NC3225 CN1500 CN2500	200 148 220 200	CNMG  p. B36	DNMG  p. B43		TNMG  p. B58		WNMG  p. B68
	0.5 ~ 1.0 ~ 1.5 Finishing	VF 		0.08 ~ 0.15 ~ 0.30	NC3215 NC3220 NC3225	180 159 159	CNMG  p. B36	DNMG  p. B43	SNMG  p. B50	TNMG  p. B58	VNMG  p. B66	WNMG  p. B68
	0.5 ~ 1.5 ~ 3.5 Medium to finishing	VC 		0.12 ~ 0.25 ~ 0.45	NC3215 NC3220 NC3225 NC5330	168 148 150 200	CNMG  p. B36	DNMG  p. B44	SNMG  p. B50	TNMG  p. B59	VNMG  p. B66	WNMG  p. B68
	0.5 ~ 1.0 ~ 2.5 Medium cutting	LP 		0.10 ~ 0.25 ~ 0.40	NC3215 NC3225 NC5330	250 200 200	CNMG  p. B36	DNMG  p. B43	SNMG  p. B50	TNMG  p. B58	VNMG  p. B66	WNMG  p. B68
	0.5 ~ 1.5 ~ 4.5 Medium cutting	MP 		0.15 ~ 0.25 ~ 0.45	NC3215 NC3225 NC5330	250 200 200	CNMG  p. B37	DNMG  p. B44	SNMG  p. B51	TNMG  p. B59	VNMG  p. B66	WNMG  p. B69
	1.0 ~ 2.5 ~ 5.0 Medium cutting	VM 		0.15 ~ 0.25 ~ 0.50	NC3215 NC3220 NC3225 CN1500 CN2500	174 153 153 120 100	CNMG  p. B37	DNMG  p. B45	SNMG  p. B51	TNMG  p. B59	VNMG  p. B67	WNMG  p. B69
	1.0 ~ 3.0 ~ 4.5 Medium to roughing	GR 		0.20 ~ 0.35 ~ 0.50	NC3125 NC3225 NC5330	180~370 150~330 130~280	CNMG  p. B38	DNMG  p. B45	SNMG  p. B52	TNMG  p. B60		WNMG  p. B69
	6.0 ~ 10.0 ~ 15.0 Heavy (General)	VH 		0.70 ~ 1.00 ~ 1.40	NC3215 NC3030 NC500H NC5330	50~250 50~150 50~150 50~150	CNMM  p. B42		SNMM  p. B57			
	7.0 ~ 12.0 ~ 17.0 Heavy (High feed cutting)	VT 		0.75 ~ 1.20 ~ 1.60	NC3215 NC3030 NC500H NC5330	50~250 50~150 50~150 50~150	CNMM  p. B42		SNMM  p. B57			

• The first recommended cutting condition



# B Turning Chip Breakers

Workpiece  
**P**  
Steel

## Recommended chip breaker for workpiece

Materials: SNC415, SNC815, SNCM240, SNCM439, STS12, STS61, etc  
SCM440, Hardened steel  
Hardness: 260~350HB

Depth of cut (mm)	C/B	Cutting edge	Feed (mm/rev)	Grades	Cutting Speed (m/min)	Insert shape						
Positive	0.1 ~ 0.5 ~ 1.0 Finishing	FP 		0.01 ~ 0.06 ~ 0.20	NC3215 NC3225 CN1500 CN2500	350 270 260 240	CCMT 	DCMT 	SCMT 	TCMT 	VB(C)MT 	p. B73 p. B79 p. B84 p. B88 p. B94
	0.4 ~ 0.5 ~ 1.5 Medium to finishing	VL 		0.05 ~ 0.10 ~ 0.25	NC3215 NC3220 NC3225 NC5330 CN1500 CN2500	305 310 310 240 210 190	CCMT 	DCMT 	SCMT 	TCMT 	VB(C)MT 	p. B73 p. B79 p. B84 p. B88 p. B94
	0.1 ~ 0.5 ~ 1.5 Medium to finishing	VF 		0.05 ~ 0.15 ~ 0.25	NC3215 NC3220 NC3225 NC5330 CC1500 CN1500 CN2500	330 300 300 230 260 250 240	CCMT 	DCMT 	SCMT 	TC(P)MT 	VB(C)MT 	p. B73 p. B79 p. B84 p. B88 p. B94
	0.6 ~ 1.5 ~ 2.5 Medium cutting	MP 		0.10 ~ 0.15 ~ 0.30	NC3215 NC3225 NC5300 CN1500 CN2500	305 285 225 240 220	CCMT 	DCMT 	SCMT 	TC(P)MT 	VB(C)MT 	p. B73 p. B79 p. B84 p. B88 p. B94
	0.8 ~ 2.0 ~ 3.0 Roughing	C25 		0.12 ~ 0.15 ~ 0.32	NC3215 NC3220 NC3225 NC5330 CN1500 CN2500	320 285 285 225 100 80	CCMT 	DCMT 	SCMT 	TCMT 		p. B74 p. B80 p. B84 p. B89

• The first recommended cutting condition




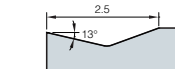






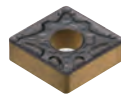
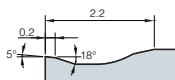







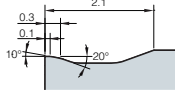







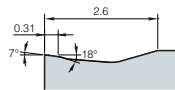






Workpiece  
M  
 Stainless steel

## Recommended chip breaker for workpiece

**Materials:** STS304, STS316, STS430, STS630

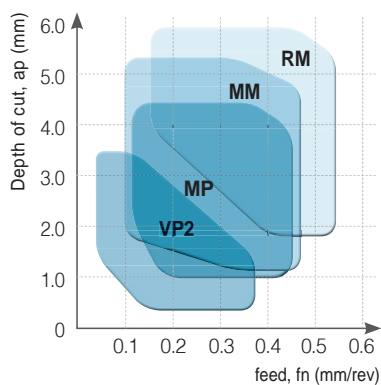
Ferrite, austenite, martensite, precipitation hardening stainless steels

**Hardness:** 135~300HB

Depth of cut (mm)	C/B	Cutting edge	Feed (mm/rev)	Grades	Cutting Speed (m/min)	Insert shape						
						80°	55°	90°	60°	35°	80°	
Negative	0.5 ~ <span style="color: red;">1.5</span> ~ 4.0 Medium to finishing	VP2 		0.10 ~ <span style="color: red;">0.20</span> ~ 0.40	PC8105 PC8110 PC8115 PC5300 <span style="color: red;">PC5400</span>	185 170 160 135 <span style="color: red;">120</span>	CNMG  p. B41	DNMG  p. B47	SNMG  p. B55	TNMG  p. B63	VNMG 	WNMG  p. B71
	1.0 ~ <span style="color: red;">2.0</span> ~ 4.5 Medium cutting	MP 		0.15 ~ <span style="color: red;">0.23</span> ~ 0.45	PC8105 PC8110 PC8115 PC5300 <span style="color: red;">PC5400</span>	175 160 150 130 <span style="color: red;">110</span>	CNMG  p. B37	DNMG  p. B44	SNMG  p. B51	TNMG  p. B59	VNMG  p. B66	WNMG  p. B69
	0.5 ~ <span style="color: red;">3.0</span> ~ 5.5 Medium cutting	MM 		0.12 ~ <span style="color: red;">0.25</span> ~ 0.45	NC9115 <span style="color: red;">NC9125</span> NC9135 PC8110 PC8115 PC5300	190 <span style="color: red;">170</span> 130 160 150 130	CNMG  p. B40	DNMG  p. B46	SNMG  p. B54	TNMG  p. B62	VNMG  p. B67	WNMG  p. B71
	2.0 ~ <span style="color: red;">4.0</span> ~ 6.0 Roughing	RM 		0.15~ <span style="color: red;">0.30</span> ~ 0.55	NC9115 <span style="color: red;">NC9125</span> NC9135 PC8110 PC8115 PC5300	190 <span style="color: red;">170</span> 130 160 150 130	CNMG  p. B40	DNMG  p. B47	SNMG  p. B55	TNMG  p. B63	VNMG  p. B67	WNMG  p. B71

• The first recommended cutting condition

### M Negative





# B Turning Chip Breakers

Workpiece  
**M**  
Stainless steel

## Recommended chip breaker for workpiece

Materials: STS304, STS316, STS430, STS630

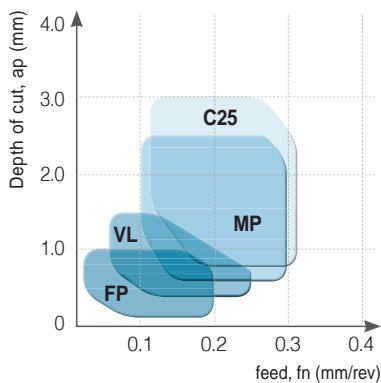
Ferrite, austenite, martensite, precipitation hardening stainless steels

Hardness: 135~300HB

Depth of cut (mm)	C/B	Cutting edge	Feed (mm/rev)	Grades	Cutting Speed (m/min)	Insert shape					
						80°	55°	90°	60°	35°	80°
Positive 0.1 ~ 1.0 Finishing	VL		0.05 ~ 0.10 ~ 0.20	PC8105 PC8110 PC8115 PC5300 PC5400 NC5330 NC9025	215 195 190 165 135 165 165	CCMT p. B73	DCMT p. B79	SCMT p. B84	TCMT p. B88	VB(C)/MT p. B94	
	HMP		0.05 ~ 0.10 ~ 0.25	PC8105 PC8110 PC8115 PC5400 NC5330 NC9025	190 175 170 120 150 150	CCMT p. B73	DCMT p. B79	SCMT p. B84	TCMT p. B88	VB(C)/MT p. B94	
	MP		0.05 ~ 0.15 ~ 0.35	PC8105 PC8110 PC8115 PC5400 NC5330 NC9025	190 175 170 120 150 150	CCMT p. B73	DCMT p. B79	SCMT p. B84	TC(P)/MT p. B88	VB(C)/MT p. B94	
	C25		0.08 ~ 0.13 ~ 0.25	PC8110 PC5300 PC9030	170 155	CCMT p. B74	DCMT p. B80	SCMT p. B84	TCMT p. B89		

• The first recommended cutting condition

### M Positive



Workpiece  
**K**  
Cast iron

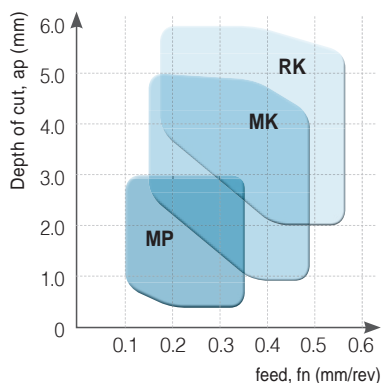
## Recommended chip breaker for workpiece

Materials: GC250, GC300, GCD400, GCD700, etc : Gray cast iron, Ductile cast iron  
Hardness: 135~185HB  
Tensile strength: under 450N/mm<sup>2</sup>

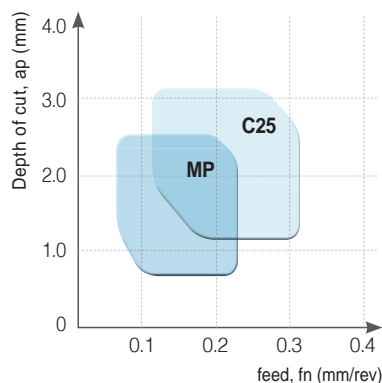
Depth of cut (mm)	C/B	Cutting edge	Feed (mm/rev)	Grades	Cutting Speed (m/min)	Insert shape						
						80°	55°	90°	60°	35°	80°	
Negative	1.0 ~ 3.0 ~ 4.5 Roughing	VR 		0.20 ~ 0.35 ~ 0.60	NC6310	220~420	CNMG p. B39	DNMG p. B46	SNMG p. B54	TNMG p. B62	WNMG p. B70	
	1.5 ~ 3.0 ~ 6.0 Roughing	RK 		0.20 ~ 0.30 ~ 0.60	NC6310	350~550	CNMG p. B39	DNMG p. B46	SNMG p. B54	TNMG p. B62	WNMG p. B70	
	1.0 ~ 2.5 ~ 6.0 Roughing	C/B none 		0.15 ~ 0.30 ~ 0.60	DB1000 DBN500 DBN700A NC6310 NC6315	150 ~ 200 200 ~ 500 500 ~ 2000 140 ~ 420 120 ~ 290	CNMA p. B39	DNMA p. B46	SNMA p. B53	TNMA p. B61		
	1.0 ~ 2.5 ~ 5.0 Medium - Medium to finishing	MK 		0.10 ~ 0.25 ~ 0.50	NC6310	350~550	CNMG p. B38	DNMG p. B46	SNMG p. B53	TNMG p. B61	VNMG p. B67	WNMG p. B70
	0.5 ~ 2.0 ~ 3.5 Medium to finishing	B25 		0.20 ~ 0.35 ~ 0.60	NC6310 NC6315	140~380 120~290	CNMG p. B38	DNMG p. B45	SNMG p. B52	TNMG p. B60		
	0.5 ~ 1.0 ~ 2.5 Finishing	MP 		0.10 ~ 0.25 ~ 0.45	NC6310 NC6315	140~380 120~290	CNMG p. B37	DNMG p. B44	SNMG p. B51	TNMG p. B59	VNMG p. B66	WNMG p. B69
Positive	1.0 ~ 3.0 ~ 4.5 Roughing	MP 		0.10 ~ 0.20 ~ 0.35	NC6310	225~290	CCMT p. B73	DCMT p. B79	SCMT p. B84	TC(P)MT p. B88	VB(C)MT p. B94	
	1.5 ~ 3.0 ~ 6.0 Roughing	C25 		0.10 ~ 0.25 ~ 0.40	NC6310 NC6315	285~340 200	CCMT p. B74	DCMT p. B80	SCMT p. B84	TCMT p. B89		

• The first recommended cutting condition

### **K** Negative



### **K** Positive



# B Turning Chip Breakers

Workpiece  
**N**  
Aluminum alloy

## Recommended chip breaker for workpiece

Materials: Aluminum alloy

Hardness: 20~110HB

Depth of cut (mm)	C/B	Cutting edge	Feed (mm/rev)	Grades	Cutting Speed (m/min)	Insert shape					
						80°	55°	90°	60°	35°	80°
<b>Negative</b> 0.5 ~ 2.0 ~ 6.0 Medium cutting	HA		0.10 ~ 0.20 ~ 0.50	H01	500	CNMG	DNMG	SNMG	TNMG	VNMG	WNMG
<b>Positive</b> 0.1 ~ 1.0 ~ 4.0 Medium to finishing	AK		0.03 ~ 0.20 ~ 0.40	H01 ND1000 PD1000	1000 1000 1000	CCGT	DCGT	SCGT	TCGT	VB(C)GT	RCGT
0.5 ~ 1.5 ~ 4.0 Medium cutting	AR		0.05 ~ 0.30 ~ 0.50	H01 ND1000 PD1000	1000 1000 1000	CCGT	DCGT	SCGT	TCGT	VB(C)GT	RCGT

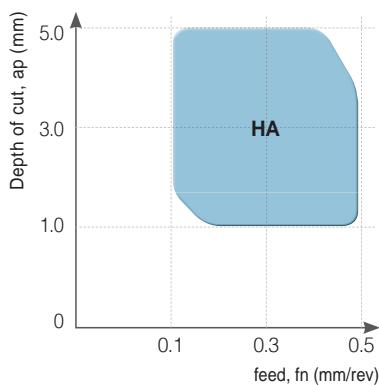
Materials: Copper, Bronze alloy

Hardness: 20~110HB

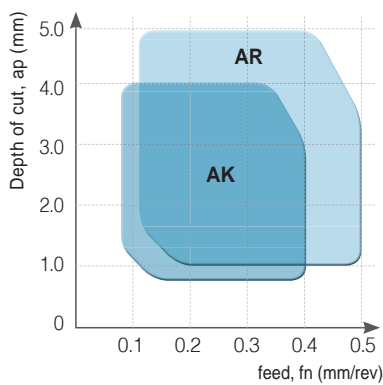
Depth of cut (mm)	C/B	Cutting edge	Feed (mm/rev)	Grades	Cutting Speed (m/min)	Insert shape					
						80°	55°	90°	60°	35°	80°
<b>Negative</b> 0.5 ~ 2.0 ~ 4.0 Medium to finishing	HA		0.10 ~ 0.20 ~ 0.50	H01	1000	CNMG	DNMG	SNMG	TNMG	VNMG	WNMG
<b>Positive</b> 0.1 ~ 1.0 ~ 3.0 Medium to finishing	AK		0.03 ~ 0.20 ~ 0.30	H01	1000	CCGT	DCGT	SCGT	TCGT	VB(C)GT	RCGT
0.5 ~ 1.5 ~ 3.0 Medium cutting	AR		0.05 ~ 0.25 ~ 0.40	H01	1000	CCGT	DCGT	SCGT	TCGT	VB(C)GT	RCGT

•: The first recommended cutting condition

### N Negative



### N Positive



Workpiece  
**S**  
Heat resistant alloy

## Recommended chip breaker for workpiece

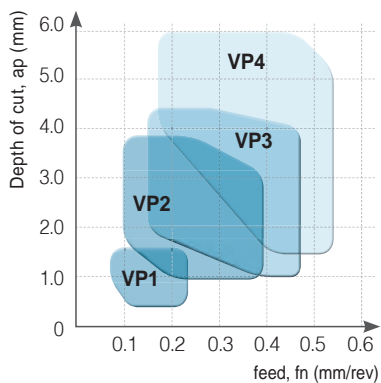
Materials: Inconel, Nimonic, Stellite, Ti alloy

Hardness: 160~350HB

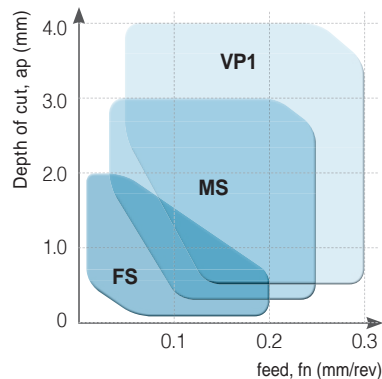
Depth of cut (mm)	C/B	Cutting edge	Feed (mm/rev)	Grades	Cutting Speed (m/min)	Insert shape					
						80°	55°	90°	60°	35°	80°
<b>Negative</b>	0.1 ~ 0.5 ~ 1.5 Finishing	VP1	0.05 ~ 0.10 ~ 0.20	PC8110 PC5300 NC5330	60 50 50	CNMG p. B40	DNGG p. B47				
	0.5 ~ 1.5 ~ 4.0 Medium to finishing	VP2	0.10 ~ 0.20 ~ 0.40	PC8110 PC5300	60 45	CNMG p. B41	DNMG p. B47	SNMG p. B55	TNMG p. B63		WNMG p. B71
	0.05 ~ 2.0 ~ 3.0 Medium cutting	VP3	0.05 ~ 0.15 ~ 0.25	PC8110 PC5300	60 40	CNMG p. B41	DNMG p. B47	SNMG p. B55	TNMG p. B63	VNMG p. B67	WNMG p. B71
	1.0 ~ 2.5 ~ 4.0 Roughing	VP4	0.15 ~ 0.20 ~ 0.35	PC8115	60 40	CNMG p. B41	DNMG p. B48	SNMG p. B55	TNMG p. B63		WNMG p. B71
<b>Positive</b>	0.5 ~ 2.0 ~ 4.0 Medium cutting	VP1	0.05 ~ 0.23 ~ 0.30	PC8110 PC5300	60 45	CCGT p. B74	DCGT p. B81			VCGT p. B98	
	0.2 ~ 1.0 ~ 2.5 Medium cutting	MS	0.03 ~ 0.10 ~ 0.25	PC8110 PC5300	60 45	CCGT p. B74	DCGT p. B80			VCGT p. B98	
	0.1 ~ 0.8 ~ 1.5 Finishing	FS	0.01 ~ 0.08 ~ 0.20	PC8110 PC5300	60 45	CCGT p. B74	DCGT p. B80		TCGT p. B89	VCGT p. B98	

●: The first recommended cutting condition

### **S** Negative



### **S** Positive



## Features of Chip Breaker

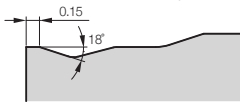
### CP Chip Breaker new [ For medium to finishing ]

- Chip breaker with strong cutting edge for heavy interruption in the range of medium to finishing
- Effective chip control in the range from low depth of cut to high depth of cut due to 2-stepped back angle
- Stable chip evacuation and breaking long chip in deep cutting by side rake angle and continuous bumps

#### Features of CP chip breaker

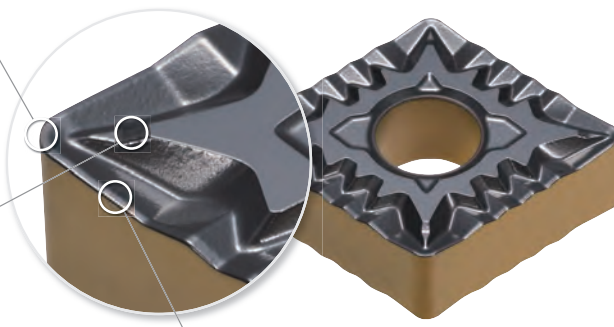
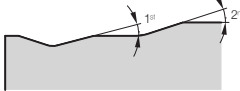
##### ► Flat land

- Strong cutting edge in interrupted roughing
- Keeping the balance between continuous cutting and interrupted cutting
- Expanded versatility



##### ► 2-stepped back side

- Better chip control in low depth of cut machining
- Improved chip evacuation in high feed machining
- Expanded versatility by 2-stepped rake angle



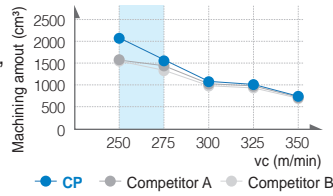
##### ► Side rake angle + continuous bumps

- Enhanced surface finish
- Improved chip evacuation
- Breaking long chips

#### Performance evaluation

##### V-T (Vc-Tool life)

- **Workpiece** Alloy steel (SCM440), External machining
- **Cutting condition** vc (m/min) = 250, 300, 350, fn (mm/rev) = 0.3, ap (mm) = 0.5, wet
- **Tools** Insert : CNMG120408-RM (NC9115)  
Holder : PCLNL2525-M12



CP



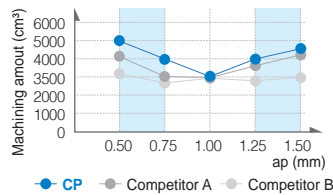
Competitor A



Competitor B

##### D-T (Depth of cut-Tool life)

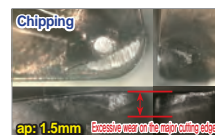
- **Workpiece** Alloy steel (SCM440), External machining
- **Cutting condition** vc (m/min) = 250, fn (mm/rev) = 0.2, ap (mm) = 0.50, 0.75, 1.00, 1.25, 1.50, wet
- **Tools** Insert : CNMG120408-CP (NC3215P)  
Holder : PCLNL2525-M12



CP

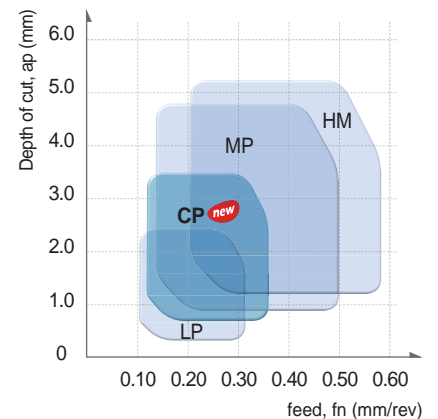


Competitor A



Competitor B

#### Application range





## Features of Chip Breaker

### FP Chip Breaker new [ For chip control in finishing ]

- Chip breaker applied on one side of insert controls chip in mild steel machining with low depth of cut
- Chip control in poor machining (with lower depth of cut than nose R, in machining minor cutting edge and in back cutting)
- Decreased cutting load and excellent surface finish due to 3-dimensional cutting edge and side rake angle

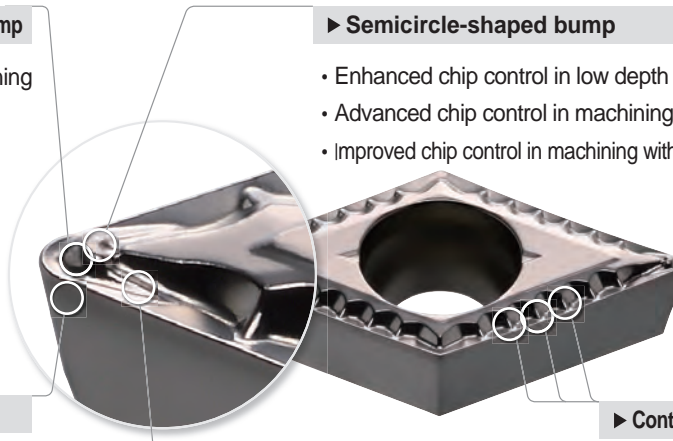
#### Features of FP chip breaker

##### ► Concave form of semicircle-shaped bump

- Better chip curling in mild steel machining
- Enhanced chip control in low depth of cut and low feed machining

##### ► Semicircle-shaped bump

- Enhanced chip control in low depth of cut machining
- Advanced chip control in machining of minor cutting edge
- Improved chip control in machining with lower depth of cut than nose R



##### ► 3-dimensional side rake angle

- Ensuring surface finish and guiding chip to right direction

##### ► Assistant bump on flank surface

- Better chip curling in high depth of cut and low feed machining
- Preventing chip twist

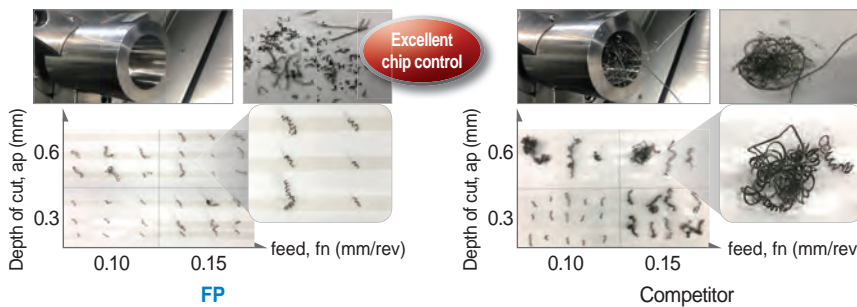
##### ► Continuous bump on flank surface

- Cutting long chip

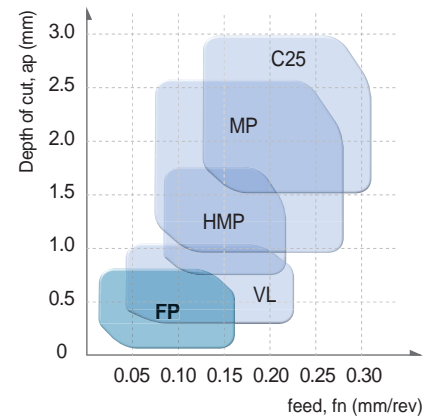
#### Performance evaluation

##### Chip control

- **Workpiece** Mild steel (SM20C), Ø40 Internal machining
- **Cutting condition**  $vc$  (m/min) = 200,  $n$  (rpm) = 1,600,  $fn$  (mm/rev) = 0.03,  $ap$  (mm) = 0.5, wet
- **Tools** Insert : CCMT09T304-FP (NC3215)  
Holder : S16M-SCLCR-M09

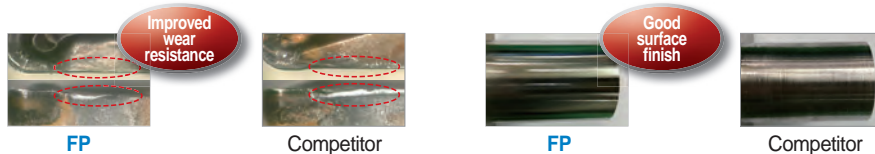


#### Application range



##### Surface finish

- **Workpiece** Mild steel (SM20C), Ø30 External machining
- **Cutting condition**  $vc$  (m/min) = 200,  $n$  (rpm) = 2,000,  $fn$  (mm/rev) = 0.08,  $ap$  (mm) = 0.8, wet
- **Tools** Insert : CCMT09T304-FP (NC3215)  
Holder : SCLCR1616-M09





## Features of Chip Breaker

### FS Chip Breaker new [ For finishing ]

- Chip breaker for ultra-precision automatic Swiss lathe machining (for lower depth of cut and lower feed cutting range than VP1 and MS)
- Available for various workpieces, P, M and S
- Reduced cutting load and good surface finish due to sharp cutting edge

#### Features of FS chip breaker

##### ▶ Variable elevated triangular pyramid shape

- Applicable for various cutting range due to optimally designed chip breaker
- Enhanced chip evacuation function per variation of cutting depth
- Enhanced chip control with low depth of cut
- Lowered cutting load in high feed machining

##### ▶ Side high rake angle

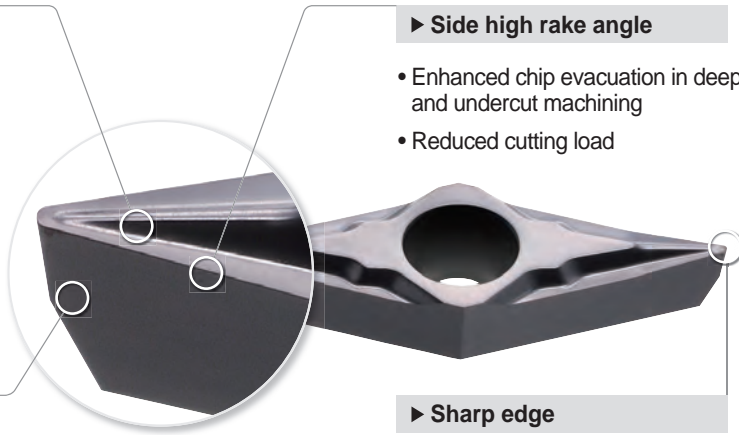
- Enhanced chip evacuation in deep grooving and undercut machining
- Reduced cutting load

##### ▶ Side grinding

- Periphery grinding G class
- High precision grinding

##### ▶ Sharp edge

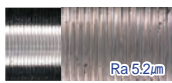
- Reduced cutting resistance
- Improved chip control



#### Performance evaluation

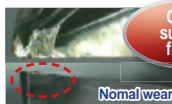
##### Workpiece size and surface finish

- **Workpiece** Stainless steel (STS406)
- **Cutting condition**  $vc$  (m/min) = 80,  $n$  (rpm) = 1,000,  $fn$  (mm/rev) = 0.05,  $ap$  (mm) = 0.1, wet
- **Tools** **Insert** : VCGT110301-FS (PC8110)  
**Holder** : SVJCR1212-X11A



Ra 5.2µm

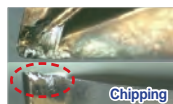
Good surface finish



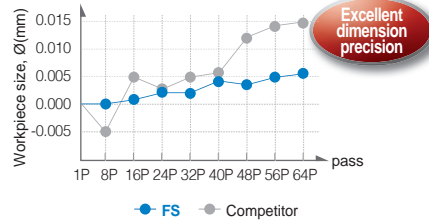
FS



Ra 7.8µm

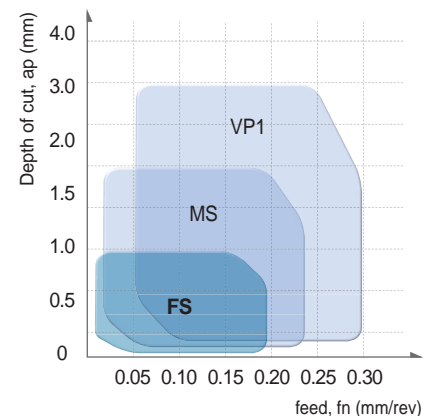


Competitor



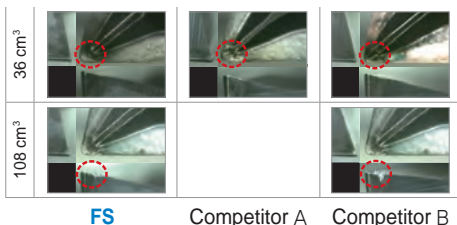
Excellent dimension precision

#### Application range



##### Wear resistance

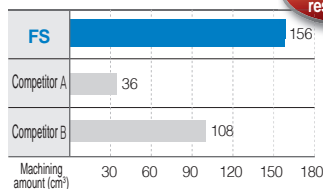
- **Workpiece** Alloy steel (SCM440)
- **Cutting condition**  $vc$  (m/min) = 100,  $n$  (rpm) = 1,000,  $fn$  (mm/rev) = 0.05,  $ap$  (mm) = 0.5, wet
- **Tools** **Insert** : CCGT09T304-FS (PC8110)  
**Holder** : SCLCR1212-X09A



FS

Competitor A

Competitor B



Improved wear resistance



## Features of Chip Breaker

### MS Chip Breaker new

[ For medium to finishing ]

- Sharp cutting edge with welding resistance reducing the cutting heat is necessary for machining hard-to-cut materials
- Chip evacuation is increased in low to high feed cutting conditions

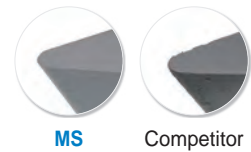
#### Features of MS chip breaker

##### ▶ Sharp cutting edge

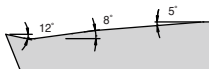
- Decreased cutting heat
- Minimized welding

##### ▶ Flank surface grinding

- G grade of periphery grinding
- Precise grinding



##### ▶ 2-level angle back area

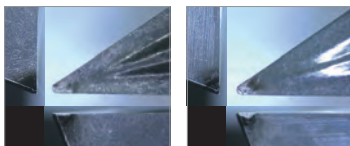


- Improved chip curl and chip control in low feed cutting range
- Better chip evacuation in high feed cutting range
- Reduced cutting resistance
- Protected cutting edge without chip blockage

#### Performance evaluation

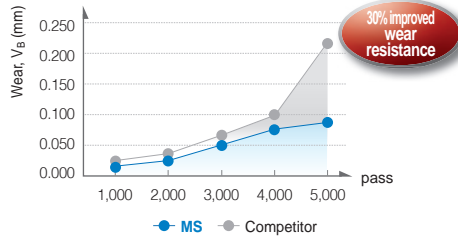
##### Wear resistance

- **Workpiece** Pure titanium (Grade4)
- **Cutting condition**  $vc$  (m/min) = 100,  $n$  (rpm) = 3,500,  $fn$  (mm/rev) = 0.03,  $ap$  (mm) = 0.5, wet
- **Tools** Insert : VCGT1203008FN-MS (PC8110)  
Holder : SVJCR1212-X12A



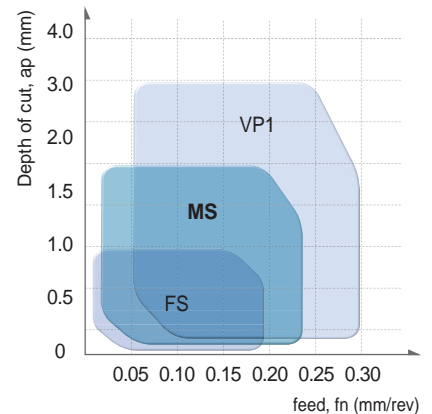
MS

Competitor

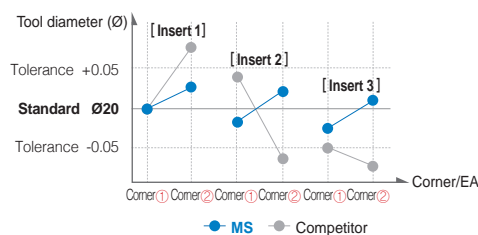
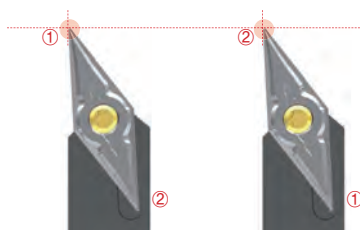


- ▶ Ultra-fine substrate and high hardness coating ensure stable tool life.

#### Application range



##### Dimension precision



- ▶ Changing tool offset in switching insert corners and items is not necessary using MS chip breaker due to tight dimension deviation management.

# B Turning Chip Breakers

## Features of Chip Breaker

### LP Chip Breaker new [ For medium to finishing ]

- Chip breaker for forged steel of automobile parts and normal steel
- Quad dots improve productivity through efficient chip control at high feed
- Angle land minimizes cutting force

#### Features of LP chip breaker

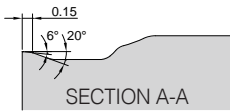
##### ▶ Front dot

- Higher stability of chip curls at high feed
- Excellent chip control when copying
- Lower cutting force at low depth of cut and high feed

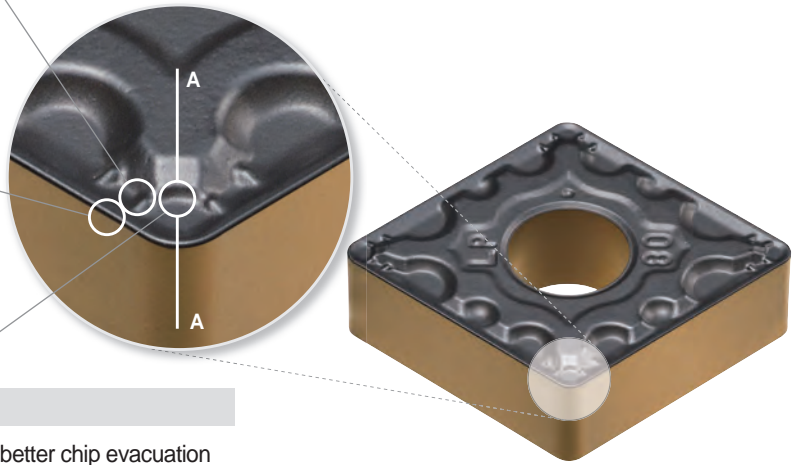
##### ▶ Variable land

- Less crater wear
- Prevents chipping on minor cutting edge

##### ▶ Flat zone



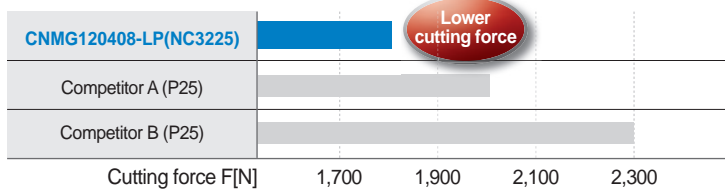
- Larger chip pocket for better chip evacuation at high feed
- Reduced cutting force with larger contact surface of chips



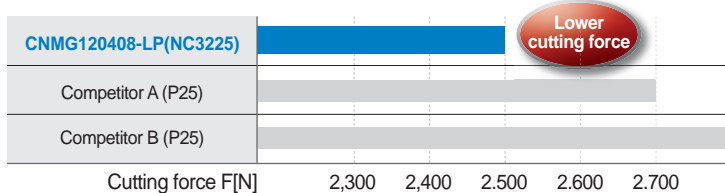
#### Performance evaluation (Evaluation of cutting force)

- **Workpiece** SM45C, Ø100, External machining
- **Cutting condition** vc (m/min) = 250, ap (mm) = 1.0, fn (mm/rev) = 0.25/0.40, wet
- **Tools** CNMG120408-□□

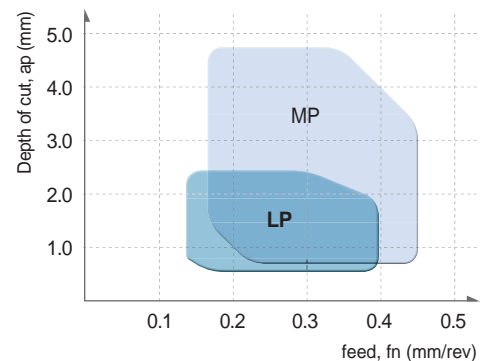
##### Medium feed (0.25 mm/rev)



##### High feed (0.40 mm/rev)



#### Application range



## Features of Chip Breaker

### MP Chip Breaker new [ For medium cutting ]

- Chip breaker for forged steel of automobile parts and all other steels
- Quad dots improve productivity through efficient chip control at high feed
- Angle land minimizes cutting force

#### Features of MP chip breaker

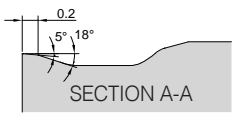
##### ▶ Front two step dot

- Higher stability of chip curls at high feed
- Excellent chip control when copying
- Lower cutting force at high depth of cut

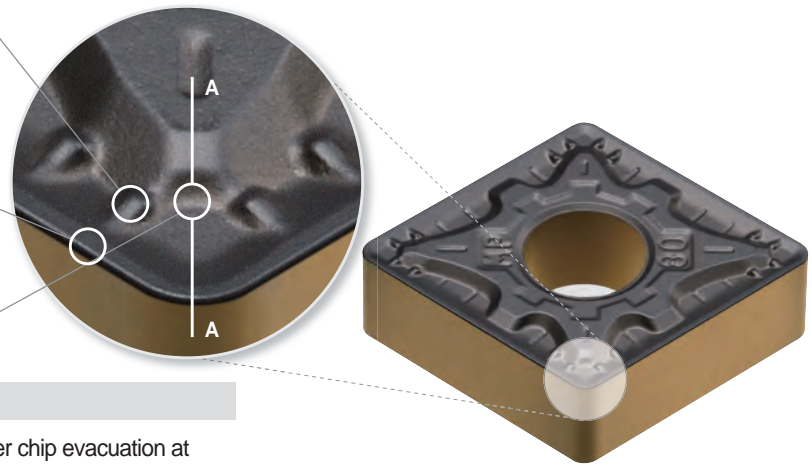
##### ▶ Variable land

- Less crater wear
- Prevents chipping on minor cutting edge
- Higher toughness at high depth of cut and interrupted cutting

##### ▶ Flat zone



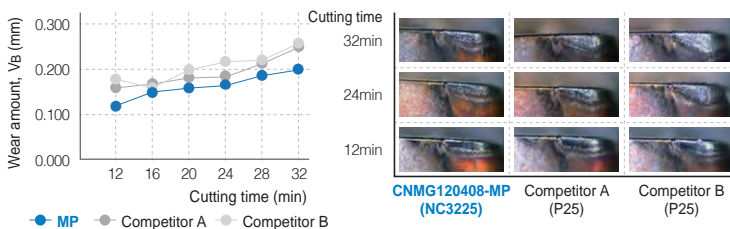
- Larger chip pocket for better chip evacuation at high feed
- Reduced cutting force with larger contact surface of chips



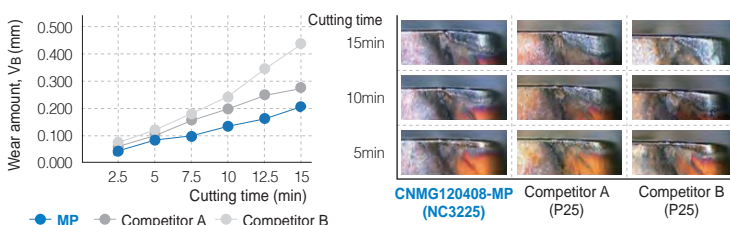
#### Performance evaluation

- **Workpiece** Alloy steel (SCM440), Ø100, External machining
- **Cutting condition**  $vc$  (m/min) = 280,  $ap$  (mm) = 1.5,  $fn$  (mm/rev) = 0.25/0.40, wet
- **Tools** CNMG120408-□□

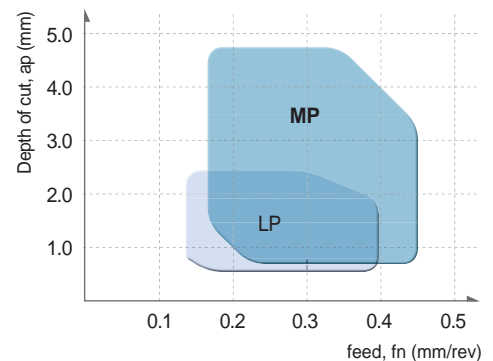
##### Medium feed (0.25 mm/rev)



##### High feed (0.40 mm/rev)



#### Application range



## Features of Chip Breaker

### MM Chip Breaker new [ For medium cutting ]

- The 1<sup>st</sup> recommended chip breaker for stainless steel machining
- Change to: A dual land achieves sharp cutting performance and insert toughness
- Wide chip pockets for stable chip evacuation at high feeds/depths of cut

#### Features of MM chip breaker

##### ▶ Variable Land

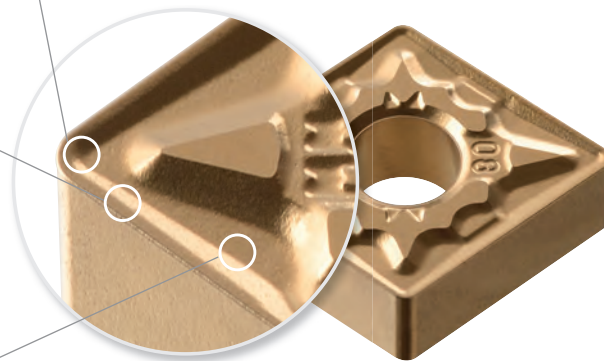
- Excellent chip control and sharp cutting at low depths of cut
- Delays crater wear
- Prevents plastic deformation

##### ▶ Dual Land

- Balance between requirements of sharp and tough cutting edges
- Sharp cutting edge for high speed machining
- Prevents chipping in interrupted machining

##### ▶ Wide Chip Pocket

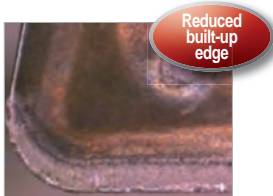
- Stable chip evacuation at high speeds/feeds
- Improved surface finishes by reduced workpiece scratches caused by work-hardened chips at high depths of cut
- Prevents built-up edge



#### Performance evaluation

##### Built-up edge

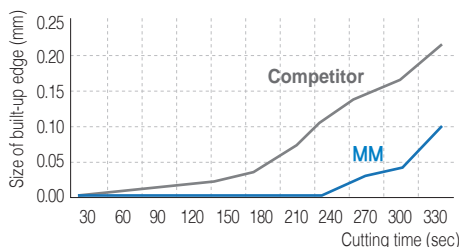
- **Workpiece** STS405 (Ferrite)
- **Cutting condition**  $vc$  (m/min) = 180,  $fn$  (mm/rev) = 0.3,  $ap$  (mm) = 3.0, wet
- **Tools** **Insert** : CNMG120408-MM (NC9125)  
**Holder**: PCLNL2525-M12



MM(NC9125)

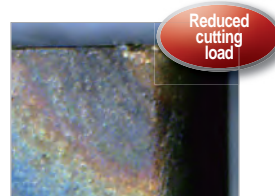


Competitor

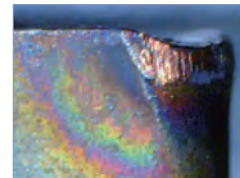


##### Plastic deformation

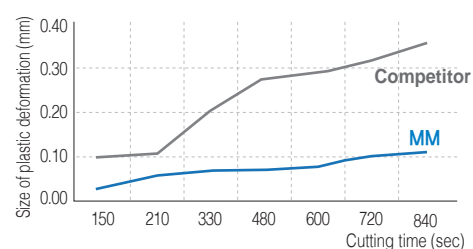
- **Workpiece** STS316 (Austenite)
- **Cutting condition**  $vc$  (m/min) = 200,  $fn$  (mm/rev) = 0.35,  $ap$  (mm) = 2.0, dry
- **Tools** **Insert** : CNMG120408-MM (NC9135)  
**Holder**: PCLNL2525-M12



MM(NC9135)



Competitor





## Features of Chip Breaker

### RM Chip Breaker new [ For roughing]

- The 1<sup>st</sup> recommended chip breaker for rough and interrupted machining of stainless steel
- Prevents notch wear and burrs at high feeds and depths of cut
- Reduced cutting force extends tool life in high feed machining

#### Features of RM chip breaker

##### ► Variable Land

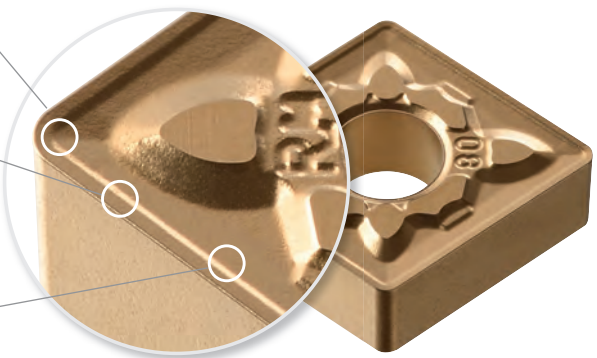
- Excellent chip control and sharp cutting at low depths of cut
- Delays crater wear
- Prevents plastic deformation

##### ► Wide land & Gentle front angle

- Sharp cutting edges and a wide land reduce cutting force
- Reduced burrs
- Dispersed cutting load enables higher toughness

##### ► Stepped Design

- Stepped design makes chip evacuation easier
- Smooth chip evacuation prevents plastic deformation



#### Performance evaluation

##### Notch wear

- **Workpiece** STS410 (Martensite)
- **Cutting condition**  $vc$  (m/min) = 150,  $fn$  (mm/rev) = 0.25,  $ap$  (mm) = 3.0, wet
- **Tools** Insert : CNMG120408-RM (NC9115)  
Holder: PCLNL2525-M12

##### Burr

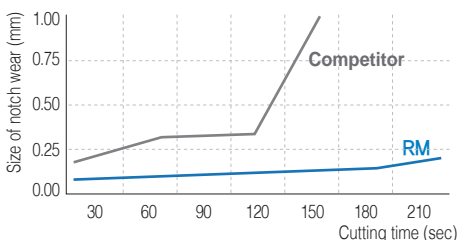
- **Workpiece** Duplex
- **Cutting condition**  $vc$  (m/min) = 120,  $fn$  (mm/rev) = 0.2,  $ap$  (mm) = 2.0, dry
- **Tools** Insert : CNMG120408-RM (NC9125)  
Holder: PCLNL2525-M12



RM (NC9115)



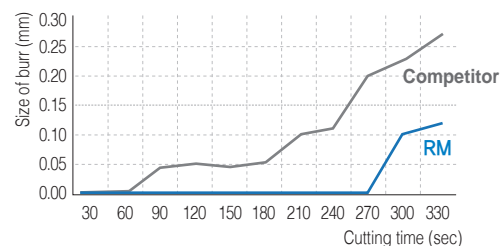
Competitor



RM (NC9125)



Competitor





# B Turning Chip Breakers

## Features of Chip Breaker

### MK Chip Breaker new [ For medium cutting ]

- Ideally suited for continuous cutting of ductile cast iron and gray cast iron
- Angle lands provide upgraded surface finish

#### Features of MK chip breaker

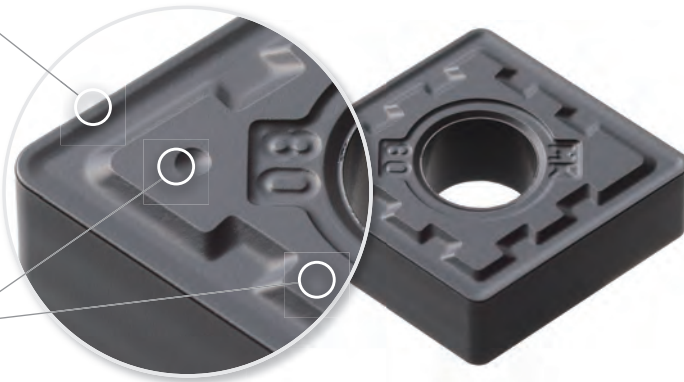
##### ▶ Angle land

- Angle lands provide sharper cutting performance
- Maximized wear resistance in continuous cutting
- High quality results in surface finish



##### ▶ Wide supporting area

- Higher clamping stability
- Prevents chipping at vibrations during operation



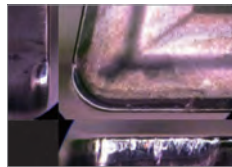
#### Performance evaluation

##### Wear resistance

- **Workpiece** GCD500(KS), Ø90 (Spherical tube) → Ø30 machining
- **Cutting conditions**  $vc$  (m/min) = 400,  $fn$  (mm/rev) = 0.35,  $ap$  (mm) = 2.5, wet
- **Cutting time** 30 passes with results of normal wear on rake/flank surface
- **Tools** Insert : CNMG120408-MK (NC6315)  
Holder: DCLNR2525-M12



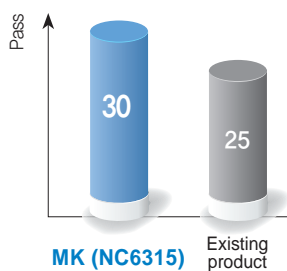
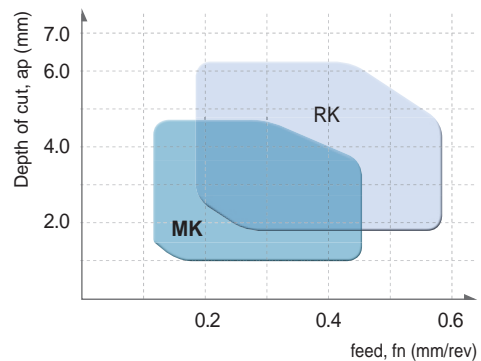
MK (NC6315)



Existing product

130% increased flank wear resistance

#### Application range



## Features of Chip Breaker

### RK Chip Breaker **new** [ For roughing ]

- Ideally suited for high speed / high feed cutting of ductile cast iron and gray cast iron
- Flat lands provide upgraded toughness and chipping resistance

#### Features of RK chip breaker

##### ► Flat land

- Flat lands provide upgraded toughness and chipping resistance
- Stable machining availability under high cutting loads at high depth of cuts or interrupted cutting
- Optimized land width for high feed machining



##### ► Wide supporting area

- Higher clamping stability
- Minimizes vibration and chipping.

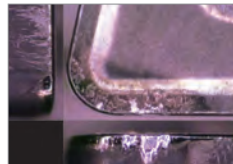
#### Performance evaluation

##### Impact resistance

- **Workpiece** GCD500 (KS), Ø90 (Triangular tube) → Ø30 machining
- **Cutting conditions**  $vc$  (m/min) = 380,  $fn$  (mm/rev) = 0.35,  $ap$  (mm) = 2, wet
- **Cutting time** 15 passes with results of normal rake surface wear and good chipping resistance
- **Tools** **Insert** : CNMG120408-RK (NC6315)  
**Holder**: DCLNR2525-M12



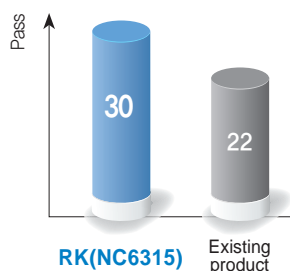
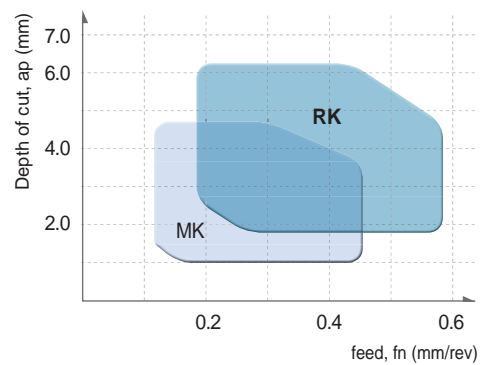
RK(NC6315)



Existing product

125% increased chipping resistance

#### Application range



## Features of Chip Breaker

### VP1 Chip Breaker [ For finishing ]

- Cutting edges designed in high-positive
  - Reduced contact area between rake surface and chip minimizes cutting heat and improved tool life
- Recommended cutting conditions:  $f_n$  (mm/rev) = 0.05~0.2,  $a_p$  (mm) = 0.1~1.5

#### Features of VP1 chip breaker

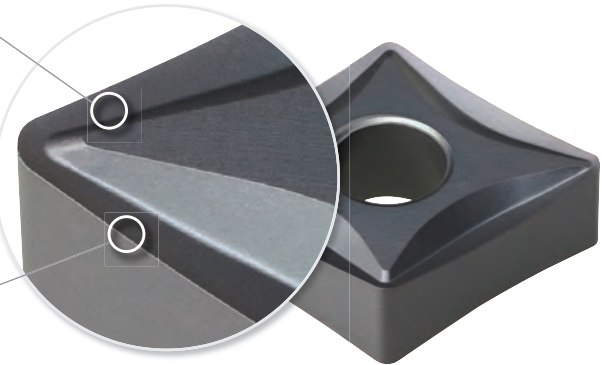
##### ► Optimized design for finishing

- Obtains excellent cutting performance and quality surface finish at low depth of cut and high speed



##### ► High-positive blade design

- Minimizes cutting heat by reducing the contact area between flank surface and chips
- Prevents built-up edge and extends tool life



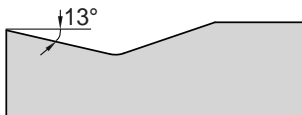
### VP2 Chip Breaker [ For medium to finishing ]

- High-positive cutting edge design/Side rake angle applied
  - Stable chip control improves machinability when ball machining at variable depths of cut
- Recommended cutting conditions:  $f_n$  (mm/rev) = 0.1~0.4,  $a_p$  (mm) = 0.5~4.5

#### Features of VP2 chip breaker

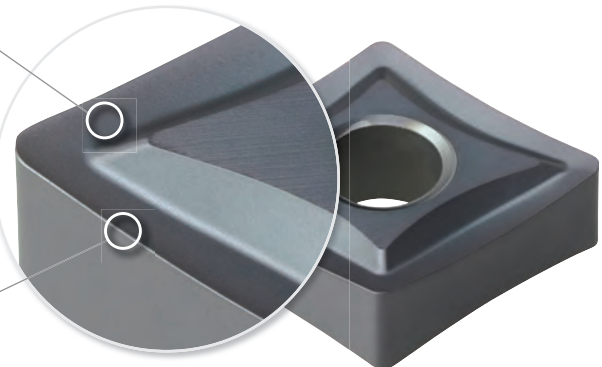
##### ► Sharp blades and wide chip pockets

- Increase productivity
- Ideal for medium to finish cutting



##### ► High-positive blade design

- Improves cutting performance with its stable chip control at varying depth of cuts



## Features of Chip Breaker

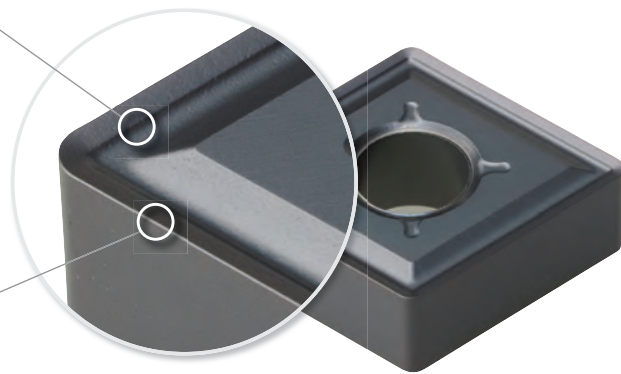
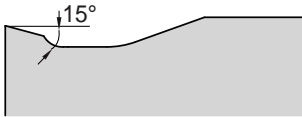
### VP3 Chip Breaker [ For medium cutting ]

- High-positive cutting edge design/Wide land applied
  - Improved stability at interrupted cutting when toughness is required. Stable chip control and machinability at high depth of cut
- Recommended cutting conditions:  $f_n$  (mm/rev) = 0.1~0.45,  $a_p$  (mm) = 0.5~5.0

#### Features of VP3 chip breaker

##### ► Chip pocket design leading to a R-shaped cutting edge

- Creates a stepped space between edge and land to make smooth chip flow at low and high depth of cuts



##### ► High-positive blade design / Wide land

- Minimize heat concentration at high depth of cut
- Improves stability in interrupted machining of a tough workpiece

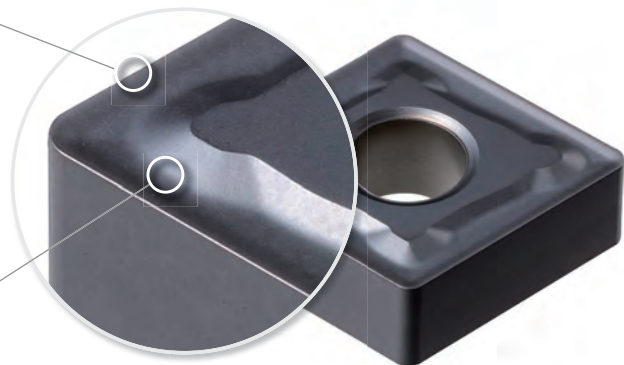
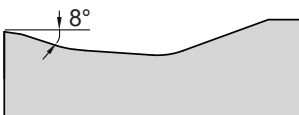
### VP4 Chip Breaker **new** [ For roughing ]

- The 1st recommended chip breakers for machining Inconel which remains highly resistant to and hard at high temperature
- Rough machining stability resulting from reinforced cutting edges and wide chip pockets

#### Features of VP4 chip breaker

##### ► Rake angle design resistant to high hardness cutting

- Reinforces cutting edges and prevents notch wear in rough surface machining
- Prevents chipping in interrupted cutting



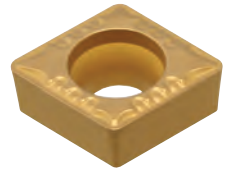
##### ► Wide chip pockets

- Reduce cutting loads and improve stability even at high depth of cut in roughing

## Features of Chip Breaker

### Single-sided VL Chip Breaker

[ For finishing ]



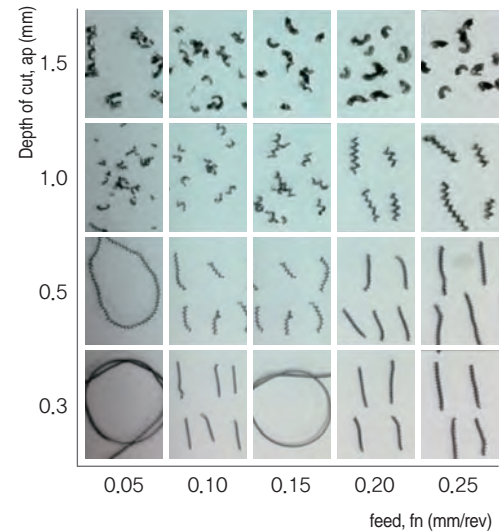
- The sharp flank surface and the chip breaker design significantly improve chip control when machining tough materials such as low carbon steel, pipe steel, and iron plates
- Sharp cutting edges reduce cutting resistance and provide excellent chip control at low depth of cuts, leading to stable machining on automated production lines

#### Features of VL chip breaker

- **Sharp cutting edges**
  - High rake cutting edges provide improved surface finishes
  - Low cutting resistance reduces cutting heat
- **2-step rear rake angle**
  - Stable chip control regardless of varying feed rates
  - Excellent machinability even when machining mild workpieces

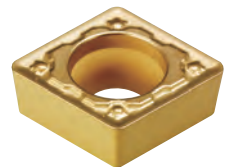
#### Chip control test

- **Workpiece** SCM440(Alloy steel), Ø50, Internal diameter turning
- **Cutting condition**  $vc = 250$  m/min,  $ap = 0.3\text{--}1.5$  mm,  $fn = 0.05\text{--}0.25$  mm/rev
- **Tools** CCMT09T304-VL



### Single-sided MP Chip Breaker

[ For medium to finishing ]



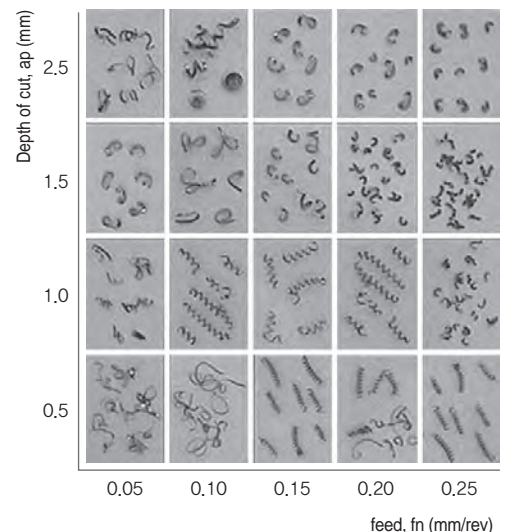
- For continuous cutting of forged steel at high feed
- Turning insert for internal machining of automobile components

#### Features of MP chip breaker

- **Three-dimensional 2 step chip breaker**
  - Stable chip control in unstable internal machining
  - Prevents chip blocking at internal diameter at varying depth of cut and feed.
- **Stronger cutting edge and wide chip pocket**
  - Increased chipping resistance in unstable internal machining

#### Chip control test

- **Workpiece** SCM440
- **Cutting condition**  $vc = 200$  m/min,  $ap = 0.5\text{--}2.5$  mm,  $fn = 0.05\text{--}0.25$  mm/rev
- **Tools** CCMT09T304-MP





## Features of Chip Breaker

### VL Chip Breaker [ For finishing ]



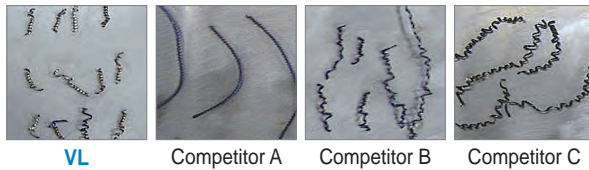
- Improved chip control for machining material that have high toughness such as low carbon steel, pipe, steel plate etc
- Improved chip control and decreased cutting load on external, facing, and copying applications
- Improved strength of the cutting edge for measurable efficiency in automated production

#### Features of VL chip breaker

- **2 steps designed chip-breaker** - Suitable Mild steel  
- Stable chip control on the low feed and cutting depth
- **Designed with special dots** - Stable chip breaking on the low cutting depth
- **Applied side rake angle** - Improved chip control on facing, copying applications  
- Decreased cutting load and better surface finish

#### Chip control test

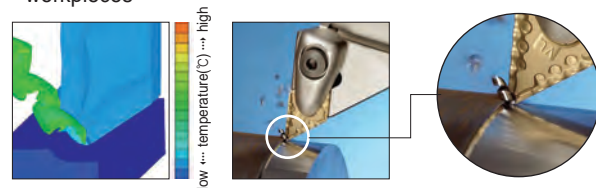
- **Workpiece** SM20C
- **Cutting conditions**  $vc = 250$  m/min,  $ap = 0.5$  mm  
 $fn = 0.2$  mm/rev (Side), dry
- **Tools** DNMG150408-VL



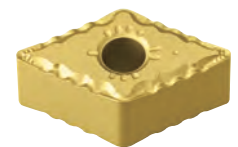
VL Chip Breakers

#### FEM Cutting simulation analysis in the design

- For design of geometry, chip shapes and chip flow are predictable
- Optimal chip breaker design by various cutting conditions and workpieces



### VB Chip Breaker [ For finishing ]



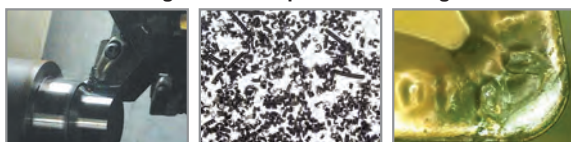
- Excellent chip evacuation in continuous and high speed machining of various workpieces
- 3-dimensional chip breaker achieves lower cutting resistance, high rigidity of the cutting edge, and longer tool life
- Stable chip control in copying and internal machining

#### Features of VB chip breaker

- **6 bumps on the insert corner** - Superior chip control and chip cutting in copying with various depths of cut
- **Side rake angle** - Superb chip cutting in facing and copying. Superior tool life due to improved surface roughness and lower cutting resistance
- **Cutting edge on 100° part for medium machining (For CNMG)** - Excellent chip evacuation and toughness in machining with high depth of cut

#### Performance

Better machining   Better Chip control   Longer tool life



VB Chip Breakers



Conventional chip breaker



# B Turning Chip Breakers

## Features of Chip Breaker

### VC Chip Breaker [ For medium to finishing ]

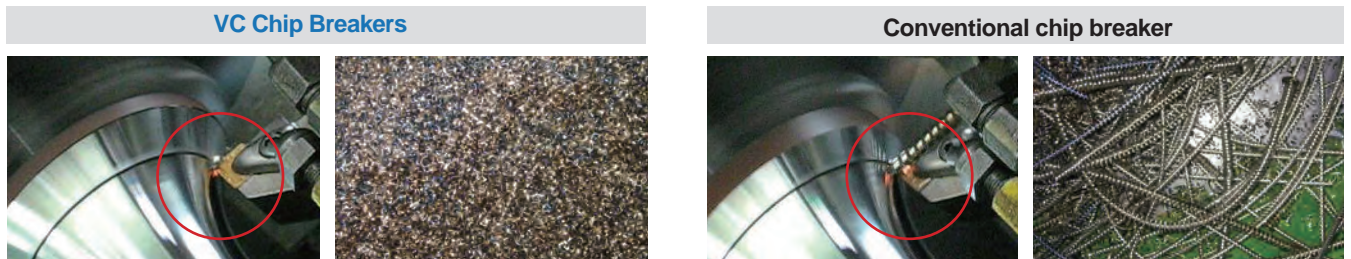
- Superior chip evacuation in high speed and continuous machining of various workpieces (carbon steel, alloy steel etc)
- KORLOY 3 dimensional chip breaker ensures longer tool life due to low cutting load and improved cutting edge strength
- Stable chip control in copying and internal machining



#### Features of VC chip breaker

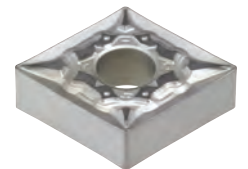
- 4 bumps on the insert corner
  - Excellent chip control in various depths of cut and superb chip cutting in external, internal, copy machining and facing

#### Evaluation of chip control (Copying)



### VQ Chip Breaker [ For medium to finishing\_For cermet ]

- Excellent cutting performance and reinforced cutting edges
- Improved chip control at low depth of cuts

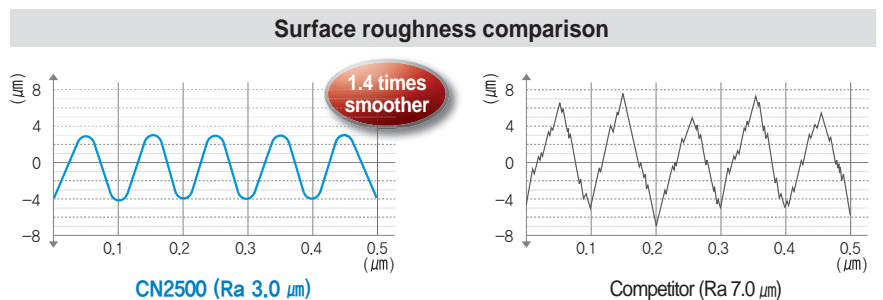
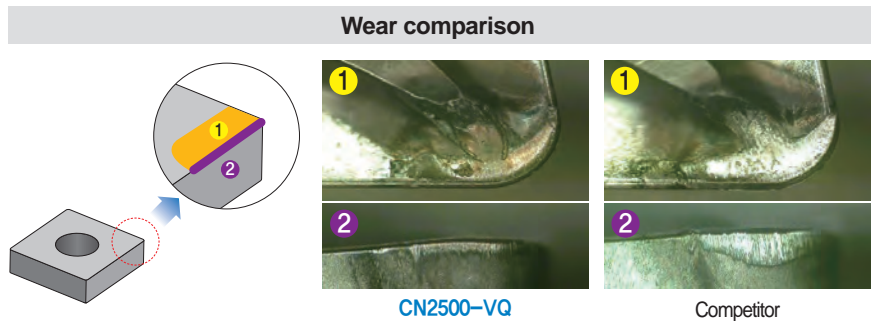


#### Features of VQ chip breaker

- Three dimensional rake angle
  - Improved surface finish thanks to sharp cutting performance
  - Less cutting heat and longer tool life thanks to low cutting resistance
- Beveled protruding structure
  - Smooth chip flow at low depth of cuts
  - Wide application range

#### Performance evaluation

- **Workpiece** SCM440(Alloy steel), Ø100, External diameter turning
- **Cutting condition**  $vc = 280$  m/min,  $ap = 1.5$  mm,  $fn = 0.25$  mm/rev
- **Tools** CNMG120408-VQ (CN2500)



## Features of Chip Breaker

### VH/VT Chip Breaker [ For heavy duty machining ]

- Heavy duty chip breaker suitable for Heavy machining in the ship building and power plant industries
- Suitable for large vertical machines when machining shafts, rollers, rotors and optimal for the big flange machining

#### Features of VH chip breaker

##### ► For good chip control in heavy machining (comprehensive type)



- Designed from the study of heavy cutting mechanism
- Smooth chip control from the high rake angle
- Wider cutting edge land provides stronger cutting
- Unique cutting edge treatment provides smooth cutting
- Optimized chip pocket design provides smooth chip flow

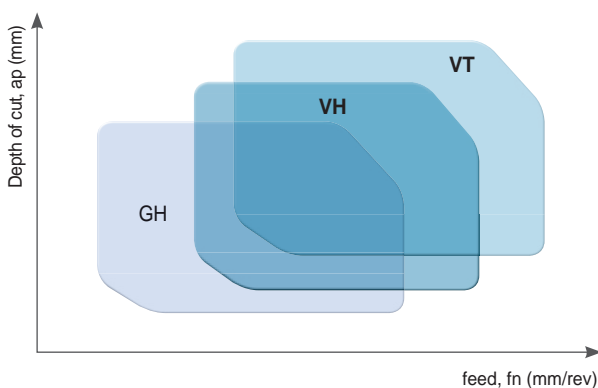
#### Features of VT chip breaker

##### ► For long tool life and stable cutting (higher feeds, big depth) in heavy machining



- Designed from the study of heavy cutting mechanism
- Strong edge design provides long and stable cutting (2 step rake angle of cutting edge)
- Varied cutting edge land strengthens the cutting edge
- The positioning of the chip breaking convex dot deflect the machining heat, optimizes inserts wear & absorb shock

#### Applications range of chip breakers



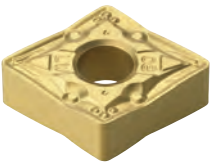
# B Turning Chip Breakers

## Features of Chip Breaker

### LW/VW Chip Breaker [ For high feed cutting ]

- Improved productivity with higher feed rates and surface finishes
- Improved wear resistance and toughness

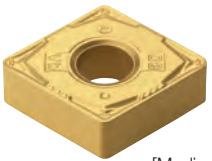
#### Features of LW chip breaker



[For medium cutting]

- **Curvilinear cutting edge** - Reduces cutting force
- **Cutting edge design able to handle deeper depth of cuts** - lower cutting load & reduces heat
- **Greater chip control at shallow depths of cuts** - Chip pocket design improves smooth chip flow
- **For shallow depth cutting and low speed machining** - 3D design at the corner

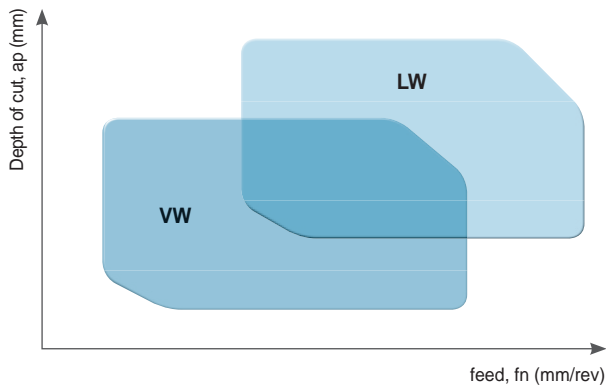
#### Features of VW chip breaker



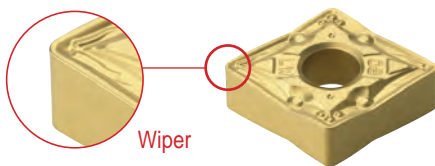
[Medium to finishing]

- **Excellent Finishing applications** - Excellent chip control
- **Insert design great for stable clamping** - Chip breaker designed close to the cutting edge
- **Similar cutting edge to C/B for medium** - strong cutting edge
- **3 Dimensional dot design on cutting corner**
  - reduces cutting force and good chip control at shallow depth of cut

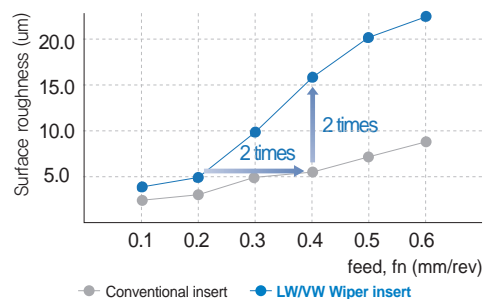
#### Applications range of chip breakers



#### Wiper Insert



- High productivity
- Improved surface roughness
- High feed-reducing machining time
- Improved tool life due to reduce cutting force

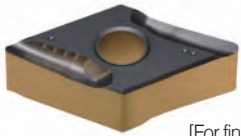


## Features of Chip Breaker

### SR/SH Chip Breaker new [ For machining a shaft ]

- Specialized for machining slender bars and thin walls
- High rake helix angle to reduce cutting resistance
- For machining steel and stainless steel

#### Features of SR chip breaker



[For finishing]

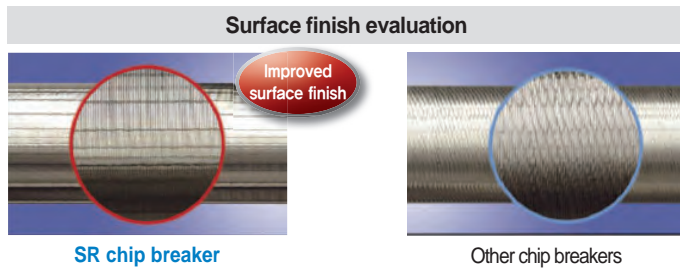
- The first recommended chip breaker for machining a shaft
- For continuous finishing
- Improved chip and heat evacuation due to high rake cutting edge and 3-dimensional shape
- Good surface finish
- Preventing fracture due to chamfering on the cutting edge

#### Features of SH chip breaker

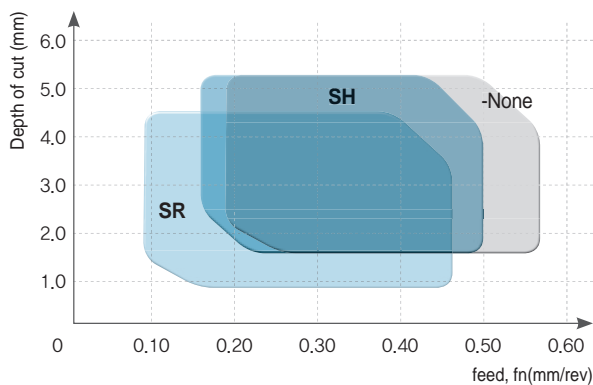


[For medium cutting]

- Specialized for interrupted and medium cutting
- Efficient heat evacuation due to concave shaped back side of insert



#### Applications range of chip breakers



Machining	C/B	$a_p$ (mm)	$f_n$ (mm/rev)
Medium to rough cutting	-None	1.5~5.0	0.20~0.55
Medium cutting	SH	1.5~5.0	0.15~0.50
<b>Finish cutting</b>	<b>SR</b>	<b>1.0~4.5</b>	<b>0.12~0.45</b>

# B Turning Insert Code System (ISO)



### 1 Insert Shape

**C** N M G 12 04 08 - MP

C D E K L  
R S T V W

### 2 Relief Angle

**C** N M G 12 04 08 - MP

B C D E  
F N P O

### 3 Tolerance

**C** N **M** G 12 04 08 - MP

d: Inscribed circle  
t: Thickness  
m: Refer to figure

Class	d	m	t
A	±0.025	±0.005	±0.025
C	±0.025	±0.013	±0.025
H	±0.013	±0.013	±0.025
E	±0.025	±0.025	±0.025
G	±0.025	±0.025	±0.13
J*	±0.05~±0.15	±0.005	±0.025
K*	±0.05~±0.15	±0.013	±0.025
L*	±0.05~±0.15	±0.025	±0.025
M*	±0.05~±0.15	±0.08~±0.20	±0.13
N*	±0.05~±0.15	±0.08~±0.18	±0.025
U*	±0.08~±0.25	±0.13~±0.38	±0.13

(mm)

\* Sides are based on unground insert

#### Tolerance on C, H, R, T, W Insert Shape (Exceptional case)

d	Tolerance on d		Tolerance on m	
	J, K, L, M, N	U	M, N	U
6.35	±0.05	±0.08	±0.08	±0.13
9.525	±0.05	±0.08	±0.08	±0.13
12.7	±0.08	±0.13	±0.13	±0.20
15.875	±0.10	±0.18	±0.15	±0.27
19.05	±0.10	±0.18	±0.15	±0.27
25.4	±0.13	±0.25	±0.18	±0.38

#### Tolerance on D Insert Shape (Exceptional case)

d	Tolerance on d	Tolerance on m
6.35	±0.05	±0.11
9.525	±0.05	±0.11
12.7	±0.08	±0.15
15.875	±0.10	±0.18
19.05	±0.10	±0.18

### 4 Cross Section Type

**C** N M **G** 12 04 08 - MP

A B C  
F G H  
J M N  
Q R T  
U W X





04

08

-

MP

6

7

8

Height of Cutting Edge

Nose "r"

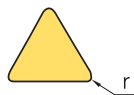
Chip Breaker for Turning

**5** Cutting Edge Length, Diameter of Incribed Circle  
C N M G 12 04 08 - MP

Symbol							Inch	IC d (mm)
C	d	S	T	R	V	W		
03	04	03	06	03	-	02	1.2 (5)	3.97
04	05	04	08	04	08	S3	1.5 (6)	4.76
05	06	05	09	05	09	03	1.8 (7)	5.56
-	-	-	-	06	-	-	-	6.00
06	07	06	11	06	11	04	2	6.35
08	09	07	13	07	13	05	2.5	7.94
-	-	-	-	08	-	-	-	8.00
09	11	09	16	09	16	06	3	9.525
-	-	-	-	10	-	-	-	10.00
11	13	11	19	11	19	07	3.5	11.11
-	-	-	-	12	-	-	-	12.00
12	15	12	22	12	22	08	4	12.70
14	17	14	24	14	24	09	4.5	14.29
16	19	15	27	15	27	10	5	15.875
-	-	-	-	16	-	-	-	16.00
17	21	17	30	17	30	11	5.5	17.46
19	23	19	33	19	33	13	6	19.05
-	-	-	-	20	-	-	-	20.00
22	27	22	38	22	38	15	7	22.225
-	-	-	-	25	-	-	-	25.00
25	31	25	44	25	44	17	8	25.40
32	38	31	54	31	54	21	10	31.75
-	-	-	-	32	-	-	-	32.00

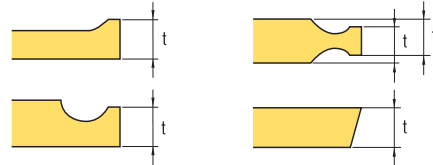
( ) Symbol for small size insert

**7** Nose "r"  
C N M G 12 04 08 - MP



Symbol		Nose "r"	
Metric	Inch	Metric	Inch
003	0.1	0.03	0.0012
005	0.13	0.05	0.002
01	0.2	0.1	0.004
02	0.5	0.2	0.008
04	1	0.4	1/64
08	2	0.8	1/32
12	3	1.2	3/64
16	4	1.6	1/16
20	5	2.0	5/64
24	6	2.4	3/32
28	7	2.8	7/64
32	8	3.2	1/8
00	-	Round insert (Inch)	
M0	-	Round insert (Metric)	

**6** Height of Cutting Edge  
C N M G 12 04 08 - MP

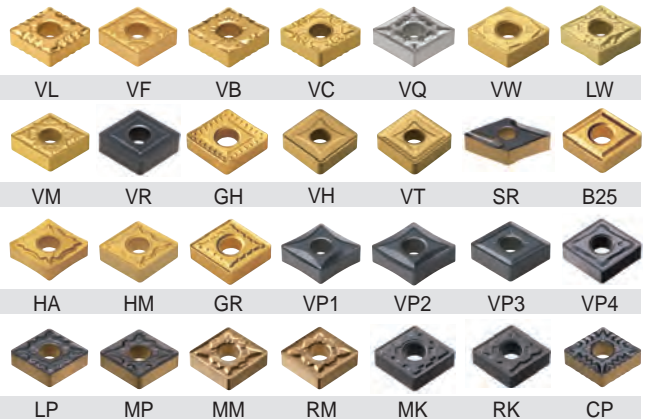


Symbol		Height of Cutting Edge (t)	
Metric	Inch	mm	Inch
01	1 (2)	1.59	1/16
T0	1.125	1.79	9/128
T1	1.2	1.98	5/64
02	1.5 (3)	2.38	3/32
T2	1.75	2.78	7/64
03	2	3.18	1/8
T3	2.5	3.97	5/32
04	3	4.76	3/16
05	3.5	5.56	7/32
06	4	6.35	1/4
07	5	7.94	5/16
09	6	9.52	3/8
11	7	11.11	7/16
12	8	12.70	1/2

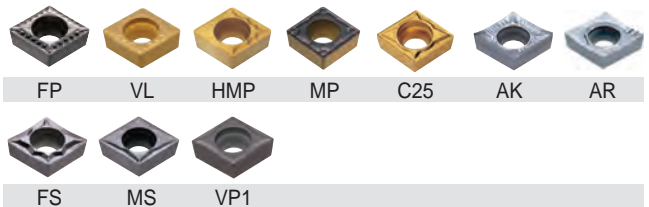
( ) Symbol for small size insert

**8** Chip Breaker for Turning  
C N M G 12 04 08 - MP

Negative Insert Chip Breaker



Positive Insert Chip Breaker



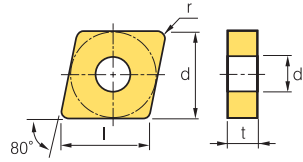




# B Turning Insert (Negative)





CN○○○

 Rhombic **80° Negative**



Dimensions (mm)			
Size	d	t	d <sub>1</sub>
09	9.525	3.18	3.81
12	12.7	4.76	5.16
16	15.875	6.35	6.35
19	19.05	6.35	7.93
25	25.4	9.52	9.12

Workpiece	Machining types											
	P	M	K	N	S	H						
Steel	●	●	●	●	●	●	●	●	●	●	●	●
Stainless steel	●	●	●	●	●	●	●	●	●	●	●	●
Cast iron	●	●	●	●	●	●	●	●	●	●	●	●
Non-ferrous metal	●	●	●	●	●	●	●	●	●	●	●	●
Heat resistant alloy, Titanium alloy	●	●	●	●	●	●	●	●	●	●	●	●
Hardened steel	●	●	●	●	●	●	●	●	●	●	●	●

Inserts	Designation	Cermet		Coated										Uncoated		Cutting Condition											
		CN1500	CN2500	CC1500	CC2500	NC3215	NC3225	NC3120	NC3030	NC3235	NC5330	NC6310	NC6315	NC9115	NC9125	NC9135	PC5300	PC5400	PC8105	PC8110	PC8115	PC9030	H01	H05	f <sub>n</sub> (mm/rev)	a <sub>p</sub> (mm)	
Medium to roughing 	CNMG 120404-B25	●	●			●	●	●	●	●	●	●	●	●	●	●	●	●	●	●	●	●			0.17-0.45	1.00-5.00	
	120408-B25	●	●			●	●	●	●	●	●	●	●	●	●	●	●	●	●	●	●	●			0.23-0.60	1.50-5.00	
	120412-B25		●			●	●	●	●	●	●	●	●	●	●	●	●	●	●	●	●	●			0.25-0.60	2.00-5.00	
	160608-B25					●	●	●	●	●	●	●	●	●	●	●	●	●	●	●	●	●			0.25-0.60	2.00-6.50	
	160612-B25					●	●	●	●	●	●	●	●	●	●	●	●	●	●	●	●	●			0.27-0.60	2.00-6.50	
	160616-B25					●	●	●	●	●	●	●	●	●	●	●	●	●	●	●	●	●			0.27-0.60	2.00-6.50	
	190604-B25								●		●														0.20-0.45	3.00-8.00	
	190608-B25					●	●	●	●	●	●	●	●	●	●	●	●	●	●	●	●	●			0.25-0.60	3.00-8.00	
	190612-B25					●	●	●	●	●	●	●	●	●	●	●	●	●	●	●	●	●			0.30-0.60	3.00-8.00	
	190616-B25					●	●	●	●	●	●	●	●	●	●	●	●	●	●	●	●	●			0.23-0.70	3.00-8.00	
Roughing 	CNMG 120408-GR					●	●	●	●	●	●	●	●	●	●	●	●	●	●	●	●			0.20-0.50	1.00-7.00		
	120412-GR						●	●	●	●	●	●	●	●	●	●	●	●	●	●	●			0.25-0.50	1.30-7.00		
	120416-GR							●	●	●	●	●	●	●	●	●	●	●	●	●	●			0.25-0.60	1.80-6.00		
	160608-GR					●	●	●	●	●	●	●	●	●	●	●	●	●	●	●	●	●			0.20-0.70	1.00-8.00	
	160612-GR					●	●	●	●	●	●	●	●	●	●	●	●	●	●	●	●	●			0.25-0.70	1.30-8.00	
	160616-GR					●	●	●	●	●	●	●	●	●	●	●	●	●	●	●	●	●			0.25-0.75	1.80-8.00	
	190608-GR							●	●	●	●	●	●	●	●	●	●	●	●	●	●	●			0.20-0.70	1.70-10.00	
	190612-GR					●	●	●	●	●	●	●	●	●	●	●	●	●	●	●	●	●			0.30-0.75	1.70-10.00	
	190616-GR					●	●	●	●	●	●	●	●	●	●	●	●	●	●	●	●	●			0.30-0.80	1.80-10.00	
	190624-GR																								0.35-0.85	2.00-12.00	
Medium to finishing  [Cermet]	CNMG 090304-VQ																								0.05-0.30	0.50-3.50	
	090308-VQ																									0.08-0.30	0.80-4.00
	090408-VQ																								0.05-0.30	0.50-3.50	
	090412-VQ																								0.08-0.30	0.80-4.00	
	120404-VQ	●	●	●	●																				0.05-0.30	0.80-4.00	
	120408-VQ	●	●	●	●																				0.08-0.40	0.80-4.00	
	120412-VQ																								0.10-0.40	0.80-4.00	
Medium cutting 	CNMG 120404-MK																								0.05-0.30	0.90-4.00	
	120408-MK																									0.10-0.50	1.00-5.00
	120412-MK																									0.13-0.60	1.30-5.00
	120416-MK																									0.15-0.60	1.30-5.00
	160608-MK																									0.28-0.70	1.80-7.00
	160612-MK																									0.28-0.72	2.00-8.00
	160616-MK																									0.28-0.74	2.00-8.00
	190608-MK																									0.33-0.78	2.50-9.00
	190612-MK																									0.35-0.78	2.60-9.50
	190616-MK																									0.35-0.80	2.60-10.00

 Cutting edge geometry A52~A61
  Recommended chip breaker B04~B14
  Code system B34~B35
 ● : Stock item

Available tool holders			
Designation	Page	Designation	Page
MCKNR/L	B183	MCRNR/L	B184
MCLNR/L	B183	PCBNR/L	B172
MCMNN	B183	PCLNR/L	B173



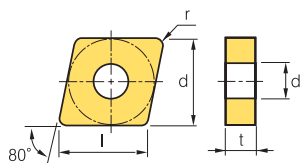




# B Turning Insert (Negative)





CN○○○

 Rhombic **80° Negative**



Dimensions (mm)			
Size	d	t	d <sub>1</sub>
09	9.525	3.18	3.81
12	12.7	4.76	5.16
16	15.875	6.35	6.35
19	19.05	6.35	7.93
25	25.4	9.52	9.12

Workpiece	Material	Grade	Machining types															
			●	●	●	●	●	●	●	●	●	●	●	●	●	●	●	●
Steel		<b>P</b>	●	●	●	●	●	●	●	●	●	●	●	●	●	●	●	
Stainless steel		<b>M</b>	●	●	●	●	●	●	●	●	●	●	●	●	●	●	●	
Cast iron		<b>K</b>	●	●	●	●	●	●	●	●	●	●	●	●	●	●	●	
Non-ferrous metal		<b>N</b>	●	●	●	●	●	●	●	●	●	●	●	●	●	●	●	
Heat resistant alloy, Titanium alloy		<b>S</b>	●	●	●	●	●	●	●	●	●	●	●	●	●	●	●	
Hardened steel		<b>H</b>	●	●	●	●	●	●	●	●	●	●	●	●	●	●	●	

Inserts	Designation	Cermet		Coated		Coated											Uncoated		Cutting Condition								
		CN1500	CN2500	CC-1500	CC-2500	NC3215	NC3225	NC3120	NC3030	NC3235	NC5330	NC6310	NC6315	NC9115	NC9125	NC9135	PC5300	PC5400	PC8105	PC8110	PC8115	PC9030	H01	H05	f <sub>n</sub> (mm/rev)	a <sub>p</sub> (mm)	
Medium cutting 	CNMG	090304-MM																							0.08-0.35	0.50-5.00	
		090308-MM												●	●								●			0.10-0.40	0.50-5.00
		090312-MM																								0.12-0.45	0.50-5.00
		090404-MM																								0.08-0.35	0.50-5.00
		090408-MM																								0.10-0.40	0.50-5.00
		090412-MM																								0.12-0.45	0.50-5.00
		120404-MM													●	●	●				●	●	●			0.10-0.40	0.50-5.50
		120408-MM													●	●	●	●			●	●	●			0.12-0.45	0.50-5.50
		120412-MM													●	●	●	●			●	●	●			0.15-0.60	0.50-5.50
		120416-MM													●	●	●				●					0.20-0.65	0.50-5.50
		160608-MM													●	●	●				●					0.12-0.45	0.50-7.00
		160612-MM													●	●	●				●	●	●			0.15-0.60	0.50-7.00
		160616-MM													●	●	●				●	●				0.18-0.65	0.50-7.00
		190608-MM													●	●	●				●					0.12-0.45	0.50-8.50
		190612-MM													●	●	●				●	●	●			0.15-0.60	0.50-8.50
	190616-MM													●	●	●				●	●				0.18-0.65	0.50-8.50	
Roughing 	CNMG	120404-RM												●	●	●				●	●				0.10-0.50	2.00-6.00	
		120408-RM												●	●	●	●			●	●	●			0.15-0.55	2.00-6.00	
		120412-RM												●	●	●	●			●	●	●			0.20-0.60	2.00-6.00	
		120416-RM													●	●	●				●				0.25-0.70	2.00-6.00	
		160608-RM													●	●	●				●				0.15-0.55	2.00-8.00	
		160612-RM													●	●	●				●				0.20-0.60	2.00-8.00	
		160616-RM													●	●	●				●				0.25-0.70	2.00-8.00	
		190608-RM													●	●	●				●				0.15-0.55	2.00-10.00	
		190612-RM													●	●	●				●				0.20-0.60	2.00-10.00	
		190616-RM													●	●	●				●				0.25-0.70	2.00-10.00	
	250924-RM																								0.40-1.20	4.00-14.00	
Finishing 	CNMG	120404-VP1																	●	●		●			0.05-0.15	0.10-1.50	
		120408-VP1																		●	●		●			0.07-0.20	0.10-1.50
Finishing 	CNGG	120402-VP1																			●				0.01-0.10	0.10-1.00	
		120404-VP1																				●			0.05-0.15	0.10-1.50	
		120408-VP1																							0.07-0.20	0.10-1.50	

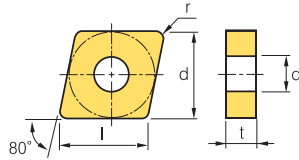
 Cutting edge geometry **A52~A61**
 Recommended chip breaker **B04~B14**
 Code system **B34~B35**
● : Stock item

Available tool holders			
Designation	Page	Designation	Page
MCKNR/L	B183	MCRNR/L	B184
MCLNR/L	B183	PCBNR/L	B172
MCMNN	B183	PCLNR/L	B173



CN○○○

## Rhombic 80° Negative



Dimensions (mm)			
Size	d	t	d <sub>1</sub>
12	12.7	4.76	5.16
16	15.875	6.35	6.35
19	19.05	6.35	7.93

Workpiece	Material Groups												Machining types				
	Steel	Stainless steel	Cast iron	Non-ferrous metal	Heat resistant alloy, Titanium alloy	Hardened steel	P	M	K	N	S	H	●	⊙	⊛	⊞	
Steel	●	●	●	●	●	●	●	●	●	●	●	●	●	●	●	●	●
Stainless steel	●	●	●	●	●	●	●	●	●	●	●	●	●	●	●	●	●
Cast iron	●	●	●	●	●	●	●	●	●	●	●	●	●	●	●	●	●
Non-ferrous metal	●	●	●	●	●	●	●	●	●	●	●	●	●	●	●	●	●
Heat resistant alloy, Titanium alloy	●	●	●	●	●	●	●	●	●	●	●	●	●	●	●	●	●
Hardened steel	●	●	●	●	●	●	●	●	●	●	●	●	●	●	●	●	●

Inserts	Designation	Cermets		Coated		Coated										Uncoated		Cutting Condition											
		CN1500	CN2500	CC1500	CC2500	NC3215	NC3225	NC3120	NC3030	NC3235	NC5330	NC6315	NC9115	NC9125	NC9135	PC5300	PC5400	PC8105	PC8110	PC8115	PC8120	PC9030	H01	H05	f <sub>n</sub> (mm/rev)	a <sub>p</sub> (mm)			
Medium to finishing 	CNMG 120404-VP2					●									●	●	●	●	●	●	●	●	●	●	●	0.05-0.30	0.10-3.00		
	CNMG 120408-VP2														●	●	●	●	●	●	●	●	●	●	●	0.10-0.40	0.50-4.50		
	CNMG 160608-VP2																									0.12-0.45	0.80-5.00		
	CNMG 190608-VP2																										0.12-0.50	1.00-5.20	
	CNMG 190612-VP2																											0.15-0.50	1.20-5.50
	CNMG 190616-VP2																											0.18-0.50	1.50-5.50
Medium cutting 	CNMG 120404-VP3														●	●	●	●	●	●	●	●	●	●	●	●	0.05-0.30	0.10-3.00	
	CNMG 120408-VP3														●	●	●	●	●	●	●	●	●	●	●	●	0.10-0.40	0.50-4.50	
	CNMG 120412-VP3														●	●	●	●	●	●	●	●	●	●	●	●	0.12-0.50	0.50-5.00	
	CNMG 120416-VP3																										0.25-0.45	1.00-4.00	
	CNMG 160608-VP3																										0.15-0.35	0.80-6.00	
	CNMG 160612-VP3																										0.20-0.40	1.00-6.00	
	CNMG 160616-VP3																										0.20-0.40	1.00-6.00	
	CNMG 190608-VP3																											0.20-0.50	1.00-7.00
	CNMG 190612-VP3																											0.25-0.55	1.00-8.00
CNMG 190616-VP3																											0.30-0.60	1.00-8.00	
Medium cutting 	CNMG 120404-VP3																										0.05-0.30	0.10-3.00	
	CNMG 120408-VP3																											0.10-0.40	0.50-4.50
	CNMG 120412-VP3																											0.12-0.50	0.50-5.00
Roughing 	CNMG 120408-VP4																										0.15-0.35	1.00-4.00	
	CNMG 120412-VP4																										0.20-0.40	1.00-4.00	
	CNMG 160608-VP4																										0.20-0.45	1.00-6.50	
	CNMG 160612-VP4																										0.25-0.50	1.50-6.50	
	CNMG 190608-VP4																										0.15-0.45	1.00-8.00	
CNMG 190612-VP4																											0.20-0.50	1.20-8.50	
Medium to finishing 	CNMG 120404-HA																										0.05-0.20	0.80-3.50	
	CNMG 120408-HA																										0.10-0.40	0.80-3.50	
	CNMG 120412-HA																										0.13-0.55	0.80-3.50	
Finishing 	CNMG 120404-VW																										0.10-0.30	0.50-3.00	
	CNMG 120408-VW																										0.15-0.50	0.50-4.00	
	CNMG 120412-VW																										0.20-0.55	1.00-4.50	

Cutting edge geometry A52-A61  
 Recommended chip breaker B04-B14  
 Code system B34-B35  
 ● : Stock item

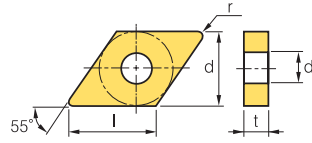
Available tool holders			
Designation	Page	Designation	Page
MCKNR/L	B183	MCRNR/L	B184
MCLNR/L	B183	PCBNR/L	B172
MCMNN	B183	PCLNR/L	B173





DN ○ ○

Dimensions (mm)			
Size	d	t	d <sub>1</sub>
11	9.525	3.18-4.76	3.81
15	12.7	4.76-6.35	5.16



## Rhombic 55° Negative

Workpiece	Machining types															
	P	M	K	N	S	H										
Steel	●	●	●	●	●	●	●	●	●	●	●	●	●	●	●	●
Stainless steel	●	●	●	●	●	●	●	●	●	●	●	●	●	●	●	●
Cast iron	●	●	●	●	●	●	●	●	●	●	●	●	●	●	●	●
Non-ferrous metal	●	●	●	●	●	●	●	●	●	●	●	●	●	●	●	●
Heat resistant alloy, Titanium alloy	●	●	●	●	●	●	●	●	●	●	●	●	●	●	●	●
Hardened steel	●	●	●	●	●	●	●	●	●	●	●	●	●	●	●	●

Inserts	Designation	Cermets		Coated												Uncoated		Cutting Condition									
		CN1500	CN2500	CC1500	CC2500	NC3215	NC3225	NC3120	NC3030	NC3235	NC5330	NC6310	NC6315	NC9115	NC9125	NC9135	PC5300	PC5400	PC8105	PC8110	PC8115	PC9030	H01	H05	f <sub>n</sub> (mm/rev)	a <sub>p</sub> (mm)	
Finishing 	DNMG 110404-VB																								0.05-0.25	0.30-2.00	
	150404-VB	●	●	●	●	●	●																			0.10-0.35	0.30-2.00
	150408-VB	●	●	●	●	●	●				●									●						0.15-0.45	0.50-2.00
	150412-VB					●	●																			0.15-0.45	0.50-2.00
	150604-VB	●	●	●	●	●	●				●															0.10-0.35	0.30-2.00
	150608-VB	●	●	●	●	●	●				●						●									0.15-0.45	0.50-2.00
	150612-VB					●	●				●															0.20-0.50	0.50-2.50
Finishing 	DNMG 110402-VF																								0.05-0.20	0.20-1.00	
	110404-VF																									0.07-0.30	0.50-1.50
	110408-VF																									0.10-0.40	0.50-1.50
	150404-VF																									0.07-0.30	0.50-1.50
	150408-VF																									0.10-0.40	0.50-1.50
	150412-VF																									0.15-0.50	0.60-1.50
	150604-VF							●			●															0.13-0.30	0.50-1.50
	150608-VF							●			●															0.10-0.40	0.50-1.50
150612-VF																									0.15-0.50	0.60-1.50	
Finishing 	DNMG 110408-VL																								0.05-0.20	0.10-1.00	
	150404-VL							●			●															0.05-0.25	0.10-1.50
	150408-VL							●	●		●															0.05-0.30	0.20-1.50
	150412-VL																									0.10-0.30	0.25-1.50
	150604-VL	●																								0.05-0.25	0.10-1.50
	150608-VL	●						●	●		●															0.05-0.30	0.20-1.50
	150612-VL																									0.10-0.30	0.25-1.50
Medium to finishing 	DNMG 110402-LP																								0.06-0.30	0.25-1.20	
	110404-LP							●	●																	0.07-0.30	0.30-1.50
	110408-LP																									0.10-0.40	0.30-1.50
	110504-LP																									0.07-0.30	0.30-1.50
	110508-LP																									0.10-0.40	0.30-1.50
	150404-LP							●	●		●															0.10-0.35	0.30-2.00
	150408-LP							●	●		●															0.10-0.40	0.50-2.50
	150412-LP							●	●		●															0.13-0.45	0.80-3.00
	150604-LP							●	●		●															0.10-0.35	0.30-2.00
	150608-LP							●	●		●															0.10-0.40	0.50-2.50
	150612-LP							●	●		●															0.13-0.45	0.80-3.00

Cutting edge geometry **A52-A61**
 Recommended chip breaker **B04-B14**
 Code system **B34-B35**
● : Stock item

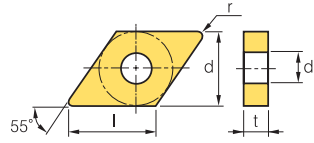
Available tool holders			
Designation	Page	Designation	Page
MCKNR/L	B183	MCRNR/L	B184
MCLNR/L	B183	PCBNR/L	B172
MCMNN	B183	PCLNR/L	B173



# B Turning Insert (Negative)

DN ○ ○

Dimensions (mm)			
Size	d	t	d <sub>1</sub>
11	9.525	3.18~4.76	3.81
15	12.7	4.76~6.35	5.16



## Rhombic 55° Negative

Workpiece	Material Compatibility													Machining types			
	Steel	Stainless steel	Cast iron	Non-ferrous metal	Heat resistant alloy, Titanium alloy	Hardened steel	P	M	K	N	S	H	●	⊕	⊖	⊙	
Steel							●	⊕	⊖	⊙							
Stainless steel							●	⊕	⊖	⊙							
Cast iron							●	⊕	⊖	⊙							
Non-ferrous metal																	
Heat resistant alloy, Titanium alloy																	
Hardened steel																	

Inserts	Designation	Cermets		Coated		Coated													Uncoated		Cutting Condition					
		CN1500	CN2500	CC1500	CC2500	NC3215P	NC3225P	NC3215	NC3225	NC3120	NC3030	NC3235	NC5330	NC6310	NC6315	NC9115	NC9125	NC9135	PC8105	PC8110	PC8115	PC9030	H01	H05	f <sub>n</sub> (mm/rev)	a <sub>p</sub> (mm)
Medium to finishing 	DNMG 110404-CP																								0.08-0.30	0.40-3.00
	110408-CP																								0.10-0.30	0.40-3.00
	110504-CP																								0.08-0.30	0.40-3.00
	110508-CP																								0.10-0.30	0.40-3.00
	150404-CP					●	●																		0.10-0.35	0.50-3.50
	150408-CP					●	●																		0.12-0.35	0.50-3.50
	150412-CP					●	●																		0.13-0.35	0.80-3.50
	150604-CP					●	●																		0.10-0.35	0.50-3.50
	150608-CP					●	●																		0.12-0.35	0.50-3.50
	150612-CP					●	●																		0.13-0.35	0.80-3.50
Medium to finishing 	DNMG 150404-VC							●	●																0.10-0.35	0.30-2.00
	150408-VC							●	●		●														0.15-0.40	0.50-3.00
	150412-VC							●	●																0.15-0.45	0.50-3.00
	150604-VC							●	●																0.10-0.35	0.30-2.00
	150608-VC							●	●		●														0.15-0.40	0.50-3.00
Medium cutting 	DNMG 110404-HM										●														0.05-0.50	0.80-4.00
	110408-HM																								0.10-0.50	1.00-4.00
	150404-HM								●																0.05-0.30	0.90-5.00
	150408-HM									●															0.10-0.50	1.00-5.00
	150604-HM									●	●		●												0.05-0.30	0.90-5.00
	150608-HM									●	●	●													0.10-0.50	1.00-5.00
Medium cutting 	DNMG 110404-MP							●	●		●				●	●									0.10-0.40	0.40-3.80
	110408-MP							●	●		●				●	●									0.15-0.40	0.50-4.00
	110412-MP																								0.15-0.50	0.80-4.20
	110504-MP																								0.10-0.40	0.40-3.80
	110508-MP																								0.15-0.40	0.50-4.00
	110512-MP																								0.15-0.50	0.80-4.20
	150404-MP							●	●		●				●	●	●	●							0.10-0.40	0.40-4.00
	150408-MP							●	●		●				●	●	●	●	●						0.15-0.45	0.50-4.50
	150412-MP							●	●		●				●			●							0.15-0.50	0.80-5.00
	150416-MP																								0.15-0.50	0.85-5.00
	150604-MP							●	●		●				●	●	●	●	●						0.10-0.40	0.40-4.00
	150608-MP							●	●		●				●	●	●	●	●						0.15-0.45	0.50-4.50
	150612-MP							●	●		●				●	●	●	●	●						0.15-0.50	0.80-5.00
150616-MP							●	●		●				●	●	●	●	●						0.15-0.55	0.85-5.00	

Cutting edge geometry A52~A61  
 Recommended chip breaker B04~B14  
 Code system B34~B35  
 ● : Stock item

Available tool holders			
Designation	Page	Designation	Page
MCKNR/L	B183	MCRNR/L	B184
MCLNR/L	B183	PCBNR/L	B172
MCMNN	B183	PCLNR/L	B173



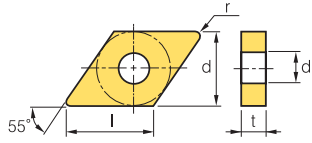




# B Turning Insert (Negative)

## DN ○○

### Rhombic 55° Negative



Dimensions (mm)			
Size	d	t	d <sub>1</sub>
11	9.525	3.18~4.76	3.81
15	12.7	4.76~6.35	5.16
19	19.05	6.35	7.93

Workpiece	Material Compatibility													Machining types			
	Steel	Stainless steel	Cast iron	Non-ferrous metal	Heat resistant alloy, Titanium alloy	Hardened steel	P	M	K	N	S	H	●	⊕	⊛	⊚	
Steel	●	●	●	●	●	●	●	●	●	●	●	●	●	●	●	●	●
Stainless steel	●	●	●	●	●	●	●	●	●	●	●	●	●	●	●	●	●
Cast iron	●	●	●	●	●	●	●	●	●	●	●	●	●	●	●	●	●
Non-ferrous metal	●	●	●	●	●	●	●	●	●	●	●	●	●	●	●	●	●
Heat resistant alloy, Titanium alloy	●	●	●	●	●	●	●	●	●	●	●	●	●	●	●	●	●
Hardened steel	●	●	●	●	●	●	●	●	●	●	●	●	●	●	●	●	●

Inserts	Designation	Cermet		Coated		Coated										Uncoated		Cutting Condition										
		CN1500	CN2500	CC1500	CC2500	NC3215	NC3225	NC3120	NC3030	NC3235	NC5330	NC6310	NC6315	NC9115	NC9125	NC9135	PC5300	PC5400	PC8105	PC8110	PC8115	PC9030	H01	H05	f <sub>n</sub> (mm/rev)	a <sub>p</sub> (mm)		
Medium cutting MK	DNMG 150404-MK																									0.05-0.30	0.90-5.00	
	150408-MK																										0.10-0.50	1.00-5.00
	150412-MK																										0.13-0.60	1.30-5.00
	150604-MK																										0.05-0.30	0.90-5.00
	150608-MK																										0.10-0.50	1.00-5.00
	150612-MK																										0.13-0.60	1.30-5.00
Roughing DNMA	110408																										0.17-0.45	0.80-3.00
	150404																										0.17-0.55	0.40-4.00
	150408																										0.25-0.55	0.80-4.00
	150412																										0.25-0.65	0.50-4.00
	150604																										0.17-0.55	0.40-4.00
	150608																										0.25-0.55	0.80-4.00
	190608																										0.30-0.80	2.50-13.00
Roughing DNMG	150408-RK																										0.15-0.50	1.50-5.00
	150412-RK																										0.20-0.60	1.80-5.00
	150608-RK																										0.15-0.50	1.50-5.00
	150612-RK																										0.20-0.60	1.80-5.00
Roughing DNMG	150408-VR																										0.25-0.55	1.20-7.00
	150412-VR																										0.30-0.60	1.50-7.00
	150608-VR																										0.25-0.55	1.20-7.00
	150612-VR																										0.30-0.60	1.50-7.00
Medium cutting DNMG	110404-MM																										0.08-0.35	0.50-5.00
	110408-MM																										0.10-0.40	0.50-5.00
	110412-MM																										0.12-0.45	0.50-5.00
	110504-MM																										0.08-0.35	0.50-5.00
	110508-MM																										0.10-0.40	0.50-5.00
	110512-MM																										0.12-0.45	0.50-5.00
	150404-MM																										0.10-0.40	0.50-6.40
	150408-MM																										0.12-0.45	0.50-6.40
	150412-MM																										0.15-0.60	0.50-6.40
	150416-MM																										0.15-0.60	0.50-6.00
	150604-MM																										0.10-0.40	0.50-6.40
	150608-MM																										0.12-0.45	0.50-6.40
	150612-MM																										0.15-0.60	0.50-6.40
150616-MM																										0.18-0.65	0.50-8.00	

➤ Cutting edge geometry A52-A61   
 ➤ Recommended chip breaker B04-B14   
 ➤ Code system B34-B35   
 ● : Stock item

Available tool holders			
Designation	Page	Designation	Page
MCKNR/L	B183	MCRNR/L	B184
MCLNR/L	B183	PCBNR/L	B172
MCMNN	B183	PCLNR/L	B173

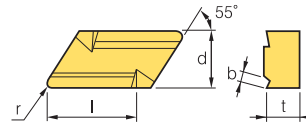








# KN

Dimensions (mm)		
Size	d	t
16	9.525	4.76



## Parallelogram 55° Negative

Workpiece	Steel	P	●	✱	●	✱	●	✱	✱	✱	●	●	✱					Machining types
	Stainless steel	M																
Cast iron	K	●	✱	●	✱	●	✱											● Continuous cutting
Non-ferrous metal	N																	● General cutting
Heat resistant alloy, Titanium alloy	S																	✱ Interrupted cutting
Hardened steel	H																	

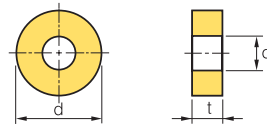
Inserts	Designation	Cermet		Coated		Coated										Uncoated		Cutting Condition											
		CN1500	CN2500	CC1500	CC2500	NC3215	NC3225	NC3120	NC3030	NC3235	NC5330	NC6310	NC6315	NC9115	NC9125	NC9135	PC5300	PC5400	PC8105	PC8110	PC8115	PC9030	H01	H05	fn (mm/rev)	ap (mm)			
Medium cutting 	KNUX 160405R-11					●	●	●	●	●	●	●														0.20-0.35	1.00-6.00		
						●	●	●	●	●	●	●															0.30-0.60	1.50-6.00	
						●	●	●	●	●	●	●																0.20-0.35	1.00-6.00
						●	●	●	●	●	●	●																0.30-0.60	1.50-6.00
Roughing 	KNUX 160405R-12					●	●	●	●	●	●																0.25-0.35	1.50-6.00	
						●	●	●	●	●	●																	0.40-0.70	1.50-6.00
																												0.25-0.35	1.50-6.00
										●																		0.40-0.70	1.50-6.00

 Cutting edge geometry **A52-A61**  
  Recommended chip breaker **B04-B14**  
  Code system **B34-B35**  
 ● : Stock item

Available tool holders			
Designation	Page	Designation	Page
CKJNR/L	B181	CKUNR/L	B212
CKNNR/L	B181		


# RN

Dimensions (mm)			
Size	d	t	d <sub>1</sub>
09	9.525	3.18	3.81
12	12.7	4.76	5.16
15	15.875	6.35	6.35
19	19.05	6.35	7.93
25	25.4	6.35-9.52	9.12
31	31.75	9.52	12.7



## Round Negative

Workpiece	Steel	P	●	✱	●	✱	●	✱	✱	✱	●	●	✱					Machining types
	Stainless steel	M																
Cast iron	K	●	✱	●	✱	●	✱											● Continuous cutting
Non-ferrous metal	N																	● General cutting
Heat resistant alloy, Titanium alloy	S																	✱ Interrupted cutting
Hardened steel	H																	

Inserts	Designation	Cermet		Coated		Coated										Uncoated		Cutting Condition											
		CN1500	CN2500	CC1500	CC2500	NC3215	NC3225	NC3120	NC3030	NC3235	NC5330	NC6310	NC6315	NC9115	NC9125	NC9135	PC5300	PC5400	PC8105	PC8110	PC8115	PC9030	H01	H05	fn (mm/rev)	ap (mm)			
General 	RNMG 090300-B25																									0.90-4.50	0.09-0.90		
	120400-B25																										1.20-4.80	0.12-1.20	
	150600-B25									●																	1.15-1.50	1.50-7.50	
	190600-B25																										1.90-7.60	0.19-1.90	
	250600-B25																										2.50-10.0	0.25-2.50	
	250900-B25										●																	2.50-10.0	0.25-2.50
	310900-B25																										3.50-13.0	0.30-2.50	

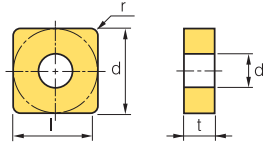
 Cutting edge geometry **A52-A61**  
  Recommended chip breaker **B04-B14**  
  Code system **B34-B35**  
 ● : Stock item





# B Turning Insert (Negative)

SN ○ ○



Dimensions (mm)			
Size	d	t	d <sub>1</sub>
09	9.525	3.18	3.81
12	12.7	4.76	5.16

○ Square 90° Negative

Workpiece	Material Groups												Machining types			
	P	M	K	N	S	H										
Steel	●	●	●	●	●	●	●	●	●	●	●	●	●	●	●	●
Stainless steel	●	●	●	●	●	●	●	●	●	●	●	●	●	●	●	●
Cast iron	●	●	●	●	●	●	●	●	●	●	●	●	●	●	●	●
Non-ferrous metal	●	●	●	●	●	●	●	●	●	●	●	●	●	●	●	●
Heat resistant alloy, Titanium alloy	●	●	●	●	●	●	●	●	●	●	●	●	●	●	●	●
Hardened steel	●	●	●	●	●	●	●	●	●	●	●	●	●	●	●	●

● Continuous cutting  
 ● General cutting  
 ● Interrupted cutting

Inserts	Designation	Cermet		Coated		Coated													Uncoated		Cutting Condition						
		CN1500	CN2500	CC1500	CC2500	NC3215P	NC3225P	NC3215	NC3225	NC3120	NC3030	NC3235	NC5330	NC6310	NC6315	NC9115	NC9125	NC9135	PC8105	PC8110	PC8115	PC9030	H01	H05	f <sub>n</sub> (mm/rev)	a <sub>p</sub> (mm)	
Finishing	VB	SNMG 120404-VB	●	●	●	●	●	●	●	●	●	●	●	●	●	●	●	●	●	●	●	●	●	●	●	0.15-0.35	0.30-2.00
		120408-VB	●	●	●	●	●	●	●	●	●	●	●	●	●	●	●	●	●	●	●	●	●	●	●	●	0.15-0.40
Finishing	VF	SNMG 090304-VF	●	●	●	●	●	●	●	●	●	●	●	●	●	●	●	●	●	●	●	●	●	●	●	0.07-0.30	0.50-1.50
		090308-VF	●	●	●	●	●	●	●	●	●	●	●	●	●	●	●	●	●	●	●	●	●	●	●	0.07-0.30	0.50-1.50
		120404-VF	●	●	●	●	●	●	●	●	●	●	●	●	●	●	●	●	●	●	●	●	●	●	●	0.07-0.30	0.50-1.50
		120408-VF	●	●	●	●	●	●	●	●	●	●	●	●	●	●	●	●	●	●	●	●	●	●	●	0.10-0.40	0.50-1.50
		120412-VF	●	●	●	●	●	●	●	●	●	●	●	●	●	●	●	●	●	●	●	●	●	●	●	0.20-0.50	0.50-1.50
Finishing	VL	SNMG 120408-VL	●	●	●	●	●	●	●	●	●	●	●	●	●	●	●	●	●	●	●	●	●	●	0.10-0.35	0.20-1.50	
Medium to finishing	LP	SNMG 090308-LP	●	●	●	●	●	●	●	●	●	●	●	●	●	●	●	●	●	●	●	●	●	●	●	0.10-0.30	0.30-1.50
		090408-LP	●	●	●	●	●	●	●	●	●	●	●	●	●	●	●	●	●	●	●	●	●	●	●	0.10-0.30	0.30-1.50
		120404-LP	●	●	●	●	●	●	●	●	●	●	●	●	●	●	●	●	●	●	●	●	●	●	●	0.10-0.35	0.30-2.00
		120408-LP	●	●	●	●	●	●	●	●	●	●	●	●	●	●	●	●	●	●	●	●	●	●	●	0.10-0.40	0.50-2.50
		120412-LP	●	●	●	●	●	●	●	●	●	●	●	●	●	●	●	●	●	●	●	●	●	●	●	0.13-0.45	0.80-3.00
Medium to finishing	CP	SNMG 090304-CP	●	●	●	●	●	●	●	●	●	●	●	●	●	●	●	●	●	●	●	●	●	●	●	0.08-0.30	0.40-3.00
		090308-CP	●	●	●	●	●	●	●	●	●	●	●	●	●	●	●	●	●	●	●	●	●	●	●	0.10-0.30	0.40-3.00
		090404-CP	●	●	●	●	●	●	●	●	●	●	●	●	●	●	●	●	●	●	●	●	●	●	●	0.08-0.30	0.40-3.00
		090408-CP	●	●	●	●	●	●	●	●	●	●	●	●	●	●	●	●	●	●	●	●	●	●	●	0.10-0.30	0.40-3.00
		120404-CP	●	●	●	●	●	●	●	●	●	●	●	●	●	●	●	●	●	●	●	●	●	●	●	0.10-0.35	0.50-3.50
		120408-CP	●	●	●	●	●	●	●	●	●	●	●	●	●	●	●	●	●	●	●	●	●	●	●	0.12-0.35	0.50-3.50
120412-CP	●	●	●	●	●	●	●	●	●	●	●	●	●	●	●	●	●	●	●	●	●	●	●	0.13-0.35	0.80-3.50		
Medium to finishing	VC	SNMG 120408-VC	●	●	●	●	●	●	●	●	●	●	●	●	●	●	●	●	●	●	●	●	●	●	0.15-0.40	0.50-3.50	

↻ Cutting edge geometry A52-A61   
 ↻ Recommended chip breaker B04-B14   
 ↻ Code system B34-B35   
 ● : Stock item

Available tool holders					
Designation	Page	Designation	Page	Designation	Page
MSBNR/L	B185	MSRNR/L	B186	PSDNN	B175
MSDNN	B185	MSSNR/L	B187	PSKNR/L	B176
MSKNR/L	B186	PSBNR/L	B175	PSSNR/L	B177



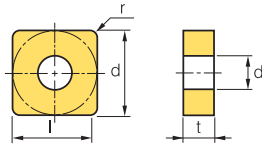









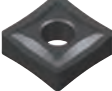



# SN



Size	Dimensions (mm)		
	d	t	d <sub>1</sub>
12	12.7	4.76	5.16
15	15.875	6.35	6.35
16	9.525	3.18~4.76	3.81
19	19.05	6.35	7.93
25	25.4	7.94	9.12

**○** Square **90° Negative**

Workpiece	Material	Machining types															
		●	✱	●	✱	●	✱	●	✱	●	✱	●	✱	●	✱	●	✱
Steel	<b>P</b>	●	✱	●	✱	●	✱	●	✱	●	✱	●	✱	●	✱	●	✱
Stainless steel	<b>M</b>	●	✱	●	✱	●	✱	●	✱	●	✱	●	✱	●	✱	●	✱
Cast iron	<b>K</b>	●	✱	●	✱	●	✱	●	✱	●	✱	●	✱	●	✱	●	✱
Non-ferrous metal	<b>N</b>	●	✱	●	✱	●	✱	●	✱	●	✱	●	✱	●	✱	●	✱
Heat resistant alloy, Titanium alloy	<b>S</b>	●	✱	●	✱	●	✱	●	✱	●	✱	●	✱	●	✱	●	✱
Hardened steel	<b>H</b>	●	✱	●	✱	●	✱	●	✱	●	✱	●	✱	●	✱	●	✱

Inserts	Designation	Cermets		Coated												Uncoated		Cutting Condition										
		CN1500	CN2500	CC1500	CC2500	NC3215	NC3225	NC3120	NC3030	NC3235	NC5330	NC6315	NC9115	NC9125	NC9135	PC5300	PC5400	PC8105	PC8110	PC8115	PC8120	PC9030	H01	H05	f <sub>n</sub> (mm/rev)	a <sub>p</sub> (mm)		
Roughing 	SNMG 120404-RM												●	●	●	●				●					0.10-0.50	2.00-6.00		
	120408-RM												●	●	●	●			●	●	●					0.15-0.55	2.00-6.00	
	120412-RM												●	●	●				●							0.20-0.60	2.00-6.00	
	120416-RM												●	●	●				●							0.25-0.70	2.00-6.00	
	150608-RM																			●						0.20-0.60	0.20-6.00	
	150612-RM													●	●	●				●						0.20-0.60	2.00-8.00	
	150616-RM																			●						0.25-0.70	2.00-8.00	
	190608-RM														●	●	●				●					0.20-0.60	2.00-10.00	
	190612-RM														●	●	●				●					0.20-0.60	2.00-10.00	
	190616-RM														●	●					●					0.27-0.70	2.00-10.00	
	190624-RM														●						●					0.30-0.75	3.00-10.00	
250924-RM																				●					0.40-1.20	4.00-14.00		
Medium to finishing 	SNMG 120404-VP2																		●	●	●	●	●	●	●	0.05-0.35	0.10-3.00	
	120408-VP2						●													●	●	●	●	●	●	0.10-0.45	0.50-4.50	
	120412-VP2																			●	●	●	●	●	●	0.10-0.50	0.50-5.00	
Medium cutting 	SNMG 120404-VP3																		●	●	●	●	●	●	●	0.05-0.30	0.10-3.00	
	120408-VP3																			●	●	●	●	●	●	●	0.10-0.45	1.00-5.00
	120412-VP3																			●	●	●	●	●	●	●	0.12-0.50	1.00-5.00
	120416-VP3																				●					0.25-0.45	0.50-4.00	
	160608-VP3																				●					0.15-0.35	0.80-6.00	
	160612-VP3																				●					0.20-0.40	1.00-6.00	
	160616-VP3																				●					0.20-0.40	1.00-6.00	
	190608-VP3																				●					0.15-0.35	0.80-7.00	
	190612-VP3																				●					0.20-0.40	1.00-7.00	
190616-VP3																				●					0.25-0.45	1.00-7.00		
Medium cutting 	SNGG 120404-VP3																			●	●				0.05-0.30	0.10-3.00		
	120408-VP3																				●	●	●	●	●	0.10-0.45	1.00-5.00	
	120412-VP3																				●	●	●	●	●	0.12-0.50	1.00-5.00	
Roughing 	SNMG 120408-VP4																				●	●				0.15-0.35	1.00-4.00	
	120412-VP4																					●	●			0.20-0.40	1.00-4.00	
	150612-VP4																					●	●			0.20-0.45	1.00-5.00	
	190608-VP4																					●				0.20-0.50	1.00-9.00	
	190612-VP4																					●	●			0.23-0.55	1.00-9.00	
190616-VP4																						●			0.27-0.60	1.00-9.00		

 Cutting edge geometry **A52-A61**  
  Recommended chip breaker **B04-B14**  
  Code system **B34-B35**  
 ● : Stock item

Available tool holders					
Designation	Page	Designation	Page	Designation	Page
MSBNR/L	B185	MSRNR/L	B186	PSDNN	B175
MSDNN	B185	MSSNR/L	B187	PSKNR/L	B176
MSKNR/L	B186	PSBNR/L	B175	PSSNR/L	B177





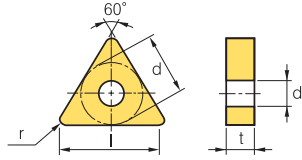




# B Turning Insert (Negative)

TN ○ ○

Triangular 60° Negative



Dimensions (mm)			
Size	d	t	d <sub>1</sub>
11	6.35	3.18	2.40
16	9.525	3.18~4.76	3.81
22	12.7	4.76	5.16

Workpiece	Machining types																								
	P	M	K	N	S	H	NC3215P	NC3225P	NC3215	NC3225	NC3120	NC3030	NC3235	NC5330	NC6310	NC6315	NC9115	NC9125	NC9135	PC8105	PC8110	PC8115	PC9030	H01	H05
Steel	●	●	●	●	●	●	●	●	●	●	●	●	●	●	●	●	●	●	●	●	●	●	●	●	●
Stainless steel	●	●	●	●	●	●	●	●	●	●	●	●	●	●	●	●	●	●	●	●	●	●	●	●	●
Cast iron	●	●	●	●	●	●	●	●	●	●	●	●	●	●	●	●	●	●	●	●	●	●	●	●	●
Non-ferrous metal	●	●	●	●	●	●	●	●	●	●	●	●	●	●	●	●	●	●	●	●	●	●	●	●	●
Heat resistant alloy, Titanium alloy	●	●	●	●	●	●	●	●	●	●	●	●	●	●	●	●	●	●	●	●	●	●	●	●	●
Hardened steel	●	●	●	●	●	●	●	●	●	●	●	●	●	●	●	●	●	●	●	●	●	●	●	●	●

Inserts	Designation	Cermets		Coated		Coated														Uncoated		Cutting Condition							
		CN1500	CN2500	CC1500	CC2500	NC3215P	NC3225P	NC3215	NC3225	NC3120	NC3030	NC3235	NC5330	NC6310	NC6315	NC9115	NC9125	NC9135	PC8105	PC8110	PC8115	PC9030	H01	H05	f <sub>n</sub> (mm/rev)	a <sub>p</sub> (mm)			
Finishing	VB	TNMG 160404-VB	●	●	●	●		●	●				●	●	●	●	●	●								0.10-0.35	0.30-1.50		
		TNMG 160408-VB	●	●	●	●		●	●				●	●	●	●	●	●									0.15-0.45	0.50-7.00	
		TNMG 160412-VB						●	●					●	●	●	●	●									0.18-0.45	0.80-3.00	
		TNMG 220408-VB						●	●					●	●	●	●	●										0.15-0.45	0.50-2.50
		TNMG 220412-VB						●	●					●	●	●	●	●										0.20-0.50	0.70-2.50
Finishing	VL	TNMG 160404-VL	●					●						●	●	●	●	●									0.05-0.25	0.10-1.00	
		TNMG 160408-VL	●					●	●					●	●	●	●	●									0.10-0.35	0.20-1.50	
		TNMG 160412-VL						●							●	●	●	●									0.15-0.40	0.20-1.50	
		TNMG 220408-VL						●							●	●	●	●									0.10-0.35	0.20-1.50	
		TNMG 220412-VL						●							●	●	●	●										0.10-0.35	0.50-2.00
Finishing	VF	TNMG 110304-VF	●											●	●	●	●	●									0.05-0.20	0.20-1.00	
		TNMG 160404-VF	●							●				●	●	●	●	●			●						0.07-0.30	0.50-1.50	
		TNMG 160408-VF						●	●					●	●	●	●	●										0.10-0.40	0.50-1.50
		TNMG 160412-VF						●	●					●	●	●	●	●										0.15-0.50	0.50-1.50
		TNMG 220404-VF													●	●	●	●	●					●				0.10-0.40	0.50-1.50
		TNMG 220408-VF													●	●	●	●	●									0.10-0.40	0.50-1.50
Medium to finishing	LP	TNMG 110304-LP																									0.07-0.30	0.30-1.50	
		TNMG 110308-LP																										0.10-0.30	0.30-1.50
		TNMG 160404-LP							●	●				●	●	●	●	●										0.10-0.35	0.30-2.00
		TNMG 160408-LP							●	●				●	●	●	●	●										0.10-0.40	0.50-2.50
		TNMG 160412-LP							●	●				●	●	●	●	●										0.13-0.45	0.80-3.00
Medium to finishing	CP	TNMG 110304-CP																									0.08-0.26	0.40-2.50	
		TNMG 110308-CP																										0.10-0.26	0.40-2.50
		TNMG 160404-CP						●	●					●	●	●	●	●										0.10-0.30	0.50-3.00
		TNMG 160408-CP						●	●					●	●	●	●	●										0.12-0.30	0.50-3.00
		TNMG 160412-CP						●	●					●	●	●	●	●										0.13-0.30	0.80-3.00
		TNMG 220408-CP						●	●					●	●	●	●	●										0.15-0.35	0.80-4.00
		TNMG 220412-CP						●	●					●	●	●	●	●										0.18-0.35	1.00-4.00

🔄 Cutting edge geometry A52~A61    🔄 Recommended chip breaker B04~B14    🔄 Code system B34~B35    ● : Stock item

Available tool holders					
Designation	Page	Designation	Page	Designation	Page
MTENN	B187	PTFNR/L	B177	WTJNR/L	B179
MTFNR/L	B187	PTGNR/L	B178	WTXNR/L	B179
MTGNR/L	B188	PTTNR/L	B178		
MTJNR/L	B188	WTENN	B179		







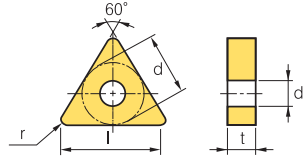




# B Turning Insert (Negative)





TN ○ ○

 Triangular 60° Negative



Dimensions (mm)			
Size	d	t	d <sub>1</sub>
11	6.35	3.18	2.40
16	9.525	4.76	3.81
22	12.7	4.76	5.16
27	15.875	6.35	6.35

Workpiece	Material	Grade	Machining types													
			●	✱	●	✱	●	✱	●	✱	●	✱	●	✱	●	✱
Steel		<b>P</b>	●	✱	●	✱	●	✱	●	✱	●	✱	●	✱	●	✱
Stainless steel		<b>M</b>	●	✱	●	✱	●	✱	●	✱	●	✱	●	✱	●	✱
Cast iron		<b>K</b>	●	✱	●	✱	●	✱	●	✱	●	✱	●	✱	●	✱
Non-ferrous metal		<b>N</b>														
Heat resistant alloy, Titanium alloy		<b>S</b>														
Hardened steel		<b>H</b>														

Inserts	Designation	Cermet		Coated		Coated											Uncoated		Cutting Condition										
		CN1500	CN2500	CC1500	CC2500	NC3215	NC3225	NC3120	NC3030	NC3235	NC5330	NC6310	NC6315	NC9115	NC9125	NC9135	PC5300	PC5400	PC8105	PC8110	PC8115	PC9030	H01	H05	f <sub>n</sub> (mm/rev)	a <sub>p</sub> (mm)			
Roughing		TNGA 110302																								0.05-0.30	0.20-3.00		
		110304																									0.05-0.30	0.40-3.00	
		160304																									0.10-0.35	0.40-4.00	
		160402																									0.10-0.30	0.20-4.00	
		160404																									0.10-0.35	0.40-5.00	
		160408																									0.10-0.35	0.50-5.00	
		220304																									0.10-0.35	0.50-5.00	
		220402																										0.05-0.30	0.20-3.00
		220404																										0.10-0.35	0.40-5.00
		220408																										0.10-0.40	0.50-5.00
		220412																										0.10-0.40	0.50-5.00
		220416																										0.12-0.45	1.00-5.50
		270612																										0.12-0.45	1.00-7.00
270624																										0.20-0.55	2.00-7.00		
Roughing		TNMG 160408-RK																								0.23-0.53	1.50-5.00		
		160412-RK																									0.28-0.53	1.80-5.00	
		160416-RK																									0.28-0.53	1.80-5.00	
		220408-RK																									0.23-0.53	1.50-6.00	
		220412-RK																										0.28-0.53	1.80-6.00
		220416-RK																										0.28-0.63	2.00-6.00
Roughing		TNMG 160404-VR																								0.20-0.50	0.80-7.00		
		160408-VR																									0.25-0.55	1.20-7.00	
		160412-VR																									0.35-0.65	1.70-7.00	
		160416-VR																									0.35-0.70	2.00-10.0	
		220408-VR																									0.35-0.70	2.00-10.0	
		220412-VR																									0.35-0.70	2.00-10.0	
		220416-VR																									0.35-0.75	2.20-10.0	
Medium cutting		TNMG 160404-MM																								0.10-0.40	0.50-4.80		
		160408-MM																									0.12-0.45	0.50-4.80	
		160412-MM																									0.18-0.65	0.50-4.80	
		160416-MM																									0.18-0.65	0.50-4.80	
		220404-MM																									0.10-0.40	0.50-6.50	
		220408-MM																									0.12-0.45	0.50-6.50	
		220412-MM																									0.15-0.60	0.50-6.50	
		220416-MM																									0.18-0.65	0.50-6.50	

 Cutting edge geometry A52~A61
  Recommended chip breaker B04~B14
  Code system B34~B35
 ● : Stock item

Available tool holders					
Designation	Page	Designation	Page	Designation	Page
MTENN	B187	PTFNR/L	B177	WTJNR/L	B179
MTFNR/L	B187	PTGNR/L	B178	WTXNR/L	B179
MTGNR/L	B188	PTTNR/L	B178		
MTJNR/L	B188	WTENN	B179		

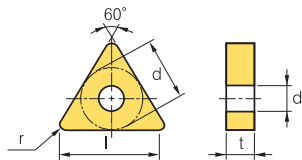




# B Turning Insert (Negative)






TN ○ ○

 Triangular 60° Negative



Dimensions (mm)			
Size	d	t	d <sub>1</sub>
11	6.35	3.18	2.40
16	9.525	4.76	3.81
22	12.7	4.76	5.16
27	15.875	6.35	6.35

Workpiece	Machining types															
	P	M	K	N	S	H										
Steel	●	●	●	●	●	●	●	●	●	●	●	●	●	●	●	●
Stainless steel	●	●	●	●	●	●	●	●	●	●	●	●	●	●	●	●
Cast iron	●	●	●	●	●	●	●	●	●	●	●	●	●	●	●	●
Non-ferrous metal	●	●	●	●	●	●	●	●	●	●	●	●	●	●	●	●
Heat resistant alloy, Titanium alloy	●	●	●	●	●	●	●	●	●	●	●	●	●	●	●	●
Hardened steel	●	●	●	●	●	●	●	●	●	●	●	●	●	●	●	●

Inserts	Designation	Cermets		Coated		Coated													Uncoated		Cutting Condition								
		CN1500	CN2500	CC1500	CC2500	NC3215	NC3225	NC3120	NC3030	NC3235	NC5330	NC6310	NC6315	NC9115	NC9125	NC9135	PC5300	PC5400	PC8105	PC8110	PC8115	PC9030	H01	H05	f <sub>n</sub> (mm/rev)	a <sub>p</sub> (mm)			
Finishing  [Wiper]	TNMG 160404-VW																									0.10-0.35	0.30-3.00		
	160408-VW																										0.10-0.40	0.30-3.00	
Medium cutting  [Wiper]	TNMG 160408-LW																									0.15-0.50	0.70-4.50		
	160412-LW																										0.20-0.60	1.00-5.00	
Medium cutting 	TNGN 110302																									0.05-0.25	0.20-2.50		
	110304																										0.10-0.30	0.50-2.50	
	110308																										0.10-0.30	0.80-2.50	
	160302																										0.05-0.30	0.20-3.00	
	160304																										0.10-0.30	0.50-4.00	
	160308																										0.10-0.40	0.80-4.00	
	160404																										0.10-0.40	0.50-4.00	
	160408																										0.10-0.40	1.00-4.00	
	160412																											0.10-0.50	1.50-4.50
	220404																											0.10-0.35	1.00-4.00
	220408																											0.15-0.40	1.50-5.00
	220412																											0.20-0.50	1.50-5.00
	220416																											0.25-0.55	1.50-5.00
220424																											0.30-0.65	2.00-5.00	
270630																											0.35-0.70	2.00-5.00	
Medium to finishing  [Shaft]	TNMX 160404R-SR																										0.10-0.35	0.70-3.50	
	160408R-SR																											0.12-0.40	1.00-3.50
	160404L-SR																											0.10-0.35	0.70-3.50
	160408L-SR																											0.12-0.40	1.00-3.50
Medium cutting  [Shaft]	TNMX 160404R-SH					●	●																				0.15-0.30	0.50-4.00	
	160408R-SH					●	●																					0.15-0.45	1.00-4.00
	160404L-SH					●	●																					0.15-0.30	0.50-4.00
	160408L-SH					●	●																					0.15-0.45	1.00-4.00

 Cutting edge geometry A52~A61  
  Recommended chip breaker B04~B14  
  Code system B34~B35  
 ● : Stock item

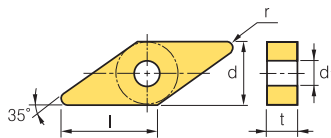
Available tool holders					
Designation	Page	Designation	Page	Designation	Page
MTENN	B187	PTFNR/L	B177	WTJNR/L	B179
MTFNR/L	B187	PTGNR/L	B178	WTXNR/L	B179
MTGNR/L	B188	PTTNR/L	B178		
MTJNR/L	B188	WTENN	B179		





# B Turning Insert (Negative)

## VN○○○



Dimensions (mm)			
Size	d	t	d <sub>1</sub>
16	9.525	4.76	3.81

Rhombic 35° Negative

Workpiece	Machining types												
	P	M	K	N	S	H	●	⊙	⊚	⊛	⊜	⊝	⊞
Steel	●	●	●	●	●	●	●	●	●	●	●	●	●
Stainless steel	●	●	●	●	●	●	●	●	●	●	●	●	●
Cast iron	●	●	●	●	●	●	●	●	●	●	●	●	●
Non-ferrous metal	●	●	●	●	●	●	●	●	●	●	●	●	●
Heat resistant alloy, Titanium alloy	●	●	●	●	●	●	●	●	●	●	●	●	●
Hardened steel	●	●	●	●	●	●	●	●	●	●	●	●	●

Inserts	Designation	Cermets		Coated		Coated											Uncoated		Cutting Condition							
		CN1500	CN2500	CC1500	CC2500	NC3215P	NC3225P	NC3215	NC3225	NC3120	NC3030	NC3235	NC5330	NC6310	NC6315	NC9115	NC9125	NC9135	PC8105	PC8110	PC8115	PC9030	H01	H05	f <sub>n</sub> (mm/rev)	a <sub>p</sub> (mm)
Finishing 	VNMG 160404-VB	●	●	●	●			●	●			●													0.10-0.35	0.30-1.50
	160408-VB	●	●	●	●			●	●			●													0.15-0.45	0.50-2.00
	160412-VB							●	●																0.20-0.45	0.80-2.50
Finishing 	VNMG 160402-VF									●														0.06-0.20	0.30-1.00	
	160404-VF	●								●		●							●					0.08-0.30	0.50-1.50	
	160408-VF	●								●	●	●												0.10-0.40	0.50-1.50	
	160412-VF									●	●	●												0.15-0.50	0.50-1.50	
Finishing 	VNMG 160404-VL	●	●					●	●			●												0.05-0.20	0.10-1.00	
	160408-VL	●	●					●	●			●												0.10-0.25	0.20-1.50	
	160412-VL							●	●															0.15-0.30	0.50-2.00	
Medium to finishing 	VNMG 160404-LP							●	●															0.10-0.35	0.30-1.50	
	160408-LP							●	●															0.10-0.40	0.50-2.00	
	160412-LP							●	●															0.10-0.45	0.80-2.50	
Medium to finishing 	VNMG 160404-CP					●	●																	0.10-0.35	0.5-3.0	
	160408-CP					●	●																	0.12-0.30	0.5-3.0	
	160412-CP					●	●																	0.13-0.30	0.8-3.0	
Medium to finishing 	VNMG 160404-VC	●	●					●	●															0.10-0.35	0.30-2.00	
	160408-VC	●						●	●															0.15-4.00	0.50-3.00	
	160412-VC							●	●															0.15-0.40	0.80-3.00	
Medium cutting 	VNMG 160404-HM									●	●										●		0.13-0.40	0.80-3.80		
	160408-HM									●	●	●										●		0.20-0.45	0.80-4.50	
	160412-HM									●	●													0.10-0.60	1.00-4.00	
Medium cutting 	VNMG 160404-MP							●	●			●		●	●	●	●	●	●	●				0.10-0.40	0.40-3.50	
	160408-MP							●	●			●	●	●	●	●	●	●	●	●	●			0.15-0.45	0.50-4.00	
	160412-MP							●	●			●												0.15-0.50	0.80-4.50	
	160416-MP											●												0.18-0.50	1.00-4.50	

Cutting edge geometry A52-A61  
 Recommended chip breaker B04-B14  
 Code system B34-B35  
 ● : Stock item

Available tool holders			
Designation	Page	Designation	Page
MVJNR/L	B188	MVVNN	B189
MVQNR/L	B189	MVUNR/L	B214







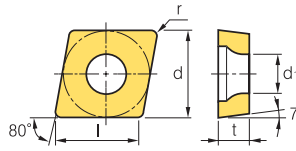











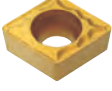





Dimensions (mm)			
Size	d	t	d <sub>1</sub>
06	6.35	2.38	2.8
09	9.525	3.97	4.4
12	12.7	4.76	5.5

## Rhombic **80° Positive** Relief Angle: 7°

Workpiece	Machining types															
	P	M	K	N	S	H	●	●	●	●	●	●	●	●	●	●
Steel	●	●	●	●	●	●	●	●	●	●	●	●	●	●	●	●
Stainless steel	●	●	●	●	●	●	●	●	●	●	●	●	●	●	●	●
Cast iron	●	●	●	●	●	●	●	●	●	●	●	●	●	●	●	●
Non-ferrous metal	●	●	●	●	●	●	●	●	●	●	●	●	●	●	●	●
Heat resistant alloy, Titanium alloy	●	●	●	●	●	●	●	●	●	●	●	●	●	●	●	●
Hardened steel	●	●	●	●	●	●	●	●	●	●	●	●	●	●	●	●

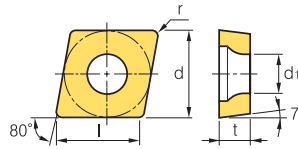
Inserts	Designation	Cermet		Coated		Coated										Uncoated		Cutting Condition											
		CN1500	CN2500	CC1500	CC2500	NC3215	NC3225	NC3120	NC3030	NC3235	NC5330	NC6310	NC6315	NC9115	NC9125	NC9135	PC5300	PC5400	PC8105	PC8110	PC8115	PC9030	H01	H05	f <sub>n</sub> (mm/rev)	a <sub>p</sub> (mm)			
Finishing (Mild steel)	FP  [Mild steel]	CCMT 060202-FP	●																							0.01 - 0.10	0.05 - 0.08		
		CCMT 060204-FP	●	●	●	●	●	●						●							●						0.01 - 0.10	0.10 - 0.90	
		CCMT 09T302-FP	●				●	●																				0.01 - 0.10	0.05 - 1.00
		CCMT 09T304-FP	●	●	●	●	●	●						●								●						0.01 - 0.10	0.10 - 1.00
		CCMT 09T308-FP	●	●	●	●	●	●						●								●						0.04 - 0.12	0.10 - 1.00
Finishing	VF 	CCMT 060202-VF					●									●				●						0.05-0.20	0.30-1.00		
		CCMT 060204-VF	●	●			●										●				●						0.10-0.25	0.30-1.00	
		CCMT 09T302-VF					●																				0.04-0.16	0.80-1.50	
		CCMT 09T304-VF	●	●			●										●				●						0.05-0.20	0.30-1.50	
		CCMT 09T308-VF		●			●				●						●											0.10-0.25	0.30-1.50
		CCMT 120404-VF					●																					0.07-0.22	0.10-2.00
Finishing	VL 	CCMT 060202-VL																									0.04-0.18	0.20-1.40	
		CCMT 060204-VL	●	●	●	●	●	●				●		●	●	●	●	●	●	●	●	●	●	●	●	●	0.04-0.10	0.08-0.90	
		CCMT 060208-VL					●	●				●		●	●													0.06-0.12	0.10-1.00
		CCMT 09T304-VL	●	●	●	●	●	●				●		●	●	●	●	●	●	●	●	●	●	●	●	●	●	0.05-0.10	0.10-1.00
		CCMT 09T308-VL	●	●	●	●	●	●				●		●	●	●	●	●	●	●	●	●	●	●	●	●	●	0.08-0.15	0.10-1.00
		CCMT 120404-VL																										0.06-0.12	0.30-1.50
		CCMT 120408-VL																										0.08-0.15	0.30-1.50
		CCMT 120412-VL																										0.08-0.15	0.30-1.50
Medium to finishing	HMP 	CCMT 060202-HMP	●													●				●		●				0.03-0.12	0.10-1.50		
		CCMT 060204-HMP		●						●	●		●				●				●		●				0.06-0.17	0.20-2.40	
		CCMT 060208-HMP								●	●		●				●				●		●				0.08-0.23	0.40-2.40	
		CCMT 09T302-HMP																									0.07-0.22	0.10-2.00	
		CCMT 09T304-HMP		●						●	●		●	●			●				●		●				0.08-0.23	0.30-3.00	
		CCMT 09T308-HMP		●						●	●		●	●			●				●		●				0.10-0.30	0.50-3.00	
		CCMT 120404-HMP							●	●		●	●				●				●		●				0.09-0.27	0.30-3.60	
		CCMT 120408-HMP								●	●		●	●			●				●		●				0.24-0.36	1.00-3.60	
		CCMT 120412-HMP																										0.14-0.43	0.70-3.60
Medium to finishing	MP 	CCMT 060202-MP	●	●	●	●	●	●				●		●	●	●	●	●	●	●	●	●	●	●	●	●	0.04-0.12	0.20-1.50	
		CCMT 060204-MP	●	●	●	●	●	●				●		●	●	●	●	●	●	●	●	●	●	●	●	●	0.05-0.15	0.30-1.50	
		CCMT 060208-MP													●												0.07-0.15	0.50-2.00	
		CCMT 09T302-MP	●	●	●	●	●	●				●		●	●	●	●	●	●	●	●	●	●	●	●	●	●	0.07-0.15	0.30-2.00
		CCMT 09T304-MP	●	●	●	●	●	●				●	●	●	●	●	●	●	●	●	●	●	●	●	●	●	●	0.08-0.25	0.50-2.50
		CCMT 09T308-MP	●	●	●	●	●	●				●	●	●	●	●	●	●	●	●	●	●	●	●	●	●	●	0.10-0.30	0.50-2.50
		CCMT 120404-MP								●				●	●													0.10-0.30	0.50-3.50
		CCMT 120408-MP								●				●	●													0.15-0.35	0.80-3.50
		CCMT 120412-MP															●	●										0.25-0.40	1.00-3.50

➡ Cutting edge geometry A52-A61
➡ Recommended chip breaker B04-B14
➡ Code system B34-B35
● : Stock item

Available tool holders			
Designation	Page	Designation	Page
SCACR/L	B123, 190	SCLCR/L	B123, 190, 215, 225



# B Turning Insert (Positive)



Dimensions (mm)			
Size	d	t	d <sub>1</sub>
06	6.35	2.38	2.8
09	9.525	3.97	4.4
12	12.7	4.76	5.5

**Rhombic 80° Positive**  
Relief Angle: 7°

Workpiece	Material Compatibility												Machining types					
	P	M	K	N	S	H												
Steel	●	●	●	●	●	●	●	●	●	●	●	●	●	●	●	●	●	●
Stainless steel	●	●	●	●	●	●	●	●	●	●	●	●	●	●	●	●	●	●
Cast iron	●	●	●	●	●	●	●	●	●	●	●	●	●	●	●	●	●	●
Non-ferrous metal	●	●	●	●	●	●	●	●	●	●	●	●	●	●	●	●	●	●
Heat resistant alloy, Titanium alloy	●	●	●	●	●	●	●	●	●	●	●	●	●	●	●	●	●	●
Hardened steel	●	●	●	●	●	●	●	●	●	●	●	●	●	●	●	●	●	●

Inserts	Designation	Cermet		Coated		Coated										Uncoated		Cutting Condition										
		CN1500	CN2500	CC1500	CC2500	NC3215	NC3225	NC3120	NC3030	NC3235	NC5330	NC6310	NC6315	NC9115	NC9125	NC9135	PC5300	PC5400	PC8105	PC8110	PC8115	PC9030	H01	H05	f <sub>n</sub> (mm/rev)	a <sub>p</sub> (mm)		
Medium cutting	C25	CCMT	060202-C25	●	●	●	●	●	●	●	●	●	●	●	●	●	●	●	●	●	●	●	●	●	●	0.03-0.12	0.40-2.00	
		CCMT	060204-C25	●	●	●	●	●	●	●	●	●	●	●	●	●	●	●	●	●	●	●	●	●	●	●	0.05-0.15	0.60-2.30
		CCMT	060208-C25	●	●	●	●	●	●	●	●	●	●	●	●	●	●	●	●	●	●	●	●	●	●	●	0.07-0.20	0.80-2.30
		CCMT	09T302-C25	●	●	●	●	●	●	●	●	●	●	●	●	●	●	●	●	●	●	●	●	●	●	●	0.05-0.20	0.50-2.50
		CCMT	09T304-C25	●	●	●	●	●	●	●	●	●	●	●	●	●	●	●	●	●	●	●	●	●	●	●	0.08-0.25	0.80-3.00
		CCMT	09T308-C25	●	●	●	●	●	●	●	●	●	●	●	●	●	●	●	●	●	●	●	●	●	●	●	0.10-0.30	1.00-3.00
		CCMT	120404-C25	●	●	●	●	●	●	●	●	●	●	●	●	●	●	●	●	●	●	●	●	●	●	●	0.10-0.32	0.80-3.00
		CCMT	120408-C25	●	●	●	●	●	●	●	●	●	●	●	●	●	●	●	●	●	●	●	●	●	●	●	0.12-0.36	1.20-3.50
		CCMT	120412-C25	●	●	●	●	●	●	●	●	●	●	●	●	●	●	●	●	●	●	●	●	●	●	●	0.15-0.40	1.40-3.50
Finishing	VP1	CCMT	060204-VP1	●	●	●	●	●	●	●	●	●	●	●	●	●	●	●	●	●	●	●	●	●	●	0.06-0.12	0.10-1.50	
		CCMT	09T304-VP1	●	●	●	●	●	●	●	●	●	●	●	●	●	●	●	●	●	●	●	●	●	●	0.06-0.20	0.10-1.50	
		CCMT	09T308-VP1	●	●	●	●	●	●	●	●	●	●	●	●	●	●	●	●	●	●	●	●	●	●	0.08-0.20	0.50-2.00	
		CCMT	120404-VP1	●	●	●	●	●	●	●	●	●	●	●	●	●	●	●	●	●	●	●	●	●	●	0.08-0.22	0.20-2.00	
		CCMT	120408-VP1	●	●	●	●	●	●	●	●	●	●	●	●	●	●	●	●	●	●	●	●	●	●	0.10-0.25	0.50-2.00	
Finishing	FS	CCGT	060201-FS	●	●	●	●	●	●	●	●	●	●	●	●	●	●	●	●	●	●	●	●	●	●	0.01-0.18	0.03-1.60	
		CCGT	060202-FS	●	●	●	●	●	●	●	●	●	●	●	●	●	●	●	●	●	●	●	●	●	●	0.02-0.20	0.04-1.70	
		CCGT	060204-FS	●	●	●	●	●	●	●	●	●	●	●	●	●	●	●	●	●	●	●	●	●	●	0.04-0.21	0.06-1.80	
		CCGT	09T301-FS	●	●	●	●	●	●	●	●	●	●	●	●	●	●	●	●	●	●	●	●	●	●	0.01-0.20	0.04-1.80	
		CCGT	09T302-FS	●	●	●	●	●	●	●	●	●	●	●	●	●	●	●	●	●	●	●	●	●	●	0.02-0.23	0.05-2.00	
		CCGT	09T304-FS	●	●	●	●	●	●	●	●	●	●	●	●	●	●	●	●	●	●	●	●	●	●	0.04-0.23	0.08-2.00	
		CCGT	09T308-FS	●	●	●	●	●	●	●	●	●	●	●	●	●	●	●	●	●	●	●	●	●	●	0.06-0.25	0.10-2.20	
Finishing	FS	CCGT	060201MFN-FS	●	●	●	●	●	●	●	●	●	●	●	●	●	●	●	●	●	●	●	●	●	●	0.01-0.18	0.03-1.60	
		CCGT	060202MFN-FS	●	●	●	●	●	●	●	●	●	●	●	●	●	●	●	●	●	●	●	●	●	●	0.02-0.20	0.04-1.70	
		CCGT	060204MFN-FS	●	●	●	●	●	●	●	●	●	●	●	●	●	●	●	●	●	●	●	●	●	●	0.04-0.21	0.06-1.80	
		CCGT	09T301MFN-FS	●	●	●	●	●	●	●	●	●	●	●	●	●	●	●	●	●	●	●	●	●	●	0.01-0.20	0.04-1.80	
		CCGT	09T302MFN-FS	●	●	●	●	●	●	●	●	●	●	●	●	●	●	●	●	●	●	●	●	●	●	0.02-0.23	0.05-2.00	
		CCGT	09T304MFN-FS	●	●	●	●	●	●	●	●	●	●	●	●	●	●	●	●	●	●	●	●	●	●	0.04-0.23	0.08-2.00	
Medium cutting	MS	CCGT	09T301-MS	●	●	●	●	●	●	●	●	●	●	●	●	●	●	●	●	●	●	●	●	●	●	0.02-0.23	0.05-2.00	
		CCGT	09T302-MS	●	●	●	●	●	●	●	●	●	●	●	●	●	●	●	●	●	●	●	●	●	●	0.03-0.25	0.07-2.50	
		CCGT	09T304-MS	●	●	●	●	●	●	●	●	●	●	●	●	●	●	●	●	●	●	●	●	●	●	0.05-0.25	0.09-2.50	
Medium cutting	MS	CCGT	09T301MFN-MS	●	●	●	●	●	●	●	●	●	●	●	●	●	●	●	●	●	●	●	●	●	●	0.02-0.23	0.05-2.00	
		CCGT	09T302MFN-MS	●	●	●	●	●	●	●	●	●	●	●	●	●	●	●	●	●	●	●	●	●	●	0.03-0.25	0.07-2.50	
		CCGT	09T304MFN-MS	●	●	●	●	●	●	●	●	●	●	●	●	●	●	●	●	●	●	●	●	●	●	0.05-0.25	0.09-2.50	

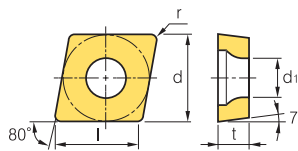
➤ Cutting edge geometry A52-A61   ➤ Recommended chip breaker B04-B14   ➤ Code system B34-B35   ● : Stock item

Available tool holders			
Designation	Page	Designation	Page
SCACR/L	B123, 190	SCLCR/L	B123, 190, 215, 225





# B Turning Insert (Positive)



Dimensions (mm)			
Size	d	t	d <sub>1</sub>
*03	3.5	1.39	1.9
*04	4.3	1.79	2.3
06	6.35	2.38	2.8
09	9.525	3.97	4.4

**Rhombic 80° Positive**  
Relief Angle: 7°

\*: The d and t are special dimensions.

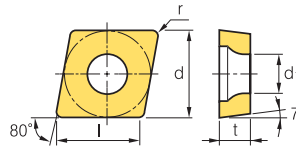
Workpiece	Machining types												
	P	M	K	N	S	H							
Steel	●	●	●	●	●	●	●	●	●	●	●	●	●
Stainless steel	●	●	●	●	●	●	●	●	●	●	●	●	●
Cast iron	●	●	●	●	●	●	●	●	●	●	●	●	●
Non-ferrous metal	●	●	●	●	●	●	●	●	●	●	●	●	●
Heat resistant alloy, Titanium alloy	●	●	●	●	●	●	●	●	●	●	●	●	●
Hardened steel	●	●	●	●	●	●	●	●	●	●	●	●	●

Inserts	Designation	Cermet		Coated		Coated										Uncoated		Cutting Condition										
		CN1500	CN2500	CC1500	CC2500	NC3215	NC3225	NC3120	NC3030	NC3235	NC5330	NC6310	NC6315	NC9115	NC9125	NC9135	PC5300	PC5400	PC8105	PC8110	PC8115	PC9030	H01	H05	f <sub>n</sub> (mm/rev)	a <sub>p</sub> (mm)		
Finishing  [High precision]	*CCGT															●				●						0.01-0.05	0.10-0.30	
	0301003R-KF															●				●							0.01-0.05	0.10-0.30
	030101R-KF															●				●							0.01-0.05	0.10-0.30
	030102R-KF															●				●							0.01-0.05	0.10-0.30
	030104R-KF															●				●							0.01-0.05	0.10-0.30
	0401003R-KF															●				●							0.01-0.10	0.10-0.50
	040101R-KF															●				●							0.01-0.10	0.10-0.50
	040102R-KF															●				●							0.01-0.10	0.10-0.50
	040104R-KF															●				●							0.01-0.10	0.10-0.50
	0602003R-KF																										0.01-0.06	0.04-1.30
	060201R-KF																										0.02-0.08	0.05-1.50
	060202R-KF																										0.03-0.11	0.06-1.70
	09T3003R-KF																										0.02-0.08	0.05-1.50
	09T301R-KF																										0.03-0.11	0.06-1.70
	09T302R-KF																										0.04-0.15	0.08-2.00
	0301003L-KF																●				●						0.01-0.05	0.10-0.30
	030101L-KF																●				●						0.01-0.05	0.10-0.30
	030102L-KF																●				●						0.01-0.05	0.10-0.30
	030104L-KF																●				●						0.01-0.05	0.10-0.30
	0401003L-KF																●				●						0.01-0.10	0.10-0.50
040101L-KF																●				●						0.01-0.10	0.10-0.50	
040102L-KF																●				●						0.01-0.10	0.10-0.50	
040104L-KF																●				●						0.01-0.10	0.10-0.50	
0602003L-KF																										0.01-0.06	0.04-1.30	
060201L-KF																										0.02-0.08	0.05-1.50	
060202L-KF																										0.03-0.11	0.06-1.70	
09T3003L-KF																										0.02-0.08	0.05-1.50	
09T301L-KF																										0.03-0.11	0.06-1.70	
09T302L-KF																										0.04-0.15	0.08-2.00	
Finishing  [Ultra high precision]	CCET															●				●						0.01-0.06	0.04-1.30	
	060201MFR-KF															●				●							0.02-0.08	0.05-1.50
	060202MFR-KF															●				●							0.03-0.11	0.06-1.70
	09T3005MFR-KF															●				●							0.02-0.08	0.05-1.50
	09T301MFR-KF															●				●							0.03-0.11	0.06-1.70
	09T302MFR-KF															●				●							0.04-0.15	0.08-2.00
	0602005MFL-KF															●				●							0.01-0.06	0.04-1.30
	060201MFL-KF															●				●							0.02-0.08	0.05-1.50
	060202MFL-KF															●				●							0.03-0.11	0.06-1.70
	09T3005MFL-KF															●				●							0.02-0.08	0.05-1.50
	09T301MFL-KF															●				●							0.03-0.11	0.06-1.70
	09T302MFL-KF															●				●							0.04-0.15	0.08-2.00

➤ Cutting edge geometry A52-A61   ➤ Recommended chip breaker B04-B14   ➤ Code system B34-B35   ●: Stock item

Available tool holders			
Designation	Page	Designation	Page
SCACR/L	B123, 190	SCLCR/L	B123, 190, 215, 225





Dimensions (mm)			
Size	d	t	d <sub>1</sub>
06	6.35	2.38	2.8
09	9.525	3.97	4.4

## Rhombic 80° Positive Relief Angle: 7°

Workpiece	Machining types															
	P	M	K	N	S	H										
Steel	●	●	●	●	●	●	●	●	●	●	●	●	●	●	●	●
Stainless steel	●	●	●	●	●	●	●	●	●	●	●	●	●	●	●	●
Cast iron	●	●	●	●	●	●	●	●	●	●	●	●	●	●	●	●
Non-ferrous metal	●	●	●	●	●	●	●	●	●	●	●	●	●	●	●	●
Heat resistant alloy, Titanium alloy	●	●	●	●	●	●	●	●	●	●	●	●	●	●	●	●
Hardened steel	●	●	●	●	●	●	●	●	●	●	●	●	●	●	●	●

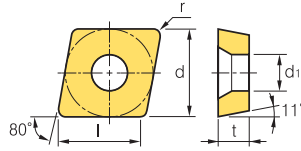
Inserts	Designation	Cermets		Coated		Coated										Uncoated		Cutting Condition										
		CN1500	CN2500	CC1500	CC2500	NC3215	NC3225	NC3120	NC3030	NC3235	NC5330	NC6310	NC6315	NC9115	NC9125	NC9135	PC5300	PC5400	PC8105	PC8110	PC8115	PC9030	H01	H05	f <sub>n</sub> (mm/rev)	a <sub>p</sub> (mm)		
Medium to finishing  [High precision]	CCGT	0602003R-KM														●				●						0.01~0.06	0.04~1.30	
		060201R-KM															●				●						0.02~0.08	0.05~1.50
		060202R-KM															●				●		●				0.03~0.11	0.06~1.70
		060204R-KM															●				●						0.04~0.13	0.04~1.70
		09T3003R-KM															●				●						0.02~0.08	0.06~1.50
		09T301R-KM															●				●						0.03~0.11	0.06~1.70
		09T302R-KM															●				●						0.04~0.15	0.08~2.00
		09T304R-KM															●				●						0.05~0.16	0.10~2.00
		0602003L-KM															●				●						0.01~0.06	0.04~1.30
		060201L-KM															●				●						0.02~0.08	0.05~1.50
		060202L-KM															●				●						0.03~0.11	0.06~1.70
		060204L-KM															●				●						0.04~0.13	0.04~1.70
		09T3003L-KM															●				●						0.02~0.08	0.06~1.50
		09T301L-KM															●				●						0.03~0.11	0.06~1.70
		09T302L-KM															●				●						0.04~0.15	0.08~2.00
	09T304L-KM															●				●						0.05~0.16	0.10~2.00	
Medium to finishing  [Ultra high precision]	CCET	0602005MFR-KM															●			●						0.01~0.06	0.04~1.30	
		060201MFR-KM															●			●						0.02~0.08	0.05~1.50	
		060202MFR-KM															●			●						0.03~0.11	0.06~1.70	
		09T3005MFR-KM															●			●						0.02~0.08	0.05~1.50	
		09T301MFR-KM															●			●						0.03~0.11	0.06~1.70	
		09T302MFR-KM															●			●						0.04~0.15	0.08~2.00	
		0602005MFL-KM															●			●						0.01~0.06	0.04~1.30	
		060201MFL-KM															●			●						0.02~0.08	0.05~1.50	
		060202MFL-KM															●			●						0.03~0.11	0.06~1.70	
		09T3005MFL-KM															●			●						0.02~0.08	0.05~1.50	
		09T301MFL-KM															●			●						0.03~0.11	0.06~1.70	
	09T302MFL-KM															●			●						0.04~0.15	0.08~2.00		

➔ Cutting edge geometry A52~A61
➔ Recommended chip breaker B04~B14
➔ Code system B34~B35
●: Stock item

Available tool holders			
Designation	Page	Designation	Page
SCACR/L	B123, 190	SCLCR/L	B123, 190, 215, 225

# B Turning Insert (Positive)

CP



Dimensions (mm)			
Size	d	t	d <sub>1</sub>
06	6.35	2.38	2.8
08	7.94	2.38	3.4
09	9.525	3.18	4.4

Rhombic **80° Positive**  
Relief Angle: 11°

Workpiece	Machining types																								
	P	M	K	N	S	H	NC3215	NC3225	NC3120	NC3030	NC3235	NC5330	NC6310	NC6315	NC9115	NC9125	NC9135	PC5300	PC5400	PC8105	PC8110	PC8115	PC9030	H01	H05
Steel	●	●	●	●	●	●	●	●	●	●	●	●	●	●	●	●	●	●	●	●	●	●	●	●	●
Stainless steel	●	●	●	●	●	●	●	●	●	●	●	●	●	●	●	●	●	●	●	●	●	●	●	●	●
Cast iron	●	●	●	●	●	●	●	●	●	●	●	●	●	●	●	●	●	●	●	●	●	●	●	●	●
Non-ferrous metal	●	●	●	●	●	●	●	●	●	●	●	●	●	●	●	●	●	●	●	●	●	●	●	●	●
Heat resistant alloy, Titanium alloy	●	●	●	●	●	●	●	●	●	●	●	●	●	●	●	●	●	●	●	●	●	●	●	●	●
Hardened steel	●	●	●	●	●	●	●	●	●	●	●	●	●	●	●	●	●	●	●	●	●	●	●	●	●

Inserts	Designation	Cermet		Coated		Coated														Uncoated		Cutting Condition						
		CN1500	CN2500	CC1500	CC2500	NC3215	NC3225	NC3120	NC3030	NC3235	NC5330	NC6310	NC6315	NC9115	NC9125	NC9135	PC5300	PC5400	PC8105	PC8110	PC8115	PC9030	H01	H05	f <sub>n</sub> (mm/rev)	a <sub>p</sub> (mm)		
Finishing 	CPMT <b>080204-VF</b>																									0.05-0.20	0.30-1.20	
	<b>080208-VF</b>																										0.10-0.25	0.30-1.20
	<b>090304-VF</b>																										0.05-0.20	0.30-1.50
	<b>090308-VF</b>																										0.10-0.25	0.30-1.50
Finishing 	CPMT <b>080204-VL</b>																									0.03-0.08	0.08-1.00	
	<b>080208-VL</b>																										0.04-0.12	0.10-1.00
	<b>090304-VL</b>																										0.05-0.10	0.10-1.00
	<b>090308-VL</b>																										0.08-0.15	0.10-1.00
Medium to finishing 	CPGT <b>090308-HMP</b>																									0.05-0.20	0.70-2.00	
Medium cutting 	CPMT <b>060204-C25</b>																									0.05-0.15	0.60-2.30	
Finishing 	CPGT <b>080202</b>																									0.06-0.20	0.10-2.00	
	<b>080204</b>	●																								0.08-0.20	0.30-2.00	
	<b>080208</b>																									0.10-0.25	0.50-2.00	
	<b>090302</b>																									0.04-0.20	0.30-1.50	
	<b>090304</b>	●																								0.06-0.25	0.50-2.00	
	<b>090308</b>																									0.08-0.30	0.70-2.50	

Cutting edge geometry **A52-A61**
 Recommended chip breaker **B04-B14**
 Code system **B34-B35**
● : Stock item

Available tool holders	
Designation	Page
SCLPR/L	B216







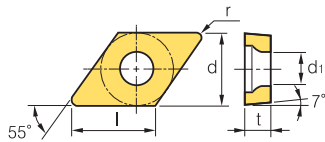




# B Turning Insert (Positive)



DC○○○

 Rhombic **55° Positive**  
Relief Angle: 7°



Dimensions (mm)			
Size	d	t	d <sub>1</sub>
07	6.35	2.38	2.8
11	9.525	3.97	4.4

Workpiece	Machining types															
	P	M	K	N	S	H										
Steel	●	●	●	●	●	●	●	●	●	●	●	●	●	●	●	●
Stainless steel	●	●	●	●	●	●	●	●	●	●	●	●	●	●	●	●
Cast iron	●	●	●	●	●	●	●	●	●	●	●	●	●	●	●	●
Non-ferrous metal	●	●	●	●	●	●	●	●	●	●	●	●	●	●	●	●
Heat resistant alloy, Titanium alloy	●	●	●	●	●	●	●	●	●	●	●	●	●	●	●	●
Hardened steel	●	●	●	●	●	●	●	●	●	●	●	●	●	●	●	●

Inserts	Designation	Cermet		Coated		Coated										Uncoated		Cutting Condition												
		CN1500	CN2500	CC1500	CC2500	NC3215	NC3225	NC3120	NC3030	NC3235	NC5330	NC6310	NC6315	NC9115	NC9125	NC9135	PC5300	PC5400	PC8105	PC8110	PC8115	PC9030	H01	H05	f <sub>n</sub> (mm/rev)	a <sub>p</sub> (mm)				
Medium to finishing  [High precision]	DCGT	0702003R-KM															●									0.01-0.06	0.04-1.30			
		070201R-KM																●										0.02-0.08	0.05-1.50	
		070202R-KM																●										0.03-0.11	0.06-1.50	
		070204R-KM																●										0.04-0.13	0.04-1.70	
		11T3003R-KM																●										0.02-0.08	0.05-1.50	
		11T301R-KM																●										0.03-0.11	0.06-1.70	
		11T302R-KM																●										0.04-0.15	0.08-2.00	
		11T304R-KM																●										0.05-0.16	0.10-2.00	
		0702003L-KM																●											0.01-0.06	0.04-1.30
		070201L-KM																●											0.02-0.08	0.05-1.50
		070202L-KM																●											0.03-0.11	0.06-1.50
		070204L-KM																●											0.04-0.13	0.04-1.70
		11T3003L-KM																●											0.02-0.08	0.05-1.50
		11T301L-KM																●											0.03-0.11	0.06-1.70
		11T302L-KM																●											0.04-0.15	0.08-2.00
11T304L-KM																●											0.05-0.16	0.10-2.00		
Medium to finishing  [Ultra high precision]	DCET	0702005MFR-KM															●										0.01-0.06	0.04-1.30		
		070201MFR-KM																●										0.02-0.08	0.05-1.50	
		070202MFR-KM																●										0.03-0.11	0.06-1.70	
		11T3005MFR-KM																●										0.02-0.08	0.05-1.50	
		11T301MFR-KM																●										0.03-0.11	0.06-1.70	
		11T302MFR-KM																●										0.04-0.15	0.08-2.00	
		0702005MFL-KM																●										0.01-0.06	0.04-1.30	
		070201MFL-KM																●										0.02-0.08	0.05-1.50	
		070202MFL-KM																●										0.03-0.11	0.06-1.70	
		11T3005MFL-KM																●										0.02-0.08	0.05-1.50	
		11T301MFL-KM																●										0.03-0.11	0.06-1.70	
		11T302MFL-KM																●										0.04-0.15	0.08-2.00	

➔ Cutting edge geometry A52-A61   ➔ Recommended chip breaker B04-B14   ➔ Code system B34-B35   ● : Stock item

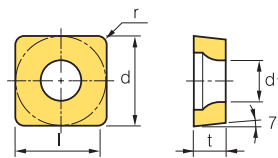
Available tool holders			
Designation	Page	Designation	Page
SDACR/L	B190	SDQCR/L	B217
SDJCR/L	B123, 191	SDUCR/L	B218
SDNCN	B124, 191	SDZCR/L	B219





# B Turning Insert (Positive)



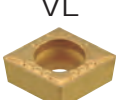



SC ○ ○



Dimensions (mm)			
Size	d	t	d <sub>1</sub>
09	9.525	3.97	4.4
12	12.0	4.76	4.2

**□** Square **90° Positive**  
Relief Angle: 7°

Workpiece	Machining types															
	P	M	K	N	S	H										
Steel	●	●	●	●	●	●	●	●	●	●	●	●	●	●	●	●
Stainless steel	●	●	●	●	●	●	●	●	●	●	●	●	●	●	●	●
Cast iron	●	●	●	●	●	●	●	●	●	●	●	●	●	●	●	●
Non-ferrous metal	●	●	●	●	●	●	●	●	●	●	●	●	●	●	●	●
Heat resistant alloy, Titanium alloy	●	●	●	●	●	●	●	●	●	●	●	●	●	●	●	●
Hardened steel	●	●	●	●	●	●	●	●	●	●	●	●	●	●	●	●

Inserts	Designation	Cermets		Coated												Uncoated		Cutting Condition								
		CN1500	CN2500	CC1500	CC2500	NC3215	NC3225	NC3120	NC3030	NC3235	NC5330	NC6310	NC6315	NC9115	NC9125	NC9135	PC5300	PC5400	PC8105	PC8110	PC8115	PC9030	H01	H05	f <sub>n</sub> (mm/rev)	a <sub>p</sub> (mm)
Finishing  [Mild steel]	SCMT 09T304-FP	●	●	●	●	●	●	●	●	●	●	●	●	●	●	●	●	●	●	●	●	●	●	●	0.01-0.10	0.10-1.00
	09T308-FP	●	●	●	●	●	●	●	●	●	●	●	●	●	●	●	●	●	●	●	●	●	●	●	0.04-0.12	0.10-1.00
Finishing 	SCMT 09T304-VF	●	●	●	●	●	●	●	●	●	●	●	●	●	●	●	●	●	●	●	●	●	●	0.05-0.20	0.30-1.50	
Finishing 	SCMT 09T304-VL	●	●	●	●	●	●	●	●	●	●	●	●	●	●	●	●	●	●	●	●	●	●	0.05-0.10	0.10-1.00	
	09T308-VL	●	●	●	●	●	●	●	●	●	●	●	●	●	●	●	●	●	●	●	●	●	●	0.08-0.15	0.10-1.00	
Medium to finishing 	SCMT 09T304-HMP	●	●	●	●	●	●	●	●	●	●	●	●	●	●	●	●	●	●	●	●	●	●	0.08-0.23	0.30-3.00	
	09T308-HMP	●	●	●	●	●	●	●	●	●	●	●	●	●	●	●	●	●	●	●	●	●	●	0.10-0.30	0.50-3.00	
	120404-HMP	●	●	●	●	●	●	●	●	●	●	●	●	●	●	●	●	●	●	●	●	●	●	0.09-0.27	0.30-3.60	
	120408-HMP	●	●	●	●	●	●	●	●	●	●	●	●	●	●	●	●	●	●	●	●	●	●	0.12-0.36	0.60-3.60	
Medium to finishing 	SCMT 09T304-MP	●	●	●	●	●	●	●	●	●	●	●	●	●	●	●	●	●	●	●	●	●	●	0.05-0.25	0.30-2.80	
	09T308-MP	●	●	●	●	●	●	●	●	●	●	●	●	●	●	●	●	●	●	●	●	●	●	0.10-0.30	0.50-2.80	
	120404-MP	●	●	●	●	●	●	●	●	●	●	●	●	●	●	●	●	●	●	●	●	●	●	0.10-0.30	0.50-2.80	
	120408-MP	●	●	●	●	●	●	●	●	●	●	●	●	●	●	●	●	●	●	●	●	●	●	0.15-0.35	0.80-3.50	
	120412-MP	●	●	●	●	●	●	●	●	●	●	●	●	●	●	●	●	●	●	●	●	●	●	0.25-0.40	1.00-3.50	
Medium to finishing 	SCMT 060204-C25	●	●	●	●	●	●	●	●	●	●	●	●	●	●	●	●	●	●	●	●	●	●	0.08-0.25	0.40-2.50	
	09T304-C25	●	●	●	●	●	●	●	●	●	●	●	●	●	●	●	●	●	●	●	●	●	●	0.08-0.25	0.60-3.00	
	09T308-C25	●	●	●	●	●	●	●	●	●	●	●	●	●	●	●	●	●	●	●	●	●	●	0.10-0.30	1.00-3.00	
	120404-C25	●	●	●	●	●	●	●	●	●	●	●	●	●	●	●	●	●	●	●	●	●	●	0.10-0.30	0.80-3.80	
	120408-C25	●	●	●	●	●	●	●	●	●	●	●	●	●	●	●	●	●	●	●	●	●	●	0.12-0.38	1.20-3.80	

➔ Cutting edge geometry A52~A61   ➔ Recommended chip breaker B04~B14   ➔ Code system B34~B35   ●: Stock item

Available tool holders			
Designation	Page	Designation	Page
SSBCR/L	B192	SSKCR/L	B193, 219
SSDCN	B192	SSSCR/L	B193, 245

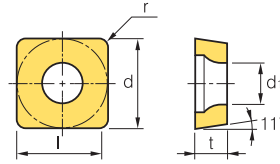






# B Turning Insert (Positive)

SP ○○



Dimensions (mm)			
Size	d	t	d <sub>1</sub>
06	6.35	2.38	2.8
07	6.35	2.38	2.8
09	9.525	3.18	3.4-4.4
12	12.7	3.18	-
15	15.875	4.76	-
19	19.05	4.76	-

**□ Square 90° Positive**  
Relief Angle: 11°

Workpiece	Material	Machining types															
		●	✱	●	✱	●	✱	●	✱	●	✱	●	✱	●	✱	●	✱
Steel	<b>P</b>	●	✱	●	✱	●	✱	●	✱	●	✱	●	✱	●	✱	●	✱
Stainless steel	<b>M</b>	●	✱	●	✱	●	✱	●	✱	●	✱	●	✱	●	✱	●	✱
Cast iron	<b>K</b>	●	✱	●	✱	●	✱	●	✱	●	✱	●	✱	●	✱	●	✱
Non-ferrous metal	<b>N</b>																
Heat resistant alloy, Titanium alloy	<b>S</b>																
Hardened steel	<b>H</b>																

Inserts	Designation	Cermet		Coated		Coated												Uncoated		Cutting Condition								
		CN1500	CN2500	CC1500	CC2500	NC3215	NC3225	NC3120	NC3030	NC3235	NC5330	NC6310	NC6315	NC9115	NC9125	NC9135	PC5300	PC5400	PC8105	PC8110	PC8115	PC9030	H01	H05	f <sub>n</sub> (mm/rev)	a <sub>p</sub> (mm)		
Medium to finishing	SPGN	070202																								0.03-0.10	0.50-2.00	
		070208																								0.10-0.25	0.70-3.00	
		090302																									0.03-0.10	0.50-3.00
		090304																									0.08-0.20	0.70-3.50
		090308																									0.10-0.25	0.70-3.50
		120302																									0.03-0.20	0.50-3.00
		120304																									0.08-0.20	1.00-5.00
		120308							●																		0.10-0.25	1.00-5.00
		120312																									0.15-0.30	1.00-5.00
		120316																									0.18-0.33	1.00-5.00
		120402																									0.03-0.20	0.50-3.00
		120404																									0.08-0.20	1.00-5.00
		120408																									0.10-0.25	1.00-5.00
		120412																									0.15-0.30	1.00-5.00
		120416																									0.18-0.33	1.00-5.00
		120430																									0.20-0.60	2.00-5.00
		120440																									0.25-0.70	3.00-5.00
		150404																									0.08-0.20	1.50-7.00
		150408																									0.10-0.25	1.50-7.00
		150412																									0.15-0.30	1.50-7.00
150416																									0.18-0.33	1.50-7.00		
150420																									0.20-0.45	1.50-7.00		
190404																									0.08-0.20	1.50-9.00		
190408																									0.10-0.25	1.50-9.00		
190412																									0.15-0.45	1.50-9.00		
190416																									0.18-0.60	1.50-9.00		
190424																									0.25-0.70	2.50-9.00		
Medium to finishing	SPGA	060204																								0.50-0.25	0.50-2.00	
		090308T	●																							0.10-0.25	0.70-3.00	
		090308T-Z																								0.10-0.25	0.70-3.00	
Medium to finishing	SPGT	090304R																								0.08-0.23	0.30-3.00	
		090308R																								0.10-0.30	0.50-3.00	
		090304L																								0.08-0.23	0.30-3.00	
		090308L																								0.10-0.30	0.50-3.00	

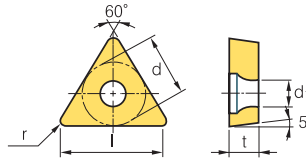
🔄 Cutting edge geometry A52-A61    ⚙️ Recommended chip breaker B04-B14    🔑 Code system B34-B35    ● : Stock item

Available tool holders			
Designation	Page	Designation	Page
CSDPN	B181	SSKPR/L	B219
CSKPR/L	B182		



# TB ○○

Dimensions (mm)			
Size	d	t	d <sub>1</sub>
06	3.97	1.59	2.16



**Triangular 60° Positive**  
Relief Angle: 5°

Workpiece	Machining types															
	P	M	K	N	S	H	●	⊙	⊚	⊛	⊜	⊝	⊞	⊟	⊠	⊡
Steel	●	●	●	●	●	●	●	●	●	●	●	●	●	●	●	●
Stainless steel	●	●	●	●	●	●	●	●	●	●	●	●	●	●	●	●
Cast iron	●	●	●	●	●	●	●	●	●	●	●	●	●	●	●	●
Non-ferrous metal	●	●	●	●	●	●	●	●	●	●	●	●	●	●	●	●
Heat resistant alloy, Titanium alloy	●	●	●	●	●	●	●	●	●	●	●	●	●	●	●	●
Hardened steel	●	●	●	●	●	●	●	●	●	●	●	●	●	●	●	●

Inserts	Designation	Cermet		Coated														Uncoated		Cutting Condition							
		CN1500	CN2500	CC1500	CC2500	NC3215	NC3225	NC3120	NC3030	NC3235	NC5330	NC6310	NC6315	NC9115	NC9125	NC9135	PC5300	PC5400	PC8105	PC8110	PC8115	PC9030	H01	H05	f <sub>n</sub> (mm/rev)	a <sub>p</sub> (mm)	
Finishing	VL 	TBMT	060102-VL																							0.03-0.06	0.05-0.60
		TBGT	060102L																				●	●	0.05-0.20	0.10-1.30	
Finishing			060104L																							0.08-0.20	0.10-1.30

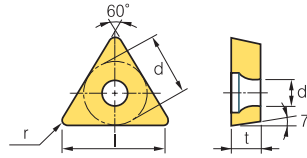
➡ Cutting edge geometry A52-A61
➡ Recommended chip breaker B04-B14
➡ Code system B34-B35
● : Stock item

적용홀더	
Designation	Page
STUBR/L	B225

# B Turning Insert (Positive)






TC ○○

 **Triangular 60° Positive**  
Relief Angle: 7°



Dimensions (mm)			
Size	d	t	d <sub>1</sub>
06	6.35	2.38	2.8
09	5.56	2.38	2.5
11	6.35	2.38	2.8
16	9.523	3.97	4.4
22	12.7	4.76	-

Workpiece	Material Compatibility																Machining types		
	P	M	K	N	S	H													
Steel	●	●	●	●	●	●	●	●	●	●	●	●	●	●	●	●	●	●	●
Stainless steel	●	●	●	●	●	●	●	●	●	●	●	●	●	●	●	●	●	●	●
Cast iron	●	●	●	●	●	●	●	●	●	●	●	●	●	●	●	●	●	●	●
Non-ferrous metal	●	●	●	●	●	●	●	●	●	●	●	●	●	●	●	●	●	●	●
Heat resistant alloy, Titanium alloy	●	●	●	●	●	●	●	●	●	●	●	●	●	●	●	●	●	●	●
Hardened steel	●	●	●	●	●	●	●	●	●	●	●	●	●	●	●	●	●	●	●

Inserts	Designation	Cermet		Coated		Coated													Uncoated		Cutting Condition							
		CN1500	CN2500	CC1500	CC2500	NC3215	NC3225	NC3120	NC3030	NC3235	NC5330	NC6310	NC6315	NC9115	NC9125	NC9135	PC5300	PC5400	PC8105	PC8110	PC8115	PC9030	H01	H05	f <sub>n</sub> (mm/rev)	a <sub>p</sub> (mm)		
Finishing 	TCMT 060201-FP																									0.00-0.08	0.05-0.07	
	110202-FP		●			●																					0.01-0.10	0.05-0.08
	110204-FP		●			●																					0.01-0.10	0.10-0.90
Finishing 	TCMT 110202-VF																									0.03-0.13	0.06-0.70	
	110204-VF																●									0.05-0.20	0.30-1.20	
	110208-VF																●									0.10-0.25	0.30-1.20	
	16T302-VF																									0.05-0.15	0.10-1.30	
	16T304-VF						●				●						●										0.05-0.20	0.30-1.50
Finishing 	TCMT 090208-VL																									0.08-0.20	0.10-1.20	
	110204-VL																										0.05-0.15	0.10-1.30
	110208-VL																										0.08-0.20	0.10-1.30
	16T304-VL	●	●	●	●	●	●						●	●	●	●	●	●	●	●	●	●	●	●	●	0.05-0.20	0.30-1.50	
	16T308-VL	●	●	●	●	●	●				●			●	●		●	●	●	●	●	●	●	●	●	0.05-0.20	0.30-1.50	
Medium to finishing 	TCMT 090204-HMP								●																	0.06-0.17	0.20-2.30	
	090208-HMP																										0.08-0.23	0.40-2.30
	110202-HMP																										0.03-0.15	0.10-1.50
	110204-HMP		●				●	●	●		●						●			●		●					0.06-0.19	0.20-2.50
	110208-HMP										●						●						●				0.09-0.26	0.40-2.50
	16T304-HMP		●								●	●					●			●		●					0.08-0.23	0.30-3.00
	16T308-HMP										●	●					●					●					0.10-0.30	0.50-3.00
Medium to finishing 	TCMT 090204-MP													●	●	●										0.05-0.18	0.10-1.00	
	090208-MP																										0.08-0.20	0.10-1.20
	110202-MP							●	●			●									●	●					0.03-0.12	0.20-1.50
	110204-MP							●	●			●									●	●					0.05-0.15	0.20-1.50
	110208-MP							●	●			●									●	●					0.10-0.28	0.25-2.00
	16T302-MP																										0.08-0.25	0.20-1.50
	16T304-MP	●	●	●	●		●	●			●			●	●	●	●	●	●	●	●	●	●	●	●	0.08-0.20	0.30-2.50	
	16T308-MP	●	●	●	●		●	●			●	●	●	●	●	●	●	●	●	●	●	●	●	●	●	0.10-0.30	0.50-2.50	
	16T312-MP							●	●			●					●					●					0.20-0.40	0.50-2.50
	220408-MP																										0.20-0.40	0.50-3.50

 Cutting edge geometry A52-A61  
  Recommended chip breaker B04-B14  
  Code system B34-B35  
 ● : Stock item

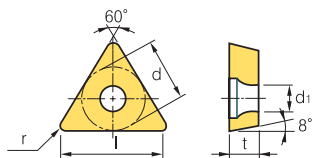
Available tool holders			
Designation	Page	Designation	Page
STACR/L	B124, 193	STTCR/L	B194, 246
STFCR/L	B194, 245	STWCR/L	B246
STGCR/L	B194		





# B Turning Insert (Positive)

## TO



Dimensions (mm)			
Size	d	t	d <sub>1</sub>
06	3.97	1.59	2.15
09	5.56	2.38	2.8
14	8.2	3.0	3.8

**Triangular 60° Positive**  
Relief Angle: 8°

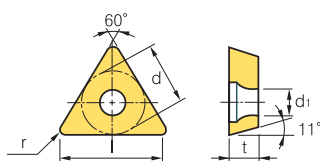
Workpiece	Machining types												
	P	M	K	N	S	H							
Steel	●	●	●	●	●	●	●	●	●	●	●	●	●
Stainless steel	●	●	●	●	●	●	●	●	●	●	●	●	●
Cast iron	●	●	●	●	●	●	●	●	●	●	●	●	●
Non-ferrous metal	●	●	●	●	●	●	●	●	●	●	●	●	●
Heat resistant alloy, Titanium alloy	●	●	●	●	●	●	●	●	●	●	●	●	●
Hardened steel	●	●	●	●	●	●	●	●	●	●	●	●	●

Inserts	Designation	Cermet		Coated										Uncoated		Cutting Condition												
		CN1500	CN2500	CC1500	CC2500	NC3215	NC3225	NC3120	NC3030	NC3235	NC5330	NC6310	NC6315	NC9115	NC9125	NC9135	PC5300	PC5400	PC8105	PC8110	PC8115	PC9030	H01	H05	f <sub>n</sub> (mm/rev)	a <sub>p</sub> (mm)		
Medium to finishing	TOEH	060102L																								0.05-0.17	0.10-1.50	
		090204L																									0.05-0.20	0.30-2.50
		140304L																									0.05-0.25	0.30-2.50

⌚ Cutting edge geometry A52-A61    ⌚ Recommended chip breaker B04-B14    ⌚ Code system B34-B35    ● : Stock item

Available tool holders			
Designation	Page	Designation	Page
STFPR/L	B221	STUPR/L	B226
CTFPR/L	B182	CTGPR/L	B182

## TP



Dimensions (mm)			
Size	d	t	d <sub>1</sub>
09	5.56	2.38	3.0
11	6.35	3.18	3.4
16	9.525	3.18-4.76	4.4

**Triangular 60° Positive**  
Relief Angle: 11°

Workpiece	Machining types												
	P	M	K	N	S	H							
Steel	●	●	●	●	●	●	●	●	●	●	●	●	●
Stainless steel	●	●	●	●	●	●	●	●	●	●	●	●	●
Cast iron	●	●	●	●	●	●	●	●	●	●	●	●	●
Non-ferrous metal	●	●	●	●	●	●	●	●	●	●	●	●	●
Heat resistant alloy, Titanium alloy	●	●	●	●	●	●	●	●	●	●	●	●	●
Hardened steel	●	●	●	●	●	●	●	●	●	●	●	●	●

Inserts	Designation	Cermet		Coated										Uncoated		Cutting Condition											
		CN1500	CN2500	CC1500	CC2500	NC3215	NC3225	NC3120	NC3030	NC3235	NC5330	NC6310	NC6315	NC9115	NC9125	NC9135	PC5300	PC5400	PC8105	PC8110	PC8115	PC9030	H01	H05	f <sub>n</sub> (mm/rev)	a <sub>p</sub> (mm)	
Finishing	TPMT	090202-FP	●	●	●	●	●	●	●	●	●	●	●	●	●	●	●	●	●	●	●	●	●	●	●	0.01-0.09	0.05-0.07
		090204-FP	●	●	●	●	●	●	●	●	●	●	●	●	●	●	●	●	●	●	●	●	●	●	●	0.01-0.09	0.10-0.08
		110302-FP	●	●	●	●	●	●	●	●	●	●	●	●	●	●	●	●	●	●	●	●	●	●	●	0.01-0.10	0.05-0.08
		110304-FP	●	●	●	●	●	●	●	●	●	●	●	●	●	●	●	●	●	●	●	●	●	●	●	0.01-0.10	0.10-0.90
		110308-FP	●	●	●	●	●	●	●	●	●	●	●	●	●	●	●	●	●	●	●	●	●	●	●	0.04-0.10	0.10-1.00
		160404-FP	●	●	●	●	●	●	●	●	●	●	●	●	●	●	●	●	●	●	●	●	●	●	●	0.01-0.10	0.10-1.00
		160408-FP	●	●	●	●	●	●	●	●	●	●	●	●	●	●	●	●	●	●	●	●	●	●	●	0.04-0.12	0.10-1.00

⌚ Cutting edge geometry A52-A61    ⌚ Recommended chip breaker B04-B14    ⌚ Code system B34-B35    ● : Stock item

Available tool holders			
Designation	Page	Designation	Page
STFPR/L	B221	STUPR/L	B226
CTFPR/L	B182	CTGPR/L	B182



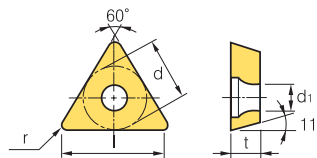




# B Turning Insert (Positive)

## TP ○○

 **Triangular 60° Positive**  
Relief Angle: 11°



Dimensions (mm)			
Size	d	t	d <sub>1</sub>
09	5.56	2.38	-
11	6.35	2.38~3.18	3.4
16	9.525	3.18~4.76	4.4
22	12.7	4.76	-
27	15.875	4.76~6.35	-
33	19.05	7.94~9.52	7.93

Workpiece	Machining types												
	P	M	K	N	S	H							
Steel	●	●	●	●	●	●	●	●	●	●	●	●	●
Stainless steel	●	●	●	●	●	●	●	●	●	●	●	●	●
Cast iron	●	●	●	●	●	●	●	●	●	●	●	●	●
Non-ferrous metal	●	●	●	●	●	●	●	●	●	●	●	●	●
Heat resistant alloy, Titanium alloy	●	●	●	●	●	●	●	●	●	●	●	●	●
Hardened steel	●	●	●	●	●	●	●	●	●	●	●	●	●

Inserts	Designation	Cermets		Coated		Coated													Uncoated		Cutting Condition							
		CN1500	CN2500	CC1500	CC2500	NC3215	NC3225	NC3120	NC3030	NC3235	NC5330	NC6310	NC6315	NC9115	NC9125	NC9135	PC5300	PC5400	PC8105	PC8110	PC8115	PC9030	PC9030	H05	f <sub>n</sub> (mm/rev)	a <sub>p</sub> (mm)		
Medium cutting	M	TPGR	110308-M																							0.13-0.30	1.00-3.00	
			160308-M																									0.13-0.30
Medium to finishing		TPUN	090308																							0.10-0.30	0.50-2.00	
			110208																								0.15-0.40	1.00-3.00
			110304																								0.10-0.30	1.00-3.00
			110308																								0.15-0.40	1.00-3.00
			160304							●																	0.10-0.30	1.00-5.00
			160308							●							●										0.15-0.40	1.00-5.00
			160308TN																								0.15-0.40	1.00-5.00
			160312																								0.20-0.50	1.50-5.00
			160312TN																								0.20-0.50	1.50-5.00
			220404																								0.10-0.30	1.50-7.00
			220408									●															0.15-0.40	1.50-7.00
			220412																								0.20-0.50	1.50-7.00
			220412TN																								0.20-0.50	1.50-7.00
			330620																								0.30-0.70	3.00-10.00
Medium to finishing		TPGN	090204																						0.07-0.20	0.70-2.00		
			110302																						●	0.05-0.15	0.50-2.00	
			110304									●													●	0.07-0.20	0.70-3.00	
			110308									●													●	0.10-0.25	1.00-3.00	
			160302																							●	0.05-0.18	1.00-5.00
			160304								●		●												●	0.07-0.20	1.00-5.00	
			160308								●		●												●	0.10-0.25	1.00-5.00	
			160310																							●	0.10-0.25	1.00-5.00
			160312																								0.15-0.30	1.00-5.00
			160316																								0.15-0.30	1.00-5.00
			160404																								0.07-0.20	1.00-5.00
			220404												●												0.07-0.20	1.50-7.00
			220408												●												0.10-0.25	1.50-7.00
			220412												●												0.15-0.30	1.50-7.00
			220430																								0.30-0.45	1.50-7.00
			220440																								0.30-0.50	1.50-7.00
			270408																								0.15-0.25	3.00-8.00
270608																								0.15-0.25	3.00-8.00			

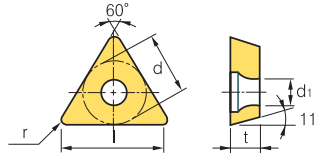
 Cutting edge geometry **A52-A61**
 Recommended chip breaker **B04-B14**
 Code system **B34-B35**
● : Stock item

Available tool holders			
Designation	Page	Designation	Page
STFPR/L	B221	STUPR/L	B226
CTFPR/L	B182	CTGPR/L	B182



# TP

**Triangular 60° Positive**  
Relief Angle: 11°



Dimensions (mm)			
Size	d	t	d <sub>1</sub>
08	4.76	2.38	2.3
09	5.56	2.38	3.0
11	6.35	3.18	3.4
16	9.525	3.18-4.76	4.4

Workpiece	Machining types															
	P	M	K	N	S	H	●	●	●	●	●	●	●	●	●	●
Steel	●	●	●	●	●	●	●	●	●	●	●	●	●	●	●	●
Stainless steel	●	●	●	●	●	●	●	●	●	●	●	●	●	●	●	●
Cast iron	●	●	●	●	●	●	●	●	●	●	●	●	●	●	●	●
Non-ferrous metal	●	●	●	●	●	●	●	●	●	●	●	●	●	●	●	●
Heat resistant alloy, Titanium alloy	●	●	●	●	●	●	●	●	●	●	●	●	●	●	●	●
Hardened steel	●	●	●	●	●	●	●	●	●	●	●	●	●	●	●	●

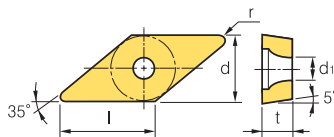
Inserts	Designation	Cermet		Coated														Uncoated		Cutting Condition								
		CN1500	CN2500	CC1500	CC2500	NC3215	NC3225	NC3120	NC3030	NC3235	NC5330	NC6310	NC6315	NC9115	NC9125	NC9135	PC5300	PC5400	PC8105	PC8110	PC8115	PC9030	H01	H05	f <sub>n</sub> (mm/rev)	a <sub>p</sub> (mm)		
Finishing		TPGH 080202L																								0.01-0.12	0.06-1.70	
		080204L	●																							0.01-0.15	0.08-1.70	
		110202L																									0.01-0.12	0.06-2.00
		110204L																									0.01-0.15	0.08-2.00
Medium to finishing		TPGT 080202R																								0.05-0.20	0.30-1.50	
		110302R																								0.05-0.20	0.30-1.50	
		110304R																								0.05-0.20	0.50-2.00	
		110308R																								0.07-0.25	0.50-2.00	
		160404R																								0.05-0.20	0.70-3.00	
		160408R																								0.05-0.20	0.70-3.00	
		080202L																					●	●	0.05-0.20	0.30-1.50		
		110302L																								0.05-0.20	0.30-1.50	
		110304L	●																							0.05-0.20	0.50-2.00	
		110308L																								0.07-0.25	0.50-2.00	
Medium to finishing		TPGX 090202L																								0.10-0.20	0.30-1.00	
		090204L		●																						0.10-0.25	0.50-1.00	
		090208L																								0.10-0.30	1.00-1.00	
		110304L																								0.10-0.25	0.50-1.20	

Cutting edge geometry A52-A61    
 Recommended chip breaker B04-B14    
 Code system B34-B35    
 ● : Stock item

Available tool holders			
Designation	Page	Designation	Page
STFPR/L	B221	STUPR/L	B226
CTFPR/L	B182	CTGPR/L	B182

# B Turning Insert (Positive)

## VB



Dimensions (mm)			
Size	d	t	d <sub>1</sub>
11	6.35	3.18	2.8
16	9.525	4.76	4.4

Rhombic **35° Positive**  
Relief Angle: 5°

Workpiece	Machining types												
	P	M	K	N	S	H							
Steel	●	●	●	●	●	●	●	●	●	●	●	●	●
Stainless steel	●	●	●	●	●	●	●	●	●	●	●	●	●
Cast iron	●	●	●	●	●	●	●	●	●	●	●	●	●
Non-ferrous metal	●	●	●	●	●	●	●	●	●	●	●	●	●
Heat resistant alloy, Titanium alloy	●	●	●	●	●	●	●	●	●	●	●	●	●
Hardened steel	●	●	●	●	●	●	●	●	●	●	●	●	●

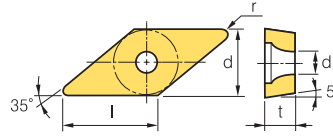
Inserts	Designation	Cermet		Coated		Coated													Uncoated		Cutting Condition							
		CN1500	CN2500	CC1500	CC2500	NC3215	NC3225	NC3120	NC3030	NC3235	NC5330	NC6310	NC6315	NC9115	NC9125	NC9135	PC5300	PC5400	PC8105	PC8110	PC8115	PC9030	H01	H05	f <sub>n</sub> (mm/rev)	a <sub>p</sub> (mm)		
Finishing FP [Mild steel]	VBMT 110302-FP					●																				0.01-0.10	0.05-0.08	
	110304-FP		●			●																					0.01-0.10	0.10-0.90
	110308-FP		●			●																					0.01-0.10	0.10-1.00
	160404-FP	●	●	●	●	●	●							●							●						0.01-0.10	0.10-1.00
	160408-FP	●	●	●	●	●	●							●							●						0.04-0.12	0.10-1.00
Finishing VB	VBMT 110302-VB																									0.05-0.15	0.20-1.20	
	110304-VB																										0.06-0.18	0.20-1.20
	110308-VB																										0.08-0.20	0.60-1.20
	160402-VB																										0.06-0.20	0.05-1.00
	160404-VB	●	●					●																			0.08-0.20	0.20-1.50
	160408-VB	●	●					●																			0.10-0.23	0.50-1.50
Finishing VF	VBMT 160404-VF	●	●					●			●					●				●						0.05-0.20	0.30-1.00	
	160408-VF	●	●													●										0.10-0.25	0.30-1.00	
Finishing VL	VBMT 110302-VL																									0.03-0.20	0.20-1.20	
	110304-VL																										0.04-0.20	0.20-1.20
	110308-VL																										0.08-0.20	0.20-1.20
	160402-VL																										0.03-0.20	0.30-1.50
	160404-VL	●	●	●	●	●	●				●			●	●	●	●	●	●	●	●	●	●				0.05-0.20	0.30-1.50
	160408-VL	●	●	●	●	●	●				●			●	●	●	●	●	●	●	●	●	●				0.10-0.20	0.30-1.50
Medium to finishing HMP	VBMT 110304-HMP									●												●				0.03-0.20	0.15-2.70	
	110308-HMP									●																	0.05-0.25	0.40-2.70
	160404-HMP									●	●			●						●		●					0.07-0.20	0.20-2.70
	160408-HMP									●	●	●		●						●		●					0.09-0.27	0.50-2.70
	160412-HMP									●	●	●		●						●		●					0.11-0.32	0.50-2.70
Medium to finishing MP	VBMT 110302-MP																									0.04-0.14	0.20-1.50	
	110304-MP							●	●					●	●												0.05-0.15	0.20-1.50
	110308-MP							●	●																		0.10-0.28	0.30-2.00
	160402-MP																										0.06-0.16	0.25-2.00
	160404-MP	●	●	●	●	●	●				●	●		●	●	●	●	●	●	●	●	●	●				0.08-0.20	0.30-2.00
	160408-MP	●	●	●	●	●	●				●	●	●	●	●	●	●	●	●	●	●	●	●				0.10-0.25	0.50-2.30
	160412-MP	●	●					●	●				●	●	●	●	●	●	●	●	●	●	●				0.10-0.35	0.50-2.30

Cutting edge geometry A52-A61  
 Recommended chip breaker B04-B14  
 Code system B34-B35  
 ● : Stock item

Available tool holders			
Designation	Page	Designation	Page
SVABR/L	B195	SVVBN	B196
SVHBR/L	B195	SVQBR/L	B222
SVJBR/L	B125, 195	SVUBR/L	B223



## VB



Dimensions (mm)			
Size	d	t	d <sub>1</sub>
11	6.35	2.38-3.18	2.8-3.4
16	9.525	4.76	4.4

**Rhombic 35° Positive**  
Relief Angle: 5°

Workpiece	Machining types											
	P	M	K	N	S	H	●	●	●	●	●	●
Steel	●	●	●	●	●	●	●	●	●	●	●	●
Stainless steel	●	●	●	●	●	●	●	●	●	●	●	●
Cast iron	●	●	●	●	●	●	●	●	●	●	●	●
Non-ferrous metal	●	●	●	●	●	●	●	●	●	●	●	●
Heat resistant alloy, Titanium alloy	●	●	●	●	●	●	●	●	●	●	●	●
Hardened steel	●	●	●	●	●	●	●	●	●	●	●	●

● Continuous cutting  
● General cutting  
● Interrupted cutting

Inserts	Designation	Cermet		Coated		Coated										Uncoated		Cutting Condition									
		CN1500	CN2500	CC1500	CC2500	NC3215	NC3225	NC3120	NC3030	NC3235	NC5330	NC6310	NC6315	NC9115	NC9125	NC9135	PC5300	PC5400	PC8105	PC8110	PC8115	PC9030	H01	H05	f <sub>n</sub> (mm/rev)	a <sub>p</sub> (mm)	
Medium to finishing	VBMT	160404						●	●		●															0.07-0.20	0.50-1.50
		160408					●	●	●		●															0.15-0.25	0.70-2.00
Medium to finishing	VBGT	160404																								0.07-0.20	0.50-1.50
		160408																								0.15-0.25	0.70-2.00
Finishing	VBMT	160402-VP1																								0.04-0.20	0.16-1.50
		160404-VP1																								0.05-0.20	0.18-1.80
		160408-VP1																								0.06-0.20	0.20-1.80
Finishing	VBGT	110301-FS															●			●						0.01-0.16	0.03-1.40
		110302-FS															●			●						0.02-0.18	0.04-1.50
		110304-FS																●			●					0.04-0.19	0.06-1.60
		160401-FS																●			●					0.01-0.16	0.04-1.80
		160402-FS																●			●					0.02-0.18	0.05-2.00
		160404-FS																●			●					0.04-0.19	0.08-2.00
Finishing	VBGT	110301MFN-FS																								0.01-0.16	0.03-1.40
		110302MFN-FS																								0.02-0.18	0.04-1.50
		110304MFN-FS																								0.04-0.19	0.06-1.60
		160401MFN-FS																								0.01-0.16	0.04-1.80
		160402MFN-FS																								0.02-0.18	0.05-2.00
		160404MFN-FS																								0.04-0.19	0.08-2.00
Finishing	VBGT	110302-VP1																								0.03-0.10	0.08-1.50
		160402-VP1																								0.04-0.20	0.16-1.50
		160404-VP1																								0.05-0.20	0.18-1.80

➡ Cutting edge geometry A52-A61
➡ Recommended chip breaker B04-B14
➡ Code system B34-B35
● : Stock item

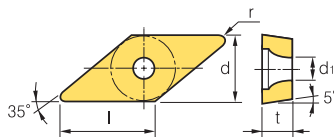
Available tool holders			
Designation	Page	Designation	Page
SVABR/L	B195	SVVBN	B196
SVHBR/L	B195	SVQBR/L	B222
SVJBR/L	B125, 195	SVUBR/L	B223



# B Turning Insert (Positive)



## VB ○ ○

 Rhombic **35° Positive**  
Relief Angle: 5°



Dimensions (mm)			
Size	d	t	d <sub>1</sub>
11	6.35	3.18	2.8

Workpiece	Machining types															
	P	M	K	N	S	H	●	⊙	⊚	⊛	⊜	⊝	⊞	⊟	⊠	⊡
Steel	●	●	●	●	●	●	●	●	●	●	●	●	●	●	●	●
Stainless steel	●	●	●	●	●	●	●	●	●	●	●	●	●	●	●	●
Cast iron	●	●	●	●	●	●	●	●	●	●	●	●	●	●	●	●
Non-ferrous metal	●	●	●	●	●	●	●	●	●	●	●	●	●	●	●	●
Heat resistant alloy, Titanium alloy	●	●	●	●	●	●	●	●	●	●	●	●	●	●	●	●
Hardened steel	●	●	●	●	●	●	●	●	●	●	●	●	●	●	●	●

Inserts	Designation	Cermet		Coated										Uncoated		Cutting Condition											
		CN1500	CN2500	CC1500	CC2500	NC3215	NC3225	NC3120	NC3030	NC3235	NC5330	NC6310	NC6315	NC9115	NC9125	NC9135	PC5300	PC5400	PC8105	PC8110	PC8115	PC9030	H01	H05	f <sub>n</sub> (mm/rev)	a <sub>p</sub> (mm)	
Finishing  [High precision]	VBGT 1103003R-KF																●			●					0.01-0.06	0.04-1.30	
	110301R-KF																	●			●					0.02-0.08	0.05-1.50
	110302R-KF																	●			●		●			0.03-0.13	0.06-1.70
	1103003L-KF																	●			●		●			0.01-0.06	0.04-1.30
	110301L-KF																	●			●		●			0.02-0.08	0.05-1.50
	110302L-KF																	●			●		●			0.03-0.13	0.06-1.70
Medium to finishing  [High precision]	VBGT 1103003R-KM																								0.01-0.06	0.04-1.30	
	110301R-KM																									0.02-0.08	0.05-1.50
	110302R-KM																									0.03-0.13	0.06-1.70
	1103003L-KM																									0.01-0.06	0.04-1.30
	110301L-KM																									0.02-0.08	0.05-1.50
	110302L-KM																									0.03-0.13	0.06-1.70

 Cutting edge geometry **A52-A61**
 Recommended chip breaker **B04-B14**
 Code system **B34-B35**
● : Stock item

Available tool holders			
Designation	Page	Designation	Page
SVABR/L	B195	SVVBN	B196
SVHBR/L	B195	SVQBR/L	B222
SVJBR/L	B125, 195	SVUBR/L	B223



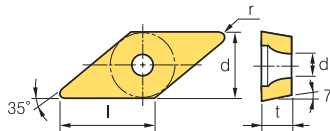




# B Turning Insert (Positive)







VC ○ ○

 Rhombic **35° Positive**  
Relief Angle: 7°



Dimensions (mm)			
Size	d	t	d <sub>1</sub>
11	6.35	3.18	2.8~3.4
12	7.5	3.18	2.8
16	9.525	4.76	4.4

Workpiece	Material Compatibility													Machining types			
	Steel	Stainless steel	Cast iron	Non-ferrous metal	Heat resistant alloy, Titanium alloy	Hardened steel	P	M	K	N	S	H	●	⊙	⊚	⊛	
Steel	●	●	●	●	●	●	●	●	●	●	●	●	●	●	●	●	●
Stainless steel	●	●	●	●	●	●	●	●	●	●	●	●	●	●	●	●	●
Cast iron	●	●	●	●	●	●	●	●	●	●	●	●	●	●	●	●	●
Non-ferrous metal	●	●	●	●	●	●	●	●	●	●	●	●	●	●	●	●	●
Heat resistant alloy, Titanium alloy	●	●	●	●	●	●	●	●	●	●	●	●	●	●	●	●	●
Hardened steel	●	●	●	●	●	●	●	●	●	●	●	●	●	●	●	●	●

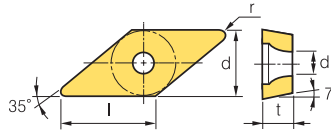
Inserts	Designation	Cermet		Coated		Coated										Uncoated		Cutting Condition											
		CN1500	CN2500	CC1500	CC2500	NC3215	NC3225	NC3120	NC3030	NC3235	NC5330	NC6310	NC6315	NC9115	NC9125	NC9135	PC5300	PC5400	PC8105	PC8110	PC8115	PC9030	H01	H05	f <sub>n</sub> (mm/rev)	a <sub>p</sub> (mm)			
Finishing  [High precision]	VCGT	110301-FS	●	●	●	●	●	●	●	●	●	●	●	●	●	●	●	●	●	●	●	●	●	●	●	0.01-0.16	0.03-1.40		
		110302-FS	●	●	●	●	●	●	●	●	●	●	●	●	●	●	●	●	●	●	●	●	●	●	●	●	0.02-0.18	0.04-1.50	
		110304-FS	●	●	●	●	●	●	●	●	●	●	●	●	●	●	●	●	●	●	●	●	●	●	●	●	0.04-0.19	0.06-1.60	
		160401-FS	●	●	●	●	●	●	●	●	●	●	●	●	●	●	●	●	●	●	●	●	●	●	●	●	●	0.01-0.16	0.04-1.80
		160402-FS	●	●	●	●	●	●	●	●	●	●	●	●	●	●	●	●	●	●	●	●	●	●	●	●	●	0.02-0.18	0.05-2.00
		160404-FS	●	●	●	●	●	●	●	●	●	●	●	●	●	●	●	●	●	●	●	●	●	●	●	●	●	0.04-0.19	0.08-2.00
Finishing  [Ultra high precision]	VCGT	110301MFN-FS	●	●	●	●	●	●	●	●	●	●	●	●	●	●	●	●	●	●	●	●	●	●	●	●	0.01-0.16	0.03-1.40	
		110302MFN-FS	●	●	●	●	●	●	●	●	●	●	●	●	●	●	●	●	●	●	●	●	●	●	●	●	0.02-0.18	0.04-1.50	
		110304MFN-FS	●	●	●	●	●	●	●	●	●	●	●	●	●	●	●	●	●	●	●	●	●	●	●	●	0.04-0.19	0.06-1.60	
		160401MFN-FS	●	●	●	●	●	●	●	●	●	●	●	●	●	●	●	●	●	●	●	●	●	●	●	●	●	0.01-0.16	0.04-1.80
		160402MFN-FS	●	●	●	●	●	●	●	●	●	●	●	●	●	●	●	●	●	●	●	●	●	●	●	●	●	0.02-0.18	0.05-2.00
		160404MFN-FS	●	●	●	●	●	●	●	●	●	●	●	●	●	●	●	●	●	●	●	●	●	●	●	●	●	0.04-0.19	0.08-2.00
Medium cutting  [High precision]	VCGT	110301-MS	●	●	●	●	●	●	●	●	●	●	●	●	●	●	●	●	●	●	●	●	●	●	●	●	0.02-0.23	0.05-2.00	
		110302-MS	●	●	●	●	●	●	●	●	●	●	●	●	●	●	●	●	●	●	●	●	●	●	●	●	0.03-0.25	0.07-2.50	
		110304-MS	●	●	●	●	●	●	●	●	●	●	●	●	●	●	●	●	●	●	●	●	●	●	●	●	0.05-0.25	0.09-2.50	
Medium cutting  [Ultra high precision]	VCGT	110301MFN-MS	●	●	●	●	●	●	●	●	●	●	●	●	●	●	●	●	●	●	●	●	●	●	●	●	0.02-0.23	0.05-2.00	
		110302MFN-MS	●	●	●	●	●	●	●	●	●	●	●	●	●	●	●	●	●	●	●	●	●	●	●	●	0.03-0.25	0.07-2.50	
		110304MFN-MS	●	●	●	●	●	●	●	●	●	●	●	●	●	●	●	●	●	●	●	●	●	●	●	●	0.05-0.25	0.09-2.50	
Medium cutting  [Ultra high precision]	VCGT	1203008FN-MS	●	●	●	●	●	●	●	●	●	●	●	●	●	●	●	●	●	●	●	●	●	●	●	●	0.02-0.20	0.04-1.80	
		120301FN-MS	●	●	●	●	●	●	●	●	●	●	●	●	●	●	●	●	●	●	●	●	●	●	●	●	0.03-0.26	0.06-2.20	
		120302FN-MS	●	●	●	●	●	●	●	●	●	●	●	●	●	●	●	●	●	●	●	●	●	●	●	●	0.05-0.28	0.08-2.80	
		120304FN-MS	●	●	●	●	●	●	●	●	●	●	●	●	●	●	●	●	●	●	●	●	●	●	●	●	0.06-0.30	0.10-2.80	
Finishing  [High precision]	VCGT	110301-VP1	●	●	●	●	●	●	●	●	●	●	●	●	●	●	●	●	●	●	●	●	●	●	●	●	0.02-0.15	0.05-0.50	
		110302-VP1	●	●	●	●	●	●	●	●	●	●	●	●	●	●	●	●	●	●	●	●	●	●	●	●	0.02-0.18	0.10-1.00	
		110304-VP1	●	●	●	●	●	●	●	●	●	●	●	●	●	●	●	●	●	●	●	●	●	●	●	●	0.03-0.18	0.15-1.20	
		160404-VP1	●	●	●	●	●	●	●	●	●	●	●	●	●	●	●	●	●	●	●	●	●	●	●	●	●	0.05-0.20	0.18-1.80
		160408-VP1	●	●	●	●	●	●	●	●	●	●	●	●	●	●	●	●	●	●	●	●	●	●	●	●	●	0.06-0.20	0.20-1.80

 Cutting edge geometry **A52-A61**
 Recommended chip breaker **B04-B14**
 Code system **B34-B35**
● : Stock item

Available tool holders			
Designation	Page	Designation	Page
SVJCR/L	B125, 196, 222	SVQCR/L	B223
SVVCN	B196	SVUCR/L	B223



## VC



Dimensions (mm)			
Size	d	t	d <sub>1</sub>
11	6.35	3.18	2.8~3.4
12	7.5	3.18	2.8

**Rhombic 35° Positive**  
Relief Angle: 7°

Workpiece	Material Compatibility												Machining types				
	Steel	Stainless steel	Cast iron	Non-ferrous metal	Heat resistant alloy, Titanium alloy	Hardened steel	P	M	K	N	S	H	●	⊙	⊘	⊚	
Steel	●	●	●	●	●	●	●	●	●	●	●	●	●	●	●	●	●
Stainless steel	●	●	●	●	●	●	●	●	●	●	●	●	●	●	●	●	●
Cast iron	●	●	●	●	●	●	●	●	●	●	●	●	●	●	●	●	●
Non-ferrous metal	●	●	●	●	●	●	●	●	●	●	●	●	●	●	●	●	●
Heat resistant alloy, Titanium alloy	●	●	●	●	●	●	●	●	●	●	●	●	●	●	●	●	●
Hardened steel	●	●	●	●	●	●	●	●	●	●	●	●	●	●	●	●	●

Inserts	Designation	Cermets		Coated		Coated										Uncoated		Cutting Condition										
		CN1500	CN2500	CC1500	CC2500	NC3215	NC3225	NC3120	NC3030	NC3235	NC5330	NC6310	NC6315	NC9115	NC9125	NC9135	PC5300	PC5400	PC8105	PC8110	PC8115	PC9030	H01	H05	f <sub>n</sub> (mm/rev)	a <sub>p</sub> (mm)		
Finishing  [Ultra high precision]	VCGT	110301MFN-VP1														●				●						0.02~0.15	0.05~0.50	
		110302MFN-VP1															●				●						0.02~0.18	0.10~1.00
		110304MFN-VP1															●				●						0.03~0.18	0.15~1.20
		1203008FN-VP1																									0.03~0.12	0.06~1.20
		120301FN-VP1																									0.04~0.13	0.08~1.20
		120302FN-VP1																									0.04~0.15	0.08~1.20
		120304FN-VP1																									0.06~0.20	0.10~1.50
Finishing  [Ultra high precision]	VCGX	120300MFR-VP1														●				●						0.02~0.10	0.05~0.50	
		120301MFR-VP1															●				●					0.02~0.15	0.05~0.50	
		120302MFR-VP1															●				●					0.02~0.18	0.10~1.00	
		120304MFR-VP1															●				●					0.03~0.20	0.12~1.20	
		120308MFR-VP1															●				●					0.05~0.20	0.15~1.20	
Finishing  [High precision]	VCGT	1103003R-KF																								0.01~0.06	0.04~1.30	
		110301R-KF																								0.02~0.08	0.05~1.50	
		110302R-KF																					●			0.03~0.13	0.06~1.70	
		1103003L-KF																								0.01~0.06	0.04~1.30	
		110301L-KF																								0.02~0.08	0.05~1.50	
		110302L-KF																								0.03~0.13	0.06~1.70	
Finishing  [Ultra high precision]	VCET	1103005MFR-KF														●				●						0.01~0.06	0.04~1.30	
		110301MFR-KF															●				●					0.02~0.08	0.05~1.50	
		110302MFR-KF															●				●					0.03~0.11	0.06~1.70	
		1103005MFL-KF															●				●					0.01~0.06	0.04~1.30	
		110301MFL-KF															●				●					0.02~0.08	0.05~1.50	
		110302MFL-KF															●				●					0.03~0.11	0.06~1.70	
Finishing  [High precision]	VCGT	1103003R-KM																								0.01~0.06	0.04~1.30	
		110301R-KM																								0.02~0.08	0.05~1.50	
		110302R-KM																						●		0.03~0.13	0.06~1.70	
		1103003L-KM																								0.01~0.06	0.04~1.30	
		110301L-KM																								0.02~0.08	0.05~1.50	
		110302L-KM																								0.03~0.13	0.06~1.70	
Medium to finishing  [Ultra high precision]	VCET	1103005MFR-KM														●				●						0.02~0.08	0.05~1.50	
		110301MFR-KM															●				●					0.03~0.11	0.06~1.70	
		110302MFR-KM															●				●					0.04~0.15	0.08~2.00	
		1103005MFL-KM															●				●					0.02~0.08	0.05~1.50	
		110301MFL-KM															●				●					0.03~0.11	0.06~1.70	
		110302MFL-KM															●				●					0.04~0.15	0.08~2.00	

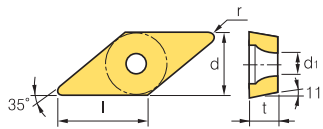
➡ Cutting edge geometry A52-A61
➡ Recommended chip breaker B04-B14
➡ Code system B34-B35
● : Stock item

Available tool holders			
Designation	Page	Designation	Page
SVJCR/L	B125, 196, 222	SVQCR/L	B223
SVVCN	B196	SVUCR/L	B223



# B Turning Insert (Positive)

## VP ○○



Dimensions (mm)			
Size	d	t	d <sub>1</sub>
08	6.35	2.38	2.3
11	6.35	3.18	2.8

Rhombic **35° Positive**  
Relief Angle: 11°

Workpiece	Machining types												
	P	M	K	N	S	H	●	⊕	⊖	⊗	⊙	⊚	⊛
Steel	●	●	●	●	●	●	●	●	●	●	●	●	●
Stainless steel	●	●	●	●	●	●	●	●	●	●	●	●	●
Cast iron	●	●	●	●	●	●	●	●	●	●	●	●	●
Non-ferrous metal	●	●	●	●	●	●	●	●	●	●	●	●	●
Heat resistant alloy, Titanium alloy	●	●	●	●	●	●	●	●	●	●	●	●	●
Hardened steel	●	●	●	●	●	●	●	●	●	●	●	●	●

Inserts	Designation	Cermet		Coated										Uncoated		Cutting Condition											
		CN1500	CN2500	CC1500	CC2500	NC3215	NC3225	NC3120	NC3030	NC3235	NC5330	NC6310	NC6315	NC9115	NC9125	NC9135	PC5300	PC5400	PC8105	PC8110	PC8115	PC9030	H01	H05	f <sub>n</sub> (mm/rev)	a <sub>p</sub> (mm)	
Finishing VP1 [High precision]	VPGT	110301-VP1														●		●	●	●					0.02-0.15	0.05-0.50	
		110302-VP1														●		●	●	●					●	0.02-0.18	0.10-1.00
		110304-VP1														●		●	●	●					●	0.03-0.18	0.15-1.20
Finishing VP1 [Ultra high precision]	VPGT	110301MFN-VP1														●			●							0.02-0.15	0.05-0.50
		110302MFN-VP1														●			●							0.02-0.18	0.10-1.00
		110304MFN-VP1														●			●							0.03-0.18	0.15-1.20
Finishing KF [Ultra high precision]	VPET	0802005MFR-KF														●			●							0.01-0.12	0.05-0.50
		080201MFR-KF														●			●							0.02-0.15	0.05-0.50
		080202MFR-KF														●			●							0.02-0.18	0.10-1.00
		0802005MFL-KF														●			●							0.01-0.12	0.05-0.50
		080201MFL-KF														●			●							0.02-0.15	0.05-0.50
		080202MFL-KF														●			●							0.02-0.18	0.10-1.00
Medium to finishing KM [Ultra high precision]	VPET	0802005MFR-KM														●			●							0.01-0.12	0.05-0.50
		080201MFR-KM														●			●							0.02-0.15	0.05-0.50
		080202MFR-KM														●			●							0.02-0.18	0.10-1.00
		0802005MFL-KM														●			●							0.01-0.12	0.05-0.50
		080201MFL-KM														●			●							0.02-0.15	0.05-0.50
		080202MFL-KM														●			●							0.02-0.18	0.10-1.00

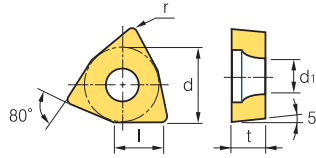
Cutting edge geometry **A52-A61**
 Recommended chip breaker **B04-B14**
 Code system **B34-B35**
● : Stock item

Available tool holders			
Designation	Page	Designation	Page
<b>SVABR/L</b>	B195	<b>SVVBN</b>	B196
<b>SVJBR/L</b>	B125, 195		



# WB

Dimensions (mm)			
Size	d	t	d <sub>1</sub>
<b>02</b>	3.97	1.59	2.2
<b>S3</b>	4.76	2.38	2.4



**Trigon 80° Positive**  
Relief Angle: 5°

Workpiece	Machining types															
	P	M	K	N	S	H	●	●	●	●	●	●	●	●	●	●
Steel	●	●	●	●	●	●	●	●	●	●	●	●	●	●	●	●
Stainless steel	●	●	●	●	●	●	●	●	●	●	●	●	●	●	●	●
Cast iron	●	●	●	●	●	●	●	●	●	●	●	●	●	●	●	●
Non-ferrous metal	●	●	●	●	●	●	●	●	●	●	●	●	●	●	●	●
Heat resistant alloy, Titanium alloy	●	●	●	●	●	●	●	●	●	●	●	●	●	●	●	●
Hardened steel	●	●	●	●	●	●	●	●	●	●	●	●	●	●	●	●

Inserts	Designation	Cermet		Coated														Uncoated		Cutting Condition								
		CN1500	CN2500	CC1500	CC2500	NC3215	NC3225	NC3120	NC3030	NC3235	NC5330	NC6310	NC6315	NC9115	NC9125	NC9135	PC5300	PC5400	PC8105	PC8110	PC8115	PC9030	H01	H05	f <sub>n</sub> (mm/rev)	a <sub>p</sub> (mm)		
Medium to finishing	WBGT <b>020102R</b>																									0.01-0.05	0.10-0.30	
	<b>S30204R</b>																										0.01-0.10	0.10-0.50
	<b>020102L</b>																						●	●		0.01-0.08	0.10-0.40	
	<b>S30202L</b>																									0.01-0.08	0.10-0.40	
	<b>S30204L</b>																									0.01-0.10	0.10-0.50	

➡ Cutting edge geometry **A52-A61**
➡ Recommended chip breaker **B04-B14**
➡ Code system **B34-B35**
● : Stock item

Available tool holders	
Designation	Page
<b>SWUBR/L</b>	B227

## Technical Information for Aluminum

### AK special chip breaker for aluminum

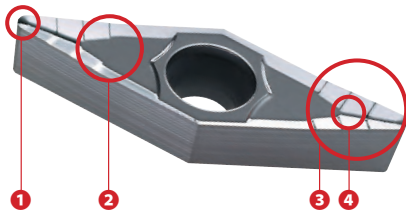
- Unique and 3-dimensional rake angle controls chip breaking and chip flow ensuring longer tool life and reducing cutting load
- High rake angle at cutting edge part reduces cutting load to increase tool life
- Buffed finish on top face controls chip flow reducing built-up edge



- 1 High rake angle & tabby pattern chip pocket - Low cutting load
- 2 Unique rake angle design - Effective chip breaking and good chip flow
- 3 Unique and 3-dimensional top face - Longer tool life & Excellent surface roughness
- 4 Tabby pattern & Sharp cutting edge - Distributing cutting load, long tool life
- 5 Buffed on top face - Excellent machining, Reducing built-up edge, Excellent chip flow

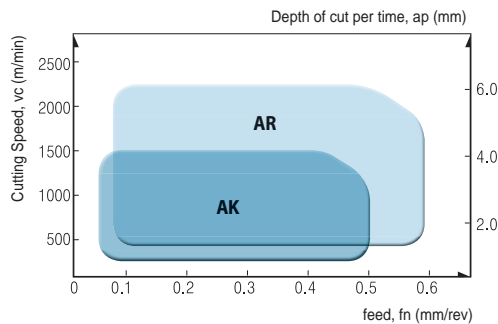
### AR special chip breaker for aluminum

- AR chip breaker ensures reliability and good cutting performance at high feed, speed and interrupted machining

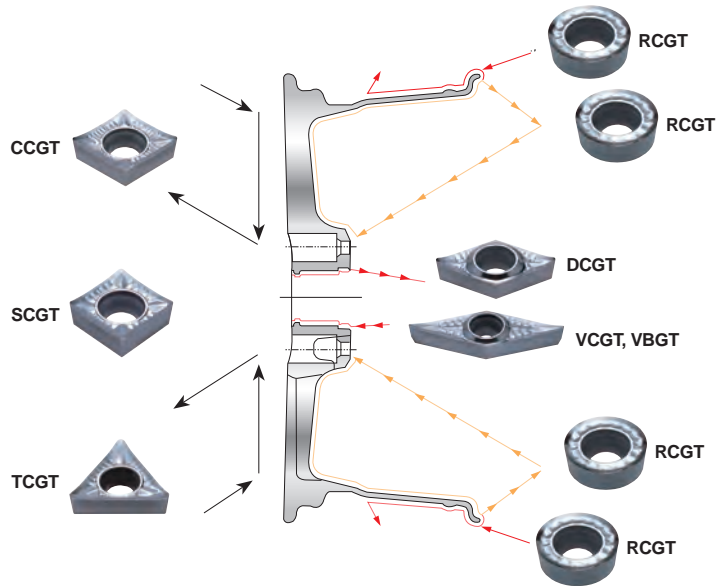


- 1 Flat corner cutting edge improved productivity at high feed machining and ensures good surface roughness and reliability owing to strong cutting edge
- 2 Specially buffed on top face controls chip flow reducing built-up edge
- 3 KORLOY's own technology applied for cutting edge and corner shape controlling chip flow ensures longer tool life
- 4 KORLOY special chip breaker design controls chip flow at high speed machining

### AK and AR chip breaker specially developed for aluminum



	Recommendation range	Grades
AK	$a_p = 0.1\sim 5.0$ mm $f_n = 0.03\sim 0.5$ mm/rev	H01 (Uncoated cemented carbides K10-K20) ND1000 (Diamond coating) PD1000 (DLC coating)
AR	$a_p = 0.5\sim 6.0$ mm $f_n = 0.05\sim 0.6$ mm/rev	H01 (Uncoated cemented carbides K10-K20) ND1000 (Diamond coating) PD1000 (DLC coating)



### Features of H01 and cutting conditions

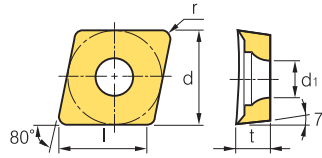
- Good for aluminum and alloy steel machining - Surface treatment reduces built-up edge
- 3-dimensional design reduces cutting resistance and ensures high machinability in high feed and speed machining

Workpiece		Hardness (HB)	kc (MPa)	vc (m/min)	fn (mm/rev)
Aluminum alloy (forged)	before heat treatment	50~70	500~600	1000~2500	0.1~0.6
	after heat treatment	90~110	700~900	300~1000	0.1~0.5
Aluminum alloy (cast)	before heat treatment	70~80	700~800	300~1000	0.1~0.6
	after heat treatment	80~100	800~950	200~600	0.1~0.4
Copper alloy	—	90~110	700	250~600	0.1~0.5
Non-ferrous metal, etc.	—	100	1700	150~300	0.1~0.6



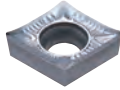
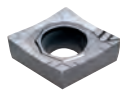
CC ○ ○

 Rhombic **80° Positive**  
Relief Angle: 7°



Dimensions (mm)			
Size	d	t	d <sub>1</sub>
06	6.35	2.38	2.8
09	9.525	3.97	4.4
12	12.7	4.76	5.5

Workpiece	Steel	P					Machining types	
	Stainless steel	M						<ul style="list-style-type: none"> <li>● Continuous cutting</li> <li>● General cutting</li> <li>✦ Interrupted cutting</li> </ul>
	Cast iron	K						
	Non-ferrous metal	N	✦	●	✦	✦		
	Heat resistant alloy, Titanium alloy	S						
Hardened steel	H							

Inserts	Designation	Coated			Uncoated		Cutting Condition		
		PC5040	PD1005	PD1010	H01	H05	fn (mm/rev)	ap (mm)	
<b>AK</b> 	CCGT	<b>060202-AK</b>	●			●	●	0.01-0.12	0.05-3.00
		<b>060204-AK</b>	●		●	●	●	0.02-0.15	0.10-3.00
		<b>060208-AK</b>				●	●	0.02-0.20	0.10-4.00
		<b>09T302-AK</b>	●		●	●	●	0.02-0.20	0.05-3.00
		<b>09T304-AK</b>	●		●	●	●	0.02-0.30	0.10-5.00
		<b>09T308-AK</b>	●			●	●	0.03-0.50	0.10-5.00
		<b>120402-AK</b>				●	●	0.02-0.30	0.05-4.00
		<b>120404-AK</b>	●		●	●	●	0.03-0.50	0.10-5.00
		<b>120408-AK</b>				●	●	0.04-0.80	0.10-5.50
	<b>AR</b> 	CCGT	<b>060202-AR</b>				●	●	0.02-0.30
		<b>060204-AR</b>						0.03-0.35	0.50-4.50
		<b>060208-AR</b>						0.04-0.50	0.50-4.50
		<b>09T302-AR</b>				●	●	0.03-0.45	0.30-4.00
		<b>09T304-AR</b>				●	●	0.04-0.50	0.50-4.50
		<b>09T308-AR</b>				●	●	0.05-0.60	0.50-6.00
		<b>120402-AR</b>						0.04-0.50	0.30-5.00
		<b>120404-AR</b>				●	●	0.05-0.60	0.50-6.00
		<b>120408-AR</b>				●	●	0.06-0.65	0.50-6.00
		<b>120412-AR</b>						0.08-0.70	0.50-6.50

Cutting edge geometry **A52-A61**  
 Recommended chip breaker **B04-B14**  
 Code system **B34-B35**  
 ● : Stock item

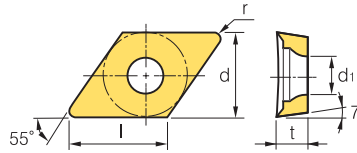
Available tool holders			
Designation	Page	Designation	Page
<b>SCACR/L</b>	B123, 190	<b>SCLCR/L</b>	B123, 190, 215



# B Aluminum Insert (Positive)


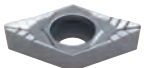
DC ○○

 Rhombic **55° Positive**  
Relief Angle: 7°



Dimensions (mm)			
Size	d	t	d <sub>1</sub>
07	6.35	2.38	2.8
11	9.525	3.97	4.4

Workpiece	Steel	<b>P</b>					Machining types
	Stainless steel	<b>M</b>					
Cast iron	<b>K</b>						● Continuous cutting
Non-ferrous metal	<b>N</b>	✱	●	✱	●	✱	● General cutting
Heat resistant alloy, Titanium alloy	<b>S</b>						✱ Interrupted cutting
Hardened steel	<b>H</b>						

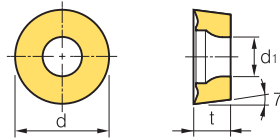
Inserts	Designation	Coated			Uncoated		Cutting Condition	
		PC5040	PD1005	PD1010	H01	H05	f <sub>n</sub> (mm/rev)	a <sub>p</sub> (mm)
<b>AK</b> 	DCGT <b>070202-AK</b>	●			●	●	0.01~0.20	0.05~3.00
	<b>070204-AK</b>	●		●	●	●	0.02~0.30	0.10~4.00
	<b>070208-AK</b>	●			●	●	0.03~0.40	0.10~4.00
	<b>11T302-AK</b>	●		●	●	●	0.02~0.30	0.05~4.00
	<b>11T304-AK</b>	●		●	●	●	0.03~0.50	0.10~5.00
	<b>11T308-AK</b>	●		●	●	●	0.03~0.50	0.10~5.00
	<b>11T312-AK</b>					●	●	0.04~0.60
<b>AR</b> 	DCGT <b>070202-AR</b>				●	●	0.02~0.30	0.30~4.00
	<b>070204-AR</b>				●	●	0.03~0.40	0.50~5.00
	<b>070208-AR</b>				●	●	0.04~0.50	0.50~5.00
	<b>11T302-AR</b>						0.03~0.45	0.30~6.00
	<b>11T304-AR</b>				●	●	0.04~0.50	0.50~6.00
	<b>11T308-AR</b>				●	●	0.05~0.60	0.50~6.00
	<b>11T312-AR</b>				●	●	0.08~0.65	0.50~6.50

 Cutting edge geometry **A52~A61**
 Recommended chip breaker **B04~B14**
 Code system **B34~B35**
● : Stock item

Available tool holders			
Designation	Page	Designation	Page
<b>SDACR/L</b>	B190	<b>SDQCR/L</b>	B217
<b>SDJCR/L</b>	B123, 191	<b>SDUCR/L</b>	B218
<b>SDNCN</b>	B124, 191	<b>SDZCR/L</b>	B219



## RC



Dimensions (mm)			
Size	d	t	d <sub>1</sub>
06	6.0	2.38	2.8
08	8.0	3.18	3.35
10	10.0	3.18~3.97	4.4
12	12.0	4.76	4.4

Round **Positive**  
Relief Angle: 7°

Workpiece	Steel	<b>P</b>					Machining types ● Continuous cutting ● General cutting ✦ Interrupted cutting
	Stainless steel	<b>M</b>					
	Cast iron	<b>K</b>					
	Non-ferrous metal	<b>N</b>	✦	●	✦	✦	
	Heat resistant alloy, Titanium alloy	<b>S</b>					
Hardened steel	<b>H</b>						

Inserts	Designation	Coated			Uncoated		Cutting Condition	
		PC5040	PD1005	PD1010	H01	H05	fn (mm/rev)	ap (mm)
 AK	RCGT	<b>0602M0-AK</b>			●	●	0.05~0.20	0.50~2.00
		<b>0803M0-AK</b>			●	●	0.05~0.25	0.50~2.50
		<b>1003M0-AK</b>			●	●	0.10~0.30	1.00~3.00
		<b>1204M0-AK</b>			●	●	0.10~0.35	1.00~3.50
 AR	RCGT	<b>0602M0-AR</b>					0.05~0.20	0.50~2.00
		<b>0803M0-AR</b>					0.05~0.25	0.50~2.50
		<b>1003M0-AR</b>			●	●	0.10~0.30	1.00~3.00
		<b>10T3M0-AR</b>					0.10~0.30	1.00~3.00
		<b>1204M0-AR</b>					0.10~0.35	1.00~3.50

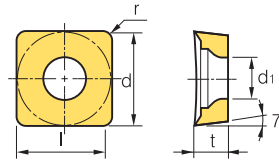
Cutting edge geometry **A52-A61**  
 Recommended chip breaker **B04-B14**  
 Code system **B34-B35**  
 ● : Stock item

Available tool holders			
Designation	Page	Designation	Page
SRDCN	B191	SRGCR/L	B192

# B Aluminum Insert (Positive)

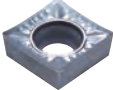
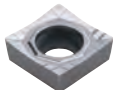
SC ○○

 Square **90° Positive**  
Relief Angle: 7°



Dimensions (mm)			
Size	d	t	d <sub>1</sub>
09	9.525	3.97	4.4
12	12.7	4.76	5.5

Workpiece	Steel	<b>P</b>					Machining types
	Stainless steel	<b>M</b>					
Cast iron	<b>K</b>						● Continuous cutting
Non-ferrous metal	<b>N</b>	✱	●	✱	●	✱	● General cutting
Heat resistant alloy, Titanium alloy	<b>S</b>						✱ Interrupted cutting
Hardened steel	<b>H</b>						

Inserts	Designation	Coated			Uncoated		Cutting Condition	
		PC5040	PD1005	PD1010	H01	H05	fn (mm/rev)	ap (mm)
<b>AK</b> 	SCGT <b>09T302-AK</b>	●				●	0.02~0.30	0.10~4.00
	<b>09T304-AK</b>	●			●	●	0.04~0.40	0.10~5.00
	<b>09T308-AK</b>				●	●	0.03~0.40	0.10~5.00
	<b>120404-AK</b>				●	●	0.03~0.50	0.10~5.00
	<b>120408-AK</b>				●	●	0.04~0.60	0.15~5.50
	<b>120416-AK</b>						0.04~0.60	0.15~5.50
<b>AR</b> 	SCGT <b>09T302-AR</b>						0.03~0.40	0.50~5.00
	<b>09T304-AR</b>				●	●	0.04~0.50	0.50~6.00
	<b>09T308-AR</b>						0.04~0.50	0.50~6.50
	<b>120404-AR</b>				●	●	0.05~0.60	0.50~6.50
	<b>120408-AR</b>						0.05~0.60	0.50~7.00
	<b>120416-AR</b>						0.05~0.60	0.50~7.00

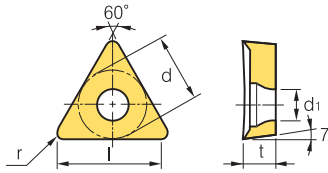
 Cutting edge geometry **A52~A61**
 Recommended chip breaker **B04~B14**
 Code system **B34~B35**
● : Stock item

Available tool holders			
Designation	Page	Designation	Page
SSBCR/L	B192	SSKCR/L	B193
SSDCN	B192	SSSCR/L	B193



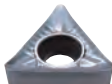
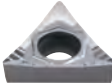
# TC

 **Triangular 60° Positive**  
Relief Angle: 7°



Dimensions (mm)			
Size	d	t	d <sub>1</sub>
09	5.56	2.38	2.5
11	6.35	2.38	2.8
16	9.525	3.97	4.4

Workpiece	Steel	<b>P</b>					Machining types
	Stainless steel	<b>M</b>					
Cast iron	<b>K</b>						● Continuous cutting
Non-ferrous metal	<b>N</b>	✱	●	✱	✱	✱	● General cutting
Heat resistant alloy, Titanium alloy	<b>S</b>						✱ Interrupted cutting
Hardened steel	<b>H</b>						

Inserts	Designation	Coated			Uncoated		Cutting Condition	
		PC5040	PD1005	PD1010	H01	H05	f <sub>n</sub> (mm/rev)	a <sub>p</sub> (mm)
<b>AK</b> 	TCGT <b>090202-AK</b>				●	●	0.01~0.12	0.05~3.00
	<b>090204-AK</b>				●	●	0.02~0.15	0.10~4.00
	<b>110202-AK</b>	●			●	●	0.02~0.20	0.05~4.00
	<b>110204-AK</b>	●			●	●	0.03~0.30	0.10~4.00
	<b>110208-AK</b>				●	●	0.03~0.40	0.10~5.00
	<b>16T302-AK</b>				●	●	0.02~0.30	0.05~5.00
	<b>16T304-AK</b>				●	●	0.03~0.40	0.10~5.50
	<b>16T308-AK</b>				●	●	0.03~0.50	0.10~5.50
	<b>16T312-AK</b>				●	●	0.04~0.60	0.15~5.50
	<b>16T316-AK</b>				●	●	0.05~0.80	0.15~5.50
	<b>16T325-AK</b>						0.06~0.90	0.20~7.00
<b>AR</b> 	TCGT <b>090202-AR</b>						0.02~0.18	0.30~3.00
	<b>090204-AR</b>				●	●	0.02~0.25	0.30~5.00
	<b>110202-AR</b>						0.02~0.30	0.30~4.00
	<b>110204-AR</b>				●	●	0.03~0.40	0.30~5.00
	<b>110208-AR</b>						0.04~0.45	0.50~6.00
	<b>16T302-AR</b>				●	●	0.03~0.45	0.30~5.00
	<b>16T304-AR</b>				●	●	0.04~0.50	0.50~6.00
	<b>16T308-AR</b>				●	●	0.05~0.60	0.50~6.00
	<b>16T312-AR</b>						0.06~0.65	0.50~6.00
	<b>16T316-AR</b>						0.08~0.70	0.50~6.50
	<b>16T325-AR</b>						0.10~0.10	0.80~7.00

 Cutting edge geometry **A52-A61**
 Recommended chip breaker **B04-B14**
 Code system **B34-B35**
● : Stock item

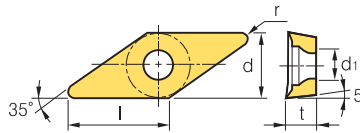
Available tool holders			
Designation	Page	Designation	Page
STACR/L	B193	STTCR/L	B194, 246
STFCR/L	B194	STWCR/L	B246
STGCR/L	B194		



# B Aluminum Insert (Positive)



## VB ○○

 Rhombic **35° Positive**  
Relief Angle: 5°



Dimensions (mm)			
Size	d	t	d <sub>1</sub>
11	6.35	3.18	2.8
16	9.525	4.76	4.4

Workpiece	Steel	<b>P</b>					Machining types
	Stainless steel	<b>M</b>					
Cast iron	<b>K</b>						
Non-ferrous metal	<b>N</b>	✱	●	✱	●	✱	
Heat resistant alloy, Titanium alloy	<b>S</b>						
Hardened steel	<b>H</b>						

Inserts	Designation	Coated			Uncoated		Cutting Condition	
		PC5040	PD1005	PD1010	H01	H05	fn (mm/rev)	ap (mm)
<b>AK</b> 	VBGT <b>110302-AK</b>				●	●	0.02~0.15	0.05~3.00
	<b>110304-AK</b>				●	●	0.02~0.15	0.10~4.00
	<b>110308-AK</b>					●	0.03~0.18	0.10~5.00
	<b>160402-AK</b>						0.03~0.30	0.05~4.00
	<b>160404-AK</b>				●	●	0.03~0.40	0.10~5.00
	<b>160408-AK</b>				●	●	0.03~0.50	0.10~5.00
	<b>160412-AK</b>					●	0.05~0.60	0.10~5.50
<b>AR</b> 	VBGT <b>110302-AR</b>						0.02~0.35	0.30~3.00
	<b>110304-AR</b>						0.03~0.45	0.30~4.00
	<b>110308-AR</b>						0.03~0.50	0.50~6.00
	<b>160402-AR</b>						0.04~0.45	0.30~5.00
	<b>160404-AR</b>				●	●	0.04~0.50	0.50~6.00
	<b>160408-AR</b>				●	●	0.05~0.60	0.50~6.00
	<b>160412-AR</b>						0.05~0.70	0.50~6.50

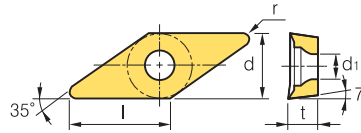
 Cutting edge geometry **A52~A61**
 Recommended chip breaker **B04~B14**
 Code system **B34~B35**
●: Stock item

Available tool holders			
Designation	Page	Designation	Page
<b>SVABR/L</b>	B195	<b>SVVBN</b>	B196
<b>SVHBR/L</b>	B195	<b>SVQBR/L</b>	B222
<b>SVJBR/L</b>	B125, 195	<b>SVUBR/L</b>	B223





## VC ○○

 Rhombic **35° Positive**  
Relief Angle: 7°



Dimensions (mm)			
Size	d	t	d <sub>1</sub>
11	6.35	3.18	2.8
13	7.94	3.18	3.4
16	9.525	4.76	4.4
22	12.7	5.56	5.6

Workpiece	Steel	P						Machining types	
	Stainless steel	M							● Continuous cutting
Cast iron	K							● General cutting	
Non-ferrous metal	N	✱	●	✱	✱	✱		✱ Interrupted cutting	
Heat resistant alloy, Titanium alloy	S								
Hardened steel	H								

Inserts	Designation	Coated			Uncoated		Cutting Condition		
		PC5040	PD1005	PD1010	H01	H05	fn (mm/rev)	ap (mm)	
<b>AK</b> 	VC GT	110301-AK			●		0.02~0.15	0.05~3.00	
		110302-AK	●		●	●	0.02~0.20	0.05~3.00	
		110304-AK	●		●	●	0.02~0.25	0.10~4.00	
		110308-AK			●	●	0.03~0.30	0.10~5.00	
		130302-AK	●			●	●	0.02~0.35	0.10~5.00
		130304-AK	●			●	●	0.03~0.35	0.10~5.00
		130308-AK						0.04~0.40	0.10~5.00
		160402-AK				●	●	0.02~0.30	0.05~5.00
		160404-AK			●	●	●	0.03~0.40	0.10~5.00
		160408-AK			●	●	●	0.03~0.50	0.10~5.00
		160412-AK				●	●	0.03~0.50	0.10~5.00
		220516-AK				●	●	0.03~0.60	0.10~7.00
		220525-AK					●	0.05~0.70	0.10~7.00
		220530-AK				●	●	0.08~1.00	0.10~7.00
<b>AR</b> 	VC GT	110301-AR					0.02~0.20	0.10~3.00	
		110302-AR				●	●	0.02~0.25	0.30~3.00
		110304-AR				●	●	0.03~0.35	0.30~4.00
		110308-AR						0.04~0.45	0.50~6.00
		130302-AR					●	0.02~0.40	0.50~3.00
		130304-AR				●	●	0.03~0.45	0.50~4.00
		130308-AR						0.04~0.50	0.50~5.00
		160402-AR				●	●	0.03~0.40	0.30~5.00
		160404-AR				●	●	0.04~0.50	0.50~6.00
		160408-AR				●	●	0.05~0.60	0.50~6.00
		160412-AR						0.06~0.65	0.50~6.50
		220516-AR						0.10~0.65	0.80~6.50
		220525-AR						0.10~0.70	0.80~7.00
		220530-AR				●	●	0.12~0.75	1.00~7.00

 Cutting edge geometry **A52-A61**
 Recommended chip breaker **B04-B14**
 Code system **B34-B35**
● : Stock item

Available tool holders			
Designation	Page	Designation	Page
SVJCR/L	B125, 196, 222	SVQCR/L	B223
SVVCN	B196	SVUCR/L	B223

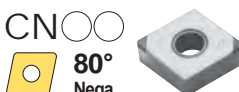
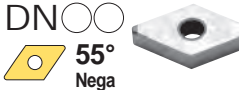
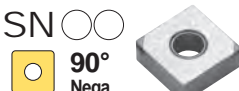






## cBN

### Multi-Corner Type (Negative)

Dimensions (mm)			
Size	d	t	d <sub>i</sub>
12	12.7	4.76	5.16
15	12.7	4.76~6.358	3.4
16	9.525	4.76	3.81

Inserts	Designation	Coated					Uncoated					Available tool holders					
		DNC100	DNC250	DNC300	DNC350	DNC400	DB1000	DB2000	DBN250	DBN350	DBN700A	DBNX20	Designation	Page			
	2NU-CNGA	120404	●	●	●	●	●				●		DCBNR/L	B167			
		120404F		●		●								DCLNR/L	B167/B208		
		120404T		●		●		●						MCKNR/L	B183		
		120404W		●										MCLNR/L	B183/B213		
		120404WF		●										MCMNN	B183		
		120408	●	●	●	●		●	●			●		PCBNR/L	B172		
		120408F		●		●								PCLNR/L	B173/B210		
		120408T		●		●		●									
		120408W		●		●		●				●					
		120408WF								●							
		120412	●	●	●	●											
		120412F		●		●											
		120412T		●		●											
		120412W		●					●			●					
		120412WT							●								
	T-2NU-CNGA	120404		●													
		120408		●		●											
	4NU-CNGA	120404		●													
		120408		●		●											
120412			●														
4NS-CNGA	120408					●											
	120412					●											
	2NU-DNGA	150404		●	●	●			●	●		DDJNR/L	B168				
		150404F		●		●							MDJNR/L	B184			
		150404T		●		●							MDNNN	B184			
		150408	●	●	●	●		●	●	●			MDQNR/L	B185			
		150408F		●		●							MDUNR/L	B213			
		150408T		●		●		●	●				PDJNR/L	B173			
		150412		●		●							PDNNR/L	B174			
		150412F		●		●							PDSNR/L	B210			
		150412T		●		●							PDUNR/L	B211			
		150604	●	●		●											
		150608	●	●		●											
			4NU-DNGA	150404		●		●									
				150408		●		●									
				150412		●		●									
				150608		●											
4NS-DNGA	150608					●											
	150612					●											
	4NU-SNGA	120404		●							●	DSBNR/L	MSBNR/L	B168	B185		
		120408		●								●	MSDNN	MSKNR/L	B185	B186/B213	
													MSRNR/L	MSSNR/L	B186	B187	
													PSBNR/L	PSDNN	B175	B176	
													PSKNR/L			B176/B211	
	3NU-TNGA	160404		●		●		●	●	●	●	MTENN	MTFNR/L	B187	B187/B214		
		160404T		●									MTGNR/L	MTJNR/L	B188	B188	
		160408		●		●						●	PTFNR/L	PTGNR/L	B177/B211	B178	
		160408F		●									PTTNR/L	WTENN	B178	B179	
		160408T		●									WTJNR/L	WTXNR/L	B179	B179	
160412					●												
	2NU-VNGA	160404	●	●	●	●				●	●	MVJNR/L		B188			
		160404F		●		●							MVQNR/L		B189		
		160404T		●		●							MVUNR/L		B214		
		160408	●	●	●	●		●	●	●		●	MVVNN		B189		
		160408F		●		●											
		160408T		●		●				●							
		T-2NU-VNGA	160408		●					●							

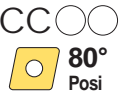
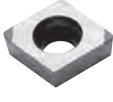
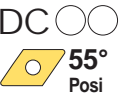
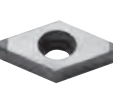
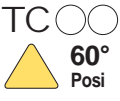

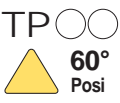



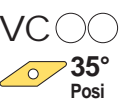

● : Stock item



# cBN

## Multi-Corner Type (Positive)

Dimensions (mm)			
Size	d	t	d <sub>1</sub>
06	6.35	2.38	2.8
07	6.35	2.38	2.8
09	9.525	3.97	4.4
11	9.525	3.97	4.4
16	9.525	4.76	3.81

Inserts	Designation	Coated					Uncoated					Available tool holders			
		DNC100	DNC250	DNC300	DNC350	DNC400	DB1000	DB2000	DBN250	DBN350	DBN700A	DBNX20	Designation	Page	
 	2NU-CCGW	060202	●										SCACR/L	B190	
		060202T	●										SCLCR/L	B190/B215/B225	
		060204	●						●						
		060204F	●												
		060204T	●												
		060208							●						
		09T302	●												
		09T304	●	●	●			●		●		●			
		09T304T	●												
		09T308	●	●	●					●	●	●			
09T308T	●														
09T308W	●														
 	2NU-DCGW	070204	●				●					SDACR/L	B190		
		070208	●									SDJCR/L	B191		
		070208T							●				SDNCN	B191	
		11T302	●										SDQCR/L	B217	
		11T304	●	●	●			●		●			SDUCR/L	B218	
		11T304F	●										SDZCR/L	B219	
		11T304T	●												
		11T308	●	●	●					●		●			
		11T308T	●												
		11T308W	●												
T-2NU-DCGW	11T304	●													
	11T308	●		●											
 	3NU-TCGW	090204	●									STACR/L	B193		
		090204F	●									STFCR/L	B194/B220		
		090204T	●									STGCR/L	B194		
												STTCR/L	B194		
 	3NU-TPGW	110304	●	●			●	●			●				
		110304F	●												
		110304T	●												
		110308	●	●				●	●			●			
		110308F	●												
	110308T	●													
	3NU-TPGN	110308						●	●				CTFPR/L	B182/B212	
		160304	●										CTGPR/L	B182	
		160308	●												
		110304	●							●			CTFPR/L	B182/B212	
110304T		●										CTGPR/L	B182		
3NU-TPGB	110308	●							●						
	110308F	●													
	110308T	●													
	110308W	●													
	110308X	●													
 	2NU-VBGW	160402	●									SVABR/L	B195		
		160404	●	●	●			●		●		●	SVHBR/L	B195	
		160404F	●										SVJBR/L	B195	
		160404T	●										SVQBR/L	B222	
		160408	●	●	●					●	●		SVUBR/L	B223	
		160408F	●												
		160408T	●												
		T-2NU-VBGW	160408			●									
		 	2NU-VCGW	160404	●	●									
				160404F	●										
160404T	●														
160408	●														
160408F	●														
160408T	●									●	●				
T-2NU-VCGW	160404			●											
160408	●														

● : Stock item











## cBN

### Regrinding Type (Negative/Positive)

Dimensions (mm)			
Size	d	t	d <sub>i</sub>
09	9.525	3.97	4.4
11	6.35~9.525	3.8~3.97	3.4~4.4
12	12.7	4.76	5.16

Dimensions (mm)			
Size	d	t	d <sub>i</sub>
15	12.7	4.76	5.16
16	9.525	4.76	3.81~4.4

Inserts	Designation	Coated										Uncoated						Available tool holders				
		DNC100	DNC250	DNC300	DNC350	DNC400	DB1000	DB2000	DBN250	DBN350	DBN700A	DBNX20	DB1000	DB2000	DBN250	DBN350	DBN700A	DBNX20	Designation	Page		
 <b>CN</b> 80° Nega	CNMA	<b>120404</b>																	DCBNR/L	MCKNR/L	B167	B183
		<b>120408</b>																	DCLNR/L	MCLNR/L	B167/B208	B183/B213
	T-CNMA	<b>120408</b>																	PCBNR/L	MCMNN	B172	B183
																			PCLNR/L		B173/B210	
 <b>DN</b> 55° Nega	DNMA	<b>150404</b>																	DDJNR/L	MDJNR/L	B168	B184
		<b>150408</b>																	MDNNN	MDQNR/L	B184	B185
																			MDUNR/L	PDJNR/L	B213	B173
																			PDNNR/L	PDSNR/L	B174	B210
																			PDUNR/L		B210	
 <b>TN</b> 60° Nega	TNMA	<b>160404</b>																	MTENN	MTFNR/L	B187	B187/B214
		<b>160408</b>																	MTGNR/L	MTJNR/L	B188	B188
																			PTFNR/L	PTGNR/L	B177/B211	B178
																			PTTNR/L	WTENN	B178	B179
																			WTJNR/L	WTXNR/L	B179	B179
 <b>VN</b> 35° Nega	T-VNMA	<b>160404</b>																	MVJNR/L		B188	
	VNMA	<b>160404</b>																	MVQNR/L		B189	
		<b>160408</b>																	MVUNR/L		B214	
																			MVVNN		B189	
 <b>CC</b> 80° Posi	CCMW	<b>09T304</b>																	SCACR/L		B190	
																			SCLCR/L		B190/B215/B225	
 <b>DC</b> 50° Posi	DCGW	<b>11T308</b>																	SDACR/L		B190	
	T-DCGW	<b>11T308</b>																	SDJCR/L		B191	
																			SDNCN		B191	
 <b>VBMW</b> 35° Posi	VBMW	<b>160404</b>																	SVABR/L		B195	
		<b>160408</b>																	SVHBR/L		B195	
																			SVJBR/L		B195	
																			SVQBR/L		B222	
																			SVUBR/L		B223	
 <b>TP</b> 60° Posi	T-TPGB	<b>110304</b>																	CTFPR/L		B182/B212	
	TPGB	<b>110304</b>																	CTGPR/L		B182	
		<b>110308</b>																				





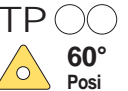

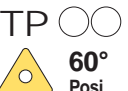
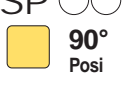
● : Stock item



# PCD

## Insert (Negative/Positive)

Dimensions (mm)				Dimensions (mm)			
Size	d	t	d <sub>1</sub>	Size	d	t	d <sub>1</sub>
06	6.35	2.38	2.8	11	9.525	3.97	4.4
07	6.35	2.38	2.8	12	12.7	4.76	5.16
08	7.94	2.38	3.4	15	12.7	4.76	5.16
09	9.525	3.18	4.4	16	9.525	4.76	3.81

Inserts	Designation	PCD			Available tool holders			
		DP90	DP150	DP200	Designation		Page	
 <b>CN</b> ○○○ 80° Nega	CNMM	<b>120404</b>	●		DCBNR/L	DCLNR/L	B167	B167
		<b>120408</b>	●		MCKNR/L	MCLNR/L	B183	B183
					MCMNN	PCBNR/L	B183	B172
					PCLNR/L		B173	
 <b>DN</b> ○○○ 55° Nega	DNMM	<b>150404</b>	●		DDJNR/L	MDJNR/L	B168	B184
		<b>150408</b>	●		MDNNN	MDQNR/L	B184	B185
					MDUNR/L	PDJNR/L	B213	B173
					PDNNR/L	PDSNR/L	B174	B210
					PDUNR/L		B210	
 <b>CC</b> ○○○ 80° Posi	CCMW	<b>120404</b>	●		SCACR/L		B190	
	CCMT	<b>060202</b>	●		SCLCR/L		B190/B215/B225	
		<b>060204</b>	●					
		<b>09T304</b>	●					
		<b>09T308</b>	●					
 <b>DC</b> ○○○ 55° Posi	DCMT	<b>070202</b>	●		SDACR/L		B195	
		<b>070204</b>	●		SDJCR/L		B191	
		<b>11T302</b>	●		SDNCN		B191	
		<b>11T304</b>	●		SDQCR/L		B217	
		<b>11T308</b>	●		SDUCR/L		B218	
	DCGT	<b>11T304</b>	●		SDZCR/L		B219	
 <b>TP</b> ○○○ 60° Posi	TPGW	<b>080204</b>	●					
		<b>090204</b>	●					
		<b>090208</b>	●					
		<b>110304</b>	●					
		<b>110308</b>	●					
			●					
 <b>VB</b> ○○○ <b>VC</b> ○○○ 35° Posi	VBGW	<b>160404</b>	●					
	VBMT	<b>110304</b>	●		SVHBR/L		B195	
		<b>110308</b>	●		SVJBR/L		B195	
		<b>160404</b>	●		SVUBR/L		B223	
		<b>160408</b>	●					
	VCMT	<b>110304</b>	●		SVVCN		B196	
		<b>110308</b>	●					
<b>160408</b>		●						
 <b>TP</b> ○○○ 60° Posi	TPGN	<b>110304</b>	●					
		<b>110308</b>	●					
			●					
 <b>SP</b> ○○○ 90° Posi	SPGN	<b>090304</b>	●		CSDPN		B181	
					CSKPR/L		B182/B212	

● : Stock item

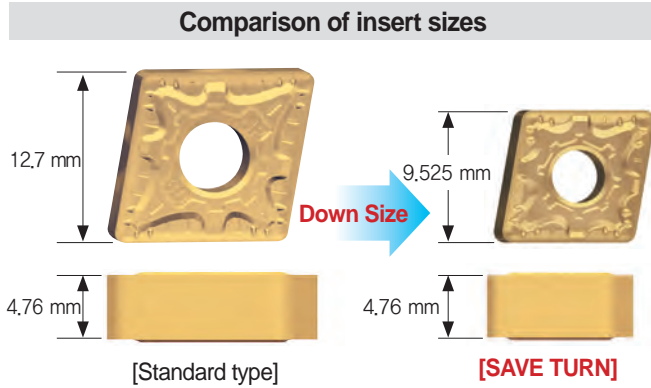
# B Technical Information for SAVE TURN

Economical small insert with powerful cutting performance

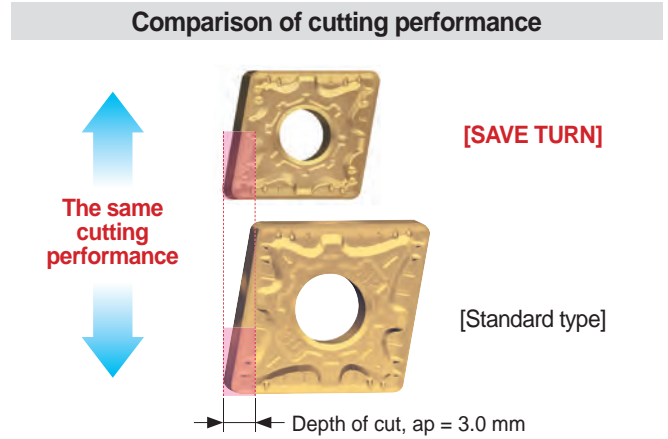
## SAVE TURN

- Strongly recommended turning insert for machining smaller diameter than  $\varnothing 100$
- Small but powerful and economical insert which performs the same like standard-sized inserts under the depth of cut of 3.0 mm

### Features



- Optimized size of the same performance like the standard type

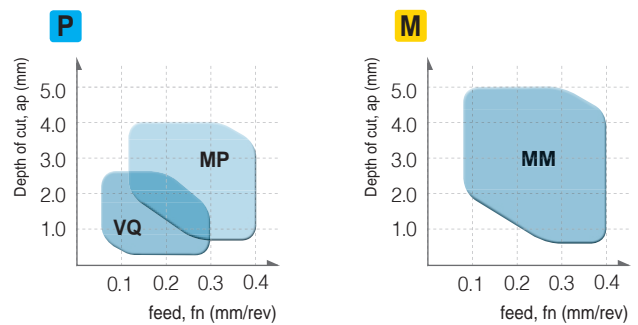


- Performs the same like standard type inserts under the depth of cut of 3.0 mm

### Features of chip breaker

Insert shape	Cutting edge	Features
<b>VQ</b> 		<ul style="list-style-type: none"> <li>• For finishing steel</li> <li>• Efficient chip breaking and low cutting resistance</li> <li>• Various application available at low depth of cut</li> <li>• Recommended depth of cut: 0.5~2.5 mm</li> </ul>
<b>MP</b> 		<ul style="list-style-type: none"> <li>• For medium cutting of steel</li> <li>• 4 dots for improved chip control in medium cutting to finishing</li> <li>• Stable chip evacuation at high depth of cut</li> <li>• Stable tool life due to lower cutting loads at high feed</li> <li>• Recommended depth of cut: 0.5~4.0 mm</li> </ul>
<b>MM</b> 		<ul style="list-style-type: none"> <li>• For medium cutting of stainless steel</li> <li>• Limits plastic deformation caused by heat</li> <li>• Stable tool life thanks to the balanced cutting performance and toughness</li> <li>• Stable chip flow at high speeds and feeds</li> <li>• Recommended depth of cut: 0.5~5.0 mm</li> </ul>

### Application area of chip breaker



**VQ:** Depth of cut,  $a_p = 0.5\sim 2.5$  mm/feed,  $f_n = 0.05\sim 0.30$  mm/rev

**MP:** Depth of cut,  $a_p = 0.5\sim 4.0$  mm/feed,  $f_n = 0.15\sim 0.40$  mm/rev

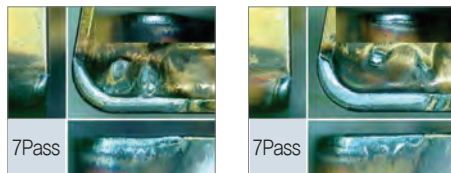
**MM:** Depth of cut,  $a_p = 0.5\sim 5.0$  mm/feed,  $f_n = 0.10\sim 0.40$  mm/rev

### Application example

#### Alloy steel (SCM440)

- **Cutting conditions**  $vc$  (m/min) = 250,  $f_n$  (mm/rev) = 0.25  
 $a_p$  (mm) = 2.0~3.0, continuous cutting, wet

- **Cutting Result**



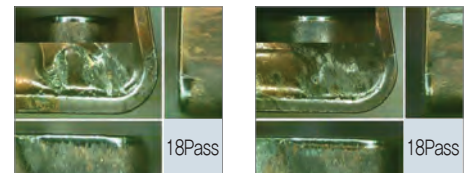
CNMG090408-HM  
SAVE TURN

CNMG120408-HM  
Standard type

#### Alloy steel (SCM440)

- **Cutting conditions**  $vc$  (m/min) = 250,  $f_n$  (mm/rev) = 0.25  
 $a_p$  (mm) = 2.0~3.0, interrupted cutting, wet

- **Cutting Result**



CNMG090408-HM  
SAVE TURN

CNMG120408-HM  
Standard type





Type	Picture	Designation	Coated						Dimensions (mm)				cutting conditions		Configuration	Available tool holders page	
			NC3215	NC3225	NC5330	NC6310	NC9125	NC9135	PC9030	d	t	r	d <sub>1</sub>	ap (mm)			fn (mm/rev)
C type		CNMG 090408-VQ		●					9.525	4.76	0.8	3.81	0.50~2.50	0.08~0.30		B116 B119	
		090412-VQ		●					9.525	4.76	1.2	3.81	0.50~2.50	0.10~0.30			
		CNMG 090404-MP							9.525	4.76	0.4	3.81	0.50~4.00	0.10~0.40		B116 B119	
		090408-MP							9.525	4.76	0.8	3.81	0.50~4.00	0.15~0.40			
		090412-MP							9.525	4.76	1.2	3.81	0.50~4.00	0.15~0.45			
		CNMG 090404-MM							9.525	4.76	0.4	3.81	0.50~5.00	0.08~0.35		B116 B119	
		090408-MM							9.525	4.76	0.8	3.81	0.50~5.00	0.10~0.40			
		090412-MM							9.525	4.76	1.2	3.81	0.50~5.00	0.12~0.45			
	D type		DNMG 110508-VQ		●					9.525	5.56	0.4	3.81	0.50~2.50	0.08~0.30		B116 B117 B119 B120
110512-VQ				●					9.525	5.56	0.8	3.81	0.50~2.50	0.10~0.30			
		DNMG 110504-MP							9.525	5.56	0.4	3.81	0.50~4.00	0.10~0.40		B116 B117 B119 B120	
		110508-MP							9.525	5.56	0.8	3.81	0.50~4.00	0.15~0.40			
		110512-MP							9.525	5.56	1.2	3.81	0.50~4.00	0.15~0.45			
		DNMG 110504-MM							9.525	5.56	0.4	3.81	0.50~5.00	0.08~0.35		B116 B117 B119 B120	
		110508-MM							9.525	5.56	0.8	3.81	0.50~5.00	0.10~0.40			
		110512-MM							9.525	5.56	1.2	3.81	0.50~5.00	0.12~0.45			
S type			SNMG 090408-VQ		●					9.525	4.76	0.4	3.81	0.50~2.50	0.08~0.30		B117 B118 B120
	090412-VQ								9.525	4.76	0.8	3.81	0.50~2.50	0.10~0.30			
		SNMG 090404-MP							9.525	4.76	0.4	3.81	0.50~4.00	0.10~0.40		B117 B118 B120	
		090408-MP							9.525	4.76	0.8	3.81	0.50~4.00	0.15~0.40			
		090412-MP							9.525	4.76	1.2	3.81	0.50~4.00	0.15~0.45			
		SNMG 090404-MM							9.525	4.76	0.4	3.81	0.50~5.00	0.08~0.35		B117 B118 B120	
		090408-MM							9.525	4.76	0.8	3.81	0.50~5.00	0.10~0.40			
		090412-MM							9.525	4.76	1.2	3.81	0.50~5.00	0.12~0.45			
	W type		WNMG 060404-VQ							9.525	4.76	0.4	3.81	0.30~2.00	0.06~0.30		B119 B120
060408-VQ									9.525	4.76	0.8	3.81	0.50~2.00	0.08~0.30			
060412-VQ									9.525	4.76	1.2	3.81	0.50~2.00	0.10~0.30			
		WNMG 060404-MP	●	●	●	●			9.525	4.76	0.4	3.81	0.50~3.50	0.10~0.40		B119 B120	
		060408-MP	●	●	●	●	●		9.525	4.76	0.8	3.81	0.50~3.50	0.15~0.40			
		060412-MP							9.525	4.76	1.2	3.81	0.50~3.50	0.15~0.45			
		WNMG 060404-MM							9.525	4.76	0.4	3.81	0.50~4.00	0.08~0.35		B119 B120	
		060408-MM				●	●	●	9.525	4.76	0.8	3.81	0.50~4.00	0.10~0.40			
		060412-MM				●	●	●	9.525	4.76	1.2	3.81	0.50~4.00	0.12~0.45			

● : Stock item



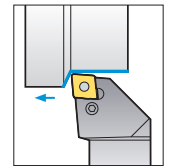
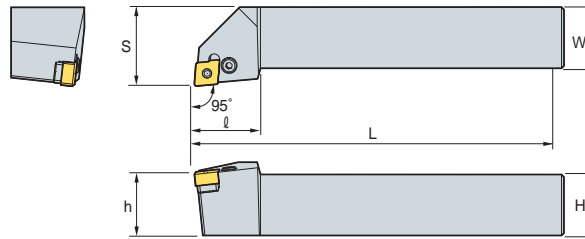


# B SAVE TURN Holder

## PCLNR/L



CN□□



95°

• R type insert (mm)

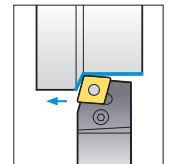
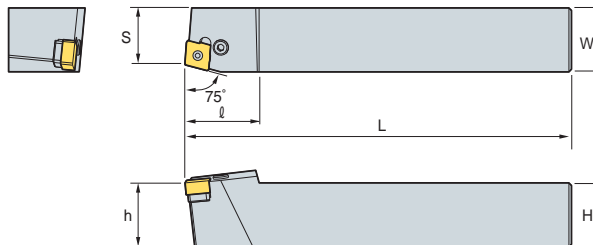
Designation	H	W	L	S	h	ℓ	Insert	Lever	Screw	Shim	Shim pin	Wrench	Shim Pin Punch
PCLNR/L 1616-H09-4N	16	16	100	20	16	20	CN□□ 0904□□						
2020-K09-4N	20	20	125	25	20	25							
2525-M09-4N	25	25	150	32	25	27							

➔ Applicable inserts B115

## PCBNR/L



CN□□



75°

• R type insert (mm)

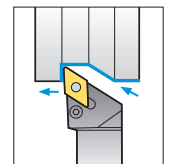
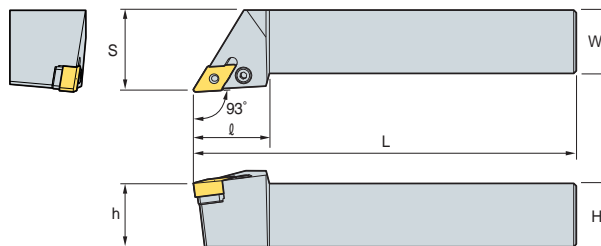
Designation	H	W	L	S	h	ℓ	Insert	Lever	Screw	Shim	Shim pin	Wrench	Shim Pin Punch
PCBNR/L 2020-K09-4N	20	20	125	17	20	27	CN□□ 0904□□						
2525-M09-4N	25	25	150	22	25	29							

➔ Applicable inserts B115

## PDJNR/L



DN□□



93°

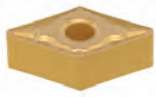
• R type insert (mm)

Designation	H	W	L	S	h	ℓ	Insert	Lever	Screw	Shim	Shim pin	Wrench	Shim Pin Punch
PDJNR/L 2020-K11-5N	20	20	125	25	20	25	DN□□ 1105□□						
2525-M11-5N	25	25	150	32	25	30							

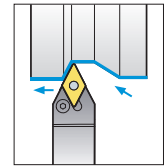
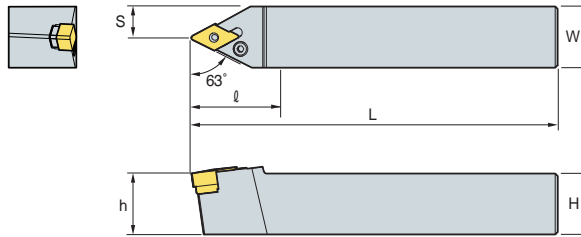
➔ Applicable inserts B115



# PDNNR/L



DN□□



63°

• R type insert  
(mm)

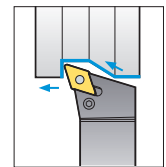
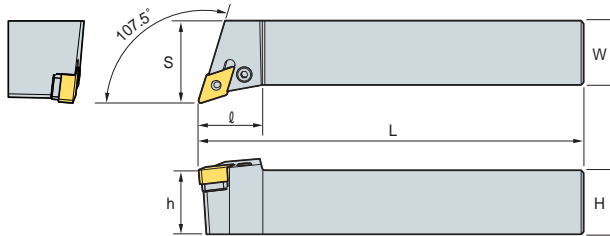
Designation	H	W	L	S	h	ℓ	Insert	Lever	Screw	Shim	Shim pin	Wrench	Shim Pin Punch
PDNNR/L 2020-K11-5N	20	20	125	25	20	30	DN□□ 1105□□						
2525-M11-5N	25	25	150	32	25	30							

↻ Applicable inserts B115

# PDQNR/L



DN□□



107.5°

• R type insert  
(mm)

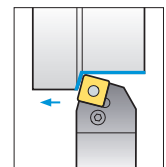
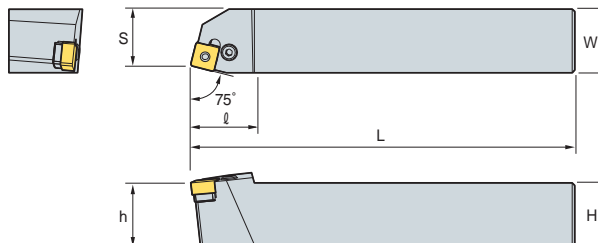
Designation	H	W	L	S	h	ℓ	Insert	Lever	Screw	Shim	Shim pin	Wrench	Shim Pin Punch
PDQNR/L 2020-K11-5N	20	20	125	25	20	30	DN□□ 1105□□						
2525-M11-5N	25	25	150	32	25	30							

↻ Applicable inserts B115

# PSBNR/L



SN□□



75°

• R type insert  
(mm)

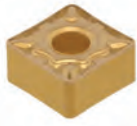
Designation	H	W	L	S	h	ℓ	Insert	Lever	Screw	Shim	Shim pin	Wrench	Shim Pin Punch
PSBNR/L 2020-K09-4N	20	20	125	17	20	25	SN□□ 0904□□						
2525-M09-4N	25	25	150	22	25	25							

↻ Applicable inserts B115

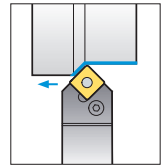
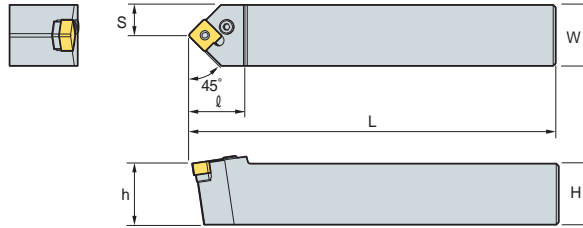


# B SAVE TURN Holder

## PSDNN



SN□□



45°

• R type insert  
(mm)

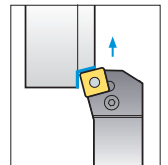
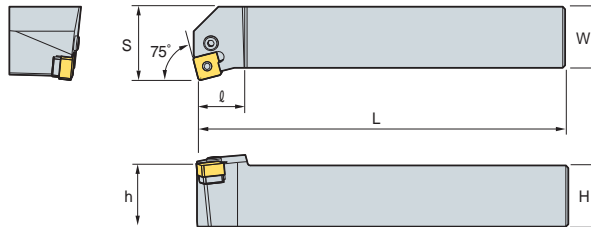
Designation		H	W	L	S	h	ℓ	Insert	Lever	Screw	Shim	Shim pin	Wrench	Shim Pin Punch
PSDNN	2020-K09-4N	20	20	125	17	20	25	SN□□0904□□						
	2525-M09-4N	25	25	150	22	25	25							

↻ Applicable inserts B115

## PSKNR/L



SN□□



75°

• R type insert  
(mm)

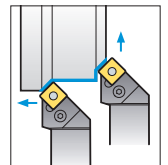
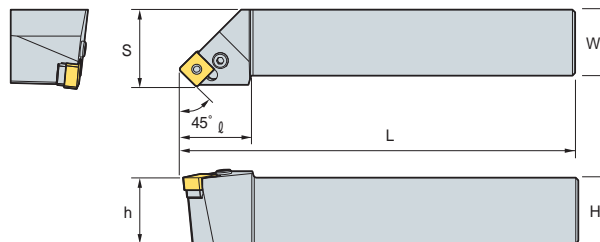
Designation		H	W	L	S	h	ℓ	Insert	Lever	Screw	Shim	Shim pin	Wrench	Shim Pin Punch
PSKNR/L	2020-K09-4N	20	20	125	17	20	25	SN□□0904□□						
	2525-M09-4N	25	25	150	22	25	25							

↻ Applicable inserts B115

## PSSNR/L



SN□□



45°

• R type insert  
(mm)

Designation		H	W	L	S	h	ℓ	Insert	Lever	Screw	Shim	Shim pin	Wrench	Shim Pin Punch
PSSNR/L	2020-K09-4N	20	20	125	17	20	25	SN□□0904□□						
	2525-M09-4N	25	25	150	22	25	25							

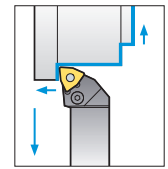
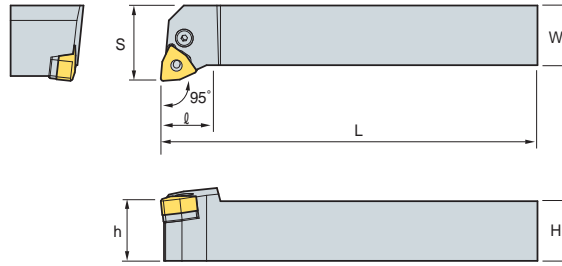
↻ Applicable inserts B115



# PWLNRL/L



WN□□



95°

• R type insert (mm)

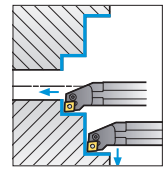
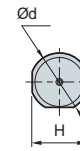
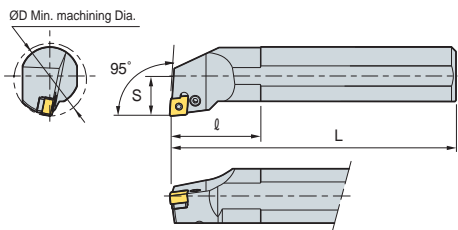
Designation	H	W	L	S	h	ℓ	Insert	Lever	Screw	Shim	Shim pin	Wrench	Shim Pin Punch
PWLNRL/L 1616-H06	16	16	100	20	16	20	WN□□0604□□						
2020-K06	20	20	125	25	20	20							
2525-M06	25	25	150	32	25	20							

↻ Applicable inserts B115

# PCLNR/L



CN□□



95°

• R type insert (mm)

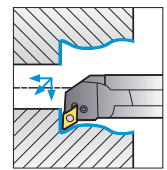
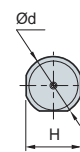
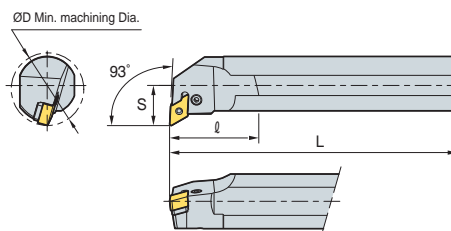
Designation	ØD	Ød	H	L	S	ℓ	Insert	Lever	Screw	Shim	Shim pin	Wrench	Shim Pin Punch
S20Q-PCLNR/L-09-4N	25	20	18	180	13	50	CN□□0904□□						
S25R-PCLNR/L-09-4N	32	25	23	200	17	50							
S32S-PCLNR/L-09-4N	40	32	30	250	22	50							

↻ Applicable inserts B115

# PDUNR/L



DN□□



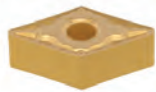
93°

• R type insert (mm)

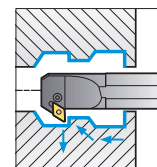
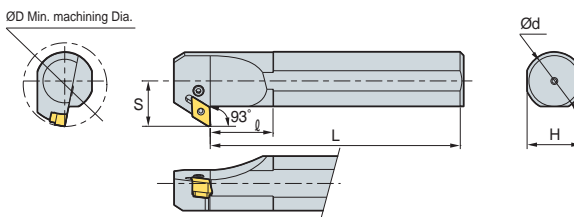
Designation	ØD	Ød	H	L	S	ℓ	Insert	Lever	Screw	Shim	Shim pin	Wrench	Shim Pin Punch
S32S-PDUNR/L-11-5N	40	32	30	250	22	30	DN□□1105□□						
S40T-PDUNR/L-11-5N	50	40	38	300	27	50							

↻ Applicable inserts B115

## PDZNR/L



DN□□



93°

• R type insert (mm)

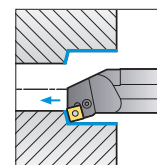
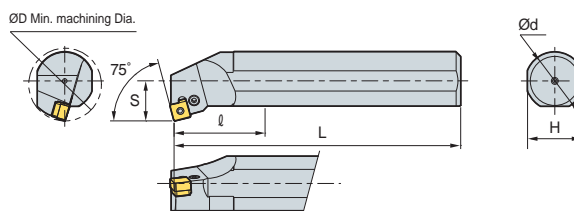
Designation	ØD	Ød	H	L	S	ℓ	Insert	Lever	Screw	Shim	Shim pin	Wrench	Shim Pin Punch
S32S-PDZNR/L-11-5N	40	32	30	250	22	30	DN□□1105□□						
S40T-PDZNR/L-11-5N	50	40	38	300	27	50							

➔ Applicable inserts B115

## PSKNR/L



SN□□



75°

• R type insert (mm)

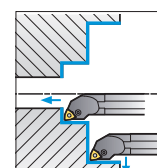
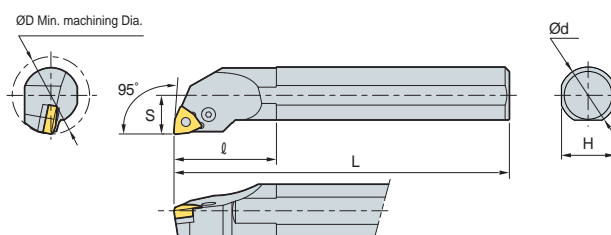
Designation	ØD	Ød	H	L	S	ℓ	Insert	Lever	Screw	Shim	Shim pin	Wrench	Shim Pin Punch
S25R-PSKNR/L-09-4N	32	25	23	200	17	32	SN□□0904□□						
S32S-PSKNR/L-09-4N	40	32	30	250	22	32							

➔ Applicable inserts B115

## PWLNRL



WN□□



95°

• R type insert (mm)

Designation	ØD	Ød	H	L	S	ℓ	Insert	Lever	Screw	Shim	Shim pin	Wrench	Shim Pin Punch						
S20S-PWLNRL/L-06	25	20	18	250	13	40	WN□□0604□□												
S25R-PWLNRL/L-06	32	25	23	200	17	40								LV3B	VHX0512B	-	-	-	-
S32S-PWLNRL/L-06	44	32	30	250	22	45								LV3B	VHX0617B	SW317	SW317	HW25L	LSPS3

➔ Applicable inserts B115



Excellent for precision machining

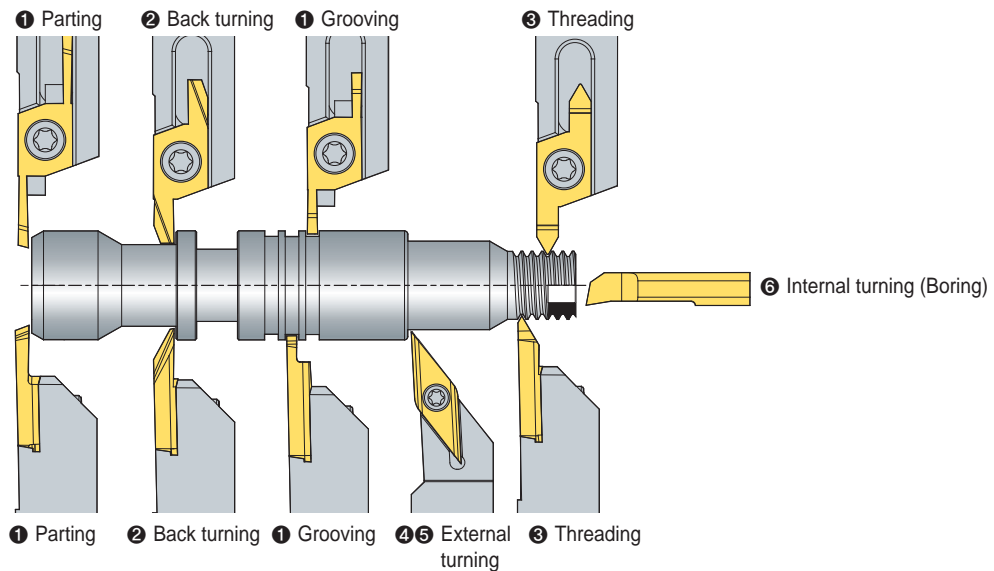
## Auto Tools

- High precision machining of small parts and complex forms, etc.
- High quality products through stable machining
- Exclusive insert for automatic lathes

### Type



### Application example



### Index

Specification	1 Parting and Grooving						2 Back turning			Specification	3 Threading	
<b>Holder</b>	SXGNR/L	SXGNR/L	SBHR/L	SBHR/L	MGEHR/L	KGEHR/L	SXGNR/L	SXGNR/L	SBHR/L	<b>Holder</b>	SXGNR/L	SBHR/L
<b>Insert</b>	SG	SC	SBG	SBC	MGMN	KGMM	SB	SGB	SBB	<b>Insert</b>	ST	SBT
<b>Holder size</b>	10~20mm	10~20mm	10~16mm	10~16mm	10~16mm	10~16mm	10~20mm	10~20mm	10~16mm	<b>Shank diameter</b>	10~20mm	10~16mm
<b>Insert shape</b>										<b>Insert shape</b>		
<b>Cutting width</b>	1~3mm	1~3mm	0.7~2.0mm	0.7~2.0mm	1.5~2.5mm	1.5~2.5mm	2~4mm	2~3mm	3.18mm	<b>ØDmin</b>	Pitch ranges 0.5~1.5 / 1.5~3.0	Pitch ranges 0.2~1.5 / 1.0~2.0
<b>ØDmax</b>	Ø18	Ø18	Ø16	Ø16	Ø32	Ø32	Tmax 8.0	Tmax 8.5	Tmax 8.0	<b>Page</b>	B140	B137
<b>Page</b>	B140	B140	B137	B137	B144	B143	B140	B140	B137			

Specification	4 External turning and Copy machining				5 External turning and Facing			Specification	6 Internal turning (Boring)				
<b>Holder</b>	SDJCR/L	SDNCN	SVJBR/L	SVJCR/L	SCACR/L	SCLCR/L	STACR/L	<b>Holder</b>	SCLCR/L	STUBR/L	STUPR/L	SWUBR/L	MSB
<b>Insert</b>	DC□T	DC□T	VB□T	VC□T	CC□T	CC□T	TC□T	<b>Insert</b>	CC□T	TB□T	TP□T	WB□T	-
<b>Holder size</b>	8~16mm	8~16mm	10~16mm	10~16mm	8~16mm	8~16mm	8~10mm	<b>Shank diameter</b>	Ø4~Ø10	Ø8	Ø8	Ø5~Ø8	Ø4~Ø6
<b>Insert shape</b>								<b>Insert shape</b>					
<b>Feature</b>	Offset "0"				Offset "0"			<b>ØDmin</b>	Ø5	Ø8	Ø10	Ø5.5	Ø3.2
<b>Page</b>	B123	B124	B125	B125	B123	B123	B124	<b>Page</b>	B225	B225	B226	B227	B147~B151



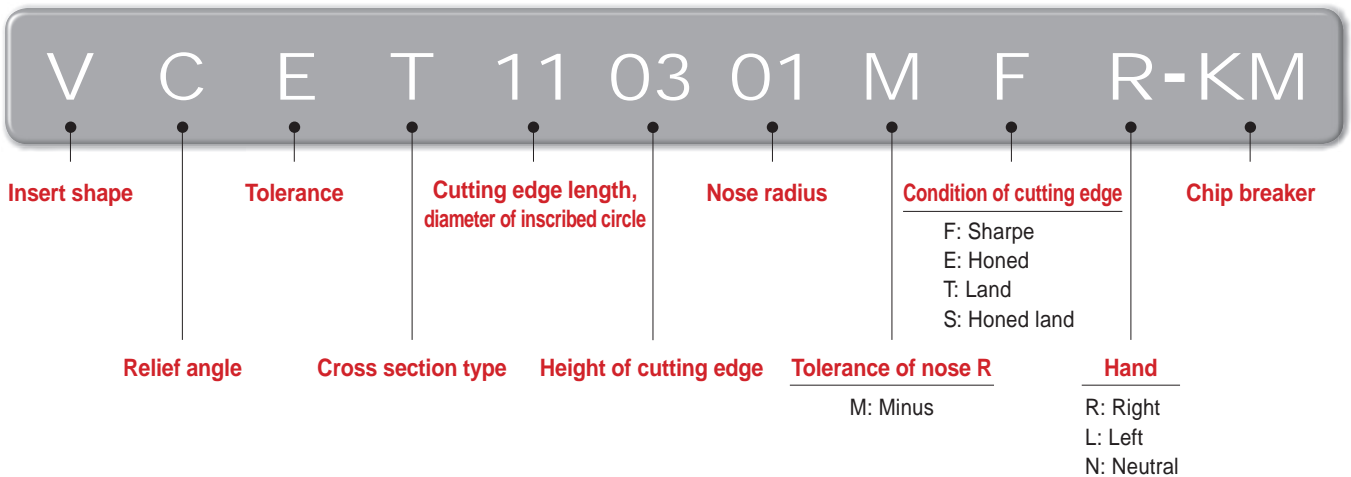
# B Auto Tools (ISO type)

## Auto Tools (ISO type)

- ISO inserts for automatic lathes
- Precise R shape with the use of minus tolerance of nose R
- Tolerance class precise enough in no need for adjusting tools with the use of accurate cutting edge height
- Sharp blade for excellent chip control and surface roughness with low cutting force
- High precision tools for electrical/ electronics instruments and medical instruments


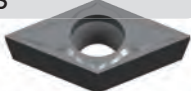



### Code system (ISO type)



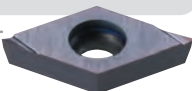
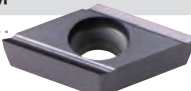
### VP1/MS/FS chip breaker

- Exclusive chip breaker for hard-to-cut materials such as titanium alloy, Inconel, stainless steel, etc.
- Minimized cutting heat by reducing contact area between chips and rake surface with the use of high positive blade

<p>VP1</p> 	<p>MS</p> 	<p>FS</p> 
<ul style="list-style-type: none"> <li>• Hard cutting edge for medium cutting</li> <li>• Optimal width of chip breaker by each depth of cuts realizes wide workpiece machining</li> </ul>	<ul style="list-style-type: none"> <li>• Good surface finish for medium cutting</li> <li>• Preventing welding in titanium machining</li> <li>• Increasing chip evacuation in high feed machining</li> <li>• Protecting cutting edge due to structure for good chip evacuation</li> </ul>	<ul style="list-style-type: none"> <li>• For finishing (for surface roughness)</li> <li>• 1<sup>st</sup> recommended chip breaker for chip control</li> <li>• Better surface roughness, surface finish and chip control</li> </ul>

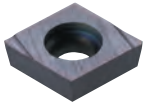
### KF/KM chip breaker, ground type for grooving

- Ground chip breaker with sharp cutting edge
- High precision insert of E-class tolerance with accurate nose radius

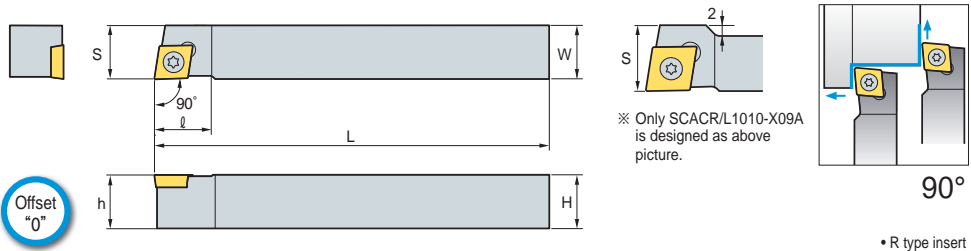
<p>KF</p> 	<p>KM</p> 
<ul style="list-style-type: none"> <li>• For finishing</li> <li>• Low cutting loads with sharp cutting edges</li> <li>• Longer tool life due to lower chip evacuation resistance at high speed</li> <li>• Excellent surface roughness</li> </ul>	<ul style="list-style-type: none"> <li>• For medium cutting to finishing</li> <li>• Better chip flow due to wide chip pockets</li> <li>• Longer tool life and better cutting action due to improved chip evacuation</li> <li>• Excellent surface roughness</li> </ul>



# SCACR/L



CC□T



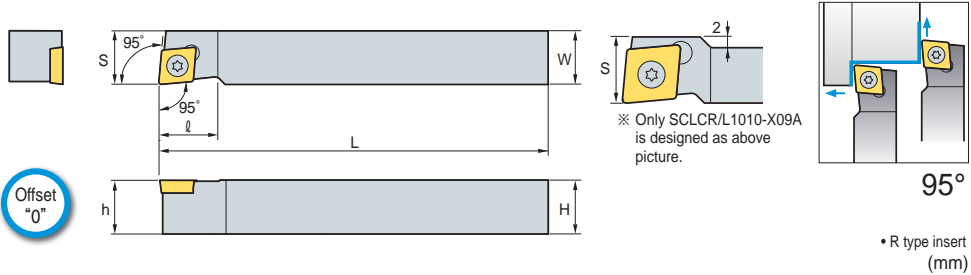
Designation	H	W	L	S	h	l	Insert	Screw	Wrench
SCACR/L 0808-X06A	8	8	120	8	8	10	CC□T0602□□	FTKA02565	TW07P
1010-X06A	10	10	120	10	10	10			
1010-X09A	10	10	120	12	10	13	CC□T09T3□□	FTKA0410	TW15P
1212-X09A	12	12	120	12	12	16			
1616-X09A	16	16	120	16	16	16			

➔ Applicable inserts B73-B77, B103

# SCLCR/L



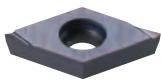
CC□T



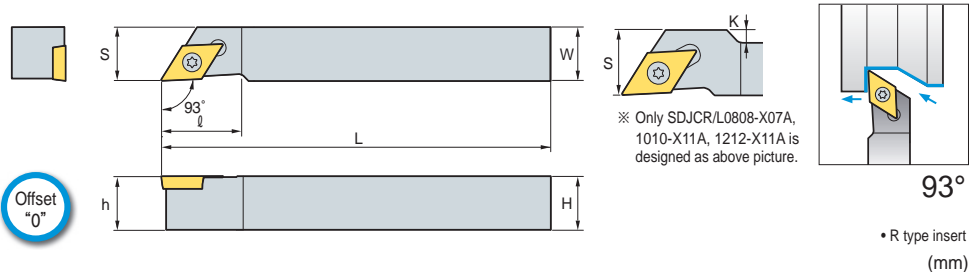
Designation	H	W	L	S	h	l	Insert	Screw	Wrench
SCLCR/L 0808-X06A	8	8	120	8	8	10	CC□T0602□□	FTKA02565	TW07P
1010-X06A	10	10	120	10	10	10			
1010-X09A	10	10	120	12	10	13	CC□T09T3□□	FTKA0410	TW15P
1212-X09A	12	12	120	12	12	16			
1616-X09A	16	16	120	16	16	16			

➔ Applicable inserts B73-B77, B103

# SDJCR/L



DC□T



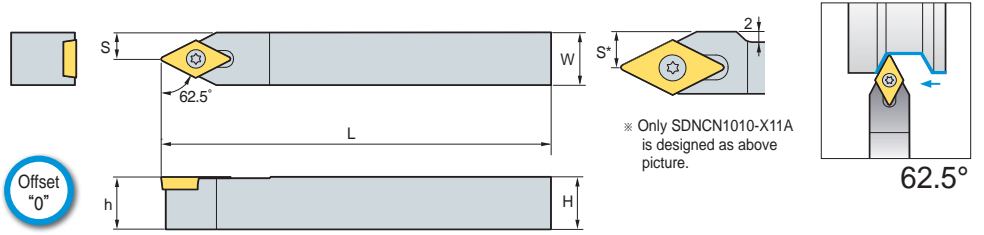
Designation	H	W	L	S	h	K	l	Insert	Screw	Wrench
SDJCR/L 0808-X07A	8	8	120	10	8	2	18	DC□T0702□□	FTKA02565	TW07P
1010-X07A	10	10	120	10	10	-	15			
1010-X11A	10	10	120	14	10	4	18	DC□T11T3□□	FTKA0410	TW15P
1212-X11A	12	12	120	14	12	2	18			
1616-X11A	16	16	120	16	16	-	22			

➔ Applicable inserts B79-B82, B104

## SDNCN



DC□T



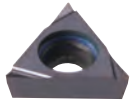
62.5°

• R type insert (mm)

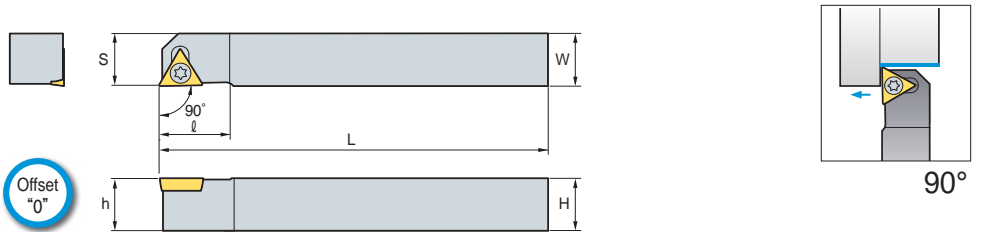
Designation	H	W	L	S	h	Insert	Screw	Wrench
SDNCN 0808-X07A	8	8	120	4	8	DC□T0702□□	FTKA02565	TW 07P
1010-X07A	10	10	120	5	10			
1010-X11A	10	10	120	7	10	DC□T11T3□□	FTKA0410	TW 15P
1212-X11A	12	12	120	6	12			
1616-X11A	16	16	120	8	16			

➔ Applicable inserts B79-B82, B104

## STACR/L



TC□T



90°

• R type insert (mm)

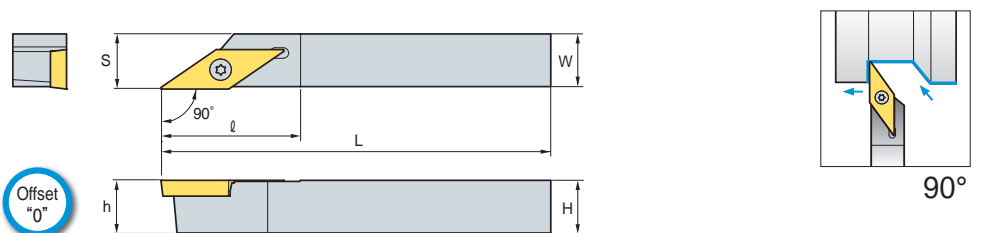
Designation	H	W	L	S	h	K	ℓ	Insert	Screw	Wrench
STACR/L 0808-X08A	8	8	120	8	8	1	12	TC□T0802□□	FTNA0206	TW06P
1010-X08A	10	10	120	10	10	3	12			

➔ Applicable inserts B88-B89, B107

## SVACR/L



VC□□



90°

• R type insert (mm)

Designation	H	W	L	S	h	ℓ	Insert	Screw	Wrench
SVACR/L 0808-X12A	8	8	120	8.5	8	26	VC□□T1203□□	FTKA02565	TW07P
1010-X12A	10	10	120	10.5	10	26			
1212-X12A	12	12	120	12.5	12	26			
1616-X12A	16	16	120	16.5	16	26			
SVACR/L 0808-X12C	8	8	120	8.5	8	26	VC□□X1203□□	FTKA02565	TW07P
1010-X12C	10	10	120	10.5	10	26			
1212-X12C	12	12	120	12.5	12	26			
1616-X12C	16	16	120	16.5	16	26			

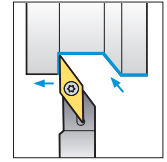
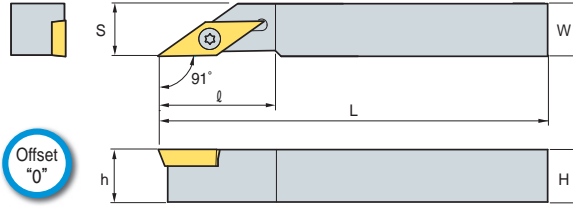
➔ Applicable inserts B97-B99, B109



# SVAPR/L



VP□□



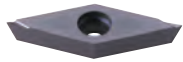
91°

• R type insert (mm)

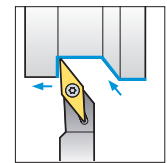
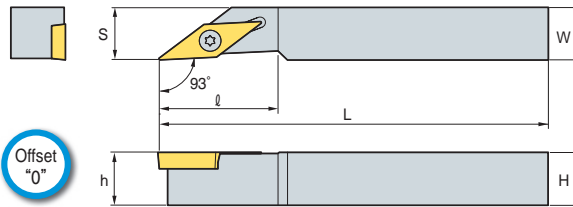
Designation	H	W	L	S	h	ℓ	Insert	Screw	Wrench
SVAPR/L 0808-X11A	8	8	120	8	8	22	VP□□ T1103□□	FTKA02565	TW07P
1010-X11A	10	10	120	10	10	22			
1212-X11A	12	12	120	12	12	22			
1616-X11A	16	16	120	16	16	24			

↻ Applicable inserts B100

# SVJBR/L



VB□□



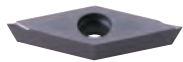
93°

• R type insert (mm)

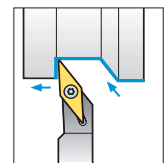
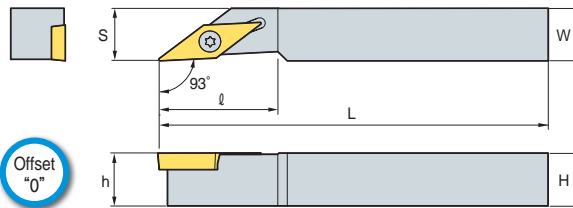
Designation	H	W	L	S	h	ℓ	Insert	Screw	Wrench
SVJBR/L 1010-X11A	10	10	120	10	10	22	VB□□ T1103□□	FTKA02565	TW07P
1212-X11A	12	12	120	12	12	22			
1616-X11A	16	16	120	16	16	24			

↻ Applicable inserts B94-B96, B108

# SVJCR/L



VC□□



93°

• R type insert (mm)

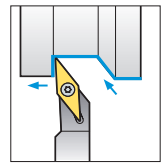
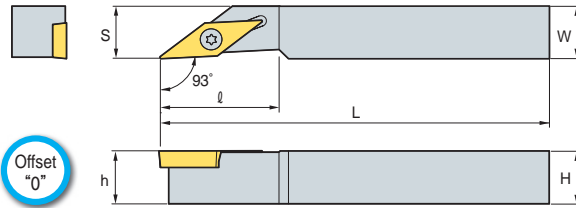
Designation	H	W	L	S	h	ℓ	Insert	Screw	Wrench
SVJCR/L 1010-X11A	10	10	120	10	10	22	VC□□ T1103□□	FTKA02565	TW07P
1212-X11A	12	12	120	12	12	22			
1616-X11A	16	16	120	16	16	24			
0810-X12A	8	10	120	10	8	26	VC□□ T1203□□	FTKA02565	TW07P
1010-X12A	10	10	120	10	10	26			
1212-X12A	12	12	120	12	12	26			
1616-X12A	16	16	120	16	16	26			
SVJCR/L 0810-X12C	8	10	120	10	8	26	VC□□ X1203□□	FTKA02565	TW07P
1010-X12C	10	10	120	10	10	26			
1212-X12C	12	12	120	12	12	26			
1616-X12C	16	16	120	16	16	26			

↻ Applicable inserts B97-B99, B109

## SVJPR/L



VP□T



93°

• R type insert (mm)

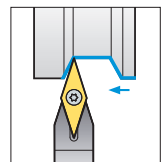
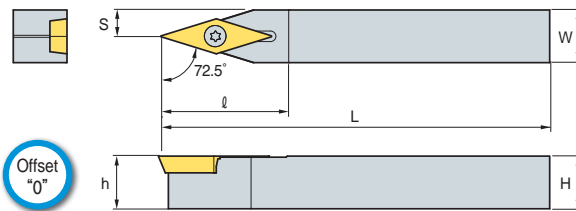
Designation	H	W	L	S	h	ℓ	Insert	Screw	Wrench
<b>SVJPR/L 0810-X11A</b>	8	10	120	8	10	22	VP□T1103□□	FTKA02565	TW07P
<b>1010-X11A</b>	10	10	120	10	10	22			
<b>1212-X11A</b>	12	12	120	12	12	22			
<b>1616-X11A</b>	16	16	120	16	16	24			

↻ Applicable inserts **B100**

## SVVPN



VP□T



72.5°

• R type insert (mm)

Designation	H	W	L	S	h	ℓ	Insert	Screw	Wrench
<b>SVVPN 0808-X11A</b>	8	8	120	4	8	24	VP□T1103□□	FTKA02565	TW07P
<b>1010-X11A</b>	10	10	120	5	10	24			
<b>1212-X11A</b>	12	12	120	6	12	24			
<b>1616-X11A</b>	16	16	120	8	16	28			

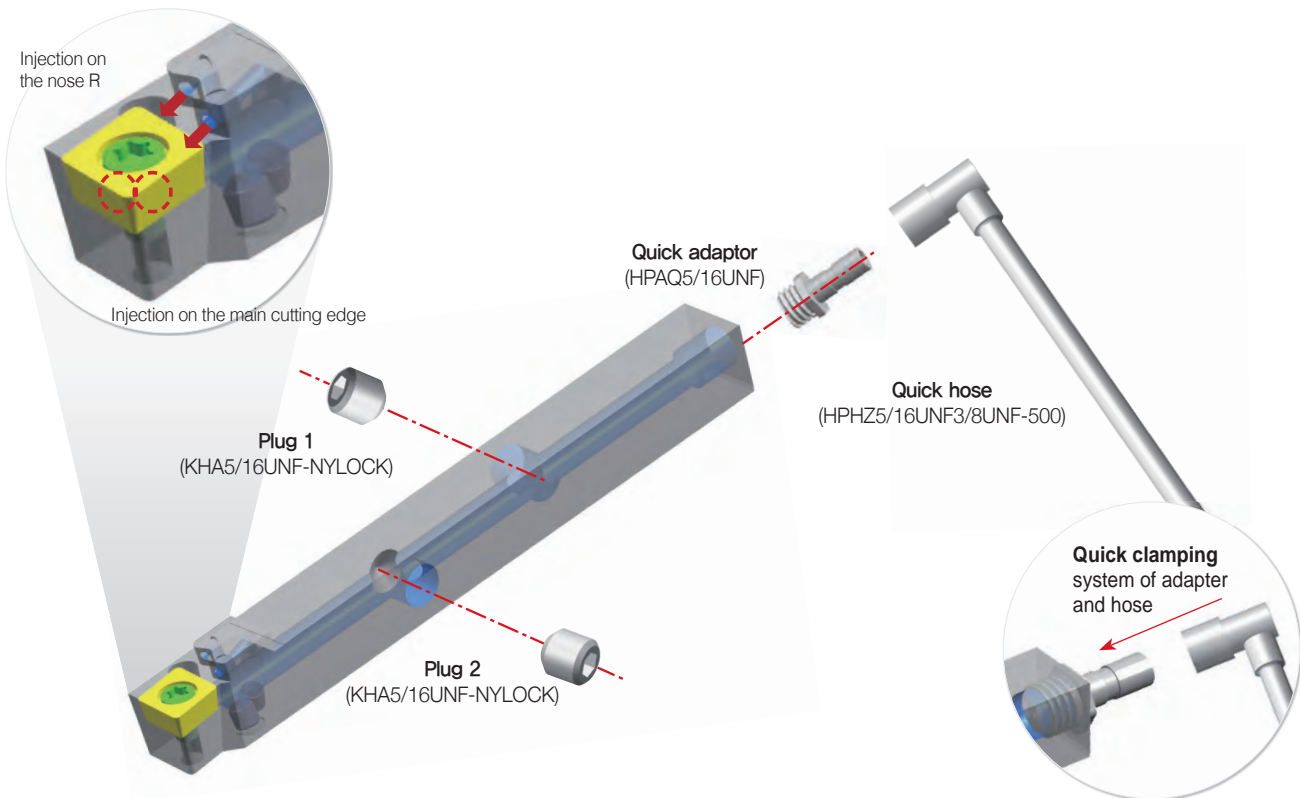
↻ Applicable inserts **B100**



# Auto Tools (KHP Coolant)




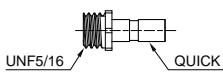
- KORLOY High pressure coolant for high productivity of automatic lathe
- High pressure coolant holder for high productivity of precise parts machining on automatic lathe
- Improved cooling and chip control due to injecting coolant through two holes to the main cutting edge and nose R concentrically
- Two holes with different injection angles each other increase chip control
- Easy clamping system of quick hose adapter and quick hose provides convenient using

## Structure of holder



※ Quick adaptor and quick hose are sold separately

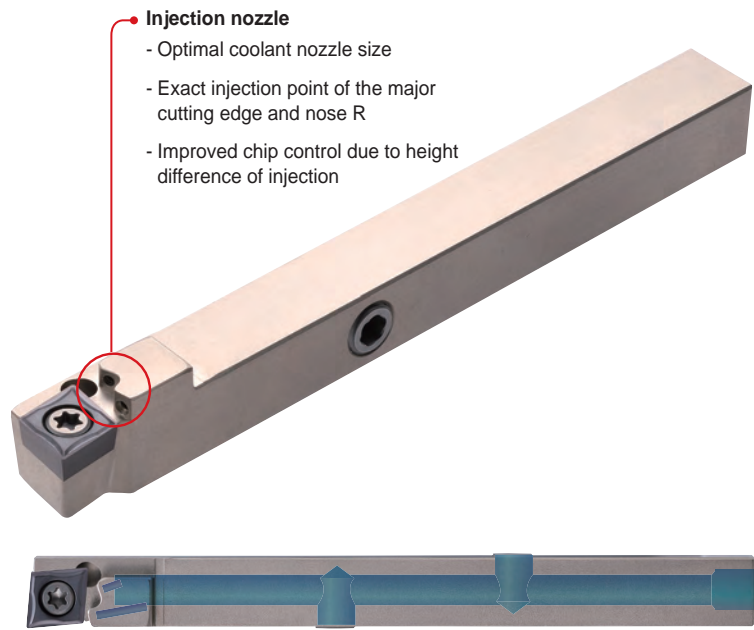
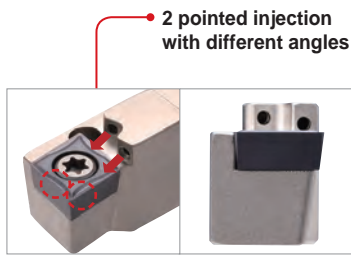
## Parts

	Shape	Configuration	Length	Q clamping dimensions	S clamping dimensions
Quick to straight	HPHZ5/16UNF3/8UNF-500 		500 mm	UNF5/16	-
Quick adaptor	HPAQ5/16UNF 		18.5 mm	UNF5/16	



# B Auto Tools (KHP Coolant)

## Features



- Injection nozzle**
- Optimal coolant nozzle size
  - Exact injection point of the major cutting edge and nose R
  - Improved chip control due to height difference of injection

### Max 300 bar

Workpiece	The minimum pressure	The maximum pressure
P	100	300
M	120	
K	110	
N	100	
S	120	

## Parts

Devision	Designation	Shape	
Adaptor	HPA3/8UNF1/8PF		
Blank	HPB1/8PF		
Quick adaptor	HPAQ5/16UNF		

## High pressure hose

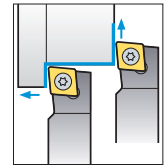
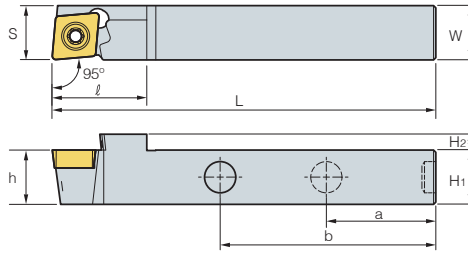
	Shape	length	Q clamping dimensions	S clamping dimensions
Quick to straight (HPHZ5/16UNF3/8UNF-500)		500 mm	UNF5/16	-



# SCLCR/L



CC□T



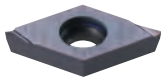
95°

• R type insert (mm)

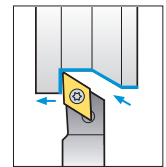
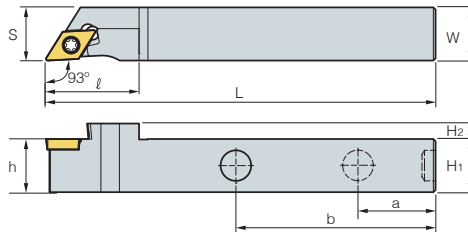
Designation	H <sub>1</sub>	H <sub>2</sub>	W	L	S	h	ℓ	a	b	Insert	Screw	Plug	Wrench
SCLCR/L 1212-X09A-KHP	12	3.5	12	120	12	12	21	40	70	CC□T09T3□□	FTKA0410	KHA0404-NYLOCK	TW15P

➔ Applicable inserts B66-69, B91

# SDJCR/L



DC□T



93°

• R type insert (mm)

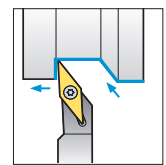
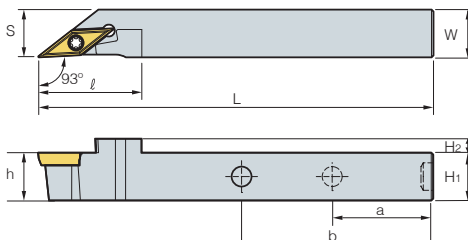
Designation	H <sub>1</sub>	H <sub>2</sub>	W	L	S	h	ℓ	a	b	Insert	Screw	Plug	Wrench
SDJCR/L 1212-X07A-KHP	12	3.5	12	120	12	12	21	40	70	DC□T0702□□	FTKA02565	KHA0404-NYLOCK	TW07P
1212-X11A-KHP	12	3.5	12	120	14	12	29.8	40	70	DC□T11T3□□	FTKA0408	KHA0404-NYLOCK	TW15P

➔ Applicable inserts B71-73, B92

# SVJCR/L



VC□□



93°

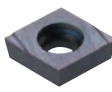
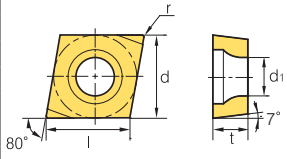
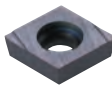
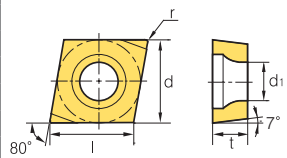

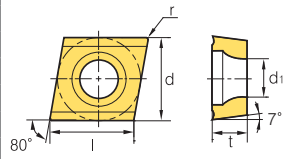
• R type insert (mm)

Designation	H <sub>1</sub>	H <sub>2</sub>	W	L	S	h	ℓ	a	b	Insert	Screw	Plug	Wrench
SVJCR/L 1212-X11A-KHP	12	3.5	12	120	12	12	26	40	70	VC□T1103□□	FTKA02565	KHA0404-NYLOCK	TW07P
1212-X12A-KHP	12	3.5	12	120	12	12	26	40	70	VC□□1203□□	FTKA02565	KHA0404-NYLOCK	TW07P

➔ Applicable inserts B86-B87, B97




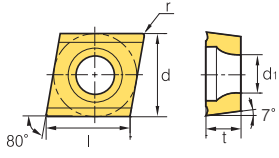
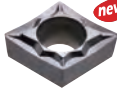
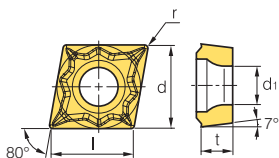
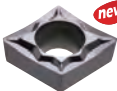
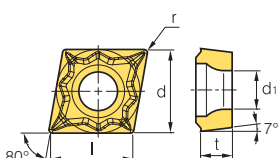

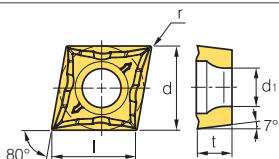
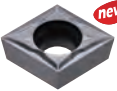
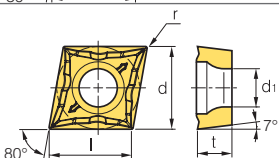

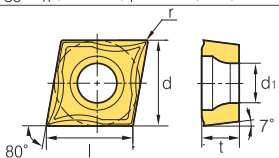

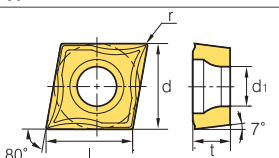
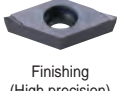
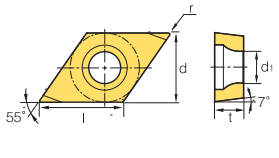
## Insert

Picture	Designation	Coated				Uncoated	Dimensions (mm)					Configuration
		PC5300	PC8105	PC8110	PC8115	H01	l	d	t	r	d <sub>1</sub>	
 <p>Finishing (High precision)</p>	0301003R-KF	●		●			3.6	3.5	1.39	0.03	1.9	
	030101R-KF	●		●			3.5	3.5	1.39	0.10	1.9	
	030102R-KF	●		●			3.5	3.5	1.39	0.20	1.9	
	030104R-KF	●		●			3.5	3.5	1.39	0.40	1.9	
	0401003R-KF	●		●			4.4	4.3	1.79	0.03	2.3	
	040101R-KF	●		●			4.4	4.3	1.79	0.10	2.3	
	040102R-KF	●		●			4.3	4.3	1.79	0.20	2.3	
	040104R-KF	●		●			4.3	4.3	1.79	0.40	2.3	
	0602003R-KF						6.6	6.35	2.38	0.03	2.8	
	060201R-KF						6.4	6.35	2.38	0.10	2.8	
	060202R-KF						6.2	6.35	2.38	0.20	2.8	
	09T3003R-KF						9.8	9.525	3.97	0.03	4.4	
	09T301R-KF						9.6	9.525	3.97	0.10	4.4	
	09T302R-KF						9.2	9.525	3.97	0.20	4.4	
	0301003L-KF	●		●			3.6	3.5	1.39	0.03	1.9	
	030101L-KF	●		●			3.5	3.5	1.39	0.10	1.9	
	030102L-KF	●		●			3.5	3.5	1.39	0.20	1.9	
	030104L-KF	●		●			3.5	3.5	1.39	0.40	1.9	
	0401003L-KF	●		●			4.4	4.3	1.79	0.03	2.3	
	040101L-KF	●		●			4.4	4.3	1.79	0.10	2.3	
	040102L-KF	●		●			4.3	4.3	1.79	0.20	2.3	
	040104L-KF	●		●			4.3	4.3	1.79	0.40	2.3	
	0602003L-KF						6.6	6.35	2.38	0.03	2.8	
	060201L-KF						6.4	6.35	2.38	0.10	2.8	
	060202L-KF						6.2	6.35	2.38	0.20	2.8	
	09T3003L-KF						9.8	9.525	3.97	0.03	4.4	
	09T301L-KF						9.6	9.525	3.97	0.10	4.4	
	09T302L-KF						9.2	9.525	3.97	0.20	4.4	
 <p>Finishing (Ultra high precision)</p>	0602005MFR-KF	●		●			6.6	6.35	2.38	< 0.05	2.8	
	060201MFR-KF	●		●			6.4	6.35	2.38	< 0.10	2.8	
	060202MFR-KF	●		●			6.2	6.35	2.38	< 0.20	2.8	
	09T3005MFR-KF	●		●			9.8	9.525	3.97	< 0.05	4.4	
	09T301MFR-KF	●		●			9.6	9.525	3.97	< 0.10	4.4	
	09T302MFR-KF	●		●			9.2	9.525	3.97	< 0.20	4.4	
	0602005MFL-KF	●		●			6.6	6.35	2.38	< 0.05	2.8	
	060201MFL-KF	●		●			6.4	6.35	2.38	< 0.10	2.8	
	060202MFL-KF	●		●			6.2	6.35	2.38	< 0.20	2.8	
	09T3005MFL-KF	●		●			9.8	9.525	3.97	< 0.05	4.4	
09T301MFL-KF	●		●			9.6	9.525	3.97	< 0.10	4.4		
09T302MFL-KF	●		●			9.2	9.525	3.97	< 0.20	4.4		
 <p>Medium to finishing (High precision)</p>	0602003R-KM	●		●			6.6	6.35	2.38	0.03	2.8	
	060201R-KM	●		●			6.4	6.35	2.38	0.10	2.8	
	060202R-KM	●		●			6.2	6.35	2.38	0.20	2.8	
	060204R-KM	●		●			6.2	6.35	2.38	0.40	2.8	
	09T3003R-KM	●		●			9.8	9.525	3.97	0.03	4.4	
	09T301R-KM	●		●			9.6	9.525	3.97	0.10	4.4	
	09T302R-KM	●		●			9.2	9.525	3.97	0.20	4.4	
	09T304R-KM	●		●			9.2	9.525	3.97	0.40	4.4	
	0602003L-KM	●		●			6.6	6.35	2.38	0.03	2.8	
	060201L-KM	●		●			6.4	6.35	2.38	0.10	2.8	
	060202L-KM	●		●			6.2	6.35	2.38	0.20	2.8	
	060204L-KM	●		●			6.2	6.35	2.38	0.40	2.8	
	09T3003L-KM	●		●			9.8	9.525	3.97	0.03	4.4	
	09T301L-KM	●		●			9.6	9.525	3.97	0.10	4.4	
09T302L-KM	●		●			9.2	9.525	3.97	0.20	4.4		
09T304L-KM	●		●			9.2	9.525	3.97	0.40	4.4		

● : Stock item



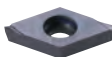
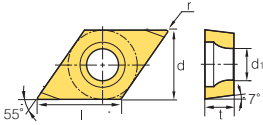
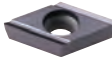
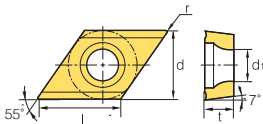

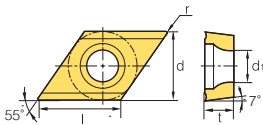

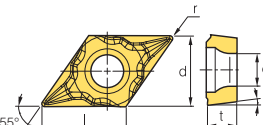

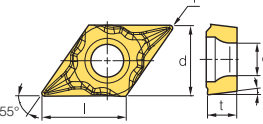
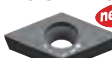
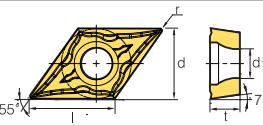
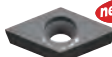
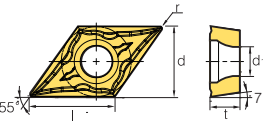
**Insert**

Picture	Designation	Coated				Uncoated	Dimensions (mm)					Configuration
		PC5300	PC8105	PC8110	PC8115	H01	l	d	t	r	d1	
 CCET-KM Medium to finishing (Ultra high precision)	0602005MFR-KM	●		●			6.6	6.35	2.38	< 0.05	2.8	
	060201MFR-KM	●		●			6.4	6.35	2.38	< 0.10	2.8	
	060202MFR-KM	●		●			6.2	6.35	2.38	< 0.20	2.8	
	09T3005MFR-KM	●		●			9.8	9.525	3.97	< 0.05	4.4	
	09T301MFR-KM	●		●			9.6	9.525	3.97	< 0.10	4.4	
	09T302MFR-KM	●		●			9.2	9.525	3.97	< 0.20	4.4	
	0602005MFL-KM	●		●			6.6	6.35	2.38	< 0.05	2.8	
	060201MFL-KM	●		●			6.4	6.35	2.38	< 0.10	2.8	
	060202MFL-KM	●		●			6.2	6.35	2.38	< 0.20	2.8	
	09T3005MFL-KM	●		●			9.8	9.525	3.97	< 0.05	4.4	
09T301MFL-KM	●		●			9.6	9.525	3.97	< 0.10	4.4		
09T302MFL-KM	●		●			9.2	9.525	3.97	< 0.20	4.4		
 CCGT-FS Finishing (High precision)	060201-FS	●		●			6.3	6.35	2.38	0.10	2.8	
	060202-FS	●		●			6.2	6.35	2.38	0.20	2.8	
	060204-FS	●		●			6.0	6.35	2.38	0.40	2.8	
	09T301-FS	●		●			9.8	9.525	3.97	0.10	4.4	
	09T302-FS	●		●			9.6	9.525	3.97	0.20	4.4	
	09T304-FS	●		●			9.2	9.525	3.97	0.40	4.4	
09T308-FS	●		●			8.8	9.525	3.97	0.80	4.4		
 CCGT-FS Finishing (Ultra high precision)	060201MFN-FS	●		●			6.3	6.35	2.38	< 0.10	2.8	
	060202MFN-FS	●		●			6.2	6.35	2.38	< 0.20	2.8	
	060204MFN-FS	●		●			6.0	6.35	2.38	< 0.40	2.8	
	09T301MFN-FS	●		●			9.8	9.525	3.97	< 0.10	4.4	
	09T302MFN-FS	●		●			9.6	9.525	3.97	< 0.20	4.4	
	09T304MFN-FS	●		●			9.2	9.525	3.97	< 0.40	4.4	
09T308MFN-FS	●		●			8.8	9.525	3.97	< 0.80	4.4		
 CCGT-MS Medium cutting (High precision)	09T301-MS	●		●			9.8	9.525	3.97	0.10	4.4	
	09T302-MS	●		●			9.6	9.525	3.97	0.20	4.4	
	09T304-MS	●		●			9.2	9.525	3.97	0.40	4.4	
 CCGT-MS Medium cutting (Ultra high precision)	09T301MFN-MS	●		●			9.8	9.525	3.97	< 0.10	4.4	
	09T302MFN-MS	●		●			9.6	9.525	3.97	< 0.20	4.4	
	09T304MFN-MS	●		●			9.2	9.525	3.97	< 0.40	4.4	
 CCGT-VP1 Finishing (High precision)	60201-VP1	●	●	●	●	●	6.6	6.35	2.38	0.10	2.8	
	60202-VP1	●	●	●	●	●	6.4	6.35	2.38	0.20	2.8	
	60204-VP1	●	●	●	●	●	6.2	6.35	2.38	0.40	2.8	
	09T301-VP1	●	●	●	●	●	9.8	9.525	3.97	0.10	4.4	
	09T302-VP1	●	●	●	●	●	9.6	9.525	3.97	0.20	4.4	
	09T304-VP1	●	●	●	●	●	9.2	9.525	3.97	0.40	4.4	
 CCGT-VP1 Finishing (Ultra high precision)	060201MFN-VP1	●		●			6.6	6.35	2.38	< 0.10	2.8	
	060202MFN-VP1	●		●			6.4	6.35	2.38	< 0.20	2.8	
	060204MFN-VP1	●		●			6.2	6.35	2.38	< 0.40	2.8	
	09T301MFN-VP1	●		●			9.8	9.525	3.97	< 0.10	4.4	
	09T302MFN-VP1	●		●			9.6	9.525	3.97	< 0.20	4.4	
	09T304MFN-VP1	●		●			9.2	9.525	3.97	< 0.40	4.4	
 DCGT-KF Finishing (High precision)	0702003R-KF	●		●			7.8	6.35	2.38	0.03	2.8	
	070201R-KF	●		●			7.8	6.35	2.38	0.10	2.8	
	070202R-KF	●		●			7.8	6.35	2.38	0.20	2.8	
	070204R-KF	●		●			7.8	6.35	2.38	0.40	2.8	
	11T3003R-KF	●		●			11.6	9.525	3.97	0.03	4.4	
	11T301R-KF	●		●			11.6	9.525	3.97	0.10	4.4	
	11T302R-KF	●		●			11.6	9.525	3.97	0.20	4.4	
	11T304R-KF	●		●			11.6	9.525	3.97	0.40	4.4	
	0702003L-KF	●		●			7.8	6.35	2.38	0.03	2.8	
	070201L-KF	●		●			7.8	6.35	2.38	0.10	2.8	
	070202L-KF	●		●			7.8	6.35	2.38	0.20	2.8	
	070204L-KF	●		●			7.8	6.35	2.38	0.40	2.8	
	11T3003L-KF	●		●			11.6	9.525	3.97	0.03	4.4	
	11T301L-KF	●		●			11.6	9.525	3.97	0.10	4.4	
11T302L-KF	●		●			11.6	9.525	3.97	0.20	4.4		
11T304L-KF	●		●			11.6	9.525	3.97	0.40	4.4		

●: Stock item




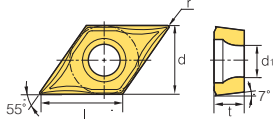

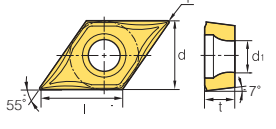

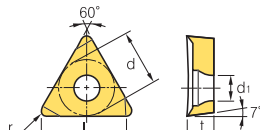

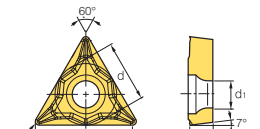

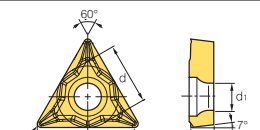

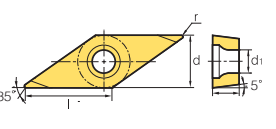

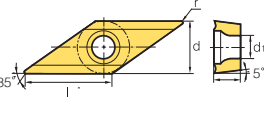

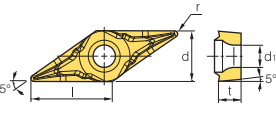

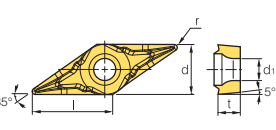

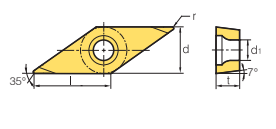
## Insert

Picture	Designation	Coated				Uncoated	Dimensions (mm)					Configuration
		PC5300	PC8105	PC8110	PC8115	H01	l	d	t	r	d <sub>1</sub>	
 <p>Finishing (Ultra high precision)</p>	0702005MFR-KF	●		●			7.8	6.35	2.38	< 0.05	2.8	
	070201MFR-KF	●		●			7.8	6.35	2.38	< 0.10	2.8	
	070202MFR-KF	●		●			7.8	6.35	2.38	< 0.20	2.8	
	11T3005MFR-KF	●		●			11.6	9.525	3.97	< 0.05	4.4	
	11T301MFR-KF	●		●			11.6	9.525	3.97	< 0.10	4.4	
	11T302MFR-KF	●		●			11.6	9.525	3.97	< 0.20	4.4	
	0702005MFL-KF	●		●			7.8	6.35	2.38	< 0.05	2.8	
	070201MFL-KF	●		●			7.8	6.35	2.38	< 0.10	2.8	
	070202MFL-KF	●		●			7.8	6.35	2.38	< 0.20	2.8	
	11T3005MFL-KF	●		●			11.6	9.525	3.97	< 0.05	4.4	
	11T301MFL-KF	●		●			11.6	9.525	3.97	< 0.10	4.4	
11T302MFL-KF	●		●			11.6	9.525	3.97	< 0.20	4.4		
 <p>Medium to finishing (High precision)</p>	0702003R-KM	●		●			7.8	6.35	2.38	0.03	2.8	
	070201R-KM	●		●			7.8	6.35	2.38	0.10	2.8	
	070202R-KM	●		●			7.8	6.35	2.38	0.20	2.8	
	070204R-KM	●		●			7.8	6.35	2.38	0.40	2.8	
	11T3003R-KM	●		●			11.6	9.525	3.97	0.03	4.4	
	11T301R-KM	●		●			11.6	9.525	3.97	0.10	4.4	
	11T302R-KM	●		●			11.6	9.525	3.97	0.20	4.4	
	11T304R-KM	●		●			11.6	9.525	3.97	0.40	4.4	
	0702003L-KM	●		●			7.8	6.35	2.38	0.03	2.8	
	070201L-KM	●		●			7.8	6.35	2.38	0.10	2.8	
	070202L-KM	●		●			7.8	6.35	2.38	0.20	2.8	
	070204L-KM	●		●			7.8	6.35	2.38	0.40	2.8	
	11T3003L-KM	●		●			11.6	9.525	3.97	0.03	4.4	
	11T301L-KM	●		●			11.6	9.525	3.97	0.10	4.4	
11T302L-KM	●		●			11.6	9.525	3.97	0.20	4.4		
11T304L-KM	●		●			11.6	9.525	3.97	0.40	4.4		
 <p>Medium to finishing (Ultra high precision)</p>	0702005MFR-KM	●		●			7.8	6.35	2.38	< 0.05	2.8	
	070201MFR-KM	●		●			7.8	6.35	2.38	< 0.10	2.8	
	070202MFR-KM	●		●			7.8	6.35	2.38	< 0.20	2.8	
	11T3005MFR-KM	●		●			11.6	9.525	3.97	< 0.05	4.4	
	11T301MFR-KM	●		●			11.6	9.525	3.97	< 0.10	4.4	
	11T302MFR-KM	●		●			11.6	9.525	3.97	< 0.20	4.4	
	0702005MFL-KM	●		●			7.8	6.35	2.38	< 0.05	2.8	
	070201MFL-KM	●		●			7.8	6.35	2.38	< 0.10	2.8	
	070202MFL-KM	●		●			7.8	6.35	2.38	< 0.20	2.8	
	11T3005MFL-KM	●		●			11.6	9.525	3.97	< 0.05	4.4	
	11T301MFL-KM	●		●			11.6	9.525	3.97	< 0.10	4.4	
11T302MFL-KM	●		●			11.6	9.525	3.97	< 0.20	4.4		
 <p>Finishing (High precision)</p>	070201-FS	●		●			7.6	6.35	2.38	0.10	2.8	
	070202-FS	●		●			7.5	6.35	2.38	0.20	2.8	
	11T301-FS	●		●			11.6	9.525	3.97	0.10	4.4	
	11T302-FS	●		●			11.6	9.525	3.97	0.20	4.4	
	11T304-FS	●		●			11.6	9.525	3.97	0.40	4.4	
	11T308-FS	●		●			11.6	9.525	3.97	0.80	4.4	
 <p>Finishing (Ultra high precision)</p>	070201MFN-FS						7.6	6.35	2.38	< 0.10	2.8	
	070202MFN-FS						7.5	6.35	2.38	< 0.20	2.8	
	11T301MFN-FS						11.6	9.525	3.97	< 0.10	4.4	
	11T302MFN-FS						11.4	9.525	3.97	< 0.20	4.4	
	11T304MFN-FS						11.2	9.525	3.97	< 0.40	4.4	
	11T308MFN-FS						11.0	9.525	3.97	< 0.80	4.4	
 <p>Medium cutting (High precision)</p>	11T301-MS	●		●			11.6	9.525	3.97	0.10	4.4	
	11T302-MS	●		●			11.6	9.525	3.97	0.20	4.4	
	11T304-MS	●		●			11.6	9.525	3.97	0.40	4.4	
 <p>Medium cutting (Ultra high precision)</p>	11T301MFN-MS	●		●			11.6	9.525	3.97	< 0.10	4.4	
	11T302MFN-MS	●		●			11.6	9.525	3.97	< 0.20	4.4	
	11T304MFN-MS	●		●			11.6	9.525	3.97	< 0.40	4.4	

● : Stock item



**Insert**


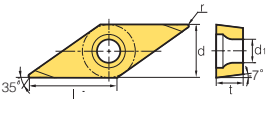

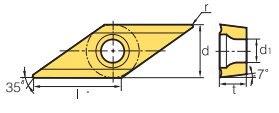

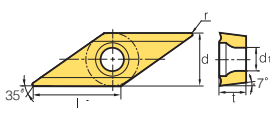

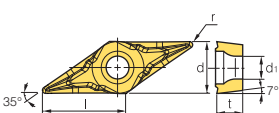

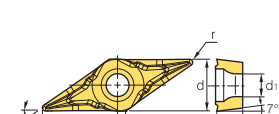

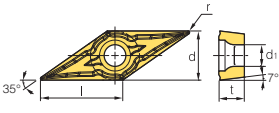

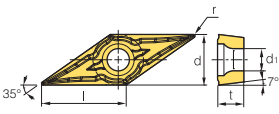

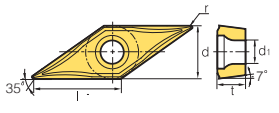

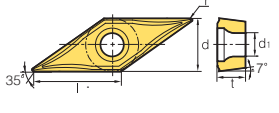

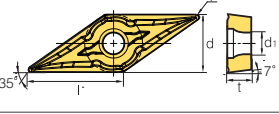

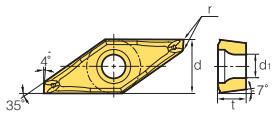
Picture	Designation	Coated				Uncoated	Dimensions (mm)					Configuration
		PC5300	PC8105	PC8110	PC8115		H01	l	d	t	r	
 Finishing (High precision)	070201-VP1	●	●	●	●	●	7.8	6.35	2.38	0.10	2.8	
	070202-VP1	●	●	●	●	●	7.8	6.35	2.38	0.20	2.8	
	070204-VP1	●	●	●	●	●	7.8	6.35	2.38	0.40	2.8	
	11T301-VP1	●	●	●	●	●	11.6	9.525	3.97	0.10	4.4	
	11T302-VP1	●	●	●	●	●	11.6	9.525	3.97	0.20	4.4	
	11T304-VP1	●	●	●	●	●	11.6	9.525	3.97	0.40	4.4	
 Finishing (Ultra high precision)	070201MFN-VP1	●	●	●	●	●	7.8	6.35	2.38	< 0.10	2.8	
	070202MFN-VP1	●	●	●	●	●	7.8	6.35	2.38	< 0.20	2.8	
	070204MFN-VP1	●	●	●	●	●	7.8	6.35	2.38	< 0.40	2.8	
	11T301MFN-VP1	●	●	●	●	●	11.6	9.525	3.97	< 0.10	4.4	
	11T302MFN-VP1	●	●	●	●	●	11.6	9.525	3.97	< 0.20	4.4	
	11T304MFN-VP1	●	●	●	●	●	11.6	9.525	3.97	< 0.40	4.4	
 Finishing (High precision)	0802003R-KF	●	●	●	●	●	8.15	4.76	2.38	0.03	2.38	
	080201R-KF	●	●	●	●	●	8.0	4.76	2.38	0.10	2.38	
	080202R-KF	●	●	●	●	●	7.7	4.76	2.38	0.20	2.38	
	08020003L-KF	●	●	●	●	●	8.15	4.76	2.38	0.03	2.38	
	080201L-KF	●	●	●	●	●	8.0	4.76	2.38	0.10	2.38	
	080202L-KF	●	●	●	●	●	7.7	4.76	2.38	0.20	2.38	
 Finishing (High precision)	110201-FS	●	●	●	●	●	9.3	6.35	2.38	0.10	2.8	
	110202-FS	●	●	●	●	●	9.1	6.35	2.38	0.20	2.8	
	110204-FS	●	●	●	●	●	8.6	6.35	2.38	0.40	2.8	
 Finishing (Ultra high precision)	110201MFN-FS	●	●	●	●	●	9.3	6.35	3.18	< 0.10	3.4	
	110202MFN-FS	●	●	●	●	●	9.1	6.35	3.18	< 0.20	3.4	
	110204MFN-FS	●	●	●	●	●	8.6	6.35	3.18	< 0.40	3.4	
 Finishing (High precision)	1103003R-KF	●	●	●	●	●	7.8	6.35	2.38	0.03	2.8	
	110301R-KF	●	●	●	●	●	7.8	6.35	2.38	0.10	2.8	
	110302R-KF	●	●	●	●	●	7.8	6.35	2.38	0.20	2.8	
	1103003L-KF	●	●	●	●	●	11.6	9.525	3.97	0.03	4.4	
	110301L-KF	●	●	●	●	●	11.6	9.525	3.97	0.10	4.4	
	110302L-KF	●	●	●	●	●	11.6	9.525	3.97	0.20	4.4	
 Medium to finishing (High precision)	1103003R-KM	●	●	●	●	●	7.8	6.35	2.38	0.03	2.8	
	110301R-KM	●	●	●	●	●	7.8	6.35	2.38	0.10	2.8	
	110302R-KM	●	●	●	●	●	7.8	6.35	2.38	0.20	2.8	
	1103003L-KM	●	●	●	●	●	11.6	9.525	3.97	0.03	4.4	
	110301L-KM	●	●	●	●	●	11.6	9.525	3.97	0.10	4.4	
	110302L-KM	●	●	●	●	●	11.6	9.525	3.97	0.20	4.4	
 Finishing (High precision)	110301-FS	●	●	●	●	●	11.0	6.35	3.18	0.10	2.8	
	110302-FS	●	●	●	●	●	11.0	6.35	3.18	0.20	2.8	
	110304-FS	●	●	●	●	●	11.0	6.35	3.18	0.40	2.8	
	160401-FS	●	●	●	●	●	16.3	9.525	4.76	0.10	4.4	
	160402-FS	●	●	●	●	●	16.1	9.525	4.76	0.20	4.4	
	160404-FS	●	●	●	●	●	15.7	9.525	4.76	0.40	4.4	
 Finishing (Ultra high precision)	110301MFN-FS	●	●	●	●	●	10.8	6.35	3.18	< 0.10	2.8	
	110302MFN-FS	●	●	●	●	●	10.6	6.35	3.18	< 0.20	2.8	
	110304MFN-FS	●	●	●	●	●	11.4	6.35	3.18	< 0.40	2.8	
	160401MFN-FS	●	●	●	●	●	16.3	9.525	4.76	< 0.10	4.4	
	160402MFN-FS	●	●	●	●	●	16.1	9.525	4.76	< 0.20	4.4	
	160404MFN-FS	●	●	●	●	●	15.7	9.525	4.76	< 0.40	4.4	
 Finishing (High precision)	1103003R-KF	●	●	●	●	●	11.0	6.35	3.18	0.03	2.8	
	110301R-KF	●	●	●	●	●	11.0	6.35	3.18	0.10	2.8	
	110302R-KF	●	●	●	●	●	11.0	6.35	3.18	0.20	2.8	
	1103003L-KF	●	●	●	●	●	11.0	6.35	3.18	0.03	2.8	
	110301L-KF	●	●	●	●	●	11.0	6.35	3.18	0.10	2.8	
	110302L-KF	●	●	●	●	●	11.0	6.35	3.18	0.20	2.8	

● : Stock item






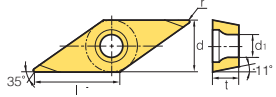

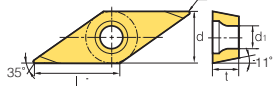

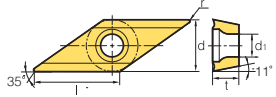

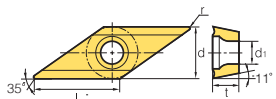

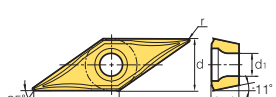

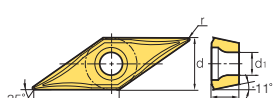
## Insert

Picture	Designation	Coated				Uncoated	Dimensions (mm)					Configuration
		PC5300	PC8105	PC8110	PC8115	H01	l	d	t	r	d <sub>1</sub>	
 Finishing (Ultra high precision)	1103005MFR-KF	●		●			11.0	6.35	3.18	< 0.05	2.8	
	110301MFR-KF	●		●			11.0	6.35	3.18	< 0.10	2.8	
	110302MFR-KF	●		●			11.0	6.35	3.18	< 0.20	2.8	
	1103005MFL-KF	●		●			11.0	6.35	3.18	< 0.05	2.8	
	110301MFL-KF	●		●			11.0	6.35	3.18	< 0.10	2.8	
	110302MFL-KF	●		●			11.0	6.35	3.18	< 0.20	2.8	
 Medium to finishing (High precision)	1103003R-KM						11.0	6.35	3.18	0.03	2.8	
	110301R-KM						11.0	6.35	3.18	0.10	2.8	
	110302R-KM						11.0	6.35	3.18	0.20	2.8	
	1103003L-KM						11.0	6.35	3.18	0.03	2.8	
	110301L-KM						11.0	6.35	3.18	0.10	2.8	
	110302L-KM						11.0	6.35	3.18	0.20	2.8	
 Medium to finishing (Ultra high precision)	1103005MFR-KM	●		●			11.0	6.35	3.18	< 0.05	2.8	
	110301MFR-KM	●		●			11.0	6.35	3.18	< 0.10	2.8	
	110302MFR-KM	●		●			11.0	6.35	3.18	< 0.20	2.8	
	3005MFL-KM	●		●			11.0	6.35	3.18	< 0.05	2.8	
	301MFL-KM	●		●			11.0	6.35	3.18	< 0.10	2.8	
	302MFL-KM	●		●			11.0	6.35	3.18	< 0.20	2.8	
 Finishing (High precision)	110301-FS	●		●			11.0	6.35	3.18	0.10	2.8	
	110302-FS	●		●			11.0	6.35	3.18	0.20	2.8	
	110304-FS	●		●			11.0	6.35	3.18	0.40	2.8	
	160401-FS	●		●			16.3	9.525	4.76	0.10	4.4	
	160402-FS	●		●			16.1	9.525	4.76	0.20	4.4	
	160404-FS	●		●			15.7	9.525	4.76	0.40	4.4	
 Finishing (Ultra high precision)	110301MFN-FS						10.8	6.35	3.18	< 0.10	2.8	
	110302MFN-FS						10.6	6.35	3.18	< 0.20	2.8	
	110304MFN-FS						11.4	6.35	3.18	< 0.40	2.8	
	160401MFN-FS						16.3	9.525	4.76	< 0.10	4.4	
	160402MFN-FS						16.1	9.525	4.76	< 0.20	4.4	
	160404MFN-FS						15.7	9.525	4.76	< 0.40	4.4	
 Medium cutting (High precision)	110301-MS	●		●			10.8	6.35	3.18	0.10	2.8	
	110302-MS	●		●			10.6	6.35	3.18	0.20	2.8	
	110304-MS	●		●			11.4	6.35	3.18	0.40	2.8	
 Medium cutting (Ultra high precision)	11T301MFN-MS	●		●			10.8	6.35	3.18	< 0.10	2.8	
	11T302MFN-MS	●		●			10.6	6.35	3.18	< 0.20	2.8	
	11T304MFN-MS	●		●			11.4	6.35	3.18	< 0.40	2.8	
 Finishing (High precision)	110301-VP1	●	●	●	●	●	11.0	6.35	3.18	0.10	2.8	
	110302-VP1	●	●	●	●	●	11.0	6.35	3.18	0.20	2.8	
	110304-VP1	●	●	●	●	●	11.0	6.35	3.18	0.40	2.8	
 Finishing (Ultra high precision)	110301MFN-VP1	●		●			11.0	6.35	3.18	< 0.10	2.8	
	110302MFN-VP1	●		●			11.0	6.35	3.18	< 0.20	2.8	
	110304MFN-VP1	●		●			11.0	6.35	3.18	< 0.40	2.8	
 Medium cutting (Ultra high precision)	1203008FN-MS	●		●			11.0	7.50	3.00	< 0.08	2.8	
	120301FN-MS	●		●			11.0	7.50	3.00	< 0.10	2.8	
	120302FN-MS	●		●			11.0	7.50	3.00	< 0.20	2.8	
	120304FN-MS	●		●			11.0	7.50	3.00	< 0.40	2.8	
 Finishing (Ultra high precision) Chamfer type	120300MFR-VP1	●		●			11.0	7.50	3.18	< 0.00	2.8	
	120301MFR-VP1	●		●			11.0	7.50	3.18	< 0.10	2.8	
	120302MFR-VP1	●		●			11.0	7.50	3.18	< 0.20	2.8	
	120304MFR-VP1	●		●			11.0	7.50	3.18	< 0.40	2.8	
	120308MFR-VP1	●		●			11.0	7.50	3.18	< 0.80	2.8	

● : Stock item



**Insert**

Picture	Designation	Coated				Uncoated	Dimensions (mm)					Configuration
		PC5300	PC8105	PC8110	PC8115	H01	l	d	t	r	d <sub>1</sub>	
 <p>Finishing (High precision)</p>	080201R-KF	●		●			8.0	4.76	2.38	0.10	2.3	
	080202R-KF	●		●			8.0	4.76	2.38	0.20	2.3	
	1103003R-KF	●		●			11.0	6.35	3.18	0.03	2.8	
	110301R-KF	●		●			11.0	6.35	3.18	0.10	2.8	
	110302R-KF	●		●			11.0	6.35	3.18	0.20	2.8	
	080201L-KF	●		●			8.0	4.76	2.38	0.10	2.3	
	080202L-KF	●		●			8.0	4.76	2.38	0.20	2.3	
	1103003L-KF	●		●			11.0	6.35	3.18	0.03	2.8	
	110301L-KF	●		●			11.0	6.35	3.18	0.10	2.8	
	110302L-KF	●		●			11.0	6.35	3.18	0.20	2.8	
 <p>Finishing (Ultra high precision)</p>	0802005MFR-KF	●		●			8.0	6.35	2.38	< 0.05	2.3	
	080201MFR-KF	●		●			8.0	6.35	2.38	< 0.10	2.3	
	080202MFR-KF	●		●			8.0	6.35	2.38	< 0.20	2.3	
	0802005MFL-KF	●		●			8.0	6.35	2.38	< 0.05	2.3	
	080201MFL-KF	●		●			8.0	6.35	2.38	< 0.10	2.3	
	080202MFL-KF	●		●			8.0	6.35	2.38	< 0.20	2.3	
 <p>Medium to finishing (High precision)</p>	080201R-KM	●		●			8.0	4.76	2.38	0.10	2.3	
	080202R-KM	●		●			8.0	4.76	2.38	0.20	2.3	
	1103003R-KM	●		●			11.0	6.35	3.18	0.03	2.8	
	110301R-KM	●		●			11.0	6.35	3.18	0.10	2.8	
	110302R-KM	●		●			11.0	6.35	3.18	0.20	2.8	
	080201L-KM	●		●			8.0	4.76	2.38	0.10	2.3	
	080202L-KM	●		●			8.0	4.76	2.38	0.20	2.3	
	1103003L-KM	●		●			11.0	6.35	3.18	0.03	2.8	
	110301L-KM	●		●			11.0	6.35	3.18	0.10	2.8	
	110302L-KM	●		●			11.0	6.35	3.18	0.20	2.8	
 <p>Medium to finishing (Ultra high precision)</p>	0802005MFR-KM	●		●			8.0	6.35	3.18	< 0.05	2.8	
	080201MFR-KM	●		●			8.0	6.35	3.18	< 0.10	2.8	
	080202MFR-KM	●		●			8.0	6.35	3.18	< 0.20	2.8	
	0802005MFL-KM	●		●			8.0	6.35	3.18	< 0.05	2.8	
	080201MFL-KM	●		●			8.0	6.35	3.18	< 0.10	2.8	
	080202MFL-KM	●		●			8.0	6.35	3.18	< 0.20	2.8	
 <p>Medium cutting (High precision)</p>	110301-VP1	●	●	●	●	●	11.0	6.35	3.18	0.10	2.8	
	110302-VP1	●	●	●	●	●	11.0	6.35	3.18	0.20	2.8	
	110304-VP1	●	●	●	●	●	11.0	6.35	3.18	0.40	2.8	
 <p>Medium cutting (Ultra high precision)</p>	110301MFN-VP1	●		●			11.0	6.35	3.18	< 0.10	2.8	
	110302MFN-VP1	●		●			11.0	6.35	3.18	< 0.20	2.8	
	110304MFN-VP1	●		●			11.0	6.35	3.18	< 0.40	2.8	

● : Stock item



# B Auto Tools (Blade Type)

## Auto tools (Blade type)

- Blade insert for automatic lathes
- For external machining of precise small parts
- 4 types - SSB (for back turning), SGB (for grooving), SBT (for threading), SBC (for parting off)
- Convenient use of one holder to all blade inserts
- Exclusive holder for close cutting action to the sub spindle

### Code system

#### • Insert

Turning (Back turning)	SB	B	R	25	005	
	Small blade	Back turning	Hand R: Right L: Left	Length of insert	Nose radius	
Grooving	SB	G	R	25	20	
	Small blade	Grooving	Hand R: Right L: Left	Length of insert	Width of cutting edge	
Threading	SB	T	R	25	60 - N - 010	
	Small blade	Threading	Hand R: Right L: Left	Length of insert	Angle of thread Hand of thread R: Right L: Left N: Neutral	Nose radius
Parting	SB	C	R	25	20	16 - N
	Small blade	Cut off / Parting	Hand R: Right L: Left	Length of insert	Width of cutting edge	Max. machining diameter Hand of thread R: Right L: Left N: None

#### • Holder

SB	H	R	10	10	K25	X
Small blade	Holder	Hand R: Right L: Left	Height of shank	Width of shank	Length of insert	Sub spindle

### Types of blade insert

Possible to apply various types of blade inserts to one holder



**SBB:** For back turning

- Approach angle: 59°
- Max. cutting depth: 4 mm
- Nose R: 0.05, 0.1, 0.2 mm



**SGB:** For grooving

- Width: 0.5~2.5 mm
- Nose R: 0.05 mm



**SBT:** For threading

- V profile: 60°
- Pitch: 0.2~1.0 mm
- Nose R: 0.05 mm



**SBC:** For cut off/Parting

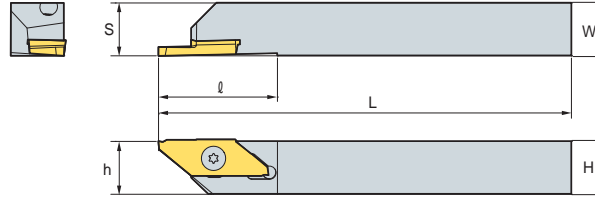
- Cutting width: 0.7~2.0
- DMax.: 16 mm
- Nose R: 0.05 mm



# SBHR/L



SBBR SBGR  
SBTR SBCR

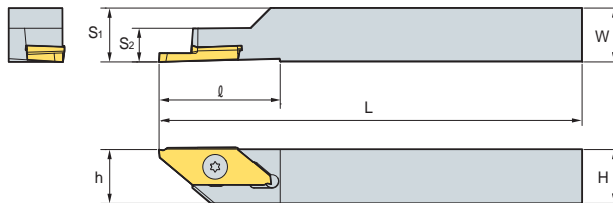


Designation		H	W	L	S	h	l	Insert	Screw	Wrench
SBHR/L	1010-K25	10	10	125	10	10	27	SB□R/L25	FTKA0409S	TW09P
	1212-K25	12	12	125	12	12	27			
	1616-K25	16	16	125	16	16	27			

# SBHR/L-X (Sub spindle)



SBBR SBGR  
SBTR SBCR



Designation		H	W	L	S1	S2	h	l	Insert	Screw	Wrench
SBHR/L	1010-K25-X	10	10	125	10	7.5	10	27	SB□R/L25	FTKA0407S	TW09P
	1212-K25-X	12	12	125	12	7.5	12	27			

## Insert

Application	Picture	Designation	Coated				Dimensions (mm)										Configuration	Feed direction	
			PC8110		PC5300		l	$\alpha$	t	r	La	ar	f	D-MAX	Pitch range				
			R	L	R	L									Min.	Max.			
Back turning		SBBR/L 25005	●	●	●	●	25	59	3.18	0.05	-	-	-	-	-	-	-		
		25010	●	●	●	●	25	59	3.18	0.10	-	-	-	-	-	-	-		
		25020	●	●	●	●	25	59	3.18	0.20	-	-	-	-	-	-	-		
Grooving		SBGR/L 2505	●	●	●	●	25	-	-	0.05	0.5	1.35	-	-	-	-	-		
		2510	●	●	●	●	25	-	-	0.05	1.0	2.75	-	-	-	-	-		
		2515	●	●	●	●	25	-	-	0.05	1.5	3.75	-	-	-	-	-		
		2520	●	●	●	●	25	-	-	0.05	2.0	3.75	-	-	-	-	-		
		2525	●	●	●	●	25	-	-	0.05	2.5	3.75	-	-	-	-	-		
Threading		SBTR/L 2560-N-005	●	●	●	●	25	-	-	0.05	-	-	1.59	-	0.2	2.0			
		2560-N-010	●	●	●	●	25	-	-	0.10	-	-	1.59	-	1.0	2.0			
		2560-R-005	●	●	●	●	25	-	-	0.05	-	-	0.6	-	0.2	1.5			
		2560-R-010	●	●	●	●	25	-	-	0.10	-	-	0.6	-	1.0	1.5			
		2560-L-005	●	●	●	●	25	-	-	0.05	-	-	0.6	-	0.2	1.5			
		2560-L-010	●	●	●	●	25	-	-	0.10	-	-	0.6	-	1.0	1.5			

● : Stock item


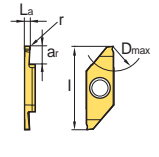
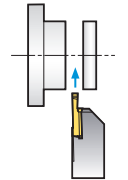
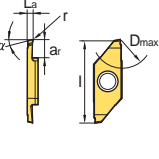
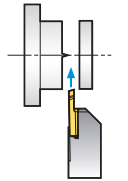
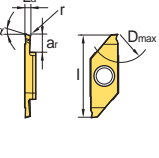
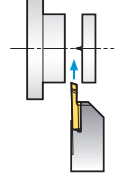
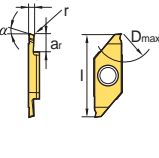
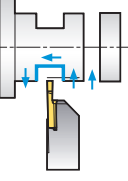
Turning



**B**

# B Auto Tools (Blade Type)

## Insert

Application	Picture	Designation	Coated				Dimensions (mm)										Configuration	Feed direction
			PC8110		PC5300		l	$\alpha$	t	r	La	ar	f	D-MAX	Pitch range			
			R	L	R	L									Min.	Max.		
Parting off		<b>SBCR/L 250708-N</b>	●	●	●	●	25	0	-	0.05	0.7	4.3	-	8	-	-		
		<b>251012-N</b>	●	●	●	●	25	0	-	0.05	1.0	6.3	-	12	-	-		
		<b>251512-N</b>	●	●	●	●	25	0	-	0.05	1.5	6.3	-	12	-	-		
		<b>252016-N</b>	●	●	●	●	25	0	-	0.05	2.0	8.3	-	16	-	-		
		<b>250708-R</b>	●	●	●	●	25	15	-	0.05	0.7	4.3	-	8	-	-		
		<b>251012-R</b>	●	●	●	●	25	15	-	0.05	1.0	6.3	-	12	-	-		
		<b>251512-R</b>	●	●	●	●	25	15	-	0.05	1.5	6.3	-	12	-	-		
		<b>252016-R</b>	●	●	●	●	25	15	-	0.05	2.0	8.3	-	16	-	-		
		<b>250708-L</b>	●	●	●	●	25	15	-	0.05	0.7	4.3	-	8	-	-		
		<b>251012-L</b>	●	●	●	●	25	15	-	0.05	1.0	6.3	-	12	-	-		
		<b>251512-L</b>	●	●	●	●	25	15	-	0.05	1.5	6.3	-	12	-	-		
		<b>252016-L</b>	●	●	●	●	25	15	-	0.05	2.0	8.3	-	16	-	-		
		<b>251012-T</b>	●	●	●	●	25	0	-	0.05	1.0	6.3	-	12	-	-		
		<b>251512-T</b>	●	●	●	●	25	0	-	0.05	1.5	6.3	-	12	-	-		
		<b>252016-T</b>	●	●	●	●	25	0	-	0.05	2.0	8.3	-	16	-	-		

● : Stock item

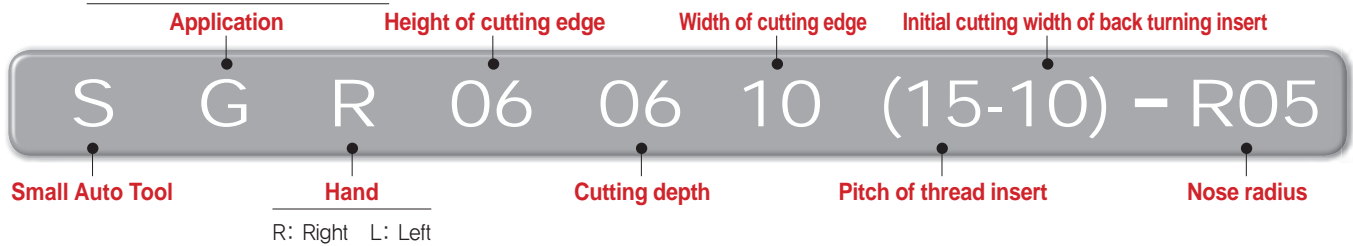


## Auto Tools (For multi utility)

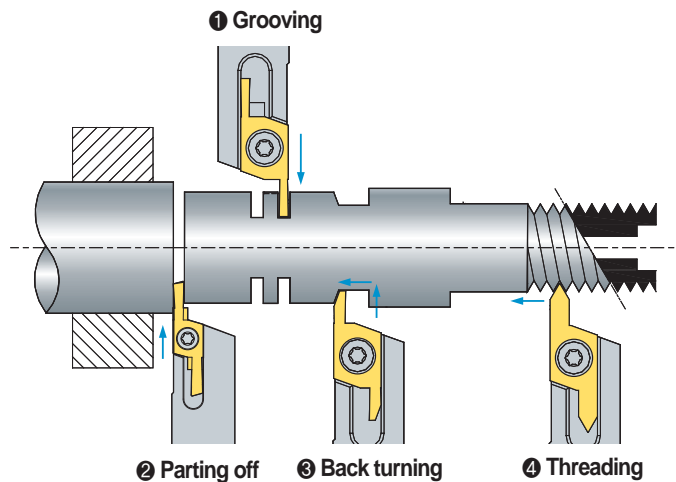
- Multifunctional insert for automatic lathes
- For external machining of precise small parts
- 5 types - SB (for back turning), SG (for grooving), ST (for threading), SC (for parting off), SGB (for grooving and back turning)
- Convenient use of one holder to all inserts
- Offset "0" to all ISO type holders

### Code system

B: Back turning    G: Grooving  
 C: Parting off    T: Threading  
 GB : Grooving and back turning

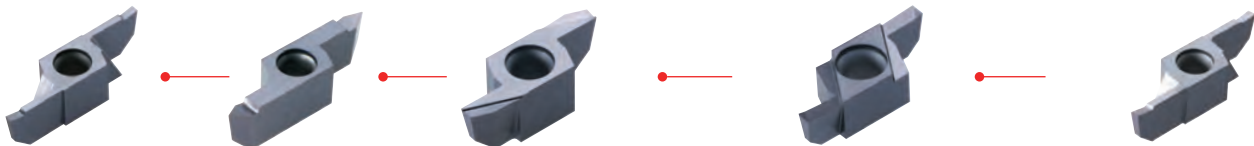


### Application example



### Types of multifunctional insert

Possible to apply various types of blade inserts to one holder (Ex: All designations of 06 size inserts can be applied to one 06 size holder.)



SG: Grooving

ST: Threading

SB: Back turning

SGB: Grooving and back turning

SC: Parting off

### Recommended cutting conditions

Workpiece	Turning		Grooving		Parting off		Back turning	
	Cutting speed, vc (m/min)	Feed, fn (mm/rev)	Cutting speed, vc (m/min)	Feed, fn (mm/rev)	Cutting speed, vc (m/min)	Feed, fn (mm/rev)	Cutting speed, vc (m/min)	Feed, fn (mm/rev)
<b>P</b> Carbon steel	50~150	0.01~0.25	50~150	0.02~0.08	50~150	0.01~0.08	50~150	0.01~0.25
Free cutting steel	30~150	0.02~0.25	30~150	0.02~0.08	30~150	0.01~0.08	30~150	0.01~0.25
<b>M</b> Stainless steel	50~120	0.02~0.20	30~120	0.02~0.05	30~120	0.02~0.05	30~120	0.02~0.20
<b>N</b> Non-ferrous metal	70~200	0.03~0.25	70~200	0.03~0.10	70~200	0.03~0.10	70~200	0.03~0.30

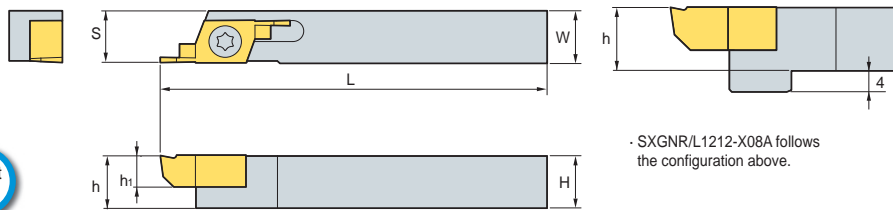




# B Auto Tools (For multi utility)

## SXGNR/L

SBR, SGBR  
SCR, STR, SGR



• R type insert (mm)

Designation	H	W	L	S	h	h1	Insert	Screw	Wrench
SXGNR/L 1010-X06A	10	10	125	10	10	6	S□R/L 06	FTNA 0408	TW 15P
	1212-X06A	12	12	125	12	12			
	1616-X06A	16	16	125	16	16			
	2020-X06A	20	20	125	20	20			
SXGNR/L 1212-X08A	12	12	130	12	12	8	S□R/L 08	FTNA 0411	TW 15P
	1616-X08A	16	16	130	16	16			
	2020-X08A	20	20	130	20	20			


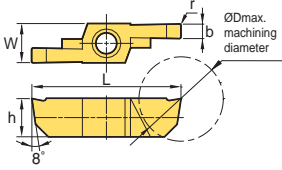
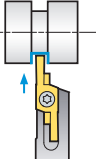
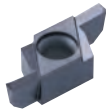
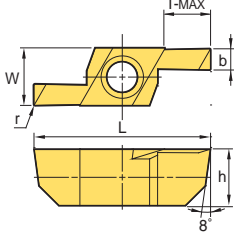
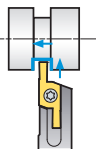

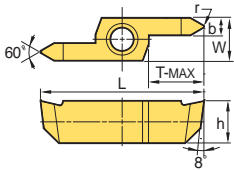
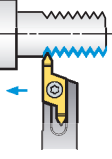
## Insert

Application	Picture	Designation	Coated		Dimensions (mm)								Configuration	Feed direction
			PC9030		b1	b	W	L	r	h	T-MAX	ØD		
			R	L										
Back turning		SBR/L 060520-10-R00			1	2	8	22	0	6	5.5	-		
		060520-10-R05			1	2	8	22	0.05	6	5.5	-		
		060520-10-R10			1	2	8	22	0.1	6	5.5	-		
		060630-20-R00			2	3	8	24	0	6	6.5	-		
		060630-20-R05			2	3	8	24	0.05	6	6.5	-		
		060630-20-R10			2	3	8	24	0.1	6	6.5	-		
		080630-20-R00			2	3	8	23	0	8	6.5	-		
		080630-20-R05			2	3	8	23	0.05	8	6.5	-		
		080630-20-R10			2	3	8	23	0.1	8	6.5	-		
		080840-20-R00			2	4	8	27	0	8	8.5	-		
			2	4	8	27	0.05	8	8.5	-				
			2	4	8	27	0.1	8	8.5	-				
Parting off		SCR/L 060610-R00			-	1	8	24	0	6	-	11		
		060610-R05	●		-	1	8	24	0.05	6	-	11		
		060610-R10	●		-	1	8	24	0.1	6	-	11		
		060615-R00			-	1.5	8	24	0	6	-	11		
		060615-R05	●		-	1.5	8	24	0.05	6	-	11		
		060615-R10	●		-	1.5	8	24	0.1	6	-	11		
		060620-R00			-	2	8	24	0	6	-	11		
		060620-R05	●		-	2	8	24	0.05	6	-	11		
		060620-R10	●		-	2	8	24	0.1	6	-	11		
		081015-R00			-	1.5	8	31	0	8	-	18		
		081015-R05			-	1.5	8	31	0.05	8	-	18		
		081015-R10			-	1.5	8	31	0.1	8	-	18		
		081020-R00			-	2	8	31	0	8	-	18		
		081020-R05			-	2	8	31	0.05	8	-	18		
		081020-R10	●		-	2	8	31	0.1	8	-	18		
		081025-R00			-	2.5	8	31	0	8	-	18		
		081025-R05	●		-	2.5	8	31	0.05	8	-	18		
		081025-R10	●		-	2.5	8	31	0.1	8	-	18		
		081030-R00			-	3	8	31	0	8	-	18		
		081030-R05	●		-	3	8	31	0.05	8	-	18		
081030-R10			-	3	8	31	0.1	8	-	18				

● : Stock item



## Insert

Application	Picture	Designation	Coated		Dimensions (mm)								Configuration	Feed direction
			PC9030		b	W	L	r	h	T-MAX	ØD	Pitch		
			R	L										
Grooving		<b>SGR/L</b> 060610-R00			1	8	24	0	6	-	11	-		
		060610-R05	●		1	8	24	0.05	6	-	11	-		
		060610-R10	●		1	8	24	0.1	6	-	11	-		
		060615-R00			1.5	8	24	0	6	-	11	-		
		060615-R05	●		1.5	8	24	0.05	6	-	11	-		
		060615-R10	●		1.5	8	24	0.1	6	-	11	-		
		060620-R00			2	8	24	0	6	-	11	-		
		060620-R05	●		2	8	24	0.05	6	-	11	-		
		060620-R10	●		2	8	24	0.1	6	-	11	-		
		081015-R00			1.5	8	31	0	8	-	18	-		
		081015-R05			1.5	8	31	0.05	8	-	18	-		
		081015-R10			1.5	8	31	0.1	8	-	18	-		
		081020-R00			2	8	31	0	8	-	18	-		
		081020-R05	●		2	8	31	0.05	8	-	18	-		
		081020-R10			2	8	31	0.1	8	-	18	-		
		081025-R00			2.5	8	31	0	8	-	18	-		
		081025-R05			2.5	8	31	0.05	8	-	18	-		
		081025-R10			2.5	8	31	0.1	8	-	18	-		
081030-R00			3	8	31	0	8	-	18	-				
081030-R05			3	8	31	0.05	8	-	18	-				
081030-R10			3	8	31	0.1	8	-	18	-				
Grooving and back turning		<b>SGBR/L</b> 0604520-R00			2	8	22	0	6	4.5	-	-		
		0604520-R05			2	8	22	0.05	6	4.5	-	-		
		0604520-R10			2	8	22	0.1	6	4.5	-	-		
		0604525-R00			2.5	8	22	0	6	4.5	-	-		
		0604525-R05			2.5	8	22	0.05	6	4.5	-	-		
		0604525-R10			2.5	8	22	0.1	6	4.5	-	-		
		0605530-R00			3	8	24	0	6	5.5	-	-		
		0605530-R05			3	8	24	0.05	6	5.5	-	-		
		0605530-R10			3	8	24	0.1	6	5.5	-	-		
		0805525-R00			2.5	8	24	0	8	5.5	-	-		
		0805525-R05			2.5	8	24	0.05	8	5.5	-	-		
		0805525-R10			2.5	8	24	0.1	8	5.5	-	-		
		0806530-R00			3	8	26	0	8	6.5	-	-		
		0806530-R05			3	8	26	0.05	8	6.5	-	-		
0806530-R10			3	8	26	0.1	8	6.5	-	-				
Threading		<b>STR/L</b> 06073215			3.2	8	25	0.06	6	7	-	0.5-1.5		
		06073230			3.2	8	25	0.19	6	7	-	1.5-3.0		
		08103215			3.2	8	31	0.06	8	10.5	-	0.5-1.5		
		08103230			3.2	8	31	0.19	8	10.5	-	1.5-3.0		

● : Stock item



# B Auto Tools (KGT/MGT type)

## AutoTools (KGT/MGT type)

- Grooving insert for automatic lathes
- Exclusive holder for automatic lathes
- Economic double sided insert
- Strong clamping system secures stable machining and precision.
- A wide selection of chip breakers according to various cutting conditions such as low/high feed, continuous/interrupted machining, etc.

### Code system

#### • Insert







KG	M	N	300	-	04	-	T
<b>System code</b>	<b>Tolerance</b>	<b>Hand</b>	<b>Width of cutting edge</b>		<b>Corner nose radius of insert</b>		<b>Chip breaker</b>
KG SYSTEM (KORLOY Grooving) MG SYSTEM (Multi Grooving)	M: Pressed class G: Ground class	N: Neutral R: Right L: Left I: Internal	2,0~8,0 mm		0,2 mm 0,3 mm 0,4 mm		L/R/T/C LP/RP

#### • Holder



KG	E	H	R/L	1212	-	3	D25A
<b>System code</b>	<b>Application</b>	<b>Holder type</b>	<b>Hand</b>	<b>Shank size</b>		<b>Cutting width</b>	<b>Max. cutting diameter</b>
KG SYSTEM (KORLOY Grooving) MG SYSTEM (Multi Grooving)	E: External machining I: Internal machining	H: Horizontal type V: Vertical type U: Undercut type	R: Right L: Left	Height 12 mm, width 12 mm (For internal machining: Min. machining diameter)		2,0~3,0 mm	Ø15~Ø32 mm

### Chip breaker line-up

#### KGT Type

<b>KGMM-L</b>		<ul style="list-style-type: none"> <li>• Sharp cutting edge</li> <li>• For low feed machining</li> <li>• For small diameter parts</li> </ul>
<b>KGMM-T</b>		<ul style="list-style-type: none"> <li>• Sharp cutting edge</li> <li>• Stronger chip control</li> <li>• For turning and grooving</li> </ul>
<b>KGMR/L-RP</b>		<ul style="list-style-type: none"> <li>• Strong cutting edge</li> <li>• For high feed machining</li> <li>• For interrupted cutting</li> <li>• Right/Left handed</li> </ul>
<b>KGMM-R</b>		<ul style="list-style-type: none"> <li>• Reinforced cutting edge</li> <li>• For high feed machining</li> <li>• For interrupted cutting</li> </ul>
<b>KGMR/L-LP</b>		<ul style="list-style-type: none"> <li>• Sharp cutting edge</li> <li>• For low feed machining</li> <li>• Small diameter component</li> <li>• Right/Left handed</li> </ul>
<b>KGMM-C</b>		<ul style="list-style-type: none"> <li>• Improved chip control</li> <li>• Relief</li> <li>• Carbon steel</li> <li>• Copying</li> <li>• Cast iron</li> <li>• Alloy steel</li> <li>• Stainless</li> </ul>

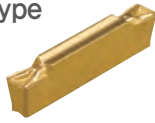
#### MGT Type

<b>MGM(G)N-M</b>		<ul style="list-style-type: none"> <li>• Easier chip control by narrowing chip width with the use of chip breaker on rake surface center</li> <li>• Smooth chip flow by small dots in external machining</li> <li>• Available for both external machining and grooving</li> </ul>
<b>MGMN-G</b>		<ul style="list-style-type: none"> <li>• Specially designed chip breaker allows narrower chips to promote better chip flow with the use of center dots</li> <li>• Exclusive chip breaker for grooving</li> </ul>

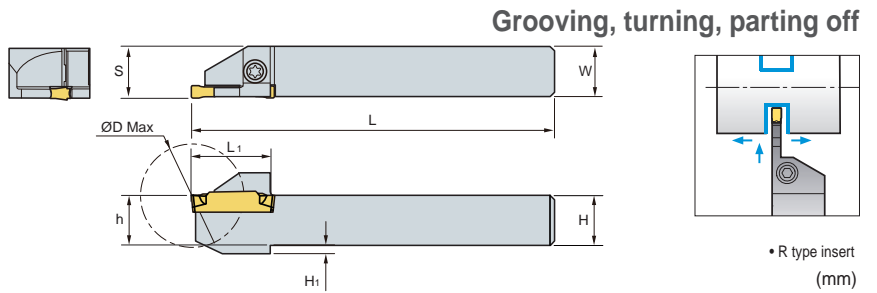


# KGEHR/L-D00A

Compact type



KGGN KGMN KGMR/L  
KRGN KRMN



Designation	Dimensions (mm)							Insert	Screw	Wrench	
	H	W	L <sub>1</sub>	L	S	h <sub>1</sub>	ØD_MAX				
KGEHR/L	1010-2-D20A	10	10	19	125	10.2	2	20	KGMN200-□-□ KGMR/L200-□-□ KRMN200-C	ETNA0412	TW15L
	1212-2-D25A	12	12	19	125	12.2	2	25			
	1414-2-D25A	14	14	19	125	14.2	-	25			
	1616-2-D32A	16	16	24	125	16.2	-	32			
1212-3-D25A	12	12	19	130	12.4	2	25	KGMN300-□-□ KGMR/L300-□-□ KRMN300-C			
1616-3-D32A	16	16	24	130	16.4	-	32				

# KGEHR/L-D00B

High rigidity type



KGGN KGMN KGMR/L  
KRGN KRMN



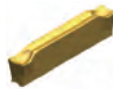
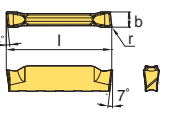

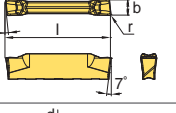

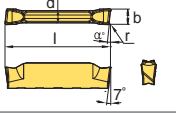

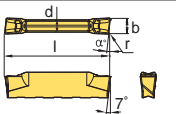

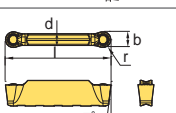
Designation	Dimensions (mm)							Insert	Screw	Wrench
	H	W	L	S	h <sub>1</sub>	ØD_MAX				
KGEHR/L	1010-2-D30B	10	10	125	10.2	6.6	30	KGMN200-□-□ KGMR/L200-□-□ KRMN200-C	MHA0512	HW40L
	1212-2-D25B	12	12	125	12.5	3.5	25			
	1212-2-D30B	12	12	125	12.2	3.5	30			
	1616-2-D32B	16	16	125	16.2	-	32			
	1212-3-D25B	12	12	125	12.4	3.5	25			
	1212-3-D32B	12	12	125	12.4	3.5	32			
1616-3-D32B	16	16	125	16.4	-	32	KGMN300-□-□ KGMR/L300-□-□ KRMN300-C			

## KGT Insert

Application	Picture	Designation	Coated							Dimensions (mm)					Configuration
			NC3120	NC3225	NC5330	NC6315	PC3035	PC5300	PC9030	b	r	l	d	α°	
Grooving		KGMN 200-02-L 300-02-L	●	●			●	●	●	2.0	0.2	20	1.7	-	
			●	●			●	●	●	3.0	0.2	20	2.3	-	
Grooving - Parting off		KGMN 200-02-R 300-02-R	●	●			●	●	●	2.0	0.2	20	1.7	-	
			●	●			●	●	●	3.0	0.2	20	2.3	-	
Grooving-turning		KGMN 200-02-T 300-02-T 300-04-T	●	●	●	●	●	●		2.0	0.2	20	1.7	-	
			●	●	●	●	●	●		3.0	0.2	20	2.3	-	
			●	●	●	●	●	●		3.0	0.4	20	2.3	-	

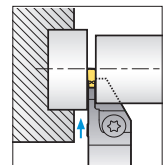
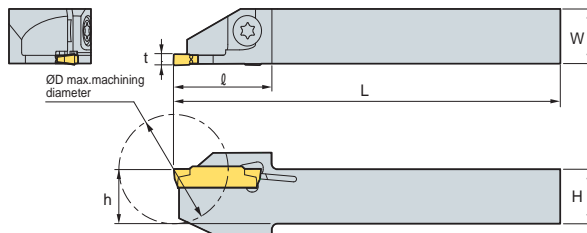
# B Auto Tools (KGT/MGT type)

## KGT Insert



Application	Picture	Designation	Coated						Dimensions (mm)					Configuration	
			NC3120	NC3225	NC5330	NC6315	PC3035	PC5300	PC9030	b	r	l	d		$\alpha^\circ$
Parting off (Right handed)		<b>KGMR</b>	<b>200-6D-LP</b>			●		●		2.0	0.2	20	-	6	
			<b>200-15D-LP</b>			●		●		2.0	0.2	20	-	15	
			<b>300-6D-LP</b>			●		●		3.0	0.2	20	-	6	
			<b>300-15D-LP</b>			●		●		3.0	0.2	20	-	15	
Parting off (Right handed)		<b>KGMR</b>	<b>200-6D-RP</b>			●		●		2.0	0.2	20	-	6	
			<b>200-15D-RP</b>			●		●		2.0	0.2	20	-	15	
			<b>300-6D-RP</b>			●		●		3.0	0.2	20	-	6	
			<b>300-15D-RP</b>			●		●		3.0	0.2	20	-	15	
Parting off (Left handed)		<b>KGML</b>	<b>200-6D-LP</b>							2.0	0.2	20	1.7	6	
			<b>200-15D-LP</b>							2.0	0.2	20	1.7	15	
			<b>300-6D-LP</b>							3.0	0.2	20	2.3	6	
			<b>300-15D-LP</b>							3.0	0.2	20	2.3	15	
Parting off (Left handed)		<b>KGML</b>	<b>200-6D-RP</b>							2.0	0.2	20	1.7	6	
			<b>200-15D-RP</b>							2.0	0.2	20	1.7	15	
			<b>300-6D-RP</b>							3.0	0.2	20	2.3	6	
			<b>300-15D-RP</b>							3.0	0.2	20	2.3	15	
Copying		<b>KRMN</b>	<b>200-C</b>		●	●	●	●	●	2.0	1.0	20	1.7	-	
			<b>300-C</b>		●	●	●	●	●	3.0	1.5	20	2.2	-	

● : Stock item


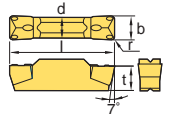

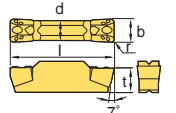
## MGEHR/L



• R type insert (mm)

Designation	ØD	H = h	W	L	l	t	Insert	Screw	Wrench
									
<b>MGEHR/L</b>	<b>1010-X15A</b>	20	10	10	125	18	1.5	MGMN150-G	ETNA 0412 TW 15L
	<b>1212-X15A</b>	25	12	12	125	19.5	1.5		
	<b>1010-X20A</b>	20	10	10	125	18	2		
	<b>1212-X20A</b>	25	12	12	125	19.5	2	MGMN200-M MGMN200-G	ETNA 0412 TW 15L
	<b>1616-X20A</b>	32	16	16	125	25	2		
	<b>1010-X25A</b>	20	10	10	125	20	2.5	MGMN250-M MGMN250-G	ETNA 0412 TW 15L
<b>1212-X25A</b>	25	12	12	125	20	2.5			
<b>1616-X25A</b>	32	16	16	125	25	2.5			

## MGT Insert

Application	Picture	Designation	Coated						Uncoated			Dimensions (mm)					Configuration	
			NC3120	NC3225	NC3030	NC5330	NC6315	PC5300	PC9030	H01	G10	ST30A	b	r	l	d		t
Grooving		<b>MGMN</b>	<b>150-G</b>		●	●			●				1.5	0.15	16.0	1.2	3.5	
			<b>200-G</b>		●	●			●				2.0	0.2	16.0	1.6	3.5	
			<b>250-G</b>		●	●			●				2.5	0.2	18.5	2.0	3.85	
Grooving		<b>MGMN</b>	<b>200-M</b>	●	●	●	●		●			2.0	0.2	16.0	1.6	3.5		
			<b>250-M</b>	●	●	●		●				2.5	0.2	18.5	2.0	3.85		

● : Stock item



## Auto Tools (MSB tool)

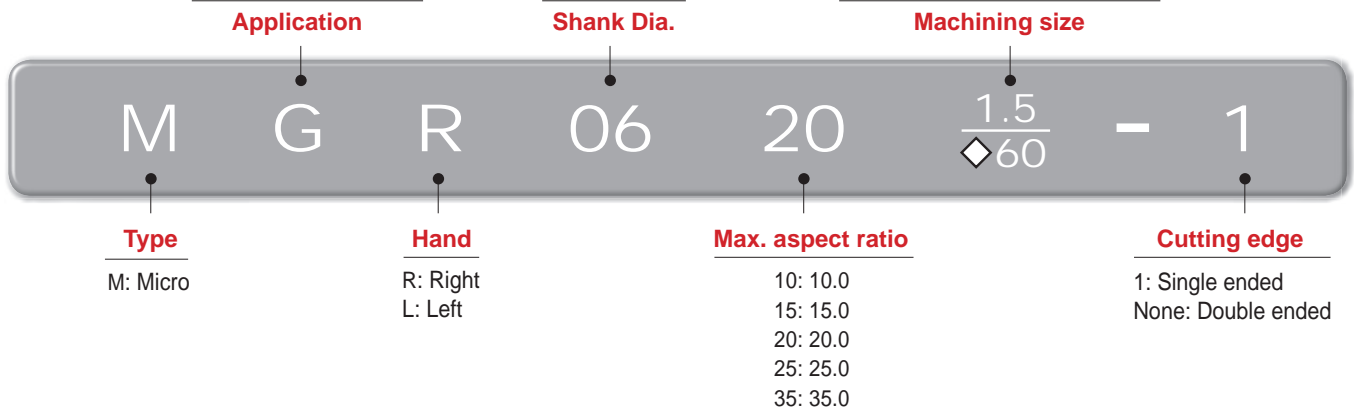
- High hardness grade guarantees longer tool life
- Various kinds of machining (Fitting, Valve, Medical parts, Automobile component, and Semiconductor equipment) are available
- Various types of MSB tools (Boring, Grooving, Threading)

### Code system

B : Boring  
 BC : Copying  
 BB : Back Boring  
 BF : Chamfering  
 G : Square Grooving  
 GR : Round Grooving  
 GF : Face Grooving  
 T : Threading

03: 3.0  
 04: 4.0  
 06: 6.0  
 08: 8.0  
 10: 10.0

Boring	No Code	
Copying	Width of Groove	
Threading	60°	55°
	Pitch	tpi
◇	F	0.25~1.0
	A	0.5~1.5
	AG	0.5~3.0



### MSB tool code system

Types		Application	Designation
01	Boring	Boring	MBR/LOO☆☆
02		Copying	MBCR/LOO☆☆
03		Back Boring	MBBR/LOO☆☆
04		Chamfering	MBFR/LOO☆☆
05	Grooving	Square Grooving	MGR/LOO☆☆-□□
06		Round Grooving	MGRR/LOO☆☆-□□
07		Face Grooving	MGFR/LOO00-□□
08	Threading	Partial	60° 55°
			MTR/LOO☆☆-◇60 MTR/LOO☆☆-◇55

### Details

Marks	○○	Shank Dia.		
	☆☆	Max. depth of boring		
	□□	Width of groove		
	◇	Pitch/tpi		
		F	0.25~1.0	72~24
		A	0.5~1.5	48~16
		AG	0.5~3.0	48~8



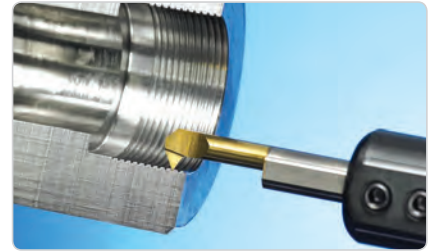


# B Auto Tools (MSB tool)

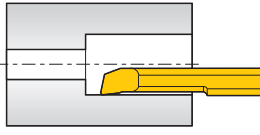
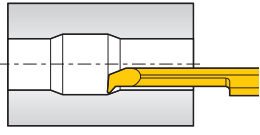
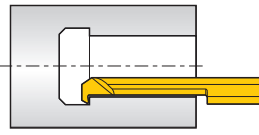
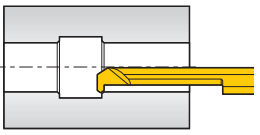
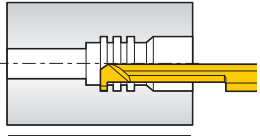
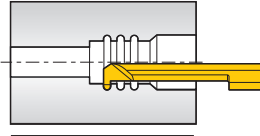
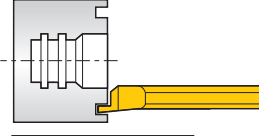
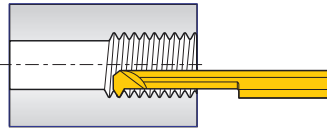
## Grades

Grades	Coating	Application and features
Z12M	Carbide	Ultra fine grain substrate ensures superior wear resistance and toughness Application: Cast iron, Aluminum alloy and Non-ferrous metals machining
PC30M	TiN coating	TiN coated ultra fine grain substrate ensures long tool life Application: Stainless steel, heat resisting alloy and hard-to-cut material machining

## Machining types

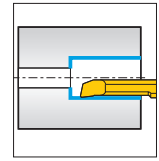
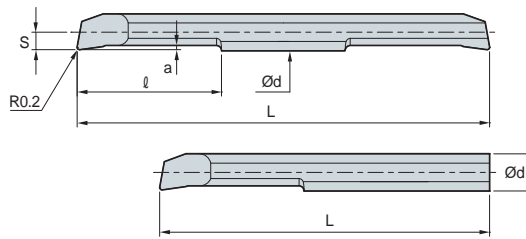


## Types

<b>Boring</b>	 <p><b>Boring</b> Min. dia. of machining: Ø3.2</p>	 <p><b>Copying</b> Min. dia. of machining: Ø4.2</p>	 <p><b>Back Boring</b> Min. dia. of machining: Ø3.2</p>	 <p><b>Chamfering</b> Min. dia. of machining: Ø4.2</p>
<b>Grooving</b>	 <p><b>Square Grooving</b> Min. dia. of machining: Ø3.2</p>	 <p><b>Round Grooving</b> Min. dia. of machining: Ø3.2</p>	 <p><b>Face Grooving</b> Min. dia. of machining: Ø6.0</p>	
<b>Threading</b>	 <p><b>Threading</b> Min. dia. of machining: Ø3.3</p>			



# Boring

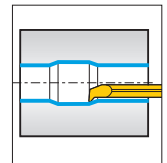
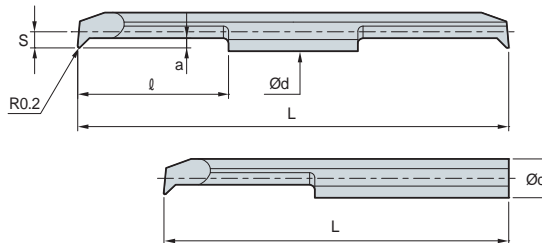


(mm)

Twin Edge			Single Edge			Ød	Min.dia. of machining	l	Overall length		Detailed cutting edge		
Designation	Coated	Uncoated	Designation	Coated	Uncoated				L		a	S	
	PC30M	Z12M		PC30M	Z12M				Double ended	Single ended			
MBR	0310	●	MBR	0310-1		3.0	3.2	10	40	35	0.5	1.4	
	0315	●		0315-1					15	50			45
	0410	●		0410-1		4.0	4.2	10	40	35	0.6	1.9	
	0415	●		0415-1					15	50			45
	0420	●		0420-1					20	60			50
	0610	●		0610-1		6.0	6.2	10	45	40	0.75	2.9	
	0615	●		0615-1					15	55			45
	0620	●		0620-1					20	65			50
	0810	●		0810-1		8.0	8.2	10	50	45	0.8	3.9	
	0820	●		0820-1					20	70			60
	0830			0830-1					30	80			70
	1015	●		1015-1		10.0	10.2	15	60	60	1.0	4.9	
	1025	●		1025-1					25	80			70
	1035	●		1035-1					35	100			80

● : Stock item

# Copying



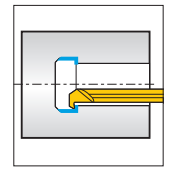
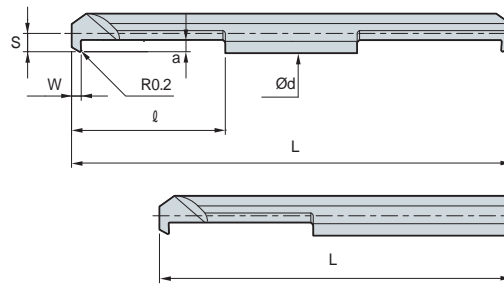
(mm)

Twin Edge			Single Edge			Ød	Min.dia. of machining	l	Overall length		Detailed cutting edge		
Designation	Coated	Uncoated	Designation	Coated	Uncoated				L		a	S	
	PC30M	Z12M		PC30M	Z12M				Double ended	Single ended			
MBCR	0410	●	MBCR	0410-1		4.0	4.2	10	40	35	1.0	1.9	
	0415	●		0415-1					15	50			45
	0420	●		0420-1					20	60			50
	0610	●		0610-1		6.0	6.2	10	45	40	1.3	2.9	
	0615	●		0615-1					15	55			45
	0620	●		0620-1					20	60			50

● : Stock item



## Back Boring

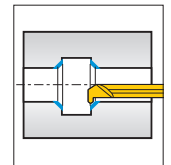
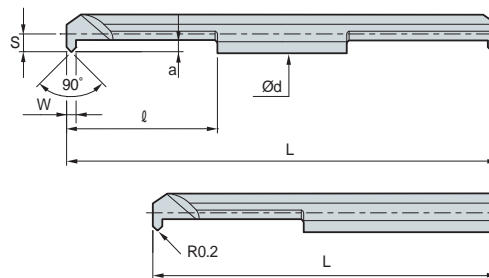


(mm)

Twin Edge			Single Edge			Ød	Min.dia. of machining	ℓ	Overall length		Detailed cutting edge		
Designation	Coated	Uncoated	Designation	Coated	Uncoated				L		W	a	S
	PC30M	Z12M		PC30M	Z12M				Double ended	Single ended			
MBBR 0310 0315 0410 0415 0420 0610 0615 0620	●		MBBR 0310-1 0315-1 0410-1 0415-1 0420-1 0610-1 0615-1 0620-1			3.0	3.2	10	40	35	1.5	0.8	1.4
	●			15	50				45				
	●			4.0	4.2	10	40	35	2.0	1.3	1.9		
	●						15	50				45	
	●			6.0	6.2	10	45	40	2.0	1.9	2.9		
	●						15	55				45	
	●						20	65				50	

● : Stock item

## Chamfering



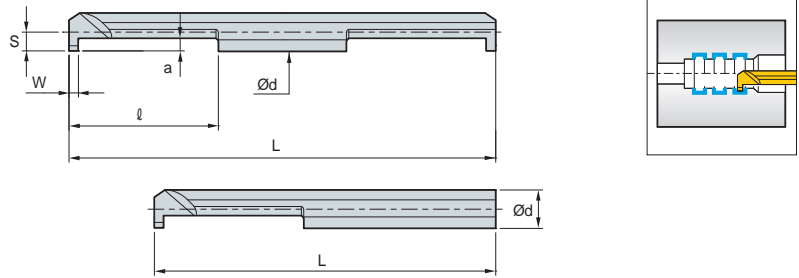
(mm)

Twin Edge			Single Edge			Ød	Min.dia. of machining	ℓ	Overall length		Detailed cutting edge		
Designation	Coated	Uncoated	Designation	Coated	Uncoated				L		W	a	S
	PC30M	Z12M		PC30M	Z12M				Double ended	Single ended			
MBFR 0410 0415 0420 0610 0615 0620	●		MBFR 0410-1 0415-1 0420-1 0610-1 0615-1 0620-1			4.0	4.2	10	40	35	0.8	1.0	1.9
	●			15	50				45				
	●			6.0	6.2	10	45	40	1.4	1.2	2.9		
	●						15	55				45	
	●			6.0	6.2	10	45	40	1.4	1.2	2.9		
	●						15	55				45	
●													

● : Stock item



# Square Grooving



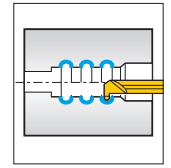
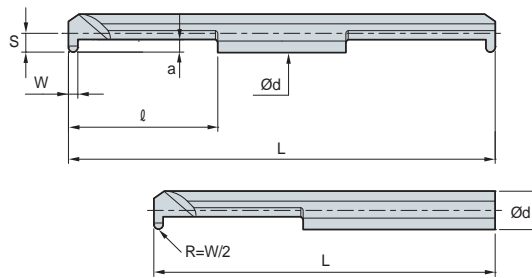
(mm)

Twin Edge			Single Edge			Ød	Min.dia. of machining	l	Overall length		Detailed cutting edge			
Designation	Coated	Uncoated	Designation	Coated	Uncoated				L		W	a	S	
	PC30M	Z12M		PC30M	Z12M				Double ended	Single ended				
MGR	0310-1.0	●	MGR	0310-1.0-1		3.0	3.2	10	40	35	1.0	0.8	1.4	
	0315-1.0	●		0315-1.0-1				15	50	45				
	0310-1.5	●		0310-1.5-1				10	40	35				1.5
	0315-1.5	●		0315-1.5-1				15	50	45				
	0410-1.0	●		0410-1.0-1		4.0	4.2	10	40	35	1.0	1.4	1.9	
	0420-1.0			0420-1.0-1				20	60	50				
	0410-1.5			0410-1.5-1				10	40	35	1.5			
	0420-1.5			0420-1.5-1				20	60	50				
	0410-2.0	●		0410-2.0-1				10	40	35	2.0			
	0420-2.0			0420-2.0-1				20	60	50				
	0610-1.0	●		0610-1.0-1		6.0	6.2	10	45	40	1.0	1.8	2.9	
	0620-1.0	●		0620-1.0-1				20	65	50				
	0610-1.5	●		0610-1.5-1				10	45	40	1.5			
	0620-1.5	●		0620-1.5-1				20	65	50				
	0610-2.0	●		0610-2.0-1				10	45	40	2.0			
	0620-2.0	●		0620-2.0-1				20	65	50				
	0610-2.5	●		0610-2.5-1				10	45	40	2.5			2.0
	0620-2.5	●		0620-2.5-1				20	65	50				
	0820-1.5	●		0820-1.5-1		8.0	8.2	20	70	60	1.5	2.5	3.9	
	0820-2.0	●		0820-2.0-1							2.0			
0820-2.5	●	0820-2.5-1		2.5	3.5									
0820-3.0	●	0820-3.0-1		3.0										
1025-1.5	●	1025-1.5-1		10.0	10.2	25	80	70	1.5	2.5	4.9			
1025-2.0	●	1025-2.0-1							2.0					
1025-2.5	●	1025-2.5-1							2.5			3.5		
1025-3.0	●	1025-3.0-1							3.0					

● : Stock item



## Round Grooving

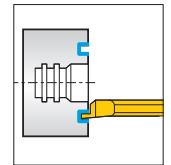
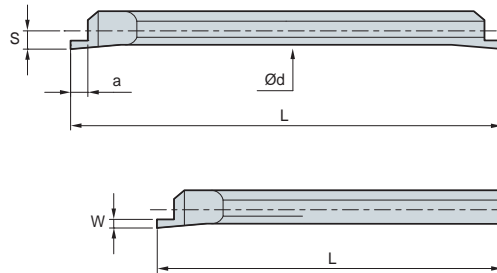
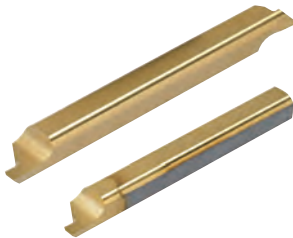


(mm)

Twin Edge			Single Edge			Ød	Min.dia. of machining	l	Overall length		Detailed cutting edge		
Designation	Coated	Uncoated	Designation	Coated	Uncoated				L		W	a	S
	PC30M	Z12M		PC30M	Z12M				Double ended	Single ended			
MGRR	0310-0.8	●	MGRR	0310-0.8-1		3.0	3.2	10	40	35	0.8	0.8	1.4
	0315-0.8	●		0315-0.8-1					15	50			
	0410-1.0	●		0410-1.0-1				4.0	4.2	10			
	0420-1.0	●		0420-1.0-1		20	60			50			
	0610-1.0	●		0610-1.0-1		6.0	6.2	10	45	40	1.0	2.0	2.9
	0620-1.0	●		0620-1.0-1					20	65			
	0610-1.5	●		0610-1.5-1				10	45	40			
	0620-1.5	●		0620-1.5-1				20	65	50			
	0610-2.0	●		0610-2.0-1				10	45	40			
	0620-2.0	●		0620-2.0-1		20	65	50					
	0820-1.0	●		0820-1.0-1		8.0	8.2	20	70	60	1.0	2.3	3.9
	0820-1.5	●		0820-1.5-1							1.5		
	0820-2.0	●		0820-2.0-1							2.0		
	1025-1.0	●		1025-1.0-1		10.0	10.2	25	80	70	1.0	2.8	4.9
	1025-1.5	●		1025-1.5-1							1.5		
1025-2.0	●	1025-2.0-1		2.0									

●: Stock item

## Face Grooving



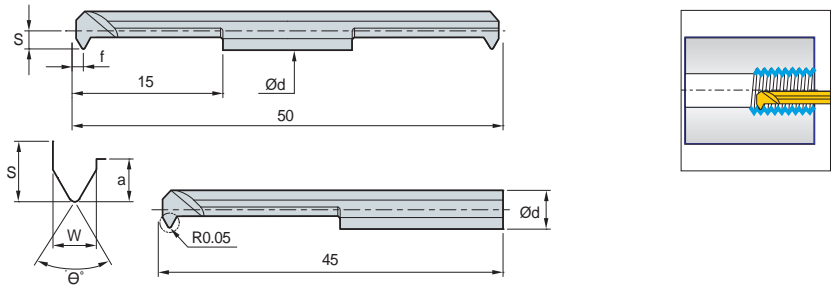
(mm)

Twin Edge			Single Edge			Ød	Min.dia. of machining	Overall length		Detailed cutting edge		
Designation	Coated	Uncoated	Designation	Coated	Uncoated			L		W	a	S
	PC30M	Z12M		PC30M	Z12M			Double ended	Single ended			
MGFR	0400-1.0	●	MGFR	0400-1.0-1		4.0	6.0	50	45	1.0	1.5	1.8
	0400-1.5	●		0400-1.5-1						1.5	2.0	
	0600-1.0	●		0600-1.0-1				6.0	8.5	50	45	
	0600-1.5	●		0600-1.5-1		1.5	2.0					
	0600-2.0	●		0600-2.0-1		8.0	10.4	70	60	2.0	2.5	3.9
	0800-1.0	●		0800-1.0-1						1.0	1.5	
	0800-1.5	●		0800-1.5-1						1.5	2.0	
	0800-2.0	●		0800-2.0-1						2.0	2.5	
	0800-2.5	●		0800-2.5-1						2.5	3.0	
	0800-3.0	●		0800-3.0-1		3.0	3.5					
				0800-3.5-1		3.5	4.0					
	1000-2.0	●		1000-2.0-1		10.0	12.4	80	70	2.0	2.5	4.9
	1000-2.5	●		1000-2.5-1						2.5	3.0	
	1000-3.0	●		1000-3.0-1						3.0	3.5	
	1000-3.5	●		1000-3.5-1						3.5	4.0	
1000-4.0	●	1000-4.0-1		4.0	4.5							
1000-4.5	●	1000-4.5-1		4.5	5.0							

●: Stock item



# Threading



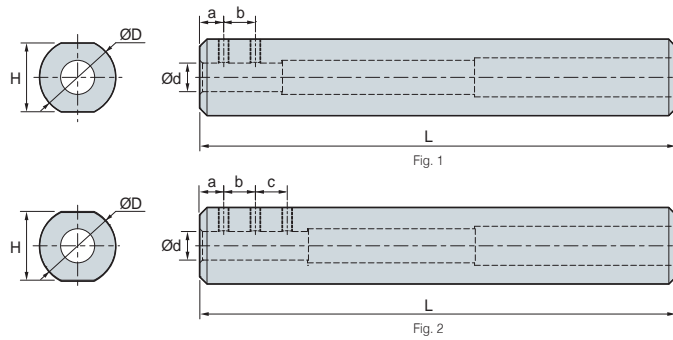
(mm)

Twin Edge			Single Edge			Ød	Min. dia. of machining	Threading			Detailed cutting edge		
Designation	Coated PC30M	Uncoated Z12M	Designation	Coated PC30M	Uncoated Z12M			W	Pitch / tpi	θ°	S	a	f
MTR	0315-F60		MTR	0315-F60-1		3.0	3.3	1.2	0.5~1.0	60°	1.45	1.2	0.6
	0415-F60	●		0415-F60-1		4.0	4.3						
	0615-A60	●		0615-A60-1		6.0	6.2				2.0		
	0315-F55	●		0315-F55-1		3.0	3.3	1.2	48~24	55°	1.45	1.2	0.6
	0415-F55	●		0415-F55-1		4.0	4.3						
	0615-A55	●		0615-A55-1		6.0	6.2				2.0		

● : Stock item

## SLEEVE

# SL(SLEEVE)



(mm)

Designation	Ød	a	b	c	ØD	H	L	Screw	Wrench	Fig.
SL1603	3	5	-	-	16	14	100	M3	HW15L	1
SL1604	4	5	6	-	16	14	100	M4	HW20L	
SL1605	5	5	8	-	16	14	100	M4	HW20L	
SL1606	6	5	6	6	16	14	100	M4	HW20L	2
SL1607	7	5	6	8	16	14	100	M4	HW20L	
SL2008	8	5	10	10	20	18	100	M4	HW20L	2
SL2010	10	5	10	10	20	18	100	M5	HW20L	

\* Fine tolerance and surface roughness

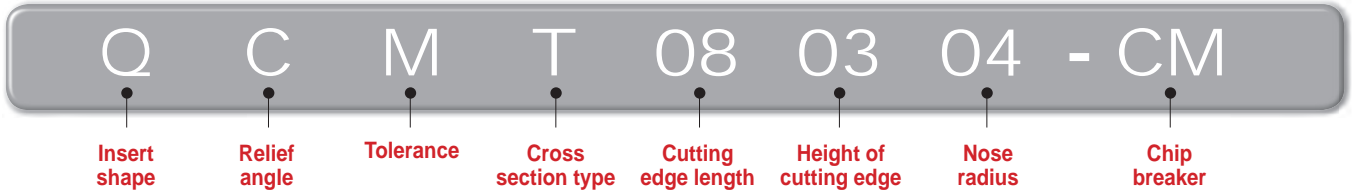


# B Technical Information for Multi Turn

## Multi Turn

### Code system

#### • Insert

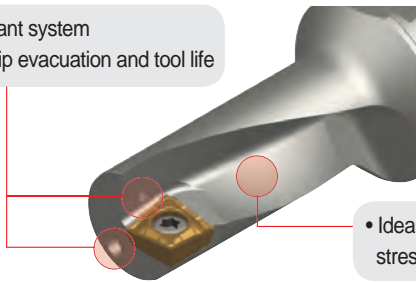


#### • Holder



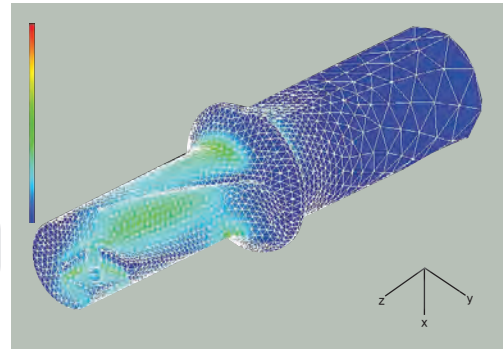
### Tool design by FEM analysis

- Double coolant system
- Excellent chip evacuation and tool life



- Ideal flute design minimizing stress concentrations

※ Notice: Clamp an insert shown as in the picture

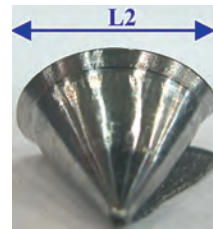
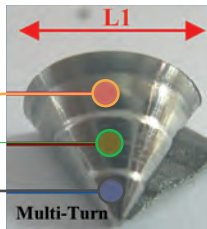
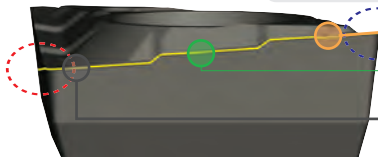


- Minimized stress during cutting, prevented damage from vibration and longer tool life
- Optimized design

### Creative stepping cutting edge

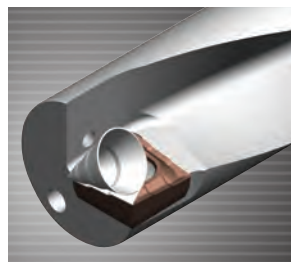
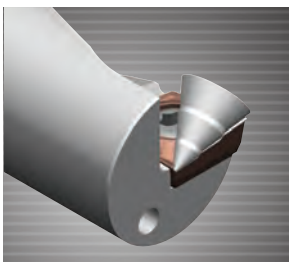
Drilling edge (Drilling)

Turning edge (Internal, external and face turning)



- Special chip formed by edge geometry better chip

- Evacuation due to small radius width of chip curl

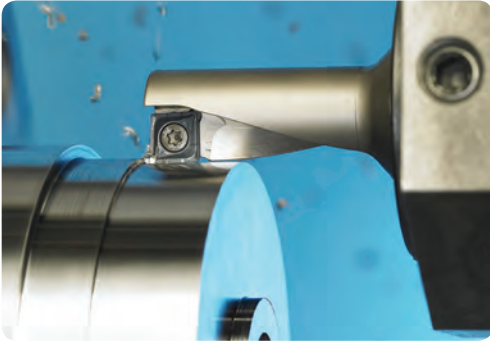


Comparison	Multi turn	Competitor A	Competitor B
$f_n$ (mm/rev) = 0.08			
Feed $f_n$ (mm/rev) = 0.10			
Chip width (rate)	80%	100%	120%

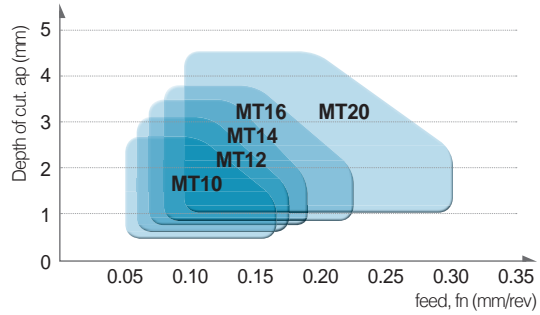


## User's guide

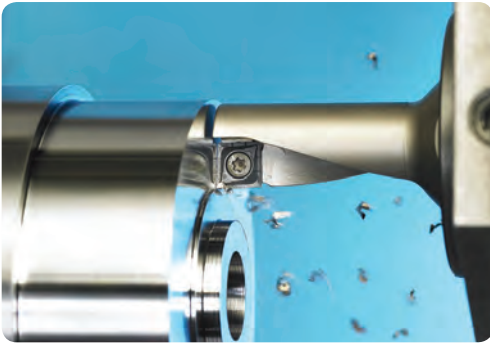
### External / Internal turning



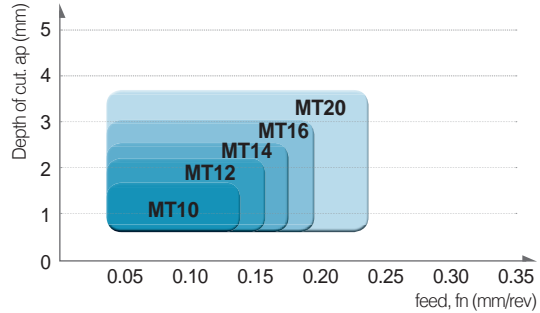
● Application range



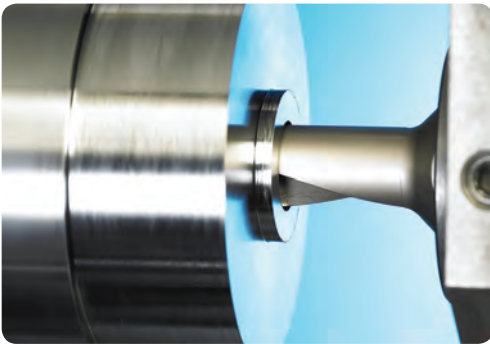
### Facing



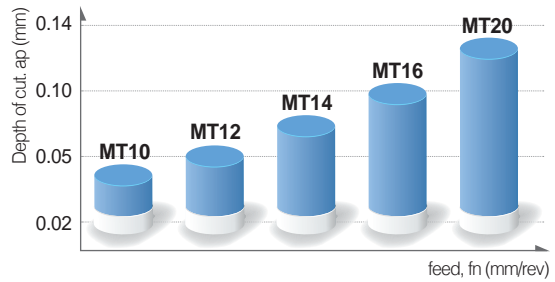
● Application ranges of facing



### Drilling

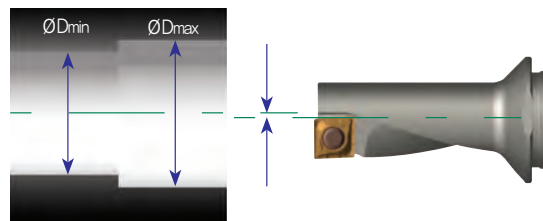


● Drilling feed range by designation



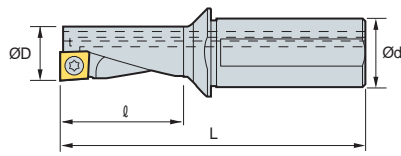
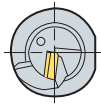
### Offset (Diameter compensation)

Disignation	Machined diameter (mm)	ØDmin (mm)	ØDmax (mm)
MT10R/L-2.25D	10	9.85	10.35
MT12R/L-2.25D	12	11.85	12.35
MT14R/L-2.25D	14	13.85	14.35
MT16R/L-2.25D	16	15.85	16.35
MT20R/L-2.25D	20	19.85	20.35
MT25R/L-2.25D	25	24.85	25.35
MT32R/L-2.25D	32	31.85	32.35



Drill diameter is adjustable by the offset compensation

## MT (Multi-Turn)



(mm)

Designation	ØD	Ød	l	L	Insert	Screw	Wrench
<b>MT</b>							
10R/L-2.25D	10	12	22.5	69.5	QC□T050204	FTNA0204S	TW06P
12R/L-2.25D	12	16	27.0	78.0	QC□T060204	FTNA02205S	TW06P
14R/L-2.25D	14	16	31.5	83.5	QC□T070304	FTKA02555	TW07P
16R/L-2.25D	16	20	36.0	94.0	QC□T080304	FTNA0306	TW09P
20R/L-2.25D	20	25	45.0	111.0	QC□T10T304	FTNA03508	TW15P
25R/L-2.25D	25	32	56.5	130.0	QC□T130408	FTNC04509	TW20S
32R/L-2.25D	32	40	72.0	160.0	QC□T170508	FTNC04511	TW20S

### Insert

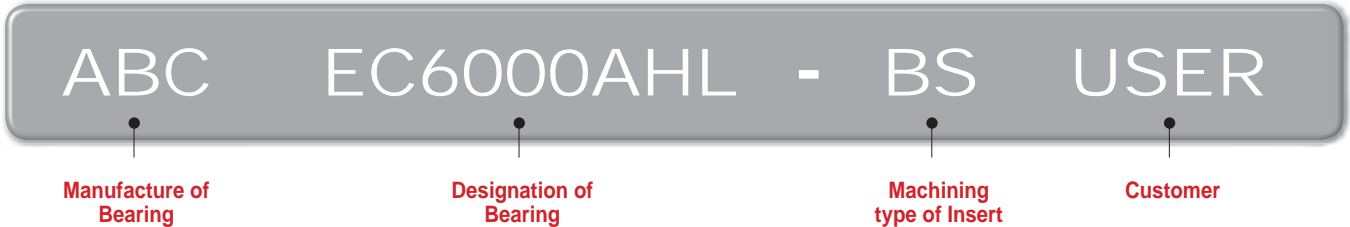
Picture	Designation	Coated				Uncoated		Dimensions (mm)					Configuration
		NC3120	NC3225	NC6315	PC5300	H01	H05	l	d	t	r	Ød <sub>1</sub>	
	<b>QCMT</b> 050204-CM		●	●	●			5.0	5.4	2.10	0.4	2.3	
	060204-CM		●	●	●			6.0	6.4	2.38	0.4	2.5	
	070304-CM		●	●	●			7.0	7.4	3.18	0.4	2.8	
	080304-CM		●	●	●			8.0	8.4	3.18	0.4	3.4	
	10T304-CM		●		●			10.0	10.4	3.97	0.4	4.0	
	130408-CM		●		●			12.7	13.5	4.76	0.8	5.5	
	170508-CM		●	●	●			16.7	17.5	5.56	0.8	5.5	
	<b>QCGT</b> 050204-CA					●		5.0	5.4	2.10	0.4	2.3	
	060204-CA					●		6.0	6.4	2.38	0.4	2.5	
	070304-CA					●		7.0	7.4	3.18	0.4	2.8	
	080304-CA					●		8.0	8.4	3.18	0.4	3.4	
	10T304-CA					●		10.0	10.4	3.97	0.4	4.0	
	130408-CA					●		12.7	13.5	4.76	0.8	5.5	
	170508-CA					●		16.7	17.5	5.56	0.8	5.5	



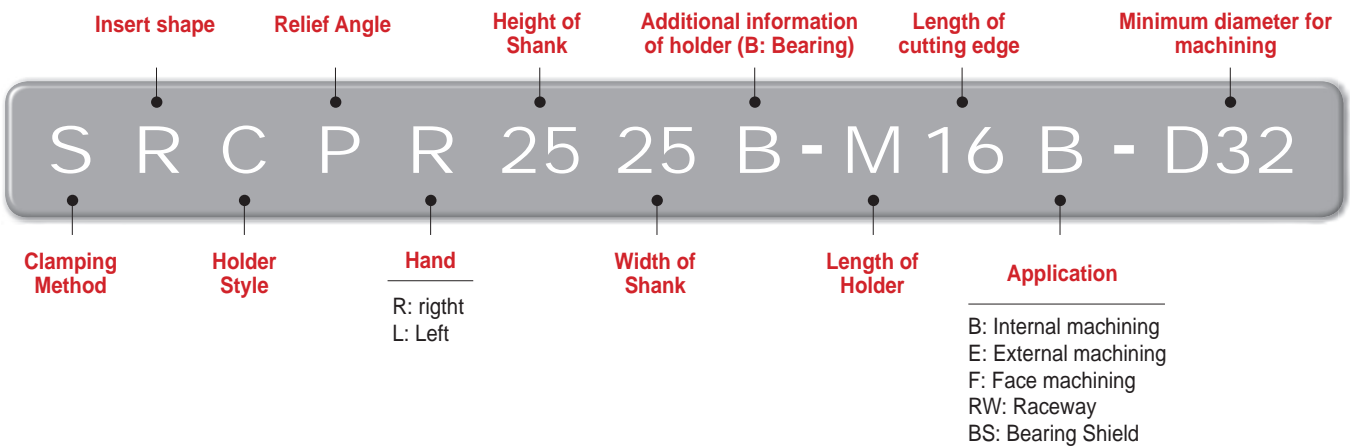
# Bearing Solution

## Code system

### • Insert

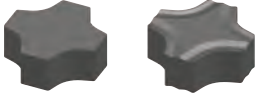


### • Holder

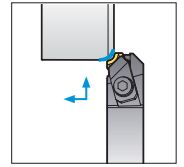
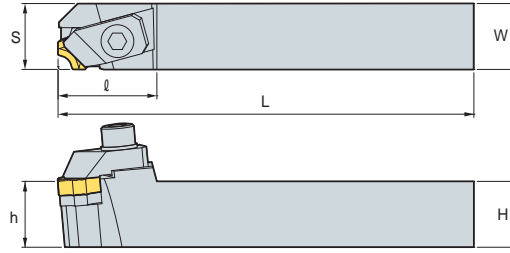
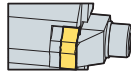


# B Bearing Solution

## CMSN...F Type



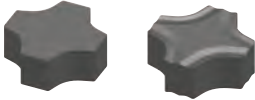
MC12□□ MC12□□-BR  
MC15□□



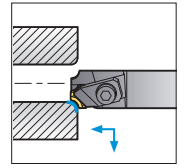
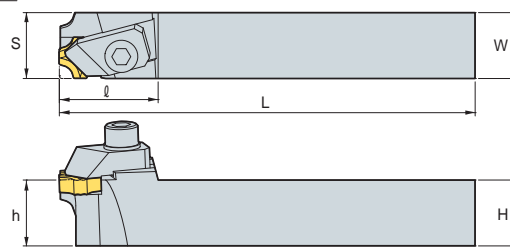
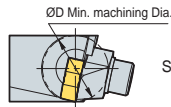
• R type insert (mm)

Designation	H	W	L	S	h	q	Insert	Clamp	Clamp Screw	Shim	Shim Screw	Wrench
CMSNR/L 2020B-L12F	20	20	140	21	20	33	MC12□□	CH6R/L1B	BHA0620	SX42CB	SS0308	HW50L
2023B-L12F	20	23	140	24	20	33	MC12□□-BR					
2525B-L15F	25	25	140	26	25	35	MC15□□	CH6R/L1B	BHA0620	SX52CB	SS0408	HW50L

## CMSN...B Type



MC12□□ MC12□□-BR



• R type insert (mm)

Designation	ØD	H	W	L	S	h	q	Insert	Clamp	Clamp Screw	Shim	Shim Screw	Wrench
CMSNR/L 2020B-L12B-D28	28	20	20	140	21	20	33	MC12□□	CH6R/L1B	BHA0620	SX42CB	SS0308	HW50L
2525B-L12B-D28	28	25	25	140	26	25	33		CH6R/L1B	BHA0620	SX42CB	SS0308	HW50L
1620B-L12B-D20	20	16	20	140	18	16	32	MC12□□-BR	CH6R/L1B	BHA0620	-	-	HW50L
2023B-L12B-D28	28	20	23	140	24	20	33		CH6R/L1B	BHA0620	SX42CB	SS0308	HW50L

## Insert

Application	Picture	Designation	Cermet	Dimensions (mm)					Configuration
			CN2500	R	θ°	B	d	t	
R-Chamfering		MC0906		0.6	12	1.8	9.525	3.18	
		MC0910		1.0	12	2.4	9.525	3.18	
		MC1206		0.6	18	1.8	12.7	4.76	
		MC1210		1.0	18	2.4	12.7	4.76	
		MC1212		1.2	18	2.2	12.7	4.76	
		MC1215		1.5	18	3.0	12.7	4.76	
		MC1220		2.0	18	3.8	12.7	4.76	
		MC1225		2.5	18	2.8	12.7	4.76	
		MC1525		2.5	18	4.0	15.875	5.56	
		MC1530		3.0	18	4.7	15.875	5.56	
	MC1540		4.0	20	4.7	15.875	5.56		
		MC1206-BR		0.6	18	1.8	12.7	4.76	
		MC1210-BR		1.0	18	2.4	12.7	4.76	
		MC1212-BR		1.2	18	2.2	12.7	4.76	
		MC1215-BR		1.5	18	3.0	12.7	4.76	
		MC1220-BR		2.0	18	3.2	12.7	4.76	
MC1230-BR			3.0	18	3.7	12.7	4.76		
MC1235-BR		3.5	18	3.9	12.7	4.76			

• Stock item

## Special order-form

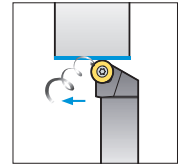
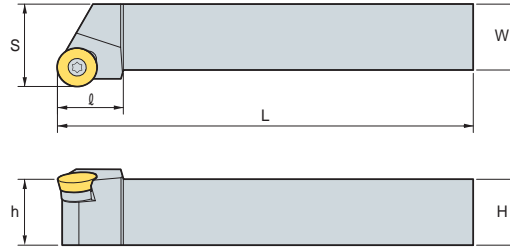
Designation	CN2500	R	θ°	B	d	t	Configuration
MC...							



## SRGP...E Type



RPGT1203M0  
RPGT1604M0  
RPGT2004M0



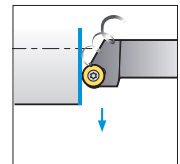
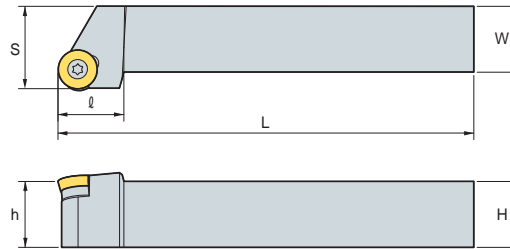
• R type insert  
(mm)

Designation	H	W	L	S	h	l	Insert	Screw	Shim	Shim Screw	Wrench
SRGPR/L 2020B-L12E	20	20	140	25	20	20	RPGT1203M0	FTKA0410	SR1203S	SHXN0609F	TW15P
2020B-L16E	20	20	140	25	20	20	RPGT1604M0	FTNA0513	SR16T3S	SHXN0712F	TW20P
2525B-L20E	25	25	140	32	25	30	RPGT2004M0	FTNA0513	SR20T3S	SHXN0712F	TW20P

## SRGP...F Type



RPGT1203M0  
RPGT1604M0  
RPGT2004M0



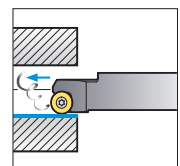
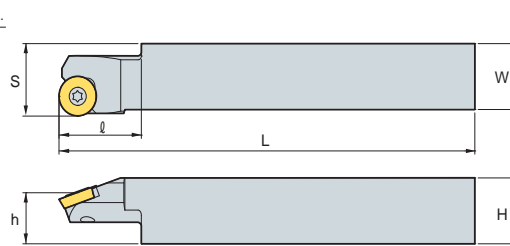
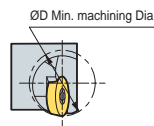
• R type insert  
(mm)

Designation	H	W	L	S	h	l	Insert	Screw	Shim	Shim Screw	Wrench
SRGPR/L 2020B-L12F	20	20	140	25	20	20	RPGT1203M0	FTKA0410	SR1203S	SHXN0609F	TW15P
2020B-L16F	20	20	140	25	20	20	RPGT1604M0	FTNA0513	SR16T3S	SHXN0712F	TW20P
2525B-L20F	25	25	140	32	25	30	RPGT2004M0	FTNA0513	SR20T3S	SHXN0712F	TW20P

## SRCP...B Type



RPGT0802M0  
RPGT1203M0  
RPGT1604M0



• R type insert  
(mm)

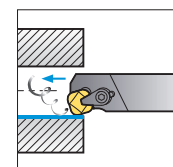
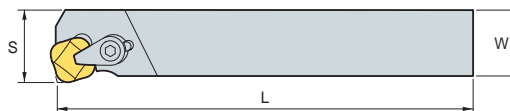
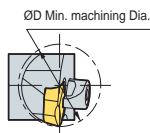
Designation	ØD	H	W	L	S	h	l	Insert	Screw	Wrench
SRCPR/L 2020B-L08B-D12	12	20	20	140	21.5	15.5	25	RPGT0802M0	FTKA0305	TW09P
1919B-L12B-D15	15	19	19	140	21	16	25	RPGT1203M0	FTNA0408	TW15P
2020B-L12B-D20	20	20	20	140	22	15.5	25	RPGT1203M0	FTNA0408	TW15P
2525B-L16B-D32	32	25	25	140	27	20	30	RPGT1604M0	FTKA0510	TW20P



## CSKP...B Type



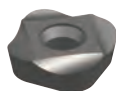
SPGR120440L



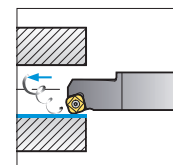
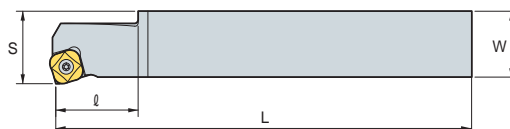
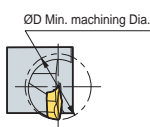
• R type insert (mm)

Designation	ØD	H	W	L	S	h	ℓ	Insert	Clamp	Clamp Screw	Wrench
CSKPR/L 2022B-L12B-D30	30	20	22	140	27	20	37	SPGR120440R/L	CH5R1	CHX0510	HW30L

## SSKP...B Type



SPGH090330L



• R type insert (mm)

Designation	ØD	H	W	L	S	h	ℓ	Insert	Screw	Wrench
SSKPR/L 2020B-L09B-D12	12	20	20	140	21.7	19	20	SPGH090330R/L	FTNA0307	TW09P
2020B-L09B-D13	13	20	20	140	21.7	19	20			
2020B-L09B-D20	20	20	20	140	21.7	19	20			

## Insert

Application	Picture	Designation	Cermet	Dimensions (mm)				Configuration
			CN2500	r	d	d <sub>1</sub>	t	
Internal turning		RPGT0802M0		-	8	3.4	2.38	
		RPGT1203M0		-	12	4.4	3.18	
		RPGT1604M0		-	16	5.5	4.76	
		RPGT2004M0		-	20	5.5	4.76	
		SPGR120440L		4.0	12.7	-	4.76	
		SPGH090330L		3.0	9.525	3.4	3.18	

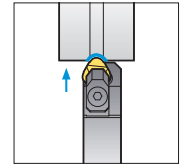
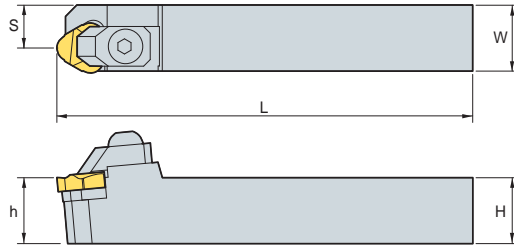
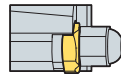
• Stock item



## CKFN...RW Type



KORIC



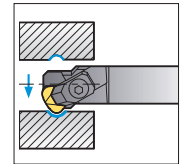
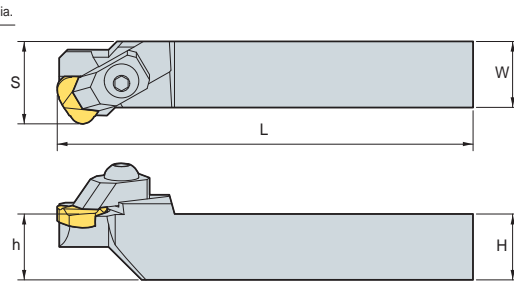
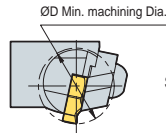
• R type insert (mm)

Designation	H	W	L	S	h	Insert	Clamp	Clamp Screw	Shim	Shim Screw	Wrench
CKFNR/L <b>2020B-L22RW</b>	20	20	140	12.5	20	KORIC2204R/L	CH6N1B	BHA0620	ST42CB	SS0408	HW50L
<b>2022B-L27RW</b>	20	22	140	13	20	KORIC2704R/L	CH8R/L1B	BHA0820	ST52CB	SS0408	HW60L
<b>2025B-L33RW</b>	20	25	140	16	20	KORIC3306R/L	CH8R/L1B	BHA0820	ST62CB	SS0408	HW60L
<b>2533B-L44RW</b>	25	33	140	21	25	KORIC4408R/L	CH8R/L1B	BHA0820	ST82CB	SS0408	HW60L

## CKGN...RW Type



KORIC



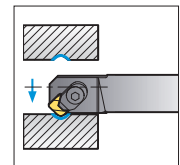
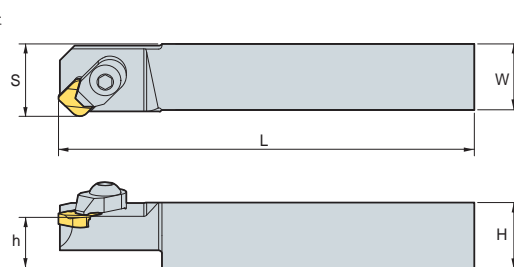
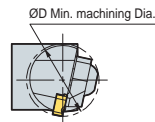
• R type insert (mm)

Designation	ØD	H	W	L	S	h	Insert	Clamp	Clamp Screw	Shim	Shim Screw	Wrench
CKGNR/L <b>2022B-L22RW-D23</b>	23	20	22	140	30	20	KORIC2204R/L	CH6R/L3B	BHA0620	ST42CB	SS0408	HW50L
<b>2022B-L27RW-D29</b>	29	20	22	140	34	20	KORIC2704R/L	CH6R/L7B	BHA0620	ST52CB	SS0408	HW50L
<b>2025B-L33RW-D38</b>	38	20	25	140	33	20	KORIC3306R/L	CH6R/L5B	BHA0620	ST62CB	SS0408	HW50L
<b>2528B-L38RW-D50</b>	50	25	28	140	46	25	KORIC3806R/L	CH8R/L2B	BHA0820	ST72CB	SS0408	HW60L
<b>2528B-L44RW-D52</b>	52	25	28	140	50	25	KORIC4408R/L	CH8R/L2B	BHA0820	ST82CB	SS0408	HW60L

## CSGN...RW Type



SNGN



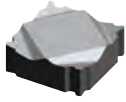
• R type insert (mm)

Designation	ØD	H	W	L	S	h	Insert	Clamp	Clamp Screw	Wrench
CSGNR/L <b>2020B-L09RW-D17</b>	17	20	20	140	22	20	SNGN0903WR/L	CH5R1	CHX0510	HW30L
<b>2020B-L09RW-D22</b>	22	20	20	140	22	20	SNGN0903WR/L	CH5R1	CHX0510	HW30L

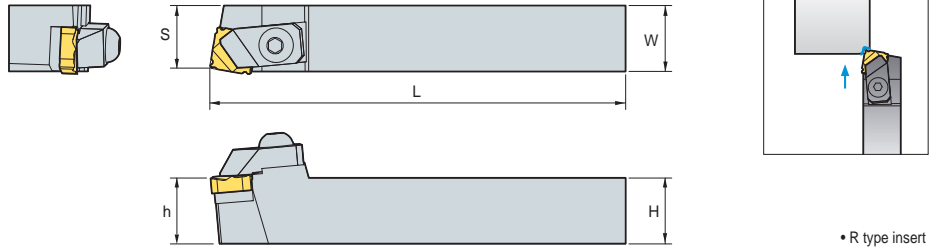


# B Bearing Solution

## CSBN...BS Type



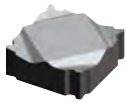
SNGN



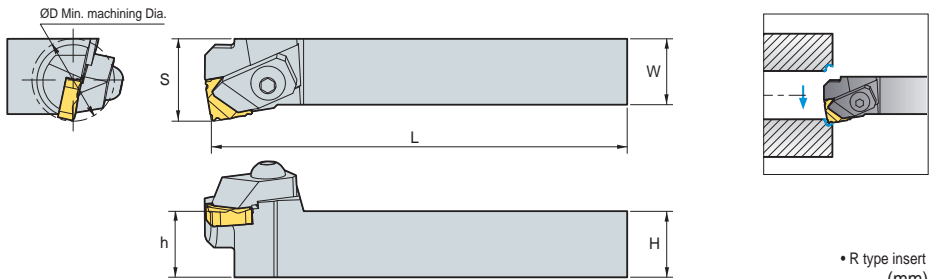
• R type insert (mm)

Designation	H	W	L	S	h	Insert	Clamp	Clamp Screw	Shim	Shim Screw	Wrench
CSBNR/L 2023B-L12BS	20	23	140	21	20	SNGN1204SR/L	CH6N1B	BHA0620	SS42CB	SS0308	HW50L
2525B-L15BS	25	25	140	23	25	SNGN1504SR/L	CH6N1B	BHA0620	SS52CB	SS0408	HW50L

## CSKN...BS Type



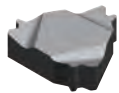
SNGN



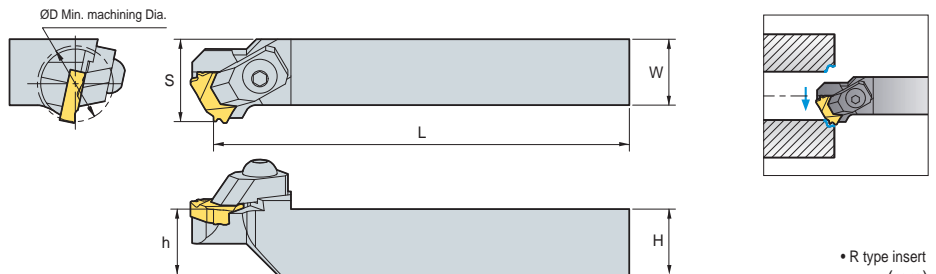
• R type insert (mm)

Designation	ØD	H	W	L	S	h	Insert	Clamp	Clamp Screw	Shim	Shim Screw	Wrench
CSKNR/L 1622B-L09BS-D14	14	16	22	140	16	16	SNGN0903SR/L	CH6R/L2B	BHA0620	-	-	HW50L
2022B-L12BS-D26	26	20	22	140	27	20	SNGN1204SR/L	CH6R/L1B	BHA0620	SS42CB	SS0308	HW50L
2525B-L15BS-D35	35	25	25	140	31	25	SNGN1504SR/L	CH6R/L3B	BHA0620	SS52CB	SS0408	HW50L

## CTGN...BS Type



TNGN



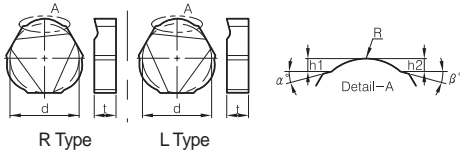
• R type insert (mm)

Designation	ØD	H	W	L	S	h	Insert	Clamp	Clamp Screw	Shim	Shim Screw	Wrench
CTGNR/L 2021B-K22BS-D25	25	20	21	140	30	20	TNGN2204SR/L	CH6R/L7B	BHA0620	ST42CB	SS0408	HW50L



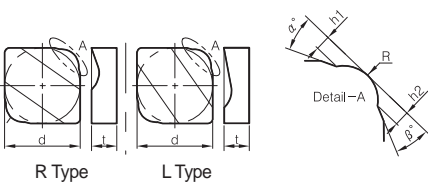
## Machining Race-way

### KORIC... R/L Type



		d	t	R	h <sub>1</sub>	h <sub>2</sub>	α°	β°
KORIC	2204R/L	12.7	4.76					
	2704R/L	15.875	4.76					
	3306R/L	19.05	6.0					
	3806R/L	22.225	6.0					
	4408R/L	25.4	8.0					

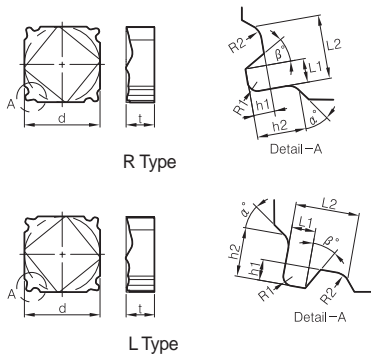
### SNGN... WR/L Type



		d	t	R	h <sub>1</sub>	h <sub>2</sub>	α°	β°
SNGN	0903WR/L	9.525	3.18					
	1504WR/L	15.875	4.76					
	1905WR/L	19.05	5.56					

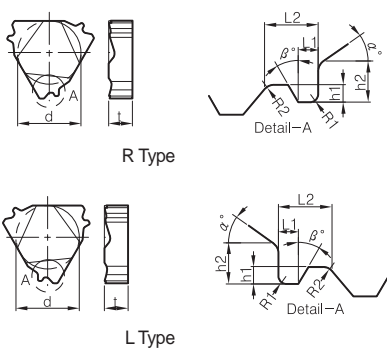
## Machining for Bearing shield

### KORIC... R/L Type



		d	t	L <sub>1</sub>	L <sub>2</sub>	h <sub>1</sub>	h <sub>2</sub>	R <sub>1</sub>	R <sub>2</sub>	α°	β°
SNGN	0903SR/L	9.525	3.18								
	1204SR/L	12.7	4.76								
	1504SR/L	15.875	4.76								

### TNGN...SR/L Type



		d	t	L <sub>1</sub>	L <sub>2</sub>	h <sub>1</sub>	h <sub>2</sub>	R <sub>1</sub>	R <sub>2</sub>	α°	β°
TNGN	02204SR/L	12.7	4.76								

# B External tool Holder Code System(ISO)

P S K N R 25 25 - M 12

1 Clamping Method of Insert    2 Insert Shape    3 Holder Style    4 Clearance Angle of Insert    5 Hand    6 Height of Shank    7 Width of Shank    8 Length of Holder    9 Length of Insert Cutting Edge

### 1 Clamping Method of Insert

P S K N R 25 25 - M 12

Top clamping without hole (C)  
 Top and hole clamping (Multi clamp, pin and clamp) (D)  
 Top and hole clamping (Multi clamp, pin and clamp) (M)  
 Hole clamping (Pin lock) (P)  
 Screw on (S)  
 Top and hole clamping (Wedge clamp, pin and clamp) (W)

### 2 Insert Shape

P S K N R 25 25 - M 12

C (80°), D (55°), E (75°), K (55°)  
 L, R, S, T  
 V (35°), W (80°)

### 3 Holder Style

P S K N R 25 25 - M 12

B (75°), D (45°), E (60°), F (90°), G (90°), J (93°), K (75°)  
 L (95°), N (62.5°), R (75°), S (45°), T (60°), V (72.5°), Y (85°)

### 4 Clearance Angle of Insert

P S K N R 25 25 - M 12

B (5°), C (7°), D (15°), E (20°)  
 F (25°), N (0°), P (11°)

### 5 Hand

P S K N R 25 25 - M 12

L, N, R

### 6 Height of Shank

P S K N R 25 25 - M 12

H

### 7 Width of Shank

P S K N R 25 25 - M 12

W

### 8 Length of Holder

P S K N R 25 25 - M 12

A-32	H-100	Q-180	X-Special Item
B-40	J-110	R-200	
C-50	K-125	S-250	
D-60	L-140	T-300	
E-70	M-150	U-350	
F-80	N-160	V-400	
G-90	P-170	W-450	

### 9 Length of Insert Cutting Edge

P S K N R 25 25 - M 12

A, B, K; C, D, E, M, V; H; L; O; P; R; S; T; W



## Double Clamp System

Cutting Shape										
Designation	DCBNR/L	DCKNR/L	DCLNR/L	DDJNR/L	DSBNR/L	DSDNN	DSKNR/L	DSSNR/L	DTFNR/L	DTGNR/L
Approach angle	75°	75°	95°	93°	75°	45°	75°	45°	90°	90°
Page	B167	B167	B167	B168	B168	B169	B169	B169	B170	B170
Turning	●		●	●	●	●		●		●
Copying				●						
Facing		●	●				●	●	●	
Chamfering						●				
Back turning			●	●						
Cutting Shape										
Designation	DVJNR/L	DVVNN	DWLNR/L							
Approach angle	93°	72.5°	95°							
Page	B170	B171	B171							
Turning	●	●	●							
Copying	●	●								
Facing			●							
Chamfering										
Back turning	●		●							

## Lever Lock System

Cutting Shape										
Designation	PCBNR/L	PCKNR/L	PCLNR/L	PDJNR/L	PDNNR/L	PRDCN	PRGCR/L	PSBNR/L	PSDNN	PSKNR/L
Approach angle	75°	75°	95°	93°	62.5°	-	-	75°	45°	75°
Page	B172	B172	B173	B173	B174	B174	B175	B175	B176	B176
Turning	●	●	●	●	●	●	●	●	●	
Copying				●	●	●	●			
Facing			●							●
Chamfering										
Back turning			●	●						
Cutting Shape										
Designation	PSSNR/L	PTFNR/L	PTGNR/L	PTTNR/L	PWLNR/L					
Approach angle	45°	90°	90°	60°	95°					
Page	B177	B177	B178	B178	B178					
Turning	●		●	●	●					
Copying										
Facing	●	●			●					
Chamfering				●						
Back turning					●					



## Wedge Clamp System

Cutting Shape										
Designation	WTENN	WTJNR/L	WTXNR/L	WWLNR/L						
Approach angle	60°	93°	105°	95°						
Page	B179	B179	B179	B180						
Turning	●	●	●	●						
Copying	●	●	●							
Facing				●						
Chamfering										
Back turning		●	●	●						

## Clamp on System

Cutting Shape										
Designation	CKJNR/L	CKNNR/L	CSDPN	CSKPR/L	CTFPR/L	CTGPR/L				
Approach angle	93°	62.5°	45°	75°	90°	90°				
Page	B181	B181	B181	B182	B182	B182				
Turning	●	●	●			●				
Copying	●	●								
Facing				●	●					
Chamfering										
Back turning	●									

## Multi Lock System

Cutting Shape										
Designation	MCKNR/L	MCLNR/L	MCMNN	MCRNR/L	MDJNR/L	MDNNN	MDQNR/L	MSBNR/L	MSDNN	MSKNR/L
Approach angle	75°	95°	50°	75°	93°	62.5°	107.5°	75°	45°	75°
Page	B183	B183	B183	B184	B184	B184	B185	B185	B185	B186
Turning		●	●	●	●	●	●	●	●	
Copying					●	●	●			
Facing	●	●								●
Chamfering										
Back turning		●			●		●			

Cutting Shape										
Designation	MSRNR/L	MSSNR/L	MTENN	MTFNR/L	MTGNR/L	MTJNR/L	MVJNR/L	MVQNR/L	MVVNN	MWLNR/L
Approach angle	75°	45°	60°	90°	90°	93°	93°	117.5°	72.5°	95°
Page	B186	B187	B187	B187	B188	B188	B188	B189	B189	B189
Turning	●	●	●		●	●	●	●	●	●
Copying			●			●	●	●	●	
Facing		●		●		●				●
Chamfering										
Back turning						●	●	●		●



## Screw on System

Cutting Shape										
Designation	SCACR/L	SCLCR/L	SDACR/L	SDJCR/L	SDNCN	SRDCN	SRGCR/L	SSBCR/L	SSDCN	SSKCR/L
Approach angle	90°	95°	90°	93°	62.5°	-	-	75°	45°	75°
Page	B190	B190	B190	B191	B191	B191	B192	B192	B192	B192
Turning	●	●	●	●	●	●	●	●	●	
Copying			●	●	●	●	●			
Facing		●								●
Chamfering										
Back turning		●		●						

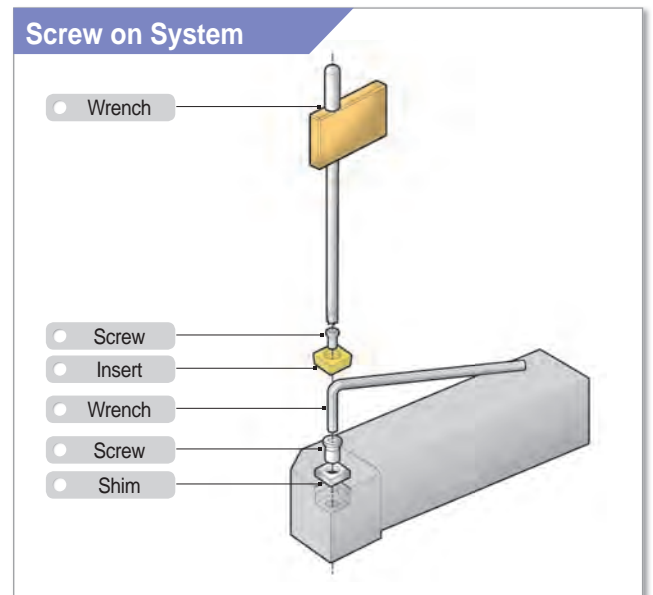
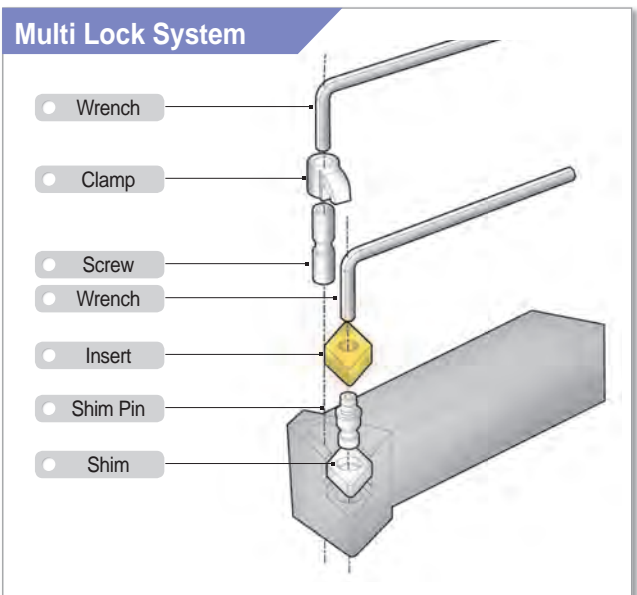
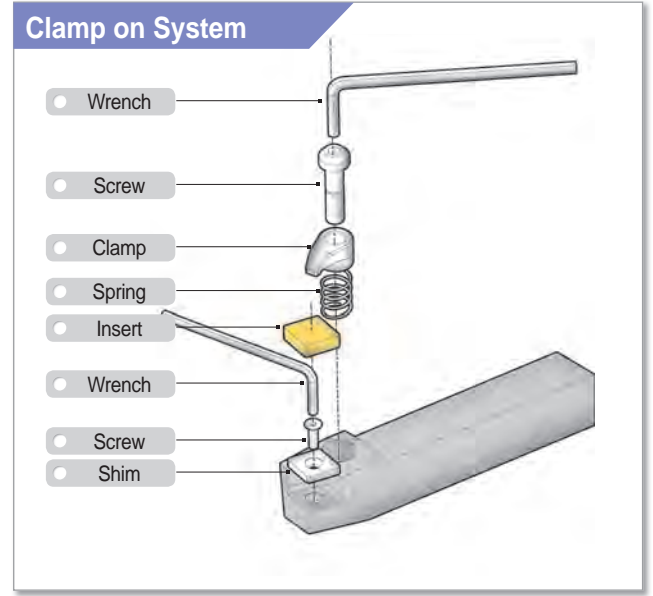
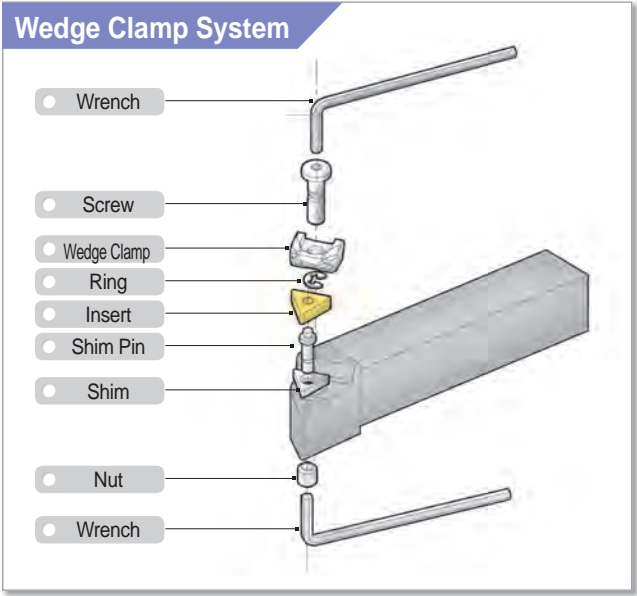
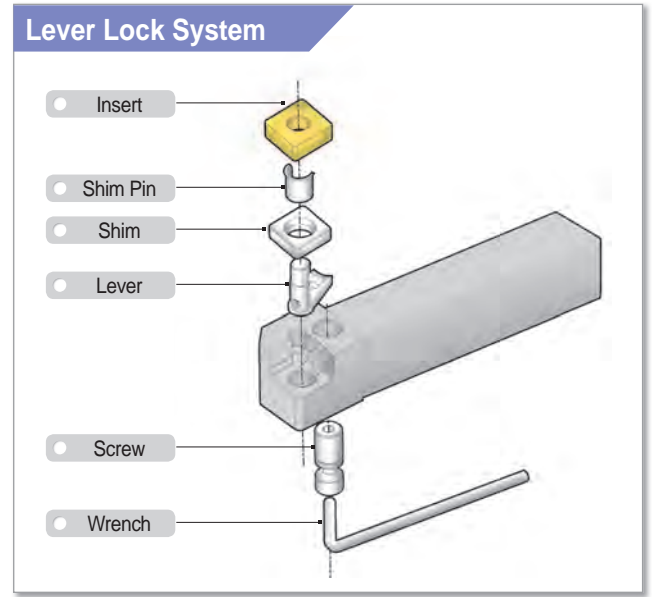
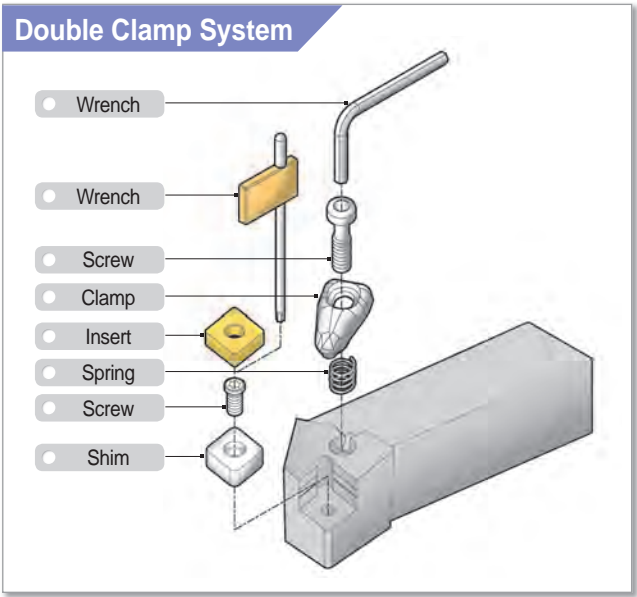
Cutting Shape										
Designation	SSSCR/L	STACR/L	STFCR/L	STGCR/L	STTCR/L	SVABR/L	SVHBR/L	SVJBR/L	SVJCR/L	SVVBN
Approach angle	45°	90°	90°	90°	60°	90°	107.5°	93°	93°	72.5°
Page	B193	B193	B194	B194	B194	B195	B195	B195	B196	B196
Turning	●	●		●	●	●	●	●	●	●
Copying						●	●	●	●	●
Facing	●		●							
Chamfering										
Back turning						●	●	●	●	

Cutting Shape										
Designation	SVVCN									
Approach angle	72.5°									
Page	B196									
Turning	●									
Copying	●									
Facing										
Chamfering										
Back turning										

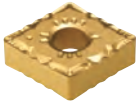
## Ceramic Holder

Cutting Shape										
Designation	CCNLR/L	CRDNN	CRGNR/L	CSDNN	CSKNR/L	CTFNR/L	CTGNR/L			
Approach angle	95°	-	-	45°	75°	90°	90°			
Page	B197	B197	B197	B197	B198	B198	B198			
Turning	●	●	●	●			●			
Copying			●							
Facing	●				●	●				
Chamfering										
Back turning	●									

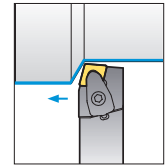
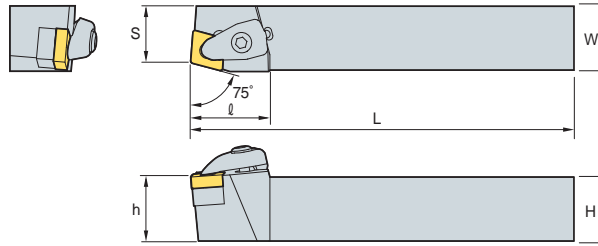
## Instruction of External Holder



## DCBNR/L



CN□□



75°

• R type insert (mm)

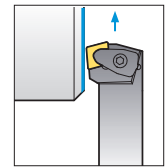
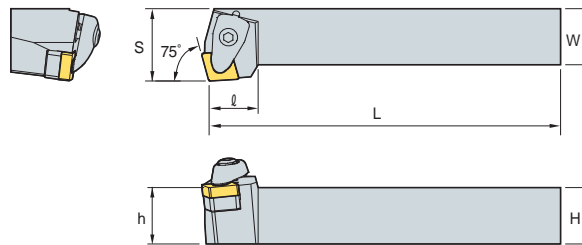
Designation	H	W	L	S	h	ℓ	Insert	Clamp	Clamp Screw	Shim	Shim Screw	Spring	Wrench						
DCBNR/L	2020-K12	20	20	125	17	20	CN□□1204□□												
	2525-M12	25	25	150	22	25								CVH4	CHX0518	SC44V	FTKA0410	SPR0714	HW30P
	3225-P12	32	25	170	22	32								CVH5	CHX0622	SC54V	FTNA0511	SPR0811	HW40L
2525-M16	25	25	150	22	25	36	CN□□1606□□												
3232-P16	32	32	170	27	32	CVH5								CHX0622	SC54V	FTNA0511	SPR0811	HW40L	
3232-P19	32	32	170	27	32	40								CVH6	CHX0622	SC63V	FTNA0511	SPR0811	HW40L
4040-S19	40	40	250	35	40	40	CN□□1906□□												

➔ Applicable inserts B36~B42

## DCKNR/L



CN□□



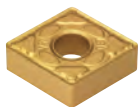
75°

• R type insert (mm)

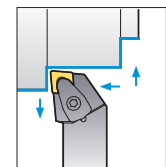
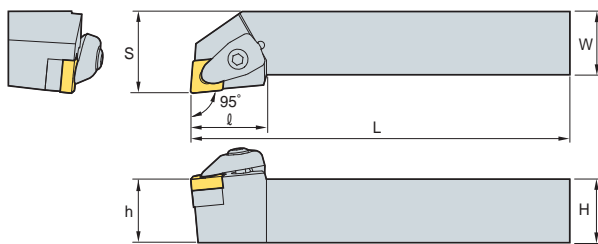
Designation	H	W	L	S	h	ℓ	Insert	Clamp	Clamp Screw	Shim	Shim Screw	Spring	Wrench						
DCKNR/L	2020-K12	20	20	125	25	20	CN□□1204□□												
	2525-M12	25	25	150	32	25								CVH4	CHX0518	SC44V	FTKA0410	SPR0714	HW30P
	3225-P12	32	25	170	32	32								21	CVH5	CHX0622	SC54V	FTNA0511	SPR0811
3232-P16	32	32	170	40	32	26	CN□□1606□□												
4040-S16	40	40	250	50	40	26								CVH5	CHX0622	SC54V	FTNA0511	SPR0811	HW40L

➔ Applicable inserts B36~B42

## DCLNR/L



CN□□



95°

• R type insert (mm)

Designation	H	W	L	S	h	ℓ	Insert	Clamp	Clamp Screw	Shim	Shim Screw	Spring	Wrench							
DCLNR/L	2020-K09	20	20	125	25	20	CN□□0903□□													
	2525-M09	25	25	150	32	25								24.5	CVH3	CHX0415	SC32V	FTKA0307	SPR0510	HW25P
DCLNR/L	2020-K12	20	20	125	25	20	CN□□1204□□													
	2525-M12	25	25	150	32	25								30	CVH4	CHX0518	SC44V	FTKA0410	SPR0714	HW30P
	3225-P12	32	25	170	32	32								30	CVH5	CHX0622	SC54V	FTNA0511	SPR0811	HW40L
3232-P12	32	32	170	40	32	30	CN□□1606□□													
2525-M16	25	25	150	32	25	36								CVH5	CHX0622	SC54V	FTNA0511	SPR0811	HW40L	
3225-P16	32	25	170	32	32	36	CN□□1906□□													
3232-P16	32	32	170	40	32	36								CVH6	CHX0622	SC63V	FTNA0511	SPR0811	HW40L	
2525-M19	25	25	150	32	25	40								CVH6	CHX0622	SC63V	FTNA0511	SPR0811	HW40L	
3225-P19	32	25	170	32	32	40	CN□□1906□□													
3232-P19	32	32	170	40	32	40								CVH6	CHX0622	SC63V	FTNA0511	SPR0811	HW40L	
4040-S19	40	40	250	50	40	40	CN□□1906□□													

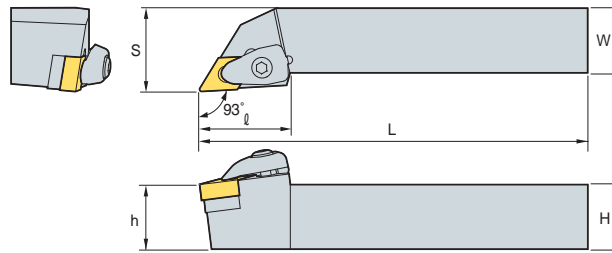
➔ Applicable inserts B36~B42

# B Double Clamp System

## DDJNR/L



DN□□



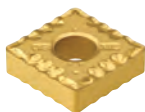
93°

• R type insert (mm)

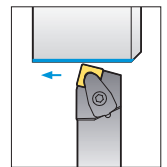
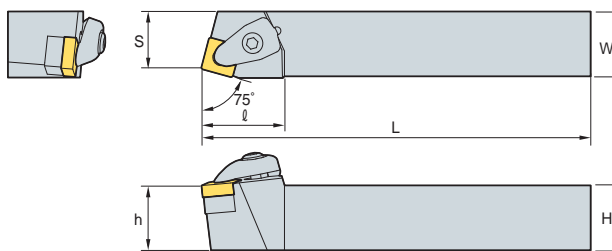
Designation	H	W	L	S	h	ℓ	Insert	Clamp	Clamp Screw	Shim	Shim Screw	Spring	Wrench
<b>DDJNR/L</b> 2020-K11	20	20	125	25	20	30	DN□□1104□□						
2525-M11	25	25	150	32	25	30							
3225-P11	32	25	170	32	32	30							
3232-P11	32	32	170	40	32	30							
2020-K15	20	20	125	25	20	35	DN□□1506□□						
2525-M15	25	25	150	32	25	35							
3225-P15	32	25	170	32	32	35							
3232-P15	32	32	170	40	32	35							
2020-K15-3	20	20	125	25	20	35	DN□□1504□□						
2525-M15-3	25	25	150	32	25	35							
3232-P15-3	32	32	170	40	32	35							

↻ Applicable inserts B43-B48

## DSBNR/L



SN□□



75°

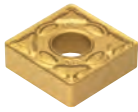
• R type insert (mm)

Designation	H	W	L	S	h	ℓ	Insert	Clamp	Clamp Screw	Shim	Shim Screw	Spring	Wrench
<b>DSBNR/L</b> 2020-K09	20	20	125	17	20	25	SN□□0903□□						
2525-M09	25	25	150	22	25	25							
2020-K12	20	20	125	17	20	32							
2525-M12	25	25	150	22	25	32	SN□□1204□□						
3225-P12	32	25	170	22	32	32							
3232-P12	32	32	170	27	32	32							
2525-M15	25	25	150	22	25	38	SN□□1506□□						
3225-P15	32	25	170	22	32	38							
3232-P15	32	32	170	27	32	38							
3232-P19	32	32	170	27	32	43	SN□□1906□□						
4040-S19	40	40	250	35	40	43							

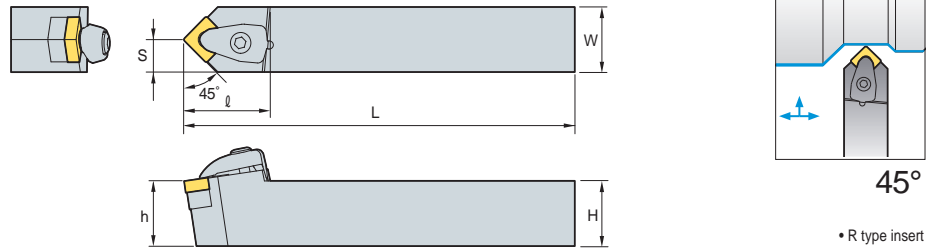
↻ Applicable inserts B50-B57



## DSDNN



SN□□



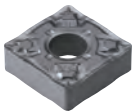
45°

\* R type insert (mm)

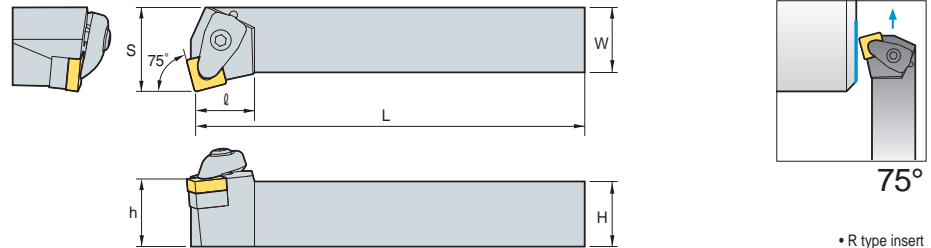
Designation	H	W	L	S	h	ℓ	Insert	Clamp	Clamp Screw	Shim	Shim Screw	Spring	Wrench
DSDNN 2020-K09	20	20	125	10	20	26.5	SN□□0903□□	CVH3	CHX0415	SS32V	FTKA0307	SPR0510	HW25P
2020-K12	20	20	125	10	20	33	SN□□1204□□	CVH4	CHX0518	SS44V	FTKA0410	SPR0714	HW30P
2525-M12	25	25	150	12.5	25	33							
3225-P12	32	25	170	12.5	32	33							
3232-P12	32	32	170	16	32	33	SN□□1506□□	CVH5	CHX0622	SS54V	FTNA0511	SPR0811	HW25P
2525-M15	25	25	150	12.5	25	39.4							
3232-P15	32	32	170	16	32	38							
3232-P19	32	32	170	16	32	43	SN□□1906□□	CVH6	CHX0622	SS64V	FTNA0511	SPR0811	HW40L
4040-S19	40	40	250	20	40	45							

↻ Applicable inserts B50-B57

## DSKNR/L



SN□□



75°

\* R type insert (mm)

Designation	H	W	L	S	h	ℓ	Insert	Clamp	Clamp Screw	Shim	Shim Screw	Spring	Wrench
DSKNR/L 2020-K09	20	20	125	25	20	20	SN□□0903□□	CVH3	CHX0415	SS32V	FTKA0307	SPR0510	HW25P
2020-K12	20	20	125	25	20	23	SN□□1204□□	CVH4	CHX0518	SS44V	FTKA0410	SPR0714	HW30P
2525-M12	25	25	150	32	25	23							
3232-P12	32	32	170	40	32	23							
3232-P15	32	32	170	40	32	28	SN□□1506□□	CVH5	CHX0622	SS54V	FTNA0511	SPR0811	HW40L
3232-P19	32	32	170	40	32	35	SN□□1906□□	CVH6	CHX0622	SC64V	FTNA0511	SPR0811	HW40L
4040-S19	40	40	250	50	40	43							

↻ Applicable inserts B50-B57

## DSSNR/L



SN□□



45°

\* R type insert (mm)

Designation	H	W	L	S	h	ℓ	Insert	Clamp	Clamp Screw	Shim	Shim Screw	Spring	Wrench
DSSNR/L 2020-K09	20	20	125	25	20	28.5	SN□□0903□□	CVH3	CHX0415	SS32V	FTKA0307	SPR0510	HW25P
2020-K12	20	20	125	25	20	35	SN□□1204□□	CVH4	CHX0518	SS44V	FTKA0410	SPR0714	HW30P
2525-M12	25	25	150	32	25	35							
3225-P12	32	25	170	32	32	35							
3232-P12	32	32	170	40	32	35	SN□□1506□□	CVH5	CHX0622	SS54V	FTNA0511	SPR0811	HW40L
2525-M15	25	25	150	32	25	38.5							
3232-P15	32	32	170	40	32	38.5							
3232-P19	32	32	170	40	32	46	SN□□1906□□	CVH6	CHX0622	SS64V	FTNA0511	SPR0811	HW40L
4040-S19	40	40	250	50	40	46							

↻ Applicable inserts B50-B57

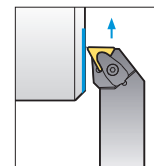
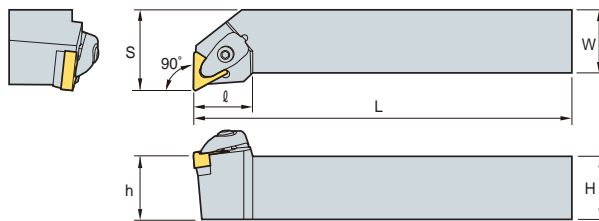


# B Double Clamp System

## DTFNR/L



TN□□



90°

• R type insert (mm)

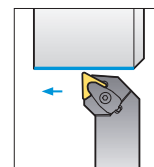
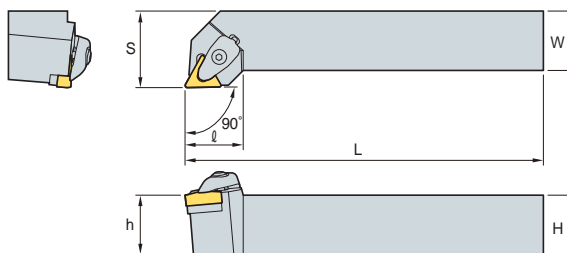
Designation	H	W	L	S	h	ℓ	Insert	Clamp	Clamp Screw	Shim	Shim Screw	Spring	Wrench	
DTFNR/L 2020-K16	20	20	125	25	20	24.5	TN□□1604□□							
	2525-M16	25	25	150	32	25								24.5
	3232-P16	32	32	170	40	32								23.5
DTFNR/L 2020-K16	2525-M22	25	25	150	32	25	TN□□2204□□							
	3225-P22	32	25	170	32	32								33
	3232-P22	32	32	170	40	32								33

↻ Applicable inserts B58-B65

## DTGNR/L



TN□□



90°

• R type insert (mm)

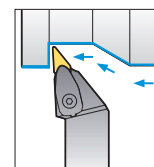
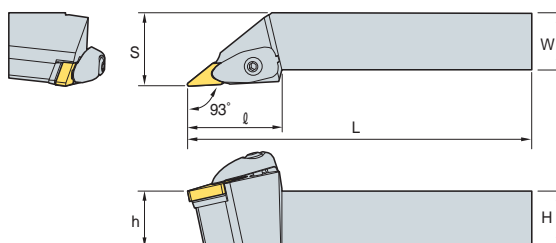
Designation	H	W	L	S	h	ℓ	Insert	Clamp	Clamp Screw	Shim	Shim Screw	Spring	Wrench	
DTGNR/L 2020-K16	20	20	125	25	20	24.5	TN□□1604□□							
	2525-M16	25	25	150	32	25								24.5
	3232-P16	32	32	170	40	32								24.5
DTGNR/L 2020-K16	2525-M22	25	25	150	32	25	TN□□2204□□							
	3225-P22	32	25	170	32	32								32.6
	3232-P22	32	32	170	40	32								32.6

↻ Applicable inserts B58-B65

## DVJNR/L



VN□□



93°

• R type insert (mm)

Designation	H	W	L	S	h	ℓ	Insert	Clamp	Clamp Screw	Shim	Shim Screw	Spring	Wrench	
DVJNR/L 2020-K16	20	20	125	25	20	41.5	VN□□1604□□							
	2525-M16	25	25	150	32	25								41.5
	3232-P16	32	32	170	40	32								41.5

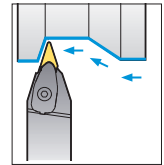
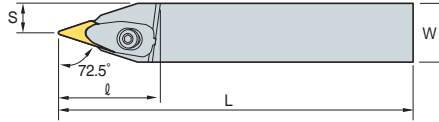
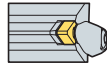
↻ Applicable inserts B66-B67



## DVVNN



VN□□



72.5°

• R type insert (mm)

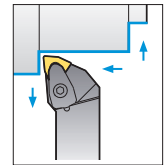
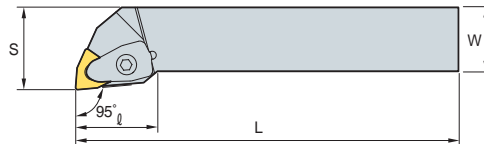
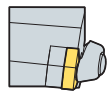
Designation		H	W	L	S	h	ℓ	Insert	Clamp	Clamp Screw	Shim	Shim Screw	Spring	Wrench
DVVNN	2020-K16	20	20	125	10	20	40	VN□□1604□□						
	2525-M16	25	25	150	12.5	25	40							
	3232-P16	32	32	170	16	32	40							

↻ Applicable inserts **B66~B67**

## DWLNR/L



WN□□



95°

• R type insert (mm)

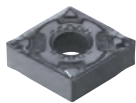
Designation		H	W	L	S	h	ℓ	Insert	Clamp	Clamp Screw	Shim	Shim Screw	Spring	Wrench
DWLNR/L	2020-K06	20	20	125	25	20	26	WN□□0604□□						
	2525-M06	25	25	150	32	25	26							
	2020-K08	20	20	125	25	20	32	WN□□0804□□						
	2525-M08	25	25	150	32	25	32							

↻ Applicable inserts **B68~B72**

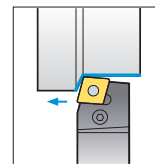
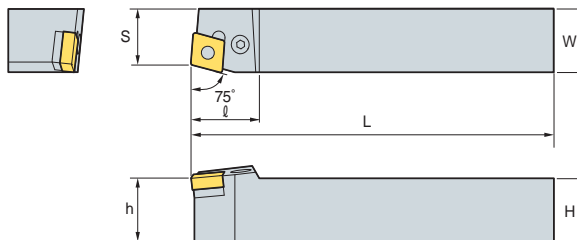


# B Lever Lock System

## PCBNR/L



CN□□



75°

• R type insert (mm)

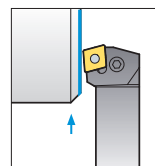
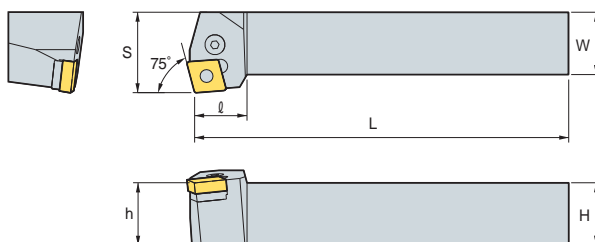
Designation	H	W	L	S	h	ℓ	Insert	Lever	Screw	Shim	Shim Pin	Wrench	Shim Pin Punch	
PCBNR/L	2020-K12	20	20	125	17	20	CN□□ 1204□□	LV4	VHX0821	SC42	SP4	HW30L	LSPS4	
	2525-M12	25	25	150	22	25								27
	3225-P12	32	25	170	22	32								27
	2525-M16	25	25	150	22	25	33	CN□□ 1606□□	LV5	VHX0825	SC53	SP5	HW30L	LSPS6
	3232-P16	32	32	170	27	32	33							
	3232-P19	32	32	170	27	32	36	CN□□ 1906□□	LV6N	VHX1027N	SC63N	SP6N	HW40L	LSPS6
	4040-S19	40	40	250	35	40	36	CN□□ 2509□□	LV8N	VHX1236N	SC84N	SP8N	HW50L	LSPS8
	4040-S25	40	40	250	35	40	47							
	4040-S25-5	40	40	250	35	40	47	CN□□ 2507□□	LV8N	VHX1236N	SC84N	SP8N	HW50L	LSPS8
5050-T25	50	50	300	43	50	47	CN□□ 2509□□							

➔ Applicable inserts B36-B42

## PCKNR/L



CN□□



95°

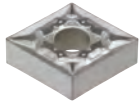
• R type insert (mm)

Designation	H	W	L	S	h	ℓ	Insert	Lever	Screw	Shim	Shim Pin	Wrench	Shim Pin Punch	
PCKNR/L	2020-K12	20	20	125	25	20	CN□□ 1204□□	LV4	VHX0821	SC42	SP4	HW30L	LSPS4	
	2525-M12	25	25	150	32	25								27
	3225-P12	32	25	170	40	32								30
	3232-P16	32	32	170	40	32	26	CN□□ 1606□□	LV5	VHX0825	SC53	SP5	HW30L	HW30L
	4040-S16	40	40	250	50	40	25							

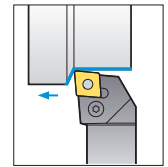
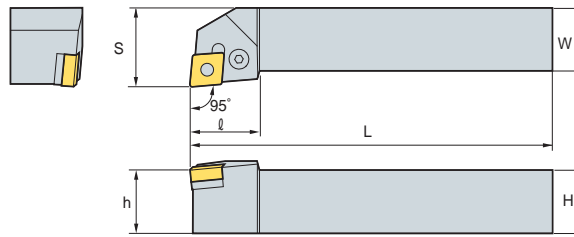
➔ Applicable inserts B36-B42



## PCLNR/L



CN□□



95°

• R type insert (mm)

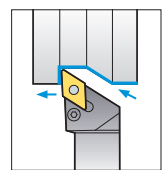
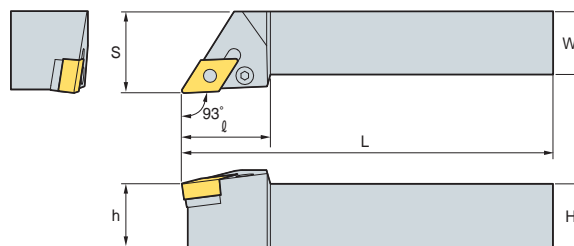
Designation	H	W	L	S	h	ℓ	Insert	Lever	Screw	Shim	Shim Pin	Wrench	Shim Pin Punch
<b>PCLNR/L</b> 1616-H09	16	16	100	20	16	20	CN□□ 0903□□	LV3	VHX0617	SC32	SP3	HW25L	LSPS3
2020-K09	20	20	125	25	20	22							
2525-M09	25	25	150	32	25	22							
1616-H12	16	16	100	20	16	28	CN□□ 1204□□	LV4	VHX0821	SC42	SP4	HW30L	LSPS4
2020-K12	20	20	125	25	20	28							
2525-M12	25	25	150	32	25	28							
3225-P12	32	25	170	32	32	28							
3232-P12	32	32	170	40	32	28	CN□□ 1606□□	LV5	VHX0825	SC53	SP5	HW30L	LSPS5
2525-M16	25	25	150	32	25	33							
3232-P16	32	32	170	40	32	33							
2525-M19	25	25	150	32	25	36	CN□□ 1906□□	LV6N	VHX1027N	SC63N	SP6N	HW40L	LSPS6
3225-P19	32	25	170	32	32	36							
3232-P19	32	32	170	40	32	36							
4040-P19	40	40	170	50	40	36							
4040-S19	40	40	250	50	40	36	CN□□ 2509□□	LV8N	VHX1236N	SC84N	SP8N	HW50L	LSPS8
4040-S25	40	40	250	50	40	47							
5050-T25	50	50	300	60	50	47							
4040-S25-5	40	40	250	50	40	47	CN□□ 2507□□	LV8N	VHX1236N	SC84N	SP8N	HW50L	LSPS8
5050-S25-5	50	50	300	60	50	47							

↻ Applicable inserts B36-B42

## PDJNR/L



DN□□



93°

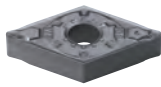
• R type insert (mm)

Designation	H	W	L	S	h	ℓ	Insert	Lever	Screw	Shim	Shim Pin	Wrench	Shim Pin Punch
<b>PDJNR/L</b> 1616-H11	16	16	100	20	16	25	DN□□ 1104□□	LV3	VHX0617	SD317	SP3	HW25L	LSPS3
2020-K11	20	20	125	25	20	25							
2525-M11	25	25	150	32	25	30							
2020-K15	20	20	125	25	20	35	DN□□ 1506□□	LV4B	VHX0821	SD42	SP4	HW30L	LSPS4
2525-M15	25	25	150	32	25	35							
3225-P15	32	25	170	32	32	35							
3232-P15	32	32	170	40	32	35							
2020-K15-3	20	20	125	25	20	35	DN□□ 1504□□	LV4	VHX0821	SD42	SP4	HW30L	LSPS4
2525-M15-3	25	25	150	32	25	35							
3232-P15-3	32	32	170	40	32	35							

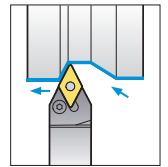
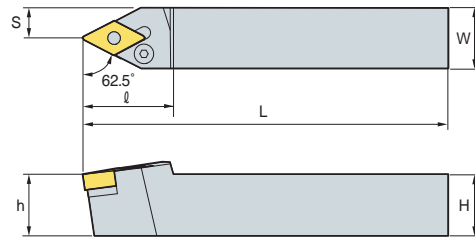
↻ Applicable inserts B43-B48

# B Lever Lock System

## PDNNR/L



DN□□



62.5°

• R type insert (mm)

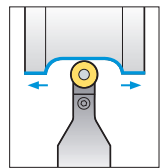
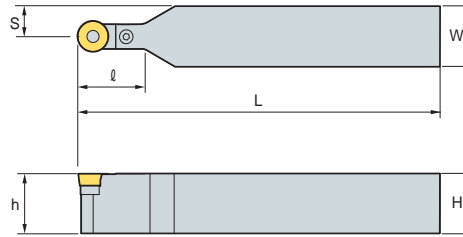
Designation	H	W	L	S	h	ℓ	Insert	Lever	Screw	Shim	Shim Pin	Wrench	Shim Pin Punch
PDNNR/L 2020-K15	20	20	125	8	20	37	DN□□ 1506□□						
2525-M15	25	25	150	12.5	25	37							
3232-P15	32	32	150	16	32	37							
4025-M15	40	25	170	12.5	32	37							
2525-M15-3	25	25	150	12.5	25	37	DN□□ 1504□□						
4025-M15-3	40	25	150	12.5	25	37							

↻ Applicable inserts B43-B48

## PRDCN



RCMX



(mm)

Designation	H	W	L	S	h	ℓ	Insert	Lever	Screw	Shim	Shim Pin	Wrench	Shim Pin Punch
PRDCN 2020-M10	20	20	150	10	20	24	RCMX1003M0						
2525-M10	25	25	150	12.5	25	24							
2525-M12	25	25	150	12.5	25	24							
2020-K12	20	20	125	10	20	24	RCMX1204M0						
3225-Q12	32	25	180	12.5	32	24							
2525-Q16	25	25	180	12.5	25	30	RCMX1606M0						
3225-Q16	32	25	180	12.5	32	30							
3232-Q16	32	32	180	16	32	35							
3232-Q20	32	32	180	16	32	40	RCMX2006M0						
4040-S25	40	40	250	20	40	42	RCMX2507M0						
4040-T25	40	40	300	20	40	42							
5050-U32	50	50	350	25	50	52	RCMX3209M0						

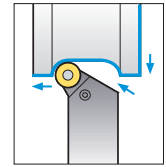
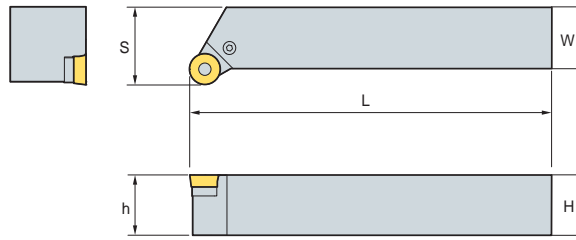
↻ Applicable inserts B83, B105



## PRGCR/L



RCMX

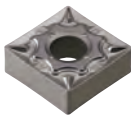


• R type insert  
(mm)

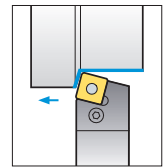
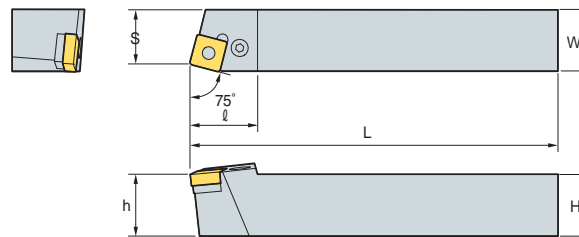
Designation	H	W	L	S	h	Insert	Lever	Screw	Shim	Shim Pin	Wrench	Shim Pin Punch
PRGCR/L 2020-K10	20	20	125	25	20	RCMX1003M0	LR10	VHX0514	SR10	SP3	HW20L	LSPS3
	25	25	150	32	25							
2020-K12	20	20	125	25	20	RCMX1204M0	LR12	VHX0617	SR12	SP3	HW25L	LSPS3
	25	25	150	32	25							
3225-P12	32	25	170	32	32	RCMX1606M0	LR16	VHX0621	SR16	SP4	HW25L	LSPS4
2525-M16	25	25	150	32	25							
3225-P16	32	25	170	32	32	RCMX2006M0	LR20	VHX0823	SR20	SP5-1	HW30L	LSPS5
3232-P20	32	32	170	40	32							
4040-S25	40	40	250	50	40	RCMX2507M0	LR25	VHX1030	SR25	SP6N	HW40L	LSPS6

➔ Applicable inserts B83, B105

## PSBNR/L



SN□□



75°

• R type insert  
(mm)

Designation	H	W	L	S	h	ℓ	Insert	Lever	Screw	Shim	Shim Pin	Wrench	Shim Pin Punch
PSBNR/L 1616-H09	16	16	100	13	16	21	SN□□0903□□	LV3	VHX0617	SS32	SP3	HW25L	LSPS3
	20	20	125	17	20	23							
2020-K12	20	20	125	17	20	28	SN□□1204□□	LV4	VHX0821	SS42	SP4	HW30L	LSPS4
2525-M12	25	25	150	22	25	28							
3225-P12	32	25	170	22	32	28							
3232-P12	32	32	170	27	32	28							
2525-M15	25	25	150	22	25	35	SN□□1506□□	LV5	VHX0825	SS53	SP5	HW30L	LSPS5
3232-P15	32	32	170	27	32	35							
3232-P19	32	32	170	27	32	40	SN□□1906□□	LV6N	VHX1027N	SS63N	SP6N	HW40L	LSPS6
4040-S19	40	40	250	35	40	40							
4040-S25	40	40	250	35	40	50	SN□□2507□□	LV8N	VHX1236N	SS84N	SP8N	HW50L	LSPS8
4040-S25-6	40	40	250	35	40	50							
5050-T25	50	50	300	43	50	50	SN□□2507□□						
5050-T25-6	50	50	300	43	50	46	SN□□2509□□						

➔ Applicable inserts B50-B57

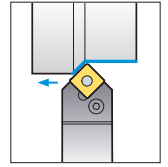
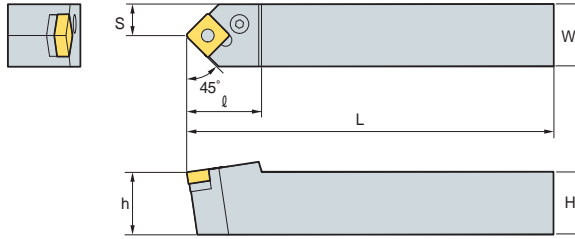


# B Lever Lock System

## PSDNN



SN□□



45°

(mm)

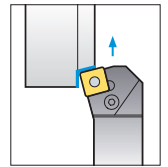
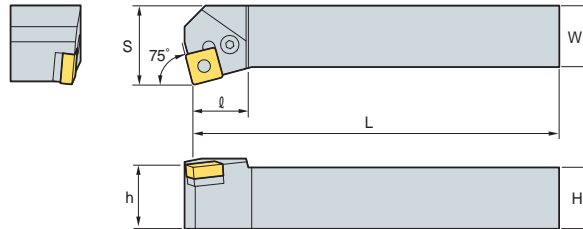
Designation	H	W	L	S	h	ℓ	Insert	Lever	Screw	Shim	Shim Pin	Wrench	Shim Pin Punch
<b>PSDNN 1616-H09</b>	16	16	100	8	16	23	SN□□0903□□	LV3	VHX0617	SS32	SP3	HW25L	LSPS3
<b>2020-K12</b>	20	20	125	10	20	30	SN□□1204□□	LV4	VHX0821	SS42	SP4	HW30L	LSPS4
<b>2525-M12</b>	25	25	150	12.5	25	30							
<b>3225-P12</b>	32	25	170	12.5	32	30							
<b>3232-P12</b>	32	32	170	16	32	40							
<b>2525-M15</b>	25	25	150	12.5	25	40	SN□□1506□□	LV5	VHX0825	SS53	SP5	HW30L	LSPS5
<b>3232-P15</b>	32	32	170	16	32	40	SN□□1906□□	LV6N	VHX1027N	SS63N	SP6N	HW40L	LSPS6
<b>3225-P19</b>	32	25	170	12.5	32	40							
<b>3232-P19</b>	32	32	170	16	32	40							
<b>4040-S19</b>	40	40	250	20	40	40							
<b>4040-S25</b>	40	40	250	20	40	50	SN□□2507□□	LV8N	VHX1236N	SS84N	SP8N	HW50L	LSPS8
<b>5050-T25</b>	50	50	300	25	50	50	SN□□2509□□	LV8N	VHX1236N	SS84N	SP8N	HW50L	LSPS8
<b>4040-S25-6</b>	40	40	250	20	40	50							
<b>5050-T25-6</b>	50	50	300	25	50	50							

↻ Applicable inserts B50-B57

## PSKNR/L



SN□□



75°

• R type insert  
(mm)

Designation	H	W	L	S	h	ℓ	Insert	Lever	Screw	Shim	Shim Pin	Wrench	Shim Pin Punch
<b>PSKNR/L 1616-H09</b>	16	16	100	20	16	17	SN□□0903□□	LV3	VHX0617	SS32	SP3	HW25L	LSPS3
<b>2020-K09</b>	20	20	125	25	20	20	SN□□1204□□	LV4	VHX0821	SS42	SP4	HW30L	LSPS4
<b>2020-K12</b>	20	20	125	25	20	23							
<b>2525-M12</b>	25	25	150	32	25	23							
<b>3232-P12</b>	32	32	170	40	32	23							
<b>2525-M15</b>	25	25	150	32	25	28	SN□□1506□□	LV5	VHX0825	SS53	SP5	HW30L	LSPS5
<b>3232-P15</b>	32	32	170	40	32	28	SN□□1906□□	LV6N	VHX1027N	SS63N	SP6N	HW40L	LSPS6
<b>3232-P19</b>	32	32	170	40	32	41.5							
<b>4040-S19</b>	40	40	250	50	40	41.5							
<b>4040-S25</b>	40	40	250	50	40	46							
<b>4040-S25-6</b>	40	40	250	50	40	46	SN□□2509□□	LV8N	VHX1236N	SS84N	SP8N	HW50L	LSPS8
<b>5050-T25-6</b>	50	50	300	60	50	37.5	SN□□2509□□						

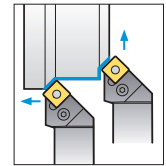
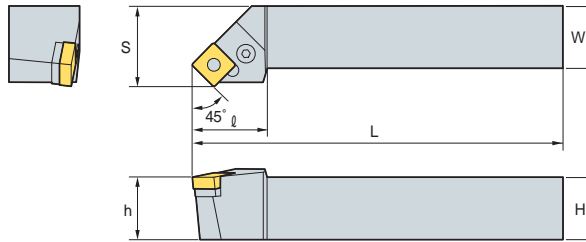
↻ Applicable inserts B50-B57



## PSSNR/L



SN□□



45°

• R type insert (mm)

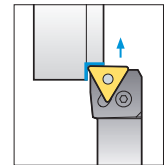
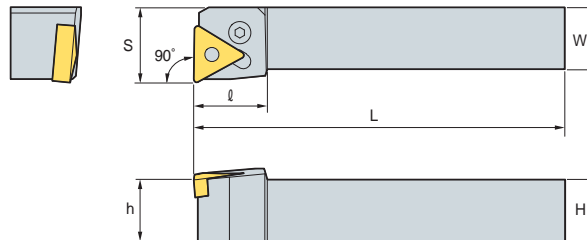
Designation	H	W	L	S	h	ℓ	Insert	Lever	Screw	Shim	Shim Pin	Wrench	Shim Pin Punch	
PSSNR/L	1616-H09	16	16	100	20	16	25	SN□□0903□□	LV3	VHX0617	SS32	SP3	HW25L	LSPS3
	2020-K12	20	20	125	25	20	30	SN□□1204□□	LV4	VHX0821	SS42	SP4	HW30L	LSPS4
	2525-M12	25	25	150	32	25	36							
	3225-P12	32	25	170	32	32	36							
	3232-P12	32	32	170	40	32	40							
	2525-M15	25	25	150	32	25	36	SN□□1506□□	LV5	VHX0825	SS53	SP5	HW30L	LSPS5
	3232-P15	32	32	170	40	32	45	SN□□1906□□	LV6N	VHX1027N	SS63N	SP6N	HW40L	LSPS6
	3232-P19	32	32	170	40	32	41.5							
	4040-R19	40	40	200	50	40	41.5							
	4040-S19	40	40	250	50	40	41.5							
4040-S25	40	40	250	50	40	48	SN□□2507□□	LV8N	VHX1236N	SS84N	SP8N	HW50L	LSPS8	
4040-S25-6	40	40	250	50	40	48	SN□□2509□□							

➔ Applicable inserts B50-B57

## PTFNR/L



TN□□



90°

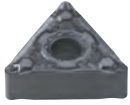
• R type insert (mm)

Designation	H	W	L	S	h	ℓ	Insert	Lever	Screw	Shim	Shim Pin	Wrench	Shim Pin Punch	
PTFNR/L	1616-H16	16	16	100	20	16	20	TN□□1604□□	LV3	VHX0617	ST317	SP3	HW25L	LSPS3
	2020-K16	20	20	125	25	20	20							
	2525-M16	25	25	150	32	25	20							
	2525-M22	25	25	150	32	25	25	TN□□2204□□	LV4	VHX0821	ST42	SP4	HW30L	LSPS4
	3232-P22	32	32	170	40	32	25	TN□□2706□□	LV5	VHX0825	ST53	SP5	HW30L	LSPS5
	3232-P27	32	32	170	40	32	34							
	4040-S27	40	40	250	50	40	34							

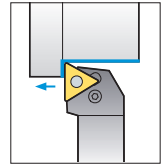
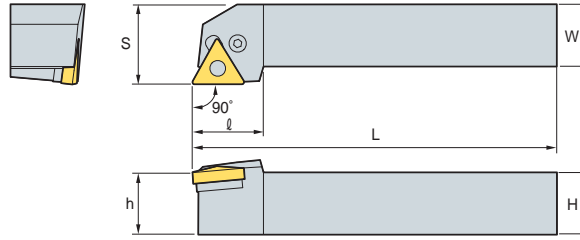
➔ Applicable inserts B58-B65

# B Lever Lock System

## PTGNR/L



TN□□



90°

• R type insert (mm)

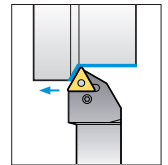
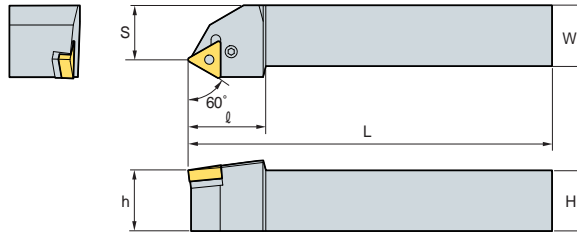
Designation	H	W	L	S	h	l	Insert	Lever	Screw	Shim	Shim Pin	Wrench	Shim Pin Punch
PTGNR/L 1212-F11	12	12	80	16	12	16	TN□□1103□□	LV2	VHX0509B	-	-	HW20L	-
1616-H11	16	16	100	20	16	18							
2020-K11	20	20	125	25	20	19							
2525-M11	25	25	150	32	25	20							
1616-H16	16	16	100	20	16	20	TN□□1604□□	LV3	VHX0617	ST317	SP3	HW25L	LSPS3
2020-K16	20	20	125	25	20	20							
2525-M16	25	25	150	32	25	20							
3232-P16	32	32	170	40	32	20							
2525-M22	25	25	150	32	25	28	TN□□2204□□	LV4	VHX0821	ST42	SP4	HW30L	LSPS4
3232-P22	32	32	170	40	32	28							
3232-P27	32	32	170	40	32	33	TN□□2706□□	LV5	VHX0825	ST53	SP5	HW30L	LSPS5
4040-S27	40	40	250	50	40	33							

↻ Applicable inserts B58-B65

## PTTNR/L



TN□□



60°

• R type insert (mm)

Designation	H	W	L	S	h	l	Insert	Lever	Screw	Shim	Shim Pin	Wrench	Shim Pin Punch
PTTNR/L 1616-H16	16	16	100	13	16	25	TN□□1604□□	LV3	VHX0617	ST317	SP3	HW25L	LSPS3
2020-K16	20	20	125	17	20	25							
2525-M16	25	25	150	22	25	32							
2525-M22	25	25	150	22	25	32	TN□□2204□□	LV4	VHX0821	ST42	SP4	HW30L	LSPS4

↻ Applicable inserts B58-B65

## PWLNR/L



WN□□

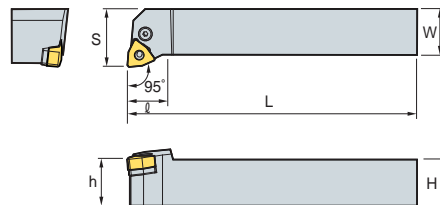


Fig. 1

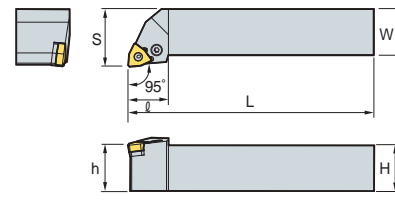
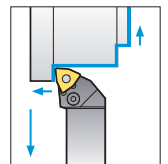


Fig. 2



95°

• R type insert (mm)

Designation	H	W	L	S	h	l	Insert	Lever	Screw	Shim	Shim Pin	Wrench	Shim Pin Punch	Fig.
PWLNR/L 1616-H06	16	16	100	20	16	20	WN□□0604□□	LV3	VHX0617	SW317	SP3	HW25L	LSPS3	1
2020-K06	20	20	125	25	20	20								
2525-M06	25	25	150	32	25	20								
2020-K08	20	20	125	25	20	26	WN□□0804□□	LV4	VHX0821	SW42	SP4	HW30L	LSPS4	2
2525-M08	25	25	150	32	25	26								

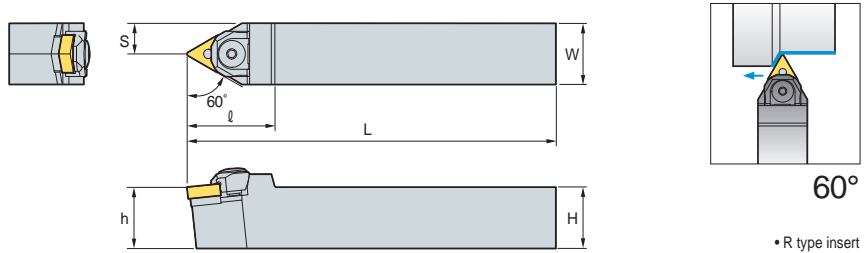
↻ Applicable inserts B68-B72



## WTENN



TN□□



• R type insert (mm)

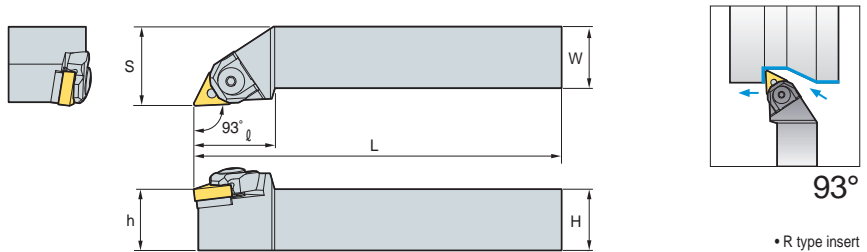
Designation	H	W	L	S	h	ℓ	Insert	Wedge Clamp	Screw	Stopper Ring	Shim	Shim Pin	Nut	Wrench
WTENN 2020-K16	20	20	125	10	20	36	TN□□1604□□							
	25	25	150	12.5	25	36								
	25	25	150	12.5	25	42								
3232-P22	32	32	170	16	32	42	TN□□2204□□							

↻ Applicable inserts B58-B65

## WTJNR/L



TN□□



• R type insert (mm)

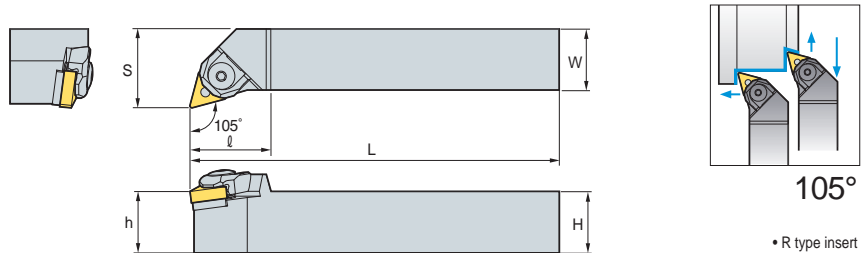
Designation	H	W	L	S	h	ℓ	Insert	Wedge Clamp	Screw	Stopper Ring	Shim	Shim Pin	Nut	Wrench
WTJNR/L 2020-K16	20	20	125	25	20	33	TN□□1604□□							
	25	25	150	32	25	33								
	32	32	170	40	32	33								
2525-M22	25	25	150	32	25	35	TN□□2204□□							
3232-P22	32	32	170	40	32	35								

↻ Applicable inserts B58-B65

## WTXNR/L



TN□□



• R type insert (mm)

Designation	H	W	L	S	h	ℓ	Insert	Wedge Clamp	Screw	Stopper Ring	Shim	Shim Pin	Nut	Wrench
WTXNR/L 2020-K16	20	20	125	25	20	30	TN□□1604□□							
	25	25	150	32	25	33								
	32	32	170	40	32	33								

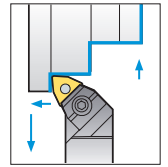
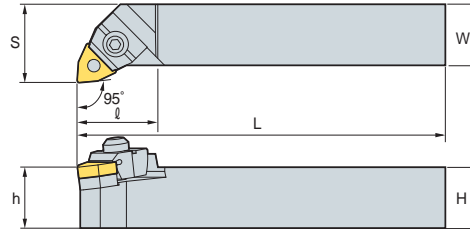
↻ Applicable inserts B58-B65

# B Wedge Clamp System

## WWLNR/L



WN□□



95°

• R type insert (mm)

Designation	H	W	L	S	h	ℓ	Insert	Wedge Clamp	Screw	Stopper Ring	Shim	Shim Pin	Nut	Wrench	
WWLNR/L	2020-K08	20	20	125	25	20	32	WN□□0804□□	CMH6R/L3				SP2M		
	2525-M08	25	25	150	32	25	33		CMH6R2	MHX0630	CR05	SW43M	SP4M	N0508	HW30L
	3232-P08	32	32	170	40	32	33		CMH6R2						HW40L

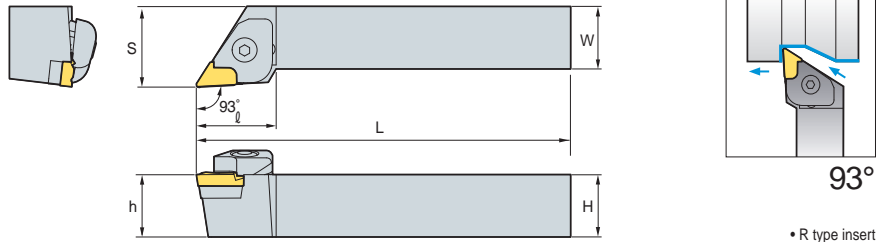
↻ Applicable inserts B68-B72



## CKJNR/L



KN□□



• R type insert (mm)

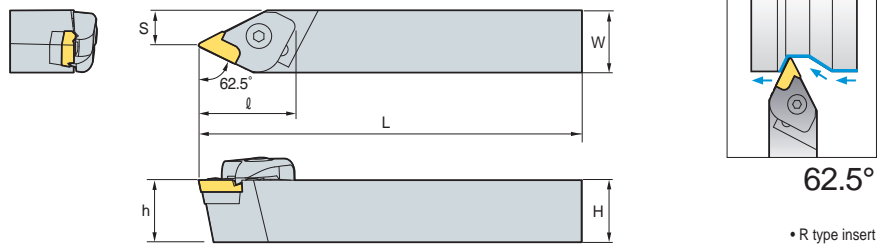
Designation		H	W	L	S	h	ℓ	Insert	Clamp	Clamp Screw	Spring	Shim	Pin + Spring	Shim Screw	Wrench
CKJNR	2020-K16	20	20	125	25	20	32	KN□□1604□□R							
	2525-M16	25	25	150	32	25	32								
	3225-M16	32	25	150	32	32	32								
	3225-P16	32	25	170	32	32	32								
	3232-P16	32	32	170	40	32	32								
4040-R16	40	40	200	50	40	32	CTH6R1	CHX0625	SR3	SK33C	PN0515 SR4	SHX0310	HW20L HW40L		
CKJNL	2020-K16	20	20	125	25	20	32	KN□□1604□□L							
	2525-M16	25	25	150	32	25	32								
	3232-P16	32	32	170	40	32	32								
	4040-R16	40	40	200	50	40	32								

➔ Applicable inserts B49

## CKNNR/L



KN□□

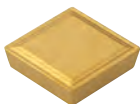


• R type insert (mm)

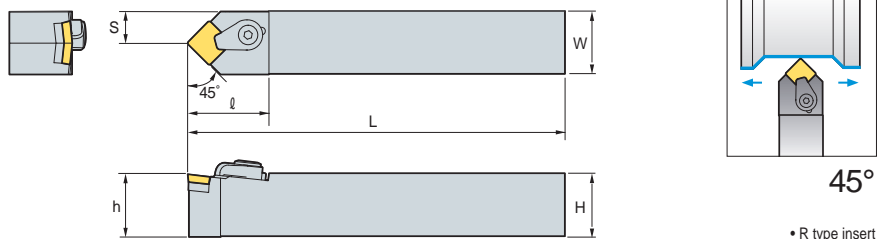
Designation		H	W	L	S	h	ℓ	Insert	Clamp	Clamp Screw	Spring	Shim	Pin + Spring	Shim Screw	Wrench
CKNNR	2525-M16	25	25	150	14.3	25	37	KN□□ 1604□□R							
	3232-P16	32	32	170	16.8	32	37								
CKNNL	2525-M16	25	25	150	14.3	25	37	KN□□ 1604□□L							
	3232-P16	32	32	170	16.8	32	37								

➔ Applicable inserts B49

## CSDPN



SP□R



• R type insert (mm)

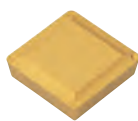
Designation		H	W	L	S	h	ℓ	Insert	Clamp	Clamp Screw	Shim	Shim Pin	C-Ring	Wrench
CSDPN	1616-H09	16	16	100	8	16	30	SP□R 0903□□	CH53R1	CH0515C	SS32C	SP3C	CR03C	HW25L
	2525-M12	25	25	150	12.5	25	35	SP□R 1203□□	CH6R5	CHX0622C	SS42C	SP3C	CR04C	HW30L

➔ Applicable inserts B85~B86

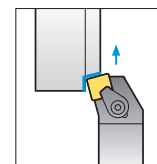
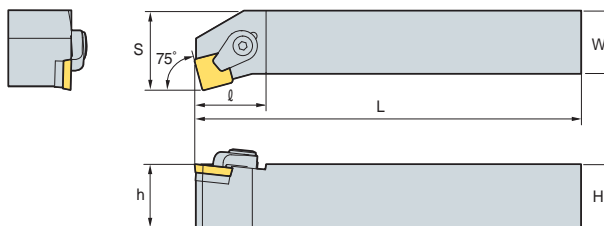


# B Clamp on System

## CSKPR/L



SP□R



75°

• R type insert (mm)

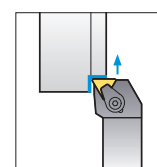
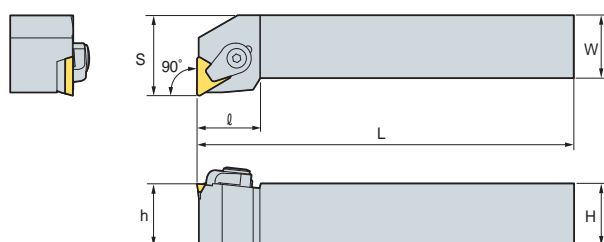
Designation	H	W	L	S	h	ℓ	Insert	Clamp	Clamp Screw	Shim	Shim Pin	C-Ring	Wrench
CSKPR/L 2525-M12	25	25	150	32	20	32	SP□R 1203□□						

➔ Applicable inserts B85-B86

## CTFPR/L



TP□R



90°

• R type insert (mm)

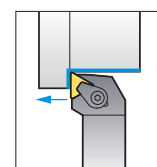
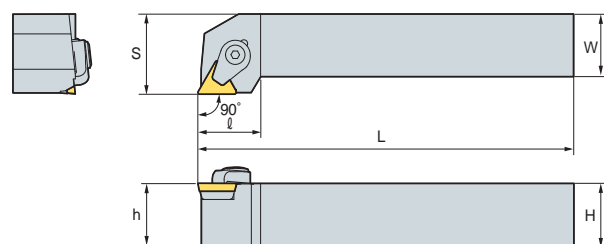
Designation	H	W	L	S	h	ℓ	Insert	Clamp	Clamp Screw	Shim	Shim Pin	C-Ring	Wrench
CTFPR/L 2020-K16	25	25	125	25	20	32	TP□R 1603□□						
2525-M16	25	25	150	32	25	CH6R5 CHX0622C ST32C SP3C CR04C HW30L							

➔ Applicable inserts B90-B93

## CTGPR/L



TP□R



90°

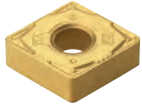
• R type insert (mm)

Designation	H	W	L	S	h	ℓ	Insert	Clamp	Clamp Screw	Shim	Shim Pin	C-Ring	Wrench
CTGPR/L 1212-F11	12	12	80	16	12	20	TP□R 1103□□						
1616-H11	16	16	100	20	16	20							
2020-K11	20	20	125	25	20	20	TP□R 1603□□						
2525-M16	25	25	150	32	25	25							
2525-M22	25	25	150	32	25	32	TP□R 2204□□						
3232-P22	32	32	170	40	32	32							

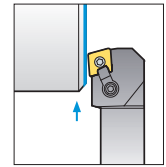
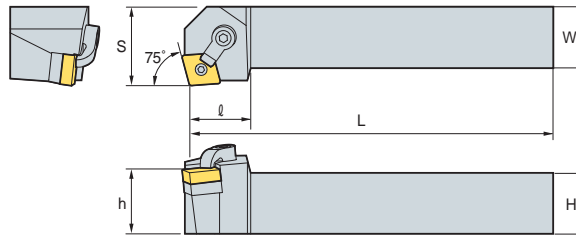
➔ Applicable inserts B90-B93



# MCKNR/L



CN□□



75°

• R type insert  
(mm)

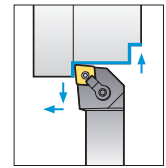
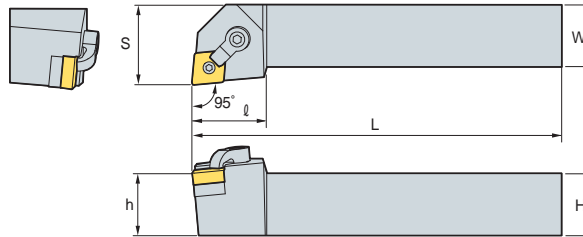
Designation	H	W	L	S	h	l	Insert	Clamp	Clamp Screw	Shim	Shim Pin	Wrench					
MCKNR/L 2020-K12	20	20	125	25	20	32	CN□□1204□□										
2525-M12	25	25	150	32	25	32							CDH6N	DHA1/4-25	SC43D	SP4D	HW31.8L HW23.8L
3232-P12	32	32	170	40	32	32											

➔ Applicable inserts B36~B42

# MCLNR/L



CN□□



95°

• R type insert  
(mm)

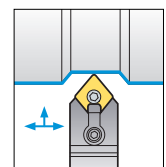
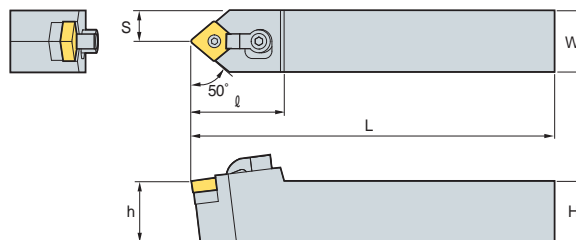
Designation	H	W	L	S	h	l	Insert	Clamp	Clamp Screw	Shim	Shim Pin	Wrench					
MCLNR/L 1616-H09	16	16	100	20	16	25	CN□□0903□□										
2020-K09	20	20	125	25	20	25							CDH7N	DHA10-32-19	SC32D	SP3DS	HW23.8L HW19.8L
2525-M09	25	25	150	32	25	25											
2020-K12	20	20	125	25	20	32	CN□□1204□□										
2525-M12	25	25	150	32	25	32							CDH6N	DHA1/4-25	SC43D	SP4D	HW31.8L HW23.8L
3225-P12	32	25	170	32	32	32											
3232-P12	32	32	170	40	32	32	CN□□1606□□										
2525-M16	25	25	150	32	25	33							CDH8N	DHA5/16-32	SC53D	SP5D	HW39.7L HW31.8L
3232-P16	32	32	170	40	32	33											
4040-S16	40	40	250	50	40	33	CN□□1906□□										
2525-M19	25	25	150	32	25	38							CDH8N	DHA5/16-32	SC63D	SP6D	HW39.7L HW35.7L
3232-P19	32	32	170	40	32	38											
4040-S19	40	40	250	50	40	38	CN□□2507□□										
4040-S25	40	40	250	50	40	38							CDH8N3	DHA3/8-35	SC84D	SP8D	HW39.7L HW47.6L

➔ Applicable inserts B36~B42

# MCMNN



CN□□



50°

• R type insert  
(mm)

Designation	H	W	L	S	h	l	Insert	Clamp	Clamp Screw	Shim	Shim Pin	Wrench					
MCMNN 2020-K12	20	20	125	10	20	32	CN□□1204□□										
2525-M12	25	25	150	12.5	25	32							CDH6N	DHA1/4-25	SC43D	SP4D	HW31.8L HW23.8L
3232-P12	32	32	170	16	32	32											
2525-M16	25	25	150	12.5	25	40	CN□□1606□□										
3232-P16	32	32	170	16	32	40							CDH8N	DHA5/16-32	SC53D	SP5D	HW39.7L HW31.8L
3232-P19	32	32	170	16	32	40											
4040-S19	40	40	250	20	40	32	CN□□1906□□										

➔ Applicable inserts B36~B42

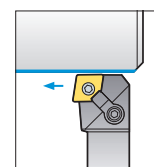
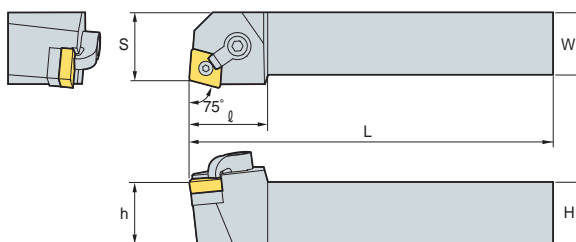


# B Multi Lock System

## MCRNR/L



CN□□



75°

• R type insert (mm)

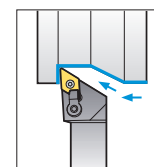
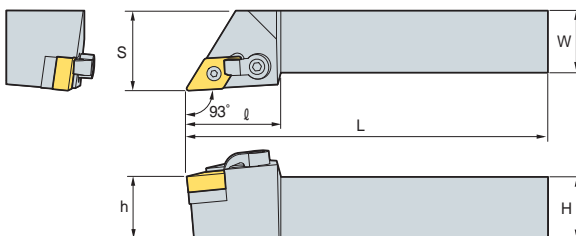
Designation	H	W	L	S	h	ℓ	Insert	Clamp	Clamp Screw	Shim	Shim Pin	Wrench						
MCRNR/L 2020-K12	20	20	125	22	20	32	CN□□1204□□											
	2525-M12	25	25	150	27	25							32	CDH8N1	DHA5/16-32	SC43D	SP4D	HW39.7L HW23.8L
	2525-M16	25	25	150	27	25							33	CDH8N1	DHA5/16-32	SC53D	SP5D	HW39.7L HW31.8L
3232-P16	32	32	170	35	32	33	CN□□1606□□											
3232-P19	32	32	170	35	32	38							CDH8N1	DHA5/16-32	SC63D	SP6D	HW39.7L HW35.7L	
4040-S19	40	40	250	43	40	38	CN□□1906□□											

➔ Applicable inserts B36-B42

## MDJNR/L



DN□□



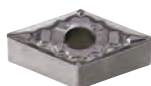
93°

• R type insert (mm)

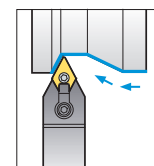
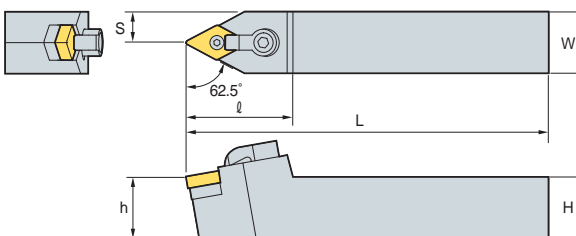
Designation	H	W	L	S	h	ℓ	Insert	Clamp	Clamp Screw	Shim	Shim Pin	Wrench					
MDJNR/L 2020-K11	20	20	125	25	20	32	DN□□1104□□										
	2525-M11	25	25	150	32	25							32	CDH6N	DHA1/4-19	SD32D	SP3D
2020-K15-3	20	20	125	25	20	36	DN□□1504□□										
	2525-M15-3	25	25	150	32	25							36	CDH6N	DHA1/4-25	SD43D	SP4D
3232-P15-3	32	32	170	40	32	36	DN□□1506□□										
2020-K15	20	20	125	25	20	36							CDH6N	DHA1/4-25	SD43D	SP4DL	HW31.8L HW23.8L
2525-M15	25	25	150	32	25	36							CDH6N	DHA1/4-25	SD43D	SP4DL	HW31.8L HW23.8L
3232-P15	32	32	170	40	32	36											

➔ Applicable inserts B43-B48

## MDNNN



DN□□



62.5°

(mm)

Designation	H	W	L	S	h	ℓ	Insert	Clamp	Clamp Screw	Shim	Shim Pin	Wrench
MDNNN 2525-M15-3	25	25	150	12.5	25	41	DN□□1504□□					
	2525-M15	25	25	150	12.5	25						
2525-M15	25	25	150	12.5	25	41	DN□□1506□□					

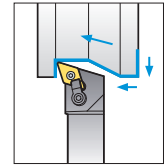
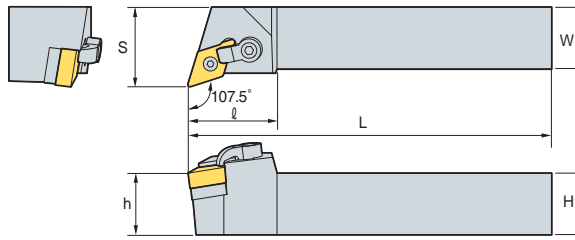
➔ Applicable inserts B43-B48



# MDQNR/L



DN□□



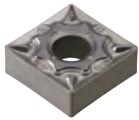
107.5°

• R type insert (mm)

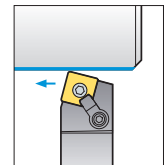
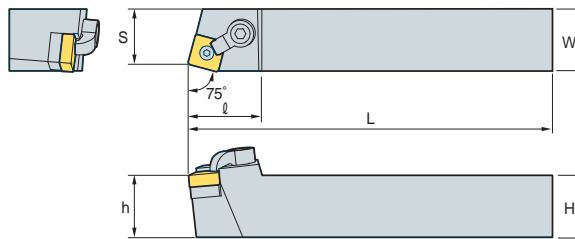
Designation	H	W	L	S	h	ℓ	Insert	Clamp	Clamp Screw	Shim	Shim Pin	Wrench
MDQNR/L 2525-M15-3	25	25	150	32	25	36	DN□□1504□□	CDH6N	DHA1/4-25	SD43D	SP4D	HW31.8L HW23.8L
	32	32	170	40	32	36						
2525-M15	25	25	150	32	25	36	DN□□1506□□	CDH6N	DHA1/4-25	SD43D	SP4DL	HW31.8L HW23.8L
	32	32	170	40	32	36						

➔ Applicable inserts B43-B48

# MSBNR/L



SN□□



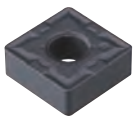
75°

• R type insert (mm)

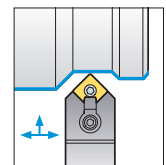
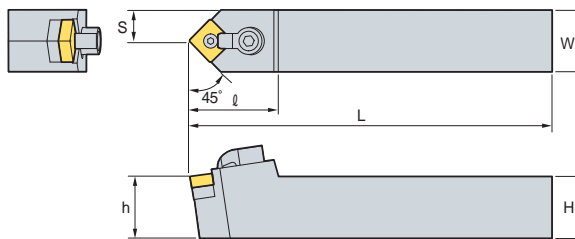
Designation	H	W	L	S	h	ℓ	Insert	Clamp	Clamp Screw	Shim	Shim Pin	Wrench
MSBNR/L 2020-K12	20	20	125	17	20	32	SN□□1204□□	CDH8N1	DHA5/16-32	SS43D	SP4D	HW39.7L HW23.8L
2525-M12	25	25	150	22	25	32						
2525-M15	25	25	150	22	25	35	SN□□1506□□	CDH8N	DHA5/16-32	SS53D	SP5D	HW39.7L HW31.8L
3232-P15	32	32	170	22	32	35						
3232-P19	32	32	170	27	32	40	SN□□1906□□	CDH8N	DHA5/16-32	SS63D	SP6D	HW39.7L HW35.7L
4040-S19	40	40	250	35	40	40						

➔ Applicable inserts B50-B57

# MSDNN



SN□□



45°

(mm)

Designation	H	W	L	S	h	ℓ	Insert	Clamp	Clamp Screw	Shim	Shim Pin	Wrench
MSDNN 1616-H09	16	16	100	8	16	28	SN□□0903□□	CDH7N	DHA10-32-19	SS32D	SP3DS	HW19.8L HW23.8L
2020-K09	20	20	125	10	20	28						
2020-K12	20	20	125	10	20	32	SN□□1204□□	CDH8N1	DHA5/16-32	SS43D	SP4D	HW39.7L HW23.8L
2525-M12	25	25	150	12.5	25	32						
3225-P12	32	25	170	12.5	32	32	SN□□1506□□	CDH8N	DHA5/16-32	SS53D	SP5D	HW39.7L HW31.8L
2525-M15	25	25	150	12.5	25	35						
3225-P15	32	25	170	12.5	32	35	SN□□1906□□	CDH8N	DHA5/16-32	SS63D	SP6D	HW39.7L HW35.7L
3232-P15	32	32	170	16	32	35						
4040-S15	40	40	250	20	40	35	SN□□1906□□	CDH8N	DHA5/16-32	SS63D	SP6D	HW39.7L HW35.7L
3232-P19	32	32	170	16	32	42						
4040-S19	40	40	250	20	40	42						

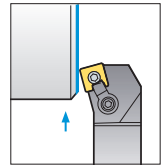
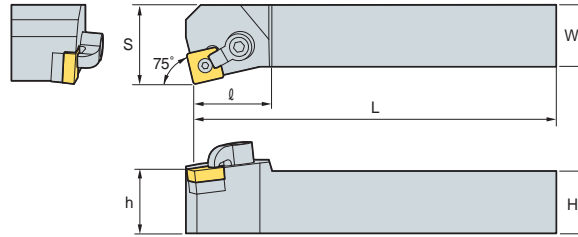
➔ Applicable inserts B50-B57

# B Multi Lock System

## MSKNR/L



SN□□



75°

• R type insert (mm)

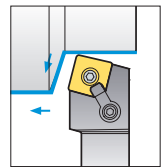
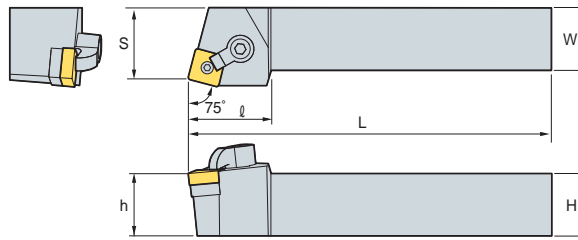
Designation	H	W	L	S	h	l	Insert	Clamp	Clamp Screw	Shim	Shim Pin	Wrench
<b>MSKNR/L 1616-H09</b>	16	16	100	20	16	28	SN□□0903□□	CDH7N	DHA10-32-19	SS32D	SP3DS	HW19.8L HW23.8L
<b>2020-K09</b>	20	20	125	22	20	28						
<b>2020-K12</b>	20	20	125	25	20	32						
<b>2525-M12</b>	25	25	150	32	25	32	SN□□1204□□	CDH8N1	DHA5/16-32	SS43D	SP4D	HW39.7L HW23.8L
<b>3225-P12</b>	32	25	170	32	32	32						
<b>2525-M15</b>	25	25	150	32	25	35	SN□□1506□□	CDH8N	DHA5/16-32	SS53D	SP5D	HW39.7L HW31.8L
<b>3232-P15</b>	32	32	170	40	32	35						
<b>3232-P19</b>	32	32	170	40	32	40	SN□□1906□□	CDH8N	DHA5/16-32	SS63D	SP6D	HW39.7L HW35.7L
<b>4040-S19</b>	40	40	250	50	40	40						
<b>4040-S25</b>	40	40	250	50	40	40	SN□□2507□□	CDH8N3	DHA3/8-35	SS84D	SP8D	HW47.6L HW39.7L

↻ Applicable inserts B50-B57

## MSRNR/L



SN□□



75°

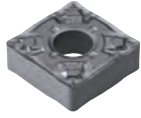
• R type insert (mm)

Designation	H	W	L	S	h	l	Insert	Clamp	Clamp Screw	Shim	Shim Pin	Wrench
<b>MSRNR/L 1616-H09</b>	16	16	100	17	16	28	SN□□0903□□	CDH7N	DHA10-32-19	SS32D	SP3DS	HW19.8L HW23.8L
<b>2020-K09</b>	20	20	125	22	20	28						
<b>2020-K12</b>	20	20	125	22	20	32						
<b>2525-M12</b>	25	25	150	27	25	32	SN□□1204□□	CDH8N1	DHA5/16-32	SS43D	SP4D	HW39.7L HW23.8L
<b>2525-M15</b>	25	25	150	27	25	35						
<b>3232-P15</b>	32	32	170	35	32	35	SN□□1506□□	CDH8N	DHA5/16-32	SS53D	SP5D	HW39.7L HW31.8L
<b>3225-P19</b>	32	25	170	27	32	40						
<b>3232-P19</b>	32	32	170	35	32	40	SN□□1906□□	CDH8N	DHA5/16-32	SS63D	SP6D	HW39.7L HW35.7L
<b>4040-S19</b>	40	40	250	43	40	40						
<b>4040-S25</b>	40	40	250	43	40	40	SN□□2507□□	CDH8N3	DHA3/8-35	SS84D	SP8D	HW47.6L HW39.7L

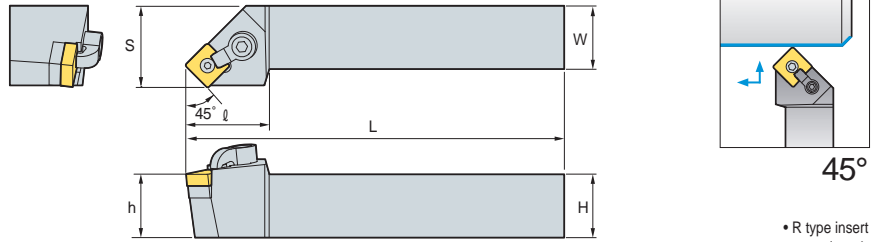
↻ Applicable inserts B50-B57



# MSSNR/L



SN□□



45°  
• R type insert (mm)

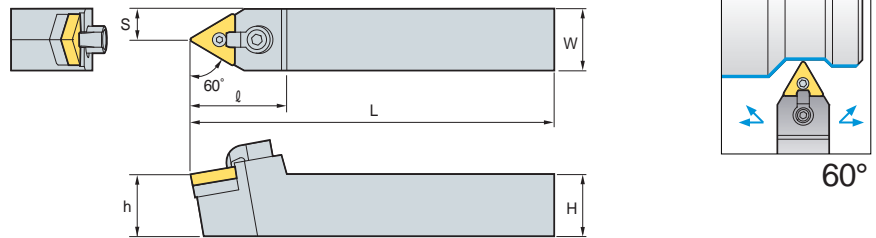
Designation	H	W	L	S	h	l	Insert	Clamp	Clamp Screw	Shim	Shim Pin	Wrench
MSSNR/L 1616-H09	16	16	100	20	16	28	SN□□0903□□	CDH7N	DHA10-32-19	SS32D	SP3DS	HW19.8L HW23.8L
	20	20	125	25	20	28						
2020-K12	20	20	125	25	20	32	SN□□1204□□	CDH8N1	DHA5/16-32	SS43D	SP4D	HW39.7L HW23.8L
2525-M12	25	25	150	32	25	32						
2525-M15	25	25	150	32	25	35	SN□□1506□□	CDH8N1	DHA5/16-32	SS53D	SP5D	HW39.7L HW31.8L
3232-P15	32	32	170	40	32	35						
3232-P19	32	32	170	40	32	40	SN□□1906□□	CDH8N1	DHA5/16-32	SS63D	SP6D	HW39.7L HW35.7L
4040-S19	40	40	250	50	40	40						

↻ Applicable inserts B50-B57

# MTENN



TN□□



60°  
(mm)

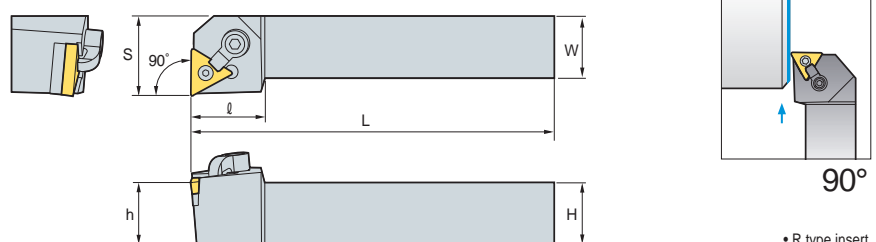
Designation	H	W	L	S	h	l	Insert	Clamp	Clamp Screw	Shim	Shim Pin	Wrench
MTENN 2020-K16	20	20	125	10	20	32	TN□□1604□□	CDH7N	DHA10-32-19	ST32D	SP3D	HW23.8L HW19.8L
	25	25	150	12.5	25	32						
2525-M22	25	25	150	12.5	25	35	TN□□2204□□	CDH8N1	DHA5/16-32	ST43D	SP4D	HW39.7L HW23.8L
3232-P27	32	32	170	16	32	35	TN□□2706□□	CDH8N1	DHA5/16-32	ST53D	SP5D	HW39.7L HW31.8L
4040-S33	40	40	250	20	40	40	TN□□3307□□	CDH8N	DHA5/16-32	ST63D	SP6DL	HW39.7L HW35.7L

↻ Applicable inserts B58-B65

# MTFNR/L



TN□□



90°  
• R type insert (mm)

Designation	H	W	L	S	h	l	Insert	Clamp	Clamp Screw	Shim	Shim Pin	Wrench
MTFNR/L 1616-H16	16	16	100	20	16	32	TN□□1604□□	CDH7N	DHA10-32-19	ST32D	SP3D	HW23.8L HW19.8L
	20	20	125	25	20	32						
2525-M16	25	25	150	32	25	32	TN□□2204□□	CDH8N1	DHA5/16-32	ST43D	SP4D	HW39.7L HW23.8L
2525-M22	25	25	150	32	25	32						
3232-P22	32	32	170	40	32	32	TN□□2706□□	CDH8N1	DHA5/16-32	ST53D	SP5D	HW39.7L HW31.8L
4040-S22	40	40	250	50	40	32						
3232-P27	32	32	170	40	32	35	TN□□2706□□	CDH8N1	DHA5/16-32	ST53D	SP5D	HW39.7L HW31.8L
4040-S27	40	40	250	50	40	35						
4040-S33	40	40	250	50	40	40	TN□□3307□□	CDH8N	DHA5/16-32	ST63D	SP6DL	HW39.7L HW35.7L

↻ Applicable inserts B58-B65



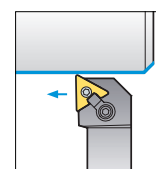
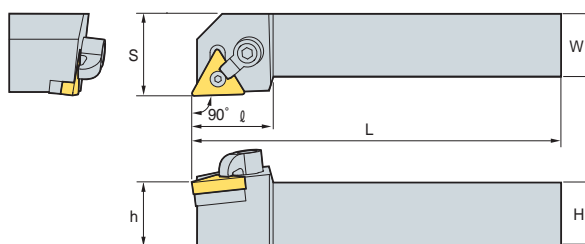


# B Multi Lock System

## MTGNR/L



TN□□



90°

• R type insert (mm)

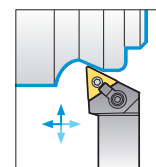
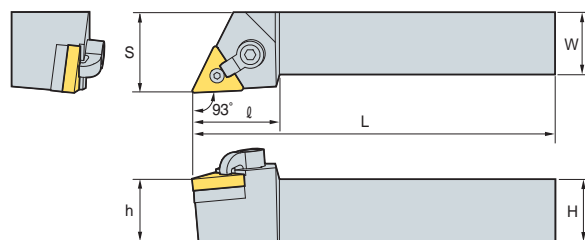
Designation	H	W	L	S	h	ℓ	Insert	Clamp	Clamp Screw	Shim	Shim Pin	Wrench
<b>MTGNR/L 1616-H16</b>	16	16	100	20	16	32	TN□□1604□□	CDH7N	DHA10-32-19	ST32D	SP3D	HW23.8L HW19.8L
<b>2020-K16</b>	20	20	125	25	20	32						
<b>2525-M16</b>	25	25	150	32	25	32						
<b>2525-M22</b>	25	25	150	32	25	32	TN□□2204□□	CDH8N1	DHA5/16-32	ST43D	SP4D	HW39.7L HW23.8L
<b>3232-P22</b>	32	32	170	40	32	32	TN□□2706□□	CDH8N1	DHA5/16-32	ST53D	SP5D	HW39.7L HW31.8L
<b>3232-P27</b>	32	32	170	40	32	35						
<b>4040-S27</b>	40	40	250	50	40	35	TN□□3307□□	CDH8N	DHA5/16-32	ST63D	SP6DL	HW39.7L HW35.7L
<b>4040-S33</b>	40	40	250	50	40	40						

➔ Applicable inserts B58-B65

## MTJNR/L



TN□□



93°

• R type insert (mm)

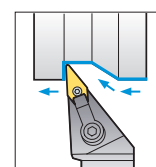
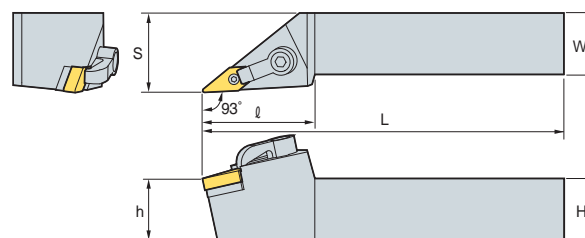
Designation	H	W	L	S	h	ℓ	Insert	Clamp	Clamp Screw	Shim	Shim Pin	Wrench
<b>MTJNR/L 2020-K16</b>	20	20	125	25	20	32	TN□□1604□□	CDH7N	DHA10-32-19	ST32D	SP3D	HW23.8L HW19.8L
<b>2525-M16</b>	25	25	150	32	25	32						
<b>2525-M22</b>	25	25	150	32	25	32						
<b>3232-P22</b>	32	32	170	40	32	32	TN□□2204□□	CDH8N1	DHA5/16-32	ST43D	SP4D	HW39.7L HW23.8L
<b>3232-P27</b>	32	32	170	40	32	35	TN□□2706□□	CDH8N1	DHA5/16-32	ST53D	SP5D	HW39.7L HW31.8L
<b>4040-S27</b>	40	40	250	50	40	35						
<b>4040-S33</b>	40	40	250	50	40	40	TN□□3307□□	CDH8N	DHA5/16-32	ST63D	SP6DL	HW39.7L HW35.7L

➔ Applicable inserts B58-B65

## MVJNR/L



VN□□



93°

• R type insert (mm)

Designation	H	W	L	S	h	ℓ	Insert	Clamp	Clamp Screw	Shim	Shim Pin	Wrench
<b>MVJNR/L 2020-K16</b>	20	20	125	25	20	44	VN□□1604□□	CDH8N2	DHA5/16-32	SV32D	SP3D	HW39.7L HW19.8L
<b>2525-M16</b>	25	25	150	32	25	45.5						
<b>3232-P16</b>	32	32	170	40	32	55.5						
<b>2525-M22</b>	25	25	150	32	25	56	VN□□2204□□	CDH8N2	DHA5/16-32	SV43D	SP4D	HW39.7L HW23.8L
<b>3232-P22</b>	32	32	170	40	32	55						
<b>4040-S22</b>	40	40	250	50	40	65						

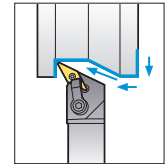
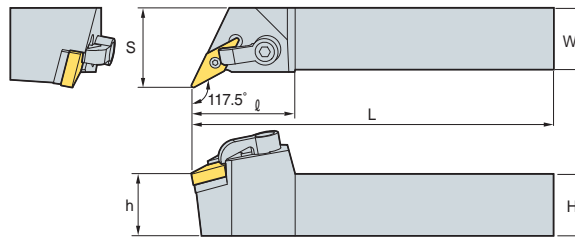
➔ Applicable inserts B66-B67



# MVQNR/L



VN□□



117.5°

• R type insert (mm)

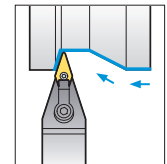
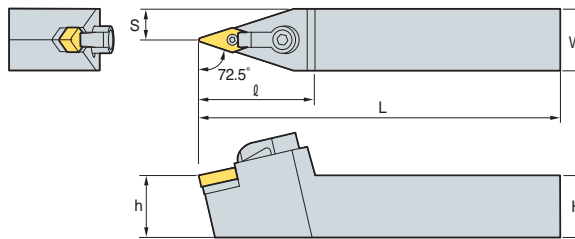
Designation	H	W	L	S	h	ℓ	Insert	Clamp	Clamp Screw	Shim	Shim Pin	Wrench
MVQNR/L 2020-K16	20	20	125	25	20	42	VN□□1604□□					
2525-M16	25	25	150	32	25	42						
3232-P16	32	32	170	40	32	37						

↻ Applicable inserts B66-B67

# MVVNN



VN□□



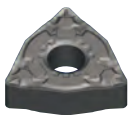
72.5°

(mm)

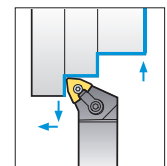
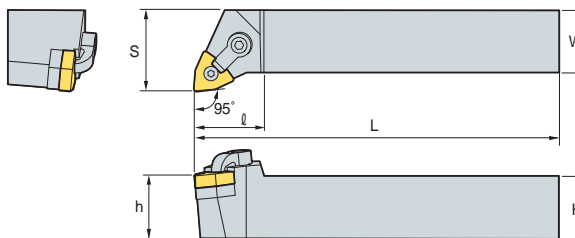
Designation	H	W	L	S	h	ℓ	Insert	Clamp	Clamp Screw	Shim	Shim Pin	Wrench
MVVNN 2020-K16	20	20	125	25	20	42	VN□□1604□□					
2525-M16	25	25	150	32	25	42						

↻ Applicable inserts B66-B67

# MWLNR/L



WN□□



95°

• R type insert (mm)

Designation	H	W	L	S	h	ℓ	Insert	Clamp	Clamp Screw	Shim	Shim Pin	Wrench
MWLNR/L 2020-K06	20	20	125	25	20	32	WN□□0604□□					
2525-M06	25	25	150	32	25	32						
3232-P06	32	32	170	40	32	32						
2020-K08	20	20	125	25	20	32	WN□□0804□□					
2525-M08	25	25	150	32	25	32						
3232-P08	32	32	170	40	32	32						

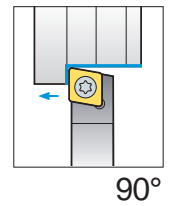
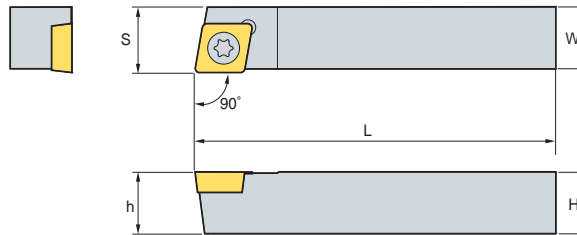
↻ Applicable inserts B68-B72

# B Screw on System

## SCACR/L



CC□T



90°

• R type insert (mm)

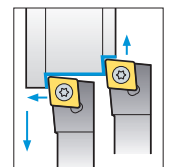
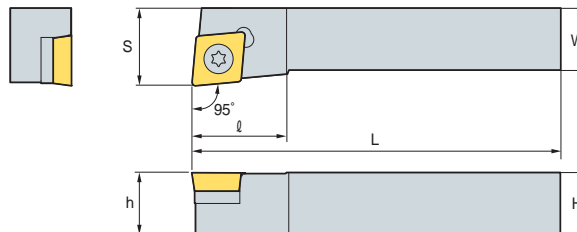
Designation	H	W	L	S	h	Insert	Screw	Shim	Shim Screw	Wrench
SCACR/L 1010-E06	10	10	70	10.5	10	CC□□T0602□□	FTKA02565	-	-	TW07P
1212-F09	12	12	80	12.5	12	CC□□T09T3□□	FTKA03508	-	-	TW15P

↻ Applicable inserts B73-B77, B103

## SCLCR/L



CC□T



95°

• R type insert (mm)

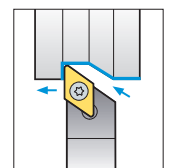
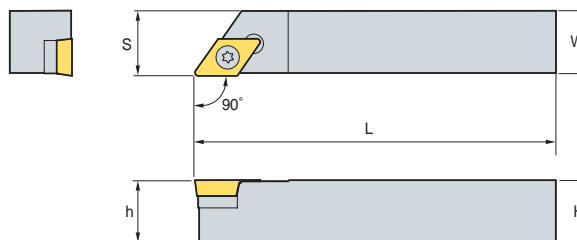
Designation	H	W	L	S	h	ℓ	Insert	Screw	Shim	Shim Screw	Wrench
SCLCR/L 0808-D06	08	08	60	10	08	10	CC□T0602□□	FTKA02565	-	-	TW07P
1010-E06	10	10	70	16	10	10					
1212-F09	12	12	80	20	12	16	CC□T09T3□□	FTGA03508	-	-	TW15P
1616-H09	16	16	100	20	16	16					
2020-K09	20	20	125	25	20	16					
2525-M09	25	25	150	32	25	26	CC□T09T3□□	FTGA0411F	SC42S	SHXN0610F	TW15P, HW40L
2020-K12	20	20	125	25	20	25	CC□T1204□□	FTGA03508	-	-	TW15P
2525-M12	25	25	150	32	25	26	CC□T1204□□	FTGA0411F	SC42S	SHXN0610F	TW15P, HW40L

↻ Applicable inserts B73-B77, B103

## SDACR/L



DC□T



90°

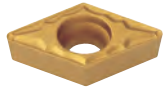
• R type insert (mm)

Designation	H	W	L	S	h	Insert	Screw	Shim	Shim Screw	Wrench
SDACR/L 1010-E07	10	10	70	10.5	10	DC□T0702□□	FTKA02565	-	-	TW07P
1212-F11	12	12	80	12.5	12	DC□T11T3□□	FTKA03508	-	-	TW15P
1616-H11	16	16	100	16.5	16		FTGA03512	SD32S	SHXN0509F	TW15P, HW35L

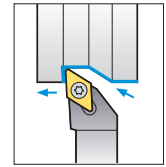
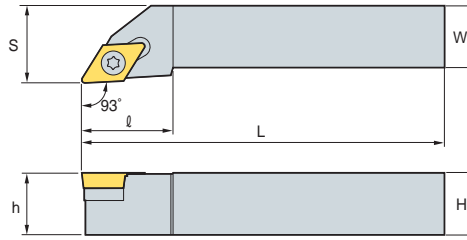
↻ Applicable inserts B79-B82, B104



# SDJCR/L



DC□T



93°

• R type insert  
(mm)

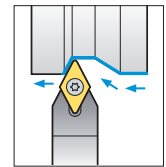
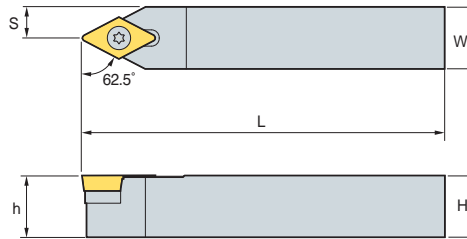
Designation	H	W	L	S	h	ℓ	Insert	Screw	Shim	Shim Screw	Wrench
SDJCR/L	1010-E07	10	10	70	12	10	DC□T0702□□	FTKA02565	-	-	TW07P
	1212-F07	12	12	80	16	12					
	1616-H07	16	16	100	20	16					
	2020-K07	20	20	125	25	20					
SDJCR/L	1212-F11	12	12	80	16	12	DC□T11T3□□	FTGA03512	SD32S	SHXN0509F	TW15P, HW35L
	1616-H11	16	16	100	20	16					
	2020-K11	20	20	125	25	20					
	2525-M11	25	25	150	32	25					

➔ Applicable inserts B79~B82, B104

# SDNCN



DC□T



62.5°

(mm)

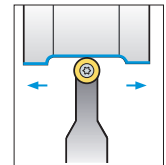
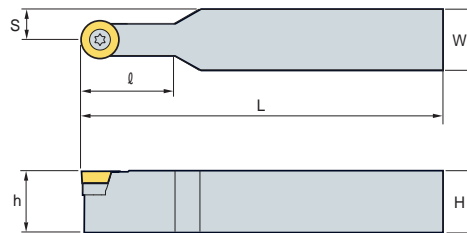
Designation	H	W	L	S	h	Insert	Screw	Shim	Shim Screw	Wrench	
SDNCN	1010-E07	10	10	70	5	10	DC□T0702□□	FTKA02565	-	-	TW07P
	1212-F07	12	12	80	6	12					
	1212-H11	12	12	100	6	12	DC□T11T3□□	FTGA03508	-	-	TW15P
	1616-H11	16	16	100	8	16	DC□T11T3□□	FTGA03512	SD32S	SHXN0509F	TW15P, HW35L
	2020-K11	20	20	125	10	20					
2025-M11	25	25	150	12.5	25	DC□T11T3□□	FTGA03512	SD32S	SHXN0509F	TW25P, HW35L	

➔ Applicable inserts B79~B82, B104

# SRDCN



RC□T



(mm)

Designation	H	W	L	S	h	ℓ	Insert	Screw	Shim	Shim Screw	Wrench
SRDCN	1010-E06	10	10	70	5	10	RC□T0602M0	FTKA02565	-	-	TW07P
	1212-F06	12	12	80	6	12					
	1616-H06	16	16	100	8	16					
SRDCN	2525-M06	25	25	150	12.5	25	RC□T0803M0	FTNA0307	-	-	TW09P
	1616-H08	16	16	100	8	16					
	2020-K08	20	20	125	10	20					
SRDCN	2525-M08	25	25	150	12.5	25	RC□T1003M0	FTKA03511A	SR10S	SHXN0509F	TW15P HW35L
	1616-H10	16	16	100	8	16					
SRDCN	2020-K10	20	20	125	10	20	RC□T1204M0	FTGA03512	SR12S	SHXN0509F	TW15P HW35L
	2525-M10	25	25	150	12.5	25					
	2020-K12	20	20	125	10	20					
2525-M12	25	25	150	12.5	25	28					

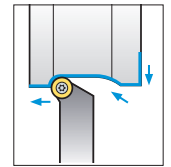
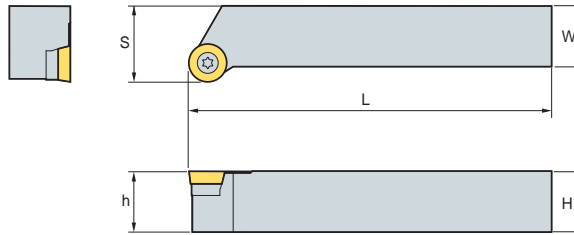
➔ Applicable inserts B83, B105

# B Screw on System

## SRGCR/L



RC□T



• R type insert  
(mm)

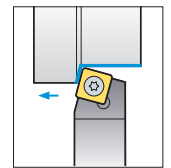
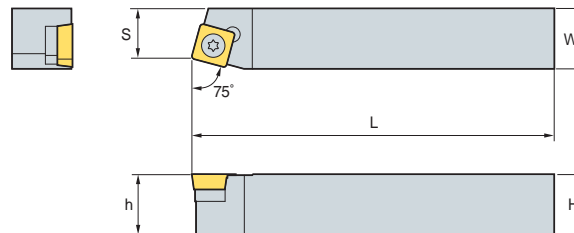
Designation	H	W	L	S	h	Insert	Screw	Shim	Shim Screw	Wrench
SRGCR/L	1010-E06	10	10	70	12	RC□T0602M0	FTKA02565	-	-	TW07P
	1212-F06	12	12	80	16					
	1616-H06	16	16	100	20					
SRGCR/L	1616-H08	16	16	100	20	RC□T0803M0	FTNA0307	-	-	TW09P
	2020-K08	20	20	125	25					
	2525-M08	25	25	150	32					
SRGCR/L	1616-H10	16	16	100	20	RC□T1003M0	FTKA03511A	SR10S	SHXN0509F	TW15P HW35L
	2020-K10	20	20	125	25					
	2525-M10	25	25	150	32					
SRGCR/L	2020-K12	20	20	125	25	RC□T1204M0	FTGA03512	SR12S	SHXN0509F	TW15P HW35L
	2525-M12	25	25	150	32					

➔ Applicable inserts B83, B105

## SSBCR/L



SC□T



75°

• R type insert  
(mm)

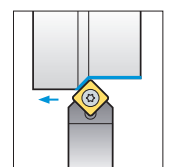
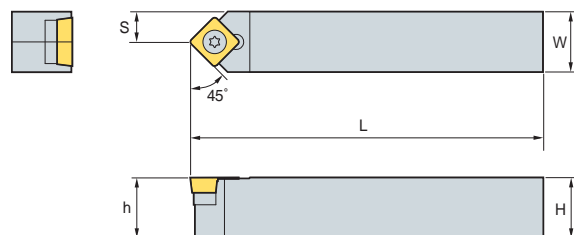
Designation	H	W	L	S	h	Insert	Screw	Shim	Shim Screw	Wrench
SSBCR/L	1212-F09	12	12	80	11	SC□T09T3□□	FTGA03508	-	-	TW15P
	1616-H09	16	16	100	13		FTGA03512	SS32S	SHXN0509F	TW15P, HW35L
	2020-K12	20	20	125	17	SC□T1204□□	FTGA0411F	SS42S	SHXN0610F	TW15P, HW40L

➔ Applicable inserts B84, B106

## SSDCN



SC□T



45°

(mm)

Designation	H	W	L	S	h	Insert	Screw	Shim	Shim Screw	Wrench
SSDCN	1212-F09	12	12	80	6	SC□T09T3□□	FTGA03508	-	-	TW15P
	1616-H09	16	16	100	8		FTGA03512	SS32S	SHXN0509F	TW15P, HW35L

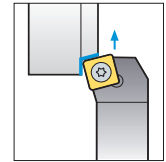
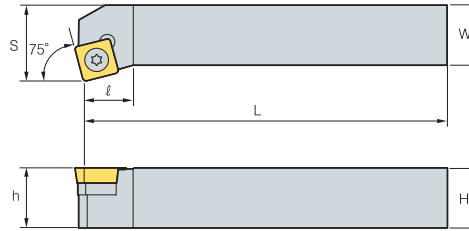
➔ Applicable inserts B84, B106



# SSKCR/L



SC□T



75°

• R type insert (mm)

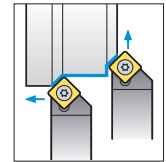
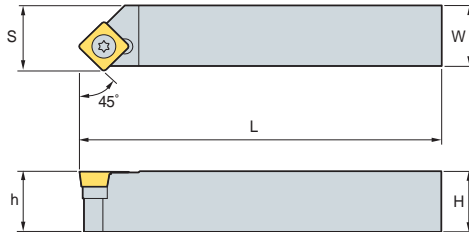
Designation	H	W	L	S	h	l	Insert	Screw	Shim	Shim Screw	Wrench
<b>SSKCR/L 1616-H09</b>	16	16	100	20	16	13	SC□T09T3□□	FTGA03512	SS32S	SHXN0509F	TW15P, HW35L

↻ Applicable inserts **B84, B106**

# SSSCR/L



SC□T



45°

• R type insert (mm)

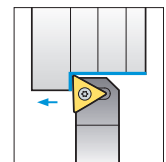
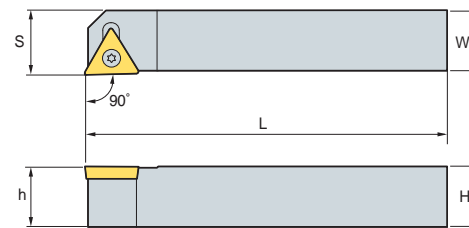
Designation	H	W	L	S	h	Insert	Screw	Shim	Shim Screw	Wrench
<b>SSSCR/L 1616-H09</b>	16	16	100	17	16	SC□T09T3□□	FTGA03512	SS32S	SHXN0509F	TW15P, HW35L
<b>2020-K12</b>	20	20	125	21	20	SC□T1204□□	FTGA0411F	SS42S	SHXN0610F	TW15P, HW40L
<b>2525-M12</b>	25	25	150	26	25	SC□T1204□□	FTGA0411F	SS42S	SHXN0610F	TW15P, HW40L

↻ Applicable inserts **B84, B106**

# STACR/L



TC□T



90°

• R type insert (mm)

Designation	H	W	L	S	h	Insert	Screw	Shim	Shim Screw	Wrench
<b>STACR/L 1010-E09</b>	10	10	70	10.5	10	TC□T0902□□	FTKA02206	-	-	TW06P
<b>1212-F11</b>	12	12	80	12.5	12	TC□T1102□□	FTKA02565	-	-	TW07P

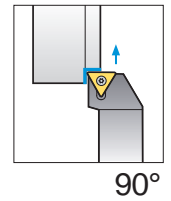
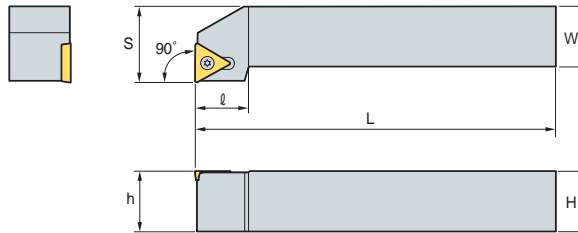
↻ Applicable inserts **B88-B89, B107**

# B Screw on System

## STFCR/L



TC□T



90°

• R type insert (mm)

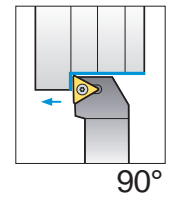
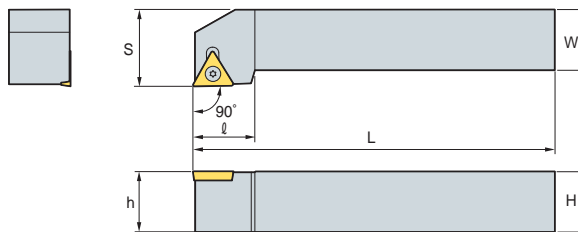
Designation	H	W	L	S	h	l	Insert	Screw	Shim	Shim Screw	Wrench
STFCR/L 1010-E09	10	10	70	12	10	10	TC□T0902□□	FTKA02206	-	-	TW06P
	12	12	80	16	12	14	TC□T1102□□	FTKA02565	-	-	TW07P
1616-H11	16	16	100	20	16	14	TC□T16T3□□	FTGA03512	ST32S	SHXN0509F	TW15P, HW35L
1616-H16	16	16	100	20	16	19					
2020-K16	20	20	125	25	20	19	TC□T16T3□□	FTGA03512	ST32S	SHXN0509F	TW15P, HW35L
2525-M16	25	25	150	32	25	25.2					

➔ Applicable inserts B88-B89, B107

## STGCR/L



TC□T



90°

• R type insert (mm)

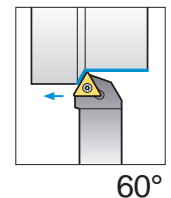
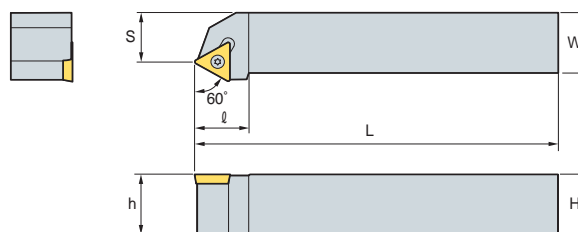
Designation	H	W	L	S	h	l	Insert	Screw	Shim	Shim Screw	Wrench
STGCR/L 0808-D09	08	08	60	10	08	11	TC□T0902□□	FTKA02206	-	-	TW06P
	10	10	70	12	10	11	TC□T1102□□	FTKA02565	-	-	TW07P
1616-H11	16	16	100	20	16	16	TC□T16T3□□	FTGA03512	ST32S	SHXN0509F	TW15P, HW35L
1616-H16	16	16	100	20	16	21					
2020-K16	20	20	125	25	20	21	TC□T16T3□□	FTGA03512	ST32S	SHXN0509F	TW15P, HW35L
2525-M16	25	25	150	32	25	21					

➔ Applicable inserts B88-B89, B107

## STTCR/L



TC□T



60°

• R type insert (mm)

Designation	H	W	L	S	h	l	Insert	Screw	Shim	Shim Screw	Wrench
STTCR/L 1616-H11	16	16	100	13	16	14	TC□T1102□□	FTKA02565	-	-	TW07P
	16	16	100	13	16	19	TC□T16T3□□	FTGA03512	ST32S	SHXN0509F	TW15P, HW35L
2020-K16	20	20	125	17	20	19					

➔ Applicable inserts B88-B89, B107

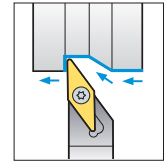
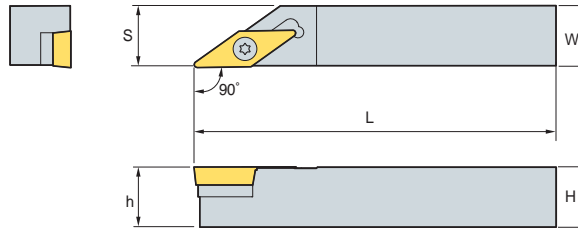




# SVABR/L



VB□T



90°

\* R type insert (mm)

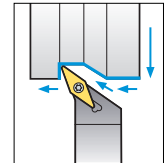
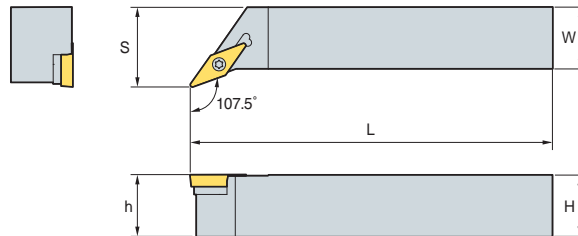
Designation	H	W	L	S	h	Insert	Screw	Shim	Shim Screw	Wrench
SVABR/L 1616-H16	16	16	100	16.5	16	VB□T1604□□	FTGA03512	SV32S	SHXN0509F	TW15P, HW35L
2020-K16	20	20	125	20.5	20					

↻ Applicable inserts B94~B96, B108

# SVHBR/L



VB□T



107.5°

\* R type insert (mm)

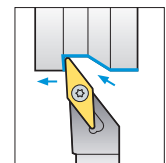
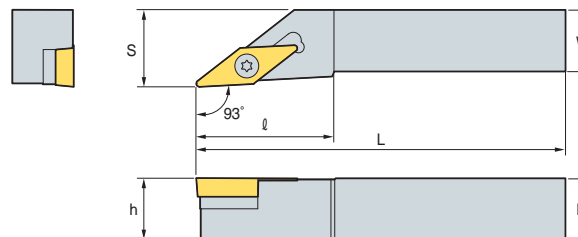
Designation	H	W	L	S	h	Insert	Screw	Shim	Shim Screw	Wrench
SVHBR/L 2525-M16	25	25	150	32	25	VB□T1604□□	FTGA03512	SV32S	SHXN0509F	TW15P, HW35L
3225-P16	32	25	170	32	32					

↻ Applicable inserts B94~B96, B108

# SVJBR/L



VB□T



93°

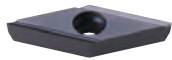
\* R type insert (mm)

Designation	H	W	L	S	h	ℓ	Insert	Screw	Shim	Shim Screw	Wrench
SVJBR/L 1212-F11	12	12	80	16	12	27	VB□T1102□□	FTKA02565	-	-	TW07P
1616-H11	16	16	100	20	16	27					
2020-K11	20	20	125	25	20	27					
1616-H16	16	16	100	20	16	36	VB□T1604□□	FTGA03512	SV32S	SHXN0509F	TW15P, HW35L
2020-K16	20	20	125	25	20	41					
2525-M16	25	25	150	32	25	41	VB□T1604□□	FTGA03512	SV32S	SHXN0509F	TW15P, HW35L
3225-P16	32	25	170	32	32	55					
3232-P16	32	32	170	40	33	55					

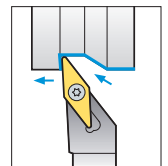
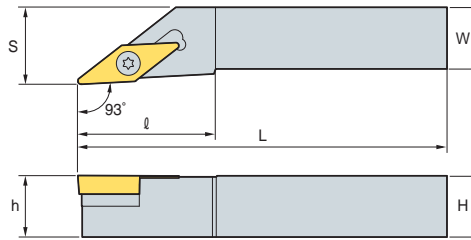
↻ Applicable inserts B94~B96, B108

# B Screw on System

## SVJCR/L



VC□T



93°

• R type insert (mm)

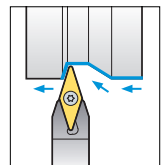
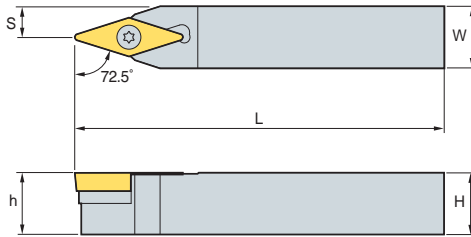
Designation	H	W	L	S	h	ℓ	Insert	Screw	Shim	Shim Screw	Wrench
SVJCR/L	1212-F11	12	12	80	16	12	VC□T1103□□	FTKA02565	-	-	TW07P
	1616-H11	16	16	100	20	16					
	2020-K11	20	20	125	25	20					
	1212-F13	12	12	80	16	12	VC□T1303□□	FTKA0307	-	-	TW09P
	1616-H13	16	16	100	20	16					
	2020-K13	20	20	125	25	20					
	1616-H16	16	16	100	20	16	VC□T1604□□	FTGA03512	SV32S	SHXN0509F	TW15P, HW35L
	2020-K16	20	20	125	25	20					
	2525-M16	25	25	150	32	25					

➔ Applicable inserts B97-B99, B109

## SVVBN



VB□T



72.5°

(mm)

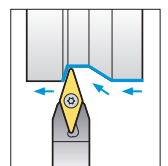
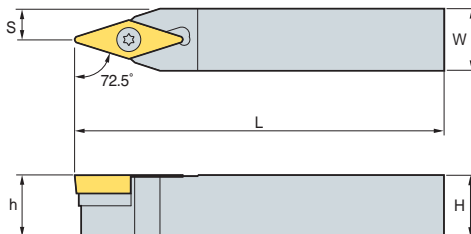
Designation	H	W	L	S	h	Insert	Screw	Shim	Shim Screw	Wrench	
SVVBN	1212-F11	12	12	80	6	12	VB□T1102□□	FTKA02565	-	-	TW07P
	1616-H11	16	16	100	8	16					
	2020-K11	20	20	125	10	20					
	1616-H16	16	16	100	8	16	VB□T1604□□	FTGA03512	SV32S	SHXN0509F	TW15P, HW35L
	2020-K16	20	20	125	10	20					
	2525-M16	25	25	150	12.5	25					
	3225-P16	32	25	170	12.5	32					

➔ Applicable inserts B94-B96, B108

## SVVCN



VC□T



72.5°

(mm)

Designation	H	W	L	S	h	Insert	Screw	Shim	Shim Screw	Wrench	
SVVCN	1212-F11	12	12	80	6	12	VC□T1103□□	FTKA02565	-	-	TW07P
	1616-H11	16	16	100	8	16					
	2020-K11	20	20	125	10	20					
	1212-F13	12	12	80	6	12	VC□T1303□□	FTNA0307	-	-	TW09P
	1616-H13	16	16	100	8	16					
	2020-K13	20	20	125	10	20					
	1616-H16	16	16	100	8	16	VC□T1604□□	FTGA03512	SV32S	SHXN0509F	TW15P, HW35L
	2020-K16	20	20	125	10	20					
	2525-M16	25	25	150	12.5	25					

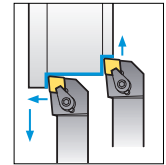
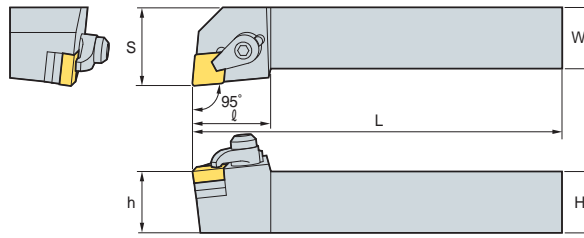
➔ Applicable inserts B97-B99, B109



# CCLNR/L



CN□N



95°

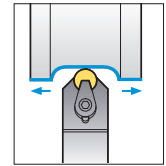
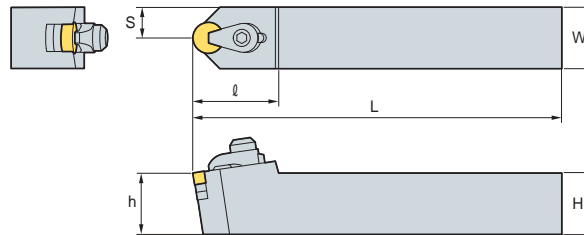
• R type insert  
(mm)

Designation	H	W	L	S	h	ℓ	Insert	Clamp	Screw	Shim	Spring	Wrench
CCLNR/L 2525-M12C	25	25	150	32	25	32	CN□N1204□□ CN□N1207□□	CH6R3	MHX0630 SHX0310	SC42CC	SR3	HW40L HW20L

# CRDNN



RN□N



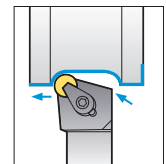
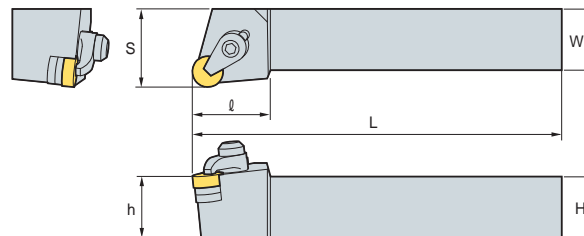
(mm)

Designation	H	W	L	S	h	ℓ	Insert	Clamp	Screw	Shim	Spring	Wrench
CRDNN 2525-M12C	25	25	150	12.5	25	35	RN□N1204□□ RN□N1207□□	CH6R3	MHX0630 SHX0310	SC42CC	SR3	HW40L HW20L

# CRGNR/L



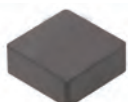
RN□N



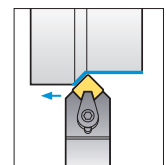
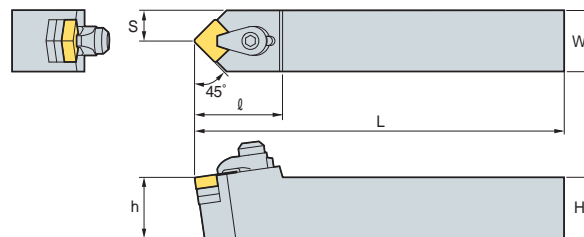
• R type insert  
(mm)

Designation	H	W	L	S	h	ℓ	Insert	Clamp	Screw	Shim	Spring	Wrench
CRGNR/L 2525-M12C	25	25	150	32	25	32	RN□N1204□□ RN□N1207□□	CH6R3	MHX0630 SHX0310	SC42CC	SR3	HW40L HW20L

# CSDNN



SN□N



45°

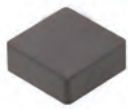
(mm)

Designation	H	W	L	S	h	ℓ	Insert	Clamp	Screw	Shim	Spring	Wrench
CSDNN 2525-M12C	25	25	125	12.5	25	35	SN□N1204□□ RN□N1207□□	CH6R3	MHX0630 SHX0310	SS42CC	SR3	HW40L HW20L

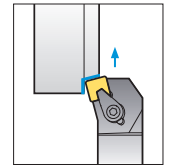
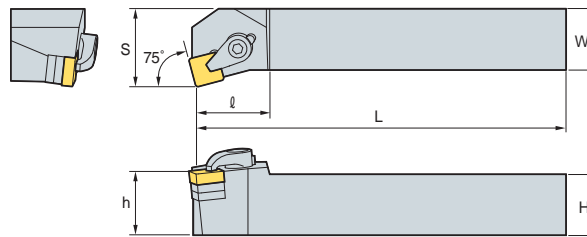


# B Ceramic Holder

## CSKNR/L



SN□N



75°

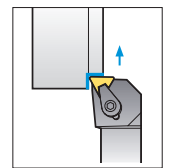
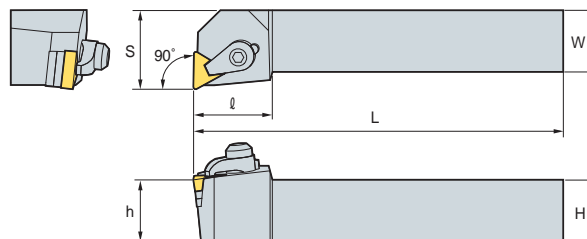
• R type insert (mm)

Designation	H	W	L	S	h	l	Insert	Clamp	Screw	Shim	Spring	Wrench
CSKNR/L 2525-M12C	25	25	150	32	25	28	SN□N1204□□ SN□N1207□□	CH6R3	MHX0630 SHX0310	SS42CC	SR3	HW40L HW20L

## CTFNR/L



TN□N



90°

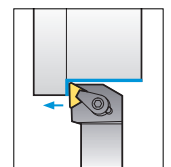
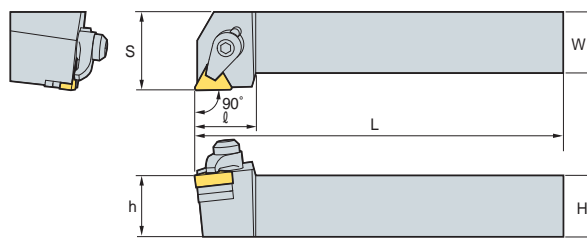
• R type insert (mm)

Designation	H	W	L	S	h	l	Insert	Clamp	Screw	Shim	Spring	Wrench
CTFNR/L 2525-M16C	25	25	150	32	25	32	TN□N1604□□ TN□N1607□□	CH6R3	MHX0630 SHX0310	ST32CC	SR3	HW40L HW20L

## CTGNR/L



TN□N



90°

• R type insert (mm)

Designation	H	W	L	S	h	l	Insert	Clamp	Screw	Shim	Spring	Wrench
CTGNR/L 2525-M16C	25	25	150	32	25	32	TN□N1604□□ TN□N1607□□	CH6R3	MHX0630 SHX0310	ST32CC	SR3	HW40L HW20L



**Note)** Generally, two shims are clamped to a Ceramic Holder.

However, only one shim is used in clamping 1207□□ and 1607□□ sized inserts.



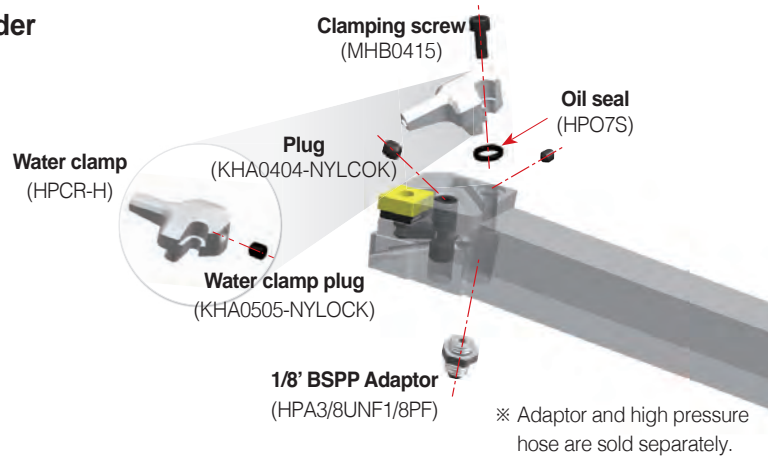
KORLOY High Pressure Coolant

## KHP Coolant **new**

### ISO turning holder

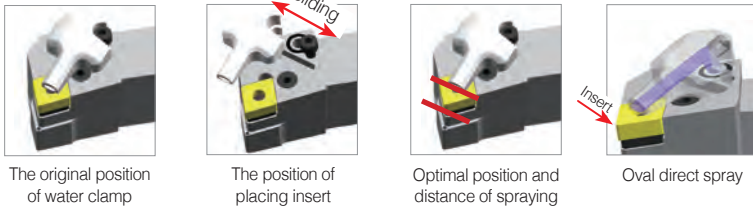
- 300% increased productivity on Inconel machining vs. low pressure coolant system
- Cooling, tool life, and chip control are improved by the high volume coolant multi-directional injection system

#### Structure of Holder



#### Features

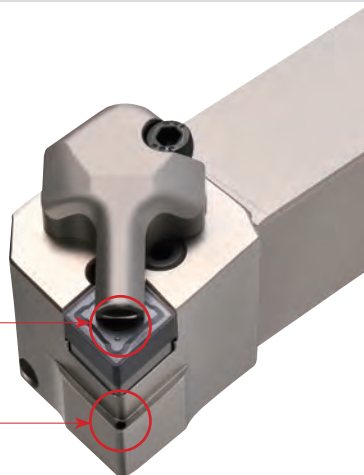
- The optimal distance between the insert and the jet orifice and the ideal place of the jet orifice
- Maximized loss pressure of coolant pressure due to streamlined design of internal path
- Easy to clamp an insert for sliding clamp system



#### MAX 300 bar

Workpiece	The minimum pressure	The maximum pressure
P	50	300
M	70	
K	60	
N	50	
S	70	

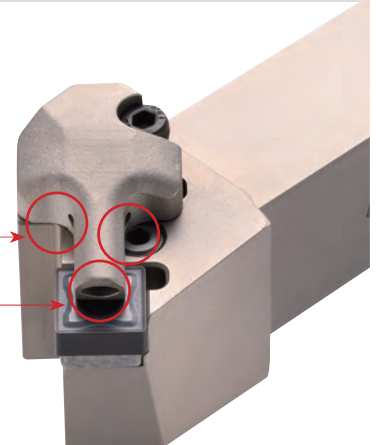
#### Water clamp with a hole



Spray to the upper surface of insert  
 Spray to the bottom surface of insert

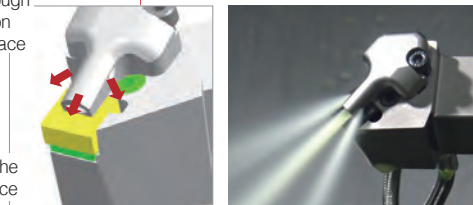


#### Water clamp with three holes



Injection through three holes on the rake surface

Injection on the bottom surface



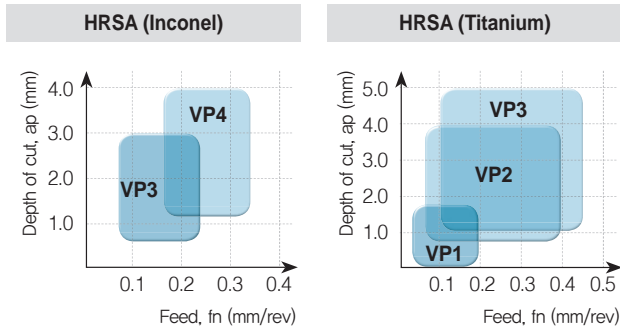
※ Clamp is sold separately

# B Technical Information for KHP Coolant

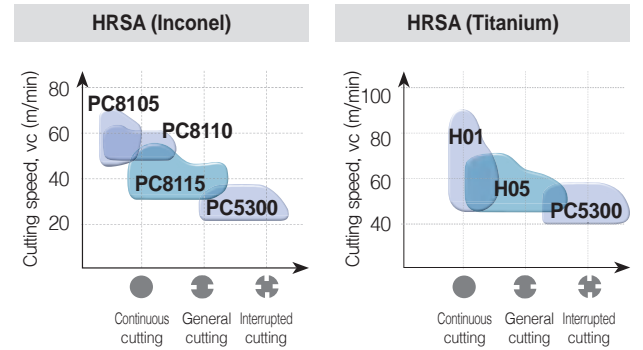
## How to use the water clamp



## Application range



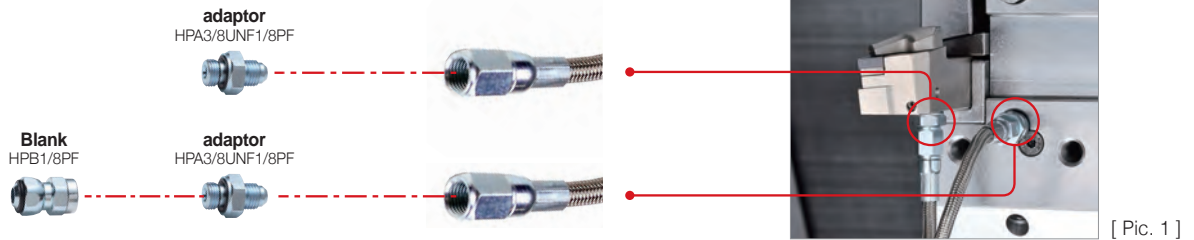
## Grade Line-up



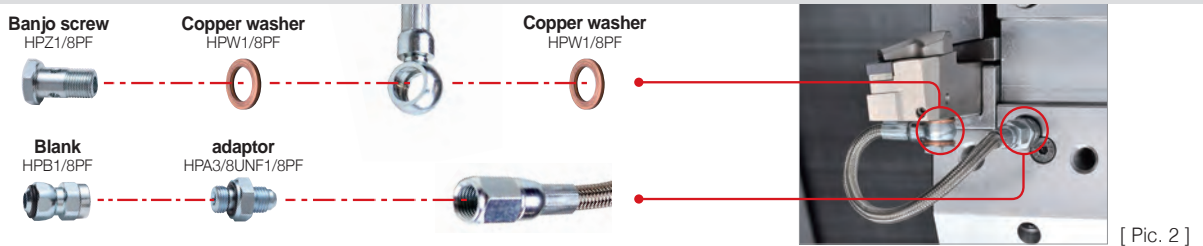
## How to clamp the KHP Coolant

- 3 types of installation systems makes clamping easy
- The banjo type hose provides wider area for machining than other types

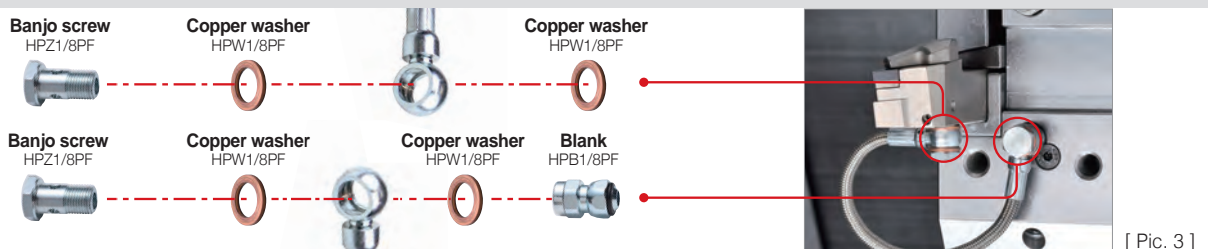
### Straight to straight (S-S)



### Straight to banjo (S-B)



### Banjo to banjo (B-B)






※ Blank including a fixed oil seal provides easy clamping

※ Banjo screws provide easy clamping and clamping a holder to the turning machine with various types of blanks


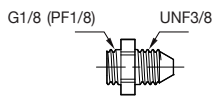

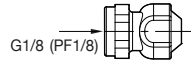

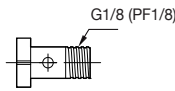




## Components of KHP Coolant




- The components of high pressure coolant are sold separately
- Various components are available according to different machining sites and uses machining with high pressure coolant

Designation	Shape	Hose length	High pressure hose	Blank	Adaptor	Banjo screw	Copper washer	Pic.		
HPH3/8UNF-200-SET		200 mm	1 EA	1 EA	2 EA	-	-	1		
HPH3/8UNF-250-SET		250 mm								
HPH3/8UNF1/8PF-200-SET		200 mm			1 EA	1 EA	1 EA	1 EA	3 EA	2
HPH3/8UNF1/8PF-250-SET		250 mm								
HPH1/8PF-200-SET		200 mm			-	2 EA	5 EA	3		
HPH1/8PF-250-SET		250 mm								

## KHP Coolant Parts

Division	Designation	Shape
adaptor	HPA3/8UNF1/8PF	 
Blank	HPB1/8PF	 
Banjo screw	HPZ1/8PF	 
Copper washer	HPW1/8PF	 

## KHP Coolant High pressure hose

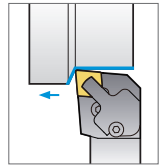
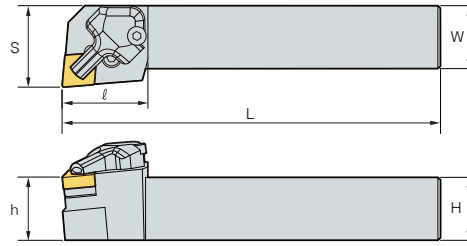
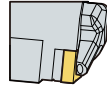
High pressure hose shape		Length	S	B
Straight to straight (HPH3/8UNF)		200 mm	UNF3/8	-
		250 mm		
Straight to banjo (HPH3/8UNF1/8PF)		200 mm	UNF3/8	Internal Ø10
		250 mm		
Banjo to banjo (HPH1/8PF)		200 mm	-	Internal Ø10
		250 mm		



## PCLNR/L



CN□□



95°

• R type insert (mm)

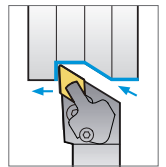
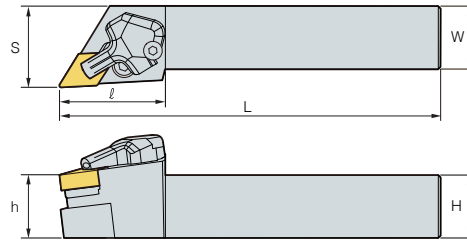
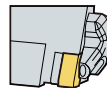
Designation	H	W	L	S	h	l	Insert	Lever	Screw	Shim	Ship pin	Shim Pin Punch	Clamp	Clamping screw	Oil seal	Plug	Wrench
PCLNR/L 2525-M12-KHP	25	25	150	32	25	34	CN□□1204□□										
3232-P12-KHP	32	32	170	40	32	34											

➔ Applicable inserts B36~B42

## PDJNR/L



DN□□



93°

• R type insert (mm)

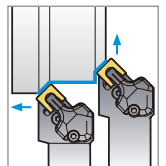
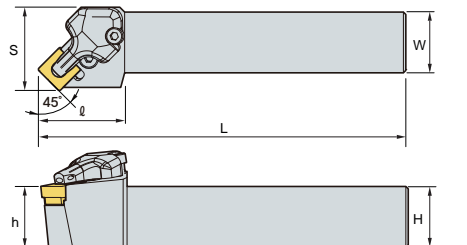
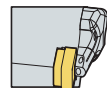
Designation	H	W	L	S	h	l	Insert	Lever	Screw	Shim	Ship pin	Shim Pin Punch	Clamp	Clamping screw	Oil seal	Plug	Wrench										
PDJNR/L 2525-M11-KHP	25	25	150	32.25	25	42	DN□□1104□□																				
2525-M1504-KHP	25	25	150	32.25	25	42	DN□□1504□□											LV3AN	VHX0617N	SD32N	SP3	LSPS3	HPCR/L-H	MHB0415	HPO7S	KHA0404-NYLOCK	HW20L HW25L HW30L
2525-M1506-KHP	25	25	150	32.25	25	42	DN□□1506□□											LV4BN	VHX0821N	SD43N	SP4N	LSPS4	HPCR/L-H	MHB0415	HPO7S	KHA0404-NYLOCK	HW20L HW30L

➔ Applicable inserts B43~B48

## PSSNR/L



SN□□



45°

• R type insert (mm)

Designation	H	W	L	S	h	l	Insert	Lever	Screw	Shim	Ship pin	Shim Pin Punch	Clamp	Clamping screw	Oil seal	Plug	Wrench
PSSNR/L 2525-M12-KHP	25	25	150	34.25	25	35.5	SN□□1204□□										
								LV4N	VHX0821	SS42N	SP4N	LSPS4	HPCR/L-3H	MHB0415	HPO7S	KHA0404-NYLOCK	HW20L HW30L

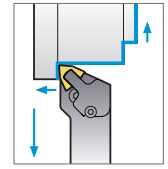
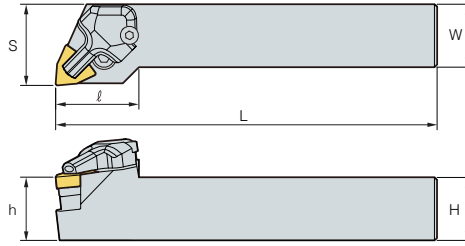
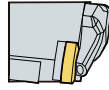
➔ Applicable inserts B50~B57



# PWLNR/L



WN□□



95°

• R type insert (mm)

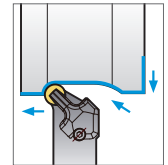
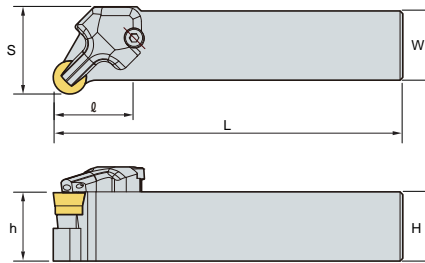
Designation	H	W	L	S	h	l	Insert	Lever	Screw	Shim	Ship pin	Shim Pin Punch	Clamp	Clamping screw	Oil seal	Plug	Wrench
PWLNR/L 2525-M08-KHP	25	25	150	32.25	25	33	WN□□0804□□										
3232-P08-KHP	32	32	170	39.25	32	33											

➔ Applicable inserts B68~B72

# SRGCR/L



RCGT



• R type insert (mm)

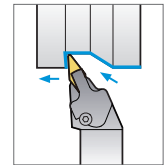
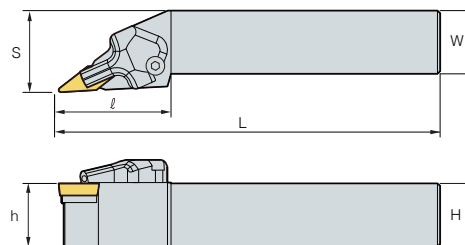
Designation	H	W	L	S	h	l	Insert	Screw	Shim	Shim Screw	Clamp	Clamping screw	Oil seal	Wrench
SRGCR/L 2525-M12-KHP	25	25	150	31.5	25	-	RCGT1204M0							
								FTGA03512	SR12S	SHXN0509F	HPCR/L-3H	MHB0415	HPO7S	HW15P HW30L HW35L

➔ Applicable inserts B83, B105

# SVJBR/L



VB□□



93°

• R type insert (mm)

Designation	H	W	L	S	h	l	Insert	Screw	Shim	Shim Screw	Clamp	Clamping screw	Oil seal	Wrench
SVJBR/L 2525-M16-KHP	25	25	150	32.5	25	46.5	VB□□1604□□							
								FTGA03512	SV32S	SHXN0509F	HPCR/L-H	MHB0415	HPO7S	TW15P HW30L HW35L

➔ Applicable inserts B94~B96, B108

# B Boring Bar Code System(ISO)

S 12 M - S T F P R - 11

1

2

3

4

5

6

7

8

9

Type of Bar

Bar Diameter

Bar Length

Method of Mounting Insert

Insert Shape

Lead Angle of Boring Bar

Relief Angle of Insert

Hand of Bar

Length of Cutting Edge

## 1 Type of Bar

S 12 M - S T F P R - 11

"A" Steel with coolant hole

"E" Carbide bar with fixed steel head and coolant hole

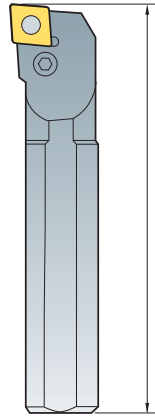
"C" Carbide shank

"S" Steel shank

"X" Special type

## 3 Bar Length

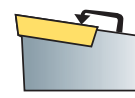
S 12 M S T F P R - 11



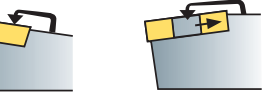
Symbol(L)	length(mm)
H	100
J	110
K	125
M	150
N	160
Q	180
R	200
S	250
T	300
U	350
V	400
W	450
Y	500

## 4 Method of Mounting Insert

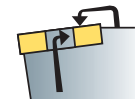
S 12 M S T F P R - 11



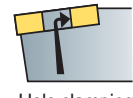
Top clamping



Top and hole clamping



Top and hole clamping



Hole clamping

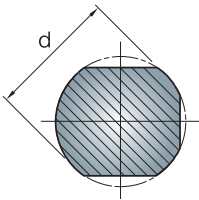


Screw on

S

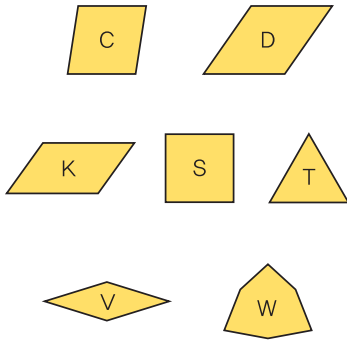
## 2 Bar Diameter

S 12 M S T F P R - 11



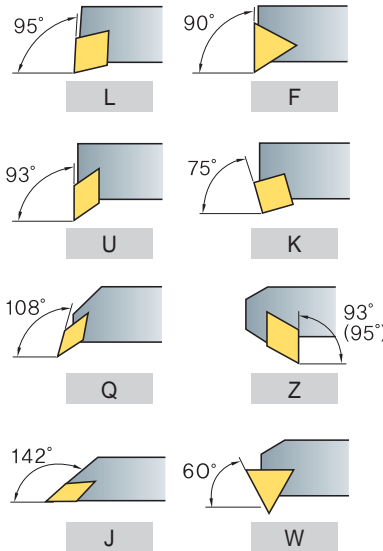
## 5 Insert Shape

S 12 M S T F P R - 11



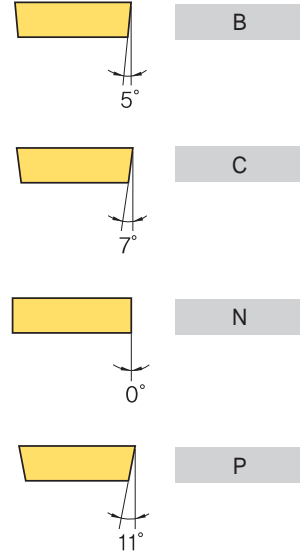
## 6 Lead Angle of Boring Bar

S 12 M S T F P R - 11



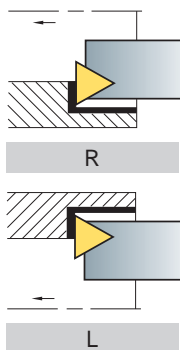
## 7 Relief Angle of Insert

S 12 M S T F P R - 11



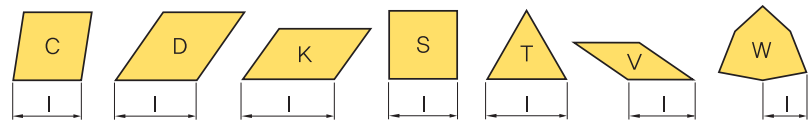
## 8 Hand of Bar

S 12 M S T F P R - 11



## 9 Length of Cutting Edge

S 12 M S T F P R - 11



## Double Clamp System

Cutting Shape								
Designation	DCLNR/L	DDUNR/L	DSKNR/L	DTFNR/L	DWLNR/L			
Approach angle	95°	93°	75°	90°	95°			
Page	B208	B208	B208	B209	B209			
Copying		●						
Facing	●				●			
Back turning		●						
Turning	●	●	●	●	●			

## Lever Lock System

Cutting Shape								
Designation	PCLNR/L	PDSNR/L	PDUNR/L	PSKNR/L	PTFNR/L	PWLNR/L		
Approach angle	95°	62.5°	93°	75°	90°	95°		
Page	B210	B210	B210	B211	B211	B211		
Copying		●	●					
Facing	●					●		
Back turning		●	●			●		
Turning	●	●	●	●	●	●		

## Clamp on System

Cutting Shape								
Designation	CKUNR/L	CSKPR/L	CTFPR/L					
Approach angle	93°	75°	90°					
Page	B212	B212	B212					
Copying								
Facing								
Back turning	●							
Turning	●	●	●					

## Multi Lock System

Cutting Shape								
Designation	MCLNR/L	MDUNR/L	MSKNR/L	MTFNR/L	MVUNR/L	MWLNR/L		
Approach angle	95°	93°	75°	90°	93°	95°		
Page	B213	B213	B213	B214	B214	B214		
Copying		●			●			
Facing	●					●		
Back turning		●			●			
Turning	●	●	●	●	●	●		

# B Index for Boring Bar

## Screw on System

Cutting Shape								
Designation	SCLCR/L	SCLPR/L	SDQCR/L	SDUCR/L	SDZCR/L	SSKCR/L	SSKPR/L	STFCR/L
Approach angle	95°	95°	107.5°	93°	93°	75°	75°	90°
Page	B215	B216	B217	B218	B219	B219	B219	B220
Copying			●	●				
Facing	●	●						
Back turning			●	●	●			
Turning	●	●	●	●	●	●	●	●

Cutting Shape								
Designation	STFPR/L	STWPR/L	SVJCR/L	SVQBR/L	SVQCR/L	SVUBR/L	SVUCR/L	SWLCR/L
Approach angle	90°	60°	142°	108°	108°	93°	93°	95°
Page	B221	B221	B222	B222	B223	B223	B223	B224
Copying			●	●	●	●	●	●
Facing								
Back turning				●	●	●	●	●
Turning	●	●	●	●	●	●	●	●

## Compact Mini

Cutting Shape								
Designation	SCLCR/L	STUBR/L	STLBR/L	STUPR/L	SWUBR/L			
Approach angle	95°	93°	95°	93°	93°			
Page	B225	B225	B225	B226	B227			
Copying								
Facing	●	●	●					
Back turning				●				
Turning	●	●	●	●	●			

## Carbide Shank Boring Bar

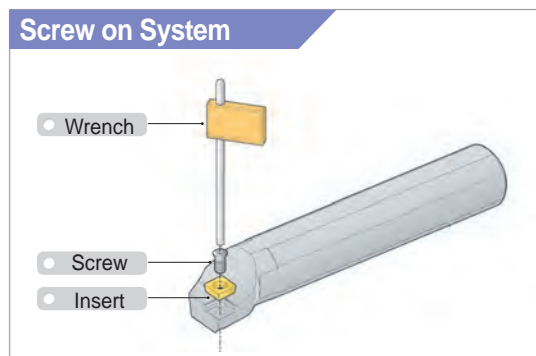
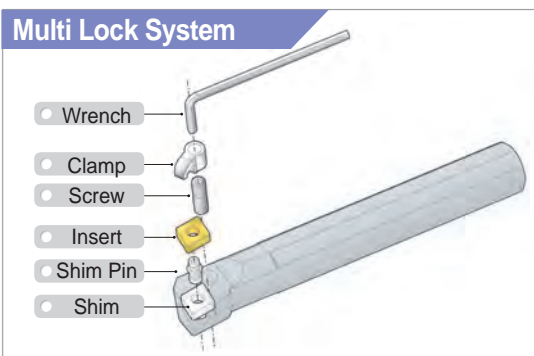
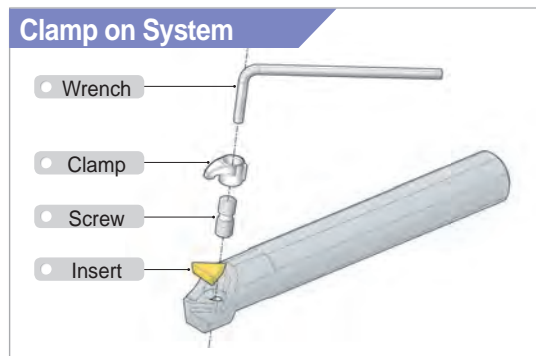
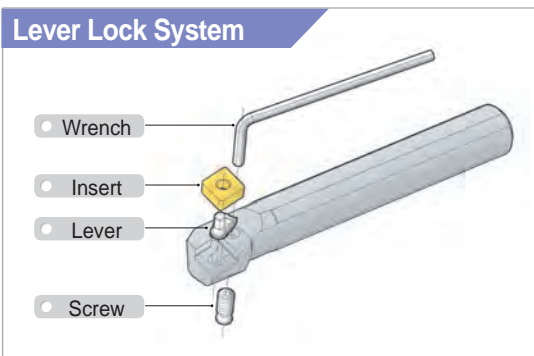
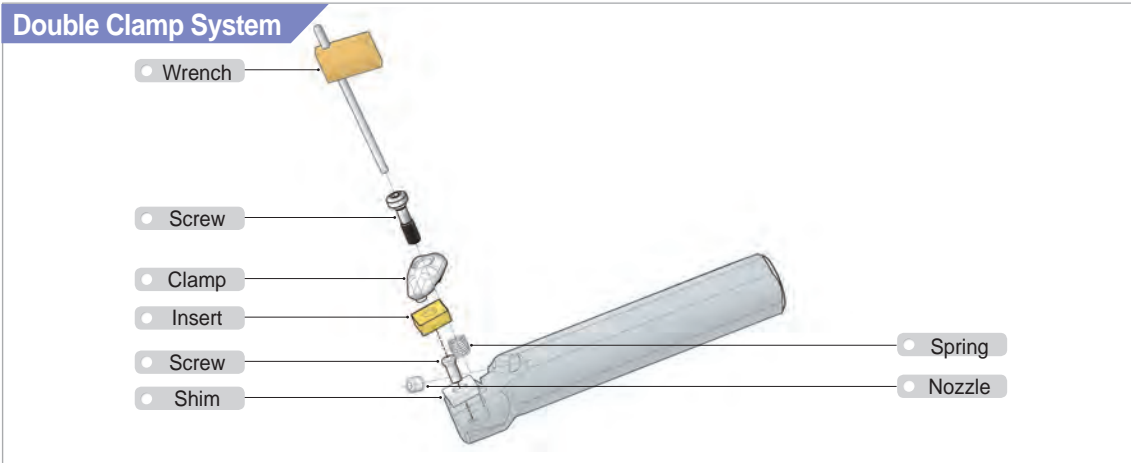
Designation	SCLCR/L	SCLPR/L	SDQCR/L	SDUCR/L	STFCR/L
Approach angle	95°	95°	107.5°	93°	90°
Page	B215	B216	B217	B218	B220
Designation	STFPR/L	STUBR/L	STUPR/L	SWUBR/L	-
Approach angle	90°	93°	93°	93°	-
Page	B221	B225	B226	B227	-

## Sleeve

Shape	
Designation	SL
Page	B151



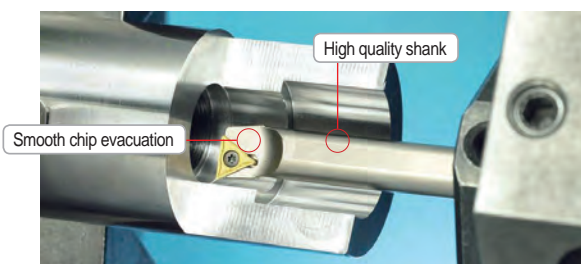
## Instructions of Boring Bar assembly



## Carbide Shank Boring Bar

- Excellent cutting performance even in internal machining with chattering
- Available for various workpieces such as steel, stainless steel, cast iron, etc.
- Improved tool life and surface roughness

### Features



Higher strength and durability than steel shank, special surface treatment applied

### Comparison of chipping

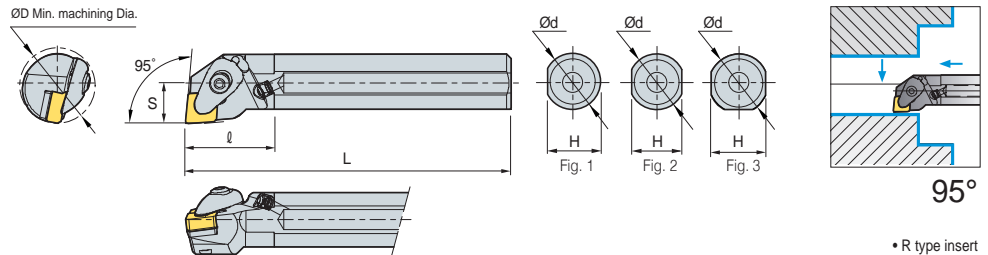
Specifications	Steel boring bar	Carbide boring bar				
	Increased chipping on insert	Stable tool life				
• SCM440						
• $vc$ (m/min) = 200						
• $ap$ (mm) = 0.4						
• $fn$ (mm/rev) = 0.15						
• Cutting depth: 5D						
	Rmax	Rz	Ra	Rmax	Rz	Ra
	4.67	3.68	0.62	3.07	2.76	0.53

# B Double Clamp System

## DCLNR/L



CN□□



95°

• R type insert (mm)

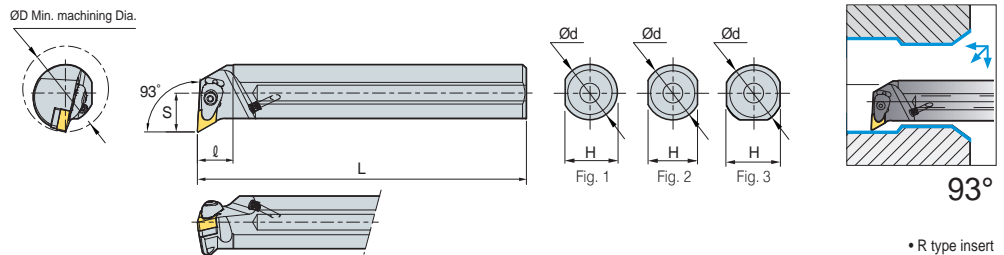
Designation	ØD	Ød	H	L	S	l	Insert	Clamp	Clamp Screw	Shim	Shim Screw	Spring	Nozzle	Wrench	Fig.
A25R-DCLNR/L-09	32	25	24	200	17	40	CN□□0903□□	CVH3	CHX0415	SC32V	FTKA0307	SPR0510	CN0605	HW25P	1
A25R-DCLNR/L-12	32	25	24	200	17	40	CN□□1204□□	CVH4	CHX0518	SC42V	FTKA0410	SPR0714	CN0605	HW30P	1
A32S-DCLNR/L-12	40	32	30	250	22	50									3
A40T-DCLNR/L-12	50	40	38	300	27	60									
A50U-DCLNR/L-16	63	50	48	350	35	70	CN□□1606□□	CVH5	CHX0622	SC54V	FTNA0511	SPR0811	CN0605	HW40L	3

➔ Applicable inserts B36-B42

## DDUNR/L



DN□□



93°

• R type insert (mm)

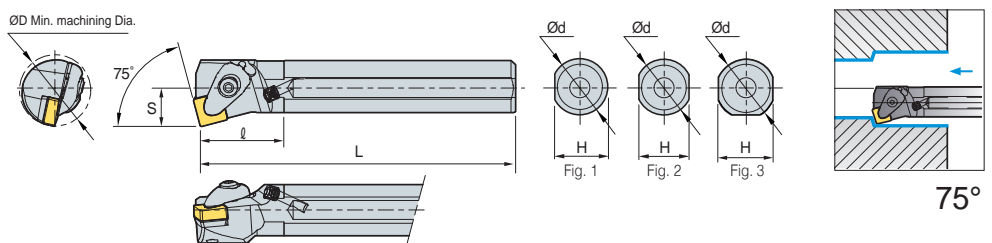
Designation	ØD	Ød	H	L	S	l	Insert	Clamp	Clamp Screw	Shim	Shim Screw	Spring	Nozzle	Wrench	Fig.
A40T-DDUNR/L-15	50	40	38	300	27	60	DN□□1506□□	CVH4	CHX0518	SD43V	FTKA0410	SPR0714	CN0605	HW30P	3
A50U-DDUNR/L-15	63	50	47	350	35	70									
A40T-DDUNR/L-15 -3	50	40	37	300	25	60	DN□□1504□□	CVH4	CHX0518	SD44V	FTKA0410	SPR0714	CN0605	HW30P	3
A50U-DDUNR/L-15 -3	63	50	47	350	35	70									

➔ Applicable inserts B43-B48

## DSKNR/L



SN□□



75°

• R type insert (mm)

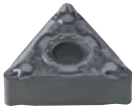
Designation	ØD	Ød	H	L	S	l	Insert	Clamp	Clamp Screw	Shim	Shim Screw	Spring	Nozzle	Wrench	Fig.
A25R-DSKNR/L-09	32	25	24	200	17	40	SN□□0903□□	CVH3	CHX0415	SS32V	FTKA0307	SPR0510	CN0605	HW25P	1
A25R-DSKNR/L-12	32	25	24	200	17	40	SN□□1204□□	CVH4	CHX0518	SS42V	FTKA0410	SPR0714	CN0605	HW30P	1
A32S-DSKNR/L-12	40	32	30	250	22	50									3
A40T-DSKNR/L-12	50	40	38	300	27	60									

➔ Applicable inserts B50-B57

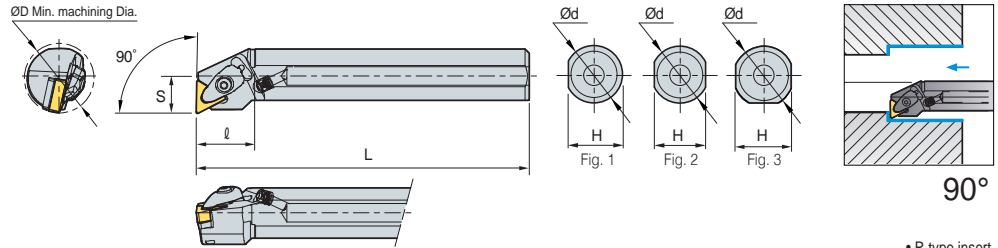




## DTFNR/L



TN□□



• R type insert (mm)

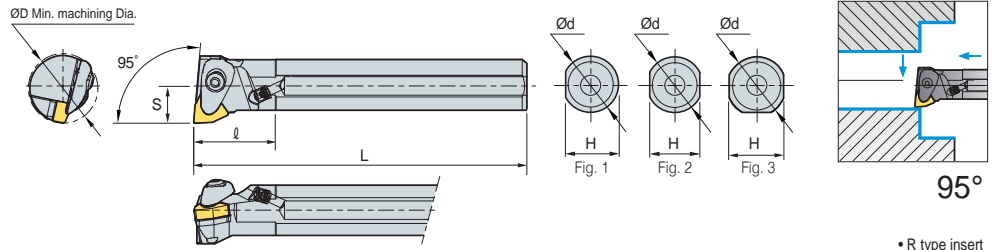
Designation	ØD	Ød	H	L	S	ℓ	Insert	Clamp	Clamp Screw	Shim	Shim Screw	Spring	Nozzle	Wrench	Fig.
A25R-DTFNR/L-16	32	25	24	200	17	40	TN□□1604□□	CVH3	CHX0415	ST32V	FTKA0307	SPR0510	CN0605	HW25P	1
A32S-DTFNR/L-16	40	32	30	250	22	50									3
A40T-DTFNR/L-22	50	40	38	300	27	60	TN□□2204□□	CVH4	CHX0518	ST44V	FTKA0410	SPR0714	CN0605	HW30P	3
A50U-DTFNR/L-22	63	50	47	350	35	70									

↻ Applicable inserts B58-B65

## DWLNR/L



WN□□



• R type insert (mm)

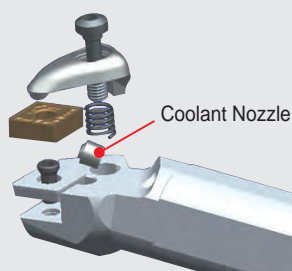
Designation	ØD	Ød	H	L	S	ℓ	Insert	Clamp	Clamp Screw	Shim	Shim Screw	Spring	Nozzle	Wrench	Fig.
A25R-DWLNR/L-06	32	25	24	200	17	40	WN□□0604□□	CVH3	CHX0415	SW32V	FTKA0307	SPR0510	CN0605	HW25P	1
A32S-DWLNR/L-06	40	32	30	250	22	50									3
A40T-DWLNR/L-06	50	40	38	300	27	60									
A25R-DWLNR/L-08	32	25	24	200	17	40	WN□□0804□□	CVH4	CHX0518	SW42V	FTKA0410	SPR0714	CN0605	HW30P	1
A32S-DWLNR/L-08	40	32	30	250	22	50									3
A40T-DWLNR/L-08	50	40	38	300	27	60									
A50U-DWLNR/L-08	63	50	47	350	35	70									

↻ Applicable inserts B68-B72



### Features of Double Clamp (Boring bar)

Longer tool life and excellent surface finish can be achieved with the adjustable Coolant Nozzle

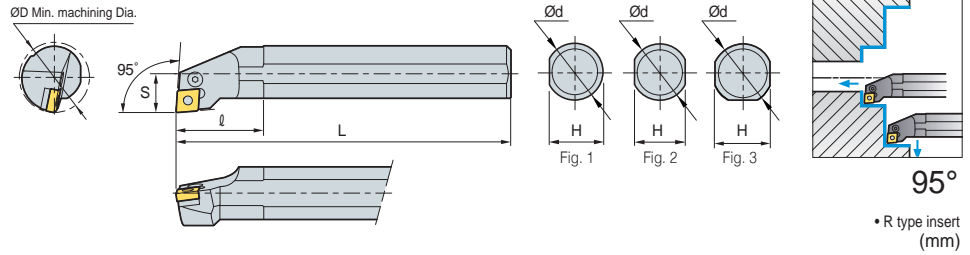


# B Lever Lock System

## PCLNR/L



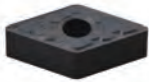
CN□□



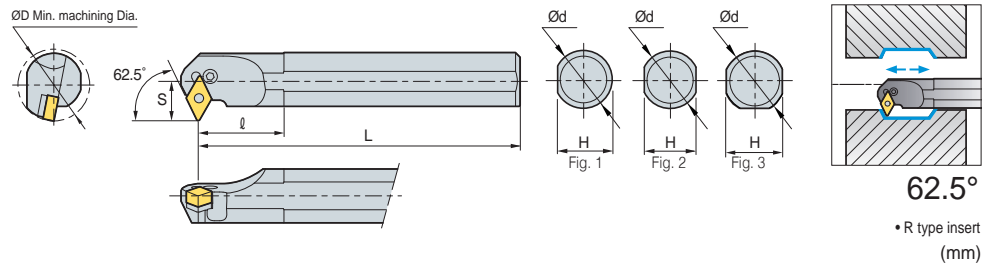
Designation	ØD	Ød	H	L	S	l	Insert	Lever	Screw	Shim	Shim Pin	Shim Pin Punch	Wrench	Fig.
S16R-PCLNR/L-09	20	16	14	200	11	25	CN□□0903□□	LV3C	VHX0509B	-	-	-	HW20L	2
S20S-PCLNR/L-09	25	20	18	250	13	32		3						
S25R-PCLNR/L-09	32	25	23	200	17	40	CN□□1204□□	LV4A	VHX0613A	-	-	-	HW25L	3
S25R-PCLNR/L-12	32	25	23	200	17	40		LV4	VHX0821	SC42B	SP4	LSPS4	HW30L	
S25T-PCLNR/L-12	32	25	23	300	17	40		LV4	VHX0821	SC43B	SP4	-	HW30L	
S32S-PCLNR/L-12	40	32	30	250	22	50		LV4	VHX0821	SC42B	SP4	LSPS4	HW30L	
S32U-PCLNR/L-12	40	32	30	350	22	50		LV6	VHX1027	SC63	SP6	LSPS6	HW40L	3
S40T-PCLNR/L-12	50	40	38	300	27	60		CN□□1906□□	LV4A	VHX0613A	-	-	-	HW25L
S50U-PCLNR/L-12	63	50	47	350	35	70	CN□□1204□□	LV4	VHX0821	SC42B	SP4	LSPS4	HW30L	3
S50U-PCLNR/L-19	63	50	47	350	35	70		3						
A25R-PCLNR/L-12	32	25	24	200	17	40	1							
A32S-PCLNR/L-12	40	32	30	250	22	50	3							
A40T-PCLNR/L-12	50	40	38	300	27	60								

↻ Applicable inserts B36-B42

## PDSNR/L



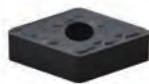
DN□□



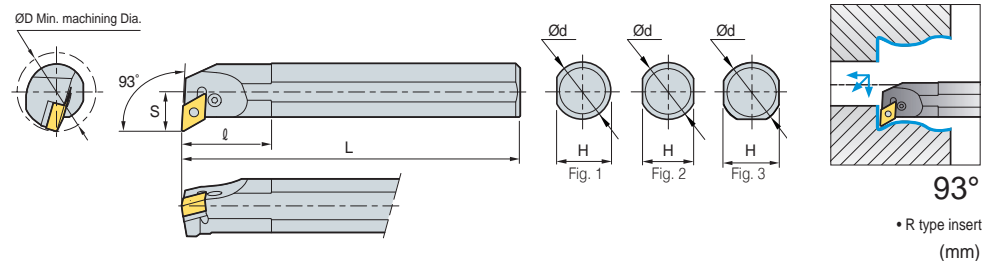
Designation	ØD	Ød	H	L	S	l	Insert	Lever	Screw	Shim	Shim Pin	Shim Pin Punch	Wrench	Fig.
S32S-PDSNR/L-15	40	32	30	250	22	50	DN□□1506□□	LV4B	VHX0821	SD42	SP4	LSPS4	HW30L	3
S40T-PDSNR/L-15	50	40	38	300	27	60		3						
S32S-PDSNR/L-15-3	40	32	30	250	22	50	DN□□1504□□	LV4	VHX0821	SD42	SP4	LSPS4	HW30L	3
S40T-PDSNR/L-15-3	50	40	38	300	27	60	3							
A32S-PDSNR/L-15	40	32	30	250	22	50	DN□□1506□□	LV4B	VHX0821	SD42	SP4	LSPS4	HW30L	3
A32S-PDSNR/L-15-3	40	32	30	250	22	50	DN□□1504□□	LV4	VHX0821	SD42	SP4	LSPS4	HW30L	

↻ Applicable inserts B43-B48

## PDUNR/L



DN□□



Designation	ØD	Ød	H	L	S	l	Insert	Lever	Screw	Shim	Shim Pin	Shim Pin Punch	Wrench	Fig.
S32S-PDUNR/L-11	40	32	30	250	22	50	DN□□1104□□	LV3	VHX0617	SD317	SP3	LSPS3	HW25L	3
S32S-PDUNR/L-15	40	32	30	250	22	50	DN□□1506□□	LV4B	VHX0821	SD42	SP4	LSPS4	HW30L	3
S40T-PDUNR/L-15	50	40	38	300	27	60		3						
S50U-PDUNR/L-15	63	50	47	350	35	70	DN□□1504□□	LV4	VHX0821	SD42	SP4	LSPS4	HW30L	3
S32S-PDUNR/L-15-3	40	32	30	250	22	50		3						
S40T-PDUNR/L-15-3	50	40	38	300	27	60	3							
A32S-PDUNR/L-15	40	32	30	250	22	50	DN□□1506□□	LV4B	VHX0821	SD42	SP4	LSPS4	HW30L	3
A32S-PDUNR/L-15-3	40	32	30	250	22	50	DN□□1504□□	LV4	VHX0821	SD42	SP4	LSPS4	HW30L	

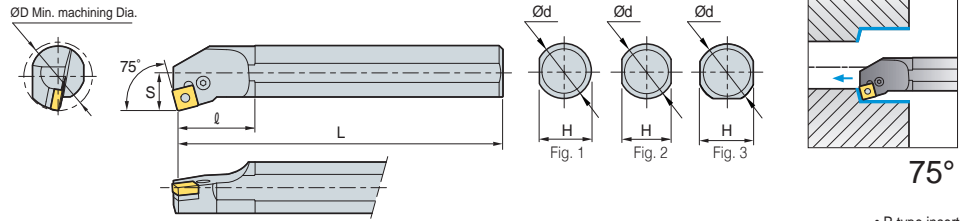
↻ Applicable inserts B43-B48



## PSKNR/L



SN□□

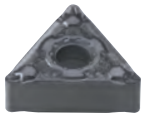


• R type insert (mm)

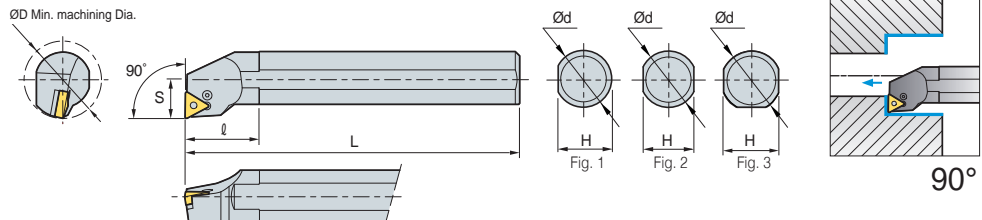
Designation	ØD	Ød	H	L	S	l	Insert	Lever	Screw	Shim	Shim Pin	Shim Pin Punch	Wrench	Fig.
S25R-PSKNR/L-12	32	25	23	200	17	40	SN□□1204□□	LV4A	VHX0613A	-	-	-	HW30L	3
S32S-PSKNR/L-12	40	32	30	250	22	50		LV4	VHX0821	SS42B	SP4	LSPS4	HW30L	
S40T-PSKNR/L-12	50	40	38	300	27	60	SN□□1204□□	LV4A	VHX0613A	-	-	-	HW25L	1
A25R-PSKNR/L-12	32	25	24	200	17	40		LV4	VHX0821	SS42B	SP4	LSPS4	HW30L	3
A32S-PSKNR/L-12	40	32	30	250	22	50								

↻ Applicable inserts B50~B57

## PTFNR/L



TN□□



• R type insert (mm)

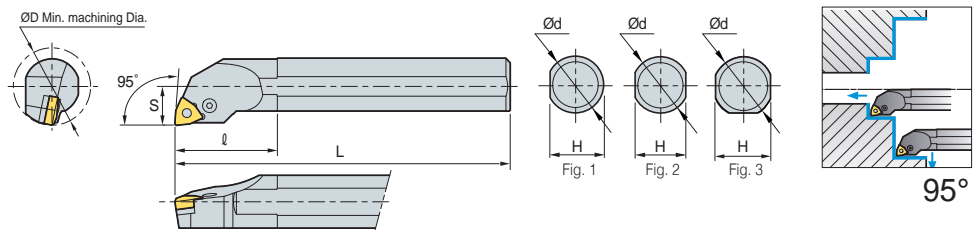
Designation	ØD	Ød	H	L	S	l	Insert	Lever	Screw	Shim	Shim Pin	Shim Pin Punch	Wrench	Fig.
S16R-PTFNR/L-11	20	16	14	200	11	25	TN□□1103□□	LV2	VHX0509B	-	-	-	HW25L	2
S20S-PTFNR/L-11	25	20	18	250	13	32								3
S25R-PTFNR/L-11	32	25	23	200	17	40	TN□□1604□□	LV3B	VHX0512B	-	-	-	HW20L	3
S25R-PTFNR/L-16	32	25	23	200	17	40		LV3	VHX0617	ST317B	SP3	LSPS3	HW25L	
S32S-PTFNR/L-16	40	32	30	250	22	50		LV3	VHX0617	-	-	-	HW25L	1
S40T-PTFNR/L-16	50	40	38	300	27	60		LV3	VHX0617	ST317B	SP3	LSPS3	HW25L	3
A25R-PTFNR/L-16	32	25	24	200	17	40								
A32S-PTFNR/L-16	40	32	30	250	22	50								

↻ Applicable inserts B58~B65

## PWLNR/L



WN□□



• R type insert (mm)

Designation	ØD	Ød	H	L	S	l	Insert	Lever	Screw	Shim	Shim Pin	Shim Pin Punch	Wrench	Fig.
S16R-PWLNR/L-06	20	16	14	200	11	25	WNMG060408	LV3B	VHX0512B	-	-	-	HW20L	2
S20S-PWLNR/L-06	25	20	18	250	13	32	WN□□0604□□	LV3B	VHX0512B	-	-	-	HW20L	2
S25R-PWLNR/L-06	32	25	23	200	17	40		LV3	VHX0617	SW317	SP3	LSPS3	HW25L	3
S32S-PWLNR/L-06	40	32	30	250	22	50	WN□□0804□□	LV4A	VHX0613A	-	-	-	HW25L	3
S25R-PWLNR/L-08	32	25	23	200	17	40		LV4	VHX0821	SW42	SP4	LSPS3	HW30L	
S32S-PWLNR/L-08	40	32	30	250	22	50								

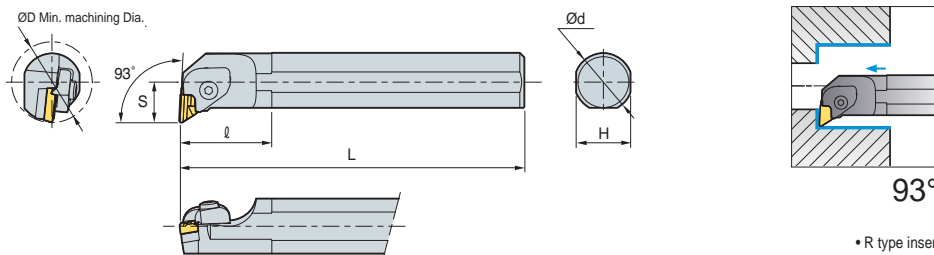
↻ Applicable inserts B68~B72

# B Clamp on System

## CKUNR/L



KN□□



93°

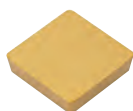
• R type insert (mm)

Designation	ØD	Ød	H	L	S	ℓ	Insert	Clamp	Clamp Screw	Spring	Shim	Pin+Spring	Shim Screw	Wrench							
S32S-CKUNR-16	40	32	30	250	22	70	KN□□1604□□L														
S40T-CKUNR-16	50	40	37	300	27	60									CTH6LI	CHX0625	SR3	SK33CL	PN0515 SR4	SHX0310	HW40L HW20L
S50U-CKUNR-16	63	50	43	350	35	55															
S32S-CKUNL-16	40	32	30	250	22	70	KN□□1604□□R														
S40T-CKUNL-16	50	40	37	300	27	60									CTH6RI	CHX0625	SR3	SK33C	PN0515 SR4	SHX0310	HW40L HW20L
S50U-CKUNL-16	63	50	43	350	35	55															

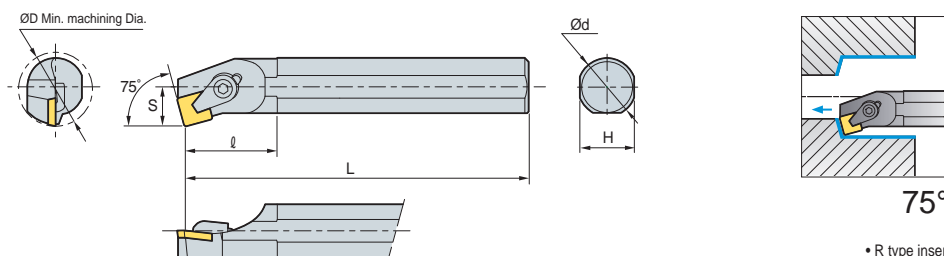
➔ Applicable inserts B49

• Use left handed insert for right handed holder

## CSKPR/L



SP□□



75°

• R type insert (mm)

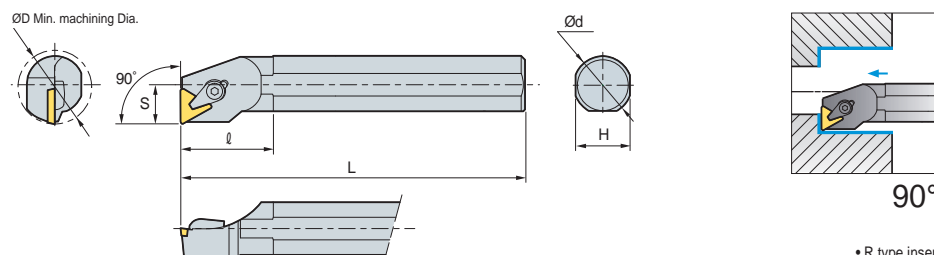
Designation	ØD	Ød	H	L	S	ℓ	Insert	Clamp	Clamp Screw	C-ring	Wrench
S16R-CSKPR/L-09	20	16	15	200	11	30	SP□□0903□□				
S20S-CSKPR/L-09	25	20	18	250	13	36					
S20S-CSKPR/L-12	25	20	18	250	13	28	SP□□1203□□				
S25R-CSKPR/L-12	32	25	23	300	17	40					
								CH6R5	CH0616	CR04C	HW30L

➔ Applicable inserts B85-B86

## CTFPR/L



TP□□



90°

• R type insert (mm)

Designation	ØD	Ød	H	L	S	ℓ	Insert	Clamp	Clamp Screw	C-ring	Shim	Shim Pin	Wrench						
S12M-CTFPR/L-11	16	12	11	150	9	26	TP□□1103□□												
S16R-CTFPR/L-11	20	16	15	200	11	40								CH4R1C	CHX0414C	CR02C	-	-	HW25L
S20S-CTFPR/L-11	25	20	18	250	13	40													
S16R-CTFPR/L-16	20	16	15	200	11	40	TP□□1603□□												
S20S-CTFPR/L-16	25	20	18	250	13	40								CH5R5C	CHX0519C	CR03C	-	-	HW30L
S25R-CTFPR/L-16	32	25	23	200	17	40													
S32S-CTFPR/L-16	40	32	30	250	22	45								CH6R5	CHX0622C	CR04C	ST32C	SP3C	
S40T-CTFPR/L-16	50	40	37	300	27	60	TP□□2204□□												
S40T-CTFPR/L-22	50	40	37	300	27	60								CH83R1	CH0823C	CR05C	ST43C	SP4C	HW40L

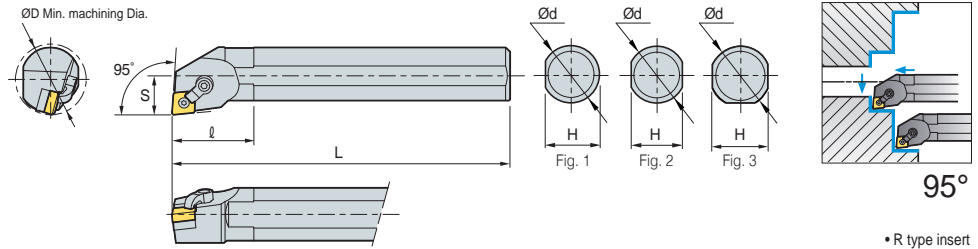
➔ Applicable inserts B90-B93



## MCLNR/L



CN□□



• R type insert (mm)

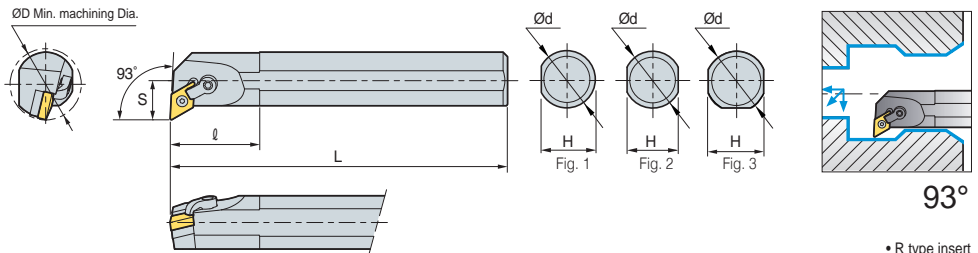
Designation	ØD	Ød	H	L	S	ℓ	Insert	Clamp	Clamp Screw	Shim	Shim Pin	Wrench	Fig.
S20S-MCLNR/L-09	25	20	18	200	13	32	CN□□0903□	CDH7N	DHA10/32-19	-	SP3D3	HW19.8L HW23.8L	2
S25R-MCLNR/L-09	32	25	23	250	17	40							3
S25R-MCLNR/L-12	32	25	23	200	17	40	CN□□1204□	CDH6N	DHA1/4-21	SC43D	SP4DS	HW31.8L HW23.8L	3
S32S-MCLNR/L-12	40	32	30	250	22	50							
S40T-MCLNR/L-12	50	40	38	300	27	60	CN□□1204□	CDH6N	DHA1/4-21	-	SP4DS	HW31.8L	1
A25R-MCLNR/L-12	32	25	24	200	17	40							3
A32S-MCLNR/L-12	40	32	30	250	22	50							

➔ Applicable inserts B36~B42

## MDUNR/L



DN□□



• R type insert (mm)

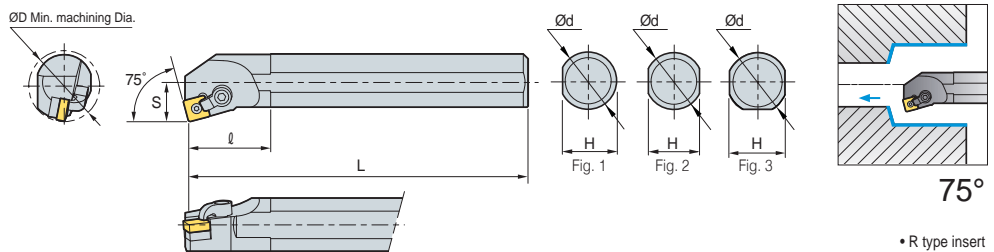
Designation	ØD	Ød	H	L	S	ℓ	Insert	Clamp	Clamp Screw	Shim	Shim Pin	Wrench	Fig.
S32S-MDUNR/L-15-3	40	32	30	250	22	50	DN□□1504□	CDH6N	DHA1/4-21	SD43D	SP4D	HW31.8L HW23.8L	3
S40T-MDUNR/L-15-3	50	40	38	300	27	60							
A32S-MDUNR/L-15-3	40	32	30	250	22	50							

➔ Applicable inserts B43~B48

## MSKNR/L



SN□□



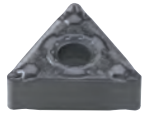
• R type insert (mm)

Designation	ØD	Ød	H	L	S	ℓ	Insert	Clamp	Clamp Screw	Shim	Shim Pin	Wrench	Fig.
S25R-MSKNR/L-12	32	25	23	200	17	40	SN□□1204□	CDH8N1	DHA5/16-28	SS43D	SP4D	HW39.7L HW23.8L	3
S32S-MSKNR/L-12	40	32	30	250	22	50							
S40T-MSKNR/L-12	50	40	38	300	27	60	SN□□1204□	CDH8N1	DHA5/16-28	-	SP4DS	HW39.7L	1
A25R-MSKNR/L-12	32	25	23	200	17	40							
A32S-MSKNR/L-12	40	32	30	250	22	50							
A40T-MSKNR/L-12	50	40	38	300	27	60							

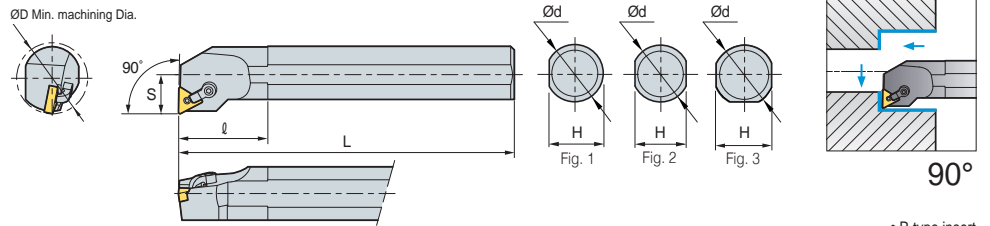
➔ Applicable inserts B50~B57



## MTFNR/L



TN□□



• R type insert (mm)

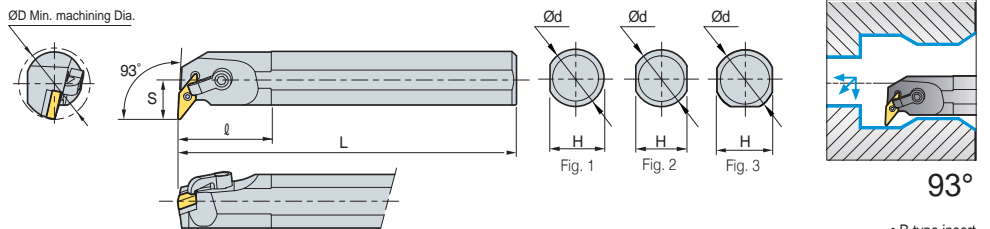
Designation	ØD	Ød	H	L	S	ℓ	Insert	Clamp	Clamp Screw	Shim	Shim Pin	Wrench	Fig.
S25R-MTFNR/L-16	32	25	23	200	17	40	TN□□1604□	CDH7N1	DHA10-32-19	-	SP3D3	HW23.8L	3
S32S-MTFNR/L-16	40	32	30	250	22	50		CDH7N1	DHA10-32-19	ST32D	SP3D	HW19.8L	
S40T-MTFNR/L-16	50	40	38	300	27	60		CDH7N1	DHA10-32-19	ST32D	SP3D	HW19.8L	
A25R-MTFNR/L-16	32	25	24	200	17	40	TN□□1604□	CDH7N1	DHA10-32-19	-	SP3D3	HW23.8L	1
A32S-MTFNR/L-16	40	32	30	250	22	50		CDH7N1	DHA10-32-19	ST32D	SP3D	HW19.8L	3

➔ Applicable inserts B58-B65

## MVUNR/L



VN□□

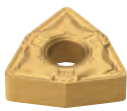


• R type insert (mm)

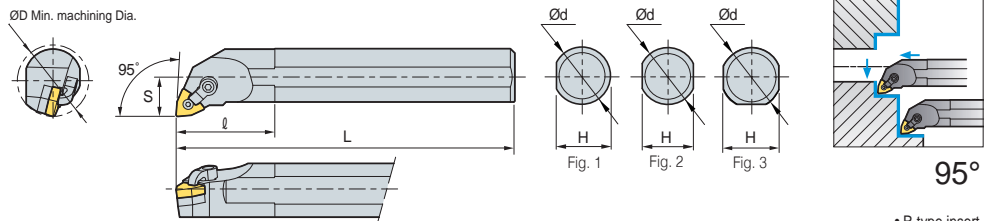
Designation	ØD	Ød	H	L	S	ℓ	Insert	Clamp	Clamp Screw	Shim	Shim Pin	Wrench	Fig.
S32S-MVUNR/L-16	40	32	30	250	22	50	VN□□1604□	CDH8N2	DHA5/16-28	SV32D	SP3D	HW39.7L	3
S40T-MVUNR/L-16	50	40	38	300	27	60		CDH8N2	DHA5/16-28	SV32D	SP3D	HW19.8L	
A32S-MVUNR/L-16	40	32	30	250	22	50	VN□□1604□	CDH8N2	DHA5/16-28	SV32D	SP3D	HW39.7L	3
A40T-MVUNR/L-16	50	40	38	300	27	60		CDH8N2	DHA5/16-28	SV32D	SP3D	HW19.8L	

➔ Applicable inserts B66-B67

## MWLNR/L



WN□□



• R type insert (mm)

Designation	ØD	Ød	H	L	S	ℓ	Insert	Clamp	Clamp Screw	Shim	Shim Pin	Wrench	Fig.
S25R-MWLNR/L-06	32	25	23	200	17	40	WN□□0604□	CDH7N	DHA10/32-19	-	SP3D3	HW23.8L	3
S32S-MWLNR/L-06	40	32	30	250	22	50		CDH7N	DHA10/32-19	SW32D	SP3D	HW19.8L	
S40T-MWLNR/L-06	50	40	38	300	27	60		CDH7N	DHA10/32-19	SW32D	SP3D	HW19.8L	
S25R-MWLNR/L-08	32	25	23	200	17	40	WN□□0804□	CDH6N	DHA1/4-21	-	SP4DS	HW31.8L	3
S32S-MWLNR/L-08	40	32	30	250	22	50		CDH6N	DHA1/4-21	SW43D	SP4D	HW23.8L	
S40T-MWLNR/L-08	50	40	38	300	27	60		CDH6N	DHA1/4-21	SW43D	SP4D	HW23.8L	
A25R-MWLNR/L-06	32	25	24	200	17	40	WN□□0604□	CDH7N	DHA10/32-19	-	SP3D3	HW31.8L	1
A32S-MWLNR/L-06	40	32	31	250	22	50		CDH7N	DHA10/32-19	SW32D	SP3D	HW19.8L	3
A25R-MWLNR/L-08	32	25	24	200	17	40	WN□□0804□	CDH6N	DHA1/4-21	-	SP4DS	HW31.8L	1
A32S-MWLNR/L-08	40	32	31	250	22	50		CDH6N	DHA1/4-21	SW43D	SP4D	HW23.8L	3

➔ Applicable inserts B68-B72

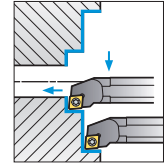
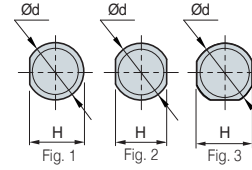
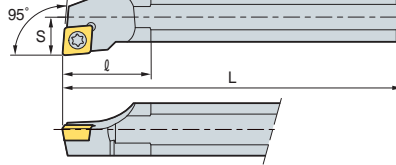
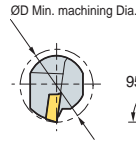




# SCLCR/L



CC□T



95°

• R type insert  
(mm)

## Steel shank type

Designation	ØD	Ød	H	L	S	l	Insert	Screw	Shim	Shim Screw	Wrench	Fig.
S08K-SCLCR/L-06	11	8	7.2	125	6	12	CC□T0602□□	FTKA02555	-	-	TW07	2
S10K-SCLCR/L-06	13	10	9	125	6	16		FTKA02565	-	-	TW07P	
S10M-SCLCR/L-06	13	10	9	150	6	16						
S12M-SCLCR/L-06	16	12	11	150	9	20						
S16R-SCLCR/L-06	20	16	14	200	11	25						
S12M-SCLCR/L-09	16	12	11	150	9	20	CC□T09T3□□	FTGA03508	-	-	TW15P	2
S16R-SCLCR/L-09	20	16	14	200	11	25		FTGA03510	-	-	TW15P	3
S20S-SCLCR/L-09	25	20	18	250	13	32						
S25R-SCLCR/L-09	32	25	23	200	17	40	CC□T1204□□	FTGA0411F	SC42S	SHXN0610F	HW40L TW15P	3
S25R-SCLCR/L-12	32	25	23	200	17	40						
S32S-SCLCR/L-12	40	32	30	250	22	50	CC□T1204□□	FTGA0411F	SC42S	SHXN0610F	HW40L, TW15P	3
S40T-SCLCR/L-12	50	40	38	300	27	60						
A08F-SCLCR/L-06	11	8	7.6	80	6	12						
A10H-SCLCR/L-06	13	10	9.5	100	7	16	CC□T0602□□	FTKA02555	-	-	TW07P	1
A12K-SCLCR/L-06	16	12	11.5	125	9	20		FTKA02565	-	-	TW07P	
A12K-SCLCR/L-09	16	12	11.5	125	9	20	CC□T09T3□□	FTGA03508	-	-	TW15P	1
A16M-SCLCR/L-09	20	16	15	150	11	25						
A20Q-SCLCR/L-09	25	20	19	180	13	32						
A25R-SCLCR/L-09	32	25	24	200	17	40		FTGA03510	-	-	TW15P	
A25R-SCLCR/L-12	32	25	24	200	17	40		FTGA0411F	-	-	TW15P	
A32S-SCLCR/L-12	40	32	31	250	22	50	FTGA0411F	SC42S	SHXN0610F	HW40L, TW15P	3	

## Carbide shank type

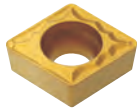
Designation	ØD	Ød	H	L	S	Insert	Screw	Wrench	Fig.	
C04G-SCLCR/L-03	5	4	3.8	90	2.5	CC□T0301□□	FTNA01633	TW06P	1	
C05H-SCLCR/L-03	6	5	4.4	100	3					
C06H-SCLCR/L-04	7	6	5.4	100	3.5	CC□T0401□□	FTNA0238	TW06P		
C07K-SCLCR/L-04	8	7	6.4	125	4	CC□T0602□□	FTKA02555	TW07P	2	
C08K-SCLCR/L-06	10	8	7	125	5					
C10K-SCLCR/L-06	12	10	9	125	6					
C10M-SCLCR/L-06	12	10	9	150	6					
C12M-SCLCR/L-06	14	12	11	150	9					
C12Q-SCLCR/L-06	14	12	11	180	9	CC□T09T3□□	FTGA03508	TW15P	2	
C12M-SCLCR/L-09	15	12	11	150	8					
C12Q-SCLCR/L-09	15	12	11	180	8					
C16R-SCLCR/L-09	20	16	15	200	11					
C16S-SCLCR/L-09	20	16	15	250	11					
C20R-SCLCR/L-09	25	20	18	200	13	CC□T1204□□	FTGA0411F	TW15P	1	
C20S-SCLCR/L-09	25	20	18	250	13					
C25T-SCLCR/L-12	32	25	23	300	17					
E06H-SCLCR/L-04	7	6	5.4	100	3.5	CC□T0401□□	FTNA0238	TW06P	1	
E07K-SCLCR/L-04	8	7	6.4	125	4					
E08K-SCLCR/L-06	10	8	7	125	5	CC□T0602□□	FTKA02555	TW07P		2
E10K-SCLCR/L-06	12	10	9	125	6					
E10M-SCLCR/L-06	12	10	9	150	6					
E12M-SCLCR/L-06	14	12	11	150	9					
E12Q-SCLCR/L-06	14	12	11	180	9					
E12M-SCLCR/L-09	15	12	11	150	8	CC□T09T3□□	FTGA03508	TW15P	2	
E12Q-SCLCR/L-09	15	12	11	180	8					
E16R-SCLCR/L-09	20	16	15	200	11					
E16S-SCLCR/L-09	20	16	15	250	11					
E20R-SCLCR/L-09	25	20	18	200	13					
E20S-SCLCR/L-09	25	20	19	250	13	CC□T1204□□	FTGA0411F	TW15P	1	
E25T-SCLCR/L-12	32	25	23	300	17					

➔ Applicable inserts B73~B77, B103

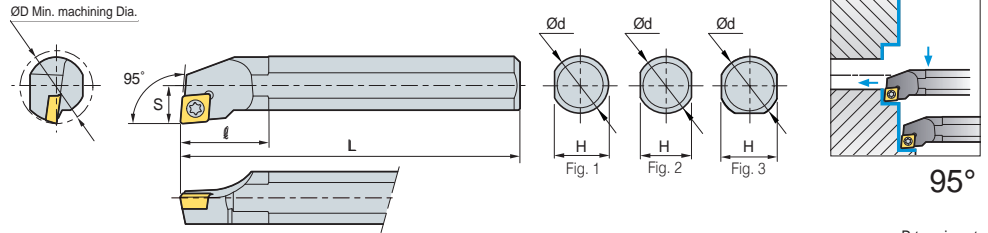




## SCLPR/L



CP□T



### Steel shank type

• R type insert (mm)

Designation	ØD	Ød	H	L	S	ℓ	Insert	Screw	Wrench	Fig.
S10M-SCLPR/L-08	13	10	9	150	7	16	CP□T0802□□	FTNA0305	TW09P	2
S12M-SCLPR/L-08	16	12	11	150	9	20		FTNA0307	TW09P	
S16N-SCLPR/L-09	20	16	14	160	11	25	CP□T0903□□	FTNA0408	TW15P	2
S16R-SCLPR/L-09	20	16	14	200	11	25				
S20N-SCLPR/L-09	25	20	18	160	13	32				
S20S-SCLPR/L-09	25	20	18	250	13	32				3
A10H-SCLPR/L-08	12	10	9.65	100	6	-	CP□T0802□□	FTNA0305	TW09P	1
A12K-SCLPR/L-08	16	12	11.5	125	9	20		FTNA0307	TW09P	
A16M-SCLPR/L-09	20	16	15.5	150	10	25	CP□T0903□□	FTNA0408	TW15P	1
A20Q-SCLPR/L-09	25	20	19	180	13	32				3

### Carbide shank type

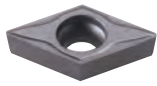
(mm)

Designation	ØD	Ød	H	L	S	ℓ	Insert	Screw	Wrench	Fig.
C10K-SCLPR/L-08	12	10	9	125	6	14.5	CP□T0802□□	FTNA0305	TW09P	2
C10M-SCLPR/L-08	12	10	9	150	6	14.5				
C12M-SCLPR/L-08	15	12	11	150	7.5	14.7		FTNA0306	TW09P	
C12Q-SCLPR/L-08	15	12	11	180	7.5	14.7				
C12M-SCLPR/L-09	15	12	11	150	8	14.4	CP□T0903□□	FTNA0408	TW15P	2
C12Q-SCLPR/L-09	15	12	11	180	8	14.4				
C16R-SCLPR/L-09	20	16	15	200	10	22.4				
C16S-SCLPR/L-09	20	16	15	250	10	22.4				
C20R-SCLPR/L-09	25	20	18	200	13	22.5				
C20S-SCLPR/L-09	25	20	18	250	13	22.5				
E10K-SCLPR/L-08	12	10	9	125	6	14.5	CP□T0802□□	FTNA0305	TW09P	2
E10M-SCLPR/L-08	12	10	9	150	6	14.5				
E12M-SCLPR/L-08	15	12	11	150	7.5	14.7				
E12Q-SCLPR/L-08	15	12	11	180	7.5	14.7		FTNA0407	TW09P	
E12M-SCLPR/L-09	15	12	11	150	8	14.4				
E12Q-SCLPR/L-09	15	12	11	180	8	14.4				
E16R-SCLPR/L-09	20	16	15	200	10	22.4	CP□T0903□□	FTNA0408	TW15P	2
E16S-SCLPR/L-09	20	16	15	250	10	22.4				
E20R-SCLPR/L-09	25	20	18	200	13	22.5				
E20S-SCLPR/L-09	25	20	18	250	13	22.5				

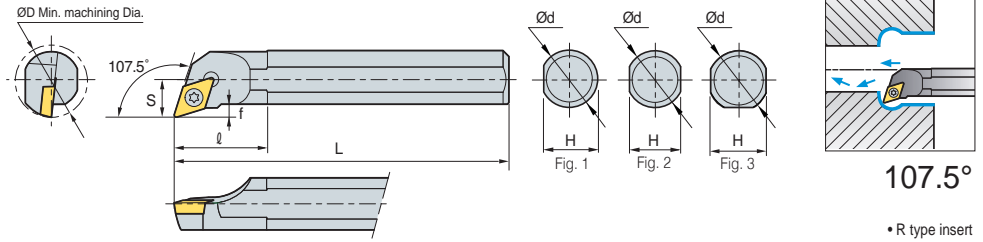
Applicable inserts B78



# SDQCR/L



DC□T



## Steel shank type

\* R type insert (mm)

Designation	ØD	Ød	H	L	S	ℓ	Insert	Screw	Wrench	Fig.
S10M-SDQCR/L-07	13	10	9	150	7	16	DC□T0702□□	FTKA02555	TW07P	2
S12M-SDQCR/L-07	16	12	11	150	9	20		FTKA02565	TW07P	
S16R-SDQCR/L-07	20	16	14	200	11	25				
S16R-SDQCR/L-11	20	16	14	200	11	25	DC□T11T3□□	FTGA03508	TW15P	2
S20S-SDQCR/L-11	25	20	18	250	13	32		FTGA03510	TW15P	
S25R-SDQCR/L-11	32	25	23	200	17	40				
A10H-SDQCR/L-07	13	10	9.5	100	7	16	DC□T0702□□	FTKA02555	TW07P	1
A12K-SDQCR/L-07	16	12	11.5	125	9	20		FTKA02565	TW07P	1
A16M-SDQCR/L-11	20	16	15	150	11	25	DC□T11T3□□	FTGA03508	TW15P	1
A20Q-SDQCR/L-11	25	20	19	180	13	32				
A25R-SDQCR/L-11	32	25	24	200	17	40		FTGA03510	TW15P	

## Carbide shank type

(mm)

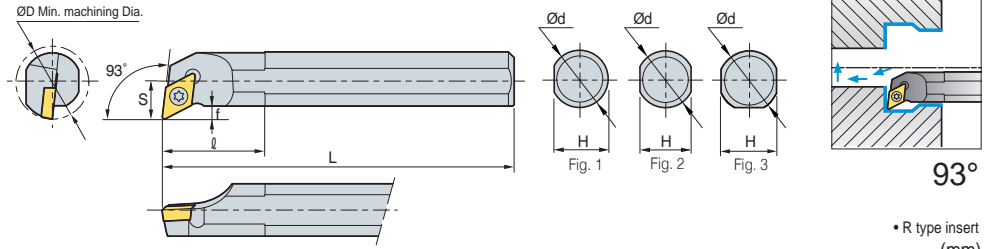
Designation	ØD	Ød	H	L	S	ℓ	Insert	Screw	Wrench	Fig.
C08K-SDQCR/L-07	11	8	7	125	6	-	DC□T0702□□	FTKA02555	TW07P	2
C10K-SDQCR/L-07	13	10	9	125	7	14.0		FTKA02565	TW07P	
C12M-SDQCR/L-07	16	12	11	150	9	14.0				
C16R-SDQCR/L-07	20	16	15	200	11	-				
C16R-SDQCR/L-11	20	16	15	200	11	21.3	DC□T11T3□□	FTGA03508	TW15P	2
C20R-SDQCR/L-11	25	20	18	200	13	24.0				
C20S-SDQCR/L-11	25	20	18	250	13	24.0				
E08K-SDQCR/L-07	11	8	7	125	6	-	DC□T0702□□	FTKA02555	TW07P	2
E10K-SDQCR/L-07	13	10	9	125	7	14.0		FTKA02565	TW07P	
E12M-SDQCR/L-07	16	12	11	150	9	14.0				
E16R-SDQCR/L-07	20	16	15	200	11	-				
E16R-SDQCR/L-11	20	16	15	200	11	21.3	DC□T11T3□□	FTGA03508	TW15P	2
E20R-SDQCR/L-11	25	20	18	200	13	24.0				
E20S-SDQCR/L-11	25	20	19	250	13	24.0				

Applicable inserts B79-B82, B103

## SDUCR/L



DC□T



### Steel shank type

Designation	ØD	Ød	H	L	S	ℓ	Insert	Screw	Wrench	Fig.
S10M-SDUCR/L-07	13	10	9	150	7	16	DC□T0702□□	FTKA02555	TW07P	2
S12M-SDUCR/L-07	16	12	11	150	9	20		FTKA02565	TW07P	2
S16R-SDUCR/L-07	20	16	14	200	11	25		DC□T11T3□□	FTGA03508	TW15P
S16R-SDUCR/L-11	20	16	14	200	11	25	FTGA03510		TW15P	3
S20S-SDUCR/L-11	25	20	18	250	13	32	DC□T11T3□□		FTKA02555	TW07P
S25R-SDUCR/L-11	32	25	23	200	17	40		FTKA02565	TW07P	1
S32S-SDUCR/L-11	40	32	30	250	22	50		FTGA03508	TW15P	1
A25R-SDUCR/L-11	32	25	24	200	17	40	FTGA03510	TW15P	1	

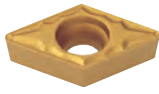
### Carbide shank type

Designation	ØD	Ød	H	L	S	ℓ	Insert	Screw	Wrench	Fig.
C10K-SDUCR/L-07	13	10	9	125	7	9.8	DC□T0702□□	FTKA02555	TW07P	2
C10M-SDUCR/L-07	13	10	9	150	7	9.8		FTKA02565	TW07P	
C12M-SDUCR/L-07	16	12	11	150	9	11.0		DC□T11T3□□	FTGA03508	
C12Q-SDUCR/L-07	16	12	11	180	9	11.0	FTGA03510		TW15P	
C16R-SDUCR/L-07	20	16	15	200	11	-	DC□T0702□□		FTKA02555	TW07P
C16S-SDUCR/L-07	20	16	15	250	11	-		FTKA02565	TW07P	
C16R-SDUCR/L-11	20	16	15	200	11	-		DC□T11T3□□	FTGA03508	TW15P
C16S-SDUCR/L-11	20	16	15	250	11	-	FTGA03510		TW15P	
C20R-SDUCR/L-11	25	20	18	200	13	-	DC□T0702□□		FTKA02555	TW07P
C20S-SDUCR/L-11	25	20	18	250	13	-		FTKA02565	TW07P	
C25T-SDUCR/L-11	32	25	23	300	17	-		DC□T11T3□□	FTGA03508	TW15P
E10K-SDUCR/L-07	13	10	9	125	7	9.8	FTGA03510		TW15P	
E10M-SDUCR/L-07	13	10	9	150	7	9.8	DC□T0702□□		FTKA02555	TW07P
E12M-SDUCR/L-07	16	12	11	150	9	11.0		FTKA02565	TW07P	
E12Q-SDUCR/L-07	16	12	11	180	9	11.0		DC□T11T3□□	FTGA03508	TW15P
E16R-SDUCR/L-07	20	16	15	200	11	-	FTGA03510		TW15P	
E16S-SDUCR/L-07	20	16	15	250	11	-	DC□T11T3□□		FTGA03508	TW15P
E16R-SDUCR/L-11	20	16	15	200	11	-		FTGA03510	TW15P	
E16S-SDUCR/L-11	20	16	15	250	11	-		DC□T11T3□□	FTGA03508	TW15P
E20R-SDUCR/L-11	25	20	18	200	13	-	FTGA03510		TW15P	
E20S-SDUCR/L-11	25	20	18	250	13	-	DC□T11T3□□		FTGA03508	TW15P
E25T-SDUCR/L-11	32	25	23	300	17	-		FTGA03510	TW15P	

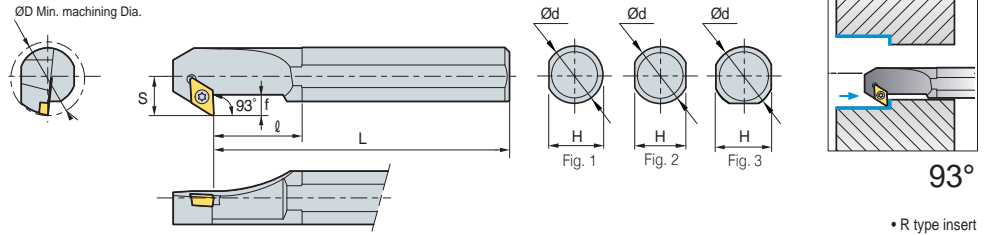
Applicable inserts B79-B82, B104



# SDZCR/L



DC□T

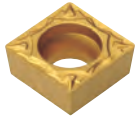


• R type insert (mm)

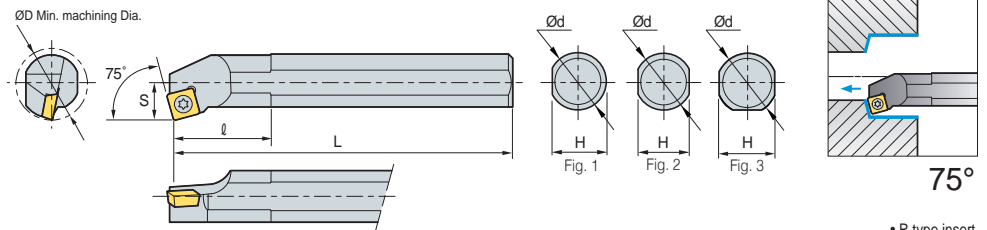
Designation	ØD	Ød	H	L	S	ℓ	f	Insert	Screw	Shim	Shim Screw	Wrench	Fig.
S16R-SDZCR/L-07	20	16	14	200	11	25	6.5	DC□T0702□□	FTKA02565	-	-	TW07P	2
S20S-SDZCR/L-07	25	20	18	250	13	32	7.5						
S25R-SDZCR/L-11	32	25	23	200	17	40	9	DC□T11T3□□	FTGA03510	-	-	TW15P	3
S32S-SDZCR/L-11	40	32	30	250	22	50	11		FTGA03512	SD32S	SHXN0509F	TW15P, HW35L	
S40T-SDZCR/L-11	50	40	38	300	27	60	11		FTGA03510	-	-	TW15P	1
A25R-SDZCR/L-11	32	25	24	200	17	40	9		FTGA03512	SD32S	SHXN0509F	TW15P, HW35L	3

↻ Applicable inserts B79~B82, B104

# SSKCR/L



SC□T



• R type insert (mm)

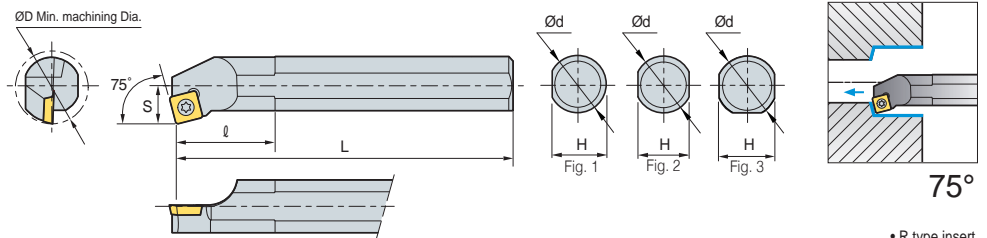
Designation	ØD	Ød	H	L	S	ℓ	Insert	Screw	Shim	Shim Screw	Wrench	Fig.
S12M-SSKCR/L-09	16	12	11	150	9	20	SC□T09T3□□	FTGA03507	-	-	TW15P	2
S16R-SSKCR/L-09	20	16	14	200	11	25		FTGA03508	-	-	TW15P	
S20S-SSKCR/L-09	25	20	18	250	13	32	SC□T1204□□	FTGA0411F	-	-	TW15P	3
S25R-SSKCR/L-12	32	25	23	200	17	40		FTGA0411F	SS42S	SHXN0610F	TW15P, HW40L	
S32S-SSKCR/L-12	40	32	30	250	22	50	SC□T09T3□□	FTGA03507	-	-	TW15P	1
A12K-SSKCR/L-09	16	12	11.5	125	9	20		FTGA03508	-	-	TW15P	
A16M-SSKCR/L-09	20	16	15	150	11	25	SC□T1204□□	FTGA0411F	-	-	TW15P	3
A20Q-SSKCR/L-09	25	20	19	180	13	32		FTGA0411F	SS42S	SFXN0610F	TW15P, HW40L	

↻ Applicable inserts B84, B106

# SSKPR/L



SP□T



• R type insert (mm)

Designation	ØD	Ød	H	L	S	ℓ	Insert	Screw	Wrench	Fig.
S12M-SSKPR/L-09	16	12	11	150	9	20	SP□T09T3□□	FTNA0307	TW09P	2
S16N-SSKPR/L-09	20	16	14	160	11	25				
S16R-SSKPR/L-09	20	16	14	200	11	25				
S20N-SSKPR/L-09	25	20	18	160	13	32				
S20S-SSKPR/L-09	25	20	18	250	13	32				
A12K-SSKPR/L-09	16	12	11.5	125	9	20	SP□T09T3□□	FTNA0307	TW09P	1
A16M-SSKPR/L-09	20	16	15	150	11	25				
A20Q-SSKPR/L-09	25	20	19	180	13	32				

↻ Applicable inserts B85~B86

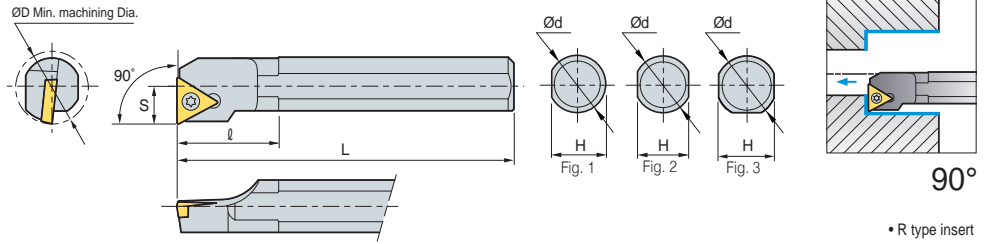
• Use left handed insert for right handed holder



## STFCR/L



TC□T



• R type insert (mm)

### Steel shank type

Designation	ØD	Ød	H	L	S	ℓ	Insert	Screw	Shim	Shim Screw	Wrench	Fig.
S10M-STFCR/L-09	13	10	9	150	7	16	TC□T0902□□	FTKA02206	-	-	TW06P	2
S12M-STFCR/L-09	16	12	11	150	9	20						
S12M-STFCR/L-11	16	12	11	150	9	20						
S16R-STFCR/L-11	20	16	14	200	11	25	TC□T1102□□	FTKA02565	-	-	TW07P	2
S20S-STFCR/L-11	25	20	18	250	13	32						
S20S-STFCR/L-16	25	20	18	250	13	32	TC□T16T3□□	FTGA03510	-	-	TW15P	2
S25R-STFCR/L-16	32	25	23	200	17	40						3
S32S-STFCR/L-16	40	32	30	250	22	50	TC□T16T3□□	FTGA03512	ST32S	SHXN0509F	TW15P, HW35L	3
S40T-STFCR/L-16	50	40	38	300	27	60						
A10H-STFCR/L-09	13	10	9.5	100	7	16	TC□T0902□□	FTKA02206	-	-	TW06P	1
A12K-STFCR/L-09	16	12	11.5	125	9	20						
A12K-STFCR/L-11	16	12	11.5	125	9	20						
A16M-STFCR/L-11	20	16	15	150	11	25	TC□T1102□□	FTKA02565	-	-	TW07P	1
A20Q-STFCR/L-11	25	20	19	180	13	32						
A25R-STFCR/L-16	32	25	24	200	17	40	TC□T16T3□□	FTKA03510	-	-	TW15P	1
A32S-STFCR/L-16	40	32	30	250	22	50						

### Carbide shank type

Designation	ØD	Ød	H	L	S	ℓ	Insert	Screw	Wrench	Fig.
C08K-STFCR/L-09	10	8	7	125	5	-	TC□T0902□□	FTKA02206	TW06P	2
C10K-STFCR/L-09	12	10	9	125	6	14.0				
C10K-STFCR/L-11	12	10	9	125	6	12.5				
C12M-STFCR/L-11	15	12	11	150	8	-	TC□T1102□□	FTKA02565	TW07P	2
C16R-STFCR/L-11	20	16	15	200	10	-				
C20R-STFCR/L-11	25	20	18	200	13	23.0				
C20S-STFCR/L-11	25	20	18	250	13	23.0				
C20R-STFCR/L-16	25	20	18	200	13	-	TC□T16T3□□	FTGA03510	TW15P	2
C20S-STFCR/L-16	25	20	18	250	13	-				
E08K-STFCR/L-09	10	8	7	125	5	-	TC□T0902□□	FTKA02206	TW06P	2
E10K-STFCR/L-09	12	10	9	125	6	14.0				
E10K-STFCR/L-11	12	10	9	125	6	12.5				
E12M-STFCR/L-11	15	12	11	150	8	-	TC□T1102□□	FTKA02565	TW07P	2
E16R-STFCR/L-11	20	16	15	200	11	-				
E20R-STFCR/L-11	25	20	18	200	13	23.0				
E20S-STFCR/L-11	25	20	18	250	13	23.0				
E20R-STFCR/L-16	25	20	18	200	13	-	TC□T16T3□□	FTGA03510	TW15P	2
E20S-STFCR/L-16	25	20	19	250	13	-				

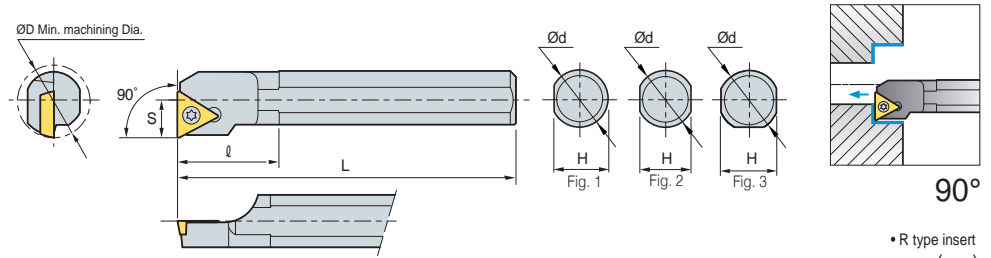
Applicable inserts B88-B89, B107



# STFPR/L



TP□T



• R type insert (mm)

## Steel shank type

Designation	ØD	Ød	H	L	S	l	Insert	Screw	Wrench	Fig.
S10M-STFPR/L-11	13	10	9	150	7	16	TP□T1103□□	FTNA0306	TW09P	2
S12M-STFPR/L-11	16	12	11	150	9	20		FTNA0307	TW09P	2
S16N-STFPR/L-11	20	16	14	160	11	25				
S16R-STFPR/L-11	20	16	14	200	11	25				
S20N-STFPR/L-16	25	20	18	160	13	32	TP□T1604□□	FTNA0408	TW15P	2
S20S-STFPR/L-16	25	20	18	250	13	32				
A10H-STFPR/L-11	13	10	9.5	100	7	16	TP□T1103□□	FTNA0306	TW09P	1
A12K-STFPR/L-11	16	12	11	125	9	20		FTNA0307	TW09P	1
A16M-STFPR/L-11	20	16	15	150	11	25				
A20Q-STFPR/L-16	25	20	19	180	13	32	TP□T1604□□	FTNA0408	TW15P	1

## Carbide shank type

Designation	ØD	Ød	H	L	S	l	Insert	Screw	Wrench	Fig.
C08K-STFPR/L-08	10	8	7	125	5	13.7	TP□T1103□□	FTNA02205	TW06P	2
C10K-STFPR/L-11	12	10	9	125	6	14.0		FTNA0305	TW09P	
C10M-STFPR/L-11	12	10	9	150	6	14.0				
C12M-STFPR/L-11	15	12	11	150	8	-				
C12Q-STFPR/L-11	15	12	11	180	8	-				
C16R-STFPR/L-11	20	16	15	200	10	-				
C16S-STFPR/L-11	20	16	15	250	10	-				
C20R-STFPR/L-11	25	20	18	200	13	-				
C20S-STFPR/L-11	25	20	18	250	13	-				
C20R-STFPR/L-16	25	20	18	200	13	-				
C20S-STFPR/L-16	25	20	18	250	13	-	TP□T1604□□	FTNA0408	TW15P	
C25T-STFPR/L-16	32	25	23	300	17	23.5				
E08K-STFPR/L-08	10	8	7	125	5	13.7	TP□T1103□□	FTNA02205	TW06P	2
E10K-STFPR/L-11	12	10	9	125	6	14.0		FTNA0305	TW09P	
E10M-STFPR/L-11	12	10	9	150	6	14.0				
E12M-STFPR/L-11	15	12	11	150	8	-				
E12Q-STFPR/L-11	15	12	11	180	8	-				
E16R-STFPR/L-11	20	16	15	200	10	-				
E16S-STFPR/L-11	20	16	15	250	10	-				
E20R-STFPR/L-11	25	20	18	200	13	-				
E20S-STFPR/L-11	25	20	18	250	13	-				
E20R-STFPR/L-16	25	20	18	200	13	-				
E20S-STFPR/L-16	25	20	18	250	13	-	TP□T1604□□	FTNA0408	TW15P	
E25T-STFPR/L-16	32	25	23	300	17	23.5				

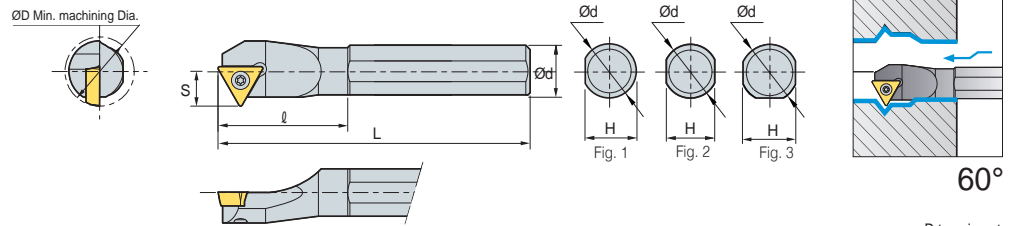
Applicable inserts **B90~B93**

• Use left handed insert for right handed holder

## STWPR/L



TP□□



60°

• R type insert (mm)

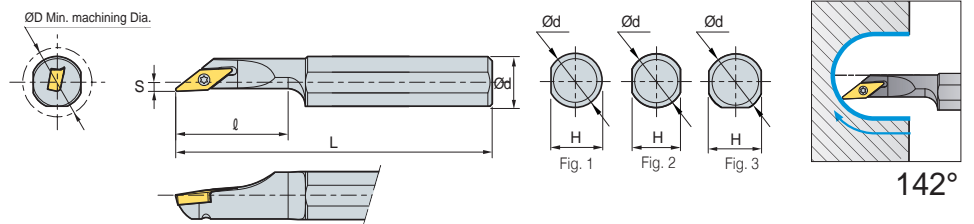
Designation	ØD	Ød	H	L	S	ℓ	Insert	Screw	Wrench	Fig.
S10M-STWPR/L-11	13	10	7	150	7	16	TPGH1102□□	FTNA0305	TW09P	2
S12M-STWPR/L-11	16	12	9	150	9	20	TPGH1103□□ TPMT1103□□	FTNA0306	TW09P	
S16Q-STWPR/L-11	20	16	14	180	11	25				
S20R-STWPR/L-11	25	20	18	200	13	32				

➔ Applicable inserts B90-B93

## SVJCR/L



VC□□



142°

• R type insert (mm)

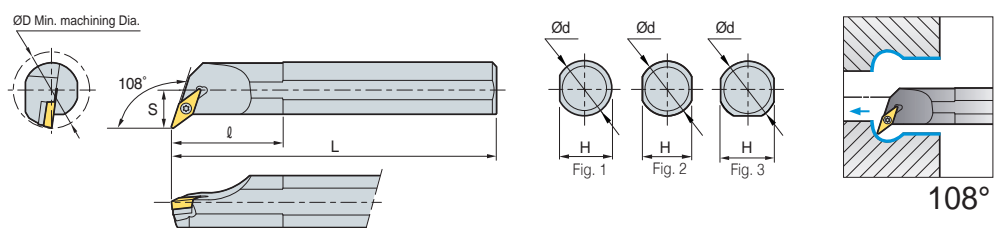
Designation	ØD	Ød	H	L	S	ℓ	Insert	Screw	Wrench	Fig.
S12M-SVJCR/L-08	16	12	11	150	2	26	VCMT0802□□	FTNA0204	TW06P	2
S16Q-SVJCR/L-08	20	16	15	180	2	36				

➔ Applicable inserts B97-B99, B109

## SVQBR/L



VB□T



108°

• R type insert (mm)

Designation	ØD	Ød	H	L	S	ℓ	Insert	Screw	Shim	Shim Screw	Wrench	Fig.
S32S-SVQBR/L-16	40	32	30	250	22	50	VB□T1604□□	FTGA03512	SV32S	SHXN0509F	TW15P HW35L	3
S40T-SVQBR/L-16	50	40	38	300	27	60						
A32S-SVQBR/L-16	40	32	30	250	22	50						

➔ Applicable inserts B94-B96, B108

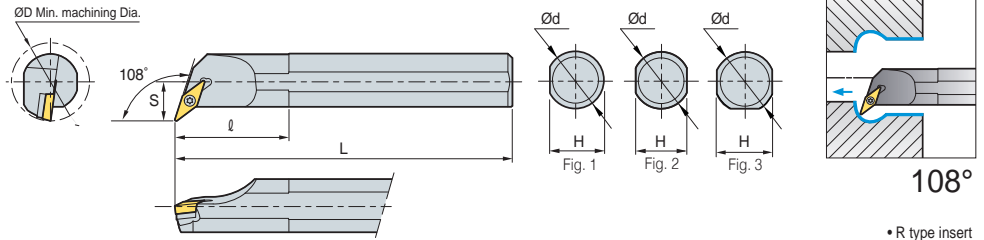




# SVQCR/L



VC□T



\* R type insert (mm)

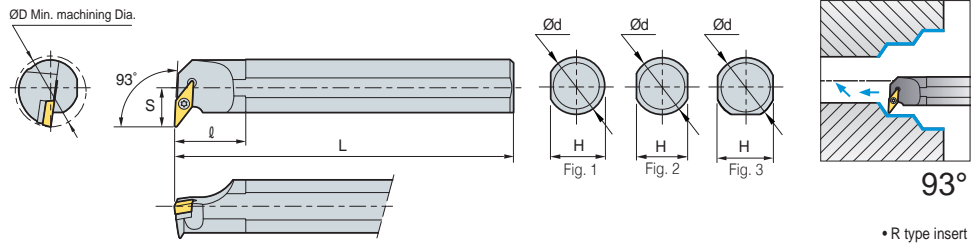
Designation	ØD	Ød	H	L	S	ℓ	Insert	Screw	Shim	Shim Screw	Wrench	Fig.
S16R-SVQCR/L-11	20	16	14	200	11	25	VC□T1103□□	FTKA02565	-	-	TW07P	2
S20S-SVQCR/L-11	25	20	18	250	13	32						3
S25R-SVQCR/L-11	32	25	23	200	17	40	VC□T1303□□	FTKA0307	-	-	TW07P	2
S20S-SVQCR/L-13	25	20	18	250	13	32						3
S25R-SVQCR/L-13	32	25	23	200	17	40	VC□T1604□□	FTGA03510	-	-	TW15P	3
S25R-SVQCR/L-16	32	25	23	200	17	40		FTGA03512	SV32S	SHXN0509F	TW15P HW35L	
S32S-SVQCR/L-16	40	32	30	250	22	50						
S40T-SVQCR/L-16	50	40	38	300	27	60						

↻ Applicable inserts B97~B99, B109

# SVUBR/L



VB□T



\* R type insert (mm)

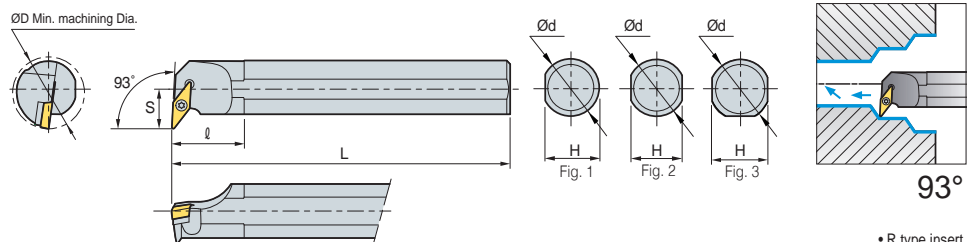
Designation	ØD	Ød	H	L	S	ℓ	Insert	Screw	Shim	Shim Screw	Wrench	Fig.
S32S-SVUBR/L-16	40	32	30	250	22	50	VB□T1604□□	FTGA03512	SV32S	SHXN0509F	TW15P HW35L	3
S40T-SVUBR/L-16	50	40	38	300	27	60						
A32S-SVUBR/L-16	40	32	30	250	22	50						

↻ Applicable inserts B94~B96, B108

# SVUCR/L



VC□T



\* R type insert (mm)

Designation	ØD	Ød	H	L	S	ℓ	Insert	Screw	Shim	Shim Screw	Wrench	Fig.
S16R-SVUCR/L-11	22	16	14	200	13	25	VC□T1103□□	FTKA02565	-	-	TW07P	2
S20S-SVUCR/L-11	25	20	18	250	13	32						3
S25T-SVUCR/L-11	32	25	23	300	17	40	VC□T1303□□	FTKA0307	-	-	TW09P	2
S20S-SVUCR/L-13	25	20	18	250	13	32						3
S25R-SVUCR/L-13	32	25	23	200	17	40	VC□T1604□□	FTGA03510	-	-	TW15P	3
S25R-SVUCR/L-16	32	25	23	200	17	40		FTGA03512	SV32S	SHXN0509F	TW15P HW35L	
S32S-SVUCR/L-16	40	32	30	250	22	50						
S40T-SVUCR/L-16	50	40	38	300	27	60						

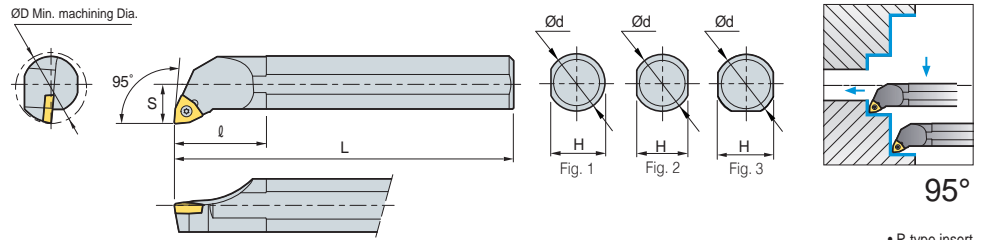
↻ Applicable inserts B97~B99, B109

# B Screw on System

## SWLCR/L



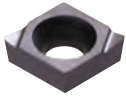
WC□T



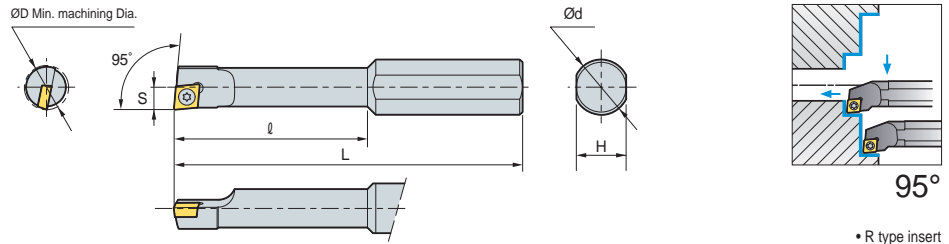
Designation	ØD	Ød	H	L	S	ℓ	Insert	Screw	Wrench	Fig.
<b>S25R-SWLCR/L-08</b>	32	25	23	200	17	40	WC□T0804□□	FTGA0411F	TW15P	3
<b>S32S-SWLCR/L-08</b>	40	32	30	250	22	50				
<b>A25R-SWLCR/L-08</b>	32	25	24	200	17	40	WC□T0804□□	FTGA0411F	TW15P	1
<b>A32S-SWLCR/L-08</b>	40	32	30	250	22	50				3



# SCLCR/L



CCET



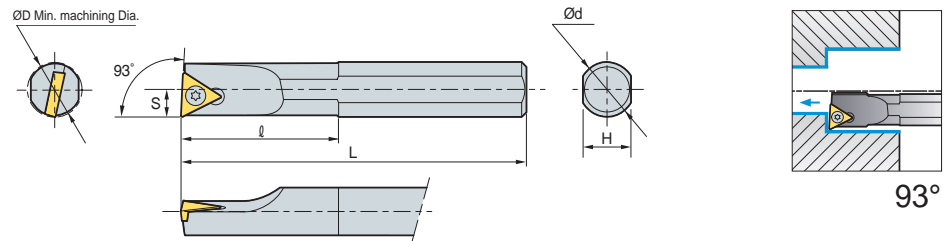
Designation	ØD	Ød	H	L	S	ℓ	Insert	Screw	Wrench
S10H-SCLCR/L-0305	5	10	9	100	2.5	25	CCET0301□□	FTNA01633	TW06P
S10H-SCLCR/L-0306	6	10	9	100	3.0	25			
S10J-SCLCR/L-0407	7	10	9	110	3.5	30	CCET0401□□	FTNA0238	TW06P
S10J-SCLCR/L-0408	8	10	9	110	4.0	30			

↻ Applicable inserts **B73 ~B77, B103** • Use left handed insert for right handed holder

# STUBR/L



TB□□



↻ **Steel shank type**

Designation	ØD	Ød	H	L	S	ℓ	Insert	Screw	Wrench
S08K-STUBR/L-06	8	8	7	125	4	30	TB□□0601□□R/L	FTNA0204	TW06P
A08F-STUBR/L-06	8	8	7.5	80	4	30			

↻ **Carbide shank type**

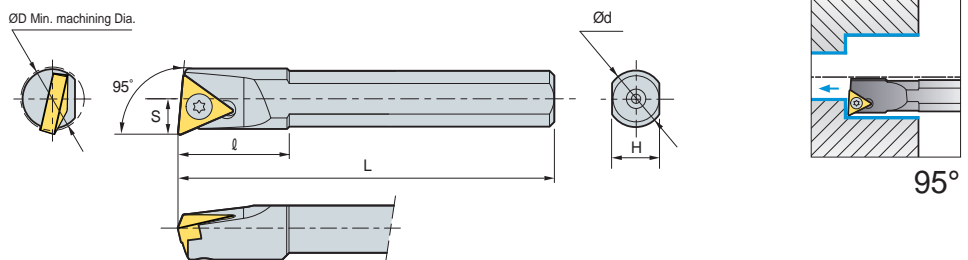
Designation	ØD	Ød	H	L	S	ℓ	Insert	Screw	Wrench
C08K-STUBR/L-06	10	8	7	125	5		TB□T0601□□	FTNA0204	TW06P
C10K-STUBR/L-06	12	10	9	125	6				
E08K-STUBR/L-06	10	8	7	125	5		TB□T0601□□	FTNA0204	TW06P
E10K-STUBR/L-06	12	10	9	125	6				

↻ Applicable inserts **B87** • Use left handed insert for right handed holder

# STLBR/L



TB□□



↻ **Steel shank type**

Designation	ØD	Ød	H	L	S	ℓ	Insert	Screw	Wrench
S06H-STLBR/L-06-SP	8	6	5	100	3.8	12	TB□□0601□□R/L	FTNA0204	TW06P

↻ Applicable inserts **B87** • Use left handed insert for right handed holder

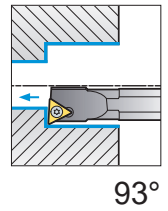
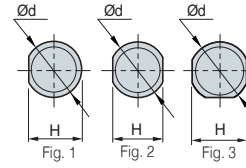
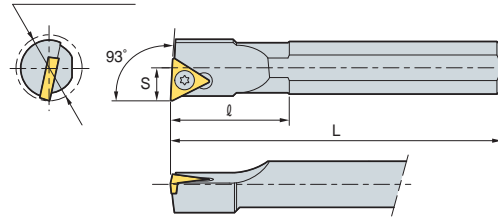


## STUPR/L



TP□□

ØD Min. machining Dia.



93°

### Steel shank type

• R type insert (mm)

Designation	ØD	Ød	H	L	S	ℓ	Insert	Screw	Wrench	Fig.
S08K-STUPR/L-08	10	8	7	125	4	18	TP□□0802□□R/L	FTNA02205	TW06P	2
A08F-STUPR/L-08	10	8	7.5	80	5	18				

### Carbide shank type

(mm)

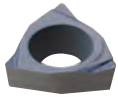
Designation	ØD	Ød	H	L	S	ℓ	Insert	Screw	Wrench	Fig.
C08K-STUPR/L-08	10	8	7	125	5		TP□T0802□□	FTNA02205	TW06P	2
C10K-STUPR/L-11	12	10	9	125	6		TP□T1103□□	FTNA0305	TW09P	
C10M-STUPR/L-11	12	10	9	150	6					
C12M-STUPR/L-11	15	12	11	150	8					
C12Q-STUPR/L-11	15	12	11	180	8					
C16R-STUPR/L-11	20	16	15	200	10					
C16S-STUPR/L-11	20	16	15	250	10					
C20R-STUPR/L-11	25	20	18	200	13					
C20S-STUPR/L-11	25	20	18	250	13					
C20R-STUPR/L-16	25	20	18	200	13					
C20S-STUPR/L-16	25	20	18	250	13		TP□T1604□□	FTNA0408	TW15P	
C25T-STUPR/L-16	32	25	23	300	17					
E08K-STUPR/L-08	10	8	7	125	5		TP□T0802□□	FTNA02205	TW06P	2
E10K-STUPR/L-11	12	10	9	125	6		TP□T1103□□	FTNA0305	TW09P	
E10M-STUPR/L-11	12	10	9	150	6					
E12M-STUPR/L-11	15	12	11	150	8					
E12Q-STUPR/L-11	15	12	11	180	8					
E16R-STUPR/L-11	20	16	15	200	10					
E16S-STUPR/L-11	20	16	15	250	10					
E20R-STUPR/L-11	25	20	18	200	13					
E20S-STUPR/L-11	25	20	18	250	13					
E20R-STUPR/L-16	25	20	18	200	13					
E20S-STUPR/L-16	25	20	18	250	13		TP□T1604□□	FTNA0408	TW15P	
E25T-STUPR/L-16	32	25	23	300	17					

Applicable inserts B90-B93

• Use left handed insert for right handed holder

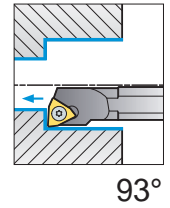
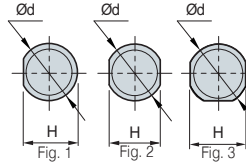
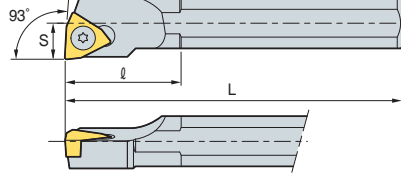


# SWUBR/L



WB□T

∅D Min. machining Dia.



93°

## Steel shank type

• R type insert (mm)

Designation	∅D	∅d	H	L	S	ℓ	Insert	Screw	Wrench	Fig.
S05H-SWUBR/L-02	5.5	5	4.5	100	2.75	-	WBGTO201□□R/L	FTNA0203	TW06P	2
S08K-SWUBR/L-02	8	8	7	125	4	30		FTNA02033		
S08K-SWUBR/L-S3	10	8	7	125	5	18	WBGTS302□□R/L	FTNA02205		
A08F-SWUBR/L-02	8	8	7.5	80	4	30	WBGTO201□□R/L	FTNA0203		
A08F-SWUBR/L-S3	10	8	7.5	80	5	16	WBGTS302□□R/L	FTNA02205		

## Carbide shank type

(mm)

Designation	∅D	∅d	H	L	S	ℓ	Insert	Screw	Wrench	Fig.
C05H-SWUBR/L-02	6	5	4.4	100	3	-	WB□T0201□□	FTNA0203	TW06P	1
C06H-SWUBR/L-02	7	6	5.4	100	3.5	-		FTNA02033		
C08K-SWUBR/L-02	9	8	7	125	4.5	-	WB□TS301□□	FTNA02205	TW06P	2
C08K-SWUBR/L-S3	10	8	7	125	4.5	-		FTNA02205		
E06H-SWUBR/L-02	7	6	5.4	100	3.5	-	WB□T0201□□	FTNA0203	TW06P	1
E08K-SWUBR/L-02	9	8	7	125	4.5	-		FTNA02033		
E08K-SWUBR/L-S3	10	8	7	125	5	-	WB□TS301□□	FTNA02205	TW06P	2

↻ Applicable inserts **B101**

• Use left handed insert for right handed holder



※ See page B151 for applicable sleeves

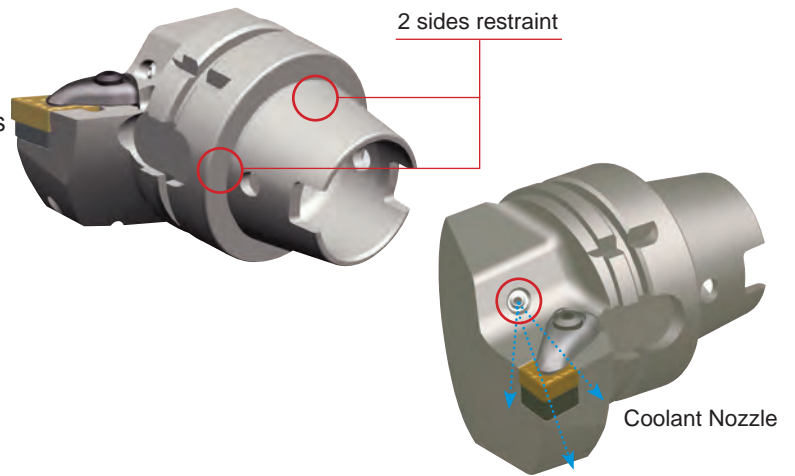


# B Technical Information for HSK Tooling System

2 sides restraint - side and taper part

## HSK Tooling System [For Multi-task Machines]

- 2 sides restraint - side and taper part
- Toughness guaranteed for static and dynamic movements
- Precision guaranteed on shaft and repeat directions
- Suitable at high speeds
- Suitable for small work pieces
- Coolant Nozzle is easily adjustable



### Code system

C: 80° Diamond D: 55° Diamond  
S: 90° Square T: 60° Triangle  
V: 35° Diamond W: 80° Hexagon

N = 0°  
B = 5°

DX: 65  
H: 100  
L: 140

Insert Shape

Clearance angle of insert

Length of tool holder



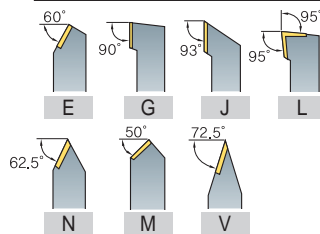
#### Taper design & size

ICTM = HSK standard

#### Clamping Type

D: Double Clamp  
M: Multi Clamp  
P: Lever Lock  
S: Screw On  
W: Wedge Clamp

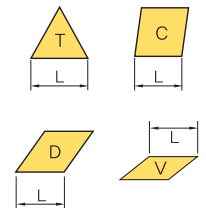
#### Holder Style



#### Hand

R: Right  
L: Left  
N: No Hand

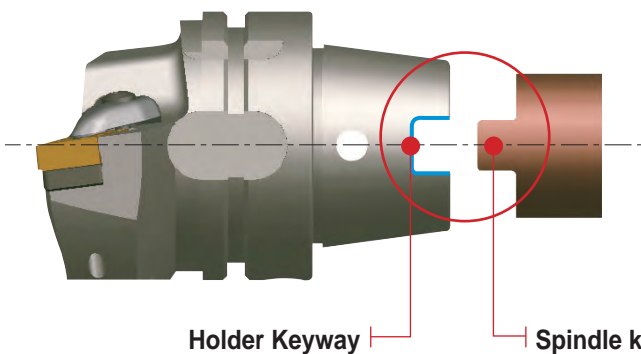
#### Cutting edge Length



### ICTM (Interface committee for turning mill)

- Interface for Multi-task machines turning tool, which is tooling system based on ICTM standard from 17 major Japanese companies cooperation and is compatible with conventional HSK-A type and common to Multi-task machines and machining centers

### Tolerance of keyway has been improved: HSK-T63



### Tolerance comparison (Example)

(mm)

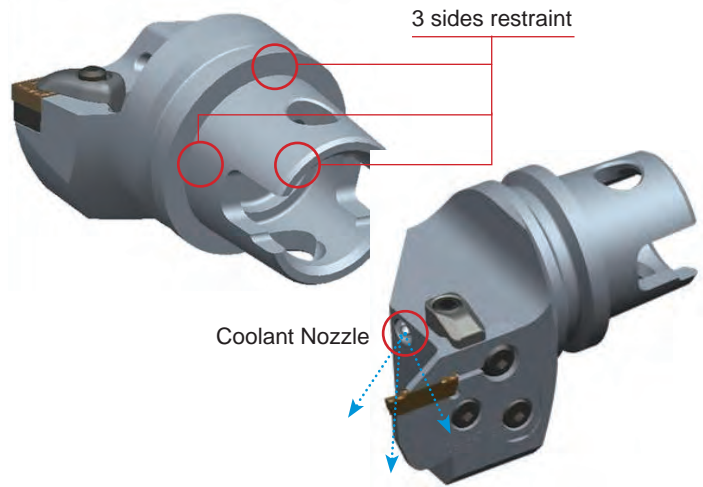
Remarks	Maximum Tolerance	Minimum Tolerance
ICTM STANDARD HSK-T63	0.075	0.035
ISO STANDARD HSK-A63	0.33	0.08



## 3 Face Binding - Superior precision

# KM Tooling System [For Multi-task Machines]

- 3 Face binding/Superior precision
- Flexible clamping system/Superior rigidity
- Various size & style
- Appropriate for turning & milling
- Adjustable coolant direction with coolant nozzle



### Code system

C: 80° Diamond	D: 55° Diamond			DX: 65
S: 90° Square	T: 60° Triangle	N = 0°		H: 100
V: 35° Diamond	W: 80° Hexagon	B = 5°		L: 140
<b>Insert Shape</b>		<b>Clearance angle of insert</b>		<b>Length of tool holder</b>



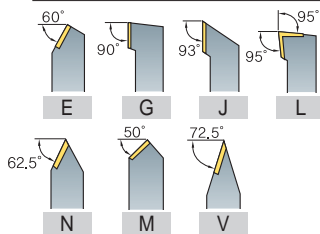
#### Taper design & size

50, 63UT  
80ATC, 100

#### Clamping Type

D: Double Clamp  
M: Multi Clamp  
P: Lever Lock  
S: Screw On  
W: Wedge Clamp

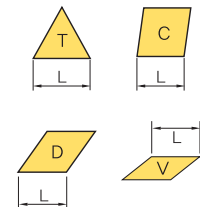
#### Holder Style



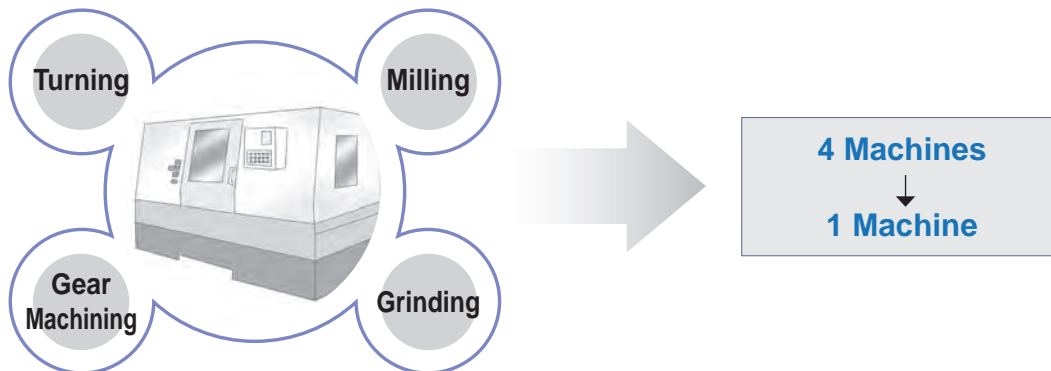
#### Hand

R: Right  
L: Left  
N: No Hand

#### Cutting edge Length



### Multi-tasking machine



**KM Tooling system is superior for wide application.**

External Process

Internal Process

Grooving Process

Drill Process

Parting-off Process

KM50, KM63UT, KM80, KM100 Standard and Special type can be produced.



# B Index for HSK/KM Tooling System

## Index for HSK Tooling System

Cutting Shape								
Designation	H63T-DCLNR/L-DX12	H63T-DCMNN-H/L12	H63T-DDJNR/L-DX15	H63T-DDNNN-H/L15	H63T-PCLNR/L-DX12	H63T-PCMNN-H/L12	H63T-PDJNR/L-DX15	H63T-PDNNN-H/L15
Approach angle	95°	95°	93°	107.5°	95°	95°	93°	107.5°
Page	B231	B231	B231	B231	B232	B232	B232	B232
Turning	●	●	●	●	●	●	●	●
Copying			●	●			●	●
Facing	●	●	●	●	●	●	●	●
Back turning	●	●	●	●	●	●	●	●
Internal turning								

Cutting Shape								
Designation	H63T-PRGCR-DX12	H63T-PRDCN-H/L12	H63T-SVPBR/L-DX16	H63T-SVVBH-H/L16	H63T-A25K/A32L-DCLNR/L-12	H63T-MCFR/L	H63T-MCHR/L	
Approach angle	-	-	117.5°	117.5°	95°	-	-	
Page	B233	B233	B233	B233	B235	B235	B234	
Turning	●	●	●	●	●	●		
Copying	●	●	●	●	●	●		
Facing	●	●	●	●	●	●	●	
Back turning	●	●	●	●	●	●		
Internal turning					●			

## Index for KM Tooling System

Cutting Shape						
Designation	KM50-DCLNR/L-C12 KM63UT-DCLNR/L-D12	KM50-DCMNN-C12 KM63UT-DCMNN-D12	KM50-DDJNR/L-C15(-3) KM63UT-DCJNR/L-D15(-3)	KM50-DDNNN-C15(-3) KM63UT-DDNNN-D15(-3)	KM50-A25K-DCLNR/L-12 KM50-A32K-DCLNR/L-12 KM63UT-A25K-DCLNR/L-12 KM63UT-A32L-DCLNR/L-12	KM50-PCLNR/L-C12 KM63UT-PCLNR/L-D12
Approach angle	95°	95°	93°	107.5°	95°	95°
Page	B237	B237	B237	B238	B240	B238
Turning	●	●	●	●	●	●
Copying			●	●		
Facing	●	●	●	●	●	●
Back turning	●	●	●	●	●	●
Internal turning					●	

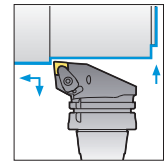
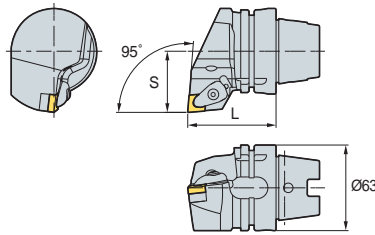
Cutting Shape						
Designation	KM50-PCMNN-C12 KM63UT-PCMNN-D12	KM50-PDJNR/L-C15(-3) KM63UT-PDJNR/L-D15(-3)	KM50-PDNNN-C15(-3) KM63UT-PDNNN-D15(-3)	KM50-MCHR/L KM63UT-MCHR/L		
Approach angle	95°	93°	107.5°	-		
Page	B238	B239	B239	B239		
Turning	●	●	●	●		
Copying		●	●	●		
Facing	●	●	●			
Back turning	●	●	●	●		
Internal turning						



## DCLNR/L



CN□□



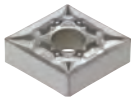
95°

• R type insert  
(mm)

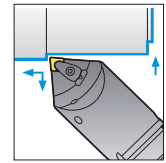
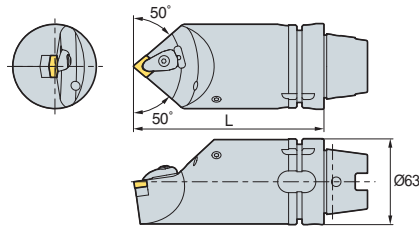
Designation	L	S	Insert	Clamp	Screw	Shim	Shim Screw	Spring	Nozzle	Plug	Wrench	Coolant Pipe
H63T-DCLNR/L-DX12	65	45	CN□□1204□□	CVH4	CHX0518	SC44V	FTKA0410	SPR0714	CN0605	-	HW30P	CP63T

↻ Applicable inserts B36~B42

## DCMNN



CN□□



95°

(mm)

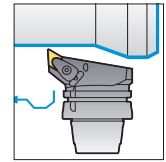
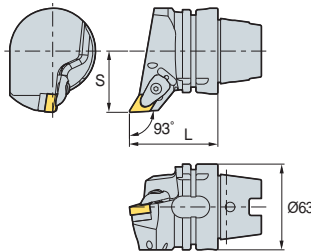
Designation	L	Insert	Clamp	Screw	Shim	Shim Screw	Spring	Nozzle	Plug	Wrench	Coolant Pipe
H63T-DCMNN-H12	100	CN□□1204□□	CVH4	CHX0518	SC44V	FTKA0410	SPR0714	CN0605	KHA0808	HW30P	CP63T
H63T-DCMNN-L12	140										

↻ Applicable inserts B36~B42

## DDJNR/L



DN□□



93°

• R type insert  
(mm)

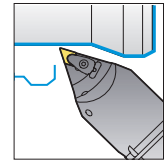
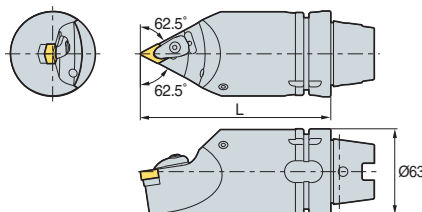
Designation	L	S	Insert	Clamp	Screw	Shim	Shim Screw	Spring	Nozzle	Plug	Wrench	Coolant Pipe
H63T-DDJNR/L-DX15	65	45	DN□□1506□□	CVH4	CHX0518	SD43V	FTKA0410	SPR0714	CN0605	-	HW30P	CP63T
H63T-DDJNR/L-DX15-3	65	45	DN□□1504□□			SD44V						

↻ Applicable inserts B43~B48

## DDNNN



DN□□



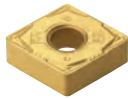
107.5°

(mm)

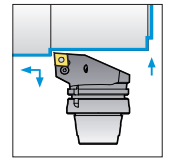
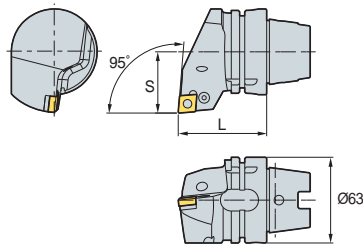
Designation	L	Insert	Clamp	Screw	Shim	Shim Screw	Spring	Nozzle	Plug	Wrench	Coolant Pipe
H63T-DDNNN-H15	100	DN□□1506□□	CVH4	CHX0518	SD43V	FTKA0410	SPR0714	CN0605	KHA0808	HW30P	CP63T
H63T-DDNNN-L15	140										
H63T-DDNNN-H15-3	100	DN□□1504□□	CVH4	CHX0518	SD44V	FTKA0410	SPR0714	CN0605	KHA0808	HW30P	CP63T
H63T-DDNNN-L15-3	140										

↻ Applicable inserts B43~B48

## PCLNR/L



CN□□



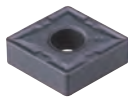
95°

• R type insert  
(mm)

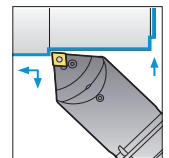
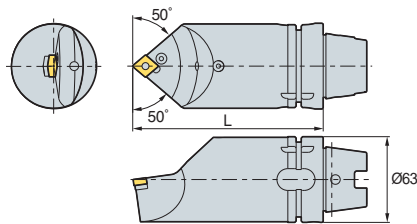
Designation	L	S	Insert	Lever	Screw	Shim	Shim Pin	Punching	Nozzle	Plug	Wrench	Coolant Pipe
H63T-PCLNR/L-DX12	65	45	CN□□1204□□	LV4N	VHX0820N	SC42N	SP4N	LSPS4	CN0605	-	HW30L	CP63T

↻ Applicable inserts B36-B42

## PCMNN



CN□□



95°

(mm)

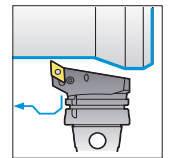
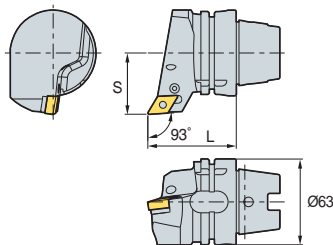
Designation	L	Insert	Lever	Screw	Shim	Shim Pin	Punching	Nozzle	Plug	Wrench	Coolant Pipe
H63T-PCMNN-H12	100	CN□□1204□□	LV4N	VHX0820N	SC42N	SP4N	LSPS4	CN0605	KHA0808	HW30L	CP63T
H63T-PCMNN-L12	140										

↻ Applicable inserts B36-B42

## PDJNR/L



DN□□



95°

• R type insert  
(mm)

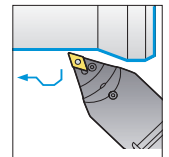
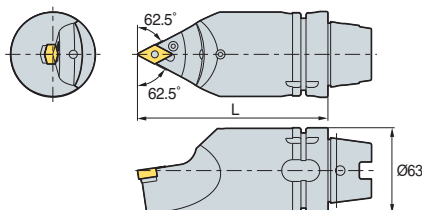
Designation	L	S	Insert	Lever	Screw	Shim	Shim Pin	Punching	Nozzle	Plug	Wrench	Coolant Pipe
H63T-PDJNR/L-DX15	65	45	DN□□1506□□	LV4BN	VHX0821N	SD42N	SP4N	LSPS4	CN0605	-	HW30L	CP63T
H63T-PDJNR/L-DX15-3	65	45	DN□□1504□□			SD43N						

↻ Applicable inserts B43-B48

## PDNNN



DN□□



107.5°

(mm)

Designation	L	Insert	Lever	Screw	Shim	Shim Pin	Punching	Nozzle	Plug	Wrench	Coolant Pipe
H63T-PDNNN-H15	100	DN□□1506□□	LV4BN	VHX0821N	SD42N	SP4N	LSPS4	CN0605	KHA0808	HW30L	CP63T
H63T-PDNNN-L15	140										
H63T-PDNNN-H15-3	100	DN□□1504□□	LV4BN	VHX0821N	SD43N	SP4N	LSPS4	CN0605	KHA0808	HW30L	CP63T
H63T-PDNNN-L15-3	140										

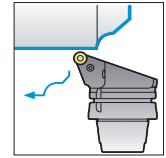
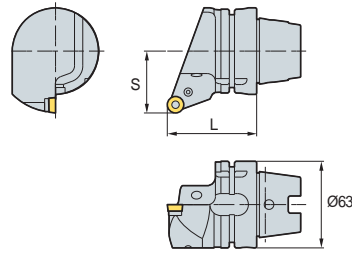
↻ Applicable inserts B43-B48



# PRGCR/L



RCMX1204M0



• R type insert (mm)

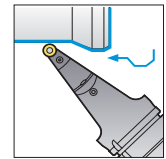
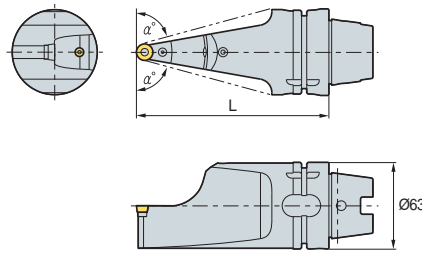
Designation	L	S	Insert	Lever	Screw	Shim	Shim Pin	Punching	Nozzle	Plug	Wrench	Coolant Pipe
H63T-PRGCR/L-DX12	65	45	RCMX1204M0	LR12	VHX0617	SR12	SP3	LSPS3	CN0605	-	HW25L	CP63T

↻ Applicable inserts **B83, B105**

# PRDCN



RCMX1204M0



(mm)

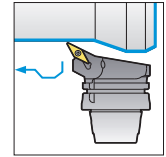
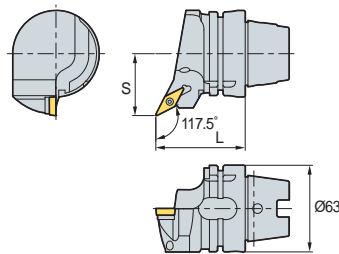
Designation	L	α°	Insert	Lever	Screw	Shim	Shim Pin	Punching	Nozzle	Plug	Wrench	Coolant Pipe
H63T-PRDCN-H12	100	69	RCMX1204M0	LR12	VHX0617	SR12	SP3	LSPS3	CN0605	-	HW25L	CP63T
H63T-PRDCN-L12	140	75										

↻ Applicable inserts **B83, B105**

# SVPBR/L



VB□T



117.5°

• R type insert (mm)

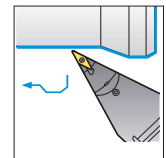
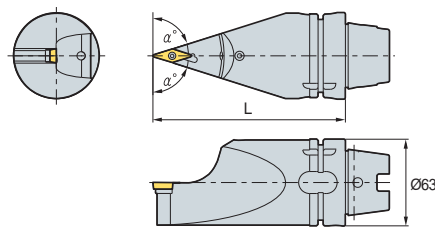
Designation	L	S	Insert	Screw	Shim Screw	Shim	Nozzle	Plug	Wrench	Wrench	Coolant Pipe
H63T-SVPBR/L-DX16	65	45	VB□T1604□□	FTGA03512	SHXN0509F	SV32S	CN0605	-	TW15P	HW32L	CP63T

↻ Applicable inserts **B94~B96, B108**

# SVVBN



VB□T



117.5°

(mm)

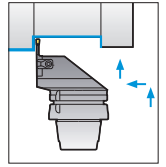
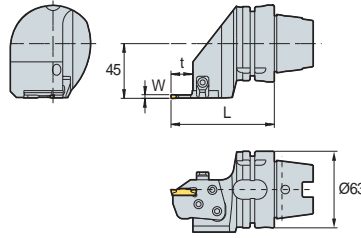
Designation	L	α°	Insert	Screw	Shim Screw	Shim	Nozzle	Plug	Wrench	Wrench	Coolant Pipe
H63T-SVVBN-H16	100	66.5	VB□T1604□□	FTGA03512	SHXN0509F	SV32S	CN0605	KHA0808	TW15P	HW32L	CP63T
H63T-SVVBN-L16	140	72.5									

↻ Applicable inserts **B94~B96, B108**

## MCHR/L



MGMN / MGMR/L  
MGGN / MRMN



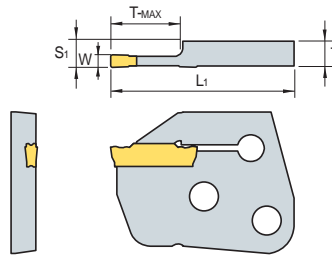
• R type insert  
(mm)

Designation	L	t	W	T-MAX	Insert	Cartridge	Clamp	Clamp Screw	Hinge Screw	Screw	Nozzle	Plug	Wrench	Coolant Pipe
H63T-MCHR/L	85	18	3	16	MGMN	MCER/L3-T16	CHX8N	DHA0818F	RHA0613	FHGA0618	CN0605	-	HW40L	CP63T
	85	18	4	16	MGMR/L	MCER/L4-T16								
	89	22	5	20	MGGN	MCER/L5-T20								
	89	22	6	20	MRMN	MCER/L6-T20								

## MCER/L (Cartridge)



MGMN / MGMR/L  
MGGN / MRMN



• R type insert  
(mm)

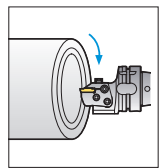
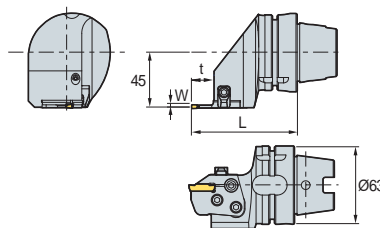
Designation	L	L <sub>1</sub>	S <sub>1</sub>	T-MAX	Insert		Tool holders	
					W	Designation		
MCER/L	3-T16	6.00	44.5	6.35	16	3	MGMN	H63T-MCHR/L
	4-T16	5.97	44.5	6.35	16	4	MGMR/L	
	5-T20	5.87	48.5	6.35	20	5	MGGN	
	6-T20	5.82	48.5	6.35	20	6	MGMN	

↻ Applicable inserts C28-C30

## MCHR/L



MFMN300  
MGMN400



• R type insert  
(mm)

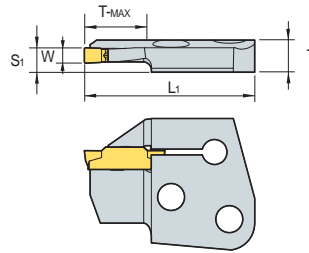
Designation	L	t	W	T-MAX	Insert	Cartridge	Clamp	Clamp Screw	Hinge Screw	Screw	Nozzle	Plug	Wrench	Coolant Pipe
H63T-MCHR/L	85	18	3	16	MFMN300	MCFR/L3-24/35-T16	CHX8N	DHA0818F	RHA0613	FHGA0618	CN0605	-	HW40L	
	85	18	3	16		MCFR/L3-29/40-T16								
	85	18	3	16		MCFR/L3-34/50-T16								
	85	18	3	16		MCFR/L3-44/70-T16								
	85	18	3	16		MCFR/L3-64/99-T16								
	85	18	3	16	MGMN400	MCFR/L4-44/60-T16								
	85	18	3	16		MCFR/L4-60/120-T16								
	85	18	3	16		MCFR/L4-112/200-T16								



# MCFR/L (Cartridge)



MFMN300  
MGMN400



• R type insert (mm)

Designation	T	L <sub>1</sub>	S <sub>1</sub>	T-MAX	Insert		Tool holders
					W	Designation	
MCFR/L3- 24/35-T16 29/40-T16 34/50-T16 44/70-T16 64/99-T16	8.00	44.5	6.35	16	3	MFMN300	H63T-MCHR/L
	8.00	44.5	6.35	16	3		
	8.00	44.5	6.35	16	3		
	8.00	44.5	6.35	16	3		
	8.00	44.5	6.35	16	3		
MCFR/L4- 44/60-T16 60/120-T16 112/200-T16	7.97	44.5	6.35	16	4	MGMN400	H63T-MCHR/L
	7.97	44.5	6.35	16	4		
	7.97	44.5	6.35	16	4		

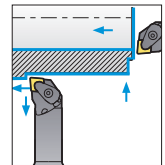
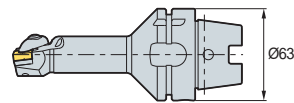
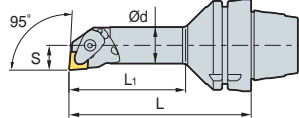
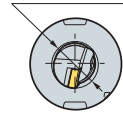
↻ Applicable inserts C28-C30

# DCLNR/L



CN□□

ØD Min. machining Dia.



95°

• R type insert (mm)

Designation	ØD	Ød	L	L <sub>1</sub>	S	Insert	Clamp	Screw	Shim	Shim Screw	Spring	Nozzle	Plug	Wrench	Coolant Pipe
H63T-A25K-DCLNR/L-12	32	25	125	80	17	CN□□1204□□									
H63T-A32L-DCLNR/L-12	40	32	140	98	22										

↻ Applicable inserts B36-B42

# Blank Tool

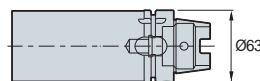
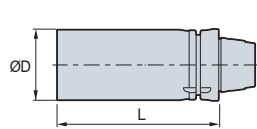


Fig. 1

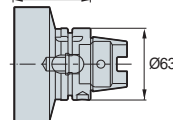
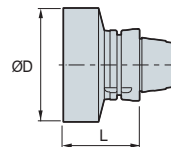


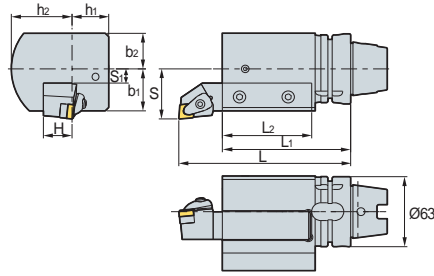
Fig. 2

(mm)

Designation	ØD	L	Fig.	Coolant Pipe
HSK-T63-BL62-102	62	102	1	 CP63T
HSK-T63-BL62-142	62	142	2	
HSK-T63-BL100-67	100	67	1	
HSK-T63-BL120-70	120	70	2	



## EV2525R/L-112

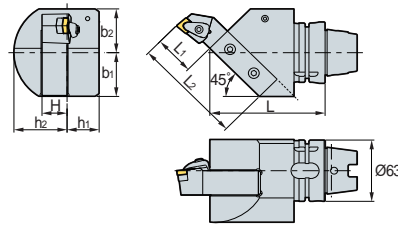


- **Holder information**
- Holder size: 25 x 25
- Before setting the holder, please cut the holder length to 115 mm.

• R type insert (mm)

Designation	L	L <sub>1</sub>	L <sub>2</sub>	H	h <sub>1</sub>	h <sub>2</sub>	S	S <sub>1</sub>	b <sub>1</sub>	b <sub>2</sub>	Screw	Plug	Nozzle	Wrench	Coolant Pipe
EV2525R/L-112	150	112	77	25	32	53	45	12.75	37.75	32	KHA1231	KHA0808	CN0605	HW50L	CP63T

## EV2525R/L-115

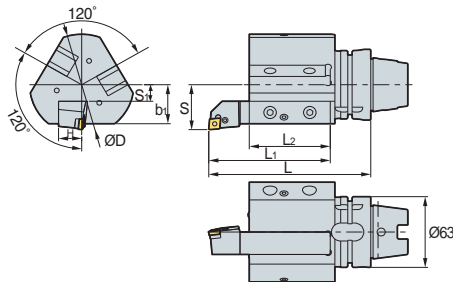


- **Holder information**
- Holder size: 25 x 25
- Before setting the holder, please cut the holder length to 110 mm.

• R type insert (mm)

Designation	L	L <sub>1</sub>	L <sub>2</sub>	H	h <sub>1</sub>	h <sub>2</sub>	b <sub>1</sub>	b <sub>2</sub>	Screw	Plug	Nozzle	Wrench	Coolant Pipe
EV2525R/L-115	115	40	110	25	32	53	45	45	KHA1231	KHA0808	CN0605	HW50L	CP63T

## EV2020R/L-105-3

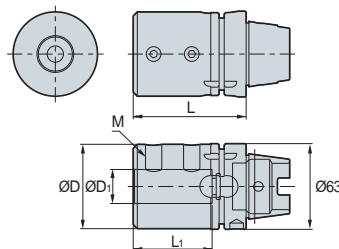


- **Holder information**
- Holder size: 20 x 20
- Before setting the holder, please cut the holder length to 105 mm.

• R type insert (mm)

Designation	L	L <sub>1</sub>	L <sub>2</sub>	H	ØD	S	S <sub>1</sub>	B <sub>1</sub>	Screw	Plug	Nozzle	Wrench	Coolant Pipe
EV2020R/L-105-3	140	105	70	20	90	40	15	35	KHA1231	KHA0808	CN0605	HW50L	CP63T

## B○○○-○○○



• R type insert (mm)

Designation	ØD	D <sub>1</sub>	L	L <sub>1</sub>	M	Screw	Wrench	Coolant Pipe
B08-65	28	8	65	40	M8	KHA1218	HW50L	CP63T
B10-70	35	10	70	45	M8			
B12-70	42	12	70	45	M8			
B16-75	48	16	75	50	M10			
B20-75	52	20	75	50	M10			
B25-83	62	25	83	58	M12			
B32-87	62	32	87	62	M12			
B40-97	65	40	97	72	M16			

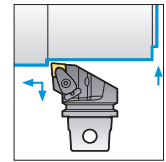
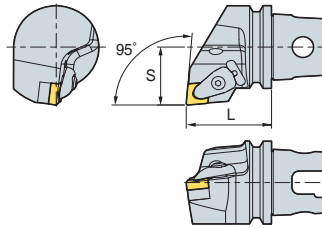




# DCLNR/L



CN□□



95°

• R type insert  
(mm)

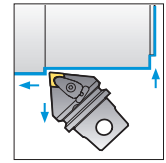
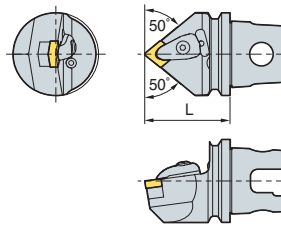
Designation	L	S	Insert	Clamp	Screw	Shim	Shim Screw	Spring	Nozzle	Plug	Wrench
KM50-DCLNR/L-C12	50	35	CN□□1204□□	CVH4	CHX0518	SC44V	FTKA0410	SPR0714	CN0605	-	HW30P
KM63UT-DCLNR/L-D12	60	43									

➔ Applicable inserts B36~B42

# DCMNN



CN□□



95°

(mm)

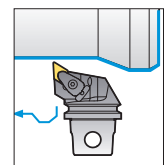
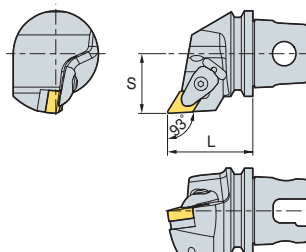
Designation	L	Insert	Clamp	Screw	Shim	Shim Screw	Spring	Nozzle	Plug	Wrench
KM50-DCMNN-C12	50	CN□□1204□□	CVH4	CHX0518	SC44V	FTKA0410	SPR0714	CN0605	KHA0808	HW30P
KM63UT-DCMNN-D12	60									

➔ Applicable inserts B36~B42

# DDJNR/L



DN□□



93°

• R type insert  
(mm)

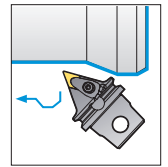
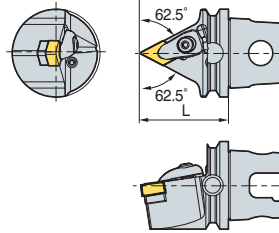
Designation	L	S	Insert	Clamp	Screw	Shim	Shim Screw	Spring	Nozzle	Plug	Wrench
KM50-DDJNR/L-C15	50	35	DN□□1506□□	CVH4	CHX0518	SD43V	FTKA0410	SPR0714	CN0605	-	HW30P
KM50-DDJNR/L-C15-3	50	35	DN□□1504□□	CVH4	CHX0518	SD44V	FTKA0410	SPR0714	CN0605	-	HW30P
KM63UT-DDJNR/L-D15	60	43	DN□□1506□□	CVH4	CHX0518	SD43V	FTKA0410	SPR0714	CN0605	-	HW30P
KM63UT-DDJNR/L-D15-3	60	43	DN□□1504□□	CVH4	CHX0518	SD44V	FTKA0410	SPR0714	CN0605	-	HW30P

➔ Applicable inserts B43~B48

## DDNNN



DN□□



117.5°

(mm)

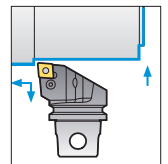
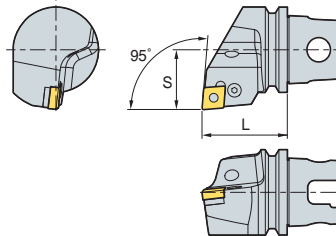
Designation	L	Insert	Clamp	Screw	Shim	Shim Screw	Spring	Nozzle	Plug	Wrench
KM50-DDNNN-C15	50	DN□□1506□□	CVH4	CHX0518	SD43V	FTKA0410	SPR0714	CN0605	KHA0808	HW30P
KM50-DDNNN-C15-3	50	DN□□1504□□	CVH4	CHX0518	SD44V	FTKA0410	SPR0714	CN0605	KHA0808	HW30P
KM63UT-DDNNN-D15	60	DN□□1506□□	CVH4	CHX0518	SD43V	FTKA0410	SPR0714	CN0605	KHA0808	HW30P
KM63UT-DDNNN-D15-3	60	DN□□1504□□	CVH4	CHX0518	SD44V	FTKA0410	SPR0714	CN0605	KHA0808	HW30P

↻ Applicable inserts B43-B48

## PCLNR/L



CN□□



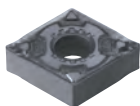
95°

• R type insert  
(mm)

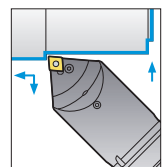
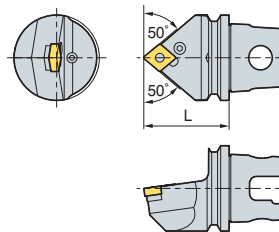
Designation	L	S	Insert	Lever	Screw	Shim	Shim Pin	Punching	Nozzle	Plug	Wrench
KM50-PCLNR/L-C12	50	35	CN□□1204□□	LV4N	VHX0820N	SC42N	SP4N	LSPS4	CN0605	-	HW30L
KM63UT-PCLNR/L-D12	60	43									

↻ Applicable inserts B36-B42

## PCMNN



CN□□



95°

(mm)

Designation	L	Insert	Lever	Screw	Shim	Shim Pin	Punching	Nozzle	Plug	Wrench
KM50-PCMNN-C12	50	CN□□1204□□	LV4N	VHX0820N	SC42N	SP4N	LSPS4	CN0605	KHA0808	HW30L
KM63UT-PCMNN-D12	60									

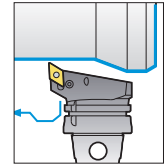
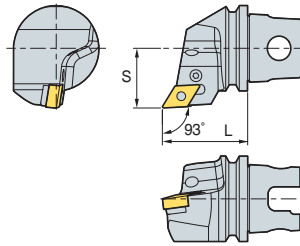
↻ Applicable inserts B36-B42



# PDJNR/L



DN□□



93°

• R type insert (mm)

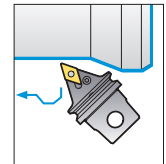
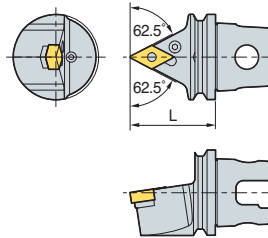
Designation	L	S	Insert	Lever	Screw	Shim	Shim Pin	Punching	Nozzle	Plug	Wrench
KM50-PDJNR/L-C15	50	35	DN□□1506□□	LV4BN	VHX0821N	SD42N	SP4N	LSPS4	CN0605	-	HW30L
KM50-PDJNR/L-C15-3	50	35	DN□□1504□□	LV4BN	VHX0821N	SD43N	SP4N	LSPS4	CN0605	-	HW30L
KM63UT-PDJNR/L-D15	60	43	DN□□1506□□	LV4BN	VHX0821N	SD42N	SP4N	LSPS4	CN0605	-	HW30L
KM63UT-PDJNR/L-D15-3	60	43	DN□□1504□□	LV4BN	VHX0821N	SD43N	SP4N	LSPS4	CN0605	-	HW30L

↻ Applicable inserts B43~B48

# PDNNN



DN□□



107.5°

(mm)

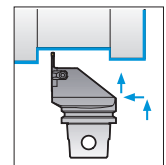
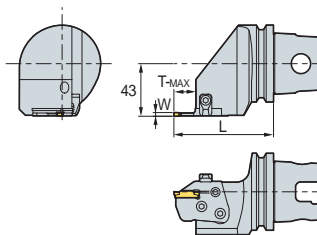
Designation	L	Insert	Lever	Screw	Shim	Shim Pin	Punching	Nozzle	Plug	Wrench
KM50-PDNNN-C15	50	DN□□1506□□	LV4BN	VHX0821N	SD42N	SP4N	LSPS4	CN0605	KHA0808	HW30L
KM50-PDNNN-C15-3	50	DN□□1504□□	LV4BN	VHX0821N	SD43N	SP4N	LSPS4	CN0605	KHA0808	HW30L
KM63UT-PDNNN-D15	60	DN□□1506□□	LV4BN	VHX0821N	SD42N	SP4N	LSPS4	CN0605	KHA0808	HW30L
KM63UT-PDNNN-D15-3	60	DN□□1504□□	LV4BN	VHX0821N	SD43N	SP4N	LSPS4	CN0605	KHA0808	HW30L

↻ Applicable inserts B43~B48

# MCHR/L



MGMN / MGMR/L  
MGGN / MRMN



• R type insert (mm)

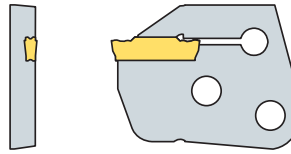
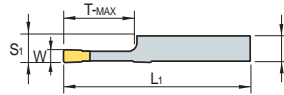
Designation	S	L	t	W	T-MAX	Insert	Cartridge	Clamp	Clamp Screw	Hinge Screw	Screw	Nozzle	Plug	Wrench
KM50-MCHR/L	35	72.5	18	3	16	MGMN MGMR/L MGGN MRMN	MCER/L3-T16	CHX8N	DHA0818F	RHA0613	FHGA0618	CN0605	-	HW40L
	35	72.5	18	4	16		MCER/L4-T16							
	35	76.5	22	5	20		MCER/L5-T20							
	35	76.5	22	6	20		MCER/L6-T20							
KM63UT-MCHR/L	43	81.5	18	3	16		MCER/L3-T16	CHX8N	DHA0818F	RHA0613	FHGA0618	CN0605	-	HW40L
	43	81.5	18	4	16		MCER/L4-T16							
	43	85.5	22	5	20		MCER/L5-T20							
	43	85.5	22	6	20		MCER/L6-T20							

↻ Applicable inserts C28~C30

## MCER/L (Cartridge)



MGMN / MGMR/L  
MGGN / MRMN



• R type insert (mm)

Designation	T	L <sub>1</sub>	S <sub>1</sub>	T-MAX	Insert		Tool holders	
					W	Designation		
MCER/L	3-T16	6.00	44.5	6.35	16	3	MGMN	H-63T-MCHR/L
	4-T16	5.97	44.5	6.35	16	4	MGMR/L	
	5-T20	5.87	48.5	6.35	20	5	MGGN	
	6-T20	5.82	48.5	6.35	20	6	MRMN	

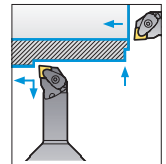
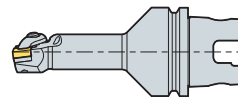
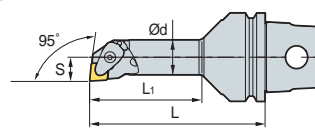
➔ Applicable inserts C28- C30

## KM○○-DCLNR/L



CN□□

ØD Min. machining Dia.



95°

• R type insert (mm)

Designation	ØD	Ød	L	L <sub>1</sub>	S	Insert	Clamp	Screw	Shim	Shim Screw	Spring	Nozzle	Plug	Wrench
KM50-A25K-DCLNR/L-12	32	25	125	80	17	CN□□1204□□								
KM50-A32L-DCLNR/L-12	40	32	140	98	22									
KM63UT-A25K-DCLNR/L-12	32	25	125	80	17									
KM63UT-A32L-DCLNR/L-12	40	32	140	98	22									

CVH4 CHX0518 SC42V FTKA0410 SPR0714 CN0605 - HW30P

➔ Applicable inserts B36-B42

## Blank Tool

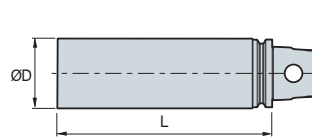


Fig. 1

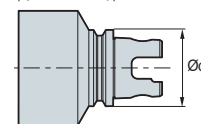
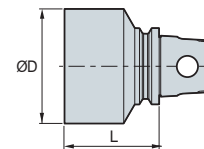


Fig. 2

(mm)

Designation	ØD	L	Ød	Fig.
KM50-BL7562	45	62	50	1
KM50-BL10562	105	62	50	2
KM63UT-BL65200	65	200	50	1
KM63UT-BL115150	115	150	50	2



S T F C R 12 C A - 16

1

Method of Mounting Insert

2

Insert Shape

3

Holder Style

4

Relief Angle of Insert

5

Hand

6

Height of Cutting Edge

7

Cartridge Code

8

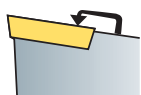
Type of Cartridge

9

Length of Cutting Edge

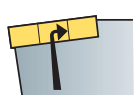
**1 Method of Mounting Insert**

S T F C R 12 C A - 16



Top Clamping

C



Hole Clamping

P



Screw on

S

**2 Insert Shape**

S T F C R 12 C A - 16



C



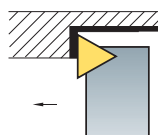
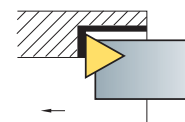
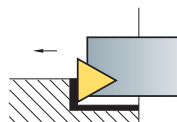
S



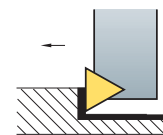
T

**5 Hand**

S T F C R 12 C A - 16



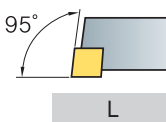
R



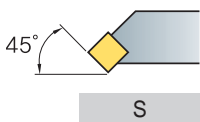
L

**3 Holder Style**

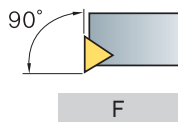
S T F C R 12 C A - 16



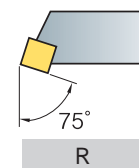
L



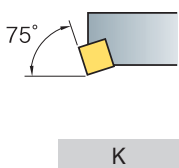
S



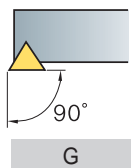
F



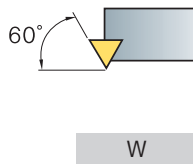
R



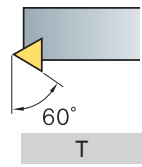
K



G



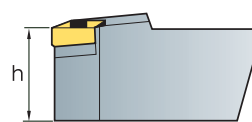
W



T

**6 Height of Cutting Edge**

S T F C R 12 C A - 16



**7 Cartridge Code**

S T F C R 12 C A - 16

C (Cartridge)

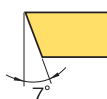
**8 Type of Cartridge**

S T F C R 12 C A - 16

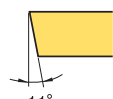
A (ISO5611)

**4 Relief Angle of Insert**

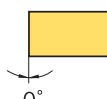
S T F C R 12 C A - 16



C



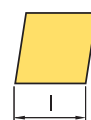
P



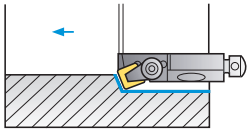
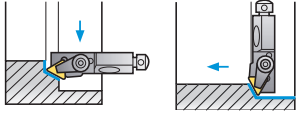
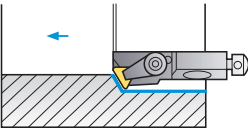
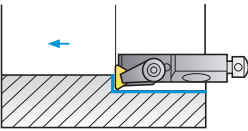
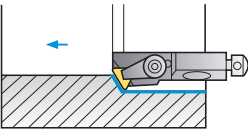
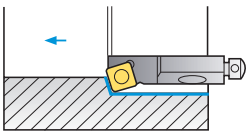
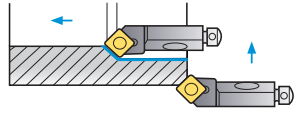
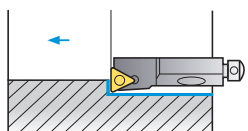
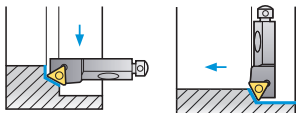
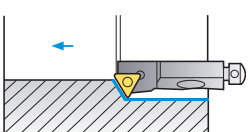
N

**9 Length of Cutting Edge**

S T F C R 12 C A - 16

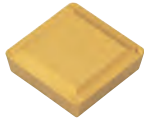


# B Index for Cartridge

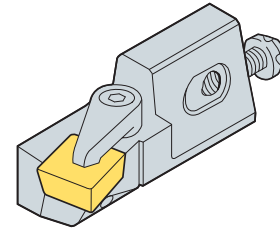
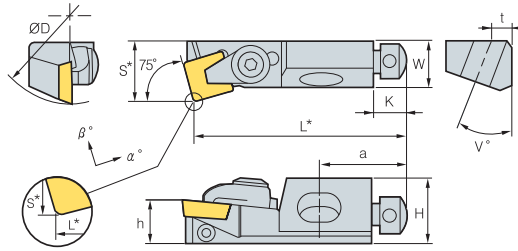
	Cutting Shape	Turning	Copying	Facing	Chamfering	Applicable inserts	Page	
Clamp on System	<b>CSKPR/L</b> 	10CA-09 12CA-12	●				SP□R0903□□ SP□R1203□□	B243
	<b>CTTPR/L</b> 	10CA-11 12CA-16	●				TP□R1103□□ TP□R1603□□	B244
	<b>CTWPR/L</b> 	10CA-11 12CA-16	●				TP□R1103□□ TP□R1603□□	B245
	<b>CTFPR/L</b> 	10CA-11 12CA-16	●		●		TP□R1103□□ TP□R1603□□	B243
	<b>CTSPR/L</b> 	10CA-11 12CA-16	●				TP□R1103□□ TP□R1603□□	B244
Screw on System	<b>SSKCR/L</b> 	10CA-09 12CA-12	●				SC□T09T3□□ SC□T1204□□	B245
	<b>SSSCR/L</b> 	10CA-09 12CA-12	●		●		SC□T09T3□□ SC□T1204□□	B246
	<b>STFCR/L</b> 	10CA-11 12CA-16	●		●		TC□T1102□□ TC□T16T3□□	B246
	<b>STTCR/L</b> 	10CA-11 12CA-16	●		●		TC□T1102□□ TC□T16T3□□	B247
	<b>STWCR/L</b> 	10CA-11 12CA-16	●				TC□T1102□□ TC□T16T3□□	B247



# CSKPR/L



SP□R



• R type insert (mm)

Designation	ØD	H	W	L*	S*	h	K	α°	β°	a	t	v°	Insert
CSKPR/L 10CA-09	40	15	11	50	14	10	8	6	0	20	5	20	SP□R0903□□
12CA-12	50	20	15	55	20	12	8	6	0	20	6	20	SP□R1203□□

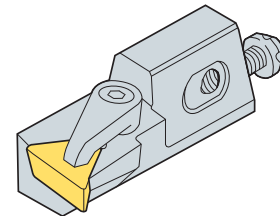
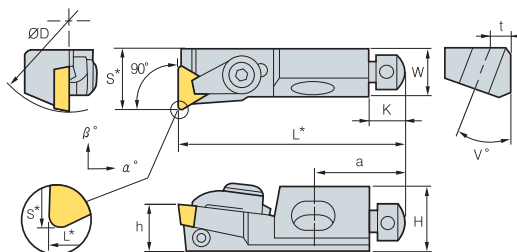
➔ Applicable inserts **B76~B77** · a base Insert : r = 0.8 D = ØD Min. machining Dia.

Parts	Clamp	Axial Adjust Screw	Radial Adjust Screw	MountingScrew	Washer	Wrench	Wrench
CSKPR/L 10CA-09	CA05R	AZ0508F	KHA0408	RHA0620	WA0602	TW 15P	HW20L
12CA-12	CA06R	AZ0508F	KHA0412	RHA0625	WA0602	TW 15P	HW20L

# CTFPR/L



TP□R



• R type insert (mm)

Designation	ØD	H	W	L*	S*	h	K	α°	β°	a	t	v°	Insert
CTFPR/L 10CA-11	40	15	11	50	14	10	8	6	0	20	5	20	TP□R1103□□
12CA-16	50	20	15	55	20	12	8	6	0	20	6	20	TP□R1603□□

➔ Applicable inserts **B81~B83** · a base Insert : r = 0.4 (l=11) r = 0.8 (l=16) D = ØD Min. machining Dia.

Parts	Clamp	Axial Adjust Screw	Radial Adjust Screw	MountingScrew	Washer	Wrench	Wrench
CTFPR/L 10CA-11	CA05R	AZ0508F	KHA0408	RHA0620	WA0602	TW25L	HW20L
12CA-16	CA06R	AZ0508F	KHA0412	RHA0625	WA0602	TW30L	HW20L

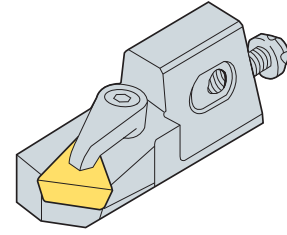
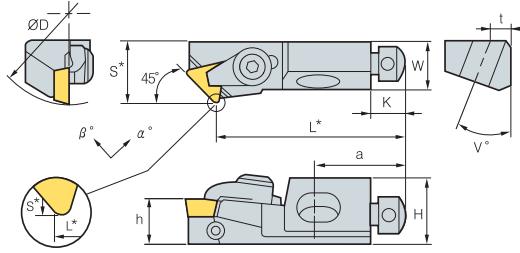


# B Clamp on System

## CTSPR/L



TP□R



• R type insert (mm)

Designation	ØD	H	W	L*	S*	h	K	α°	β°	a	t	v°	Insert
CTSPR/L 10CA-11	40	15	11	44	14	10	8	4	0	20	5	20	TP□R1103□□
12CA-16	50	20	15	47	20	12	8	5	0	20	6	20	TP□R1603□□

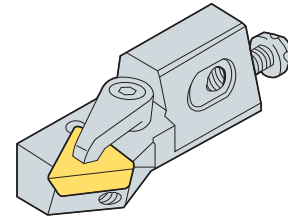
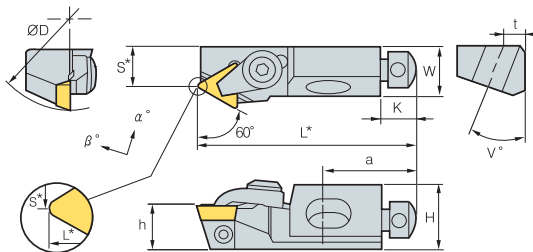
↻ Applicable inserts B81-B83     · a base Insert : r = 0.4 (l=11) r = 0.8 (l=16)     D = ØD Min. machining Dia.

Parts	Clamp	Axial Adjust Screw	Radial Adjust Screw	MountingScrew	Washer	Wrench	Wrench
CTSPR/L 10CA-11	CA05R	AZ0508F	KHA0408	RHA0620	WA0602	TW25L	HW20L
12CA-16	CA06R	AZ0508F	KHA0412	RHA0625	WA0602	TW30L	HW20L

## CTTPR/L



TP□R



• R type insert (mm)

Designation	ØD	H	W	L*	S*	h	K	α°	β°	a	t	v°	Insert
CTTPR/L 10CA-11	40	15	11	50	9	10	8	5	0	20	5	20	TP□R1103□□
12CA-16	50	20	15	55	20	12	8	5	0	20	6	20	TP□R1603□□

↻ Applicable inserts B81-B83     · a base Insert : r = 0.8     D = ØD Min. machining Dia.

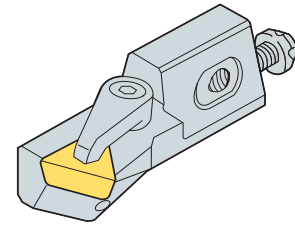
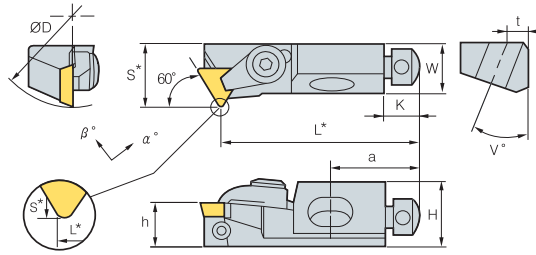
Parts	Clamp	Axial Adjust Screw	Radial Adjust Screw	MountingScrew	Washer	Wrench	Wrench
CTTPR/L 10CA-11	CA05R	AZ0508F	KHA0408	RHA0620	WA0602	TW25L	HW20L
12CA-16	CA06R	AZ0508F	KHA0412	RHA0625	WA0602	TW30L	HW20L



# CTWPR/L



TP□R



• R type insert (mm)

Designation	ØD	H	W	L*	S*	h	K	α°	β°	a	t	v°	Insert
CTWPR/L 10CA-11	40	15	11	44	14	10	8	5	0	20	5	20	TP□R1103□□
12CA-16	50	20	15	47	20	12	8	5	0	20	6	20	TP□R1603□□

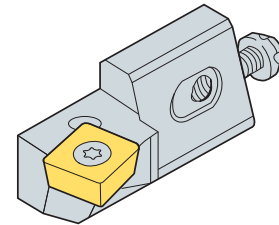
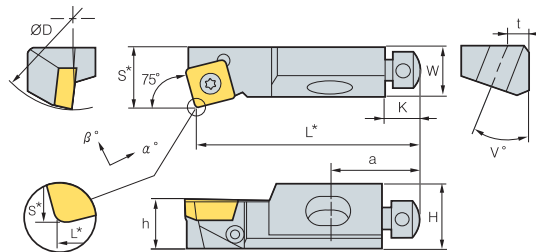
➔ Applicable inserts B81~B83      · a base Insert : r = 0.8      D = ØD Min. machining Dia.

Parts	Clamp	Axial Adjust Screw	Radial Adjust Screw	MountingScrew	Washer	Wrench	Wrench
CTWPR/L 10CA-11	CA05R	AZ0508F	KHA0408	RHA0620	WA0602	TW25L	HW20L
12CA-16	CA06R	AZ0508F	KHA0412	RHA0625	WA0602	TW30L	HW20L

# SSKCR/L



SC□□



• R type insert (mm)

Designation	ØD	H	W	L*	S*	h	K	α°	β°	a	t	v°	Insert
SSKCR/L 10CA-09	40	15	11	50	14	10	8	0	-4	20	5	20	SC□□09T3□□
12CA-12	50	20	15	55	20	12	8	0	-4	20	6	20	SC□□1204□□

➔ Applicable inserts B74~B75, B94      · a base Insert : r = 0.8      D = ØD Min. machining Dia.

Parts	Screw	Axial Adjust Screw	Radial Adjust Screw	MountingScrew	Washer	Wrench	Wrench
SSKCR/L 10CA-09	FTGA03508	AZ0508F	KHA0408	RHA0620	WA0602	TW 15P	HW20L
12CA-12	FTGA0411F	AZ0508F	KHA0412	RHA0625	WA0602	TW 15P	HW20L

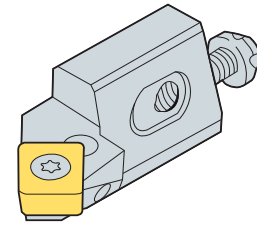
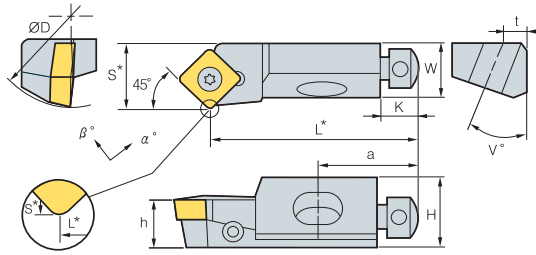


# B Screw on System

## SSSCR/L



SC□□



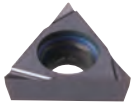
• R type insert (mm)

Designation	ØD	H	W	L*	S*	h	K	α°	β°	a	t	v°	Insert
SSSCR/L 10CA-09	40	15	11	44	14	10	8	-5	0	20	5	20	SC□□09T3□□
12CA-12	50	20	15	47	20	12	8	-5	0	20	6	20	SC□□1204□□

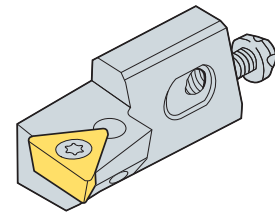
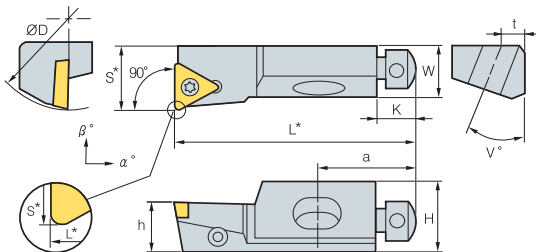
↻ Applicable inserts B74~B75, B94 · a base Insert : r = 0.8 D = ØD Min. machining Dia.

Parts	Screw	Axial Adjust Screw	Radial Adjust Screw	MountingScrew	Washer	Wrench	Wrench
SSSCR/L 10CA-09	FTGA03508	AZ0508F	KHA0408	RHA0620	WA0602	TW 15P	HW20L
12CA-12	FTGA0411F	AZ0508F	KHA0412	RHA0625	WA0602	TW 15P	HW20L

## STFCR/L



TC□□



• R type insert (mm)

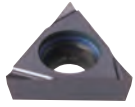
Designation	ØD	H	W	L*	S*	h	K	α°	β°	a	t	v°	Insert
STFCR/L 10CA-11	40	15	11	50	14	10	8	0	-3	20	5	20	TC□□1102□□
12CA-16	50	20	15	55	20	12	8	0	-3	20	6	20	TC□□16T3□□

↻ Applicable inserts B79~B80, B95 · a base Insert : r = 0.4 (l=11) r = 0.8 (l=16) D = Min. machining Dia.

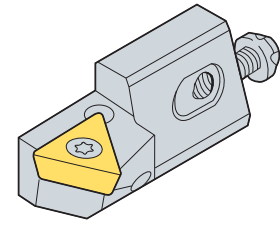
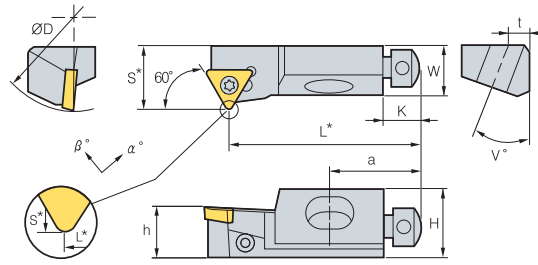
Parts	Screw	Axial Adjust Screw	Radial Adjust Screw	MountingScrew	Washer	Wrench	Wrench
STFCR/L 10CA-11	FTKA02565	AZ0508F	KHA0408	RHA0620	WA0602	TW 15P	HW20L
12CA-16	FTKA03508	AZ0508F	KHA0412	RHA0625	WA0602	TW 15P	HW20L



# STTCR/L



TC□□



• R type insert  
(mm)

Designation	ØD	H	W	L*	S*	h	K	α°	β°	a	t	v°	Insert
STTCR/L 10CA-11	40	15	11	50	9	10	8	-5	0	20	5	20	TC□□1102□□
12CA-16	50	20	15	47	20	12	8	-3	0	20	6	20	TC□□16T3□□

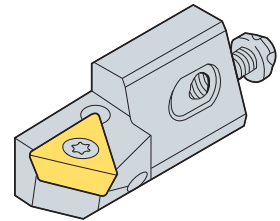
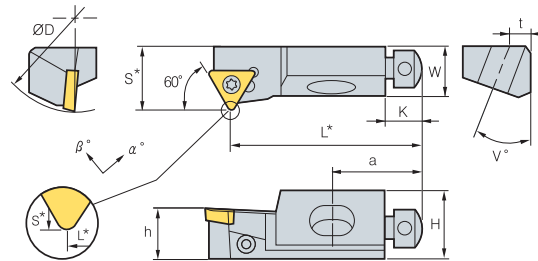
➔ Applicable inserts B79-B80, B95      · a base Insert : r = 0.4 (l=11) r = 0.8 (l=16)    D = Min. machining Dia.

Parts	Screw	Axial Adjust Screw	Radial Adjust Screw	MountingScrew	Washer	Wrench	Wrench
STTCR/L 10CA-11	FTKA02565	AZ0508F	KHA0408	RHA0620	WA0602	TW 07P	HW20L
12CA-16	FTKA03508	AZ0508F	KHA0412	RHA0625	WA0602	TW 15P	HW20L

# STWCR/L



TC□□



• R type insert  
(mm)

Designation	ØD	H	W	L*	S*	h	K	α°	β°	a	t	v°	Insert
STWCR/L 10CA-11	40	15	11	44	14	10	8	0	-4	20	5	20	TC□□1102□□
12CA-16	50	20	15	47	20	12	8	-5	0	20	6	20	TC□□16T3□□

➔ Applicable inserts B79-B80, B95      · a base Insert : r = 0.4 (l=11) r = 0.8 (l=16)    D = Min. machining Dia.

Parts	Screw	Axial Adjust Screw	Radial Adjust Screw	MountingScrew	Washer	Wrench	Wrench
STWCR/L 10CA-11	FTKA02565	AZ0508F	KHA0408	RHA0620	WA0602	TW 15P	HW20L
12CA-16	FTKA03508	AZ0508F	KHA0412	RHA0625	WA0602	TW 15P	HW20L



# MULTI FUNCTIONAL TOOLS

Korloy Multi-functional tools can be used for machining in grooving, parting-off, facing and forming applications. Its design ensures superior machinability and productivity.



### Application Example

- C02** Application Example
- C04** Technical Information for Multi Functional tools

### KGT

- C07** Technical Information for KGT
- C12** KGT
- C25** KGT Blade for Parting off

### MGT

- C26** Technical Information for MGT
- C28** MGT
- C36** MGT (Face grooving)

### KGT/MGT Cartridge

- C39** Technical Information for KGT/MGT Cartridge
- C40** KGT/MGT Cartridge Holder
- C41** KGT Cartridge
- C42** MGT Cartridge

### MGT Aluminum Wheel Series

- C43** Technical Information for MGT Aluminum Wheel
- C44** MGT Aluminum Wheel

### TB/TB-M

- C47** Technical Information for TB/TB-M
- C51** TB/TB-M

### K Notch

- C55** Technical Information for K Notch
- C57** K Notch

### Saw Man

- C60** Technical Information for Saw Man
- C61** Saw Man

### Saw Man-X

- C63** Technical Information for Saw Man-X
- C65** Saw Man-X

### Fine Tools

- C67** Technical Information for Fine Tools
- C68** Fine Tools

### Grooving/Parting off

- C70** IGH
- C70** DBH
- C71** GFIP

### Special Order Form

- C72** Special Order Form for MGT
- C73** Special Order Form for V-Pulley Insert



# C Application Example

## For external machining

KGEUR/L	MGEUR/L	TBH	K Notch	PH	GH	GFT	DBH	KGEHR/L	MGEHR/L
Width: 2.5 T-MAX: 3.0	Width: 3.0~8.0 T-MAX: 3.0~5.0	Width: 1.25~4.5 T-MAX: 1.5~5.0	Width: 0.75~6.3 T-MAX: 0~6.5	Width: 3.0~5.0 ØD-MAX: 30~50	Width: 1.23~4.28 T-MAX: 1.5~4.0	Width: 1.1~8.0 T-MAX: 2.1~9.0	Width: 3.0~8.0 T-MAX: 14	Width: 2.0~8.0 T-MAX: 17~20	Width: 1.5~8.0 T-MAX: 10~28
KRMN KRGN	MRMN MRGN	TB TB-M	KNG KNGP KNR KNRP KNB	POB	GO GS	GW BF	DC DB	KGGN KGMN KGMR/L KRGN KRMN	MGGN MGMN MGMR MRGN MRMN

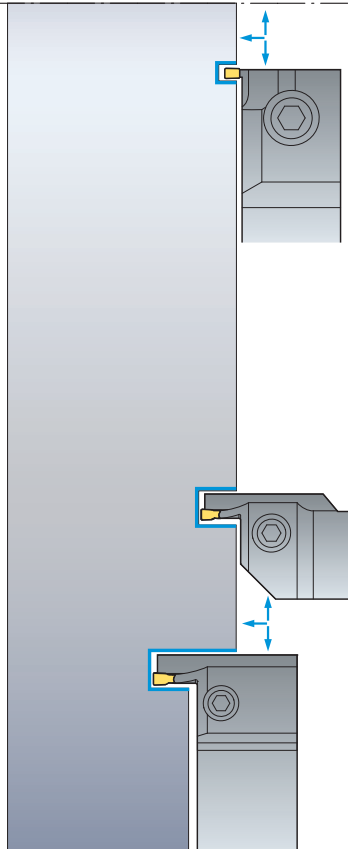
## For internal machining





NFTIH	GFIK	GFIP	IGH	KGIVR/L	MGIVR/L	KGIUR/L	MGIUR/L
Width: 0.75~4.02 T-MAX: 1.3~4.6	Width: 2.0~8.0 T-MAX: 2.0~8.0	Width: 1.1~8.0 T-MAX: 2.1~9.0	Width: 1.25~2.8 T-MAX: 1.5~2.3	Width: 2.0~4.0 T-MAX: 7.0~8.0	Width: 1.5~8.0 T-MAX: 4.0~10	Width: 3.0 T-MAX: 3.0	Width: 3.0~8.0 T-MAX: 3.5~6.5
NFTG NFTF NFTT	GR	GW BF	IG	KGMI KGMN KRMN KGGN	MRMN MGGN MRGN	KRMN KRGN	MRMN














## For face grooving







KGEVR/L
Width: 3.0~4.0 T-MAX: 4.0~8.0
 KGMN
 KGGN
 KRMN
 KRGN

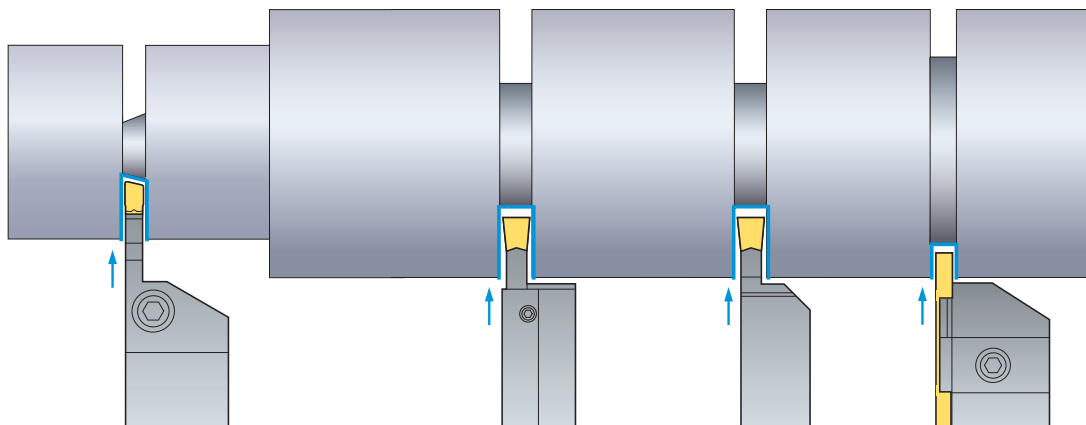
MGEVR/L
Width: 1.5~8.0 T-MAX: 3.0~9.0
 MGMN
 MGGN
 MRMN
 MRGN


FGHH/FGVH
Width: 3.0~5.0 T-MAX: 12~25
 FGD
 FGM
 FMM


MGFHR/L, MGFVR/L
Width: 3.0~4.0 T-MAX: 10~15
 MGMN
 MFMN


KGFHR/L, KGFVR/L
Width: 4.0 T-MAX: 20
 KGMN
 KRMN
 KGGN
 KRGN


## For parting off






KGEHR/L
Width: 3.0 T-MAX: 20
 KGMR/L

MGEHR/L
Width: 2.0~5.0 T-MAX: 10~28
 MGMR/L

KSPB
Width: 2.0~6.0 ØD-MAX: 35~125
 KSP

SPB-(S)
Width: 2.0~6.0 ØD-MAX: 35~125
 SP

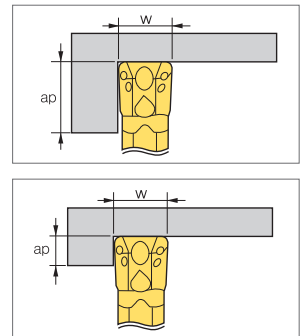
KGTB
Width: 1.5~8.0 ØD-MAX: 26~120
 KGMN
 KGGN-S-R

PH
Width: 3.0~5.0 ØD-MAX: 30~50
 POB

## Turning and Grooving

### Selection of insert

- Feed rate
  - Decide maximum feed rate after considering the insert's characteristics and machine capabilities ( $F_{max} = W \times 0.075$ )
  - Max feed rate should not be larger than the corner radius of the insert
  - In grooving applications, chip evacuation problems can be remedied by using step feed methods at small intervals
- Depth of cut
  - The minimum depth of cut should be bigger than corner radius of insert
  - When deciding on the max depth of cut please consider the machine's cutting load
  - Depending on the shape of the insert, deflection of work piece and clearance angle can be changed

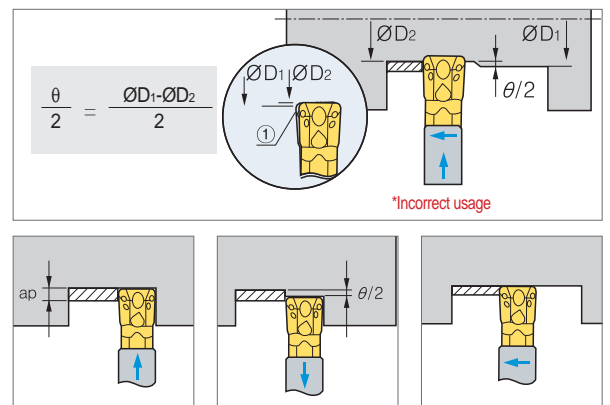


### Notice for turning

- KGT/MGT tools are designed to incur side cutting force from its clearance angle; this feature gives you advantage over a standard ISO insert
- The standard MGT insert also provides a "wiper" effect to improve surface roughness

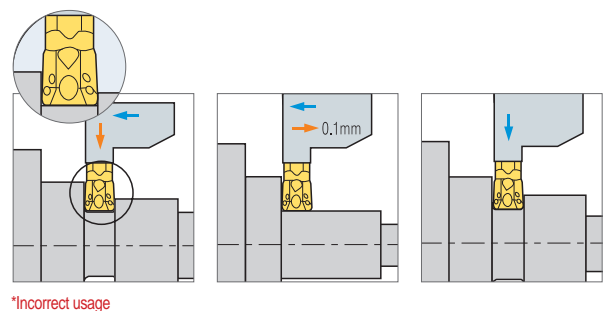
### Notice for finishing (offset need final quality)

- After desired diameter is grooved, continuous turning operation might cause some deflection of the workpiece. In these cases follow the given formula, offsetting these factors enables the desired diameter that you want
- To eliminate the difference in the machined diameter by utilizing the clearance angle (which is commonly generated during the final turning operation) follow the directions above when machining  
To obtain a good surface roughness without offsetting in an application follows the directions below
  - 1) Groove to the desired diameter
  - 2) Pull the tool backs a total distance of  $\theta/2$
  - 3) Continue the external turning operation to desired diameter

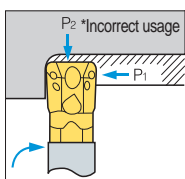


### Notice for MGT turning applications

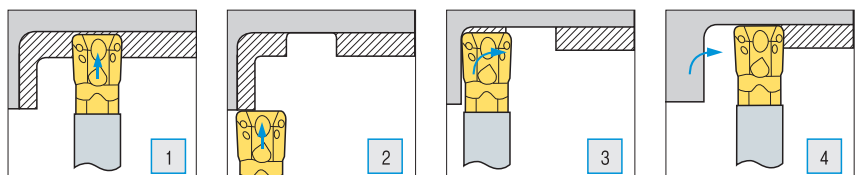
- KGT/MGT tools are available for grooving and turning as a multifunctional tool. When using a M.G.T tool keep in mind that the tool imitates a standard ISO turning application. The application uses a positive clearance angle where a tool's cutting force and depth of cut are all applied in an application. This might create normal wear on the insert, after turning, a grooving process might not meet the desired diameter on the work piece. To off set this, adjust the tool 0.1 mm and return to the original position of the grooving application



### Machining workpiece with a radius bigger than the insert's corner radius

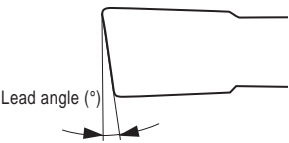

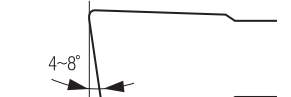



Stabilize your tool pressure. KGT/MGT tools create a cutting load when machining a workpiece with a radius larger than the corner radius of insert (shown in the picture). The unequal cutting force might initially break the insert or holder



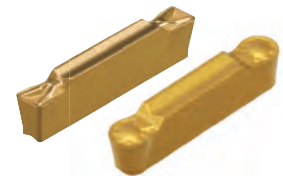
# Parting off & Grooving

## Insert

Lead angle applications	Lead angle 0° (Neutral)	Lead angle 4°~8°	Lead angle 8°~15°
			
<ul style="list-style-type: none"> <li>• 4°- Pipe (Tubing and hollow bar)</li> <li>• 6°- Pipe and solid bar</li> <li>• 8°- Solid bar</li> <li>• 15°- Small diameter Solid bar</li> </ul>	<ul style="list-style-type: none"> <li>• Parting off on solid bar type</li> <li>• Occurring the center stub when parting off</li> <li>• Prevent to be deflected workpiece by cutting direction during parting off</li> <li>• Available for use deep parting depth</li> </ul>	<ul style="list-style-type: none"> <li>• Reduce the center stub when parting off on solid bar type</li> <li>• Reduce the burr when parting off on tubing or hollow bar type</li> </ul>	<ul style="list-style-type: none"> <li>• Parting off on small diameter and hollow bar type</li> <li>• Reduce the burr and center stub when parting off on small diameter solid bar type</li> </ul>
<p>※ Available Inserts: MGMR/L□□□ - □□ - LP/RP, KGMR/L□□□ - □□ - PS/PT                      (Lead angle) (Lead angle)</p>			

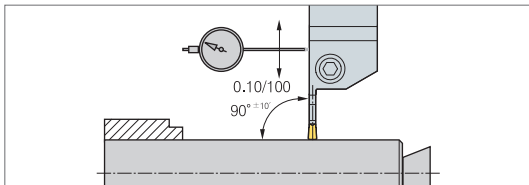
## Selection of Insert

- To properly match the insert and cutting condition, the following factors should be considered
  - Width of insert
  - Chip breaker
  - Grade and nose R
- The relationship between the cutting width and cutting depth
  - Neutral type, inserts with a 0-degree lead angle are best when used an applications maximum depth of cut
  - In general alloy steel, the maximum depth of cut = W x 0.8
- Insert with lead angle
  - To reduce burrs, we recommend using insert with a lead angle.
  - Insert that have larger lead angles reduce burrs but will also decreases tool life
  - In the case where burrs are acceptable, we recommend using a neutral type insert



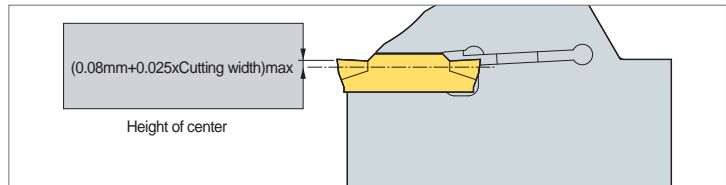
## Setting of holders

- The cutting position should be exactly mounted on machined axis in order to create a perpendicular direction or 90 to minimize vibration



## Setting of parting off

- The edge height of an insert should be set within ±0.1mm based on the center line
  - Parting off should be done as close to the chuck as possible to minimize vibration



## Notice

- Keep a consistent cutting speed and feed
- Use proper amounts of coolant for better performance
- Properly clean the insert pocket before mounting insert

## Usage

- If insert is worn, immediately replace with a new insert. This is to prevent the damage on the workpiece
- If the holder seat is worn or damaged replace with a new one immediately for stable clamping
- Do not grind or regrind the holder seat

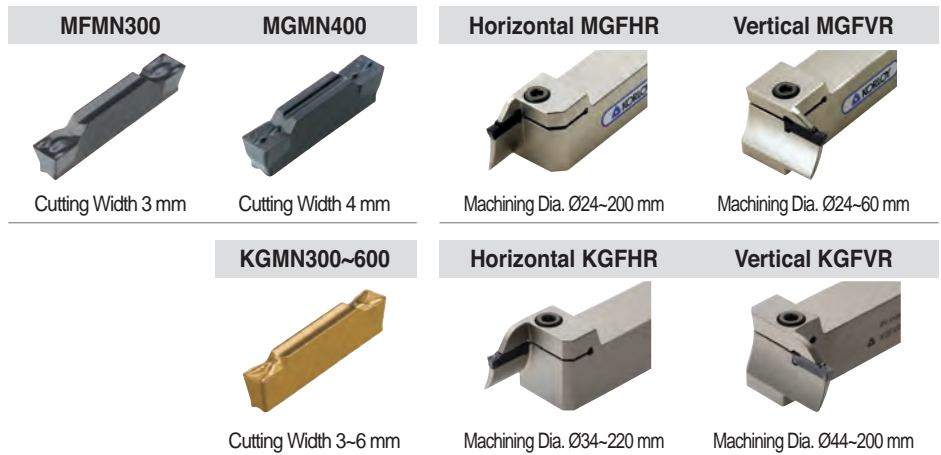
## Selection of chip breaker

- Our chip breakers are designed to narrow chips during grooving operations. Narrow chips usually offer the following advantages
- Decreases friction between chips and the workpiece. This usually gives a better surface roughness finish
- With better chip flow, a machinist is able to increase feed rates due to a reduced cutting load

## Face grooving tools

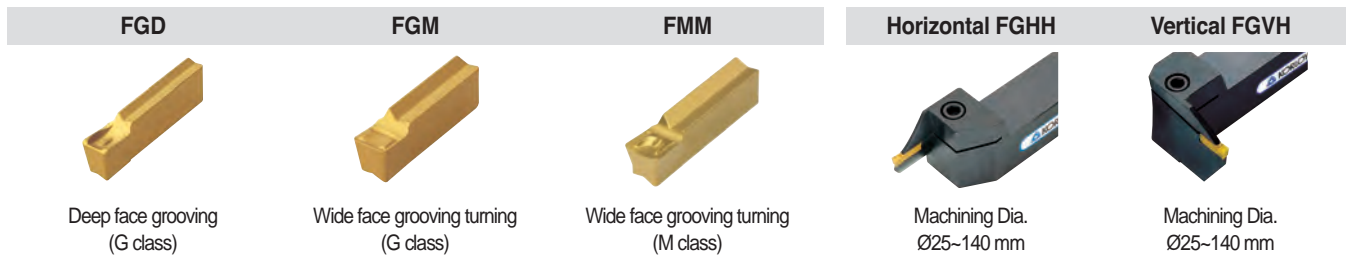
### For shallow grooving

- Economical tools utilizing a double ended cutting edge system
- Newly designed chip breakers that help ensure chip control for various face grooving applications
- KORLOY face grooving tools provide various holder line-ups to give you more options and benefits



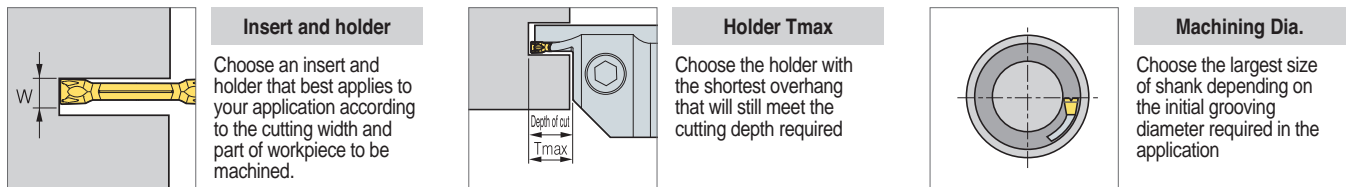
### For deep grooving

- These tools are suitable for deep grooving with a single cutting edge ( $T_{max}$  25 mm)
- A variety of chip breakers enable a machinist to apply a wide range of functions in machining
- A variety of holders ensures multiple application ranges



### Selection system of holder

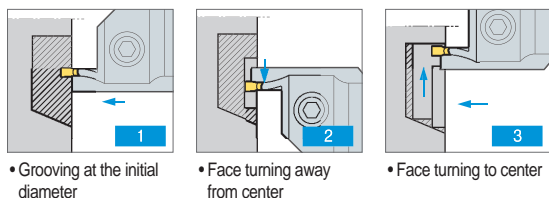
- Follow these 3 simple directions to choose the right insert and holder for your application



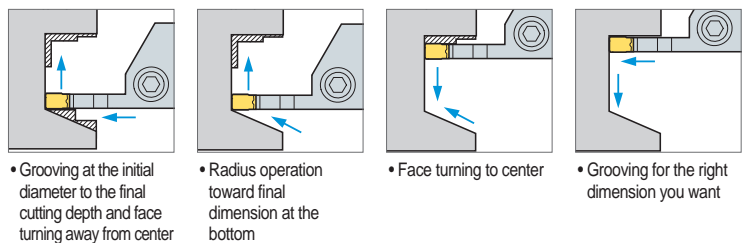
**Notice:** To minimize chattering, use the shortest holder according to  $T_{max}$ .

### Optimization of face grooving

**Roughing:** When face grooving decreases the cutting speed 40% below a normal face turning operation



**Finishing:** When face grooving decreases the cutting speed 40% below a normal face turning operation



### Notice for face grooving

- Before machining, check and adjust the following holder position



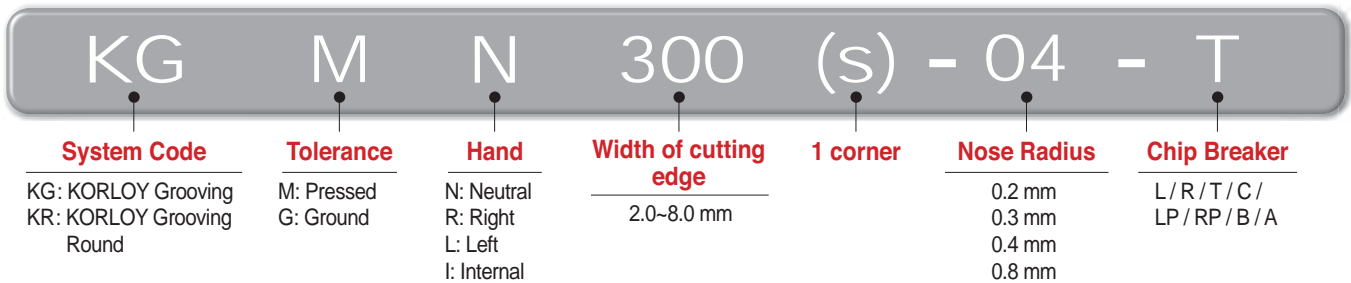
Multi-functional machining with strong clamping system and new technology

# KGT

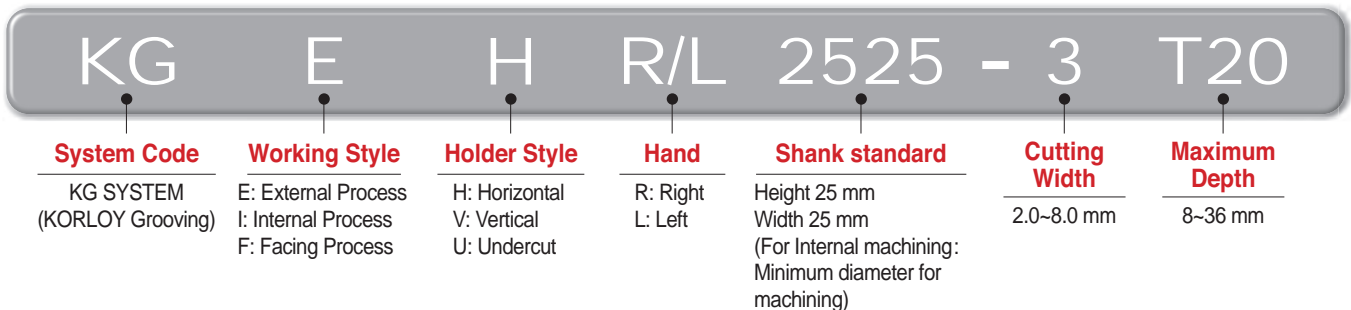
- Double-sided inserts of KGT reduces machining cost
- Strong clamping system ensures stable and accurate machining
- New grade and new technology provide superior tool life
- Various tooling solutions of the KGT improve productivity
- The foreside and clearance face of the KGT insert having cutting edges are optimal for grooving, parting-off, turning and facing with reducing processing time
- Three-dimensional chip breaker ensures excellent chip control in various applications
- The KGT inserts with various chip breakers are available for wide application range
- Special cutting edges are available for quotation

## Code system

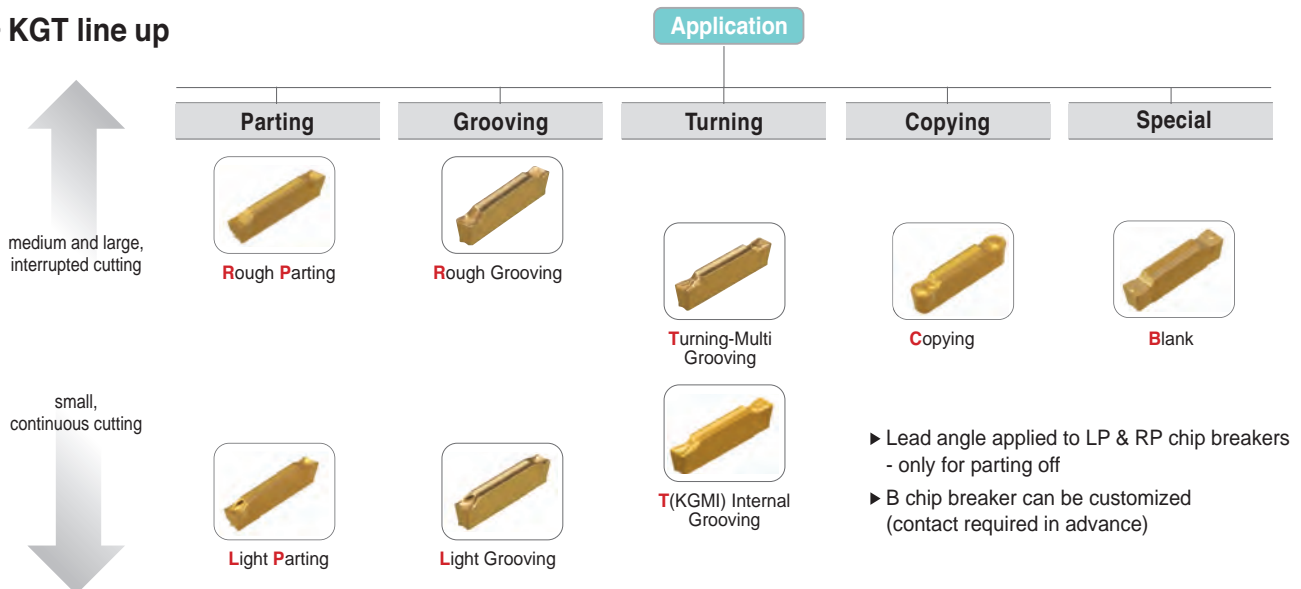
### • Insert



### • Holder
























## KGT line up



# C Technical Information for KGT Series

## Recommended insert

Designation	Geometry	Picture	Application									
			For external machining			For face grooving		For Internal machining		Copying	For relief	Special machining
			Parting	Grooving	Turning	Grooving	Turning	Grooving	Turning	Copying	Relieving	Special
												
KGMN	L Light Grooving		○	◎		○						
	R Rough Grooving		○	◎		○						
	T Turning-Multi Grooving		○	◎	◎	◎	◎					
KGMI	T Internal Grooving							◎	◎			
KRMN	C Copying									◎	◎	
KGMRL	LP Light Parting		◎									
	RP Rough Parting		◎									
KGGN	B Blank			○								◎
	A Aluminum Grooving		○	◎	○							
KRGN	A Aluminum Profiling									◎	◎	
KRMI	C Copying									◎	◎	

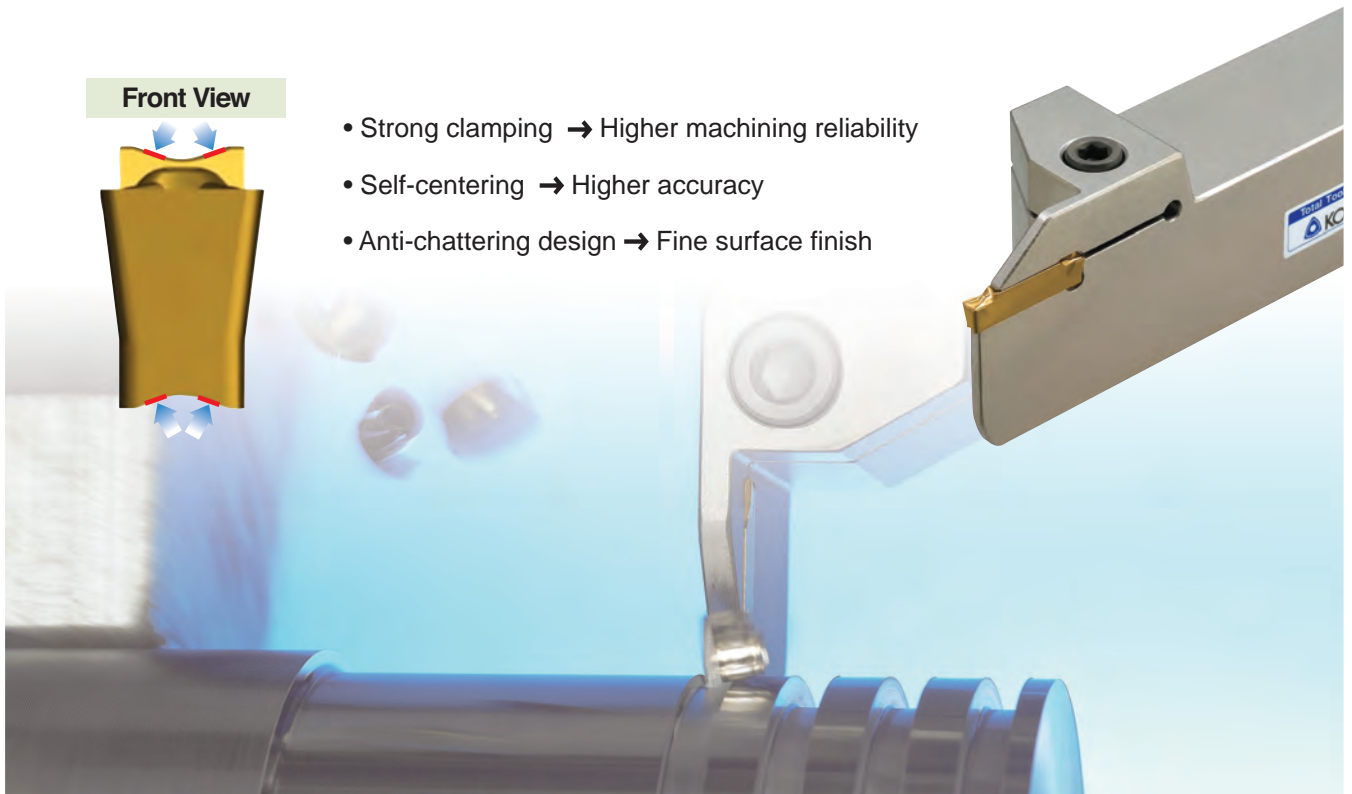
◎ First choice, ○ Second choice

## Features

Front View

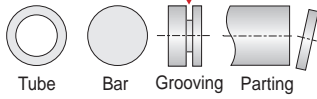


- Strong clamping → Higher machining reliability
- Self-centering → Higher accuracy
- Anti-chattering design → Fine surface finish

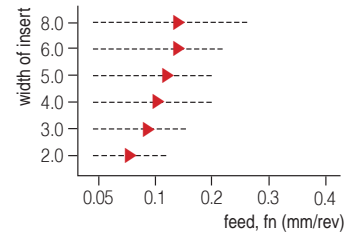


## C/B guide

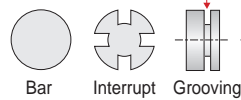
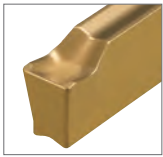
### L For Light Grooving



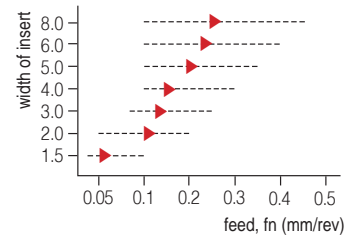
- Sharp cutting edge
- Low feed machining
- Small diameter component
- Low carbon steel
- Alloy steel
- Stainless



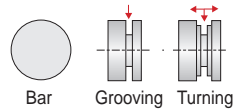
### R For Rough Grooving



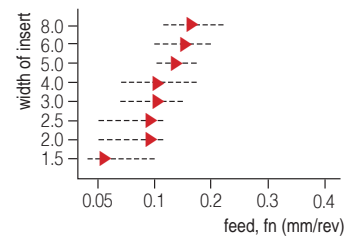
- Strong cutting edge
- High feed machining
- Interrupted cutting
- Carbon steel
- Alloy steel
- Stainless
- Cast iron



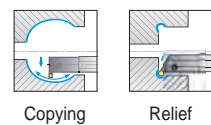
### T For Turning and Multi Grooving



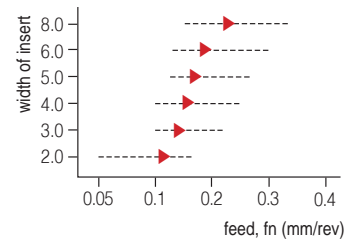
- Sharp cutting edge
- Improved chip control
- Turning & grooving machining
- Carbon steel
- Alloy steel
- Stainless
- Cast iron



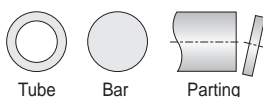
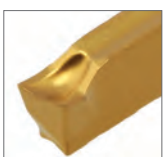
### C For Copying and Relief



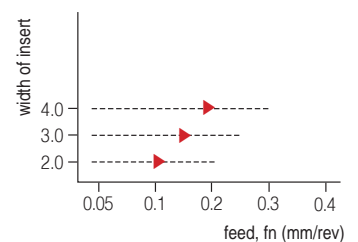
- Improved chip control
- Copying
- Relief
- Carbon steel
- Alloy steel
- Stainless
- Cast iron



### LP For Light Parting



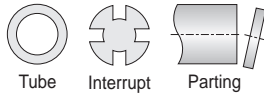
- Sharp cutting edge
- Low feed machining
- Small diameter component
- Right/left handed
- Low carbon steel
- Carbon steel
- Alloy steel
- Stainless





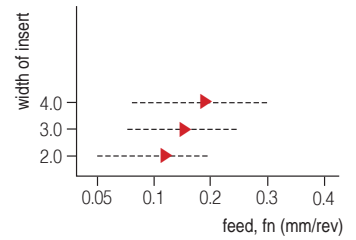
# C Technical Information for KGT Series

## RP For Rought Parting

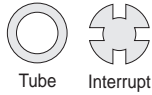


- Strong cutting edge
- High feed machining
- Interrupted cutting
- Right/left handed

- Carbon steel
- Alloy steel
- Cast iron

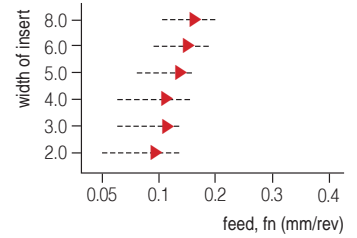


## B For Precision Grooving

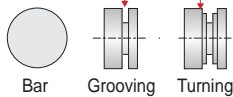


- Ground insert
- Precise tolerance
- Various cutting edge length, Nose R

- Carbon steel
- Alloy steel
- Stainless
- Cast iron

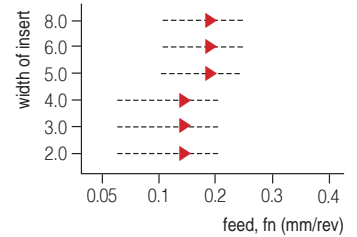


## A For Aluminium Grooving



- Sharp cutting edge
- Precise tolerance

- Aluminum alloy
- Copper alloy



## Grades for recommended application range

Workpiece	Grade	Order of recommended grade	Recommended cutting speed (m/min)						
			50	100	150	200	800		
P Steel	PC5300	1		70	120				
	PC3035	2		70	130				
	NC3225	3			130	220			
	NC5330	4			120	200			
	M Alloy Steel	PC5300	1		60	105			
		PC3035	2		60	110			
		NC3225	3			130	200		
		NC5330	4			90	180		
K Cast iron	PC5300	1		55	90				
	NC5330	2			95	160			
N Non-ferrous metal	H01	1				200	790		
S HRSA	PC5300	1	20	35					



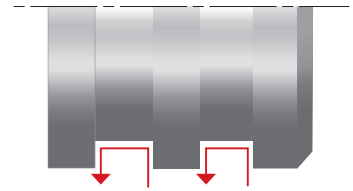
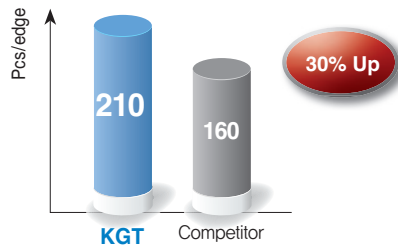
## Performance evaluation

### Multi-function machining

### Turning + Grooving repetition

Optimized geometry for turning + grooving - High efficiency.

- **Workpiece** SM45C
- **Cutting condition**
  - vc = 170 (m/min)
  - fn = 0.15 (mm/rev)
  - ap = 2 mm
  - W = 3 mm
  - wet
- **Designation** KGMN300-04-T (PC5300)

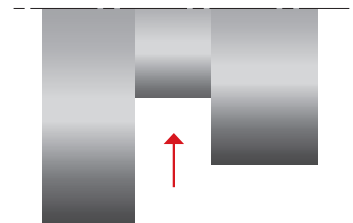
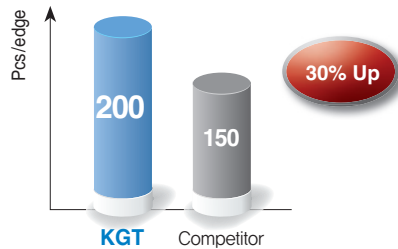


### Grooving

### Shoulder Grooving

Tough geometry for interrupted and deep grooving.

- **Workpiece** SUS304
- **Cutting condition**
  - vc = 120 (m/min)
  - fn = 0.12 (mm/rev)
  - ap = 5 mm
  - W = 4 mm
  - wet
- **Designation** KGMN400-03-R (PC5300)

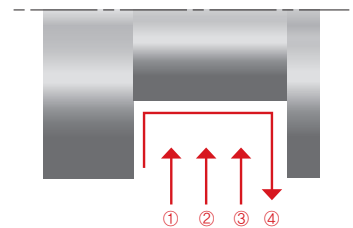


### Shaft machining

### Grooving (Roughing) & Turning (Finishing)

Excellent chip control for higher efficiency.

- **Workpiece** SCM440
- **Cutting condition**
  - vc = 150 (m/min)
  - fn = 0.15 (mm/rev)
  - ap = 5 mm
  - W = 3 mm x 3
  - wet
- **Designation** KGMN300-04-T (PC5300)

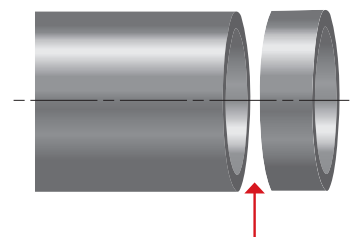
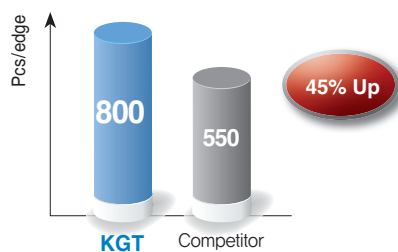


### Parting off


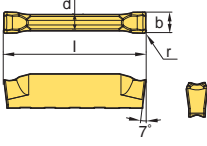

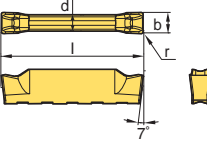

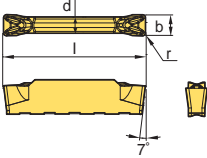

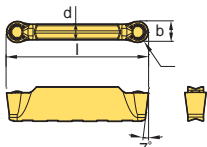

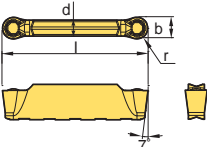
### Pipe Parting-off

Exclusive parting-off chip breaker for longer tool life. / Sharp geometry for less burr.

- **Workpiece** SUS304
- **Cutting condition**
  - vc = 140 (m/min)
  - fn = 0.15 (mm/rev)
  - ap = 2 mm
  - W = 3 mm
  - wet
- **Designation** KGMR300-6D-LP (PC5300)



## Insert


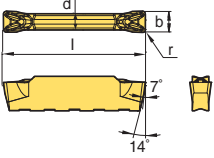

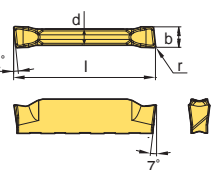

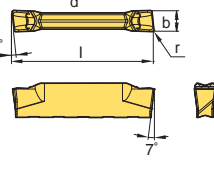

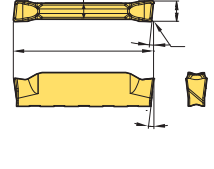

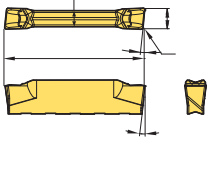

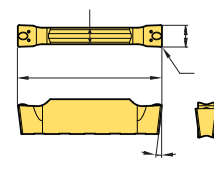
Application	Picture	Designation	Coated						Dimensions (mm)					Configuration	Page	
			NC3225	NC5330	NC6315	PC3035	PC5300	PC9030	b	r	l	d	$\alpha^\circ$			
Grooving		KGMN	200-02-L	●	●		●	●	●	2.0	0.2	20	1.7	-		C14~21 C23
			300-02-L	●	●		●	●	●	3.0	0.2	20	2.3	-		
			400-02-L	●	●		●	●	●	4.0	0.2	20	3.3	-		
			500-03-L	●	●		●	●		5.0	0.3	25	4.1	-		
			600-03-L	●	●			●		6.0	0.3	25	5.1	-		
Grooving - Parting off		KGMN	150-015-R	●	●			●		1.5	0.15	16	1.2	-		C14~21 C23
			200-02-R	●	●		●	●	●	2.0	0.2	20	1.7	-		
			300-02-R	●	●		●	●	●	3.0	0.2	20	2.3	-		
			400-03-R	●	●		●	●	●	4.0	0.3	20	3.3	-		
			500-03-R		●			●		5.0	0.3	25	4.1	-		
			600-03-R		●			●		6.0	0.3	25	5.1	-		
			800-04-R		●			●		8.0	0.4	30	6.1	-		
Grooving - Turning		KGMN	150-015-T	●	●	●		●		1.5	0.15	16	1.2	-		C14~21 C23
			200-02-T	●	●	●	●	●	●	2.0	0.2	20	1.7	-		
			250-02-T	●	●			●		2.5	0.2	20	2.0	-		
			300-02-T	●	●	●	●	●	●	3.0	0.2	20	2.3	-		
			04-T	●	●	●	●	●	●	3.0	0.4	20	2.3	-		
			400-04-T	●	●	●	●	●	●	4.0	0.4	20	3.3	-		
			08-T	●	●	●	●	●	●	4.0	0.8	20	3.3	-		
			500-04-T	●	●	●	●	●	●	5.0	0.4	25	4.1	-		
			08-T	●	●	●	●	●	●	5.0	0.8	25	4.1	-		
			600-04-T	●	●	●	●	●	●	6.0	0.4	25	5.1	-		
			08-T	●	●	●	●	●		6.0	0.8	25	5.1	-		
800-08-T	●		●	●	●		8.0	0.8	30	6.1	-					
Relief Profiling		KRMN	200-C	●	●	●	●	●		2.0	1.0	20	1.7	-		C14~22
			300-C	●	●	●	●	●		3.0	1.5	20	2.2	-		
			400-C	●	●	●	●	●		4.0	2.0	20	3.2	-		
			500-C	●	●	●	●	●		5.0	2.5	25	4.0	-		
			600-C	●	●	●	●	●		6.0	3.0	25	5.0	-		
			800-C	●	●	●		●		8.0	4.0	30	6.0	-		
Profiling		KRMI	200-C							2.0	1.0	20	1.7	-		C23
			300-C							3.0	1.5	20	2.2	-		
			400-C							4.0	2.0	20	3.2	-		

• You can grind the chip breaker, 'B' as any shape you want. If you want any special shape of chip breaker, please contact your distributor.

● : Stock item



## Insert


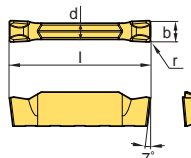

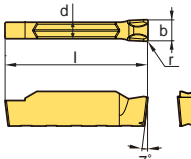

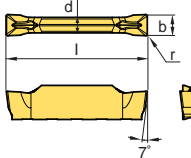
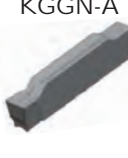
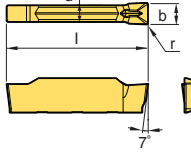

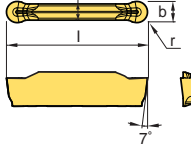
Application	Picture	Designation	Coated					Uncoated		Dimensions (mm)					Configuration	Page
			NC3215	NC3225	NC5330	NC6315	PC5300	PC9030	H01	H05	b	r	l	d		
Grooving - Internal		<b>KGMI</b> 200-02-T					●			2.0	0.2	20	1.7	-		C23
		300-04-T					●			3.0	0.4	20	2.3	-		
		400-04-T					●			4.0	0.4	20	3.3	-		
Parting off (Right handed)		<b>KGMR</b> 200-6D-LP			●		●			2.0	0.2	20	1.7	6		C14 C16
		8D-LP								2.0	0.2	20	1.7	8		
		15D-LP			●		●			2.0	0.2	20	1.7	15		
		300-6D-LP			●		●			3.0	0.2	20	2.3	6		
		15D-LP			●		●			3.0	0.2	20	2.3	15		
		400-4D-LP			●		●			4.0	0.3	20	3.3	4		
		15D-LP			●		●			4.0	0.3	20	3.3	15		
500-4D-LP									5.0	0.3	25	4.1	4			
Parting off (Right handed)		<b>KGMR</b> 200-6D-RP			●		●			2.0	0.2	20	1.7	6		C14 C16
		8D-RP								2.0	0.2	20	1.7	8		
		15D-RP			●		●			2.0	0.2	20	1.7	15		
		300-6D-RP			●		●			3.0	0.2	20	2.3	6		
		15D-RP			●		●			3.0	0.2	20	2.3	15		
		400-4D-RP			●		●			4.0	0.3	20	3.3	4		
		15D-RP			●		●			4.0	0.3	20	3.3	15		
500-4D-RP									5.0	0.3	25	4.1	4			
Parting off (Left handed)		<b>KGML</b> 200-6D-LP								2.0	0.2	20	1.7	6		C14 C16
		15D-LP								2.0	0.2	20	1.7	15		
		300-6D-LP								3.0	0.2	20	2.3	6		
		15D-LP								3.0	0.2	20	2.3	15		
		400-4D-LP								4.0	0.2	20	3.3	4		
15D-LP								4.0	0.2	20	3.3	15				
Parting off (Left handed)		<b>KGML</b> 200-6D-RP								2.0	0.2	20	1.7	6		C14 C16
		15D-RP								2.0	0.2	20	1.7	15		
		300-6D-RP								3.0	0.2	20	2.3	6		
		15D-RP								3.0	0.2	20	2.3	15		
		400-4D-RP								4.0	0.2	20	3.3	4		
15D-RP								4.0	0.2	20	3.3	15				
Grooving (Ground insert)		<b>KGGN</b> 265-015-B								2.65	0.15	20	2.3	-		C14
		300-020-B								3.0	0.20	20	2.3	-		
		040-B								3.0	0.40	20	2.3	-		
		315-015-B								3.15	0.15	20	2.3	-		
		400-040-B								4.0	0.40	20	3.3	-		
		080-B								4.0	0.80	20	3.3	-		
		415-015-B								4.15	0.15	20	3.3	-		
		478-055-B								4.78	0.55	25	4.1	-		
		500-080-B								5.0	0.80	25	4.1	-		
		515-015-B								5.15	0.15	25	4.1	-		
		600-080-B								6.0	0.80	25	5.1	-		
		120-B								6.0	1.20	25	5.1	-		
800-080-B								8.0	0.80	30	6.1	-				
120-B								8.0	1.20	30	6.1	-				

• You can grind the chip breaker, 'B' as any shape you want. If you want any special shape of chip breaker, please contact your distributor.

• : Stock item



## Insert

Application	Picture	Designation	Coated						Uncoated		Dimensions (mm)					Configuration	Page
			NC3215	NC3225	NC5330	NC6315	PC5300	PC9030	H01	H05	b	r	l	d	$\alpha^\circ$		
Grooving - Parting off (Ground Insert)	 KGGN-R <span style="color:red">new</span>	KGGN 200-02-R								2.0	0.2	20	1.7	-		C14-21	
		300-02-R								3.0	0.2	20	2.3	-			
		400-03-R								4.0	0.3	20	3.3	-			
		500-03-R								5.0	0.3	25	4.1	-			
		600-03-R								6.0	0.3	25	5.1	-			
		800-04-R								8.0	0.4	30	6.1	-			
Grooving - Parting off (Single Insert)	 KGGN-R <span style="color:red">new</span>	KGGN 200S-02-R								2.0	0.2	19.9	1.7	-		C24	
		300S-02-R					●			3.0	0.2	19.9	2.3	-			
		400S-03-R					●			4.0	0.3	19.9	3.3	-			
		500S-03-R					●			5.0	0.3	24.9	4.1	-			
		600S-03-R					●			6.0	0.3	24.9	5.1	-			
		800S-04-R					●			8.0	0.4	24.9	6.1	-			
Aluminum Grooving	 KGGN-A <span style="color:red">new</span>	KGGN 200-02-A						●	2.0	0.2	20	1.7	-		C24		
		300-02-A						●	3.0	0.2	20	2.3	-				
		400-04-A						●	4.0	0.4	20	3.3	-				
		500-04-A						●	5.0	0.4	25	4.1	-				
		600-04-A						●	6.0	0.4	25	5.1	-				
Aluminum Grooving (Single Insert)	 KGGN-A <span style="color:red">new</span>	KGGN 200S-02-A								2.0	0.2	20	1.7	-		C24	
		300S-02-A								3.0	0.2	20	2.3	-			
		400S-04-A								4.0	0.4	20	3.3	-			
		500S-04-A								5.0	0.4	25	4.1	-			
		600S-04-A								6.0	0.4	25	5.1	-			
Aluminum Grooving	 KRGN-A <span style="color:red">new</span>	KRGN 300-A						●	3.0	1.5	20	2.3	-		C14-21		
		400-A						●	4.0	2.0	20	3.3	-				
		500-A						●	5.0	2.5	25	4.1	-				
		600-A						●	6.0	3.0	25	5.1	-				
		800-A						●	8.0	4.0	30	6.1	-				

• You can grind the chip breaker, 'B' as any shape you want. If you want any special shape of chip breaker, please contact your distributor.

● : Stock item



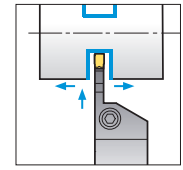
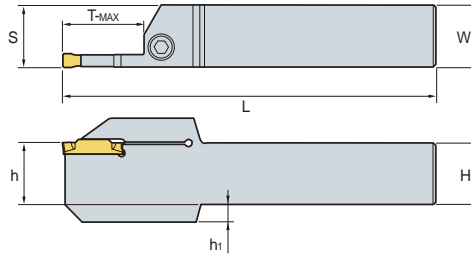
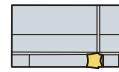
# KGEHR/L

For grooving, turning, parting off, and relief machining



KGGN  
KGMR/L  
KRGN

KGMM  
KRMN



• R type insert  
(mm)

Designation		H = (h)	W	L	S	h1	T-MAX	Inserts	Screw	Wrench
KGEHR/L	1616-1.5-T14	16	16	100	16.2	-	14	KGMM150-□-□	MHA0512	HW40L
	2020-1.5-T14	20	20	125	20.2	-	14			
	2525-1.5-T14	25	25	150	25.2	-	14			
	1212-2-T08	12	12	100	12.2	-	8			
	1616-2-T08	16	16	100	16.2	-	8	KGMM200-□-□ KGMR/L200-□-□ KRMN200-C KGGN200-□-□	MHA0512	HW40L
	2020-2-T08	20	20	125	20.2	-	8			
	2525-2-T08	25	25	150	25.2	-	8			
	1616-2-T12	16	16	100	16.2	-	12			
	2020-2-T12	20	20	125	20.2	-	12			
	2525-2-T12	25	25	150	25.2	-	12			
	1616-2-T17	16	16	100	16.2	-	17			
	2020-2-T17	20	20	125	20.2	-	17			
	2525-2-T17	25	25	150	25.2	-	17			
	1616-2.5-T17	16	16	100	16.3	-	17	KGMM250-□-□	MHA0512	HW40L
	2020-2.5-T17	20	20	125	20.3	-	17			
	2525-2.5-T17	25	25	150	25.3	-	17			
	1616-3-T10	16	16	100	16.4	-	10	KGMM300-□-□ KGMR/L300-□-□ KRMN300-C KGGN300-□-□ KRGN300-□	MHA0512	HW40L
	2020-3-T10	20	20	125	20.4	-	10			
	2525-3-T10	25	25	150	25.4	-	10			
	3232-3-T10	32	32	170	32.4	-	10			
	1616-3-T13	16	16	100	16.4	-	13			
	2020-3-T13	20	20	125	20.4	-	13			
	2525-3-T13	25	25	150	25.4	-	13			
	1616-3-T20	16	16	100	16.4	-	20			
	2020-3-T20	20	20	125	20.4	-	20			
	2525-3-T20	25	25	150	25.4	-	20			
	3232-3-T20	32	32	170	32.4	-	20			
	2525-3-T25	25	25	150	25.4	-	25	KGMM400-□-□ KGMR/L400-□-□ KRMN400-C KGGN400-□-□ KRGN400-□	BHA0616	HW50L
	1616-4-T10	16	16	100	16.4	-	10			
	2020-4-T10	20	20	125	20.4	-	10			
	2525-4-T10	25	25	150	25.4	-	10			
	3232-4-T10	32	32	150	32.4	-	10			
	1616-4-T15	16	16	100	16.4	-	15			
	2020-4-T15	20	20	125	20.4	-	15			
	2525-4-T15	25	25	150	25.4	-	15			
	1616-4-T20	16	16	100	16.4	-	20			
	2020-4-T20	20	20	125	20.4	-	20			
	2525-4-T20	25	25	150	25.4	-	20			
	3232-4-T20	32	32	170	32.4	-	20			
	1616-4-T25	16	16	100	16.4	-	25			
2020-4-T25	20	20	125	20.4	-	25				
2525-4-T25	25	25	150	25.4	-	25				

↻ Applicable inserts C12 ~ C14

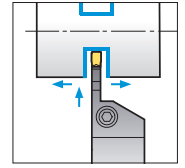
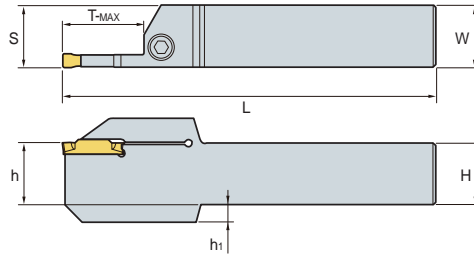
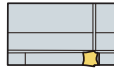


## KGEHR/L

For grooving, turning, parting off, and relief machining



KGGN KGMN  
KGMR/L KRMN  
KRGN



• R type insert  
(mm)

Designation		H = (h)	W	L	S	h <sub>1</sub>	T-MAX	Inserts	Screw	Wrench			
KGEHR/L	2020-5-T12	20	20	125	20.5	-	12	KGMN500-□-□ KRMN500-C KGGN500-□-□ KRGN500-□	BHA0616	HW50L			
	2525-5-T12	25	25	150	25.5	-	12						
	2020-5-T15	20	20	125	20.55	-	15						
	2525-5-T15	25	25	150	25.55	-	15						
	3232-5-T15	32	32	170	32.55	-	15						
	2020-5-T20	20	20	125	20.5	-	20						
	2525-5-T20	25	25	150	25.5	-	20						
	3232-5-T20	32	32	170	32.5	-	20						
	2525-5-T32	25	25	150	25.5	7	32				BHA0620	HW50L	
	2020-6-T12	20	20	125	20.5	-	12				KGMN600-□-□ KRMN600-C KGGN600-□-□ KRGN600-□	BHA0616	HW50L
	2525-6-T12	25	25	150	25.5	-	12						
	2525-6-T15	25	25	150	25.55	-	15						
	3232-6-T15	32	32	170	32.55	-	15						
	2020-6-T20	20	20	125	20.5	-	20						
	2525-6-T20	25	25	150	25.5	-	20						
	3232-6-T20	32	32	170	32.5	-	20						
	2525-6-T32	25	25	150	25.5	7	32	BHA0620	HW50L				
	2525-8-T16	25	25	150	26	-	16	KGMN800-□-□ KRMN800-C KGGN800-□-□ KRGN800-□	BHA0616	HW50L			
	3232-8-T16	32	32	170	33.05	-	16						
	2525-8-T25	25	25	150	26	-	25						
3232-8-T25	32	32	170	33	-	25							
2525-8-T36	25	25	150	26	7	36	BHA0620				HW50L		
3232-8-T36	32	32	170	33	-	36							

➔ Applicable inserts C12 ~ C14

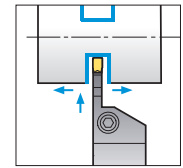
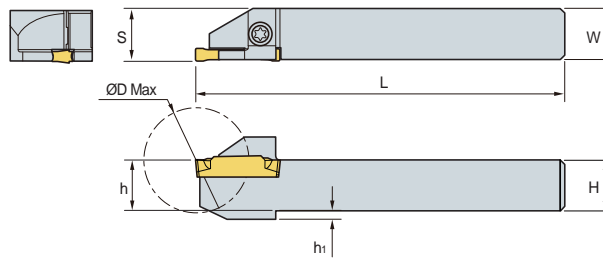


# KGEHR/L-D00A (Auto Tool)

For grooving, turning, parting off machining



KGGN KGMN  
KGMR/L KRMN



• R type insert  
(mm)

Designation		H = (h)	W	L	S	h <sub>1</sub>	ØD Max	Inserts	Screw	Wrench
KGEHR/L	1010-2-D20A	10	10	125	10.2	2	20	KGMN200-□-□ KGMR/L200-□-□ KRMN200-C KGGN200-□-□	ETNA0412	TW15L
	1212-2-D25A	12	12	125	12.2	2	25			
	1414-2-D25A	14	14	125	14.2	-	25			
	1616-2-D32A	16	16	125	16.2	-	32			
	1212-3-D25A	12	12	125	12.4	2	25			
	1616-3-D32A	16	16	125	16.4	-	32			

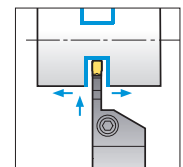
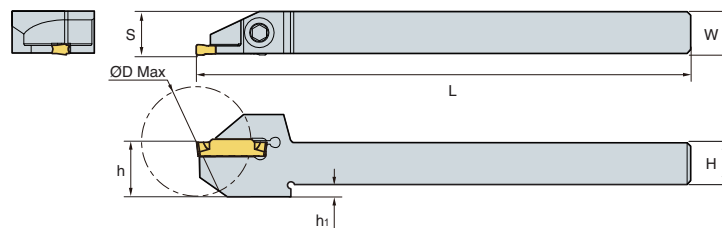
↻ Applicable inserts C12 ~ C14

# KGEHR/L-D00B (Auto Tool)

For grooving, turning, parting off machining



KGGN KGMN  
KRMN KGMR/L



• R type insert  
(mm)

Designation		H = (h)	W	L	S	h <sub>1</sub>	ØD Max	Inserts	Screw	Wrench
KGEHR/L	1010-2-D30B	10	10	140	10.2	6.6	30	KGMN200-□-□ KGMR/L200-□-□ KRMN200-C KGGN200-□-□	MHA0512	HW40L
	1212-2-D25B	12	12	140	12.5	3.5	25			
	1212-2-D30B	12	12	140	12.2	3.5	30			
	1616-2-D25B	16	16	140	16.2	-	25			
	1616-2-D32B	16	16	140	16.2	-	32	KGMN300-□-□ KGMR/L300-□-□ KRMN300-C KGGN300-□-□		
	1212-3-D25B	12	12	140	12.4	3.5	25			
	1212-3-D32B	12	12	140	12.4	3.5	32			
	1616-3-D25B	16	16	140	16.4	-	25			
1616-3-D32B	16	16	140	16.4	-	32				

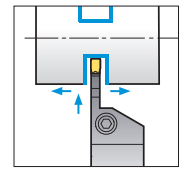
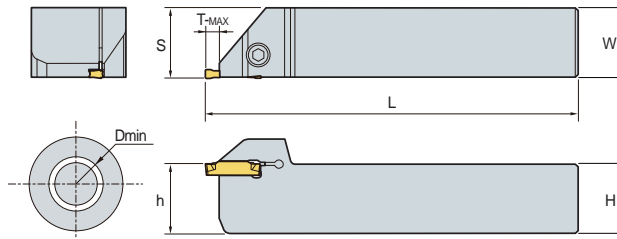
↻ Applicable inserts C12 ~ C14

## KGEHR/L-T00



For grooving, turning, face grooving machining



KG MN    KR MN  
KG GN    KR GN



• R type insert  
(mm)

Designation	H = (h)	W	L	S	ØD Min	T-MAX	Inserts	Screw	Wrench
									
<b>KGEHR/L 1616-3-T00</b>	16	16	100	16.4	80	4.8	KG MN300-□-□ KR MN300-C KG GN300-□-□ KR GN300-□	MHA0512	HW40L
	20	20	125	20.4	80	4.8			
	25	25	150	25.4	80	4.8			
<b>1616-4-T00</b>	16	16	100	16.4	80	4.8	KG MN400-□-□ KR MN400-C KG GN400-□-□ KR GN400-□	BHA0616	HW50L
	20	20	125	20.4	80	4.8			
	25	25	150	25.4	80	4.8			
<b>2020-6-T00</b>	20	20	125	20.5	80	6.0	KG MN600-□-□ KR MN600-C KG GN600-□-□ KR GN600-□	BHA0616	HW50L
	25	25	150	25.5	80	6.0			

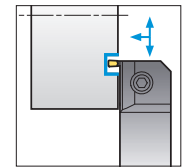
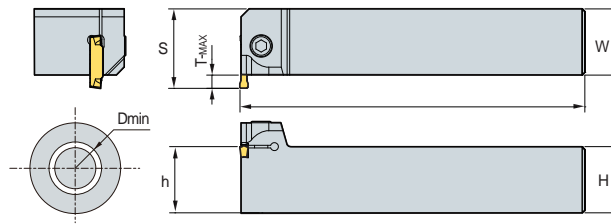
↻ Applicable inserts C12 ~ C14

# KGEVR/L-T00

For grooving, turning, face grooving machining



KGMN KRMN  
KRGN KGGN



• R type insert  
(mm)

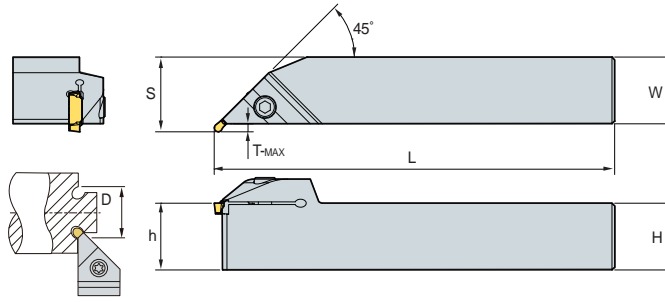
Designation	H = (h)	W	L	S	ØD Min	T-MAX	Inserts	Screw	Wrench
<b>KGEVR/L</b> 2020-1.5 -T00	20	20	125	23.5	120	3	KGMN150-□-□	MHA0512	HW40L
	25	25	150	28.5	120	3			
	32	32	170	35.5	120	3			
2020-2 -T00	20	20	125	23.5	120	3	KGMN200-□-□ KRMN200-C KGGN200-□-□-□	MHA0512	HW40L
	25	25	150	28.5	120	3			
	32	32	170	35.5	120	3			
2020-2.5 -T00	20	20	125	24.5	80	4	KGMN250-□□	MHA0512	HW40L
	25	25	150	29.5	80	4			
	32	32	170	36.5	80	4			
2020-3-T00	20	20	125	25	80	4.8	KGMN300-□-□ KRMN300-C KGGN300-□-□ KRGN300-□	MHA0512	HW40L
	25	25	150	30	80	4.8			
	32	32	170	37	80	4.8			
2020-4-T00	20	20	125	25	80	4.8	KGMN400-□-□ KRMN400-C KGGN400-□-□ KRGN400-□	BHA0616	HW50L
	25	25	150	30	80	4.8			
	32	32	170	37	80	4.8			
2020-5 -T00	20	20	125	29.5	60	6	KGMN500-□-□ KRMN500-C KGGN500-□-□ KRGN500-□	BHA0616	HW50L
	25	25	150	31.5	60	6			
	32	32	170	38.5	60	6			
2020-6 -T00	20	20	125	26.5	60	6	KGMN600-□-□ KRMN600-C KGGN600-□-□ KRGN600-□	BHA0616	HW50L
	25	25	150	31.5	80	6			
	32	32	170	38.5	60	6			
2525-8 -T00	25	25	150	33.5	50	8	KGMN800-□-□ KRMN800-C KGGN800-□-□ KRGN800-□	BHA0616	HW50L
	32	32	170	38.5	50	8			
	32	32	170	38.5	50	8			

↻ Applicable inserts C12 ~ C14

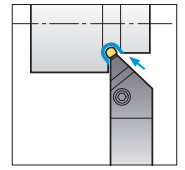
## KGEUR/L



KRMN  
KRGN



For relief machining



• R type insert  
(mm)

Designation	H = (h)	W	L	S	ØD Min	T-MAX	Inserts	Screw	Wrench	
<b>KGEUR/L</b> 1616-3	16	16	100	19	40	2.8	KRMN300-C KRGN300-□	MHA0512	HW40L	
	2020-3	20	20	125	23	40				2.8
	2525-3	25	25	150	28	40				2.8
	3232-3	32	32	170	35	40				2.8
1616-4	16	16	100	19	40	2.8	KRMN400-C KRGN400-□	BHA0616	HW50L	
	2020-4	20	20	125	23	40				2.8
	2525-4	25	25	150	28	40				2.8
	3232-4	32	32	170	35	40				2.8
2020-5	20	20	125	23.5	50	3.3	KRMN500-C KRGN500-□	BHA0616	HW50L	
	2525-5	25	25	150	28.5	50				3.3
	3232-5	32	32	170	35.5	50				3.3
2020-6	20	20	125	23.5	50	3.3	KRMN600-C KRGN600-□	BHA0616	HW50L	
	2525-6	25	25	150	28.5	50				3.3
	3232-6	32	32	170	35.5	50				3.3
2525-8	25	25	150	28.5	65	3.3	KRMN800-C KRGN800-□	BHA0616	HW50L	
3232-8	32	32	170	35.5	65	3.3				

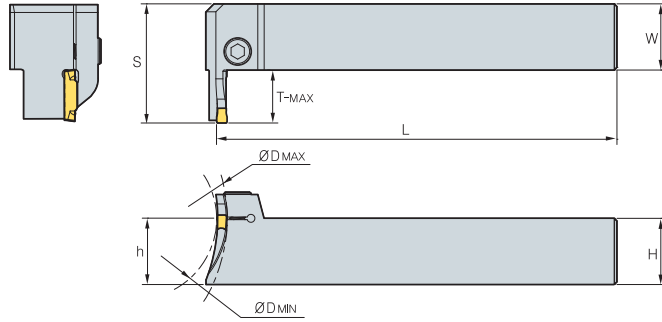
↻ Applicable inserts C12 ~ C14

# KGFVR/L

For face grooving machining



KGMN KRMN  
KGGN KRGN



• R type insert  
(mm)

Designation	H = (h)	W	L	S	T-MAX	ØD		Inserts	Screw	Wrench	
						MIN	MAX				
<b>KGFVR/L</b> 325-34/50-T10	25	25	150	36	10	34	50	KGMN300-□-□ KRMN300-C KGGN300-□-□ KRGN300-□	MHA0512	HW40L	
	44/60-T15	25	25	150	41	15	44				60
	54/85-T15	25	25	150	41	15	54				85
425-32/50-T15	25	25	150	41	15	32	50	KGMN400-□-□ KRMN400-C KGGN400-□-□ KRGN400-□	BHA0616	HW50L	
	42/60-T15	25	25	150	41	15	42				60
	44/70-T20	25	25	150	45.5	20	44				70
	52/85-T15	25	25	150	41	15	52				85
	60/120-T20	25	25	150	45.5	20	60				120
112/200-T20	25	25	150	45.5	20	112	200				
525-50/80-T20	25	25	150	46	20	50	80	KGMN500-□-□ KRMN500-C KGGN500-□-□ KRGN500-□	BHA0616	HW50L	
	70/110-T20	25	25	150	46	20	70				110
	100/150-T20	25	25	150	46	20	100				150
	140/200-T20	25	25	150	46	20	140				200
	200-T20	25	25	150	46	20	200				∞
625-48/85-T20	25	25	150	46	20	48	85	KGMN600-□-□ KRMN600-C KGGN600-□-□ KRGN600-□	BHA0616	HW50L	
	73/150-T20	25	25	150	46	20	73				150
	138/250-T20	25	25	150	46	20	138				250
	250-T20	25	25	150	46	20	250				∞

↻ Applicable inserts C12 ~ C14

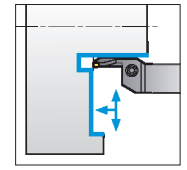
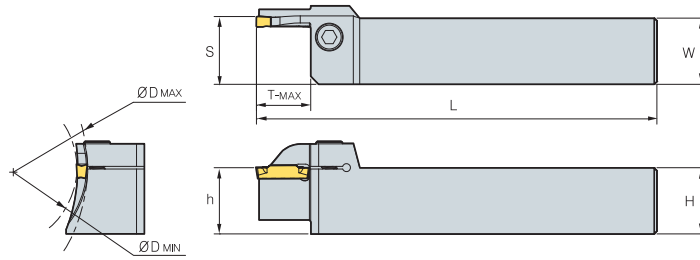
## KGFHR/L

For face grooving machining



KG MN  
KGGN

KR MN  
KRGN



• R type insert  
(mm)

Designation	H = (h)	W	L	S	T-MAX	ØD		Inserts	Screw	Wrench
						MIN	MAX			
<b>KGFHR/L 320-34/50-T10</b>		20	20	150	20.5	10	34	50	MHA0512	HW40L
	<b>44/70-T15</b>	20	20	150	20.5	15	44	70		
	<b>64/100-T15</b>	20	20	150	20.5	15	64	100		
<b>325-34/50-T10</b>		25	25	150	25.5	10	34	50	MHA0512	HW40L
	<b>44/70-T15</b>	25	25	150	25.5	15	44	70		
	<b>64/100-T15</b>	25	25	150	25.5	15	64	100		
<b>420-34/50-T16</b>		20	20	150	20.5	16	34	50	BHA0616	HW50L
	<b>42/70-T16</b>	20	20	150	20.5	16	42	70		
	<b>62/120-T16</b>	20	20	150	20.5	16	62	120		
	<b>112/200-T16</b>	20	20	150	20.5	16	112	200		
<b>425-34/50-T20</b>		25	25	150	25.6	20	34	50	BHA0616	HW50L
	<b>40/60-T10</b>	25	25	150	25.6	10	40	60		
	<b>44/70-T20</b>	25	25	150	25.6	20	44	70		
	<b>84/92-T20</b>	25	25	150	25.6	20	84	92		
	<b>60/120-T20</b>	25	25	150	25.6	20	60	120		
	<b>112/200-T20</b>	25	25	150	25.6	20	112	200		
<b>525-50/80-T15</b>		25	25	150	25.6	15	50	80	BHA0616	HW50L
	<b>50/80-T25</b>	25	25	150	25.6	25	50	80		
	<b>70/110-T15</b>	25	25	150	25.6	15	70	110		
	<b>70/110-T25</b>	25	25	150	25.6	25	70	110		
	<b>100/150-T25</b>	25	25	150	25.6	25	100	150		
	<b>140/200-T25</b>	25	25	150	25.6	25	140	200		
	<b>190/220-T10</b>	25	25	150	25.6	10	190	200		
	<b>200-T25</b>	25	25	150	25.6	25	200	∞		
<b>625-170/190-T10</b>		25	25	150	25.6	10	170	190	BHA0616	HW50L
	<b>190/220-T10</b>	25	25	150	25.6	10	190	200		

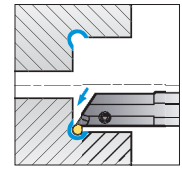
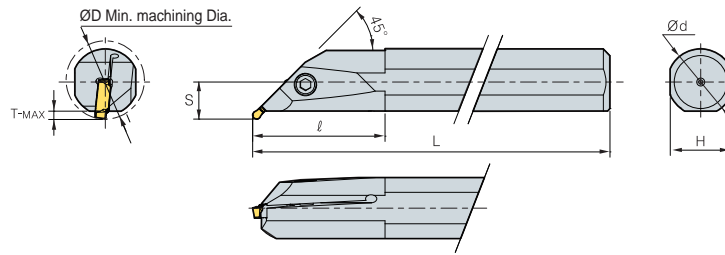
↻ Applicable inserts C12 ~ C14

# KGIUR/L

For relief machining



KRMN  
KRGN



• R type insert  
(mm)

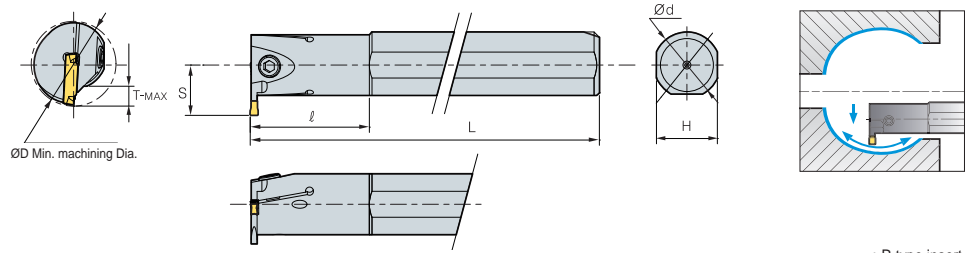
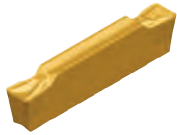
Designation	ØD	Ød	L	ℓ	T-MAX	H	S	Inserts	Screw	Wrench	
<b>KGIUR/L</b> 3520-3	35	20	150	45	3.5	18	13	KRMN300-C KRGN300-□	MHA0512	HW40L	
	4025-3	40	25	200	50	3.5	23				15.5
	5032-3	50	32	250	65	3.5	30				19
3520-4	35	20	150	45	3.5	18	13	KRMN400-C KRGN400-□	MHA0512	HW40L	
	4025-4	40	25	200	50	3.5	23				15.5
	5032-4	50	32	250	65	3.5	30				19
4025-5	40	25	200	50	3.5	23	15.5	KRMN500-C KRGN500-□	MHA0512	HW40L	
	5032-5	50	32	250	65	3.5	30				19
4025-6	40	25	200	50	3.5	23	15.5	KRMN600-C KRGN600-□	MHA0512	HW40L	
	5032-6	50	32	250	65	3.5	30				19
4025-8	40	25	200	50	3.5	23	18.5	KRMN800-C	MHA0512	HW40L	
5032-8	50	32	250	65	3.5	30	22	KRGN800-□			

↻ Applicable inserts C12 ~ C14



## KGIVR/L

For grooving, turning and profil machining



KGMI  
KGGN  
KRMN

KGMN  
KRMI

• R type insert  
(mm)

Designation		ØD	Ød	L	l	T-MAX	H	S	Inserts	Screw	Wrench
KGIVR/L	2016-1.5	20	16	125	35	4	15	12	KGMN150-□-□	MHB0410	HW30L
	2520-1.5	25	20	150	45	6	18	15.5		MHB0410	
	3225-1.5	32	25	200	45	7	23	19		MHA0512	HW40L
	2516-2	25	16	125	35	6.5	15	14	KGMI200-□-T KRMI200-C	MHB0410	HW30L
	2520-2	25	20	150	45	6.5	18	15.5		MHB0512	HW40L
	3225-2	32	25	200	45	7	23	19	KGMN250-□-□	MHB0410	HW30L
	2516-2.5	25	16	125	35	6.5	15	14		MHA0512	HW40L
	2520-2.5	25	20	150	45	6.5	18	15.5		MHB0410	HW30L
	3225-2.5	32	25	200	45	7	23	19	KGMN300-□-T KRMI300-C	MHA0512	HW40L
	2520-3	25	20	150	45	6.5	18	15.5		MHB0410	HW30L
	3225-3	32	25	200	45	7	23	19	KGMI400-□-T KRMI400-C	MHA0512	HW40L
	4032-3	40	32	250	55	7.5	30	22.5		BHA0616	HW50L
	2520-4	25	20	150	45	6.5	18	15.5		MHB0410	HW30L
	3225-4	32	25	200	45	7	23	19	KGMN500-□-□ KRMN500-C	MHA0512	HW40L
	4032-4	40	32	250	55	7.5	30	22.5		BHA0616	HW50L
	3225-5	32	25	200	45	7.5	23	19.5	KGGN500-□-R KGGN500-□-A	MHA0512	HW40L
	4032-5	40	32	250	55	8.5	30	23.5		BHA0616	HW50L
	3225-6	32	25	200	45	7.5	23	19.5	KGMN600-□-□ KRMN600-C	MHA0512	HW40L
	4032-6	40	32	250	55	8.5	30	23.5		BHA0616	HW50L
	4032-8	40	32	250	55	8.5	30	23.5	KGMN800-□-□ KRMN800-C	BHA0616	HW50L
4540-8	45	40	300	70	8.5	37	26.5	KGGN800-□-R		BHA0616	HW50L

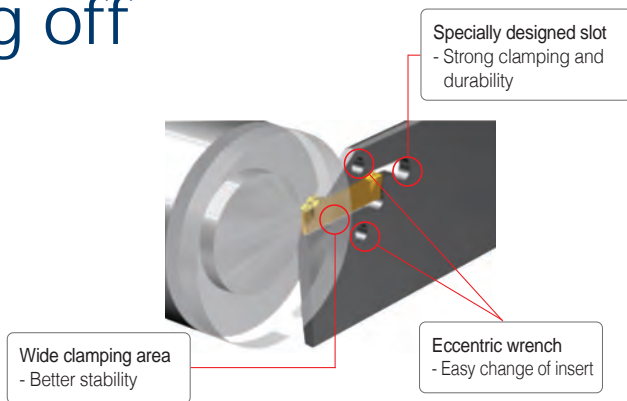
↻ Applicable inserts C12 ~ C14

• 200, 300, 400 inserts : Internal inserts, KGMI or KRMI

# KGT Blade for Parting off

## Features

- Parting application with the use of existing KGT inserts
- Economical machining with a double sided insert
- Specially designed slot for strong and stable clamping
- Easy change of insert with the use of exclusive wrench



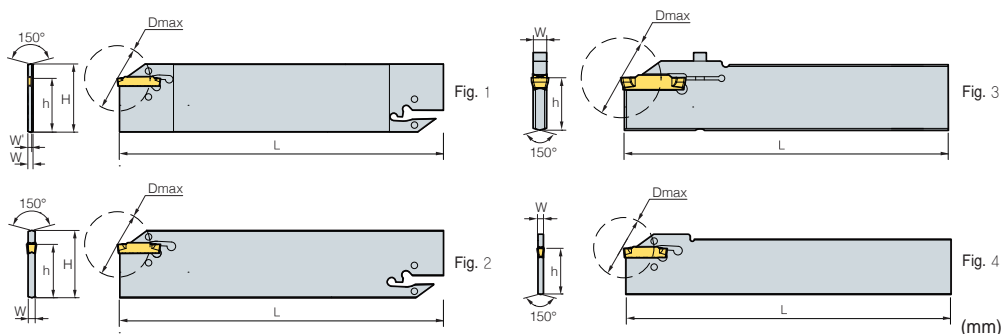
## Code system



## How to clamp insert



## KGTB



Designation	H	W	W'	L	h	ØD Max <sup>(2)</sup>	ØD Max <sup>(3)</sup>	Inserts	Wrench	Fig	
<b>KGTB 1526S</b>	26	2.4	1.0	150	21	-	26	KG□□150-□-□	EW1203 (Separately ordered)	4	
<b>1532</b>	32	2.4	1	150	25	-	26	KG□□150-□-□		1	
<b>2026S</b>	26	2.4	1.8	150	21	50	39	KG□□200-□-□ KG□□200S-□-□-R <sup>(4)</sup>		4	
<b>2032</b>	32	2.4	1.8	150	25	50	39	KG□□200-□-□ KG□□200S-□-□-R <sup>(4)</sup>		1	
<b>3026S</b>	26	2.4	-	150	21	100	39	KG□□300-□-□ KG□□300S-□-□-R <sup>(4)</sup>		4	
<b>3032</b>	32	2.4	-	150	25	100	39	KG□□300-□-□ KG□□300S-□-□-R <sup>(4)</sup>		2	
<b>4026S</b>	26	3.2	-	150	21	100	39	KG□□400-□-□ KG□□400S-□-□-R <sup>(4)</sup>		4	
<b>4032</b>	32	3.2	-	150	25	100	39	KG□□400-□-□ KG□□400S-□-□-R <sup>(4)</sup>		2	
<b>5032</b>	32	4	-	150	25	120	49	KG□□500-□-□ KG□□500S-□-□-R <sup>(4)</sup>		2	
<b>6032</b>	32	5.2	-	150	25	120	49	KG□□600-□-□ KG□□600S-□-□-R <sup>(4)</sup>		2	
<b>8032S<sup>(1)</sup></b>	32	6.2	-	150	25	80	59	KG□□800-□-□ KG□□800S-□-□-R <sup>(4)</sup>		HW30L	3

➔ Applicable inserts C12 ~ C14

(1) Screw clamping (2) 1 corner use (3) 2 corner use (4) 1 corner insert

# C Technical Information for MGT Series

Inserts are offered with two edges, for better economical machining

## MGT Series

- Inserts are offered with two edges, for better economical machining
- Multi-function operations - Reduce cycle time & increase productivity with the ability to groove, turn, face or copy in an application
- Shorten time & save on tool cost - Korloy's MGT system allows a machinist to apply one tool against many applications, reducing the number of tools
- Flat Cutting Edge - MGT tools have a flat geometry on its cutting edge to ensure excellent surface finishes. Even in high Feed applications by using a wiper function, Korloy ensures excellent surface finishes in roughing operations

### Code system












#### • Insert

MG	M	N	300	-	04	-	T
<b>System Code</b>	<b>Tolerance</b>	<b>Hand</b>	<b>Cutting Edge Width</b>		<b>Nose Radius (Nose R)</b>		<b>Chip Breaker</b>
MG: Multi Grooving MR: Multi Grooving Round	M: Pressed G: Ground	N: Neutral R: Right L: Left I: Internal	1.5~8.0 mm		0.2 mm 0.3 mm 0.4 mm 0.8 mm		L / R / T / M / PS / PT / A

#### • Holder

MG	E	H	R/L	2525	-	3	T15
<b>System Code</b>	<b>Application</b>	<b>Holder Type</b>	<b>Hand</b>	<b>Shank Size</b>		<b>Cutting Width</b>	<b>Maximum Depth of Cut</b>
MG: Multi Grooving	E: External machining I: Internal machining	H: Horizontal V: Vertical U: Undercut	R: Right L: Left	Height: 25 mm Width: 25 mm (For internal machining: Minimum diameter)		1.5~8.0 mm	15~25 mm

### Geometry of chip breaker

<b>MGM(G)N-M</b>  <ul style="list-style-type: none"> <li>• Specially designed chip breaker allows a smoother chip flow versus conventional flat-top geometries through the use of a central chip breaker</li> <li>• Specially placed convex dots assists with chip control in external machining, for a smoother chip flow</li> <li>• Chip breaker designed for turning &amp; grooving applications</li> </ul>	<b>MGMN-G</b>  <ul style="list-style-type: none"> <li>• Specially designed chip breaker allows narrower chips to promote better chip flow</li> <li>• Specifically designed for grooving applications</li> </ul>	<b>MRMN-M</b>  <ul style="list-style-type: none"> <li>• Full radius geometry for applications that require profiling</li> <li>• Available for relief machining</li> </ul>	<b>MFMN300</b>  <ul style="list-style-type: none"> <li>• Specially designed chip breaker allows narrower chips to promote better chip flow</li> <li>• Chip breaker specially designed for face-grooving</li> </ul>
<b>MRGN-A</b>  <ul style="list-style-type: none"> <li>• Specially designed high positive geometry, ideal for machining aluminum</li> <li>• The chip breaker's super buffed, high rake angle allows optimal chip flow of aluminum</li> </ul>	<b>MGMR-PS</b>  <ul style="list-style-type: none"> <li>• Sharply designed cutting edge.</li> <li>• Recommended in machining low carbon steel and stainless steel</li> <li>• Specially designed chip breaker allows narrower chips to promote better chip flow.</li> <li>• Able to machine Feed rates and small diameter cutting</li> </ul>	<b>MGMR-PT</b>  <ul style="list-style-type: none"> <li>• Stronger cutting edge with a negative land for tougher applications</li> <li>• Able to machine at Feed rates as high and bar stock</li> <li>• Chip breaker design helps narrows chips for better flow</li> </ul>	<b>MGGN-A</b>  <ul style="list-style-type: none"> <li>• Smooth chip flow</li> <li>• Reduced build up on cutting edge</li> </ul>
<b>MGMN-L</b>  <ul style="list-style-type: none"> <li>• Sharp cutting edge</li> <li>• Low cutting resistance</li> <li>• For auto CNC machine</li> <li>• For small Dia. processing</li> </ul>	<b>MGMN-R</b>  <ul style="list-style-type: none"> <li>• Strong cutting edge</li> <li>• For high feed rate processing</li> </ul>	<b>MGMN-T</b>  <ul style="list-style-type: none"> <li>• For turning &amp; grooving</li> <li>• Reduced chip width &amp; smooth chip control by dot designed on the top corner</li> </ul>	



**Parting off (MGMN/MGMR/L)**

Workpiece	Cutting Speed (vc = m/min)								Feed (fn = mm/rev)				
	CVD				PVD			Uncoated	Cutting width (mm)				
	NC3120	NC3030	NCM325	NC5330	PC8110	PC5300	PC6510	ST30A	2	3	4	5	6
SM□□C	80~180			80~180		80~180			0.02~0.15	0.03~0.20	0.08~0.30	0.10~0.40	0.12~0.50
SCM	70~150	70~150	70~150	70~150		70~150			0.02~0.15	0.03~0.20	0.08~0.30	0.10~0.40	0.12~0.50
GC/GCD				50~100			50~100	50~100	0.05~0.12	0.10~0.25	0.10~0.30	0.10~0.35	0.10~0.40
STS			50~120	50~120	50~120	60~140			0.02~0.10	0.03~0.15	0.08~0.25	0.10~0.35	0.12~0.40
Non-ferrous metal (Al, Copper)								200~450	0.05~0.10	0.05~0.20	0.05~0.25	0.05~0.30	0.05~0.35

**Facing (FGD/FGM/FMM/MFMN/MGMN)**

Workpiece	Cutting Speed (vc = m/min)							Feed (fn = mm/rev)		
	CVD				PVD		Uncoated	Cutting width (mm)		
	NC6110	NC3030	NC5330	NC3120	PC215K	PC8110 / PC5300	H01	3	4	5
SM□□C			100~160	100~160				0.05~0.10	0.05~0.12	0.05~0.15
SCM		50~130	50~130	50~130			200~800	0.05~0.10	0.05~0.12	0.05~0.15
GC/GCD	120~150		120~150		120~150			0.05~0.10	0.05~0.12	0.05~0.15
STS			60~150			60~150		0.05~0.10	0.05~0.12	0.05~0.15
Non-ferrous metal (Al, Copper)								0.05~0.15	0.08~0.15	0.08~0.15

**Grooving, Turning (MGMN/MRMN)**

Workpiece	Cutting Speed (vc = m/min)								Feed (fn = mm/rev)					
	CVD			PVD		Cermet	Uncoated		Cutting width (mm)					
	NC3120	NC3030	NC5330	PC215K	PC5300	CN20	ST30A	ST20	0.5~1.0	1.0~2.0	2~3	3~4	4~5	6~8
SM□□C	80~200		80~200		80~180	80~120		80~120	0.03~0.08	0.04~0.09	0.05~0.1	0.05~0.12	0.05~0.15	0.05~0.2
SCM	80~180	80~180	80~180		80~160	80~120	80~120	80~120	0.03~0.07	0.04~0.08	0.05~0.08	0.05~0.1	0.05~0.12	0.05~0.15
GC/GCD			60~130		60~130				0.03~0.07	0.04~0.08	0.05~0.08	0.05~0.1	0.05~0.10	0.05~0.12
STS			60~100	60~100			60~100		0.03~0.08	0.04~0.09	0.05~0.10	0.05~0.12	0.05~0.12	0.05~0.15
Non-ferrous metal (Al, Copper)				150~300			150~400		0.05~0.12	0.05~0.15	0.05~0.15	0.08~0.15	0.08~0.15	0.10~0.20


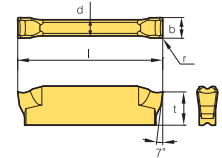

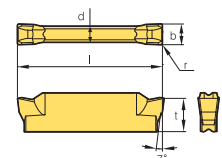

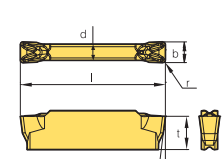

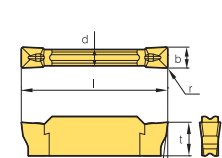
## Insert

Application	Picture	Designation	Coated							Uncoated	Dimensions (mm)					Configuration	Page
			NC3120	NC3225	NC3030	NC5330	NC6315	PC5300	PC8110	PC9030	H01	b	r	l	d		
Face Grooving	FGD	300R-03			●						3.0	0.3	15.0	2.0	4.0		C36 C37
		400R-04			●						4.0	0.4	15.0	3.0	4.5		
		500R-04			●						5.0	0.4	15.0	4.0	5.0		
	FGM	300R-03									3.0	0.3	15.0	2.0	4.0		C36 C37
		400R-04			●						4.0	0.4	15.0	3.0	4.5		
		500R-04									5.0	0.4	15.0	4.0	5.0		
	FMM	300R-03			●				●		3.0	0.3	15.0	2.0	3.91		C36 C37
		400R-04			●				●		4.0	0.4	15.0	3.0	3.96		
		500R-04							●		5.0	0.4	15.0	4.0	4.42		
Face Grooving	MFMN	300			●					3.0	0.2	18.0	2.0	3.0		C35 C41	
Grooving · Turning	MGGN-M	300-02-M									3.0	0.2	21.0	2.35	4.83		C30 C32 C34 C41
		04-M									3.0	0.4	21.0	2.35	4.83		
		08-M									3.0	0.8	21.0	2.35	4.83		
		400-02-M									4.0	0.2	21.0	3.3	4.83		
		04-M									4.0	0.4	21.0	3.3	4.83		
		08-M									4.0	0.8	21.0	3.3	4.83		
		500-02-M									5.0	0.2	26.0	4.1	5.82		
		04-M									5.0	0.4	26.0	4.1	5.82		
		08-M									5.0	0.8	26.0	4.1	5.82		
		600-02-M									6.0	0.2	26.0	5.0	5.81		
		04-M									6.0	0.4	26.0	5.0	5.81		
		08-M									6.0	0.8	26.0	5.0	5.81		
Grooving	MGMN-G	150-G		●	●			●	●	●	1.5	0.15	16.0	1.2	3.5		C30 C32 C34 C41
		200-G		●	●			●	●	●	2.0	0.2	16.0	1.6	3.5		
		250-G		●	●			●	●	●	2.5	0.2	18.5	2.0	3.85		
		300-G		●	●	●		●	●	●	3.0	0.3	21.0	2.35	4.83		
		400-G		●				●	●	●	4.0	0.3	21.0	3.3	4.83		
		500-G								●	5.0	0.5	26.0	4.1	5.82		
		600-G								●	6.0	0.8	26.0	5.0	5.81		
Grooving · Turning	MGMN-M	200-M		●	●	●	●		●	●	2.0	0.2	16.0	1.6	3.5		C30 C32 C34 C41
		250-M		●	●	●		●	●	●	2.5	0.2	18.5	2.0	3.85		
		300-02-M				●					3.0	0.2	21.0	2.35	4.83		
		300-M		●	●	●	●	●	●	●	3.0	0.4	21.0	2.35	4.83		
		350-03-M									3.5	0.3	21.0	2.9	4.83		
		400-02-M									4.0	0.2	21.0	3.3	4.83		
		400-M		●	●	●	●	●	●	●	4.0	0.4	21.0	3.3	4.83		
		500-04-M				●					5.0	0.4	26.0	4.1	5.82		
		500-M		●	●	●	●	●		●	5.0	0.8	26.0	4.1	5.82		
		600-M		●	●	●	●	●			6.0	0.8	26.0	5.0	5.81		
800-M					●				8.0	0.8	31.0	6.0	6.52				

● : Stock item




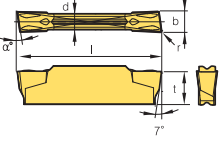

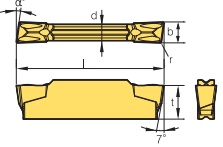

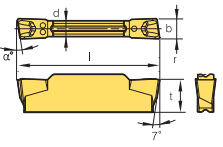

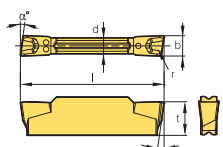

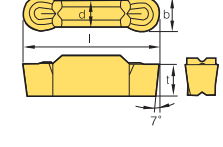

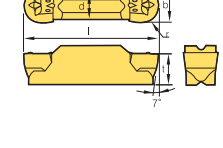
**Insert**

Application	Picture	Designation	Coated							Uncoated		Dimensions (mm)						Configuration	Page
			NC3120	NC3225	NC3030	NC5330	NC6315	PC5300	PC8100	PC9030	H01	H05	b	r	l	d	t		
Grooving	MGMN-L 	MGMN 200-02-L										2.0	0.2	16	1.6	3.5	-		C30 C32 C34 C35
		04-L										2.0	0.4	20	1.7	3.5	-		
		250-02-L										2.5	0.2	18.5	2.0	3.85	-		
		300-02-L						●				3.0	0.2	21	2.35	4.83	-		
		04-L										3.0	0.4	20	2.3	4.83	-		
		400-02-L						●				4.0	0.2	21	3.3	4.83	-		
		04-L										4.0	0.4	20	3.3	4.83	-		
		500-03-L										5.0	0.3	26	4.1	5.82	-		
		04-L							●			5.0	0.4	26	4.1	5.82	-		
Grooving · Parting off	MGMN-R 	MGMN 150-015-R										1.5	0.15	16	1.2	3.5	-		C30 C32 C34 C35
		200-02-R										2.0	0.2	16	1.6	3.5	-		
		04-R										2.0	0.4	20	1.7	3.5	-		
		250-02-R										2.5	0.2	18.5	2.0	3.85	-		
		300-02-R				●		●				3.0	0.2	21	2.35	4.83	-		
		04-R										3.0	0.4	20	2.3	4.83	-		
		400-02-R				●		●				4.0	0.2	21	3.3	4.83	-		
		04-R										4.0	0.4	20	3.3	4.83	-		
		500-04-R				●		●				5.0	0.4	26	4.1	5.82	-		
		08-R										5.0	0.4	26	4.1	5.82	-		
600-04-R										6.0	0.4	26	5.0	5.81	-				
08-R										6.0	0.8	26	5.0	5.81	-				
Grooving · Turning	MGMN-T 	MGMN 150-015-T										1.5	0.15	16	1.2	3.5	-		C30 C32 C34 C35
		200-T										2.0	0.2	16	1.6	3.5	-		
		300-T				●		●				3.0	0.4	21	2.35	4.83	-		
		400-T				●		●				4.0	0.4	21	3.3	4.83	-		
		500-04-T										5.0	0.4	26	4.1	5.82	-		
		500-T						●				5.0	0.8	26	4.1	5.82	-		
		600-08-T										6.0	0.8	26	5.0	5.81	-		
Grooving	MGMN-A 	MGMN 300-02-A										3.0	0.2	21	2.35	4.83	-		C28 C30 C32 C41
		04-A										3.0	0.4	21	2.35	4.83	-		
		08-A										3.0	0.8	21	2.35	4.83	-		
		400-02-A										4.0	0.2	21	3.3	4.83	-		
		04-A										4.0	0.4	21	3.3	4.83	-		
		08-A										4.0	0.8	21	3.3	4.83	-		
		500-02-A										5.0	0.2	26	4.1	5.82	-		
		04-A										5.0	0.4	26	4.1	5.82	-		
08-A										5.0	0.8	26	4.1	5.82	-				

● : Stock item



## Insert

Application	Picture	Designation	Coated							Uncoated		Dimensions (mm)						Configuration	Page			
			NC3120	NC3225	NC3030	NC5330	NC6315	PC5300	PC8100	PC9030	H01	H05	b	r	l	d	t			$\alpha^\circ$		
Parting off		<b>MGMR</b> 300-6D-PS 8D-PS 15D-PS 400-4D-PS 500-4D-PS										3.0	0.2	21	2.35	4.83	6		C30 C32			
													3.0	0.2	21	2.35	4.83			5		
														3.0	0.2	21	2.35			4.83	15	
														4.0	0.3	21	3.3			4.83	4	
														5.0	0.3	26	4.1			5.82	4	
Parting off		<b>MGML</b> 300-6D-PS 8D-PS 15D-PS 400-4D-PS 500-4D-PS										3.0	0.2	21.0	2.35	4.83	6					
													3.0	0.2	21.0	2.35	4.83			5		
														3.0	0.2	21.0	2.35			4.83	15	
														4.0	0.3	21	3.3			4.83	4	
														5.0	0.3	26	4.1			5.82	4	
Parting off		<b>MGMR</b> 200-6D-PT 300-6D-PT 8D-PT 15D-PT 400-4D-PT 500-4D-PT										2.0	0.2	16	1.6	3.5	6		C30 C32			
													3.0	0.2	21	2.35	4.83			6		
														3.0	0.2	21	2.35			4.83	8	
														3.0	0.2	21	2.35			4.83	15	
														4.0	0.3	21	3.3			4.83	4	
Parting off		<b>MGML</b> 200-6D-PT 300-6D-PT 8D-PT 15D-PT 400-4D-PT 500-4D-PT										2.0	0.2	16	1.6	3.50	6					
													3.0	0.2	21	2.35	4.83			6		
														3.0	0.2	21	2.35			4.83	8	
														3.0	0.2	21	2.35			4.83	15	
														4.0	0.3	21	3.30			4.83	4	
Aluminum		<b>MRGN</b> 300-A 400-A 500-A 600-A 800-A																	C30 C33 C34			
														4.0	2.0	21.0	3.3			4.83	-	
															5.0	2.5	26.0			4.1	5.82	-
															6.0	3.0	26.0			5.0	5.81	-
															8.0	4.0	31.0			6.0	6.52	-
Relieving Profiling		<b>MRMN</b> 200-M 300-M 400-M 500-M 600-M 800-M																	C30 ~34 C41			

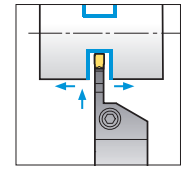
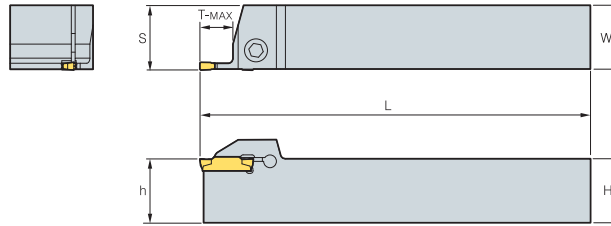
● : Stock item





# MGEHR/L

For grooving, turning, parting off, relief, profil machining



MGMN  
MGGN  
MRGN

MGMR  
MRMN

• R type insert  
(mm)

Designation	H = (h)	W	L	S	T-MAX	Inserts	Screw	Wrench
<b>MGEHR/L</b> 1616-1.5	16	16	100	16.2	14	MGMN150-G	LTX0514	TW20L
2020-1.5	20	20	125	20.2	14			
2525-1.5	25	25	150	25.2	14			
1212-2	12	12	100	14.25	14	MGMN200-G MGMN200-M MGMR200-□□-□□	MHA0512	HW40L
1616-2	16	16	100	16.25	14			
2020-2	20	20	125	20.25	14			
2525-2	25	25	150	25.25	14			
1616-2.5	16	16	100	16.30	16	MGMN250-G MGMN250-M	MHA0512	HW40L
2020-2.5	20	20	125	20.30	16			
2525-2.5	25	25	150	25.30	16			
1616-3	16	16	100	16.35	18	MGMN300-M/T MGGN300-□□-M MRMN300-M MGMR300-□□-□□ MGMN300-□□-L/R	BHA0616	HW50L
2020-3-T10	20	20	125	20.4	10			
2020-3	20	20	125	20.4	18			
2525-3-T10	25	25	150	25.4	10			
2525-3	25	25	150	25.4	18			
3232-3-T10	32	32	170	32.4	10			
3232-3	32	32	170	32.4	18			
2020-4-T10	20	20	125	20.4	10			
2020-4	20	20	125	20.4	18			
2525-4-T10	25	25	150	25.4	10			
2525-4	25	25	150	25.4	18			
3232-4-T10	32	32	170	32.4	10	MGMN400-M/T MGGN400-□□-M MRMN400-M MGMR400-□□-□□ MGMN400-□□-L/R	BHA0616	HW50L
3232-4	32	32	170	32.4	18			
2020-5-T15	20	20	150	20.5	15			
2020-5	20	20	150	20.5	23			
2525-5-T15	25	25	150	25.5	15	MGMN500-M/T MGGN500-□□-M MRMN500-M MGMR500-□□-□□ MGMN500-□□-L/R	BHA0616	HW50L
2525-5	25	25	150	25.5	23			
3232-5-T15	32	32	170	32.5	15			
3232-5	32	32	170	32.5	23			
2020-6-T15	20	20	125	20.6	15	MGMN600-M MGGN600-□□-M MRMN600-M	BHA0616	HW50L
2020-6	20	20	125	20.6	23			
2525-6-T15	25	25	150	25.6	15			
2525-6	25	25	150	25.6	23			
3232-6-T15	32	32	170	32.6	15			
3232-6	32	32	170	32.6	23			
2525-8-T15	25	25	150	26.1	15	MRMN800-M MGMN800-M	BHA0616	HW50L
2525-8	25	25	150	26.1	28			
3232-8-T15	32	32	170	33.1	16			
3232-8	32	32	170	33.1	28	MRGN600-A	BHA0616	HW50L
2525-6A-T15	25	25	150	25.6	15			
2525-6A	25	25	150	25.6	23			
3232-6A-T15	32	32	170	32.6	15			
3232-6A	32	32	170	32.6	23			
2525-8A-T15	25	25	150	26.1	16			
2525-8A	25	25	150	26.1	28			
3232-8A-T15	32	32	170	33.1	15			
3232-8A	32	32	170	33.1	28	MRGN800-A	BHA0616	HW50L

Applicable inserts C28 ~ C30

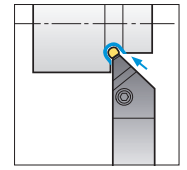
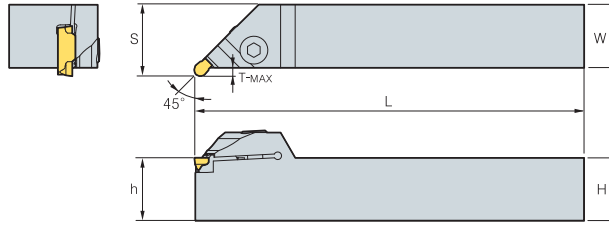


## MGEUR/L



For relief, profil machining



MRMN  
MRGN



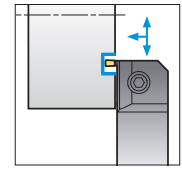
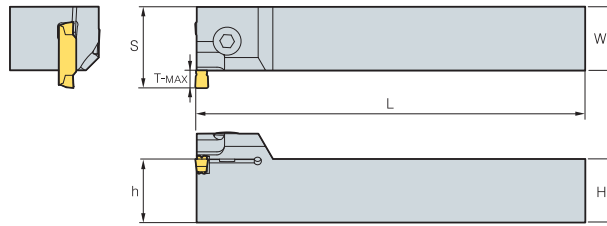
• R type insert  
(mm)

Designation	H = (h)	W	L	S	T-MAX	Inserts	Screw	Wrench
								
<b>MGEUR/L</b> 2020-3 2525-3 3232-3	20	20	125	23	3	MRMN300-M	BHA0616	HW50L
	25	25	150	28	3			
	32	32	170	35	3			
2020-4 2525-4 3232-4	20	20	125	23	3	MRMN400-M		
	25	25	150	28	3			
	32	32	170	35	3			
2020-5 2525-5 3232-5	20	20	125	24	4	MRMN500-M		
	25	25	150	29	4			
	32	32	170	36	4			
2020-6 2525-6 3232-6	20	20	125	24	4	MRMN600-M		
	25	25	150	29	4			
	32	32	170	36	4			
2525-8 3232-8	25	25	150	30	5	MRMN800-M		
	32	32	170	37	5			
2525-6A 3232-6A	25	25	150	29	4	MRGN600-A		
	32	32	170	36	4			
2525-8A 3232-8A	25	25	150	30	5	MRGN800-A		
	32	32	170	37	5			

↻ Applicable inserts C28 ~ C30

For grooving, turning, profil machining

# MGEVR/L



MGMN MGGN  
MRMN MRGN

• R type insert  
(mm)

Designation		H = (h)	W	L	S	T-MAX	Min. machining Dia. (ØD)	Inserts	Screw	Wrench
MGEVR/L	2020-1.5	20	20	125	23	3	85	MGMN150-G	LTX0514	TW20L
	2525-1.5	25	25	150	28	3	85			
	3232-1.5	32	32	170	35	3	85			
	2020-2	20	20	125	23.5	3.5	65	MGMN200-M MGMN200-G	BHA0616	HW50L
	2525-2	25	25	150	28.5	3.5	65			
	3232-2	32	32	170	35.5	3.5	65			
	2020-2.5	20	20	125	24	4	65	MGMN250-M MGMN250-G		
	2525-2.5	25	25	150	29	4	65			
	3232-2.5	32	32	170	36	4	65			
	2020-3	20	20	125	25.5	5	75	MGMN300-M/T MGGN300-□-M MRMN300-M MGMN300-□□-L/R		
	2525-3	25	25	150	30.5	5	75			
	3232-3	32	32	170	37.5	5	75			
	2020-4	20	20	125	25.5	5	70			
	2525-4	25	25	150	30.5	5	70			
	3232-4	32	32	170	37.5	5	70			
	2020-5	20	20	125	27	7	75	MGMN500-M/T MGGN500-□□-M MRMN500-M MGMN500-□□-L/R		
	2525-5	25	25	150	32	7	75			
	3232-5	32	32	170	39	7	75			
	2020-6	20	20	125	27	7	70	MGMN600-M MGGN600-□□-M MRMN600-M		
	2525-6	25	25	150	32	7	70			
3232-6	32	32	170	39	7	70				
2525-8	25	25	150	34	9	50	MRMN800-M			
3232-8	32	32	170	41	9	50	MGMN800-M			
2525-6A	25	25	150	32	7	70	MRGN600-A			
3232-6A	32	32	170	39	7	70				
2525-8A	25	25	150	34	9	45	MRGN800-A			
3232-8A	32	32	170	41	9	45				

↻ Applicable inserts C28 ~ C30

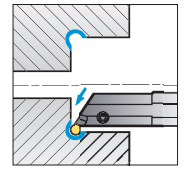
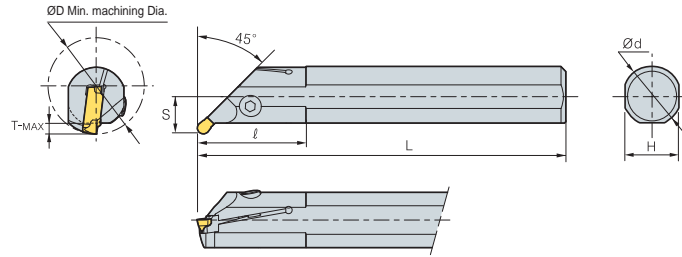


## MGIUR/L

For relief, profil machining



MRMN  
MRGN



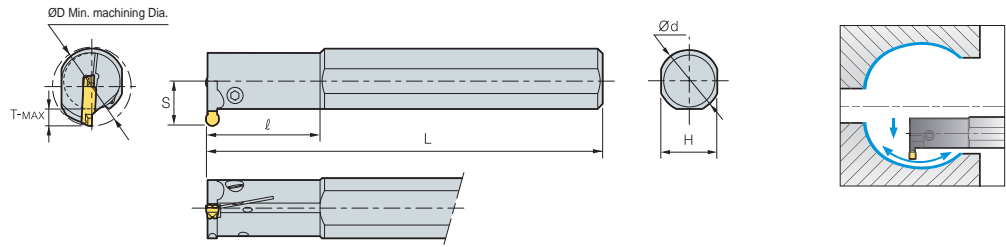
• R type insert  
(mm)

Designation	ØD	Ød	L	ℓ	T-MAX	H	S	Inserts	Screw	Wrench	
<b>MGIUR/L</b> 3520-3	35	20	150	45	3.5	18	13	MRMN300-M	MHA0512	HW40L	
	4025-3	40	25	200	45	3.5	23				15.5
	5032-3	50	32	250	65	3.5	30				19
3520-4	35	20	150	45	3.5	18	13	MRMN400-M	MHA0512	HW40L	
	4025-4	40	25	200	45	3.5	23				15.5
	5032-4	50	32	250	65	3.5	30				19
4025-5	40	25	200	45	3.5	23	15.5	MRMN500-M	BHA0616 BHA0620		
	5032-5	50	32	250	65	3.5	30				19
4025-6	40	25	200	45	3.5	23	19	MRMN600-M	BHA0616 BHA0620		
	5032-6	50	32	250	65	3.5	30				19
4025-8	40	25	200	45	6.5	23	15.5	MRMN800-M	BHA0616 BHA0620	HW50L	
	5032-8	50	32	250	65	6.5	30				19
4025-6A	40	25	200	45	3.5	23	15.5	MRGN600-A	BHA0616 BHA0620		
	5032-6A	50	32	250	65	3.5	30				19
4025-8A	40	25	200	45	5.0	23	18.5	MRGN800-A	BHA0616 BHA0620		
	5032-8A	50	32	250	65	6.5	30				22

➔ Applicable inserts C28 ~ C30

# MGIVR/L

For grooving, turning, profil machining



MGMN MRMN  
MGGN MRGN

• R type insert  
(mm)

Designation		ØD	Ød	L	ℓ	T-MAX	H	S	Inserts	Screw	Wrench				
MGIVR/L	2016-1.5	20	16	125	35	3.5	15	11.3	MGMN150-G	MHB0310	HW25L				
	2520-1.5	25	20	150	45	3.5	18	13.1		MHA0512	HW40L				
	2925-1.5	29	25	200	45	3.5	23	16.2		MHB0310	HW25L				
	2016-2	20	16	125	35	4.5	15	12.4	MGMN200-G	MHA0512	HW40L				
	2520-2	25	20	150	45	4.5	18	14.0	MGMN200-M	MHA0512	HW40L				
	2925-2	29	25	200	45	4.5	23	17.2	MRMN200-M						
	2016-2.5	20	16	125	35	4.5	15	12.5	MGMN250-G						
	2520-2.5	25	20	150	45	4.5	18	15.1	MGMN250-M	MHA0512	HW40L				
	2925-2.5	29	25	200	45	4.5	23	18.2	MGMN300-M/G/T MGGN300-□□-M MRMN300-M MGMN300-□□-L/R	MHA0512	HW40L				
	2520-3	25	20	150	45	5	18	15.6							
	2520-3-T7	25	20	150	49.3	7	18	19.92							
	3125-3	31	25	200	45	6	23	18.9							
	3125-3-T10	31	25	200	45	10	23	18.9							
	3732-3	37	32	250	65	6	30	21.5							
	3732-3-T12	37	32	250	65	12	30	21.5							
	2520-4	25	20	150	45	6	18	15.6				MGMN400-M/G/T MGGN400-□□-M MRMN400-M MGMN400-□□-L/R	MHA0512	HW40L	
	2520-4-T7	25	20	150	45	7	18	15.6							
	3125-4	31	25	200	45	6	23	18.9							
	3125-4-T10	31	25	200	45	10	23	19							
	3732-4	37	32	250	65	6	30	21.5							
	3732-4-T12	37	32	250	65	12	30	21.5							
	3125-5	31	25	200	45	8	23	19.4							MGMN500-M/G/T MGGN500-□□-M MRMN500-M MGMN500-□□-L/R
	3732-5	37	32	250	65	8	30	21.5							
	3125-6	31	25	200	45	8	23	19.4				MGMN600-MG MGGN600-□□-M MRMN600-M	BHA0616	BHA0620	HW50L
	3732-6	37	32	250	65	8	30	21.5							
	3732-8	37	32	250	65	10	30	23.4				MRMN800-M MGMN800-M			
	4540-8	45	40	300	70	10	37	27.2							
	3125-6A	31	25	200	45	8	23	19.4				MRGN600-A	BHA0616		
3732-6A	37	32	250	65	8	30	21.5	MRGN800-A				BHA0620			
3732-8A	37	32	250	65	10	30	23.4								
4540-8A	45	40	300	70	10	37	27.2								

➤ Applicable inserts C28 ~ C30



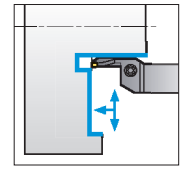
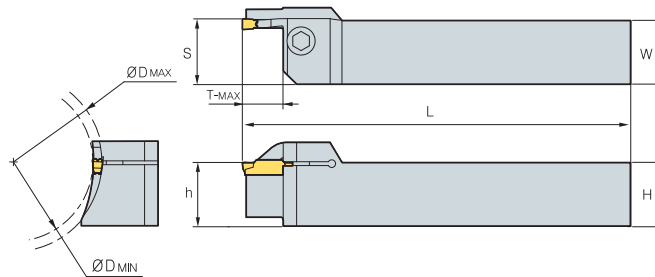
# C MGT Series (Face Grooving)

## MGFHR/L

For face grooving machining



MFMN  
MGMN



• R type insert  
(mm)

Designation	H = (h)	W	L	S	T-MAX	ØD		Inserts	Screw	Wrench	
						Min	Max				
<b>MGFHR/L</b>	<b>325-24/35-T10</b>	25	25	150	25.6	10	24	35	MFMN300	BHA0616	HW50L
	<b>29/40-T10</b>	25	25	150	25.6	10	29	40			
	<b>34/50-T10</b>	25	25	150	25.6	10	34	50			
	<b>44/70-T10</b>	25	25	150	25.6	10	44	70			
	<b>64/99-T10</b>	25	25	150	25.6	10	64	99			
	<b>425-42/63-T15</b>	25	25	150	25.6	15	42	63			
	<b>62/120-T15</b>	25	25	150	25.6	15	62	120			
<b>112/200-T15</b>	25	25	150	25.6	15	112	200	MGMN400-M/T MGMN400-□□-L/R			

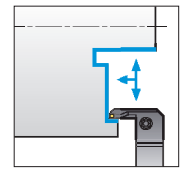
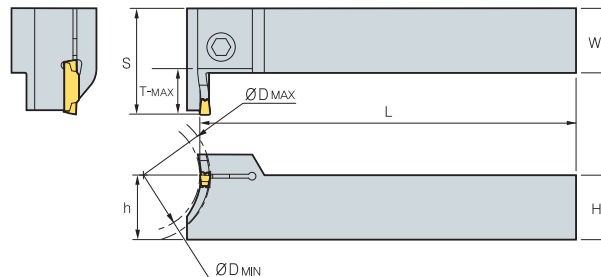
➔ Applicable inserts C28 ~ C30

## MGFVR/L

For face grooving machining



MFMN  
MGMN



• R type insert  
(mm)

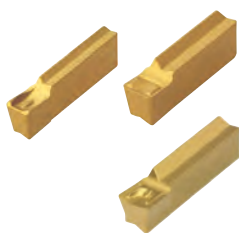
Designation	H = (h)	W	L	S	T-MAX	ØD		Inserts	Screw	Wrench	
						Min	Max				
<b>MGFVR/L</b>	<b>325-24/35-T10</b>	25	25	150	36	10	24	35	MFMN300	MHA0512	HW40L
	<b>29/40-T10</b>	25	25	150	36	10	29	40			
	<b>34/50-T10</b>	25	25	150	36	10	34	50			
	<b>44/70-T10</b>	25	25	150	36	10	44	70			
	<b>64/99-T10</b>	25	25	150	36	10	64	99			
	<b>425-44/60-T15</b>	25	25	150	41	15	44	60			
	<b>60/120-T15</b>	25	25	150	41	15	60	120			
<b>112/200-T15</b>	25	25	150	41	15	112	200				

➔ Applicable inserts C28 ~ C30

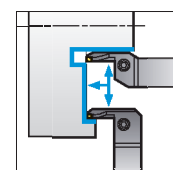
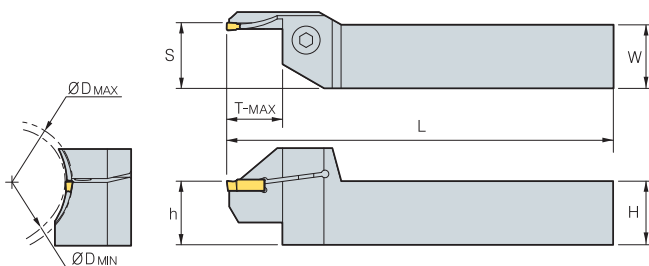


For face grooving, turning machining

## FGHH



FGD FGM FMM



• R type insert  
(mm)

Designation	H = (h)	W	L	S	T-MAX	ØD		Inserts	Screw	Wrench	
						Min	Max				
<b>FGHH</b> 320R - 25/30	20	20	125	20.6	12	25	30	FMM300R-03	BHA0616	HW50L	
	30/35	20	20	125	20.6	12	30				35
	35/48	20	20	125	20.6	12	35				48
	48/60	20	20	125	20.6	22	48	60			FGD300R-03 FGM300R-03
	60/75	20	20	125	20.6	22	60	75			
	75/100	20	20	125	20.6	22	75	100			
	100/140	20	20	125	20.6	22	100	140			
<b>325R - 25/30</b>	25	25	150	25.6	12	25	30	FMM300R-03			
	30/35	25	25	150	25.6	12	30				35
	35/48	25	25	150	25.6	12	35				48
	48/60	25	25	150	25.6	22	48	60			FGD300R-03 FGM300R-03
	60/75	25	25	150	25.6	22	60	75			
	75/100	25	25	150	25.6	22	75	100			
<b>420R - 25/30</b>	20	20	125	20.6	12	25	30	FMM400R-04			
	30/35	20	20	125	20.6	12	30		35		
	35/48	20	20	125	20.6	12	35		48		
	48/60	20	20	125	20.6	25	48	60	FGD400R-04 FGM400R-04		
	60/75	20	20	125	20.6	25	60	75			
	75/100	20	20	125	20.6	25	75	100			
<b>425R - 25/30</b>	25	25	150	25.6	12	25	30	FMM400R-04			
	30/35	25	25	150	25.6	12	30		35		
	35/48	25	25	150	25.6	12	35		48		
	48/60	25	25	150	25.6	25	48	60	FGD400R-04 FGM400R-04		
	60/75	25	25	150	25.6	25	60	75			
	75/100	25	25	150	25.6	25	75	100			
<b>520R - 25/30</b>	20	20	125	20.6	12	25	30	FMM500R-04			
	30/35	20	20	125	20.6	12	30		35		
	35/40	20	20	125	20.6	20	35		40		
	40/48	20	20	125	20.6	20	40		48		
	48/60	20	20	125	20.6	25	48	60	FGD500R-04 FGM500R-04		
	60/75	20	20	125	20.6	25	60	75			
	75/100	20	20	125	20.6	25	75	100			
<b>525R - 25/30</b>	25	25	150	25.6	12	25	30	FMM500R-04			
	30/35	25	25	150	25.6	12	30		35		
	35/40	25	25	150	25.6	20	35		40		
	40/48	25	25	150	25.6	20	40		48		
	48/60	25	25	150	25.6	25	48	60	FGD500R-04 FGM500R-04		
	60/75	25	25	150	25.6	25	60	75			
	75/100	25	25	150	25.6	25	75	100			
100/140	25	25	150	25.6	25	100	140				

➔ Applicable inserts C28 ~ C30

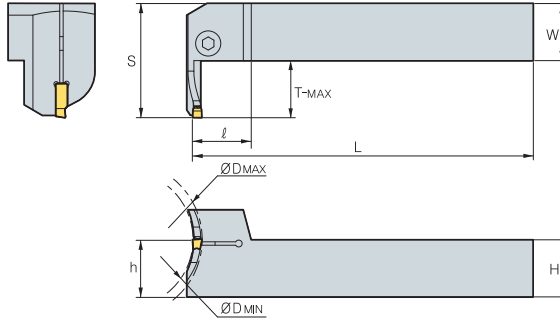


# C MGT Series (Face Grooving)

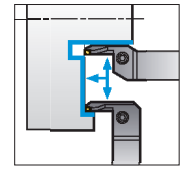
## FGVH



FGD FGM FMM



For face grooving, turning machining



• R type insert  
(mm)

Designation	H = (h)	W	L	S	T-MAX	ØD		Inserts	Screw	Wrench	
						Min	Max				
<b>FGVH</b> 320R - 25/30	20	20	125	20.6	12	25	30	FMM300R-03	BHA0616	HW50L	
	30/35	20	20	125	20.6	12	30				35
	35/48	20	20	125	20.6	12	35				48
	48/60	20	20	125	20.6	22	48	60			FGD300R-03 FGM300R-03
	60/75	20	20	125	20.6	22	60	75			
	75/100	20	20	125	20.6	22	75	100			
	100/140	20	20	125	20.6	22	100	140			
325R - 25/30	25	25	150	25.6	12	25	30	FMM300R-03			
	30/35	25	25	150	25.6	12	30				35
	35/48	25	25	150	25.6	12	35				48
	48/60	25	25	150	25.6	22	48	60			FGD300R-03 FGM300R-03
	60/75	25	25	150	25.6	22	60	75			
	75/100	25	25	150	25.6	22	75	100			
	100/140	25	25	150	25.6	22	100	140			
420R - 25/30	20	20	125	20.6	12	25	30	FMM400R-04			
	30/35	20	20	125	20.6	12	30		35		
	35/48	20	20	125	20.6	12	35		48		
	48/60	20	20	125	20.6	25	48	60	FGD400R-04 FGM400R-04		
	60/75	20	20	125	20.6	25	60	75			
	75/100	20	20	125	20.6	25	75	100			
	100/140	20	20	125	20.6	25	100	140			
425R - 25/30	25	25	150	25.6	12	25	30	FMM400R-04			
	30/35	25	25	150	25.6	12	30		35		
	35/48	25	25	150	25.6	12	35		48		
	48/60	25	25	150	25.6	25	48	60	FGD400R-04 FGM400R-04		
	60/75	25	25	150	25.6	25	60	75			
	75/100	25	25	150	25.6	25	75	100			
	100/140	25	25	150	25.6	25	100	140			
520R - 25/30	20	20	125	20.6	12	25	30	FMM500R-04			
	30/35	20	20	125	20.6	12	30		35		
	35/40	20	20	125	20.6	20	35		40		
	40/48	20	20	125	20.6	20	40		48		
	48/60	20	20	125	20.6	25	48	60	FGD500R-04 FGM500R-04		
	60/75	20	20	125	20.6	25	60	75			
	75/100	20	20	125	20.6	25	75	100			
525R - 25/30	25	25	150	25.6	12	25	30	FMM500R-04			
	30/35	25	25	150	25.6	12	30		35		
	35/40	25	25	150	25.6	20	35		40		
	40/48	25	25	150	25.6	20	40		48		
	48/60	25	25	150	25.6	25	48	60	FGD500R-04 FGM500R-04		
	60/75	25	25	150	25.6	25	60	75			
	75/100	25	25	150	25.6	25	75	100			
100/140	25	25	150	25.6	25	100	140				

↻ Applicable inserts C28 ~ C30



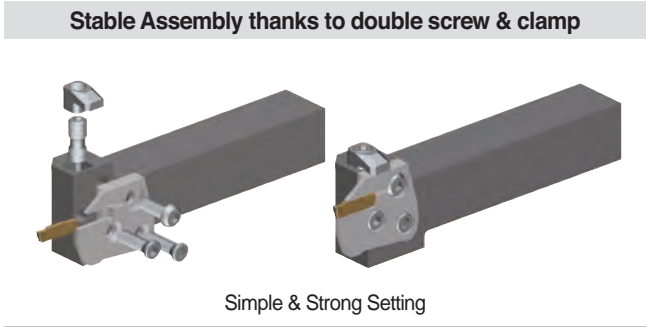
C

Multi functional Tools

## KGT/MGT cartridge

### Features





- Compatible and Economical due to divided cartridge & exclusive holder system from existing single body system
- Interchangeable cartridge
  - Various assembly depends on working style
  - Reduce cutting tool costs by over 30%
  - Setting with upper clamp & side screw
- Strong & Stable setting force
  - Simultaneous assembly of insert & cartridge
  - Easy assembly & tool exchange
- Stable assembly system
  - Simple & Superior setting force



### Code system

#### • Holder

KC	H	R/L	25	25
System Code	Holder Style	Hand	Height (mm)	Width (mm)
KC: KGT-Cartridge System MC: MGT-Cartridge System	H: Horizontal V: Vertical			

	Horizontal type		Vertical type	
				
MCHR	MCHL	MCVR	MCVL	
Available cartridge	External process: KCER/MCER Facing process: KCFL/MCFL	External process: KCEL/MCEL Facing process: KCFR/MCFR	External process: KCEL/MCEL Facing process: KCFR/MCFR	External process: KCER/MCER Facing process: KCFL/MCFL

#### • Cartridge

KC	F	R/L	3	24/35	T16
System Code	Working Style	Hand	Cutting Width (mm)	Facing Dia (min/max)	Maximum Depth (mm)
KC: KGT-Cartridge System MC: MGT-Cartridge System	E: External Process F: Facing Process				

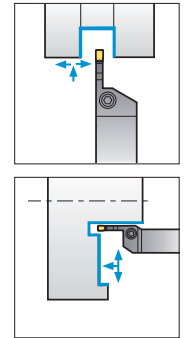
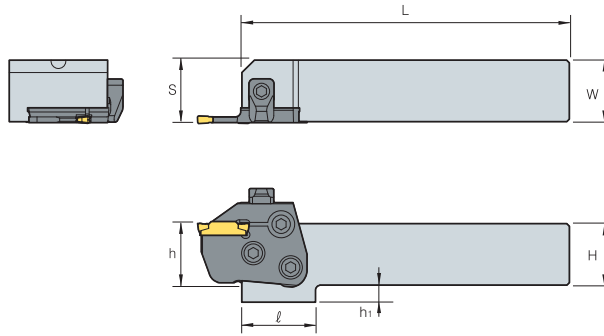
External Process		Facing Process	
			
KCER / MCER	KCEL / MCEL	KCFR / MCFR	KCFL / MCFL

## MCHR/L (Holder)

For grooving, turning, parting off, relief, profil machining



MCER/L  
MCFR/L



• R type insert

(mm)

Designation	H = (h)	W	L	S	ℓ	h <sub>1</sub>	Cartridge	Clamp	Clamp Screw	Hinge Screw	Clamping Screw	Wrench					
MCHR/L	2020	20	20	133	20.7	30	12	KCER/L, KCFR/L MCER/L, MCFR/L									
	2525	25	25	133	25.7	30	CXH8N							DHA0818F	RHA0613	FHGA0618	HW40L
	3232	32	32	153	32.7	-	-										

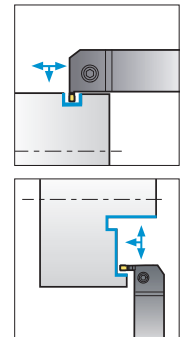
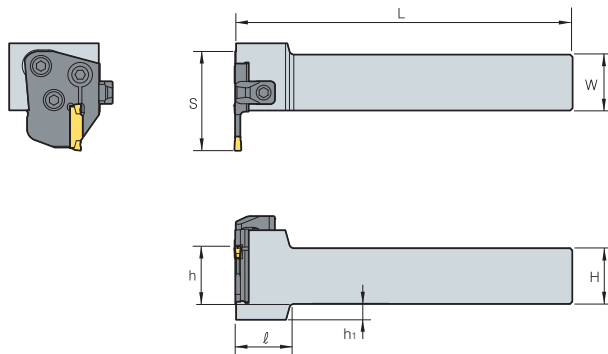
➔ Applicable cartridge C41 ~ C42

## MCVR/L (Holder)

For face grooving, turning machining



MCER/L  
MCFR/L



• R type insert

(mm)

Designation	H = (h)	W	L	S	ℓ	h <sub>1</sub>	Cartridge	Clamp	Clamp Screw	Hinge Screw	Clamping Screw	Wrench						
MCVR/L	2020	20	20	150	38	30	12	KCER/L, KCFR/L MCER/L, MCFR/L										
	2525	25	25	150	43	30	7							CXH8N	DHA0818F	RHA0613	FHGA0618	HW40L
	3232	32	32	170	50	-	-											

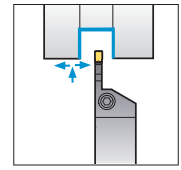
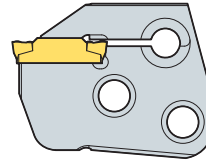
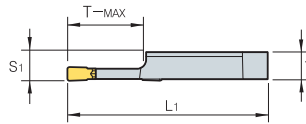
➔ Applicable cartridge C41 ~ C42

## KCER/L (Cartridge)

For grooving, turning, parting off, relief, profil machining



KGMN KGMR/L  
KGGN KRMN



• R type insert  
(mm)

Designation	T	L <sub>1</sub>	S <sub>1</sub>	T-MAX	Inserts		Holder
					Width	Designation	
KCER/L	3-T16	5.97	44.5	6.35	16	3	KGMN KGMR/L KGGN KRMN MCVR/L MCHR/L
	4-T16	5.97	44.5	6.35	16	4	
	5-T20	5.87	48.5	6.35	20	5	
	6-T20	5.82	48.5	6.35	20	6	

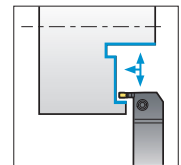
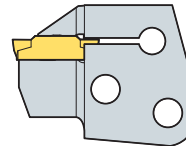
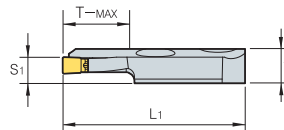
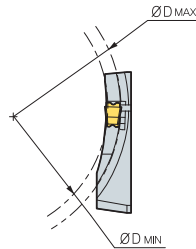
↻ Applicable inserts C12 ~ C14

## KCFR/L (Cartridge)

For face grooving, turning machining



KGMN  
KGMI



• R type insert  
(mm)

Designation	T	L <sub>1</sub>	S <sub>1</sub>	T-MAX	ØD		Inserts		Holder
					Min	Max	Width	Designation	
KCFR/L	3-34/50-T16	8.35	44.5	6.35	16	34	50	3	KGMN KRMN KGGN MCVR/L MCHR/L
	44/70-T16	8.35	44.5	6.35	16	44	70	3	
	64/99-T16	8.35	44.5	6.35	16	64	99	3	
	4-44/60-T16	8.35	44.5	6.35	16	44	60	4	
	60/120-T16	8.35	44.5	6.35	16	60	120	4	
	112/200-T16	8.35	44.5	6.35	16	112	200	4	

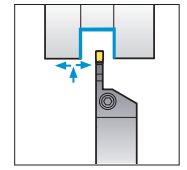
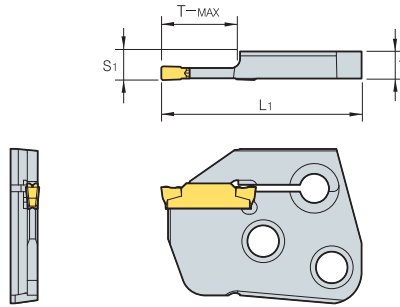
↻ Applicable inserts C12 ~ C14

## MCER/L (Cartridge)

For grooving, turning, parting off, relief, profil machining



MGMN MGMR  
MGGN MRMN



• R type insert  
(mm)

Designation	T	L <sub>1</sub>	S <sub>1</sub>	T-MAX	Inserts		Holder	
					Width	Designation		
<b>MCER/L</b>	<b>3-T16</b>	6.00	44.5	6.35	16	3	MGMN	MCVR/L MCHR/L
	<b>4-T16</b>	5.97	44.5	6.35	16	4	MGMR/L	
	<b>5-T20</b>	5.87	48.5	6.35	20	5	MGGN	
	<b>6-T20</b>	5.82	48.5	6.35	20	6	MRMN	

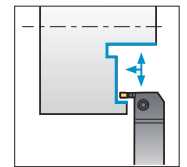
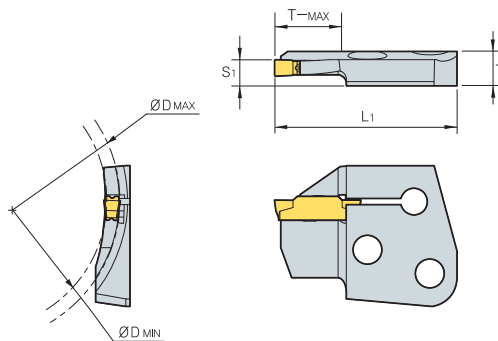
➔ Applicable inserts C28 ~ C30

## MCFR/L (Cartridge)

For face grooving, turning machining



MFNM  
MGMN



• R type insert  
(mm)

Designation	T	L <sub>1</sub>	S <sub>1</sub>	T-MAX	ØD		Inserts		Holder	
					Min	Max	Width	Designation		
<b>MCFR/L</b>	<b>3-24/35-T16</b>	8.00	44.5	6.35	16	24	35	3	MFNM300	MCVR/L MCHR/L
	<b>29/40-T16</b>	8.00	44.5	6.35	16	29	40	3		
	<b>34/50-T16</b>	8.00	44.5	6.35	16	34	50	3		
	<b>44/70-T16</b>	8.00	44.5	6.35	16	44	70	3		
	<b>64/99-T16</b>	8.00	44.5	6.35	16	64	99	3		
<b>4-44/60-T16</b>	<b>60/120-T16</b>	7.97	44.5	6.35	16	44	60	4	MGMN400	
	<b>112/200-T16</b>	7.97	44.5	6.35	16	60	120	4		
		7.97	44.5	6.35	16	112	200	4		

➔ Applicable inserts C28 ~ C30

## MGT - Machining aluminum wheels

### Features

- Optimally designed inserts for aluminum wheel machining
- Longer tool life when matched with the best grade for application
- Unique clamping mechanism places a strong clamp over the insert
- A variety of insert types for multi application functions

### Code system

#### Insert

MR	G	N	6	-	A
System Code	Tolerance	Hand	Cutting Edge Width		Chip Breaker
MR: Multi Grooving Round shape MV: Multi Grooving V shape	G: Ground	N: Neutral	6 mm, 8 mm		A/AM/AP/A5

#### Holder

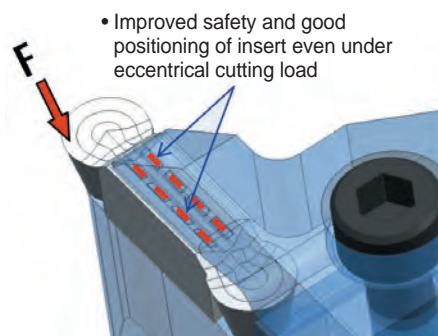
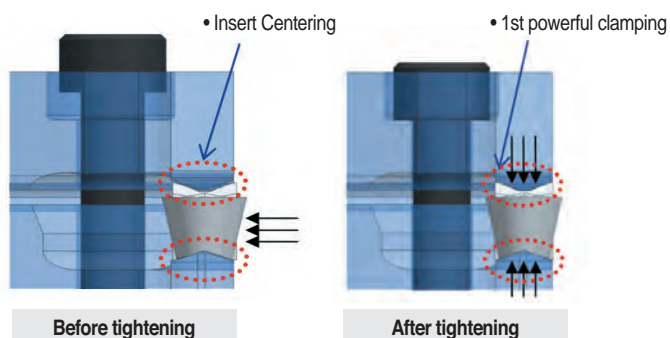
MG	E	H	R/L	25N	-	8	A	-	MR
System Code	Application	Holder Type	Hand	Shank Size	Cutting Width	Chip Breaker	Insert Type		
MG: Multi Grooving	E: External machining I: Internal machining	H: Horizontal V: Vertical U: Undercut X: Special	R: Right L: Left	Height: 25 mm Width: 25 mm (For internal machining: Minimum diameter)	1.5~8.0 mm	A/AM/ AP/A5	MR: ROUND shape MV: V shape		

### Various insert types

MRGN type : Full "Round" geometry

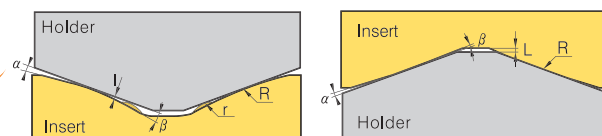
MRGN-A (For general)	MRGN-A5 (For copying)	MRGN-AM (Medium finishing)	MRGN-AP (PCD)	MVGN-A (For fine finishing)
				
High rake angle, Sharp cutting edge	Reinforced clamping force	For ductile cast iron	Improved chip control	High rake and relief angle

### New clamping system



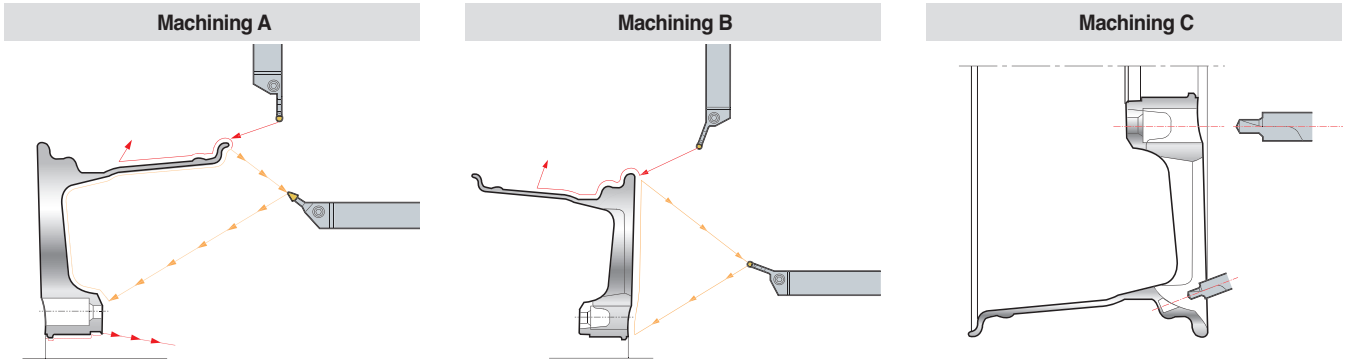
- Improved safety and good positioning of insert even under eccentric cutting load

- Reinforcing the clamping force due to radius designed on the top & bottom side of insert and convex "DOT" on the top of insert



# C Available Insert for MGT Aluminum Wheel


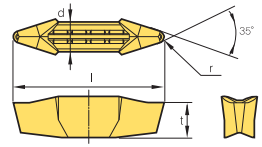

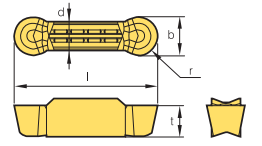
## Application of aluminum wheels



## Recommended cutting condition

Workpiece		Hardness Brinell (HB)	kc (MPa)	vc (m/min)	fn (mm/rev)
Aluminum alloy (Forged)	Unhardened	50 ~ 70	500 ~ 600	1,000 ~ 2,500	0.1 ~ 0.6
	Hardened	90 ~ 110	700 ~ 900	300 ~ 1,000	0.1 ~ 0.5
Aluminum alloy (Cast)	Unhardened	70 ~ 80	700 ~ 800	300 ~ 1,000	0.1 ~ 0.5
	Hardened	80 ~ 110	800 ~ 950	200 ~ 600	0.1 ~ 0.4
Copper alloy		90 ~ 110	700 ~ 900	300 ~ 800	0.1 ~ 0.5
Magnesium alloy		70 ~ 80	700 ~ 800	300 ~ 1,000	0.1 ~ 0.5

## Insert

Application	Picture	Designation	Coated	Uncoated	Dimensions (mm)					Configuration	Page
			DP150	G10	b	r	l	d	t		
For Aluminum Wheel	 MVGN	MVGN 8N-A-R1.2			-	1.2	30.0	6.0	6.9		C46
		MVGN 8N-A-R1.6			-	1.6	30.0	6.0	6.9		
	 MRGN-A	MRGN 6N-A		●	6.0	3.0	26.0	5.0	5.9		C45 C46
		MRGN 6N-AM			6.0	3.0	26.0	5.0	5.9		
		MRGN 6N-AP			6.0	3.0	26.0	5.0	5.9		
		MRGN 6N-A5		●	6.0	3.0	26.0	5.0	5.9		
		MRGN 8N-A			8.0	4.0	30.0	6.0	6.5		
		MRGN 8N-AM			8.0	4.0	30.0	6.0	6.5		
		MRGN 8N-AP			8.0	4.0	30.0	6.0	6.5		
		MRGN 8N-A5		●	8.0	4.0	30.0	6.0	6.5		

● : Stock item

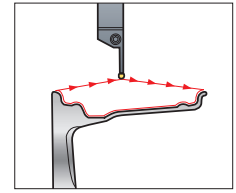
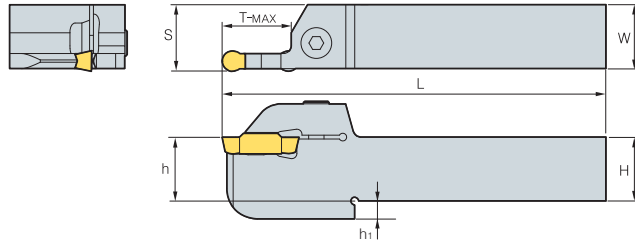




# MGEHR/L



MRGN



• R type insert (mm)

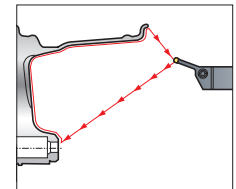
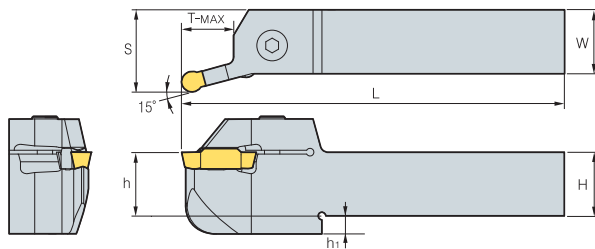
Designation	H = (h)	h <sub>1</sub>	W	L	S	T-MAX	Inserts	Screw	Wrench	
MGEHR/L	25N-6A	25	7	25	150	25.55	23.5	MRGN6N-A/AP/AM	BHA0620	HW50L
	32N-6A	32	8	32	150	32.55	27			
	25N-8A	25	7	25	150	25.55	23.5			
	32N-8A	32	8	32	150	32.55	27			
	25N-6A5	25	7	25	150	25.55	23.5	MRGN6N-A5		
	32N-6A5	32	8	32	150	32.55	27	MRGN6N-A5		
	25N-8A5	25	7	25	150	25.55	23.5	MRGN8N-A5		
	32N-8A5	32	8	32	150	32.55	27			

↻ Applicable inserts C44

# MGEHR/L-15



MRGN



• R type insert (mm)

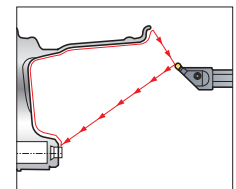
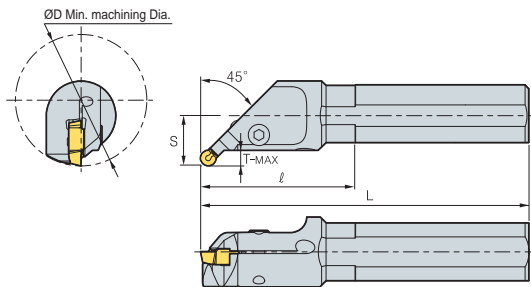
Designation	H = (h)	h <sub>1</sub>	W	L	S	T-MAX	Inserts	Screw	Wrench	
MGEHR/L	25N-6A-15	25	7	25	150	32.2	20	MRGN6N-A/AP/AM	BHA0620	HW50L
	32N-6A-15	32	8	32	150	39.2	25			
	25N-8A-15	25	7	25	150	32.2	20			
	32N-8A-15	32	8	32	150	39.2	25			
	25N-6A5-15	25	7	25	150	32.2	20	MRGN6N-A5		
	32N-6A5-15	32	8	32	150	39.2	25	MRGN6N-A5		
	25N-8A5-15	25	7	25	150	32.2	20	MRGN8N-A5		
	32N-8A5-15	32	8	32	150	39.2	25			

↻ Applicable inserts C44

# MGIUR/L-MR



MRGN



• R type insert (mm)

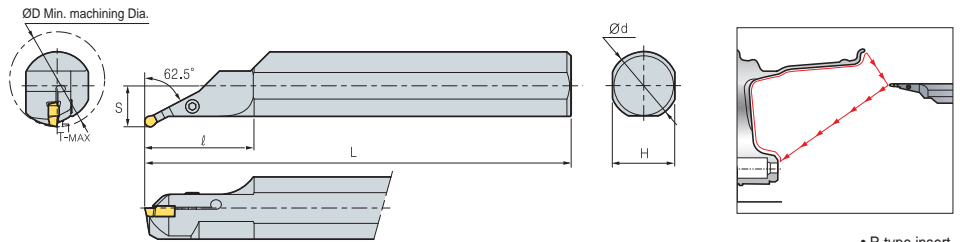
Designation	ØD	Ød	L	ℓ	T-MAX	H	S	Inserts	Screw	Wrench	
MGIUR/L	6832-8A-MR	68	32	170	65	7	30	26	MRGN8N-A/AM/AP	BHA0620	HW50L
	6832-8A5-MR	68	32	170	65	7	30	26	MRGN8N-A5		

↻ Applicable inserts C44

## MGIXR/L-MR



MRGN

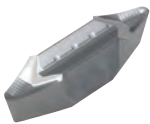


• R type insert (mm)

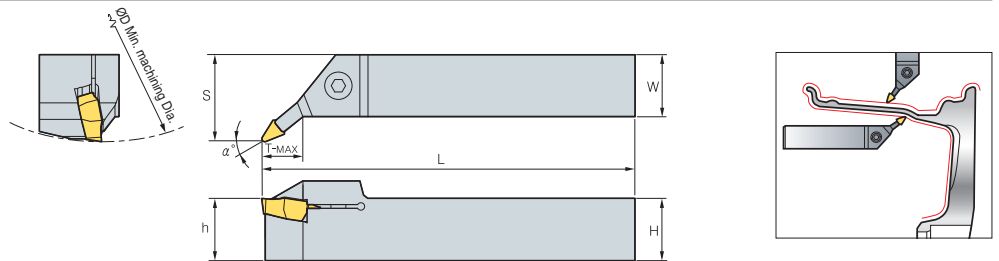
Designation	ØD	Ød	L	l	T-MAX	H	S	Inserts	Screw	Wrench
MGIXR/L 7050-8A-MR	70	50	350	80	5.5	46	30.2	MRGN8N-A/AM/AP	BHA0620	HW50L
7050-8A5-MR	70	50	350	80	5.5	46	30.2	MRGN8N-A5		

➔ Applicable inserts C44

## MGEXR/L



MVGN

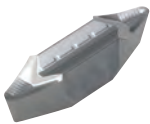


• R type insert (mm)

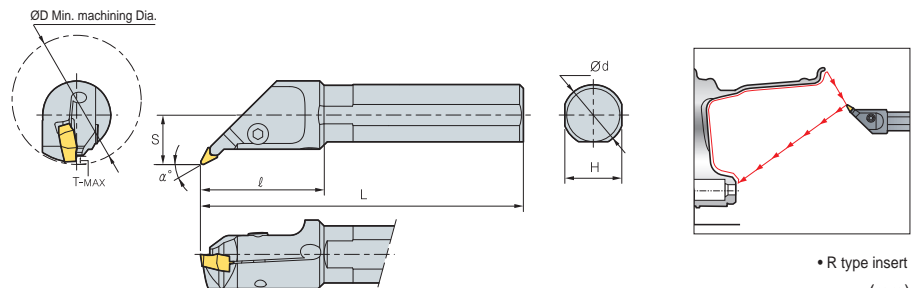
Designation	H = (h)	W	L	S	T-MAX	α°	Inserts	Screw	Wrench
MGEXR/L 25N-8A-5V	25	25	150	29	23.5	5	MVGN8N-A-R1.2	BHA0620	HW50L
25N-8A-22.5V	25	25	150	35	27	22.5	MVGN8N-A-R1.6		

➔ Applicable inserts C44

## MGIUR/L-MV



MVGN



• R type insert (mm)

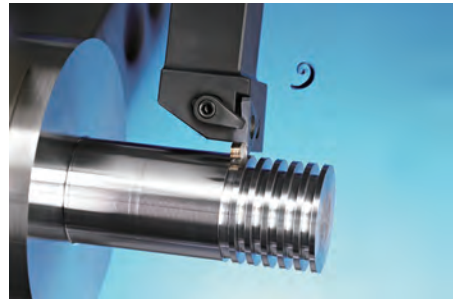
Designation	ØD	Ød	L	l	T-MAX	H	S	α°	Inserts	Screw	Wrench
MGIUR/L 6832-8A-MV	68	32	170	65	4.5	30	26	27.5	MVGN8N-A-R1.2 MVGN8N-A-R1.6	BHA0620	HW50L

➔ Applicable inserts C44



Economical 3-corner insert for high precision grooving

# TB/TB-M



- Economical 3-corner insert for grooving
- Various cutting edge size ranging from 1.25~4.5 mm
- High accuracy ground insert ensures high precision machining
- Stable chip control optimized for automated grooving process

**Code system**

• Insert

TB	5	150	N -	010	M
Triangle Blade	Inscribed circle	Cutting edge width	Hand	Nose R	Chip breaker
	3: 9.525 mm 4: 12.7 mm 5: 15.875 mm	0.5~4.5 mm	N: Neutral R: Right L: Left	0.00~0.40 mm	None M

• Holder

TBH	5	25	R
Triangle Blade Holder	Inscribed circle	Shank size	Hand
	3: 9.525 mm 4: 12.7 mm 5: 15.875 mm	10~25 mm	R: Right L: Left

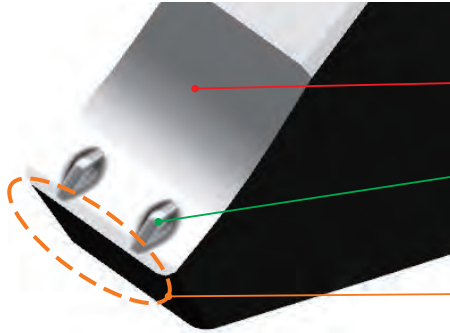
**TB/TB-M**

Specification	TB3000R/L, TB4000R/L	TB4000R-M	TB5000N-000-M	
Designation	TB3125R/L~TB3430R/L (Inscribed circle of 9.525 mm) TB4125R/L~TB4430R/L (Inscribed circle of 12.7 mm)	TB4150R-M~TB4450R-M (Inscribed circle of 12.7 mm)	TB5050N-000-M~TB5318-020-M (Inscribed circle of 15.875 mm)	
Insert shape				
Features	Chip breaker	Ground chip breaker	Pressed chip breaker	
	Hand	Right/Left-handed	Right-handed	Neutral
	Cutting edge width (b)	TB3000: 1.25~4.3 mm TB4000: 1.25~4.5 mm	1.5~4.5 mm	0.5~3.18 mm
	Depth of cut (T-MAX)	TB3000: ~3.5 mm TB4000: ~5.0 mm	~5.0 mm	~6.5 mm
	Shape	○	X	X
	Cutting edge width	○	○	○
Chip breaker shape				
Application range	P	P, M, K	P, M, K	
Grade	CN2000, PC5300	CN2000, PC5300	PC5300	

# C Technical Information for TB/TB-M

## ➤ TB-M chip breaker

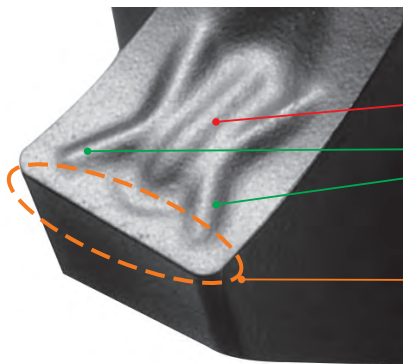
- Minimized cutting force at high speed and high feed → Smooth chip evacuation outside each groove
- High precision cutting performance → Exceptional surface finish and accurate dimensions
- Excellent chip flow and cutting results → Ideal for automated and unmanned productionw



### TB5-M Chip breaker

- **Lowered back area:** reduced load of chip evacuation due to minimizing chip friction
- **Beveled protruding dot:** made regular sized chip curls good chip flow out of the groove by reducing the chip width minimized load for chip evacuation in high depth of cut
- **Land:** prevented chipping and increased stability in interrupted machining
- **Use:** for grooving with T-MAX 6.5 mm below, parting and interrupted machining

Designation	TB5050N-M ~TB5120N-M	TB5140N-M ~TB5178N-M	TB5196N-M ~TB5239N-M	TB5247N-M ~TB5287N-M	TB5300N-M ~TB5318N-M
Shape					
Cutting edge width (b)	0.5~1.2 mm	1.40~1.78 mm	1.96~2.39 mm	2.47~2.87 mm	3.0~3.18 mm



### TB4-M Chip breaker

- **Second protruding dot:** stable chip curl control
- **Main protruding dot:** making regular sized chip curl good chip flow out of the groove by reducing the chip width good chip control in turning and chamfering
- **Sharp cutting edge:** increased machinability
- **Use:** for grooving with T-MAX 4.5 mm below and turning

Designation	TB4150R-M~TB4185R-M	TB4200R-M~TB4228R-M	TB4300R-M~TB4350R-M	TB4400R-M~TB4450R-M
Shape				
Cutting edge width (b)	1.5~1.85 mm	2.0~2.8 mm	3.0~3.5 mm	4.0~4.5 mm



## Guide for TB

(mm)

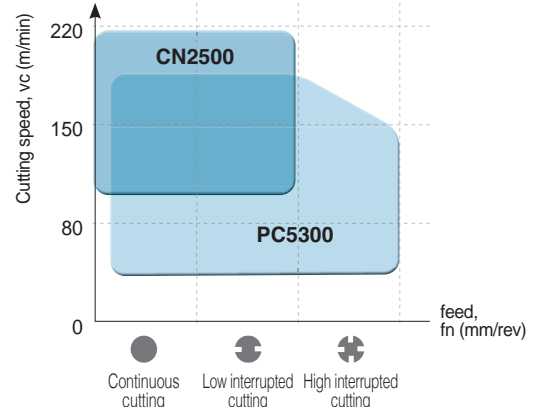
TB				TB3 / TB4	TB4-M	TB5-M	
Recommended machining method							
Cutting edge width W	Depth of cut T-MAX			Recommended feed rate (mm/rev)			
	TB3/TB4	TB4-M	TB5-M				
0.50	-	-	2.5	-	-	●	
0.80	-	-	1.6	-	-	●	
1.00	-	-	3.5	-	-	●	
1.04	-	-	2.0	-	-	●	
1.20	-	-	2.0	-	-	●	
1.25	2.0	-	2.0	●	-	-	
1.40	2.0	-	6.5	●	-	●	
1.45	2.0	-	-	●	-	-	
1.47	-	-	6.5	-	-	●	
1.50	3.5	3.5	6.5	●	●	●	
1.57	-	-	6.5	-	-	●	
1.70	-	-	6.5	-	-	●	
1.75	3.5	3.5	-	●	●	-	
1.78	-	-	6.5	-	-	●	
1.85	3.5	3.5	-	●	●	-	
1.96	-	-	6.5	-	-	●	
2.00	3.5	3.5	6.5	●	●	●	
2.15	3.5	3.5	-	●	●	-	
2.22	6.5	-	6.5	-	-	●	
2.30	3.5	3.5	6.5	●	●	●	
2.39	-	-	6.5	-	-	●	
2.47	-	-	6.5	-	-	●	
2.50	4.0	4.0	6.5	●	●	●	
2.65	4.0	4.0	6.5	●	●	-	
2.70	-	-	6.5	-	-	●	
2.80	4.0	4.0	-	●	●	-	
2.87	-	-	6.5	-	-	●	
3.00	4.0	4.0	6.5	●	●	●	
3.15	-	-	6.5	-	-	●	
3.18	-	-	6.5	-	-	●	
3.30	4.0	-	-	●	-	-	
3.50	5.0	5.0	-	●	●	-	
4.00	5.0	5.0	-	●	●	-	
4.30	5.0	5.0	-	●	●	-	
4.50	5.0	5.0	-	●	●	-	

## Recommended cutting conditions

Workpiece	Grade	CN2500 (Cermet)			PC5300 (Coated)		
		Min	Recommended	Max.	Min	Recommended	Max.
P	SM□□C type	100	160	220	80	140	200
	SCM type	100	150	200	80	130	180
M	STS type	-	-	-	40	80	150
K	GC, GCD type	-	-	-	80	130	180

Recommended cutting speed, vc (m/min)

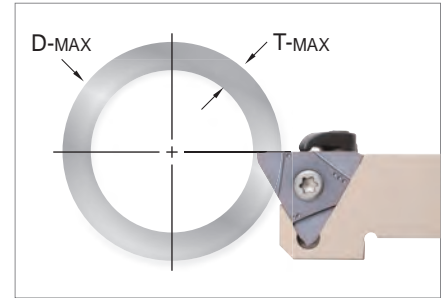
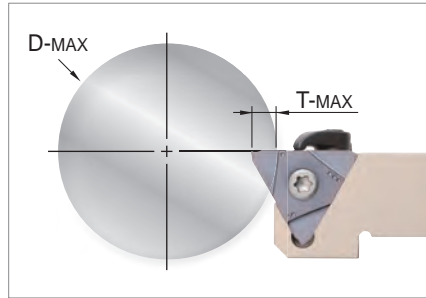
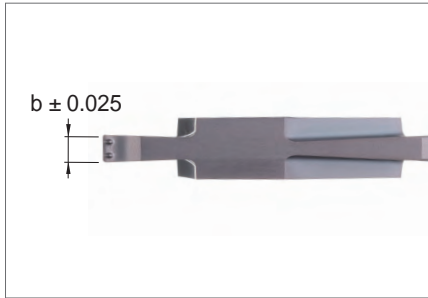
## Recommended cutting range



# C Technical Information for TB/TB-M

## ↻ TB5-M machining range

- There is a limit to cutting diameters of TB5-M when depth of cuts are over 5 mm  
(e.g. When cutting with a TB5200N-020-M insert at the depth of 6.2 mm, Ø60 D-MAX is available)
- N.L = No limit


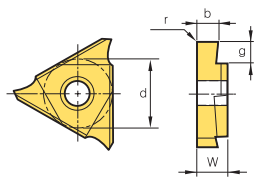

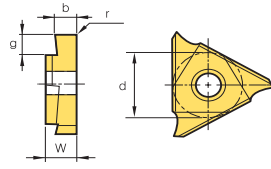


(mm)

Designation	b	r	g (T-MAX)	ØD-MAX										
				T ≤ 3.0	T ≤ 3.5	T ≤ 4.0	T ≤ 4.5	T ≤ 5.0	T ≤ 5.5	T ≤ 6.0	T ≤ 6.4	T ≤ 6.5		
TB	5050N- 000-M	0.50	0.00	1.0	-	-	-	-	-	-	-	-	-	-
	004-M	0.50	0.04	2.5	-	-	-	-	-	-	-	-	-	-
	5080N- 000-M	0.80	0.00	1.6	-	-	-	-	-	-	-	-	-	-
	5100N- 006-M	1.00	0.06	3.5	-	-	-	-	-	-	-	-	-	-
	5104N- 000-M	1.04	0.00	2.0	-	-	-	-	-	-	-	-	-	-
	5120N- 000-M	1.20	0.00	2.0	-	-	-	-	-	-	-	-	-	-
	5140N- 000-M	1.40	0.00	6.5	N.L	N.L	N.L	N.L	N.L	Ø300	Ø170	Ø60	Ø40	
	5147N- 000-M	1.47	0.00	6.5	N.L	N.L	N.L	N.L	N.L	Ø300	Ø170	Ø60	Ø40	
	5150N- 010-M	1.50	0.10	6.5	N.L	N.L	N.L	N.L	N.L	Ø300	Ø170	Ø60	Ø40	
	015-M	1.50	0.15	6.5	N.L	N.L	N.L	N.L	N.L	Ø300	Ø170	Ø60	Ø40	
	5157N- 015-M	1.57	0.15	6.5	N.L	N.L	N.L	N.L	N.L	Ø300	Ø170	Ø60	Ø40	
	5170N- 010-M	1.70	0.10	6.5	N.L	N.L	N.L	N.L	N.L	Ø300	Ø170	Ø60	Ø40	
	5178N- 018-M	1.78	0.18	6.5	N.L	N.L	N.L	N.L	N.L	Ø300	Ø170	Ø60	Ø40	
	5196N- 015-M	1.96	0.15	6.5	N.L	N.L	N.L	N.L	N.L	Ø300	Ø170	Ø60	Ø40	
	5200N- 020-M	2.00	0.20	6.5	N.L	N.L	N.L	N.L	N.L	Ø300	Ø170	Ø60	Ø40	
	5222N- 015-M	2.22	0.15	6.5	N.L	N.L	N.L	N.L	N.L	Ø300	Ø170	Ø60	Ø40	
	5230N- 020-M	2.30	0.20	6.5	N.L	N.L	N.L	N.L	N.L	Ø300	Ø170	Ø60	Ø40	
	5239N- 015-M	2.39	0.15	6.5	N.L	N.L	N.L	N.L	N.L	Ø300	Ø170	Ø60	Ø40	
	5247N- 020-M	2.47	0.20	6.5	N.L	N.L	N.L	N.L	N.L	Ø300	Ø170	Ø60	Ø40	
	5250N- 020-M	2.50	0.20	6.5	N.L	N.L	N.L	N.L	N.L	Ø300	Ø170	Ø60	Ø40	
	5270N- 010-M	2.70	0.10	6.5	N.L	N.L	N.L	N.L	N.L	Ø300	Ø170	Ø60	Ø40	
	5287N- 020-M	2.87	0.20	6.5	N.L	N.L	N.L	N.L	N.L	Ø300	Ø170	Ø60	Ø40	
	5300N- 000-M	3.00	0.00	6.5	N.L	N.L	N.L	N.L	N.L	Ø300	Ø170	Ø60	Ø40	
	020-M	3.00	0.20	6.5	N.L	N.L	N.L	N.L	N.L	Ø300	Ø170	Ø60	Ø40	
	040-M	3.00	0.40	6.5	N.L	N.L	N.L	N.L	N.L	Ø300	Ø170	Ø60	Ø40	
	5315N- 015-M	3.15	0.15	6.5	N.L	N.L	N.L	N.L	N.L	Ø300	Ø170	Ø60	Ø40	
	5318N- 020-M	3.18	0.20	6.5	N.L	N.L	N.L	N.L	N.L	Ø300	Ø170	Ø60	Ø40	



Insert


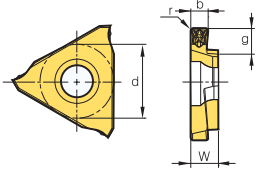

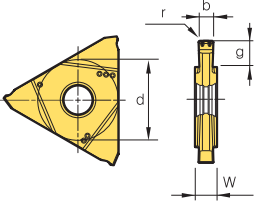
Picture	Designation	Cermet		Coated	Dimensions (mm)					Configuration
		CN2000	CN2500	PC5300	b	g (T-MAX)	r	w	d	
	TB (Right-handed)	3125R			1.25	1.5	0.2	4.76	9.525	
		3145R			1.45	1.5	0.2	4.76	9.525	
		3175R			1.75	2.5	0.2	4.76	9.525	
		3185R			1.85	2.5	0.2	4.76	9.525	
		3200R			2.00	2.5	0.2	4.76	9.525	
		3230R			2.30	3.5	0.3	4.76	9.525	
		3280R			2.80	3.5	0.3	4.76	9.525	
		3330R			3.30	3.5	0.3	4.76	9.525	
		3430R			4.30	3.5	0.4	4.76	9.525	
		4125R	●	●	1.25	2.0	0.2	4.76	12.7	
		4145R	●	●	1.45	2.0	0.2	4.76	12.7	
		4150R	●	●	1.50	3.5	0.2	4.76	12.7	
		4175R	●	●	1.75	3.5	0.2	4.76	12.7	
		4185R	●	●	1.85	3.5	0.2	4.76	12.7	
		4200R	●	●	2.00	3.5	0.2	4.76	12.7	
		4215R	●	●	2.15	3.5	0.2	4.76	12.7	
		4230R	●	●	2.30	3.5	0.2	4.76	12.7	
		4250R	●	●	2.50	4.0	0.3	4.76	12.7	
		4265R	●	●	2.65	4.0	0.3	4.76	12.7	
		4280R	●	●	2.80	4.0	0.3	4.76	12.7	
		4300R	●	●	3.00	4.0	0.3	4.76	12.7	
		4330R	●		3.30	4.0	0.3	4.76	12.7	
		4350R	●		3.50	5.0	0.3	4.76	12.7	
		4400R	●	●	4.00	5.0	0.4	4.76	12.7	
		4430R	●	●	4.30	5.0	0.4	4.76	12.7	
		4450R	●	●	4.50	5.0	0.4	4.76	12.7	
	TB (Left-handed)	3125L			1.25	1.5	0.2	4.76	9.525	
		3145L			1.45	1.5	0.2	4.76	9.525	
		3175L			1.75	2.5	0.2	4.76	9.525	
		3185L			1.85	2.5	0.2	4.76	9.525	
		3200L			2.00	2.5	0.2	4.76	9.525	
		3230L			2.30	3.5	0.3	4.76	9.525	
		3280L			2.80	3.5	0.3	4.76	9.525	
		3330L			3.30	3.5	0.3	4.76	9.525	
		3430L			4.30	3.5	0.4	4.76	9.525	
		4125L			1.25	2.0	0.2	4.76	12.7	
		4145L			1.45	2.0	0.2	4.76	12.7	
		4150L			1.50	3.5	0.2	4.76	12.7	
		4175L			1.75	3.5	0.2	4.76	12.7	
		4185L			1.85	3.5	0.2	4.76	12.7	
		4200L			2.00	3.5	0.2	4.76	12.7	
		4215L			2.15	3.5	0.2	4.76	12.7	
		4230L			2.30	3.5	0.2	4.76	12.7	
		4250L			2.50	4.0	0.3	4.76	12.7	
		4265L			2.65	4.0	0.3	4.76	12.7	
		4280L			2.80	4.0	0.3	4.76	12.7	
		4300L			3.00	4.0	0.3	4.76	12.7	
		4330L			3.30	4.0	0.3	4.76	12.7	
		4350L			3.50	5.0	0.3	4.76	12.7	
		4400L			4.00	5.0	0.4	4.76	12.7	
		4430L			4.30	5.0	0.4	4.76	12.7	
		4450L			4.50	5.0	0.4	4.76	12.7	

● : Stock item





## Insert

Picture	Designation	Cermet		Coated	Dimensions (mm)					Configuration
		CN2000	CN2500	PC5300	b	g (T-MAX)	r	w	d	
	<b>TB</b> (Right-handed)									
	<b>4150R-M</b>	●		●	1.50	3.5	0.20	4.76	12.7	
	<b>4175R-M</b>	●		●	1.75	3.5	0.20	4.76	12.7	
	<b>4185R-M</b>	●		●	1.85	3.5	0.20	4.76	12.7	
	<b>4200R-M</b>	●		●	2.00	3.5	0.20	4.76	12.7	
	<b>4215R-M</b>	●		●	2.15	3.5	0.20	4.76	12.7	
	<b>4230R-M</b>	●		●	2.30	3.5	0.20	4.76	12.7	
	<b>4250R-M</b>	●		●	2.50	4.0	0.30	4.76	12.7	
	<b>4265R-M</b>	●		●	2.65	4.0	0.30	4.76	12.7	
	<b>4280R-M</b>	●		●	2.80	4.0	0.30	4.76	12.7	
	<b>4300R-M</b>	●		●	3.00	4.0	0.30	4.76	12.7	
	<b>4330R-M</b>			●	3.30	4.0	0.30	4.76	12.7	
	<b>4350R-M</b>	●		●	3.50	5.0	0.30	4.76	12.7	
	<b>4400R-M</b>	●		●	4.00	5.0	0.40	4.76	12.7	
	<b>4430R-M</b>	●		●	4.30	5.0	0.40	4.76	12.7	
	<b>4450R-M</b>	●		●	4.50	5.0	0.40	4.76	12.7	
	<b>TB</b> (Neutral)									
	<b>5050N-000-M</b>			●	0.50	1.0	0.00	4.50	15.875	
	<b>5050N-004-M</b>			●	0.50	2.5	0.04	4.50	15.875	
	<b>5080N-000-M</b>			●	0.80	1.6	0.00	4.50	15.875	
	<b>5100N-006-M</b>			●	1.00	3.5	0.06	4.50	15.875	
	<b>5104N-000-M</b>			●	1.04	2.0	0.00	4.50	15.875	
	<b>5120N-000-M</b>			●	1.20	2.0	0.00	4.50	15.875	
	<b>5140N-000-M</b>			●	1.40	6.5	0.00	4.50	15.875	
	<b>5147N-000-M</b>			●	1.47	6.5	0.00	4.50	15.875	
	<b>5150N-010-M</b>			●	1.50	6.5	0.10	4.50	15.875	
	<b>5150N-015-M</b>			●	1.50	6.5	0.15	4.50	15.875	
	<b>5157N-015-M</b>			●	1.57	6.5	0.15	4.50	15.875	
	<b>5170N-010-M</b>			●	1.70	6.5	0.10	4.50	15.875	
	<b>5178N-018-M</b>			●	1.78	6.5	0.18	4.50	15.875	
	<b>5196N-015-M</b>			●	1.96	6.5	0.15	4.50	15.875	
	<b>5200N-020-M</b>			●	2.00	6.5	0.20	4.50	15.875	
	<b>5222N-015-M</b>			●	2.22	6.5	0.15	4.50	15.875	
	<b>5230N-020-M</b>			●	2.30	6.5	0.20	4.50	15.875	
	<b>5239N-015-M</b>			●	2.39	6.5	0.15	4.50	15.875	
	<b>5247N-020-M</b>			●	2.47	6.5	0.20	4.50	15.875	
<b>5250N-020-M</b>			●	2.50	6.5	0.20	4.50	15.875		
<b>5270N-010-M</b>			●	2.70	6.5	0.10	4.50	15.875		
<b>5287N-020-M</b>			●	2.87	6.5	0.20	4.50	15.875		
<b>5300N-000-M</b>			●	3.00	6.5	0.00	4.50	15.875		
<b>5300N-020-M</b>			●	3.00	6.5	0.20	4.50	15.875		
<b>5300N-040-M</b>			●	3.00	6.5	0.40	4.50	15.875		
<b>5315N-015-M</b>			●	3.15	6.5	0.15	4.50	15.875		
<b>5318N-020-M</b>			●	3.18	6.5	0.20	4.50	15.875		

● : Stock item

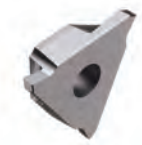


**Insert**

Picture	Designation	Cermet		Coated	Dimensions (mm)						Configuration
		CN2000	CN2500	PC5300	b	g (T-Max)	r	a°	w	d	
	<b>TB</b> 5050N-004-P				0.50	1.0	0.04	-	4.50	15.875	
	(Neutral) 5100N-010-P				1.00	3.5	0.10	-	4.50	15.875	
	5150N-010-P				1.50	6.5	0.10	-	4.50	15.875	
	020-P				1.50	6.5	0.20	-	4.50	15.875	
	5200N-010-P				2.00	6.5	0.10	-	4.50	15.875	
	020-P				2.00	6.5	0.20	-	4.50	15.875	
	5239N-015-P				2.39	6.5	0.15	-	4.50	15.875	
	5250N-020-P				2.50	6.5	0.20	-	4.50	15.875	
	5300N-020-P				3.00	6.5	0.20	-	4.50	15.875	
	<b>TB</b> 5100N-6DR-P				1.00	3.5	0.05	6	4.50	15.875	
	15DR-P				1.00	3.5	0.05	15	4.50	15.875	
	5150N-6DR-P				1.50	6.5	0.05	6	4.50	15.875	
	15DR-P				1.50	6.5	0.05	15	4.50	15.875	
	5200N-6DR-P				2.00	6.5	0.10	6	4.50	15.875	
	15DR-P				2.00	6.5	0.10	15	4.50	15.875	
	<b>TB</b> 5100N-6DL-P				1.00	3.5	0.05	6	4.50	15.875	
	15DL-P				1.00	3.5	0.05	15	4.50	15.875	
	5150N-6DL-P				1.50	6.5	0.05	6	4.50	15.875	
	15DL-P				1.50	6.5	0.05	15	4.50	15.875	
	5200N-6DL-P				2.00	6.5	0.10	6	4.50	15.875	
	15DL-P				2.00	6.5	0.10	15	4.50	15.875	
	<b>TB</b> 5157N-079-P				1.57	6.5	0.79	-	4.50	15.875	
	(Neutral, Round shape) 5200N-100-P				2.00	6.5	1.00	-	4.50	15.875	
	5239N-120-P				2.39	6.5	1.20	-	4.50	15.875	
	5300N-150-P				3.00	6.5	1.50	-	4.50	15.875	

● : Stock item

# TBH



TB3000R/L  
TB4000R-M

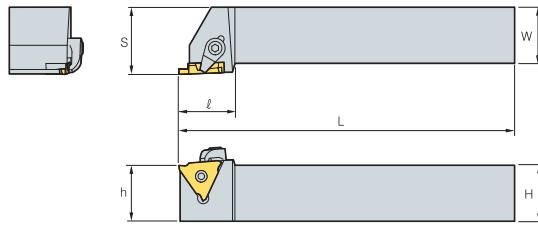
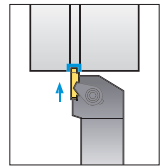


Fig. 1



• R type insert



TB5000N-□□□-M

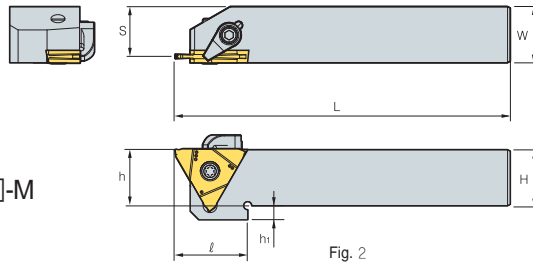


Fig. 2

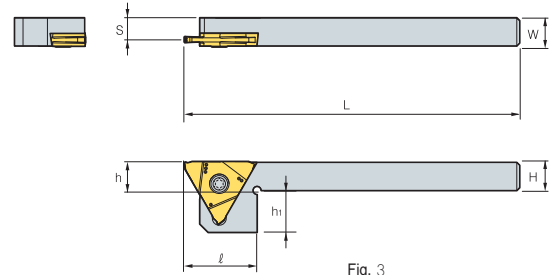


Fig. 3

(mm)

Designation	Dimensions							Inserts	Clamp	Clamp Screw	Screw	Wrench	Fig
	H = (h)	W	L	l	h <sub>1</sub>	S							
<b>TBH</b>	<b>320R/L-23</b>	20	20	125	25.5	-	25	TB3125~3230R/L	CS6R1	DHA0617	-	HW30L	1
	<b>320R/L-33</b>	20	20	125	25.5	-	25	TB3280~3330R/L					
	<b>320R/L-43</b>	20	20	125	25.5	-	25	TB3430R/L					
	<b>325R/L-23</b>	25	25	150	25.5	-	30	TB3125~3230R/L					
	<b>325R/L-33</b>	25	25	150	25.5	-	30	TB3280~3330R/L					
	<b>325R/L-43</b>	25	25	150	25.5	-	30	TB3430R/L					
	<b>420R/L-23</b>	20	20	125	25.5	-	25	TB4125~4230R/L					
	<b>420R/L-33</b>	20	20	125	25.5	-	25	TB4250~4330R/L					
	<b>420R/L-45</b>	20	20	125	25.5	-	25	TB4350~4450R/L					
	<b>425R/L-23</b>	25	25	150	25.5	-	30	TB4125~4230R/L					
	<b>425R/L-33</b>	25	25	150	25.5	-	30	TB4250~4330R/L					
	<b>425R/L-45</b>	25	25	150	25.5	-	30	TB4350~4450R/L					
<b>TBH</b>	<b>510R/L</b>	10	10	125	25	15	7.8	TB5050~5318N	-	-	FTNA0512	TW20L	3
	<b>512R/L</b>	12	12	125	25	13	9.8						
	<b>516R/L</b>	16	16	125	26	9	13.8						
	<b>520R/L</b>	20	20	125	26	5	17.8		CS6R1	DHA0617	FTNA0516	HW30L, TW20L	2
	<b>525R/L</b>	25	25	150	-	-	22.8						

The Solution for High-Precision Grooving

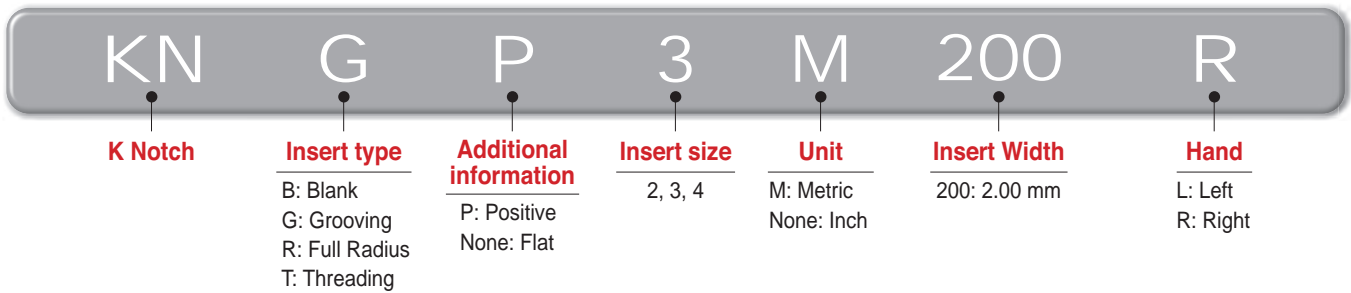
# K Notch

## KORLOY Grooving Tool

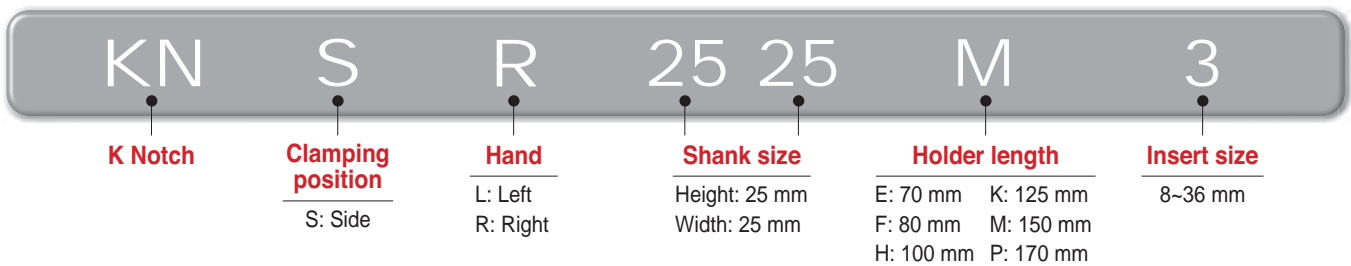
- KORLOY clamping system offers high rigidity for high precision machining
- High-quality cutting edge ensuring long tool life and excellent machinability
- Provides various cutting edge widths for a wide range of selection

### Code system

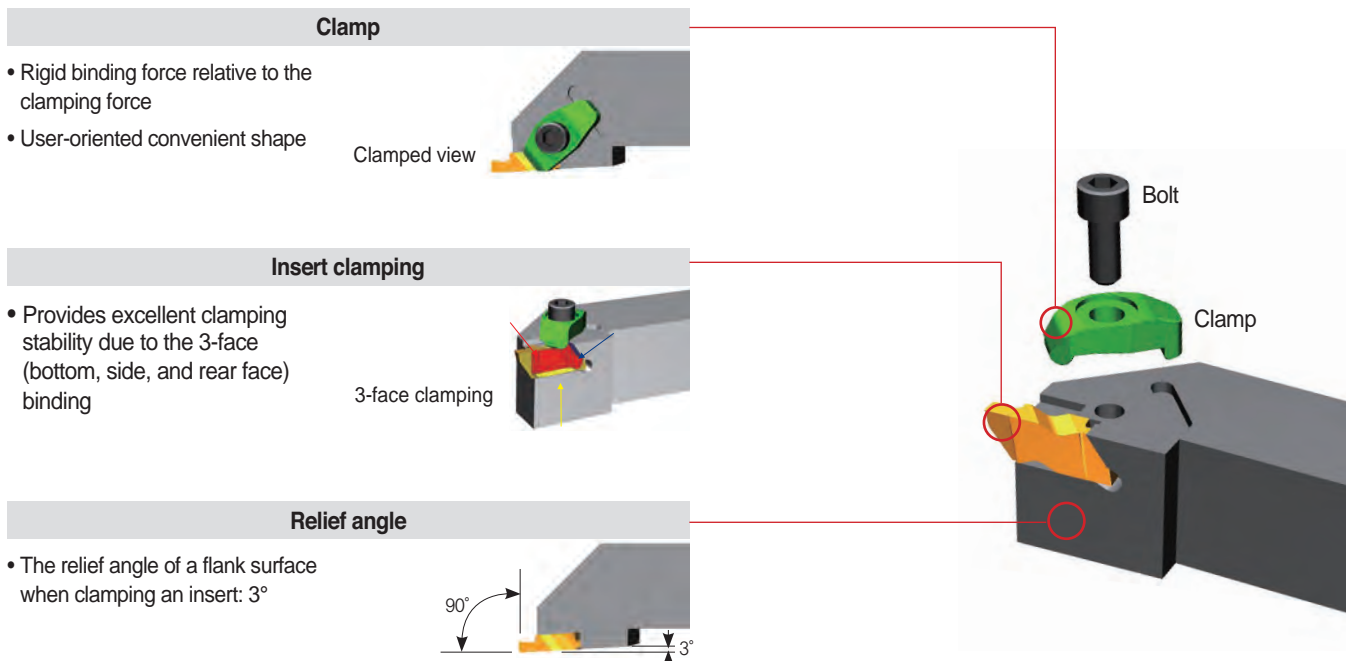
• Insert



• Holder

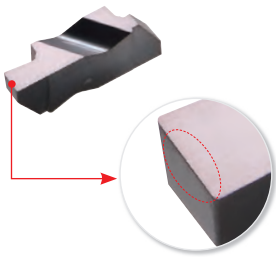


### Features of holder



# C Technical Information for K Notch

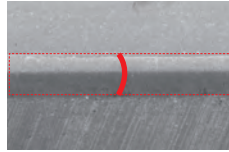
## Features of insert



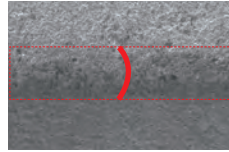
[Edge preparation]

### High-quality edge preparation

- Cutting edges in uniform quality
- Long tool life



[K Notch]



[Competitor]

### Mirror-like rake surface

- Improved resistance to welding and chipping
- Improved surface finish of workpieces



[K Notch]

## Recommended feed per insert type

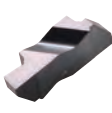
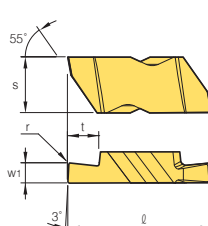
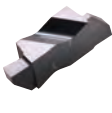
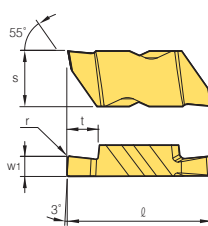

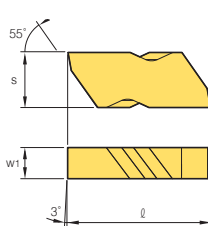
Type		KNG	KNGP	KNR	KNRP	KNB
Insert shape						
Cutting-edge						
Application		General grooving	General grooving	Turning profiling	Turning profiling	Blank
Recommended workpiece	1st	P, K	M, N, S	P, K	M, N, S	-
	2nd	M, N, S	P, K	M, N, S	P, K	-
Recommended feed, $f_n$ (mm/rev)	P	0.10 - 0.28	0.08 - 0.25	0.10 - 0.28	0.08 - 0.25	-
	M	0.10 - 0.25	0.08 - 0.25	0.10 - 0.25	0.08 - 0.25	-
	K	0.10 - 0.28	0.08 - 0.25	0.10 - 0.28	0.08 - 0.25	-
	N	0.01 - 0.30	0.01 - 0.30	0.01 - 0.30	0.01 - 0.30	-
	S	0.05 - 0.15	0.05 - 0.15	0.05 - 0.15	0.05 - 0.15	-

## Recommended cutting speed per grade

Workpiece	Grade	Recommended cutting speed, $v_c$ (m/min)				
		50	100	200	300	600
P	Steel		80	200		
	Alloy steel	60	160			
M	Stainless steel		80	130		
			80	160		
K	Cast iron		90	200		
N	Non-ferrous metal			150		600
S	Heat-resistant alloy	35	65			


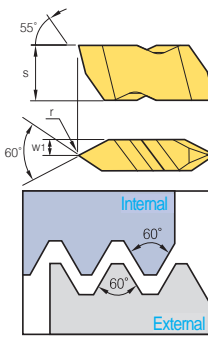


Insert (Metric)

Application	Picture	Designation	Coated			Dimensions										Configuration
			PC5300	PC8110	Uncoated	mm					inch					
						s	w <sub>1</sub>	r	t	ℓ	s	w <sub>1</sub>	r	t	ℓ	
Flat Top		KNG 2M 150R				5.56	1.50	0.19	2.79	13.030	0.219	0.059	0.0075	0.11	0.513	
						5.56	2.00	0.19	2.79	13.030	0.219	0.079	0.0075	0.11	0.513	
						5.56	2.50	0.19	2.79	13.030	0.219	0.098	0.0075	0.11	0.513	
					5.56	3.00	0.19	2.79	13.030	0.219	0.118	0.0075	0.11	0.513		
					8.74	1.50	0.19	2.79	22.709	0.344	0.059	0.0075	0.075	0.894		
					8.74	2.00	0.19	2.79	22.709	0.344	0.079	0.0075	0.11	0.894		
					8.74	2.50	0.19	3.81	22.709	0.344	0.098	0.0075	0.15	0.894		
					8.74	3.00	0.19	3.81	22.709	0.344	0.118	0.0075	0.15	0.894		
					8.74	4.00	0.19	3.81	22.709	0.344	0.157	0.0075	0.15	0.894		
					11.51	5.00	0.20	6.35	28.663	0.453	0.197	0.0079	0.25	1.128		
C/B Ground		KNGP 2M 150R				5.56	1.50	0.19	2.79	13.030	0.219	0.059	0.0075	0.11	0.513	
						5.56	2.00	0.19	2.79	13.030	0.219	0.079	0.0075	0.11	0.513	
						5.56	2.50	0.19	2.79	13.030	0.219	0.098	0.0075	0.11	0.513	
					5.56	3.00	0.19	2.79	13.030	0.219	0.118	0.0075	0.11	0.513		
					8.74	1.50	0.19	2.79	22.709	0.344	0.059	0.0075	0.075	0.894		
					8.74	2.00	0.19	2.79	22.709	0.344	0.079	0.0075	0.11	0.894		
					8.74	2.50	0.19	3.81	22.709	0.344	0.098	0.0075	0.15	0.894		
					8.74	3.00	0.19	3.81	22.709	0.344	0.118	0.0075	0.15	0.894		
					8.74	4.00	0.19	3.81	22.709	0.344	0.157	0.0075	0.15	0.894		
					11.51	5.00	0.20	6.35	28.663	0.453	0.197	0.0079	0.25	1.128		
Blank		KNB 2R				5.56	3.81	-	-	13.030	0.219	0.150	-	-	0.513	
						8.74	4.95	-	-	22.709	0.344	0.195	-	-	0.894	
						11.51	6.48	-	-	28.663	0.453	0.255	-	-	1.128	

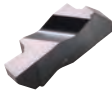
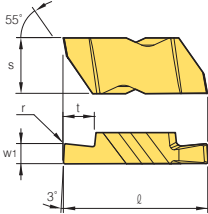
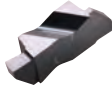
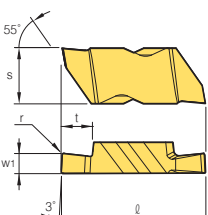

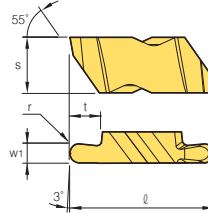
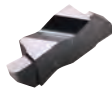
● : Stock item

Insert (Threading)

Application	Picture	Designation	Coated		Dimensions							Configuration	
			PC5300	PC8110	mm			inch			Pitch (External)		
					s	w <sub>1</sub>	r	s	w <sub>1</sub>	r	mm		tpi
Partial Profiling 60°		KNT 2R			5.56	3.81	0.10	0.219	0.150	0.004	0.70-3.00	8-36	
					8.74	4.95	0.17	0.344	0.195	0.007	1.25-4.00	6-20	
					11.51	6.48	0.17	0.453	0.255	0.007	1.25-6.25	4-20	

● : Stock item

## Insert (Inch)

Application	Picture	Designation	Coated		Dimensions										Configuration
			PC5300	PC8110	mm					inch					
					s	w1	r	t	ℓ	s	w1	r	t	ℓ	
Flat Top		KNG	2031R		5.56	0.79	0.09	1.27	13.030	0.219	0.031	0.0035	0.05	0.513	
			2041R		5.56	1.04	0.09	1.27	13.030	0.219	0.041	0.0035	0.05	0.513	
			2047R		5.56	1.19	0.09	1.27	13.030	0.219	0.047	0.0035	0.05	0.513	
			2058R		5.56	1.47	0.19	1.27	13.030	0.219	0.058	0.0075	0.05	0.513	
			2062R		5.56	1.57	0.19	2.79	13.030	0.219	0.062	0.0075	0.11	0.513	
			2094R		5.56	2.39	0.19	2.79	13.030	0.219	0.094	0.0075	0.11	0.513	
			2125R		5.56	3.18	0.19	2.79	13.030	0.219	0.125	0.0075	0.11	0.513	
			3047R		8.74	1.19	0.19	1.91	22.709	0.344	0.047	0.0075	0.075	0.894	
			3062R	●	8.74	1.57	0.19	2.39	22.709	0.344	0.062	0.0075	0.094	0.894	
			3072R		8.74	1.83	0.19	2.39	22.709	0.344	0.072	0.0075	0.094	0.894	
			3078R	●	8.74	1.98	0.19	2.39	22.709	0.344	0.078	0.0075	0.094	0.894	
			3088R		8.74	2.24	0.19	2.39	22.709	0.344	0.088	0.0075	0.094	0.894	
			3094R		8.74	2.39	0.19	3.81	22.709	0.344	0.094	0.0075	0.15	0.894	
			3097R	●	8.74	2.46	0.32	3.81	22.709	0.344	0.097	0.0125	0.15	0.894	
			3105R		8.74	2.67	0.19	3.81	22.709	0.344	0.105	0.0075	0.15	0.894	
			3110R		8.74	2.79	0.32	3.81	22.709	0.344	0.110	0.0125	0.15	0.894	
			3122R		8.74	3.10	0.19	3.81	22.709	0.344	0.122	0.0075	0.15	0.894	
			3125R	●	8.74	3.18	0.19	3.81	22.709	0.344	0.125	0.0075	0.15	0.894	
			3142R		8.74	3.61	0.32	3.81	22.709	0.344	0.142	0.0125	0.15	0.894	
			3156R	●	8.74	3.96	0.19	3.81	22.709	0.344	0.156	0.0075	0.15	0.894	
			3178R		8.74	4.52	0.19	3.81	22.709	0.344	0.178	0.0075	0.15	0.894	
			3185R		8.74	4.70	0.57	3.81	22.709	0.344	0.185	0.0225	0.15	0.894	
			3189R	●	8.74	4.80	0.57	3.81	22.709	0.344	0.189	0.0225	0.15	0.894	
			4125R	●	11.51	3.18	0.19	3.81	28.663	0.453	0.125	0.0075	0.15	1.128	
			4189R		11.51	4.80	0.57	6.35	28.663	0.453	0.189	0.0225	0.25	1.128	
4213R		11.51	5.41	0.19	6.35	28.663	0.453	0.213	0.0075	0.25	1.128				
4219R		11.51	5.56	0.57	6.35	28.663	0.453	0.219	0.0225	0.25	1.128				
4250R		11.51	6.35	0.57	6.35	28.663	0.453	0.250	0.0225	0.25	1.128				
C/B Ground		KNGP	2031R		5.56	0.79	0.09	1.27	13.030	0.219	0.031	0.0035	0.05	0.513	
			2062R		5.56	1.57	0.19	2.79	13.030	0.219	0.062	0.0075	0.11	0.513	
			2125R		5.56	3.18	0.19	2.79	13.030	0.219	0.125	0.0075	0.11	0.513	
			3088R		8.74	2.24	0.19	2.39	22.709	0.344	0.088	0.0075	0.094	0.894	
			3125R	●	8.74	3.18	0.19	3.81	22.709	0.344	0.125	0.0075	0.15	0.894	
			3156R	●	8.74	3.96	0.19	3.81	22.709	0.344	0.156	0.0075	0.15	0.894	
			3189R		8.74	4.80	0.57	3.81	22.709	0.344	0.189	0.0225	0.15	0.894	
			4189R		11.51	4.80	0.57	6.35	28.663	0.453	0.189	0.0225	0.25	1.128	
			4250R		11.51	6.35	0.57	6.35	28.663	0.453	0.250	0.0225	0.25	1.128	
Round Flat Top		KNR	2031R		5.56	1.57	0.79	2.79	13.030	0.219	0.062	0.031	0.11	0.513	
			2047R		5.56	2.39	1.19	2.79	13.030	0.219	0.094	0.047	0.11	0.513	
			3031R	●	8.74	1.57	0.79	2.39	22.709	0.344	0.062	0.031	0.094	0.894	
			3047R	●	8.74	2.39	1.19	3.81	22.709	0.344	0.094	0.047	0.15	0.894	
			3062R	●	8.74	3.18	1.59	3.81	22.709	0.344	0.125	0.0625	0.15	0.894	
			3078R	●	8.74	3.96	1.98	3.81	22.709	0.344	0.156	0.078	0.15	0.894	
			3094R	●	8.74	4.78	2.39	3.81	22.709	0.344	0.188	0.094	0.15	0.894	
			4125R		11.51	6.35	3.18	6.35	28.663	0.453	0.250	0.125	0.25	1.128	
			Round C/B Ground		KNRP	2031R		5.56	1.57	0.79	2.79	13.030	0.219	0.062	
2047R		5.56				2.39	1.19	2.79	13.030	0.219	0.094	0.047	0.11	0.513	
3031R	●	8.74				1.57	0.79	2.39	22.709	0.344	0.062	0.031	0.094	0.894	
3047R	●	8.74				2.39	1.19	3.81	22.709	0.344	0.094	0.047	0.15	0.894	
3062R	●	8.74				3.18	1.59	3.81	22.709	0.344	0.125	0.0625	0.15	0.894	
3078R	●	8.74				3.96	1.98	3.81	22.709	0.344	0.156	0.078	0.15	0.894	
3094R	●	8.74				4.78	2.39	3.81	22.709	0.344	0.188	0.094	0.15	0.894	
4125R		11.51				6.35	3.18	6.35	28.663	0.453	0.250	0.125	0.25	1.128	

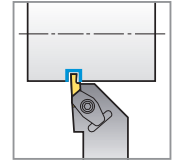
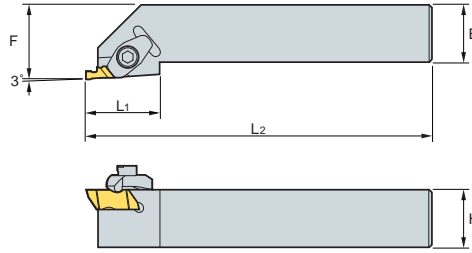
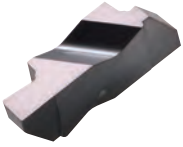
● : Stock item





# KNSR

For grooving, profil machining



KNG KNGP KNT  
KNR KNRP KNB

Designation	mm					inch					Insert	Clamp	Screw	Wrench	
	H	B	F	L1	L2	H	B	F	L1	L2					
<b>KNSR</b>	<b>1010E2</b>	10	10	14	19	70	0.394	0.394	0.551	0.748	2.756	KNG2□ KNGP2□ KNR2□ KNB2R KNT2R	CM74	MHB3010	HW25L
	<b>1212F2</b>	12	12	16	19	80	0.472	0.472	0.630	0.748	3.150				
	<b>1616H2</b>	16	16	20	19	100	0.630	0.630	0.787	0.748	3.937				
	<b>2020K2</b>	20	20	25	19	125	0.787	0.787	0.984	0.748	4.921				
	<b>2525M2</b>	25	25	32	19	150	0.984	0.984	1.260	0.748	5.906				
	<b>2020K3</b>	20	20	25	32	125	0.787	0.787	0.984	1.260	4.921				
	<b>2525M3</b>	25	25	32	32	150	0.984	0.984	1.260	1.260	5.906				
	<b>3225P3</b>	32	32	32	32	170	1.260	1.260	1.260	1.260	6.693				
	<b>3232P3</b>	32	32	40	32	170	1.260	1.260	1.575	1.260	6.693				
	<b>2525M4</b>	25	25	32	35	150	0.984	0.984	1.260	1.378	5.906				
<b>3225P4</b>	32	32	32	35	170	1.260	1.260	1.260	1.378	6.693	KNG4□ KNGP4□ KNR4□ KNB4R KNT4R	CM72LP	MHA0512	HW40L	
<b>3232P4</b>	32	32	40	35	170	1.260	1.260	1.575	1.378	6.693					



For deep hole grooving/parting off


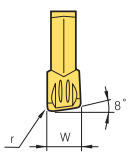
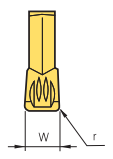
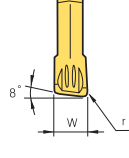
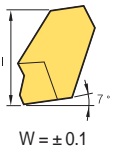
## Saw Man

### Features of parting insert

- Possible to machine a wide range of workpieces such as steel, cast iron, stainless steel, etc.
- Extended tool life due to low resistance rake angle
- Minimized burr due to minimal Nose R
- Various lead angle available
- Narrow chip curl due to dots on rake surface of insert

Workpiece	Cutting Speed (vc = m/min)								Feed (fn = mm/rev)				
	CVD				PVD			Uncoated	Cutting width (mm)				
	NC3120	NC3030	NCM325	NC5330	PC8110	PC5300	PC6510	ST30A	2	3	4	5	6
SM□□C	80~180			80~180		80~180			0.02~0.15	0.03~0.20	0.08~0.30	0.10~0.4	0.12~0.50
SCM	70~150	70~150	70~150	70~150		70~150			0.02~0.15	0.03~0.20	0.08~0.30	0.10~0.4	0.12~0.50
GC/GCD				50~100			50~100	50~100	0.05~0.12	0.10~0.25	0.10~0.30	0.10~0.35	0.10~0.40
STS			50~120	50~120	50~120	60~140			0.02~0.10	0.03~0.15	0.08~0.25	0.10~0.35	0.12~0.40
Non-ferrous metal (Al, Copper)								200~450	0.05~0.10	0.05~0.20	0.05~0.25	0.05~0.30	0.05~0.35

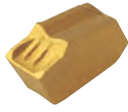
### Insert

Application	Picture	Designation	Coated										Uncoated	Dimensions (mm)			Configuration
			NC3120	NC3225	NC3030	NCM325	NC5330	PC3035	PC8105	PC8110	PC5300	PC9030	ST30A	W	l	r	
Parting tools		SP 160												1.6	7.8	0.16	<div style="display: flex; justify-content: space-around;"> <div style="text-align: center;"> <p>R type</p>  </div> <div style="text-align: center;"> <p>Standard</p>  </div> </div> <div style="margin-top: 20px;"> <p>L type</p>  </div> <div style="margin-top: 20px;">  <p>W = ± 0.1</p> </div>
		180												1.8	9.3	0.16	
		200		●	●	●	●			●	●	●		2.2	9.3	0.2	
		200R			●							●		2.2	9.3	0.2	
		200L										●		2.2	9.3	0.2	
		300		●	●	●	●	●		●	●	●	●	3.1	11.3	0.2	
		300R			●	●	●			●				3.1	11.3	0.2	
		300L				●								3.1	11.3	0.2	
		400		●	●	●	●	●		●	●	●		4.1	11.3	0.25	
		400R				●				●				4.1	11.3	0.25	
		400L				●								4.1	11.3	0.25	
		500				●	●	●		●	●			5.1	11.4	0.3	
		500R												5.1	11.4	0.3	
		500L												5.1	11.4	0.3	
		600				●		●			●			6.4	11.4	0.35	
		600R												6.4	11.4	0.35	
		600L												6.4	11.4	0.35	
800												8.0	14.06	0.4			
900												9.6	14.06	0.45			

● : Stock item



# SPB/SPB-S (Blades)



SP

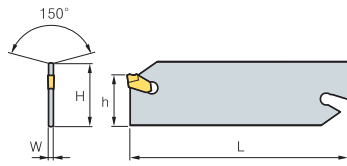


Fig. 1

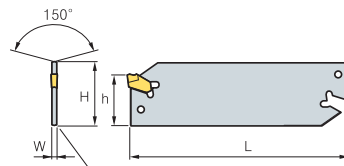
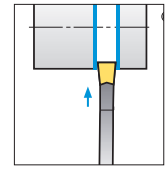


Fig. 2



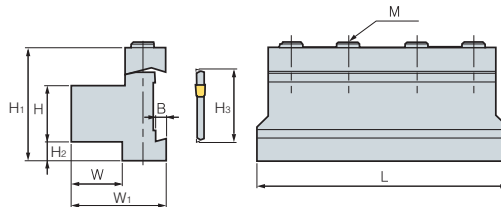
Designation		H	W	L	h	Inserts	Wrench	Fig.
SPB	226	26	1.6	110	21	SP200, 200R/L	SW50L	1
	232	32	1.6	150	25	SP200, 200R/L		
	326	26	2.4	110	21	SP300, 300R/L		
	332	32	2.4	150	25	SP300, 300R/L		
	426	26	3.2	110	21	SP400, 400R/L		
	432	32	3.2	150	25	SP400, 400R/L		
	526	26	4.0	110	21	SP500, 500R/L		
	532	32	4.0	150	25	SP500, 500R/L		
	626	26	5.2	110	21	SP600, 600R/L		
632	32	5.2	150	25	SP600, 600R/L	SW15S (Separately ordered)	2	
SPB-S	226-S	26	1.6	110	21			SP200, 200R/L
	232-S	32	1.6	150	25			SP200, 200R/L
	326-S	26	2.4	110	21			SP300, 300R/L
	332-S	32	2.4	150	25			SP300, 300R/L
	426-S	26	3.2	110	21			SP400, 400R/L
	432-S	32	3.2	150	25			SP400, 400R/L
	526-S	26	4.0	110	21			SP500, 500R/L
	532-S	32	4.0	150	25			SP500, 500R/L
	626-S	26	5.2	110	21			SP600, 600R/L
	632-S	32	5.2	150	25			SP600, 600R/L
	832-S	32	6.8	150	25			SP800
	932-S	32	8	150	25			SP900
	8526-S	52.6	6.8	150	45			SP800
	9526-S	52.6	8	150	45	SP900		

↻ Applicable inserts C60

# SMBB (Block)



SPB□□□(-S)  
KGTB□□□32

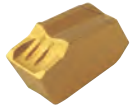


Designation		H	W	H3	L	H1	H2	W1	B	M	Blades	Wrench
SMBB	1626	16	12	26	86	43	13	30	5.3	3-M6	SPB□□26(-S) SPB□□32(-S) KGTB□□□32 SPB□□26(-S) SPB□□32(-S) KGTB□□□32	HW50L
	2026	20	19	26	86	43	9	38	5.3	3-M6		
	2032	20	19	32	100	50	13	38	5.3	4-M6		
	2526	25	23	26	86	43	4	42	5.3	4-M6		
	2532	25	23	32	110	50	8	42	5.3	4-M6		
	3232	32	30	32	110	54	5	48	5.3	4-M6		
40526	40	41	52.6	130	81.73	22	66	8	4-M8	SPB□526(-S)	HW60L	

↻ Applicable inserts C60



# SPH/SPH-S (Holder)



SP

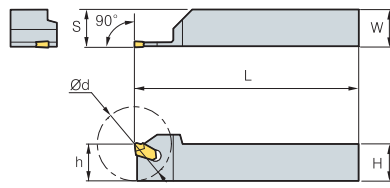


Fig. 1

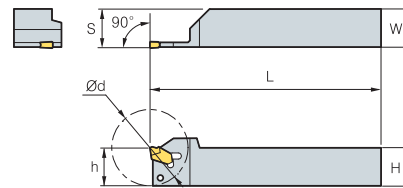
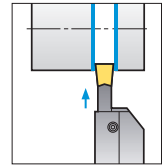



Fig. 2



• R type insert

(mm)

Designation		H = (h)	W	L	Ød	S	Inserts	Wrench	Fig.
SPH	316R/L	16	16	100	32	16.3	SP300, 300R/L	SW50L -	1
	320R/L	20	20	120	40	20.3	SP300, 300R/L		
	325R/L	25	25	150	50	25.3			
	420R/L	20	20	120	50	20.4	SP400, 400R/L		
	425R/L	25	25	150	60	25.4	SP500, 500R/L		
	520R/L	20	20	120	60	20.5	SP300, 300R/L		
	525R/L	25	25	150	70	25.5	SP500, 500R/L		
SPH-S	316R/L-S	16	16	100	32	16.3	SP300, 300R/L	- SW15S (Separately ordered)	2
	320R/L-S	20	20	120	40	20.3	SP300, 300R/L		
	325R/L-S	25	25	150	50	25.3	SP300, 300R/L		
	420R/L-S	20	20	120	50	20.4	SP400, 400R/L		
	425R/L-S	25	25	150	60	25.4	SP400, 400R/L		
	520R/L-S	20	20	120	60	20.5	SP500, 500R/L		
	525R/L-S	25	25	150	70	25.5	SP500, 500R/L		

 Applicable inserts C60

A solution for parting and deep grooving

# Saw Man-X new

- Stable machining in deep grooving applying clamping system with strong three-way V-Rail
- Improved clamping precision and convenient replacing of inserts with using the exclusive wrench

## Code system

### • Insert

KSP	300	-	020	-	N
<b>KORLOY Saw Man-X Parting</b>	<b>Cutting edge width</b> 200 : 2 mm 300 : 3 mm 400 : 4 mm		<b>Nose r</b> 020 : 0.2 mm 030 : 0.3 mm		<b>Chip breaker</b> N: Negaland

### • Shank

KSPH	3	-	25	-	R
<b>KORLOY Saw Man-X Parting Holder</b>	<b>Cutting edge width</b> 2 : 2 mm 3 : 3 mm 4 : 4 mm		<b>Shank size</b> 16 : 1616 20 : 2020 25 : 2525		<b>Hand</b> R: Right L: Left

### • Blade

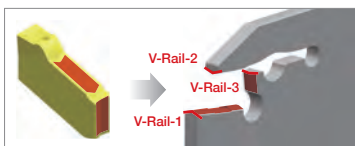
KSPB	30	-	26
<b>KORLOY Saw Man-X Parting Blade</b>	<b>Cutting edge width</b> 20 : 2 mm 30 : 3 mm 40 : 4 mm		<b>Blade height</b> 26 : 26 mm 32 : 32 mm

## Features

- Three-way V-Rail – More stable clamping system
- New treatment on cutting edge – Better quality of machining and longer tool life
- Superior chip breaker – Better chip control
- Exclusive wrench – More convenient clamping system

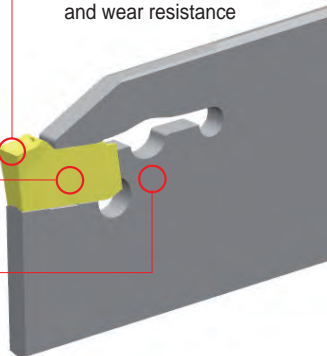
### Three-way V-RAIL

- An insert is tightly clamped in the tip seat.
- Minimized vibration during the machining increases stability.
- Stable high speed, high feed and high depth of cut machining is available.



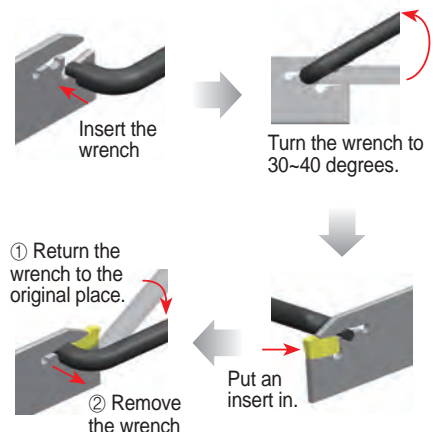
### Special cutting edge

- Even cutting edge improves machinability
- Higher quality of machining and wear resistance



### Exclusive wrench

- The exclusive wrench having the principle of CAM for the Saw Man-X
- More convenient clamping system



## Features of chip breaker

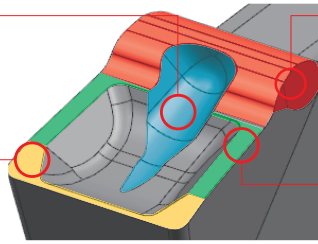
- The design of chip breaker and its bump in the back area realize better chip evacuation
- The chip breaker with negaland is used universally.

### Coolant path and guide for chip evacuation

- Inner coolant holder is available
- Guide for chip evacuation

### Negaland

- Applying for various workpieces
- Stable in interrupted cutting and machining with high depth of cut



### The second chip breaker in the back area

- Better chip control in machining of workpiece with a bigger diameter
- Preventing damage to holder from chip evacuation

### Strong land on flank

- Smaller diameter of chip curl makes better chip control
- Higher rigidity of insert

## Recommended cutting conditions

Workpiece					Grade	Cutting conditions	
ISO	Workpiece	KS	AISI	ISO (DIN)		vc (m/min)	fn (mm/rev)
P	Carbon steel	SM45C	1045	C45	PC5300	80-200	0.08-0.28
					PC3035	80-220	0.08-0.28
	Alloy steel	SCM440	4140	42CrMo4 (42CrMo4)	PC5300	80-160	0.08-0.25
					PC3035	80-180	0.08-0.25
M	Stainless steel	STS304	304	X5CrNi18-9 (X2CrNi19-11)	PC5300	80-190	0.06-0.20
		STS316	316	X5CrNiMo17-12-2	PC5300	80-190	0.06-0.20
K	Gray cast iron	GC250	No35B	250 (GG25)	PC8110	100-220	0.10-0.28
					PC5300	100-200	0.10-0.28
	Nodular graphite cast iron	GCD500	80-55-06	450-10	PC8110	80-200	0.10-0.25
					PC5300	80-180	0.10-0.25
S	HRSA	Inconel 718	7718	15156-3	PC8110	35-65	0.05-0.15
					PC5300	25-55	0.05-0.15


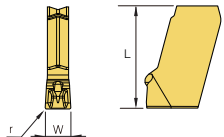
## Cutting edge width and T-MAX by items

⊙: First recommendation ○: Second recommendation

Shape	Cutting edge width (mm)	T-MAX (mm)					No. of corner	Machining				Features	
		2	4	6	8	130		External diameter	Internal diameter	Cross section	Parting		
Saw Man-X <sup>new</sup>	2.0	6.0					1	○			⊙	• Self clamping • Deep grooving	
MGT, KGT	1.5	8.0					2	⊙	○	○	○	• Various machining • Wide range of machining	
TB	1.25	6.0					3	⊙			○	• Precise ground class • Optimally automatic machining	
Auto tools	Blade type	0.7	2.0					2	⊙			○	• For swiss-type lathe (blade) • Small deliberate component machining
	Multi-functional type	1.0	4.0					2	⊙			○	• For swiss-type lathe (multifunctional) • Small deliberate component machining
K Notch	0.75	6.3					2	⊙				• Strong clamping system • Highly qualified cutting edge	

## Insert

(mm)

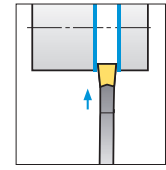
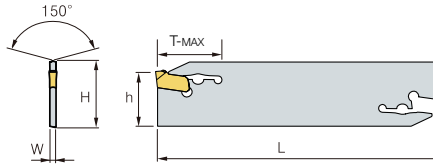
Application	Picture	Designation	Coated			W	r	L	Configuration
			PC3035	PC5300	PC8110				
Parting		KSP 200-020-N	●	●	●	2.0	0.20	11.0	
		300-020-N	●	●	●	3.0	0.20	12.0	
		400-025-N	●	●	●	4.0	0.25	12.5	
		500-025-N	●	●	●	5.0	0.25	13.5	
		600-035-N	●	●	●	6.0	0.35	14.5	

●: Stock item

# KSPB (Blades)




KSP



(mm)

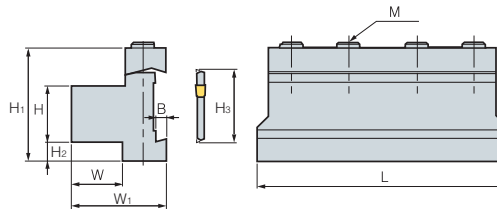
Designation	Cutting edge width	H	W	L	h	T-MAX	Wrench	
<b>KSPB</b>	<b>2026</b>	2	26	1.6	110	21	25	CW08
	<b>2032</b>	2	32	1.6	150	25	26	
	<b>3026</b>	3	26	2.4	110	21	36	
	<b>3032</b>	3	32	2.4	150	25	60	
	<b>4026</b>	4	26	3.2	110	21	36	
	<b>4032</b>	4	32	3.2	150	25	60	
	<b>5026</b>	5	26	4.0	110	21	40	CW10
	<b>5032</b>	5	32	4.0	150	25	60	
	<b>6026</b>	6	26	5.2	110	21	60	
	<b>6032</b>	6	32	5.2	150	25	60	

 Applicable inserts **C64**

# SMBB (Block)




KSPB□□□□  
 SPB□□□(-S)  
 KGTB□□□□



(mm)

Designation	H	W	H3	L	H1	H2	W1	B	M	Wrench	
<b>SMBB</b>	<b>1626</b>	16	12	26	86	43	13	30	5.3	3-M6	HW50L
	<b>2026</b>	20	19	26	86	43	9	38	5.3	3-M6	
	<b>2032</b>	20	19	32	100	50	13	38	5.3	4-M6	
	<b>2526</b>	25	23	26	86	43	4	42	5.3	4-M6	
	<b>2532</b>	25	23	32	110	50	8	42	5.3	4-M6	
	<b>3232</b>	32	30	32	110	54	5	48	5.3	4-M6	

 Applicable inserts **C64**

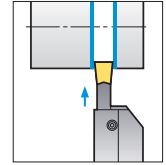
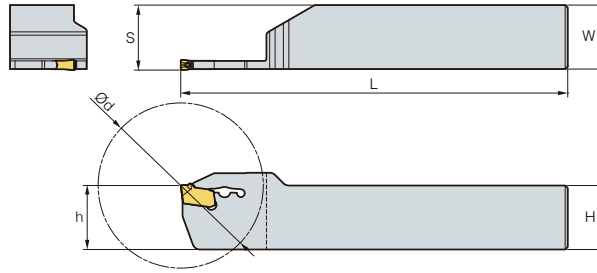





# KSPH (Shank)




KSP



(mm)

Designation	Cutting edge width	H	W	L	Ød	S	Wrench 
KSPH	216R/L	2	16	16	100	46	CW08
	220R/L	2	20	20	120	48	
	225R/L	2	25	25	150	50	
	316R/L	3	16	16	100	52	
	320R/L	3	20	20	120	54	
	325R/L	3	25	25	150	56	
	420R/L	4	20	20	120	64	
	425R/L	4	25	25	150	66	
	520R/L	5	20	20	120	74	
525R/L	5	25	25	150	76		
625R/L	6	25	25	150	76		

 Applicable inserts C64

Six kinds of inserts can be used in one holder for various operations

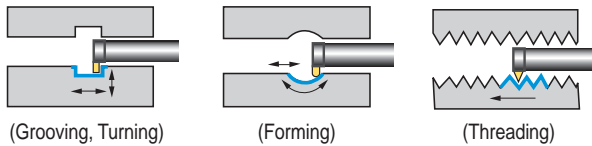
# Fine Tools

- Strong clamping system and specially designed insert are suitable for small diameter machining
- Six kinds of inserts can be clamped in one holder for various operations
- Guaranteed long tool life due to good toughness substrate with new TiAlN
- High accuracy ground insert ensures high precision machining

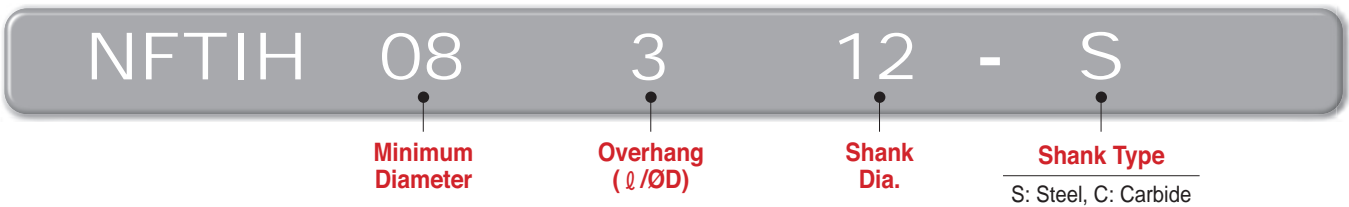


➤ **Application range** • Internal grooving, Profiling, Threading and Boring at  $\varnothing 8$  mm- $\varnothing 16$  mm

➤ **Features**



➤ **Code system**

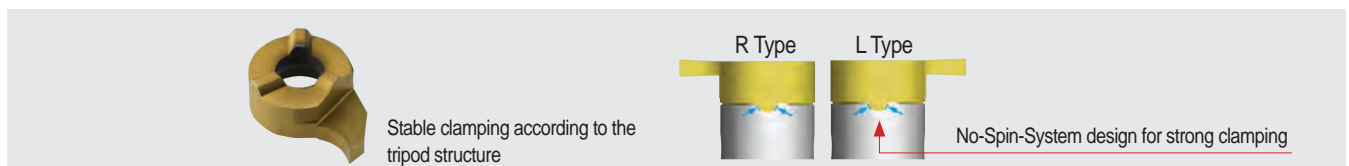
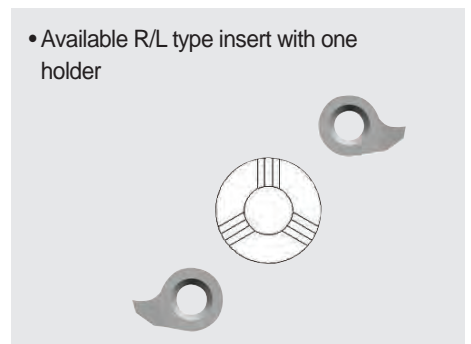
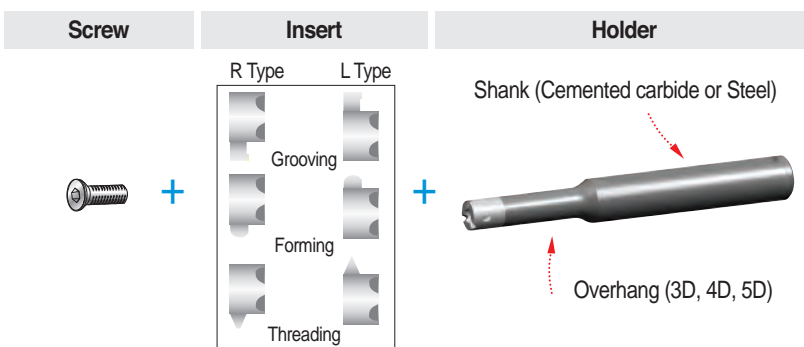


➤ **Recommended cutting condition**



Workpiece	Grade (PC130)	Cutting Condition				
		Min. machining Dia. ( $\varnothing$ Dmin)				
		$\varnothing 8$	$\varnothing 11$	$\varnothing 14$	$\varnothing 16$	
Carbon steel	◎	vc (m/min)	70~120	70~120	70~120	70~120
		fn (mm/rev)	0.01~0.04	0.01~0.05	0.02~0.05	0.02~0.06
Alloy steel	◎	vc (m/min)	70~120	70~120	70~120	70~120
		fn (mm/rev)	0.01~0.02	0.01~0.04	0.02~0.04	0.02~0.05
Cast iron	○	vc (m/min)	60~100	60~100	60~100	60~100
		fn (mm/rev)	0.01~0.05	0.01~0.05	0.02~0.05	0.02~0.05
Non-ferrous alloy	○	vc (m/min)	100~180	100~180	100~180	100~180
		fn (mm/rev)	0.02~0.06	0.02~0.06	0.02~0.06	0.02~0.06

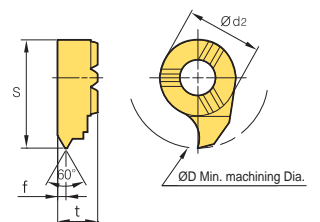
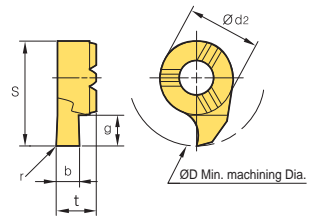
**Note** - In case of chattering, reduce the cutting speed and feed  
 - To find the optimal cutting conditions, advise to gradually increase from the lowest cutting condition of the above recommendation  
 - In case of the unilateral grooving depth over 1 mm, work to the step feed rate

➤ **Clamping system**




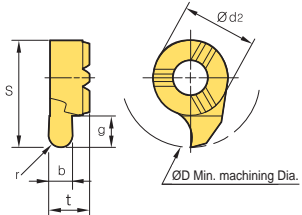
## Insert

Application	Picture	Designation	Coated		Dimensions (mm)								Configuration	
			PC5300		ØD	b	r	S	g	Ød <sub>2</sub>	t	Pitch		f
			R	L										
Internal grooving		NFTG 08075R/L	●		8	0.75	-	7.75	1.3	5.9	3.85	-	-	
		08085R/L	●		8	0.85	-	7.75	1.3	5.9	3.85	-	-	
		08095R/L	●		8	0.95	-	7.75	1.3	5.9	3.85	-	-	
		08121R/L	●		8	1.21	-	7.75	1.3	5.9	3.85	-	-	
		08141R/L	●		8	1.41	-	7.75	1.3	5.9	3.85	-	-	
		08152R/L	●		8	1.52	-	7.75	1.3	5.9	3.85	-	-	
		08171R/L	●		8	1.71	-	7.75	1.3	5.9	3.85	-	-	
		08202R/L	●		8	2.02	-	7.75	1.3	5.9	3.85	-	-	
		11075R/L	●		11	0.75	-	10.7	1.8	8.0	4.9	-	-	
		11085R/L	●		11	0.85	-	10.7	1.8	8.0	4.9	-	-	
		11095R/L	●		11	0.95	-	10.7	1.8	8.0	4.9	-	-	
		11121R/L	●		11	1.21	-	10.7	2.6	8.0	4.9	-	-	
		11141R/L	●		11	1.41	-	10.7	2.6	8.0	4.9	-	-	
		11152 R/L	●		11	1.52	-	10.7	2.6	8.0	4.9	-	-	
		11171R/L	●		11	1.71	-	10.7	2.6	8.0	4.9	-	-	
		11202R/L	●		11	2.02	-	10.7	2.6	8.0	4.9	-	-	
		11202R/L-02	●		11	2.02	0.2	10.7	2.6	8.0	4.9	-	-	
		11252R/L	●		11	2.52	-	10.7	2.6	8.0	4.9	-	-	
		11302R/L	●		11	3.02	-	10.7	2.6	8.0	4.9	-	-	
		14075R/L	●		14	0.75	-	13.5	1.8	9.0	5.85	-	-	
		14085R/L	●		14	0.85	-	13.5	1.8	9.0	5.85	-	-	
		14095R/L	●		14	0.95	-	13.5	1.8	9.0	5.85	-	-	
		14121R/L	●		14	1.21	-	13.5	4.3	9.0	5.85	-	-	
		14141R/L	●		14	1.41	-	13.5	4.3	9.0	5.85	-	-	
		14152R/L	●		14	1.52	-	13.5	4.3	9.0	5.85	-	-	
		14171R/L	●		14	1.71	-	13.5	4.3	9.0	5.85	-	-	
		14202R/L	●		14	2.02	-	13.5	4.3	9.0	5.85	-	-	
		14252R/L	●		14	2.52	-	13.5	4.3	9.0	5.85	-	-	
		14302R/L	●		14	3.02	-	13.5	4.3	9.0	5.85	-	-	
		16075R/L	●		16	0.75	-	15.7	1.8	11.0	5.8	-	-	
		16085R/L	●		16	0.85	-	15.7	1.8	11.0	5.8	-	-	
		16095R/L	●		16	0.95	-	15.7	1.8	11.0	5.8	-	-	
		16121R/L	●		16	1.21	-	15.7	4.6	11.0	5.8	-	-	
		16141R/L	●		16	1.41	-	15.7	4.6	11.0	5.8	-	-	
		16171R/L	●		16	1.71	-	15.7	4.6	11.0	5.8	-	-	
		16202R/L	●		16	2.02	-	15.7	4.6	11.0	5.8	-	-	
16252R/L	●		16	2.52	-	15.7	4.6	11.0	5.8	-	-			
16302R/L	●		16	3.02	-	15.7	4.6	11.0	5.8	-	-			
16352R/L	●		16	3.52	-	15.7	4.6	11.0	5.8	-	-			
16402R/L	●		16	4.02	-	15.7	4.6	11.0	5.8	-	-			
Threading		NFTT 0805MR/L	●		8	-	-	7.75	-	6.0	3.85	0.5	1.0	
		0810MR/L	●		8	-	-	7.75	-	6.0	3.85	1.0	1.0	
		0815MR/L	●		8	-	-	7.75	-	6.0	3.85	1.5	1.2	
		1110MR/L	●		11	-	-	10.7	-	8.0	4.9	1.0	1.2	
		1115MR/L	●		11	-	-	10.7	-	8.0	4.9	1.5	1.2	
		1120MR/L	●		11	-	-	10.7	-	8.0	4.9	2.0	1.2	
		1125MR/L	●		11	-	-	10.7	-	8.0	4.9	2.5	1.2	
		1410MR/L	●		14	-	-	13.5	-	9.0	5.85	1.0	1.2	
		1415MR/L	●		14	-	-	13.5	-	9.0	5.85	1.5	1.2	
		1420MR/L	●		14	-	-	13.5	-	9.0	5.85	2.0	1.2	
		1425MR/L	●		14	-	-	13.5	-	9.0	5.85	2.5	1.2	
		1610MR/L	●		16	-	-	15.7	-	11.0	5.8	1.0	1.2	
		1615MR/L	●		16	-	-	15.7	-	11.0	5.8	1.5	1.2	
		1620MR/L	●		16	-	-	15.7	-	11.0	5.8	2.0	1.2	
		1625MR/L	●		16	-	-	15.7	-	11.0	5.8	2.5	1.2	
		1630MR/L	●		16	-	-	15.7	-	11.0	5.8	3.0	1.5	
1635MR/L	●		16	-	-	15.7	-	11.0	5.8	3.5	1.6			
1640MR/L	●		16	-	-	15.7	-	11.0	5.8	4.0	1.8			



● : Stock item

**Insert**

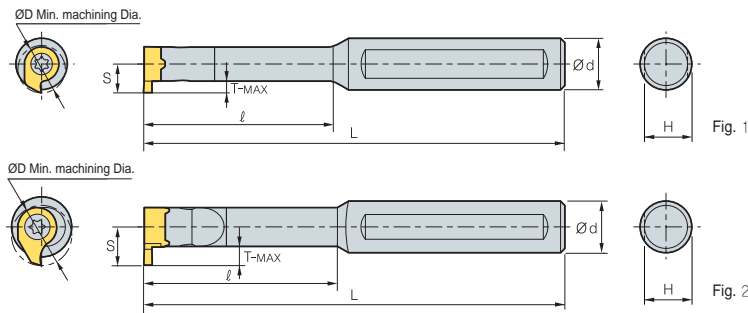
Application	Picture	Designation	Coated		Dimensions (mm)							Configuration
			PC5300		D	b	r	S	g	Ød <sub>2</sub>	t	
			R	L								
Profiling		NFTF 08082R/L	●		8	0.82	0.41	7.75	1.3	5.9	3.85	
		08122R/L	●		8	1.22	0.61	7.75	1.3	5.9	3.85	
		08182R/L	●		8	1.82	0.91	7.75	1.3	5.9	3.85	
		11082R/L	●		11	0.82	0.41	10.7	2.6	8	4.9	
		11122R/L	●		11	1.22	0.61	10.7	2.6	8	4.9	
		11182R/L	●		11	1.82	0.91	10.7	2.6	8	4.9	
		11202R/L	●		11	2.02	1.01	10.7	2.6	8	4.9	
		11302R/L	●		11	3.02	1.51	10.7	2.6	8	4.9	
		14122R/L	●		14	1.22	0.61	13.5	4.3	9	5.85	
		14182R/L	●		14	1.82	0.91	13.5	4.3	9	5.85	
		14202R/L	●		14	2.02	1.01	13.5	4.3	9	5.85	
		14222R/L	●		14	2.22	1.11	13.5	4.3	9	5.85	
		14302R/L	●		14	3.02	1.51	13.5	4.3	9	5.85	
		16182R/L	●		16	1.82	0.91	15.7	4.6	11	5.8	
		16222R/L	●		16	2.22	1.11	15.7	4.6	11	5.8	
		16302R/L	●		16	3.02	1.51	15.7	4.6	11	5.8	
		16402R/L	●		16	4.02	2.01	15.7	4.6	11	5.8	

● : Stock item

**NFTIH**



NFTF  
NFTT  
NFTG



• For NFTIH4--.  
• R type insert

Designation	ØD	Ød	L	ℓ	T-MAX	H	S	Inserts		Screw	Wrench	Fig
								NFTG: Grooving	NFTT: Threading			
NFTIH 08206C	8	6	65	-	1.0	4	4.8			PTKA02508	TW08P	1
08212C	8	12	70	16	1.0	10	4.8					
08312C	8	12	80	24	1.0	10	4.8					
08312S	8	12	80	24	1.0	10	4.8					
08412C	8	12	90	32	1.0	10	4.8			PTKA03510	TW15P	2
08512C	8	12	100	40	1.0	10	4.8					
11208C	11	8	80	-	2.3	7	6.7					
11212C	11	12	75	22	2.3	11	6.7					
11312C	11	12	95	33	2.3	11	6.7			PTKA0412	TW15P	2
11312S	11	12	95	33	2.3	11	6.7					
11412C	11	12	110	44	2.3	11	6.7					
11512C	11	12	120	55	2.3	11	6.7					
14012C	14	12	75	20	4.0	11	9.0			PTKA0512	TW20P	2
14016C	14	16	75	20	4.0	15	9.0					
14112C	14	12	100	34	4.0	11	9.0					
14116C	14	16	100	34	4.0	15	9.0					
14212C	14	12	110	45	4.0	11	9.0			PTKA0512	TW20P	2
14216C	14	16	110	45	4.0	15	9.0					
14312C	14	12	130	64	4.0	11	9.0					
14316C	14	16	130	64	4.0	15	9.0					
16312C	16	12	130	48	4.3	11	10.2			PTKA0512	TW20P	2
16312S	16	12	130	48	4.3	11	10.2					
16412C	16	12	130	64	4.3	11	10.2					
16512C	16	12	150	80	4.3	11	10.2					
16316C	16	16	130	48	4.3	15	10.2			PTKA0512	TW20P	2
16416C	16	16	130	64	4.3	15	10.2					
16516C	16	16	150	80	4.3	15	10.2					

Applicable inserts C68 ~ C69

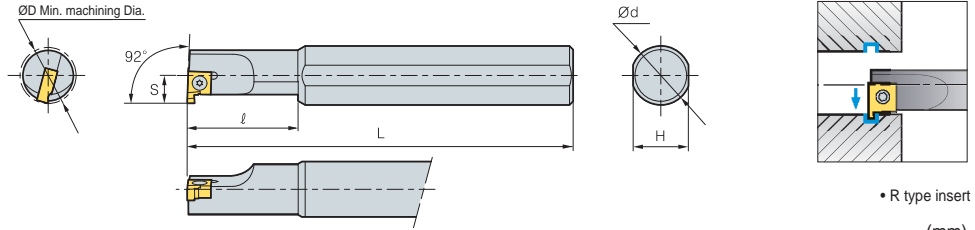


# C Grooving Tools

## IGH For internal grooving



IG



• R type insert

(mm)

Designation	ØD	Ød	H	L	l	S	Inserts	Screw	Wrench
IGH	214R	14	16	15	150	25	IG125-280	FTKA02565	TW07P
	216R	16	16	15	150	30			
	220R	20	20	18	200	40			

➔ Applicable inserts C70

### ➔ Insert

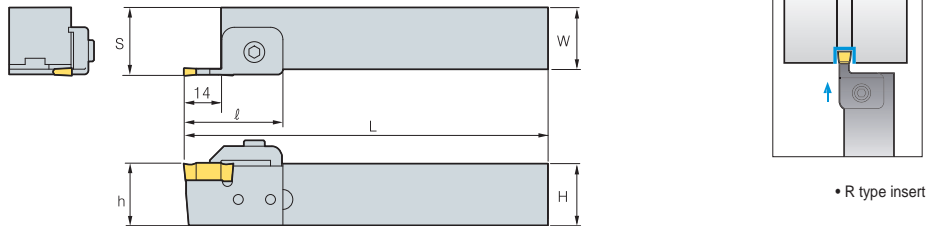
Application	Picture	Designation	Coated			Uncoated			Dimensions (mm)					Configuration	
			NC3215	NC3120	NC3225	H01	G10	ST30A	b	g	t	d	d <sub>1</sub>		
Internal grooving		IG 125R						●	1.25	1.5	3.18	6.35	2.8		
		145R						●	1.45	1.5	3.18	6.35	2.8		
		175R							●	1.75	1.5	3.18	6.35		2.8
		200R							●	2.0	2.3	3.18	6.35		2.8
		230R							●	2.3	2.3	3.18	6.35		2.8
		280R							●	2.8	2.3	3.18	6.35		2.8

● : Stock item

## DBH For deep and wide grooving



DB DC



• R type insert

(mm)

Designation	H = (h)	W	L	l	S		Inserts		Clamp	Clamp Screw	Screw	Locator	Wrench		
					*	**	*	**							
DBH	320R	20	20	150	40	22.3	22.8	DB300	DB400	CGH5R1	MHA0512	MHB0410	LD34	HW30L	HW40L
	325R	25	25	150	40	27.3	27.8	DC300	DC400						
	520R	20	20	150	40	23.8	24.3	DB500	DB600						
	525R	25	25	150	40	28.8	29.3	DC500	DC600						
	720R	20	20	150	40	25.8	26.3	DB700	DB800						
	725R	25	25	150	40	30.8	31.3								

➔ Applicable inserts C70

### ➔ Insert

Application	Picture	Designation	Cermet	Coated			Uncoated		Dimensions (mm)				Configuration	
			CN2000	NC3215	NC3120	NC3225	H01	G10	b	l	t	r		
Grooving		DB 300							3.0	20	7.5	0.2		
		400							4.0	20	7.5	0.2		
		500								5.0	20	7.5		0.2
		600								6.0	20	7.5		0.2
		700								7.0	20	7.5		0.2
		800								8.0	20	7.5		0.2
		DC 300								3.0	20	7.5	0.2	
		400								4.0	20	7.5	0.25	
		500								5.0	20	7.5	0.3	

● : Stock item



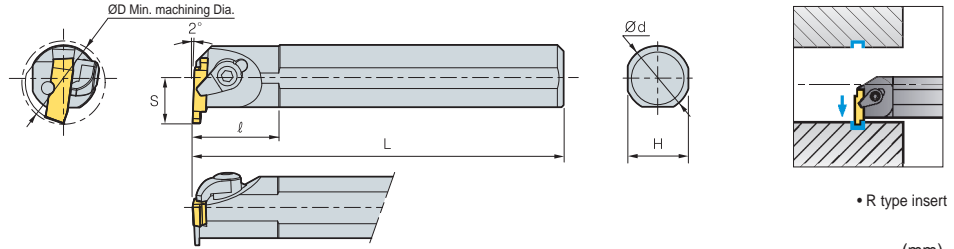
C

Multi functional Tools

## GFIP For Internal grooving



BF GW



Designation	ØD	Ød	H	L	l	S	Inserts	Clamp	C-ring	Screw	Pin	Wrench
GFIP	316R/L	20	16	15	150	17	GW110~300R/L,BF3	CH5R2	CR04	CHX0513	PN0310	HW25L
	320R/L	26	20	18	150	22						
	325R/L	32	25	23	200	22						
	340R/L	50	40	37	300	32						
GFIP	525R/L	32	25	23	200	17	GW315~500R/L,BF5	CH6R2	CR05	CHX0616	PN0310	HW30L
	540R/L	50	40	37	300	32						
GFIP	840R/L	50	40	37	300	32	GW600~800R/L,BF8	CS8R1	-	DHA0820	PN0314	HW40L

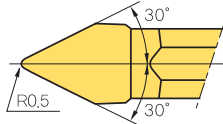
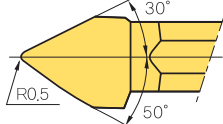
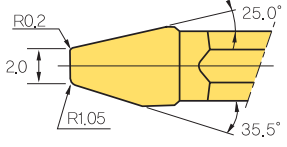
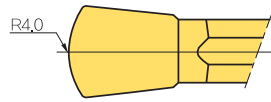
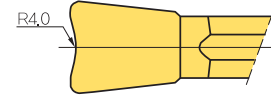
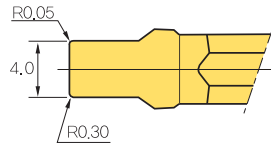
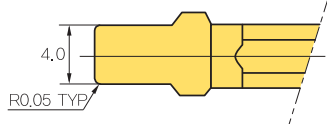
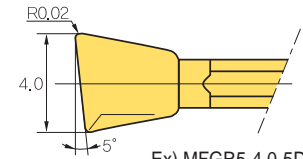
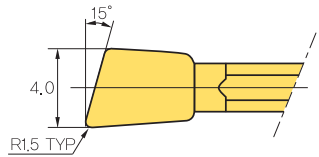
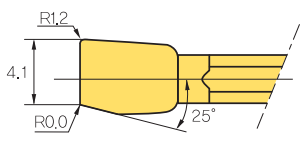
➤ Applicable inserts **C71** • Use right-hand insert for left-hand holder

## ➤ Insert

Application	Picture	Designation	Uncoated		Dimensions (mm)						Configuration	
			ST30A		b	g	W	l	t	r		
Blank		BF	-3	●			3.1	16.4	5.26	-		
			-5				5.1	22.4	6.26	-		
			-8					8.1	27.4	7.26		-
Grooving		GW		R	L							
			110R/L	●	●	1.1	2.1	3.1	16	5.0	0.2	
			130R/L	●	●	1.3	2.3	3.1	16	5.0	0.2	
			160R/L	●	●	1.6	2.6	3.1	16	5.0	0.2	
			185R/L	●	●	1.85	2.9	3.1	16	5.0	0.2	
			215R/L	●	●	2.15	3.2	3.1	16	5.0	0.2	
			265R/L	●	●	2.65	3.7	3.1	16	5.0	0.2	
			300R/L	●	●	3.0	4.0	3.1	16	5.0	0.2	
			315R/L	●	●	3.15	4.2	5.1	22	6.0	0.3	
			415R/L		●	4.15	5.2	5.1	22	6.0	0.3	
			500R/L			5.0	6.0	5.1	22	6.0	0.3	
			600R/L			6.0	7.0	8.1	27	7.0	0.3	
			800R/L			8.0	9.0	8.1	27	7.0	0.3	

● : Stock item

# C Special Order Form for MGT

Code system	Configuration
<p><b>M F G N 4 - 0.5R - 30D</b></p> <p>① ② ③ ④ ⑤ ⑥ ⑦</p> <p>① Multi                      ② Forming                      ③ Grinding            ④ Feed Direction          ⑤ Clamp part: 4 mm          ⑥ Nose Radius: 0.5            ⑦ Degree: 30°</p>	 <p>Ex) MFGN4-0.5R-30D</p>
<p><b>MFGN4 - 0.5R - L 50 D - R 30D</b></p> <p>① ② ③ ④ ⑤ ⑥</p> <p>① Refer to No. 1              ② Nose Radius: 0.5              ③ Left            ④ Degree: 50°                  ⑤ Right                              ⑥ Degree &gt; 30°</p>	 <p>Ex) MFGN4-0.5R-L50D-R30D</p>
<p><b>MFGN4 - 2.0 - R 020 250 - L 105 335</b></p> <p>① ② ③ ④ ⑤ ⑥ ⑦ ⑧</p> <p>① Refer to No. 1              ② Width of cutting edge: 2.0mm      ③ Right            ④ Nose Radius: 0.20          ⑤ Degree: 25.0°                  ⑥ Left            ⑦ Nose Radius: 1.05          ⑧ Degree: 35.5°</p>	 <p>Ex) MFGN4-2.0-R020250-L105335</p>
<p><b>MFGN5 - 4.0R F</b></p> <p>① ② ③</p> <p>① Refer to No. 1              ② Radius: 4.0                      ③ Front(Concave)</p>	 <p>Ex) MFGN5-4.0RF</p>
<p><b>MFGN5 - 4.0R B</b></p> <p>① ② ③</p> <p>① Refer to No. 1              ② Radius: 4.0                      ③ Back(Concave)</p>	 <p>Ex) MFGN5-4.0RB</p>
<p><b>MFGN5 - 4.0 - R 005 - L 030</b></p> <p>① ② ③ ④ ⑤ ⑥</p> <p>① Refer to No. 1              ② Width of cutting edge: 4.0 mm      ③ Right            ④ Nose Radius: 0.05          ⑤ Left                                  ⑥ Nose Radius : 0.30</p>	 <p>Ex) MFGN5-4.0-R005-L030</p>
<p><b>MFGN5 - 4.0 - 0.05 R</b></p> <p>① ② ③</p> <p>① Refer to No. 1            ② Width of cutting edge: 4.0 mm            ③ Nose Radius: 0.05</p>	 <p>Ex) MFGN5-4.0-0.05R</p>
<p><b>MFG R 5 - 4.0 - 5D - R 002 - L 115</b></p> <p>① ② ③ ④ ⑤ ⑥ ⑦ ⑧ ⑨</p> <p>① Refer to No. 1              ② Right                              ③ Clamp part: 5mm            ④ Width of cutting edge: 4.0mm      ⑤ Lead angle: 5°                  ⑥ Right            ⑦ Nose Radius: 0.02                  ⑧ Left                                  ⑨ Nose Radius: 1.15</p>	 <p>Ex) MFGR5-4.0-5D-R002-L115</p>
<p><b>MFG L 5 - 4.0 - 15D - 1.5R</b></p> <p>① ② ③ ④ ⑤ ⑥</p> <p>① Refer to No. 1              ② Left                                  ③ Clamp part: 5 mm            ④ Width of cutting edge: 4.0 mm      ⑤ Lead angle: 15°                  ⑥ Right Nose Radius: 1.5</p>	 <p>Ex) MFG L 5-4.0-15D-1.5R</p>
<p><b>MFG R 5 - 4.10 - 25D - R012 - L000</b></p> <p>① ② ③ ④ ⑤ ⑥ ⑦</p> <p>① Refer to No. 1              ② Right                              ③ Clamp part: 5mm            ④ Width of cutting edge: 4.1mm      ⑤ Degree: 25°                      ⑥ Right Nose Radius: 1.2            ⑦ Left Nose Radius: 0.0</p>	 <p>Ex) MFG R 5-4.10-25D-R012-L000</p>





## Code system

KP
27
064
-
R0.425
N3

**KORLOY PULLEY**

**ØD**

**W**

**R1**

**No. of flutes**

Ex)

**I.C**

**T**

**R**

**Z**

Ø 15.875

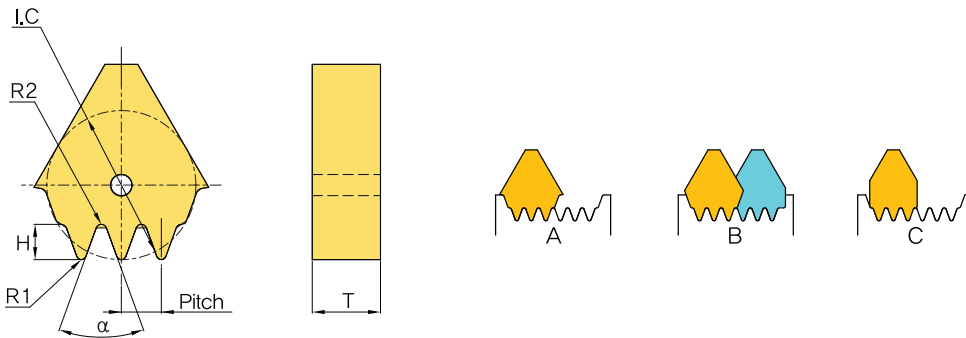
6.4

0.425

3

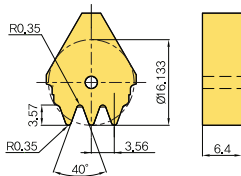
► Special types are available for quotation

### Insert for machining of pulley



#### Specifications

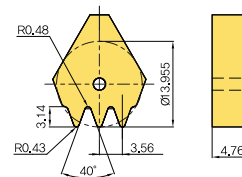
#### Standard designation



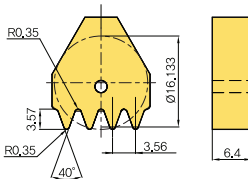
**KP27064-R0.35-N3**  
(Former: DF356-3B)

#### Specifications

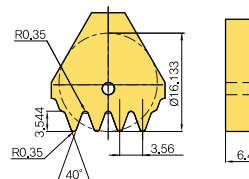
#### Standard designation



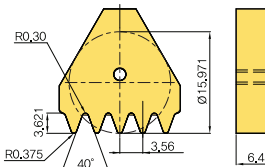
**KP27064-R0.43-N3**  
(Former: DF356-3SR)



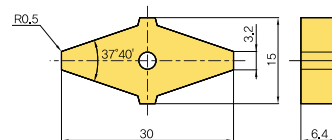
**KP27064-R0.35-N4**  
(Former: DF356-4B)



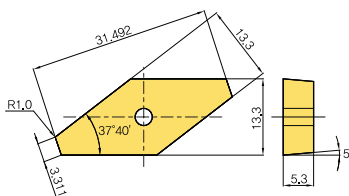
**KP27064-R0.35-N4-A**  
(Former: DF356-4X)



**KP27064-R0.375-N5**  
(Former: DF356-5B)



**UF320**

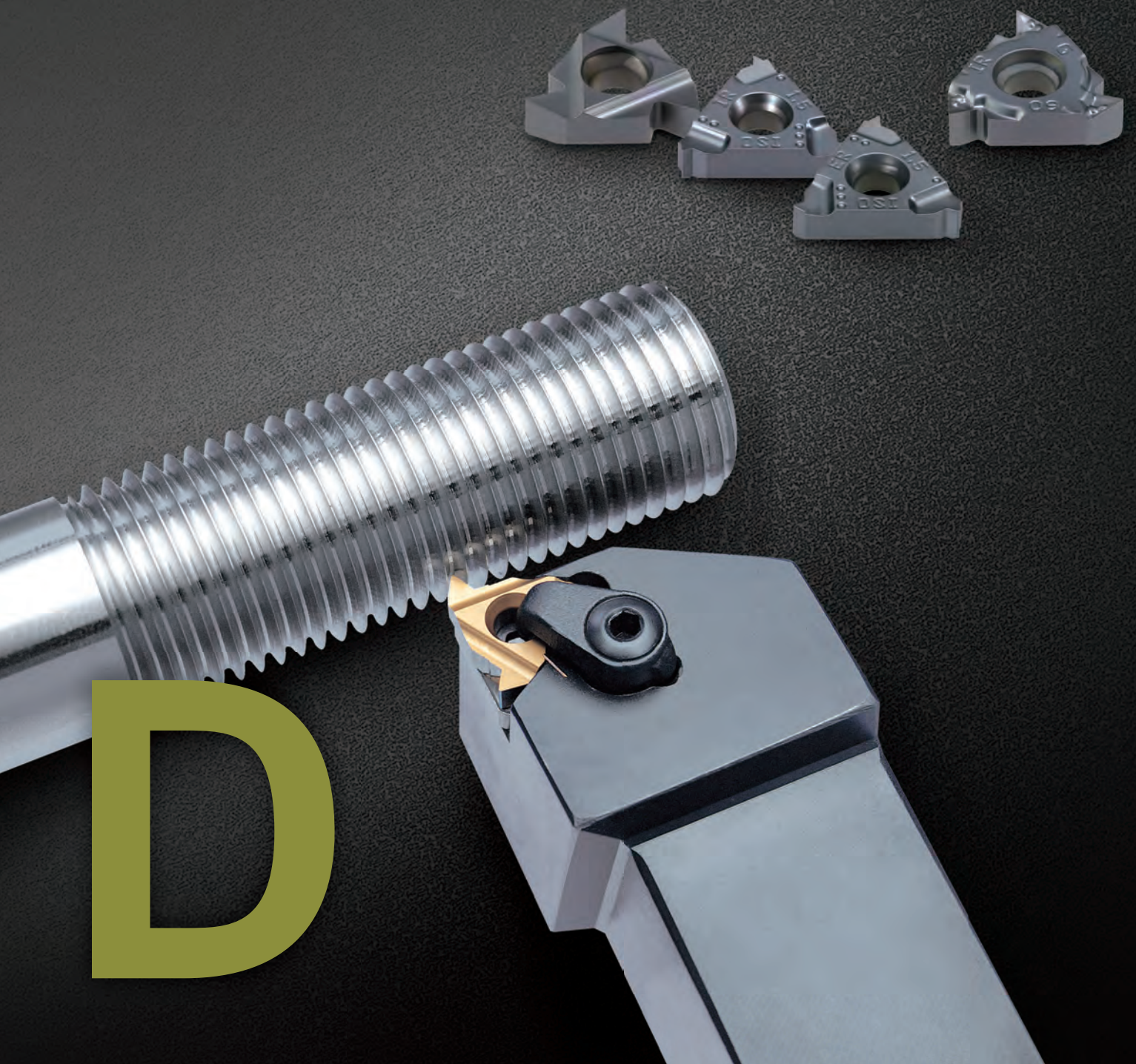


**VF13M522**



# THREADING

Korloy threading tools are available for machining various shapes of thread at various pitches while ensuring high quality performances





### Threading Code System

- D02** Threading Holder Code System
- D02** Threading Insert Code System

### Technical Information for Threading

- D03** Technical Information for Threading
- D09** Threading Insert with Chip Breaker

### Thread Inserts

- D10** Partial profile 60°
- D11** Partial profile 55°
- D12** ISO Metric
- D16** American UN  
(UN, UNC, UNF, UNEF, UNS)
- D18** Whitworth (BSW, BSF, BSP, BSB)
- D22** British Standard Pipe Thread  
(BSPT)
- D22** National Pipe Thread (NPT)
- D23** National Pipe Threads-Dryseal  
(NPTF)
- D23** Round DIN405 (RD)

### Thread Inserts

- D24** Trapez DIN103 (TR)
- D24** American ACME (ACME)
- D25** Stub ACME (STACME)
- D26** UNJ (Unified Constant Thread)
- D28** American Buttress (ABUT)
- D28** British Buttress (BBUT)
- D29** Metric Buttress (SAGE)/API
- D30** API Buttress Casing (BUT)
- D30** API Round Casing & Tubing (APIRD)
- D30** Extreme Line Casing (EL)

### Thread Holders

- D31** External Holder
- D32** Internal Holder
- D33** Vertical Type Holder

### Thread Milling

- D34** Technical Information for Thread Milling
- D44** Thread Milling Insert
- D49** Thread Milling Holder

# D Threading Code System

## Threading holder code system



**1 Holder type**  
E R H 10 (N) - 11 (C)

E: For External    I: For Internal

**2 Hand of insert**  
E R H 10 (N) - 11 (C)

R: Right handed    L: Left handed

**3 Name**  
E R H 10 (N) - 11 (C)

H: Holder

**4 Height of shank**  
E R H 10 (N) - 11 (C)

- External  
8, 10, 12, 16, 20,  
25, 32, 40, 50

- Internal  
10, 12, 13, 16, 20,  
25, 32, 49, 50, 60

\*Refer to the specification for shank diameter information

**6 Insert size (mm)**  
E R H 10 (N) - 11 (C)

11: d = 6.35  
 16: d = 9.525  
 22: d = 12.7  
 27: d = 15.875

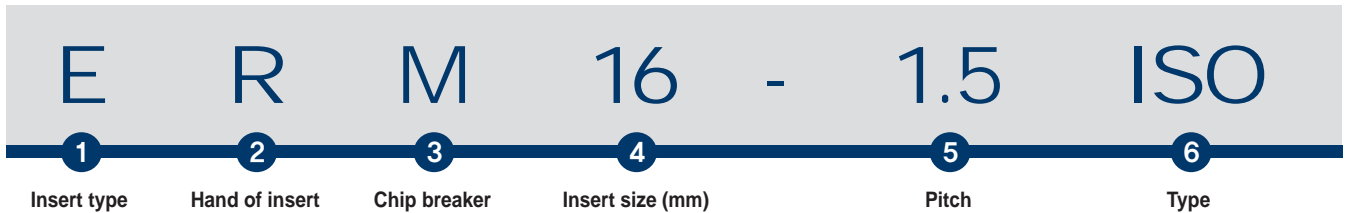
**5 Shim**  
E R H 10 (N) - 11 (C)

No code: Shim required  
 N: No shim required

**7 Clamping system**  
E R H 10 (N) - 11 (C)

No code: Screw on system  
 C: Clamp on system

## Threading insert code system



**1 Insert type**  
E R M 16 - 1.5 ISO

E: External thread    I: Internal thread

**2 Hand of insert**  
E R M 16 - 1.5 ISO

R: Right handed    L: Left handed

**3 Chip breaker**  
E R M 16 - 1.5 ISO

M: With chip breaker

**4 Insert size (mm)**  
E R M 16 - 1.5 ISO

11: d = 6.35  
 16: d = 9.525  
 22: d = 12.7  
 27: d = 15.875

**Insert shape**

< ER/IR >

< ERM/IRM >

**5 Pitch**  
E R M 16 - 1.5 ISO

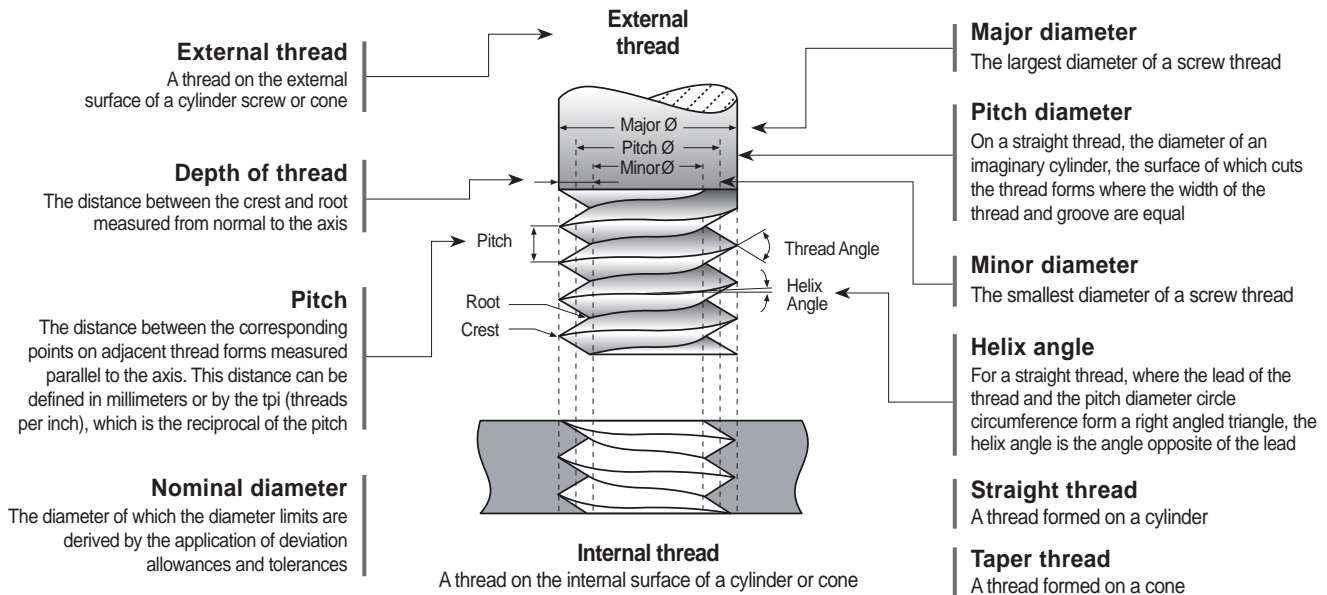
Full profile		Partial profile	
mm	tpi	mm	tpi
0.35-6.0	72-3	A	0.5-1.5 48-16
		AG	0.5-3.0 48-8
		G	1.75-3.0 14-8
		N	3.5-5.0 7-5
		Q	5.5-6.0 4.5-4

**6 Type**  
E R M 16 - 1.5 ISO

Partial profile 60°  
 Partial Profile 55°  
 ISO Metric (Full Profile)  
 American UN (Full Profile) UN, UNC, UNF, UNEF  
 Whitworth (Full Profile) BSW, BSF, BSP  
 British Standard Pipe thread (Full Profile) BSPT  
 National Pipe Thread (Full Profile) NPT  
 National Pipe Threads-Dryseal (Full Profile) NPTF  
 Round DIN 405  
 Trapez DIN 103  
 American ACME  
 Stub ACME  
 UNJ  
 American Buttress  
 British Buttress  
 Metric Buttress-Sagengewinde  
 API  
 API Buttress Casing  
 API Round Casing & Tubing  
 EL-Extreme Line Casing



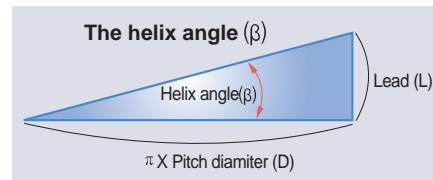
## Special features



A thread which, when viewed axially, winds in a counter clockwise and receding direction. All left handed threads are designated LH



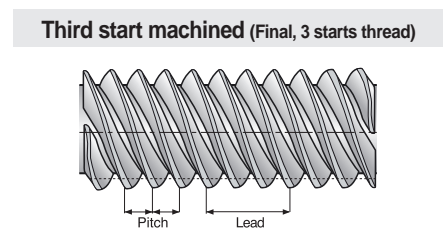
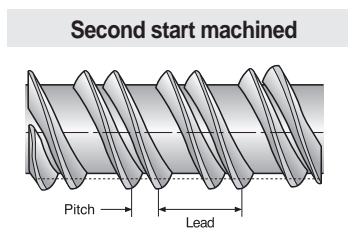
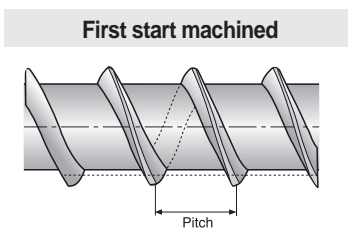
A thread which, when viewed axially, winds in a clockwise and receding direction. Threads are always right handed unless they are specified



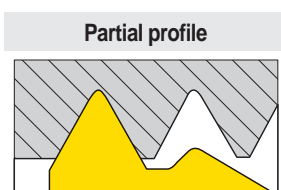
For a straight thread, where the lead of the thread and the pitch diameter circle circumference form a right angled triangle, the helix angle is the angle opposite of the lead

## Machining a multi-start thread

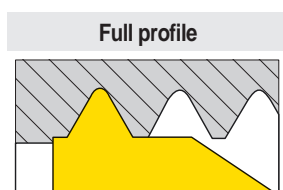
- A thread in which the lead is an integral multiple, greater than one, of the pitch. A multi-start thread permits a more rapid advance without a coarser (larger) thread form



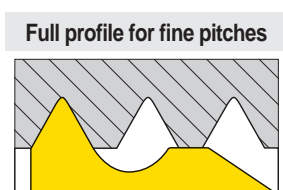
## Insert profile style



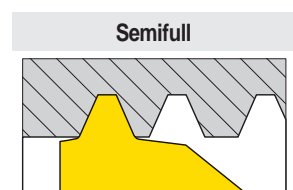
The V partial profile insert cuts without topping the outer diameter of the thread. The same insert can be used for a range of different thread pitches which have a common thread angle



The full profile insert will form a complete thread profile including the crest. For every thread pitch and standard, a separate insert is required



The full profile for Fine Pitches will form a complete thread. The topping of the outer diameter is generated by second tooth

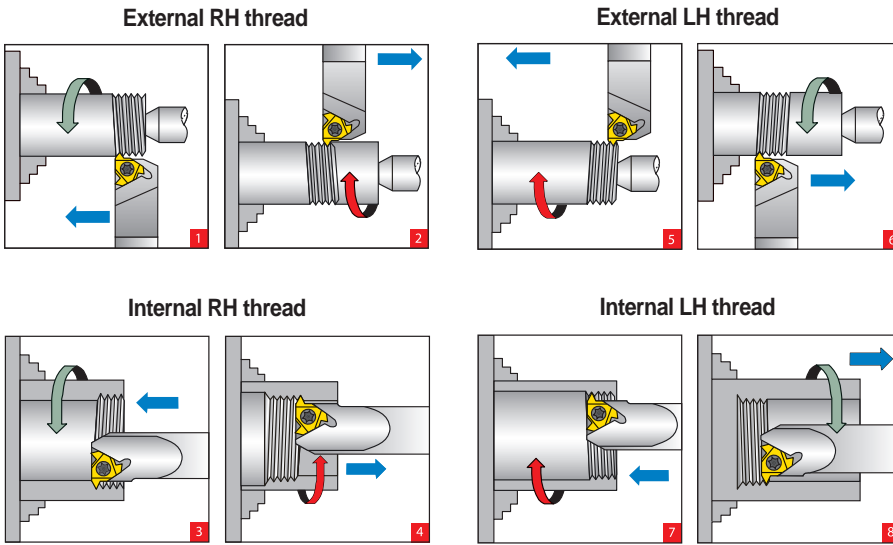


The Semi profile insert will form a complete thread including crest radius but without topping the outer diameter. Mainly used for trapezoidal profiles

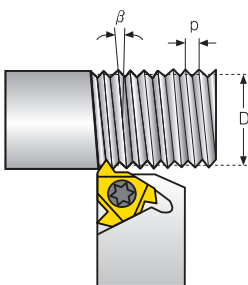
# D Technical Information for Threading

## Thread turning method

Thread	Inserts & Tool holder	Rotation	Feed direction	Helix method	Drawing no.
Right Hand External	EX RH	Counter clockwise	Towards chuck	Regular	<b>1</b>
	EX LH	Clockwise	From chuck	Reversed	<b>2</b>
Right Hand Internal	IN RH	Counter clockwise	Towards chuck	Regular	<b>3</b>
	IN LH	Clockwise	From chuck	Reversed	<b>4</b>
Left Hand External	EX LH	Clockwise	Towards chuck	Regular	<b>5</b>
	EX RH	Counter clockwise	From chuck	Reversed	<b>6</b>
Left Hand Internal	IN LH	Clockwise	Towards chuck	Regular	<b>7</b>
	IN RH	Counter clockwise	From chuck	Reversed	<b>8</b>



## Calculating the helix angle (β)

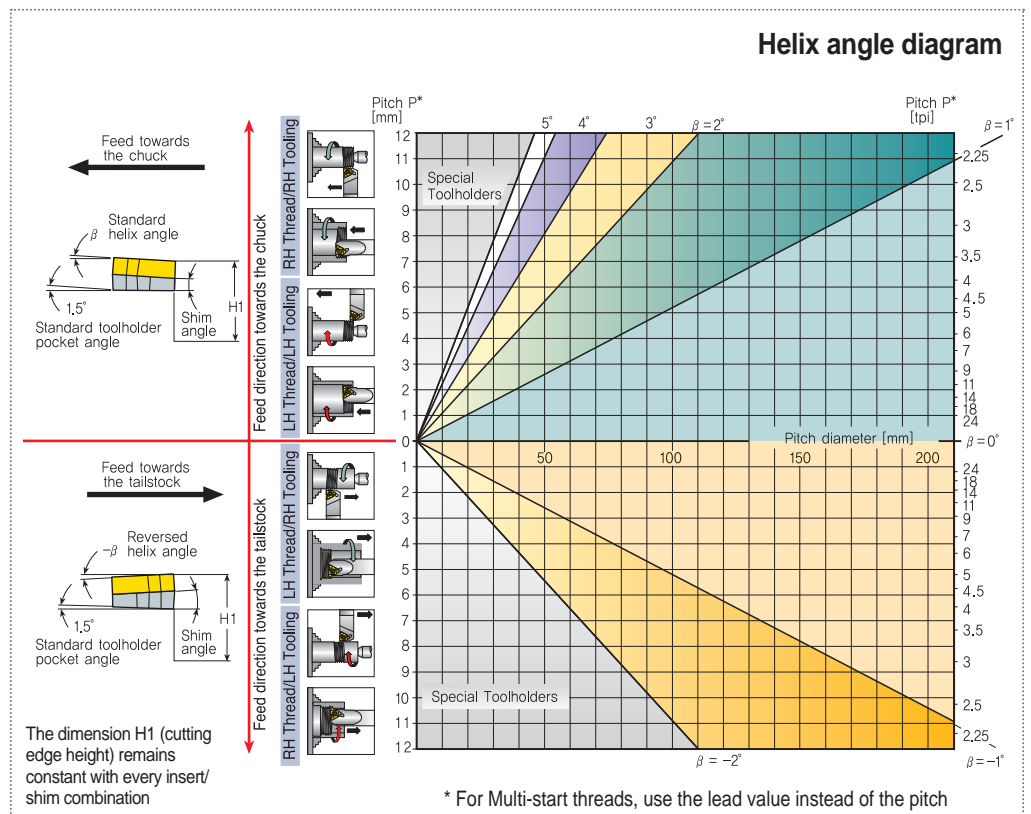


- The helix angle is calculated by the following formula:

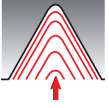
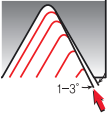

$$\beta = \tan^{-1} \frac{P \times N}{\pi \times D}$$

- β: Helix angle (°)
- P: Pitch (mm)
- N: No. of starts
- D: Pitch diameter (mm)
- Lead = P x N

- The helix angle can also be found from the diagram below



## Thread infeed method

Infeed	Application
 <p><b>Radial infeed</b></p>	<ul style="list-style-type: none"> <li>When the pitch is smaller than 16 tpi</li> <li>For material with short chips</li> <li>For work with hardened material</li> </ul> <p>Radial infeed is the simplest and quickest method. The feed is perpendicular to the turning axis, and both flanks of the insert perform the cutting operation. Radial infeed is recommended in 3 cases.</p>
 <p><b>Flank infeed (modified)</b></p>	<ul style="list-style-type: none"> <li>When the thread pitch is greater than 16 tpi. Using the radial method, the effective cutting edge length is too large, resulting in chatter. For TRAPEZ and ACME. The radial method results in three cutting edges, making chip flow very difficult.</li> </ul> <p>Flank infeed is recommended in the following cases.</p>
 <p><b>Alternate flank infeed</b></p>	<ul style="list-style-type: none"> <li>This method divides the load equally on both flanks, resulting in equal wear along the cutting edges. Alternate flank infeed requires more complicated programming, and is not available on all lathes.</li> </ul> <p>Use of the alternate flank method is recommended especially in large pitches and for materials with long chips.</p>

## Shim

Standard shim	ATE (External)    ATI (Through)		Helix angle 1.5°	Insert size	d	9.525		12.7		15.875	
					L	16		22		27	
				Holder	ER(L)H	IR(L)H	ER(L)H	IR(L)H	ER(L)H	IR(L)H	
				Ordering code	ATE16	ATI16	ATE22	ATI22	ATE27	ATI27	
※ Standard shim has lead angle 1.5°											

## Application grade

Grade	Features	Available insert type
<b>PC5300</b>	Universal grade <ul style="list-style-type: none"> <li>For chip breaker type only</li> <li>Stable machining on a wide application due to fine-grained carbide substrate with balanced heat resistance and toughness</li> <li>Excellent wear resistance and oxidation resistance due to TiN coating film. Outstanding performance on high speed machining</li> </ul>	ERM/IRM (Insert with Chip breaker)
<b>PC3030T</b>	Specialized grade for threading inserts <ul style="list-style-type: none"> <li>A tough sub-micron substrate with TiAlN coating provides good fracture toughness and excellent wear resistance</li> <li>Outstanding performance on STS and hard to cut materials</li> </ul>	ER/IR (Ground insert)
<b>PC9070T</b>	Specialized grade for threading inserts <ul style="list-style-type: none"> <li>Strong wear resistance in stainless machining thanks to multilayer PVD coatings</li> </ul>	E/IR (Ground insert)

## Application range

Workpiece		Application Range
<b>P</b>	Carbon steel, Alloy steel, Cast Steel	PC5300, PC3030T
<b>M</b>	Stainless steel	PC5300, PC3030T, PC9070T
<b>K</b>	Cast Steel	PC5300, PC3030T
<b>N</b>	Aluminum, Copper	PC5300, PC3030T



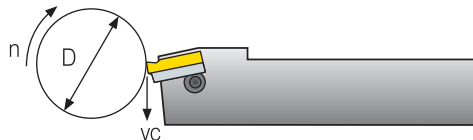
# D Technical Information for Threading

## Recommended cutting speed as per workpiece (vc)

Workpiece			Hardness brinell (HB)	vc (m/min)		
				PC3030T	PC9070T	PC5300
P	Carbon steel	Low carbon (C=0.1-0.25 %)	125	115~190		110~190
		Medium carbon (C=0.25-0.55 %)	150	100~175		100~165
		High carbon (C=0.55-0.85 %)	170	90~155		90~155
	Low alloy steel	Non-hardened	180	100~180		100~180
		Hardened	275	75~140		75~140
		Hardened	350	70~135		70~135
	High alloy steel	Annealed	200	80~120		80~120
		Hardened	325	50~100		50~100
Cast steel	Low alloy	200	70~130		70~130	
	High alloy	225	60~120		60~120	
M	Stainless steel ferritic	Non-hardened	200	70~130	70~150	70~130
		Hardened	330	50~95	60~125	50~95
	Stainless steel austenitic	Austenitic	180	80~120	90~160	80~120
		Super austenitic	200	30~100	40~120	30~100
	Stainless steel cast ferritic	Non-hardened	200	90~120	90~150	90~120
		Hardened	330	65~110	65~120	65~110
	Stainless steel cast austenitic	Austenitic	200	85~110	85~120	85~110
		Hardened	330	60~100	60~110	60~100
	High temperature alloy	Annealed (Iron based)	200	45~60		45~60
		Aged (Iron based)	280	30~50		30~50
		Annealed (Nickel or Cobalt based)	250	20~30		20~30
		Aged (Nickel or Cobalt based)	350	15~25		15~25
Titanium alloy	99.5% pure Titanium	400Rm	140~170		140~170	
	Titanium alloy	1050Rm	50~70		50~70	
K	Extra hard steel	Hardened & tempered	55HRC	45~60		45~60
	Malleable cast iron	Ferritic (short chips)	130	70~120		70~120
		Pearlitic (long chips)	230	70~120		70~120
	Gray cast iron	Low tensile strength	180	70~130		70~130
		High tensile strength	260	60~100		60~100
	Nodular SG iron	Ferritic	160	125~160		125~160
Pearlitic		260	90~120		90~120	
N	Aluminum alloy wrought	Non-aging	60	100~250		100~250
		Aged	100	80~180		80~180
	Aluminum alloy	Cast	75	200~400		200~400
		Cast & aged	90	200~280		200~280
		Cast Si 13-22%	130	60~150		60~180
	Copper and copper alloy	Brass	90	80~120		80~210
Bronze and non-leaded copper		100	80~120		80~210	

## Calculation of n [RPM]

$$n = \frac{vc \times 1000}{\pi \times D} \quad vc = \frac{\pi \times D \times n}{1000}$$



n: Revolution Per Minute [min<sup>-1</sup>]  
vc: Cutting Speed [m/min]  
D: Workpiece Diameter [mm]

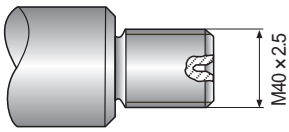
## Number of passes

Pitch	mm	0.50	0.75	1.00	1.25	1.50	1.75	2.00	2.50	3.00	3.50	4.00	4.50	5.00	5.50	6.00	8.00
	tpi	48	32	24	20	16	14	12	10	8	7	6	5.5	5	4.5	4	3
No. of passes		4~6	4~7	4~8	5~9	6~10	7~12	7~12	8~14	9~16	10~18	11~18	11~19	12~20	12~20	12~20	15~24

\* One cutting depth is calculated by total cutting depth divided into machining times  
ex) ER16-1.5ISO, hmin 0.92: If 10 times machining, one cutting depth is 0.092 (0.92/10)



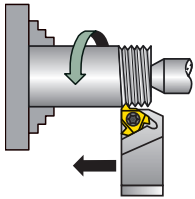
## Step by step thread turning



### Application

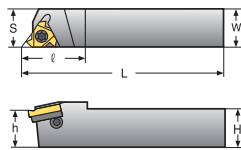
- Thread: External right hand ISO metric M40x2.5
- Material: 4140 (25 HRC)

### 1 Choose the thread turning method



Feed direction towards the chuck was chosen  
Therefore an external right hand insert and an external right hand holder will be used

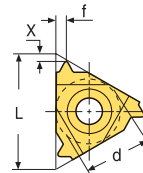
### 3 Choose the tool holder



Chosen tool holder: ERH 25-16

Insert size	Ordering code	Dimensions (mm)				
		d	H=h	W	S	L
9.525	ERH25-16	25	25	25	153.6	30

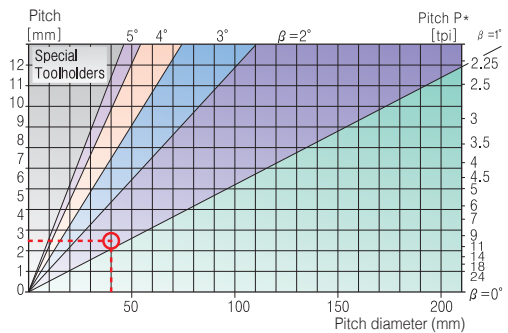
### 2 Choose the insert size



Chosen insert: ER16-2.5 ISO

Insert size	Pitch	Ordering code	Shim		Tool holder
			d	mm	
9.525	2.5	ER16-2.5ISO	ATE16	ERH□□-16	

### 4 Determine the helix angle



From the table, using a pitch of 2.5 mm (10 tpi) and a workpiece diameter of 40 mm (1.57"), we find the helix angle to be 1.5°

### 5 Choose the correct shim

Resultant Helix angle		1.5°
Insert size	d	9.525
	L	16
Ordering code		ATE16

### 6 Choose the carbide grade and cutting speed

Workpiece	HB	vc (m/min)	
		PC3030T	
P Low alloy steel (alloying elements ≤ 5%)	Non-hardened	180	85~145
	Hardened	275	75~140
	Hardened	350	70~135

- Carbide grade chosen: PC3030T
- Cutting speed: 140 m/min

### 7 Determine the number of passes

Pitch	mm	1.50	1.75	2.00	2.50	3.00	3.50	4.00
	tpi	16	14	12	10	8	7	6
No. of passes		6~10	7~12	7~12	8~14	9~16	10~18	11~18

- Carbide grade chosen: PC3030T
- Cutting speed: 140 m/min

### 8 Summary

Thread type	ISO M40 x 2.5 External right hand
1. Feed direction	Towards the chuck
2. Insert and grade	ER16-2.5ISO, PC3030T
3. Tool holder	ERH25-16
4. Helix angle	1.5°
5. Shim	ATE 16
6. Cutting speed	140 m/min
7. Number of passes	10

# D Technical Information for Threading

## ➤ Cutting condition depending on

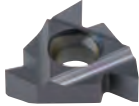











<b>Workpiece</b>	Material type		<b>Coolant</b>	Coolant type		
	Material dimension			<b>Holders</b>	Holder cross section area	
	Diameter and length chipflow character				Holder overhang	
	Material hardness				Through coolant option	
<b>Thread application</b>	External or internal		<b>Shank type: Carbide, alloy</b>	Carbide implant grade		
	Profile shape				Profile shape: Pitch and depth	
	Surface finish				Nose radius	
<b>Machine</b>	Machine stability		<b>Insert</b>	Profile shape: Pitch and depth		
	Max. RPM				Nose radius	
	Clamping system stability				Chip breaker style	

## ➤ Trouble shooting


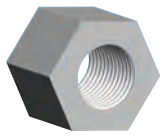
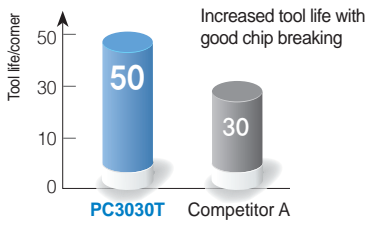
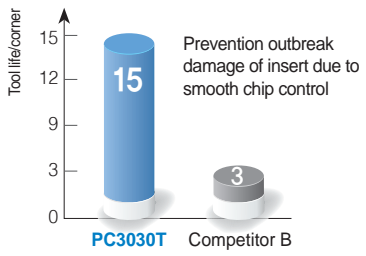
Problem	Possible cause	Solution
 <b>Increased flank wear</b>	Cutting speed too high ..... ➤ Depth of cut too low/too many passes ..... ➤ Unsuitable carbide grade ..... ➤ Insufficient cooling ..... ➤	Reduce cutting speed/use coated insert Increase the depth of cut per pass Use a coated carbide grade Increase coolant flow rate
 <b>Uneven cutting edge wear</b>	Incorrect helix angle ..... ➤ Wrong infeed method ..... ➤	Choose the correct shim Use the alternating flank infeed method
 <b>Extreme plastic deformation</b>	Depth of cut too large ..... ➤ Insufficient cooling ..... ➤ Cutting speed too high ..... ➤ Unsuitable carbide grade ..... ➤ Nose radius too small ..... ➤	Decrease depth of cut/ increase number of passes Increase coolant flow rate Reduce cutting speed Use a tougher carbide Use an insert with a larger radius, if possible
 <b>Cutting edge breakage</b>	Depth of cut too large ..... ➤ Extreme plastic deformation ..... ➤ Insufficient cooling ..... ➤ Unsuitable carbide grade ..... ➤ Instability ..... ➤	Decrease depth of cut/ increase number of passes. Use a tougher carbide Increase flow rate and/ or correct flow direction Use a tougher carbide Check stability of the system
 <b>Built-up edge</b>	Incorrect cutting speed ..... ➤ Unsuitable carbide grade ..... ➤	Change the cutting speed Use a coated carbide
 <b>Thread profile is too shallow</b>	The tool is not at the workpiece axis height ..... ➤ Insert is not machining the thread crest ..... ➤ Worn insert ..... ➤	Change tool height Measure the workpiece diameter Change the cutting edge sooner
 <b>Poor surface quality</b>	Too low cutting speed ..... ➤ Wrong shim ..... ➤ Flank infeed method is not appropriate ..... ➤	Increase cutting speed Choose correct shim Use the alternate flank or radial infeed method

## Threading insert with chip breaker

- Features**
- Economical insert
  - Good toughness and high accuracy as ground type inserts
  - Exclusive insert design improves chip control
  - New grade for general application of various kinds of workpieces

Type	Ground insert		Insert with a chip breaker			
C/B Code	None		None		U	
Designation	ER16-1.5ISO		ERM16-1.5ISO		ERM16-1.5ISO-U	
Machining	External	Internal	External	Internal	External	Internal
Insert Shape						
Chip Shape						
Class	P, M, K, N, S		P, M, K		P, M, K	
Application	G - Class		M - Class		M - Class	
Features	<ul style="list-style-type: none"> <li>• Groove-shaped chip breaker with superior chip evacuation lowers cutting load</li> <li>• Enables high precision machining</li> <li>• Applicable for machining of various shapes of threads</li> <li>• Applicable for machining of various workpieces</li> </ul>		<ul style="list-style-type: none"> <li>• Unique 3 dimensional chip breaker improves machinability with good chip control</li> <li>• Excellent cutting edge treatment technology ensures high precision sharp cutting edge</li> </ul>		<ul style="list-style-type: none"> <li>• Groove-shaped chip breaker with superior chip evacuation lowers cutting load</li> <li>• Reduces machining pass by 10~30%</li> <li>• Excellent cutting edge treatment achieves high precision sharp cutting edge</li> </ul>	

### Application examples

KORLOY		ERM16-1.5ISO [PC3030T]	IRM16-2.0ISO [PC3030T]
Competitor tools		ER16-1.5ISO [A-Maker]	IR16-2.0ISO [B-Maker]
Workpiece	Material	SCM440	STS304
	Figure		
Cutting condition	Cutting speed (m/min)	63	120
	Pass	8	9
	Machining	Radial infeed	Radial infeed
	Pitch	1.5	2.0
Coolant		Wet	Wet
Result		 <p>Increased tool life with good chip breaking</p>	 <p>Prevention outbreak damage of insert due to smooth chip control</p>

## Partial profile 60°

Type	Designation (Right)	PC3030T	PC9070T	Designation (Left)	PC3030T	PC9070T	Pitch		Dimensions (mm)					Picture
							(mm)	(tpi)	d	L	r	x	f	
External	ER 11-A60	●	●	EL 11-A60	●		0.5~1.5	48~16	6.35	11	0.05	0.8	0.9	
	16-A60	●	●	16-A60	●		0.5~1.5	48~16	9.525	16	0.05	0.8	0.9	
	16-G60	●		16-G60	●		1.75~3.0	14~8	9.525	16	0.27	1.2	1.7	
	16-AG60	●	●	16-AG60	●		0.5~3.0	48~8	9.525	16	0.08	1.2	1.7	
	22-N60	●	●	22-N60	●		3.5~5.0	7~5	12.7	22	0.53	1.7	2.5	
	27-Q60	●	●	27-Q60	●		5.5~6.0	4.5~4	15.875	27	0.64	2.1	3.1	
Internal	IR 11-A60	●	●	IL 11-A60	●	●	0.5~1.5	48~16	6.35	11	0.05	0.8	0.9	
	16-A60	●		16-A60	●		0.5~1.5	48~16	9.525	16	0.05	0.8	0.9	
	16-G60	●		16-G60	●		1.75~3.0	14~8	9.525	16	0.16	1.2	1.7	
	16-AG60	●	●	16-AG60	●		0.5~3.0	48~8	9.525	16	0.05	1.2	1.7	
	22-N60	●	●	22-N60	●		3.5~5.0	7~5	12.7	22	0.30	1.7	2.5	
	27-Q60	●	●	27-Q60			5.5~6.0	4.5~4	15.875	27	0.30	1.8	2.7	

➔ Applicable holders D31, D32

●: Stock item

## Partial profile 60° (M chip breaker)

Type	Designation (Right)	PC3030T	PC5300	Designation (Left)	PC3030T	Pitch		Dimensions (mm)					Picture	
						(mm)	(tpi)	d	L	r	x	f		
External	ERM 16-A60	●					0.5~1.5	48~16	9.525	16	0.05	0.8	0.9	
	16-G60	●					1.75~3.0	14~8	9.525	16	0.27	1.2	1.7	
	16-AG60	●					0.5~3.0	48~8	9.525	16	0.08	1.2	1.7	
	22-N60	●					3.5~5.0	7~5	12.7	22	0.53	1.7	2.5	
Internal	IRM 11-A60	●					0.5~1.5	48~16	6.35	11	0.08	0.8	0.9	
	16-A60	●					0.5~1.5	48~16	9.525	16	0.08	0.8	0.9	
	16-G60	●					1.75~3.0	14~8	9.525	16	0.12	1.2	1.7	
	16-AG60	●					0.5~3.0	48~8	9.525	16	0.08	1.2	1.7	
	22-N60	●					3.5~5.0	7~5	12.7	22	0.30	1.7	2.5	

➔ Applicable holders D31, D32

●: Stock item

## Partial profile 60° (U chip breaker)

Type	Designation (Right)	PC3030T	PC5300	Designation (Left)	PC3030T	Pitch		Dimensions (mm)					Picture	
						(mm)	(tpi)	d	L	r	x	f		
External	ERM 16-AG60-U						0.5~3.0	48~8	9.525	16	0.08	1.2	1.7	
Internal	IRM 16-AG60-U						0.5~3.0	48~8	9.525	16	0.08	1.2	1.7	

➔ Applicable holders D31, D32

●: Stock item



## Partial profile 55°

Type	Designation (Right)	PC3030T	PC9070T	Designation (Left)	PC3030T	PC9070T	Pitch		Dimensions (mm)					Picture
							(mm)	(tpi)	d	L	r	x	f	
External	ER 11-A55	●		EL 11-A55			0.5~1.5	48~16	6.35	11	0.05	0.8	0.9	
	16-A55	●		16-A55	●		0.5~1.5	48~16	9.525	16	0.05	0.8	0.9	
	16-G55	●		16-G55			1.75~3.0	14~8	9.525	16	0.21	1.2	1.7	
	16-AG55	●		16-AG55	●		0.5~3.0	48~8	9.525	16	0.07	1.2	1.7	
	22-N55	●		22-N55			3.5~5.0	7~5	12.7	22	0.43	1.7	2.5	
	27-Q55			27-Q55			5.5~6.0	4.5~4	15.875	27	0.60	2.0	2.9	
Internal	IR 11-A55	●		IL 11-A55	●		0.5~1.5	48~16	6.35	11	0.05	0.8	0.9	
	16-A55	●		16-A55			0.5~1.5	48~16	9.525	16	0.05	0.8	0.9	
	16-G55	●		16-G55			1.75~3.0	14~8	9.525	16	0.21	1.2	1.7	
	16-AG55	●		16-AG55	●		0.5~3.0	48~8	9.525	16	0.07	1.2	1.7	
	22-N55	●		22-N55			3.5~5.0	7~5	12.7	22	0.43	1.7	2.5	
	27-Q55			27-Q55			5.5~6.0	4.5~4	15.875	27	0.60	2.0	2.9	

➡ Applicable holders D31, D32

● : Stock item

## Partial profile 55° (M chip breaker)

Type	Designation (Right)	PC3030T	PC5300	Designation (Left)	PC3030T	Pitch		Dimensions (mm)					Picture
						(mm)	(tpi)	d	L	r	x	f	
External	ERM 16-A55	●				0.5~1.5	48~16	9.525	16	0.08	0.8	0.9	
	16-G55	●				1.75~3.0	14~8	9.525	16	0.21	1.2	1.7	
	16-AG55	●				0.5~3.0	48~8	9.525	16	0.07	1.2	1.7	
	22-N55	●				3.5~5.0	7~5	12.7	22	0.43	1.7	2.5	
Internal	IRM 11-A55	●				0.5~1.5	48~16	6.35	11	0.08	0.8	0.9	
	16-A55	●				0.5~1.5	48~16	9.525	16	0.05	0.8	0.9	
	16-G55	●				1.75~3.0	14~8	9.525	16	0.08	1.2	1.7	
	16-AG55	●				0.5~3.0	48~8	9.525	16	0.08	1.2	1.7	
	22-N55	●				3.5~5.0	7~5	12.7	22	0.43	1.7	2.5	

➡ Applicable holders D31, D32

● : Stock item

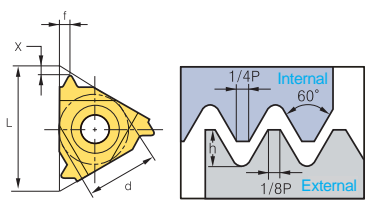
## Partial profile 55° (U chip breaker)

Type	Designation (Right)	PC3030T	PC5300	Designation (Left)	PC3030T	Pitch		Dimensions (mm)					Picture
						(mm)	(tpi)	d	L	r	x	f	
External	ERM 16-AG55-U					0.5~3.0	48~8	9.525	16	0.07	1.2	1.7	
Internal	IRM 16-AG55-U					0.5~3.0	48~8	9.525	16	0.08	1.2	1.7	

➡ Applicable holders D31, D32

● : Stock item

## ISO Metric

Type	Designation (Right)	PC3030T	PC9070T	Designation (Left)	PC3030T	PC9070T	Pitch (mm)	Dimensions (mm)					Picture
								d	L	hmin	X	f	
External	ER 11-0.35ISO	●		EL 11-0.35ISO			0.35	6.35	11	0.21	0.8	0.4	
	11-0.4ISO	●		11-0.4ISO			0.4	6.35	11	0.25	0.7	0.4	
	11-0.45ISO	●		11-0.45ISO			0.45	6.35	11	0.28	0.7	0.4	
	11-0.5ISO	●		11-0.5ISO			0.5	6.35	11	0.31	0.6	0.4	
	11-0.6ISO	●		11-0.6ISO			0.6	6.35	11	0.37	0.6	0.6	
	11-0.7ISO	●		11-0.7ISO			0.7	6.35	11	0.43	0.6	0.6	
	11-0.75ISO			11-0.75ISO			0.75	6.35	11	0.46	0.6	0.6	
	11-0.8ISO	●		11-0.8ISO			0.8	6.35	11	0.49	0.6	0.6	
	11-1.0ISO	●		11-1.0ISO			1.0	6.35	11	0.61	0.7	0.7	
	11-1.25ISO	● ●		11-1.25ISO			1.25	6.35	11	0.77	0.8	0.9	
	11-1.5ISO	●		11-1.5ISO	●		1.5	6.35	11	0.92	0.8	1.0	
	11-1.75ISO	●		11-1.75ISO			1.75	6.35	11	1.07	0.8	1.1	
	16-0.35ISO			16-0.35ISO			0.35	9.525	16	0.21	0.8	0.4	
	16-0.4ISO			16-0.4ISO			0.4	9.525	16	0.25	0.7	0.4	
	16-0.45ISO	●		16-0.45ISO			0.45	9.525	16	0.28	0.7	0.4	
	16-0.5ISO	●		16-0.5ISO	●		0.5	9.525	16	0.31	0.6	0.4	
	16-0.6ISO	●		16-0.6ISO			0.6	9.525	16	0.37	0.6	0.6	
	16-0.7ISO	●		16-0.7ISO			0.7	9.525	16	0.43	0.6	0.6	
	16-0.75ISO	●		16-0.75ISO			0.75	9.525	16	0.46	0.6	0.6	
	16-0.8ISO	● ●		16-0.8ISO			0.8	9.525	16	0.49	0.6	0.6	
	16-1.0ISO	● ●		16-1.0ISO	●		1.0	9.525	16	0.61	0.7	0.7	
	16-1.25ISO	● ●		16-1.25ISO	●		1.25	9.525	16	0.77	0.8	0.9	
	16-1.5ISO	● ●		16-1.5ISO	●		1.5	9.525	16	0.92	0.8	1.0	
	16-1.75ISO	● ●		16-1.75ISO			1.75	9.525	16	1.07	0.9	1.2	
	16-2.0ISO	● ●		16-2.0ISO	●		2.0	9.525	16	1.23	1.0	1.3	
	16-2.5ISO	● ●		16-2.5ISO			2.5	9.525	16	1.53	1.1	1.5	
	16-3.0ISO	● ●		16-3.0ISO	●		3.0	9.525	16	1.84	1.2	1.6	
	22-3.5ISO	● ●		22-3.5ISO			3.5	12.7	22	2.15	1.6	2.3	
	22-4.0ISO	● ●		22-4.0ISO	●		4.0	12.7	22	2.45	1.6	2.3	
	22-4.5ISO	● ●		22-4.5ISO			4.5	12.7	22	2.78	1.7	2.4	
	22-5.0ISO	● ●		22-5.0ISO	●		5.0	12.7	22	3.07	1.7	2.5	
	27-5.5ISO			27-5.5ISO			5.5	15.875	27	3.37	1.9	2.7	
	27-6.0ISO	● ●		27-6.0ISO			6.0	15.875	27	3.68	2.0	2.9	

➔ Applicable holders D31

●: Stock item



## ISO Metric (M chip breaker)

Type	Designation (Right)	PC3030T	PC5300	Designation (Left)	PC3030T	Pitch	Dimensions (mm)					Picture
						(mm)	d	L	hmin	X	f	
External	ERM 16-1.0ISO	●				1.0	9.525	16	0.61	0.7	0.7	
	16-1.25ISO					1.25	9.525	16	0.77	0.8	0.9	
	16-1.5ISO	●				1.5	9.525	16	0.93	0.8	1.0	
	16-1.75ISO	●				1.75	9.525	16	1.09	0.9	1.2	
	16-2.0ISO	●				2.0	9.525	16	1.25	1.0	1.3	
	16-2.5ISO	●				2.5	9.525	16	1.55	1.1	1.5	
	16-3.0ISO	●				3.0	9.525	16	1.87	1.2	1.6	

➔ Applicable holders D31

● : Stock item

## ISO Metric (U chip breaker)

Type	Designation (Right)	PC3030T	PC5300	Designation (Left)	PC3030T	Pitch	Dimensions (mm)					Picture
						(mm)	d	L	hmin	X	f	
External	ERM 16-1.5ISO-U					1.5	9.525	16	0.93	0.8	1.0	
	16-2.0ISO-U					2.0	9.525	16	1.25	1.0	1.3	

➔ Applicable holders D31

● : Stock item

## ISO Metric

Type	Designation (Right)	PC3030T	PC9070T	Designation (Left)	PC3030T	PC9070T	Pitch (mm)	Dimensions (mm)					Picture
								d	L	hmin	X	f	
Internal	IR 11-0.35ISO	●		IL 11-0.35ISO			0.35	6.35	11	0.20	0.8	0.3	
	11-0.4ISO	●		11-0.4ISO			0.4	6.35	11	0.23	0.8	0.4	
	11-0.45ISO	●		11-0.45ISO			0.45	6.35	11	0.26	0.8	0.4	
	11-0.5ISO	●		11-0.5ISO	●		0.5	6.35	11	0.29	0.6	0.4	
	11-0.6ISO	●		11-0.6ISO			0.6	6.35	11	0.35	0.6	0.6	
	11-0.7ISO	●		11-0.7ISO			0.7	6.35	11	0.40	0.6	0.6	
	11-0.75ISO	●		11-0.75ISO	●		0.75	6.35	11	0.43	0.6	0.6	
	11-0.8ISO			11-0.8ISO			0.8	6.35	11	0.46	0.6	0.6	
	11-1.0ISO	●	●	11-1.0ISO			1.0	6.35	11	0.58	0.6	0.7	
	11-1.25ISO	●	●	11-1.25ISO	●		1.25	6.35	11	0.72	0.8	0.9	
	11-1.5ISO	●	●	11-1.5ISO	●	●	1.5	6.35	11	0.87	0.8	1.0	
	11-1.75ISO		●	11-1.75ISO			1.75	6.35	11	1.01	0.9	1.1	
	11-2.0ISO	●	●	11-2.0ISO	●		2.0	6.35	11	1.15	0.9	1.1	
	11-2.5ISO	●		11-2.5ISO	●		2.5	6.35	11	1.44	0.8	1.1	
	16-0.35ISO	●		16-0.35ISO			0.35	9.525	16	0.20	0.8	0.3	
	16-0.4ISO	●		16-0.4ISO			0.4	9.525	16	0.23	0.8	0.4	
	16-0.45ISO	●		16-0.45ISO			0.45	9.525	16	0.26	0.8	0.4	
	16-0.5ISO	●		16-0.5ISO			0.5	9.525	16	0.29	0.6	0.4	
	16-0.6ISO			16-0.6ISO			0.6	9.525	16	0.35	0.6	0.6	
	16-0.7ISO			16-0.7ISO			0.7	9.525	16	0.40	0.6	0.6	
	16-0.75ISO	●		16-0.75ISO			0.75	9.525	16	0.43	0.6	0.6	
	16-0.8ISO	●		16-0.8ISO			0.8	9.525	16	0.46	0.6	0.6	
	16-1.0ISO	●	●	16-1.0ISO			1.0	9.525	16	0.58	0.6	0.7	
	16-1.25ISO	●	●	16-1.25ISO			1.25	9.525	16	0.72	0.8	0.9	
	16-1.5ISO	●	●	16-1.5ISO	●		1.5	9.525	16	0.87	0.8	1.0	
	16-1.75ISO	●	●	16-1.75ISO			1.75	9.525	16	1.01	0.9	1.2	
	16-2.0ISO	●	●	16-2.0ISO	●		2.0	9.525	16	1.15	1.0	1.3	
	16-2.5ISO	●	●	16-2.5ISO	●		2.5	9.525	16	1.44	1.1	1.5	
	16-3.0ISO	●	●	16-3.0ISO	●		3.0	9.525	16	1.73	1.1	1.5	
	22-3.5ISO	●	●	22-3.5ISO			3.5	12.7	22	2.02	1.6	2.3	
	22-4.0ISO	●	●	22-4.0ISO	●		4.0	12.7	22	2.31	1.6	2.3	
	22-4.5ISO	●	●	22-4.5ISO			4.5	12.7	22	2.60	1.6	2.4	
	22-5.0ISO	●	●	22-5.0ISO			5.0	12.7	22	2.89	1.6	2.3	
	27-5.5ISO	●		27-5.5ISO			5.5	15.875	27	3.17	1.6	2.3	
	27-6.0ISO	●		27-6.0ISO			6.0	15.875	27	3.46	1.8	2.5	

➔ Applicable holders D32

●: Stock item

## ISO Metric (M chip breaker)

Type	Designation (Right)	PC3030T	PC5300	Designation (Left)	PC3030T	Pitch	Dimensions (mm)					Picture
						(mm)	d	L	hmin	X	f	
Internal	IRM 11-1.5ISO	●				1.5	6.35	11	0.85	0.8	1.0	
	16-1.0ISO	●				1.0	9.525	16	0.58	0.6	0.7	
	16-1.25ISO					1.25	9.525	16	0.72	0.8	0.9	
	16-1.5ISO	●				1.5	9.525	16	0.85	0.8	1.0	
	16-1.75ISO					1.75	9.525	16	1.01	0.9	1.2	
	16-2.0ISO	●				2.0	9.525	16	1.12	1.0	1.3	
	16-2.5ISO	●				2.5	9.525	16	1.44	1.1	1.5	
	16-3.0ISO	●				3.0	9.525	16	1.69	1.1	1.5	

➔ Applicable holders D32

● : Stock item

## ISO Metric (U chip breaker)

Type	Designation (Right)	PC3030T	PC5300	Designation (Left)	PC3030T	Pitch	Dimensions (mm)					Picture
						(mm)	d	L	hmin	X	f	
Internal	IRM 16-1.5ISO-U					1.5	9.525	16	0.85	0.8	1.0	
	16-2.0ISO-U					2.0	9.525	16	1.12	1.0	1.3	

➔ Applicable holders D32

● : Stock item

## American UN (UN, UNC, UNF, UNEF, UNS)

Type	Designation (Right)	PC3030T	PC9070T	Designation (Left)	PC3030T	PC9070T	Pitch	Dimensions (mm)					Picture
							(tpi)	d	L	hmin	X	f	
External	ER 11-72UN	●		EL 11-72UN			72	6.35	11	0.22	0.8	0.4	
	11-64UN	●		11-64UN			64	6.35	11	0.24	0.8	0.4	
	11-56UN	●		11-56UN			56	6.35	11	0.28	0.7	0.4	
	11-48UN	●		11-48UN			48	6.35	11	0.32	0.6	0.6	
	11-44UN	●		11-44UN			44	6.35	11	0.35	0.6	0.6	
	11-40UN	●		11-40UN			40	6.35	11	0.39	0.6	0.6	
	11-36UN	●		11-36UN			36	6.35	11	0.43	0.6	0.6	
	11-32UN	●		11-32UN			32	6.35	11	0.49	0.6	0.6	
	11-28UN	●		11-28UN			28	6.35	11	0.56	0.6	0.7	
	11-27UN	●		11-27UN			27	6.35	11	0.58	0.7	0.8	
	11-24UN	●		11-24UN			24	6.35	11	0.65	0.7	0.8	
	11-20UN	●		11-20UN			20	6.35	11	0.78	0.8	0.9	
	11-18UN	●		11-18UN			18	6.35	11	0.87	0.8	1.0	
	11-16UN	●		11-16UN			16	6.35	11	0.97	0.9	1.1	
	11-14UN	●		11-14UN			14	6.35	11	1.11	0.9	1.1	
	16-72UN			16-72UN			72	9.525	16	0.22	0.8	0.4	
	16-64UN			16-64UN			64	9.525	16	0.24	0.8	0.4	
	16-56UN			16-56UN			56	9.525	16	0.28	0.7	0.4	
	16-48UN			16-48UN			48	9.525	16	0.32	0.6	0.6	
	16-44UN			16-44UN			44	9.525	16	0.35	0.6	0.6	
	16-40UN			16-40UN			40	9.525	16	0.39	0.6	0.6	
	16-36UN			16-36UN			36	9.525	16	0.43	0.6	0.6	
	16-32UN	●		16-32UN			32	9.525	16	0.49	0.6	0.6	
	16-28UN	●		16-28UN			28	9.525	16	0.56	0.6	0.7	
	16-27UN	●		16-27UN			27	9.525	16	0.58	0.7	0.8	
	16-24UN	● ●		16-24UN			24	9.525	16	0.65	0.7	0.8	
	16-20UN	● ●		16-20UN			20	9.525	16	0.78	0.8	0.9	
	16-18UN	● ●		16-18UN	●		18	9.525	16	0.87	0.8	1.0	
	16-16UN	● ●		16-16UN	●		16	9.525	16	0.97	0.9	1.1	
	16-14UN	● ●		16-14UN			14	9.525	16	1.11	1.0	1.2	
	16-13UN			16-13UN			13	9.525	16	1.20	1.0	1.3	
	16-12UN	● ●		16-12UN			12	9.525	16	1.30	1.1	1.4	
	16-11.5UN			16-11.5UN			11.5	9.525	16	1.35	1.1	1.5	
	16-11UN	● ●		16-11UN			11	9.525	16	1.42	1.1	1.5	
	16-10UN	● ●		16-10UN			10	9.525	16	1.56	1.1	1.5	
	16-9UN	●		16-9UN			9	9.525	16	1.73	1.2	1.7	
	16-8UN	● ●		16-8UN			8	9.525	16	1.95	1.2	1.6	
	22-7UN			22-7UN			7	12.7	22	2.22	1.6	2.3	
	22-6UN			22-6UN			6	12.7	22	2.60	1.6	2.3	
	22-5UN	●		22-5UN			5	12.7	22	3.12	1.7	2.5	
	27-4.5UN			27-4.5UN			4.5	15.875	27	3.46	1.9	2.7	
	27-4UN			27-4UN			4	15.875	27	3.89	2.1	3.0	

Applicable holders D31

●: Stock item



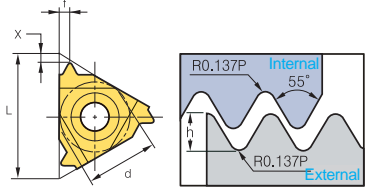
# American UN (UN, UNC, UNF, UNEF, UNS)

Type	Designation (Right)	PC3030T	PC9070T	Designation (Left)	PC3030T	PC9070T	Pitch (tpi)	Dimensions (mm)					Picture
								d	L	hmin	X	f	
Internal	IR 11-72UN			IL 11-72UN			72	6.35	11	0.20	0.8	0.3	
	11-64UN			11-64UN			64	6.35	11	0.23	0.8	0.4	
	11-56UN			11-56UN			56	6.35	11	0.26	0.7	0.4	
	11-48UN			11-48UN			48	6.35	11	0.31	0.6	0.6	
	11-44UN			11-44UN			44	6.35	11	0.33	0.6	0.6	
	11-40UN			11-40UN			40	6.35	11	0.37	0.6	0.6	
	11-36UN			11-36UN			36	6.35	11	0.41	0.6	0.6	
	11-32UN			11-32UN			32	6.35	11	0.46	0.6	0.6	
	11-28UN			11-28UN			28	6.35	11	0.52	0.6	0.7	
	11-27UN			11-27UN			27	6.35	11	0.54	0.7	0.8	
	11-24UN			11-24UN			24	6.35	11	0.61	0.7	0.8	
	11-20UN		●	11-20UN			20	6.35	11	0.73	0.8	0.9	
	11-18UN	●		11-18UN			18	6.35	11	0.81	0.8	1.0	
	11-16UN		●	11-16UN			16	6.35	11	0.92	0.9	1.1	
	11-14UN	●		11-14UN			14	6.35	11	1.05	0.9	1.1	
	11-12UN		●	11-12UN			12	6.35	11	1.22	0.8	1.1	
	11-11UN	●		11-11UN	●		11	6.35	11	1.33	0.8	1.1	
	16-72UN			16-72UN			72	9.525	16	0.20	0.8	0.3	
	16-64UN			16-64UN			64	9.525	16	0.23	0.8	0.4	
	16-56UN			16-56UN			56	9.525	16	0.26	0.7	0.4	
	16-48UN			16-48UN			48	9.525	16	0.31	0.6	0.6	
	16-44UN			16-44UN			44	9.525	16	0.33	0.6	0.6	
	16-40UN			16-40UN			40	9.525	16	0.37	0.6	0.6	
	16-36UN			16-36UN			36	9.525	16	0.41	0.6	0.6	
	16-32UN			16-32UN			32	9.525	16	0.51	0.6	0.6	
	16-28UN	●		16-28UN			28	9.525	16	0.52	0.6	0.7	
	16-27UN			16-27UN			27	9.525	16	0.54	0.7	0.8	
	16-24UN			16-24UN			24	9.525	16	0.61	0.7	0.8	
	16-20UN	●		16-20UN			20	9.525	16	0.73	0.8	0.9	
	16-18UN	●	●	16-18UN			18	9.525	16	0.81	0.8	1.0	
	16-16UN	●	●	16-16UN			16	9.525	16	0.92	0.9	1.1	
	16-14UN	●		16-14UN			14	9.525	16	1.05	0.9	1.2	
	16-13UN			16-13UN			13	9.525	16	1.13	1.0	1.3	
	16-12UN	●	●	16-12UN			12	9.525	16	1.22	1.1	1.4	
	16-11.5UN	●		16-11.5UN			11.5	9.525	16	1.28	1.1	1.5	
	16-11UN	●	●	16-11UN			11	9.525	16	1.33	1.1	1.5	
	16-10UN	●		16-10UN	●		10	9.525	16	1.47	1.1	1.5	
	16-9UN		●	16-9UN			9	9.525	16	1.63	1.2	1.7	
	16-8UN	●	●	16-8UN	●		8	9.525	16	1.83	1.2	1.5	
	22-7UN			22-7UN			7	12.7	22	2.09	1.6	2.3	
22-6UN			22-6UN			6	12.7	22	2.44	1.6	2.3		
22-5UN			22-5UN			5	12.7	22	2.93	1.7	2.3		
27-4.5UN			27-4.5UN			4.5	15.875	27	3.26	1.9	2.4		
27-4UN			27-4UN			4	15.875	27	3.67	2.1	2.7		

➔ Applicable holders D32

● : Stock item

## Whitworth (BSW, BSF, BSP, BSB)

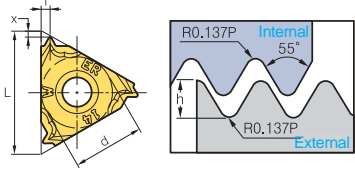
Type	Designation (Right)	PC3030T	PC9070T	Designation (Left)	PC3030T	PC9070T	Pitch (tpi)	Dimensions (mm)					Picture
								d	L	hmin	X	f	
External	ER 11-72W	●		EL 11-72W			72	6.35	11	0.23	0.7	0.4	
	11-60W	●		11-60W			60	6.35	11	0.27	0.7	0.4	
	11-56W	●		11-56W			56	6.35	11	0.29	0.7	0.4	
	11-48W	●		11-48W			48	6.35	11	0.34	0.6	0.6	
	11-40W	●		11-40W			40	6.35	11	0.41	0.6	0.6	
	11-36W	●		11-36W			36	6.35	11	0.45	0.6	0.6	
	11-32W	●		11-32W			32	6.35	11	0.51	0.6	0.6	
	11-28W	●		11-28W			28	6.35	11	0.58	0.6	0.7	
	11-26W	●		11-26W			26	6.35	11	0.63	0.7	0.8	
	11-24W	●		11-24W			24	6.35	11	0.68	0.7	0.8	
	11-22W	●		11-22W			22	6.35	11	0.74	0.8	0.9	
	11-20W	●		11-20W			20	6.35	11	0.81	0.8	0.9	
	11-19W	●		11-19W			19	6.35	11	0.86	0.8	1.0	
	11-18W	●		11-18W			18	6.35	11	0.90	0.8	1.0	
	11-16W	●		11-16W			16	6.35	11	1.02	0.9	1.1	
	11-14W	●		11-14W	●		14	6.35	11	1.16	1.0	1.2	
	16-72W	●		16-72W			72	9.525	16	0.23	0.7	0.4	
	16-60W	●		16-60W			60	9.525	16	0.27	0.7	0.4	
	16-56W	●		16-56W			56	9.525	16	0.29	0.7	0.4	
	16-48W	●		16-48W			48	9.525	16	0.34	0.6	0.6	
	16-40W	●		16-40W			40	9.525	16	0.41	0.6	0.6	
	16-36W	●		16-36W			36	9.525	16	0.45	0.6	0.6	
	16-32W	●		16-32W			32	9.525	16	0.51	0.6	0.6	
	16-30W	●		16-30W			30	9.525	16	0.55	0.6	0.7	
	16-28W	●	●	16-28W			28	9.525	16	0.58	0.6	0.7	
	16-26W			16-26W			26	9.525	16	0.63	0.7	0.8	
	16-24W	●		16-24W			24	9.525	16	0.68	0.7	0.8	
	16-22W	●		16-22W			22	9.525	16	0.74	0.8	0.9	
	16-20W	●		16-20W			20	9.525	16	0.81	0.8	0.9	
	16-19W	●	●	16-19W			19	9.525	16	0.86	0.8	1.0	
	16-18W	●		16-18W			18	9.525	16	0.90	0.8	1.0	
	16-16W	●		16-16W			16	9.525	16	1.02	0.9	1.1	
	16-14W	●	●	16-14W			14	9.525	16	1.16	1.0	1.2	
	16-12W	●		16-12W			12	9.525	16	1.36	1.1	1.4	
	16-11W	●	●	16-11W			11	9.525	16	1.48	1.1	1.5	
	16-10W	●		16-10W			10	9.525	16	1.63	1.1	1.5	
	16-9W	●		16-9W			9	9.525	16	1.81	1.2	1.7	
	16-8W	●		16-8W			8	9.525	16	2.03	1.2	1.5	
	22-7W	●		22-7W			7	12.7	22	3.32	1.6	2.3	
	22-6W	●		22-6W	●		6	12.7	22	2.71	1.6	2.3	
	22-5W	●		22-5W			5	12.7	22	3.25	1.7	2.4	
	27-4.5W	●		27-4.5W			4.5	15.875	27	3.61	1.8	2.6	
	27-4W			27-4W			4	15.875	27	4.07	2.0	2.9	

➔ Applicable holders D31

●: Stock item



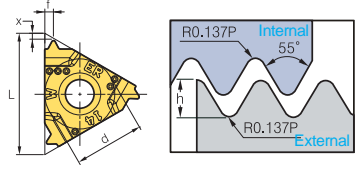
## Whitworth (M chip breaker)

Type	Designation (Right)	PC3030T	PC5300	Designation (Left)	PC3030T	Pitch	Dimensions (mm)					Picture
						(tpi)	d	L	hmin	X	f	
External	ERM 16-11W	●				14	9.525	16	1.16	1.0	1.2	
	16-14W	●				11	9.525	16	1.48	1.1	1.5	
	16-19W	●					19	9.525	16	0.86	0.8	

↻ Applicable holders D31

● : Stock item

## Whitworth (U chip breaker)

Type	Designation (Right)	PC3030T	PC5300	Designation (Left)	PC3030T	Pitch	Dimensions (mm)					Picture
						(tpi)	d	L	hmin	X	f	
External	ERM 16-14W-U					14	9.525	16	1.16	1.0	1.2	
	16-11W-U					11	9.525	16	1.48	1.1	1.5	

↻ Applicable holders D31

● : Stock item



## Whitworth (BSW, BSF, BSP, BSB)

Type	Designation (Right)	PC3030T	PC9070T	Designation (Left)	PC3030T	PC9070T	Pitch (tpi)	Dimensions (mm)					Picture
								d	L	hmin	X	f	
Internal	IR 11-72W	●		IL 11-72W			72	6.35	11	0.23	0.7	0.4	
	11-60W	●		11-60W			60	6.35	11	0.27	0.7	0.4	
	11-56W	●		11-56W			56	6.35	11	0.29	0.7	0.4	
	11-48W	●		11-48W			48	6.35	11	0.34	0.6	0.6	
	11-40W	●		11-40W			40	6.35	11	0.41	0.6	0.6	
	11-36W	●		11-36W			36	6.35	11	0.45	0.6	0.6	
	11-32W	●		11-32W			32	6.35	11	0.51	0.6	0.6	
	11-28W	●		11-28W			28	6.35	11	0.58	0.6	0.7	
	11-26W	●		11-26W			26	6.35	11	0.63	0.7	0.8	
	11-24W	●		11-24W			24	6.35	11	0.68	0.7	0.8	
	11-22W	●		11-22W			22	6.35	11	0.74	0.8	0.9	
	11-20W			11-20W			20	6.35	11	0.81	0.8	0.9	
	11-19W	●	●	11-19W	●		19	6.35	11	0.86	0.8	1.0	
	11-18W	●		11-18W	●		18	6.35	11	0.90	0.8	1.0	
	11-16W	●		11-16W	●		16	6.35	11	1.02	0.9	1.1	
	11-14W	●		11-14W	●		14	6.35	11	1.16	0.9	1.1	
	11-12W	●		11-12W	●		12	6.35	11	1.32	0.9	1.2	
	16-72W	●		16-72W			72	9.525	16	0.23	0.7	0.4	
	16-60W	●		16-60W			60	9.525	16	0.27	0.7	0.4	
	16-56W	●		16-56W			56	9.525	16	0.29	0.7	0.4	
	16-48W	●		16-48W			48	9.525	16	0.34	0.6	0.6	
	16-40W	●		16-40W			40	9.525	16	0.41	0.6	0.6	
	16-36W	●		16-36W			36	9.525	16	0.45	0.6	0.6	
	16-32W	●		16-32W			32	9.525	16	0.51	0.6	0.6	
	16-30W	●		16-30W			30	9.525	16	0.55	0.6	0.7	
	16-28W	●		16-28W			28	9.525	16	0.58	0.6	0.7	
	16-26W	●		16-26W			26	9.525	16	0.63	0.7	0.8	
	16-24W	●		16-24W			24	9.525	16	0.68	0.7	0.8	
	16-22W	●		16-22W			22	9.525	16	0.74	0.8	0.9	
	16-20W	●		16-20W			20	9.525	16	0.81	0.8	0.9	
	16-19W	●		16-19W			19	9.525	16	0.86	0.8	1.0	
	16-18W	●		16-18W			18	9.525	16	0.90	0.8	1.0	
	16-16W	●		16-16W			16	9.525	16	1.02	0.9	1.1	
	16-14W	●	●	16-14W			14	9.525	16	1.16	1.0	1.2	
	16-12W	●		16-12W			12	9.525	16	1.36	1.1	1.4	
	16-11W	●	●	16-11W			11	9.525	16	1.48	1.1	1.5	
	16-10W	●		16-10W			10	9.525	16	1.63	1.1	1.5	
	16-9W	●		16-9W			9	9.525	16	1.81	1.2	1.7	
	16-8W	●		16-8W			8	9.525	16	2.03	1.2	1.5	
	22-7W			22-7W			7	12.7	22	3.32	1.6	2.3	
	22-6W	●		22-6W			6	12.7	22	2.71	1.6	2.3	
	22-5W	●		22-5W			5	12.7	22	3.25	1.7	2.4	
	27-4.5W	●		27-4.5W			4.5	15.875	27	3.61	1.8	2.6	
	27-4W	●		27-4W			4	15.875	27	4.07	2.0	2.9	

➔ Applicable holders D32

●: Stock item



## Whitworth (M chip breaker)

Type	Designation (Right)	PC3030T	PC5300	Designation (Left)	PC3030T	Pitch (tpi)	Dimensions (mm)					Picture
							d	L	hmin	X	f	
Internal	IRM 16-14W					14	9.525	16	1.16	1.0	1.2	
	16-11W	●				11	9.525	16	1.48	1.1	1.5	

➔ Applicable holders D32

● : Stock item

## Whitworth (U chip breaker)

Type	Designation (Right)	PC3030T	PC5300	Designation (Left)	PC3030T	Pitch (tpi)	Dimensions (mm)					Picture
							d	L	hmin	X	f	
Internal	IRM 16-14W-U					14	9.525	16	1.16	1.0	1.2	
	16-11W-U					11	9.525	16	1.48	1.1	1.5	

➔ Applicable holders D32

● : Stock item

## British Standard Pipe Thread (BSPT)

Type	Designation (Right)	PC3030T	PC9070T	Designation (Left)	PC3030T	PC9070T	Pitch (tpi)	Dimensions (mm)					Picture
								d	L	hmin	X	f	
External	ER 11-28BSPT			EL 11-28BSPT			28	6.35	11	0.58	0.6		
	11-19BSPT			11-19BSPT			19	6.35	11	0.86	0.8		
	11-14BSPT			11-14BSPT			14	6.35	11	1.16	0.9		
	16-28BSPT			16-28BSPT			28	9.525	16	0.58	0.6		
	16-19BSPT	●	●	16-19BSPT			19	9.525	16	0.86	0.8		
	16-14BSPT		●	16-14BSPT			14	9.525	16	1.16	1.0		
	16-11BSPT	●	●	16-11BSPT			11	9.525	16	1.48	1.1		
Internal	IR 11-28BSPT			IL 11-28BSPT			28	6.35	11	0.58	0.6		
	11-19BSPT		●	11-19BSPT			19	6.35	11	0.86	0.8		
	11-14BSPT		●	11-14BSPT			14	6.35	11	1.16	0.9		
	16-28BSPT			16-28BSPT			28	9.525	16	0.58	0.6		
	16-19BSPT	●	●	16-19BSPT			19	9.525	16	0.86	0.8		
	16-14BSPT	●	●	16-14BSPT			14	9.525	16	1.16	1.0		
	16-11BSPT	●	●	16-11BSPT			11	9.525	16	1.48	1.1		

➔ Applicable holders D31, D32

●: Stock item

## National Pipe Thread (NPT)

Type	Designation (Right)	PC3030T	PC9070T	Designation (Left)	PC3030T	PC9070T	Pitch (tpi)	Dimensions (mm)					Picture
								d	L	hmin	X	f	
External	ER 11-27NPT	●		EL 11-27NPT			27	6.35	11	0.66	0.7		
	11-18NPT	●		11-18NPT			18	6.35	11	1.01	0.8		
	11-14NPT	●		11-14NPT			14	6.35	11	1.33	0.8		
	16-27NPT	●		16-27NPT			27	9.525	16	0.66	0.7		
	16-18NPT	●	●	16-18NPT			18	9.525	16	1.01	0.8		
	16-14NPT	●	●	16-14NPT			14	9.525	16	1.33	0.9		
	16-11.5NPT	●		16-11.5NPT			11.5	9.525	16	1.64	1.1		
Internal	IR 11-27NPT	●		IL 11-27NPT			27	6.35	11	0.66	0.7		
	11-18NPT	●		11-18NPT			18	6.35	11	1.01	0.8		
	11-14NPT	●	●	11-14NPT	●		14	6.35	11	1.33	0.8		
	16-27NPT	●		16-27NPT			27	9.525	16	0.66	0.7		
	16-18NPT			16-18NPT			18	9.525	16	1.01	0.8		
	16-14NPT	●	●	16-14NPT			14	9.525	16	1.33	0.9		
	16-11.5NPT	●	●	16-11.5NPT	●		11.5	9.525	16	1.64	1.1		
16-8NPT	●		16-8NPT	●		8	9.525	16	2.42	1.3			

➔ Applicable holders D31, D32

●: Stock item



## National Pipe Threads-Dryseal (NPTF)

Type	Designation (Right)	PC3030T	PC9070T	Designation (Left)	PC3030T	PC9070T	Pitch (tpi)	Dimensions (mm)					Picture
								d	L	hmin	X	f	
External	ER 11-27NPTF			EL 11-27NPTF			27	6.35	11	0.64	0.7	0.8	
	11-18NPTF			11-18NPTF			18	6.35	11	1.00	0.8	1.0	
	11-14NPTF			11-14NPTF			14	6.35	11	1.35	0.8	1.0	
	16-27NPTF			16-27NPTF			27	9.525	16	0.64	0.7	0.8	
	16-18NPTF	●		16-18NPTF			18	9.525	16	1.00	0.8	1.0	
	16-14NPTF			16-14NPTF			14	9.525	16	1.35	0.9	1.2	
	16-11.5NPTF			16-11.5NPTF			11.5	9.525	16	1.63	1.1	1.5	
	16-8NPTF			16-8NPTF	●		8	9.525	16	2.38	1.3	1.8	
Internal	IR 11-27NPTF			IL 11-27NPTF			27	6.35	11	0.64	0.7	0.8	
	11-18NPTF			11-18NPTF			18	6.35	11	1.00	0.8	1.0	
	11-14NPTF			11-14NPTF			14	6.35	11	1.35	0.8	1.0	
	16-27NPTF			16-27NPTF			27	9.525	16	0.64	0.7	0.8	
	16-18NPTF			16-18NPTF			18	9.525	16	1.00	0.8	1.0	
	16-14NPTF			16-14NPTF			14	9.525	16	1.35	0.9	1.2	
	16-11.5NPTF			16-11.5NPTF			11.5	9.525	16	1.63	1.1	1.5	
	16-8NPTF			16-8NPTF			8	9.525	16	2.38	1.3	1.8	

Applicable holders D31, D32

● : Stock item

## Round DIN 405

Type	Designation (Right)	PC3030T	PC9070T	Designation (Left)	PC3030T	PC9070T	Pitch (tpi)	Dimensions (mm)					Picture
								d	L	hmin	X	f	
External	ER 16-10RD			EL 16-10RD			10	9.525	16	1.27	1.1	1.2	
	16-8RD	●		16-8RD			8	9.525	16	1.59	1.4	1.3	
	16-6RD	●		16-6RD			6	9.525	16	2.12	1.5	1.7	
	22-6RD			22-6RD			6	12.7	22	2.12	1.5	1.7	
	22-4RD	●		22-4RD			4	12.7	22	3.18	2.2	2.3	
	27-4RD			27-4RD			4	15.875	27	3.18	2.2	2.3	
Internal	IR 16-10RD			IL 16-10RD			10	9.525	16	1.27	1.1	1.2	
	16-8RD			16-8RD			8	9.525	16	1.59	1.4	1.4	
	16-6RD	●		16-6RD			6	9.525	16	2.12	1.4	1.5	
	22-6RD			22-6RD			6	12.7	22	2.12	1.5	1.7	
	22-4RD	●		22-4RD			4	12.7	22	3.18	2.2	2.3	
	27-4RD			27-4RD			4	15.875	27	3.18	2.2	2.3	

Applicable holders D31, D32

● : Stock item

## Trapezoidal DIN 103 (TR)

Type	Designation (Right)	PC3030T	PC9070T	Designation (Left)	PC3030T	PC9070T	Pitch (mm)	Dimensions (mm)					Picture
								d	L	hmin	X	f	
External	ER 11-1.5TR	●		EL 11-1.5TR	●		1.5	6.35	11	0.90	0.8	0.9	
	16-1.5TR			16-1.5TR			1.5	9.525	16	0.90	1.0	1.1	
	16-2.0TR	●		16-2.0TR	●		2.0	9.525	16	1.25	1.1	1.3	
	16-3.0TR	●	●	16-3.0TR	●		3.0	9.525	16	1.75	1.3	1.5	
	22-4.0TR	●	●	22-4.0TR	●		4.0	12.7	22	2.25	1.7	1.9	
	22-5.0TR	●	●	22-5.0TR	●		5.0	12.7	22	2.75	2.1	2.5	
	27-6.0TR	●	●	27-6.0TR	●		6.0	15.875	27	3.50	2.3	2.7	
Internal	IR 11-1.5TR			IL 11-1.5TR	●		1.5	6.35	11	0.90	0.8	0.9	
	16-1.5TR	●		16-1.5TR	●		1.5	9.525	16	0.90	1.0	1.1	
	16-2.0TR	●		16-2.0TR	●		2.0	9.525	16	1.25	1.1	1.3	
	16-2.5TR	●		16-2.5TR	●		2.5	9.525	16	1.53	1.2	1.4	
	16-3.0TR	●		16-3.0TR	●		3.0	9.525	16	1.75	1.3	1.5	
	22-4.0TR	●	●	22-4.0TR	●		4.0	12.7	22	2.25	1.7	1.9	
	22-5.0TR	●	●	22-5.0TR	●		5.0	12.7	22	2.75	2.1	2.5	
	27-6.0TR	●	●	27-6.0TR	●		6.0	15.875	27	3.50	2.3	2.7	

Applicable holders D31, D32

●: Stock item

## American ACME (ACME)

Type	Designation (Right)	PC3030T	PC9070T	Designation (Left)	PC3030T	PC9070T	Pitch (tpi)	Dimensions (mm)					Picture
								d	L	hmin	X	f	
External	ER 11-16ACME			EL 11-16ACME			16	6.35	11	0.92	1.0	1.1	
	16-16ACME			16-16ACME			16	9.525	16	0.92	1.0	1.1	
	16-14ACME			16-14ACME			14	9.525	16	1.03	1.0	1.2	
	16-12ACME			16-12ACME			12	9.525	16	1.19	1.1	1.2	
	16-10ACME			16-10ACME			10	9.525	16	1.52	1.3	1.4	
	16-8ACME			16-8ACME			8	9.525	16	1.84	1.4	1.5	
	16-6ACME			16-6ACME			6	9.525	16	2.37	1.7	1.9	
	22-6ACME	●		22-6ACME	●		6	12.7	22	2.37	1.8	2.1	
	22-5ACME	●		22-5ACME	●		5	12.7	22	2.79	2.0	2.3	
	27-4ACME			27-4ACME			4	15.875	27	3.43	2.4	2.7	
Internal	IR 11-16ACME			IL 11-16ACME			16	6.35	11	0.92	0.9	0.9	
	16-16ACME			16-16ACME			16	9.525	16	0.92	1.0	1.1	
	16-14ACME			16-14ACME			14	9.525	16	1.03	1.1	1.2	
	16-12ACME			16-12ACME			12	9.525	16	1.19	1.2	1.3	
	16-10ACME	●		16-10ACME			10	9.525	16	1.52	1.2	1.3	
	16-8ACME	●		16-8ACME			8	9.525	16	1.84	1.4	1.5	
	16-6ACME			16-6ACME			6	9.525	16	2.37	1.7	1.9	
	22-6ACME	●		22-6ACME			6	12.7	22	2.37	1.8	2.1	
	22-5ACME	●		22-5ACME			5	12.7	22	2.79	2.0	2.3	
	27-4ACME	●		27-4ACME			4	15.875	27	3.43	2.3	2.6	

Applicable holders D31, D32

●: Stock item



# Stub ACME (STACME)

Type	Designation (Right)		Designation (Left)			Pitch (tpi)	Dimensions (mm)					Picture	
	PC3030T	PC9070T		PC3030T	PC9070T		d	L	hmin	X	f		
External	ER	11-16STACME		EL	11-16STACME		16	6.35	11	0.60	1.0	1.0	
		16-16STACME			16-16STACME		16	9.525	16	0.60	1.0	1.0	
		16-14STACME			16-14STACME		14	9.525	16	0.67	1.1	1.1	
		16-12STACME			16-12STACME		12	9.525	16	0.76	1.2	1.2	
		16-10STACME			16-10STACME		10	9.525	16	1.02	1.2	1.3	
		16-8STACME			16-8STACME		8	9.525	16	1.21	1.4	1.5	
		16-6STACME			16-6STACME		6	9.525	16	1.52	1.7	1.8	
		22-6STACME			22-6STACME		6	12.7	22	1.52	1.7	1.8	
		22-5STACME			22-5STACME		5	12.7	22	1.78	2.1	2.3	
		27-4STACME			27-4STACME		4	15.875	27	2.16	2.3	2.4	
		27-3STACME			27-3STACME		3	15.875	27	2.79	2.9	2.9	
	Internal	IR	11-16STACME		IL	11-16STACME		16	6.35	11	0.60	1.0	
		16-16STACME			16-16STACME		16	9.525	16	0.60	1.0	1.0	
		16-14STACME			16-14STACME		14	9.525	16	0.67	1.1	1.1	
		16-12STACME			16-12STACME		12	9.525	16	0.76	1.1	1.2	
		16-10STACME			16-10STACME		10	9.525	16	1.02	1.2	1.3	
		16-8STACME			16-8STACME		8	9.525	16	1.21	1.4	1.5	
		16-6STACME			16-6STACME		6	9.525	16	1.52	1.7	1.8	
		22-6STACME			22-6STACME		6	12.7	22	1.52	1.7	1.8	
		22-5STACME			22-5STACME		5	12.7	22	1.78	2.1	2.3	
		27-4STACME			27-4STACME		4	15.875	27	2.16	2.3	2.4	
		27-3STACME			27-3STACME		3	15.875	27	2.79	2.9	2.9	

➤ Applicable holders D31, D32

● : Stock item

## UNJ (Unified Constant Thread)

Type	Designation (Right)		Designation (Left)	Pitch		Dimensions (mm)					Picture		
	PC3030T	PC9070T		PC3030T	PC9070T	(tpi)	d	L	hmin	X		f	
External	ER	11-48UNJ		EL	11-48UNJ		48	6.35	11	0.31	0.6	0.5	
		11-44UNJ			11-44UNJ		44	6.35	11	0.33	0.6	0.6	
		11-40UNJ			11-40UNJ		40	6.35	11	0.37	0.6	0.6	
		11-36UNJ			11-36UNJ		36	6.35	11	0.41	0.6	0.6	
		11-32UNJ			11-32UNJ		32	6.35	11	0.46	0.6	0.7	
		11-28UNJ			11-28UNJ		28	6.35	11	0.52	0.7	0.7	
		11-24UNJ	●		11-24UNJ		24	6.35	11	0.61	0.7	0.8	
		11-20UNJ			11-20UNJ		20	6.35	11	0.73	0.8	0.9	
		11-18UNJ			11-18UNJ		18	6.35	11	0.81	0.8	1.0	
		11-16UNJ			11-16UNJ		16	6.35	11	0.92	0.9	1.1	
		11-14UNJ			11-14UNJ		14	6.35	11	1.05	1.0	1.2	
		16-48UNJ			16-48UNJ		48	9.525	16	0.31	0.6	0.5	
		16-44UNJ			16-44UNJ		44	9.525	16	0.33	0.6	0.6	
		16-40UNJ			16-40UNJ		40	9.525	16	0.37	0.6	0.6	
		16-36UNJ			16-36UNJ		36	9.525	16	0.41	0.6	0.6	
		16-32UNJ	●		16-32UNJ		32	9.525	16	0.46	0.6	0.7	
		16-28UNJ	●		16-28UNJ		28	9.525	16	0.52	0.7	0.7	
		16-24UNJ	●		16-24UNJ		24	9.525	16	0.61	0.7	0.8	
		16-20UNJ	●		16-20UNJ		20	9.525	16	0.73	0.8	0.9	
		16-18UNJ			16-18UNJ		18	9.525	16	0.81	0.8	1.0	
		16-16UNJ	●		16-16UNJ		16	9.525	16	0.92	0.9	1.1	
		16-14UNJ			16-14UNJ		14	9.525	16	1.05	1.0	1.2	
		16-13UNJ			16-13UNJ		13	9.525	16	1.13	1.0	1.3	
		16-12UNJ	●		16-12UNJ		12	9.525	16	1.22	1.1	1.3	
		16-11UNJ			16-11UNJ		11	9.525	16	1.33	1.2	1.5	
		16-10UNJ			16-10UNJ	●	10	9.525	16	1.47	1.2	1.5	
		16-9UNJ			16-9UNJ		9	9.525	16	1.63	1.3	1.7	
		16-8UNJ			16-8UNJ		8	9.525	16	1.83	1.2	1.6	
		22-7UNJ			22-7UNJ		7	12.7	22	2.09	1.7	2.3	
		22-6UNJ			22-6UNJ		6	12.7	22	2.44	1.7	2.3	
		22-5UNJ			22-5UNJ		5	12.7	22	2.93	1.8	2.5	
		27-4.5UNJ			27-4.5UNJ		4.5	15.875	27	3.26	2.0	2.7	
		27-4UNJ			27-4UNJ		4	15.875	27	3.67	2.2	3.0	

➔ Applicable holders D31

●: Stock item





# UNJ (Unified Constant Thread)

Type	Designation (Right)	PC3030T	PC9070T	Designation (Left)	PC3030T	PC9070T	Pitch (tpi)	Dimensions (mm)					Picture
								d	L	hmin	X	f	
Internal	IR 11-48UNJ			IL 11-48UNJ			48	6.35	11	0.28	0.6	0.5	
	11-44UNJ			11-44UNJ			44	6.35	11	0.30	0.6	0.6	
	11-40UNJ			11-40UNJ			40	6.35	11	0.33	0.6	0.6	
	11-36UNJ			11-36UNJ			36	6.35	11	0.37	0.6	0.6	
	11-32UNJ			11-32UNJ			32	6.35	11	0.42	0.6	0.7	
	11-28UNJ			11-28UNJ			28	6.35	11	0.47	0.7	0.7	
	11-24UNJ			11-24UNJ			24	6.35	11	0.55	0.7	0.8	
	11-20UNJ			11-20UNJ			20	6.35	11	0.66	0.8	0.9	
	11-18UNJ			11-18UNJ			18	6.35	11	0.74	0.8	1.0	
	11-16UNJ			11-16UNJ			16	6.35	11	0.83	0.9	1.1	
	11-14UNJ			11-14UNJ			14	9.525	11	0.95	1.0	1.2	
	16-48UNJ			16-48UNJ			48	9.525	16	0.28	0.6	0.5	
	16-44UNJ			16-44UNJ			44	9.525	16	0.30	0.6	0.6	
	16-40UNJ			16-40UNJ			40	9.525	16	0.33	0.6	0.6	
	16-36UNJ			16-36UNJ			36	9.525	16	0.37	0.6	0.6	
	16-32UNJ			16-32UNJ			32	9.525	16	0.42	0.6	0.7	
	16-28UNJ			16-28UNJ			28	9.525	16	0.47	0.7	0.7	
	16-24UNJ			16-24UNJ			24	9.525	16	0.55	0.7	0.8	
	16-20UNJ			16-20UNJ			20	9.525	16	0.66	0.8	0.9	
	16-18UNJ			16-18UNJ			18	9.555	16	0.74	0.8	1.0	
	16-16UNJ			16-16UNJ			16	9.525	16	0.83	0.9	1.1	
	16-14UNJ			16-14UNJ			14	9.525	16	0.95	1.0	1.2	
	16-13UNJ			16-13UNJ			13	9.525	16	1.02	1.0	1.3	
	16-12UNJ			16-12UNJ	●		12	9.525	16	1.11	1.1	1.3	
	16-11UNJ			16-11UNJ			11	9.525	16	1.21	1.2	1.5	
	16-10UNJ			16-10UNJ			10	9.525	16	1.33	1.2	1.5	
	16-9UNJ			16-9UNJ			9	9.525	16	1.48	1.3	1.7	
	16-8UNJ			16-8UNJ			8	9.525	16	1.66	1.2	1.6	
	22-7UNJ			22-7UNJ			7	12.7	22	1.90	1.7	2.3	
	22-6UNJ			22-6UNJ			6	12.7	22	2.21	1.7	2.3	
	22-5UNJ			22-5UNJ			5	12.7	22	2.66	1.8	2.5	
	27-4.5UNJ			27-4.5UNJ			4.5	15.875	27	2.95	2.0	2.7	
	27-4UNJ			27-4UNJ			4	15.875	27	3.32	2.2	3.0	

➔ Applicable holders D32

● : Stock item

## American Buttress (ABUT)

Type	Designation (Right)	PC3030T	PC9070T	Designation (Left)	PC3030T	PC9070T	Pitch (tpi)	Dimensions (mm)					Picture
								d	L	hmin	X	f	
External	ER 11-20ABUT			EL 11-20ABUT			20	6.35	11	0.84	1.0	1.4	
	11-16ABUT			11-16ABUT			16	6.35	11	1.05	1.3	1.9	
	16-20ABUT	●		16-20ABUT			20	9.525	16	0.84	1.0	1.4	
	16-16ABUT			16-16ABUT			16	9.525	16	1.05	1.3	1.9	
	16-12ABUT			16-12ABUT			12	9.525	16	1.40	1.4	2.0	
	16-10ABUT			16-10ABUT			10	9.525	16	1.68	1.5	2.3	
	22-8ABUT			22-8ABUT			8	12.7	22	2.10	2.0	3.2	
	22-6ABUT			22-6ABUT			6	12.7	22	2.80	2.2	3.5	
Internal	IR 11-20ABUT	●		IL 11-20ABUT			20	6.35	11	0.84	1.0	1.4	
	11-16ABUT			11-16ABUT			16	6.35	11	1.05	1.3	1.9	
	16-20ABUT	●		16-20ABUT			20	9.525	16	0.84	1.0	1.4	
	16-16ABUT			16-16ABUT			16	9.525	16	1.05	1.3	1.9	
	16-12ABUT	●		16-12ABUT			12	9.525	16	1.40	1.4	2.0	
	16-10ABUT	●		16-10ABUT			10	9.525	16	1.68	1.5	2.3	
	22-8ABUT			22-8ABUT			8	12.7	22	2.10	2.0	3.2	
	22-6ABUT			22-6ABUT			6	12.7	22	2.80	2.2	3.5	

Applicable holders D31, D32

●: Stock item

## British Buttress (BBUT)

Type	Designation (Right)	PC3030T	PC9070T	Designation (Left)	PC3030T	PC9070T	Pitch (tpi)	Dimensions (mm)					Picture
								d	L	hmin	X	f	
External	ER 16-16BBUT	●		EL 16-16BBUT			16	9.525	16	0.80	1.1	1.6	
	16-12BBUT			16-12BBUT			12	9.525	16	1.07	1.4	2.1	
	16-10BBUT			16-10BBUT			10	9.525	16	1.28	1.4	2.2	
	16-8BBUT	●		16-8BBUT			8	9.525	16	1.61	1.6	2.5	
	22-8BBUT			22-8BBUT			8	12.7	22	1.61	1.6	2.5	
Internal	IR 16-16BBUT	●		IL 16-16BBUT			16	9.525	16	0.80	1.1	1.6	
	16-12BBUT			16-12BBUT			12	9.525	16	1.07	1.4	2.1	
	16-10BBUT			16-10BBUT			10	9.525	16	1.28	1.4	2.2	
	16-8BBUT			16-8BBUT			8	9.525	16	1.61	1.6	2.5	
	22-8BBUT			22-8BBUT			8	12.7	22	1.61	1.6	2.5	

Applicable holders D31, D32

●: Stock item



## Metric Buttress (SAGE)

Type	Designation (Right)	PC3030T	PC9070T	Designation (Left)	PC3030T	PC9070T	Pitch (mm)	Dimensions (mm)					Picture
								d	L	hmin	X	f	
External	ER 16-2.0SAGE			EL 16-2.0SAGE			2.0	9.525	16	1.74	1.47	2.08	
	22-2.0SAGE			22-2.0SAGE			2.0	12.7	22	1.74	1.47	2.08	
	22-3.0SAGE	●		22-3.0SAGE			3.0	12.7	22	2.60	1.79	2.60	
	27-4.0SAGE	●		27-4.0SAGE			4.0	15.875	27	3.55	1.93	3.20	
Internal	IR 16-2.0SAGE	●		IL 16-2.0SAGE			2.0	9.525	16	1.50	1.52	2.2	
	22-3.0SAGE			22-3.0SAGE			3.0	12.7	22	2.25	1.66	2.9	
	27-4.0SAGE	●		27-4.0SAGE			4.0	5/8	27	3.09	2.12	3.2	

➔ Applicable holders D31, D32

● : Stock item

## API

Type	Designation (Right)	PC3030T	PC9070T	Designation (Left)	PC3030T	PC9070T	Pitch (tpi)	Dimensions (mm)					Picture
								d	L	hmin	X	f	
External	ER 22-4API382	●		EL 22-4API382			4	12.7	22	3.09	2.1	2.8	
	22-4API383			22-4API383			4	12.7	22	3.08	2.1	2.8	
	22-4API502	●		22-4API502			4	12.7	22	3.75	2.0	2.9	
	22-4API503	●		22-4API503			4	12.7	22	3.74	2.0	2.9	
	22-5API403			22-5API403			5	12.7	22	2.99	1.8	2.6	
	22-6API551			22-6API551			6	12.7	22	1.41	2.6	2.0	
	27-4API382	●		27-4API382			4	15.875	27	3.09	2.1	2.8	
	27-4API383			27-4API383			4	15.875	27	3.08	2.1	2.8	
	27-4API502			27-4API502			4	15.875	27	3.75	2.1	3.1	
	27-4API503	●		27-4API503			4	15.875	27	3.74	2.1	3.1	
27-5API403	●		27-5API403			5	15.875	27	2.99	1.9	2.7		
Internal	IR 22-4API382			IL 22-4API382			4	12.7	22	3.09	2.1	2.8	
	22-4API383			22-4API383			4	12.7	22	3.08	2.1	2.8	
	22-4API502	●		22-4API502			4	12.7	22	3.75	2.1	3.1	
	22-4API503			22-4API503			4	12.7	22	3.74	2.0	2.9	
	22-5API403	●		22-5API403			5	12.7	22	2.99	1.8	2.6	
	22-6API551	●		22-6API551			6	12.7	22	1.41	2.6	2.0	
	27-4API382			27-4API382			4	15.875	27	3.09	2.1	2.8	
	27-4API383	●		27-4API383			4	15.875	27	3.08	2.1	2.8	
	27-4API502	●		27-4API502			4	15.875	27	3.75	2.1	3.1	
	27-4API503	●		27-4API503			4	15.875	27	3.74	2.1	3.1	
27-5API403	●		27-5API403			5	15.875	27	2.99	1.9	2.7		

➔ Applicable holders D31, D32

● : Stock item

## API Buttress Casing (BUT)

Type	Designation (Right)	PC3030T	PC9070T	Designation (Left)	PC3030T	PC9070T	Pitch (tpi)	Dimensions (mm)					Picture	
								IPF	d	L	hmin	X		f
External	ER 22-5BUT75	●		EL 22-5BUT75			5	0.75	12.7	22	1.55	3.1	1.9	
	22-5BUT1			22-5BUT1			5	1	12.7	22	1.55	3.1	1.9	
Internal	IR 22-5BUT75	●		IL 22-5BUT75			5	0.75	12.7	22	1.55	2.8	1.9	
	22-5BUT1	●		22-5BUT1			5	1	12.7	22	1.55	2.8	1.9	

Applicable holders D31, D32

●: Stock item

## API Round Casing & Tubing (APIRD)

Type	Designation (Right)	PC3030T	PC9070T	Designation (Left)	PC3030T	PC9070T	Pitch (tpi)	Dimensions (mm)					Picture
								d	L	hmin	X	f	
External	ER 16-10APIRD	●		EL 16-10APIRD			10	9.525	16	1.41	1.2	1.4	
	16-8APIRD	●		16-8APIRD			8	9.525	16	1.81	1.3	1.5	
Internal	IR 16-10APIRD	●		IL 16-10APIRD			10	9.525	16	1.41	1.2	1.4	
	16-8APIRD	●		16-8APIRD			8	9.525	16	1.81	1.3	1.5	

Applicable holders D31, D32

●: Stock item

## Extreme Line Casing (EL)

Type	Designation (Right)	PC3030T	PC9070T	Designation (Left)	PC3030T	PC9070T	Pitch (tpi)	Dimensions (mm)					Picture	
								IPF	d	L	hmin	X		f
External	ER 22-6EL15			EL 22-6EL15			6	1.5	12.7	22	1.21	1.9	1.9	
	22-5EL125			22-5EL125			5	1.25	12.7	22	1.71	2.3	2.4	
Internal	IR 22-6EL15			IL 22-6EL15			6	1.5	12.7	22	1.39	1.8	1.9	
	22-5EL125			22-5EL125			5	1.25	12.7	22	1.91	2.2	2.4	

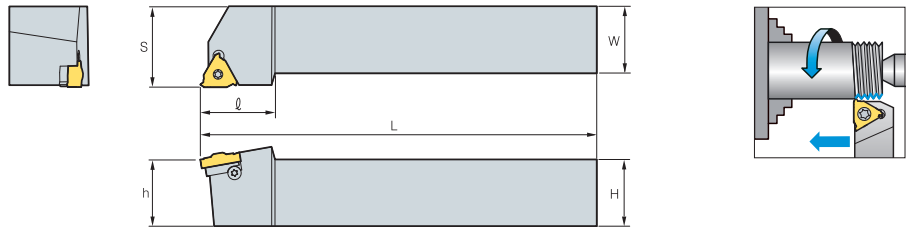
Applicable holders D31, D32

●: Stock item



# ER(L)H

(Screw on system)



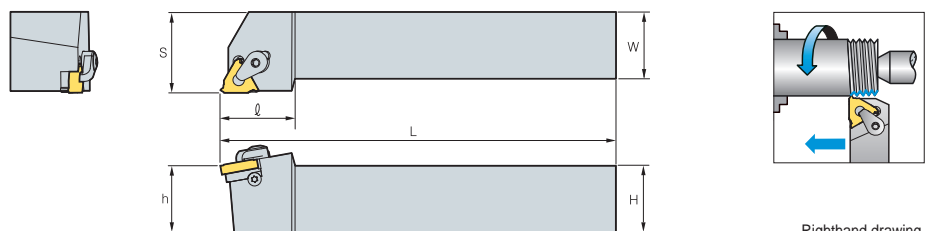
Righthand drawing (mm)

Designation	Inscribed circle	H	W	L	S	H	ℓ	Insert screw	Shim screw	Screw RH	Screw LH	Wrench	
ER(L)H	08N-11	6.35	8	8	136.4	11	8	17.5					
	10N-11	6.35	10	10	70.0	11	10	17.5	ST11N	-	-	-	TW08P
	12N-11	6.35	12	12	80.0	12	12	17.5					
	12N-16	9.525	12	12	83.2	16	12	22	ST16N	-	-	-	TW10P
	09-16	9.525	9.52	9.52	63.6	16	9.52	20.5					
	12-16	9.525	12	12	83.2	16	12	22					
	16-16	9.525	16	16	100.0	16	16	20.5	ST16	STA16	ATE16	ATI22	TW10P
	20-16	9.525	20	20	128.6	20	20	30					
	25-16	9.525	25	25	153.6	25	25	30					
	32-16	9.525	32	32	173.6	32	32	30					
	25-22	12.7	25	25	155.7	25	25	36					
	32-22	12.7	32	32	175.7	32	32	36	ST22	STA22	ATE22	ATI22	TW20P
	40-22	12.7	40	40	205.7	40	40	36					
	25-27	15.875	25	25	151.6	32	25	35					
	32-27	15.875	32	32	176.6	32	32	40	ST27	STA27	ATE27	ATI27	TW25L
	40-27	15.875	40	40	206.6	40	40	40					
50-27	15.875	50	50	256.6	50	50	40						

↻ Applicable inserts D10-D13, D16, D18, D19, D22, D23-D26 • Helix angle is 1.5° for all holders • No shim needed for N type holder

# ER(L)H-C

(Clamp on system)

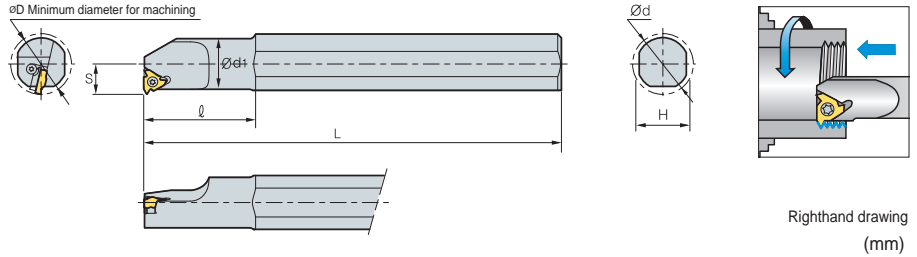


Righthand drawing (mm)

Designation	Inscribed circle	H	W	L	S	H	ℓ	Shim screw	Clamp	Screw RH	Screw LH	Wrench	
ER(L)H	20-16C	9.525	20	20	128.6	20	20	30					
	25-16C	9.525	25	25	153.6	25	25	30	STA16	CTH16	ATE16	ATI16	TW10P
	32-16C	9.525	32	32	173.6	32	32	30					TW15P
	25-22C	12.7	25	25	155.7	25	25	36					
	32-22C	12.7	32	32	175.7	32	32	36	STA22	CTH22	ATE22	ATI22	TW20P
	40-22C	12.7	40	40	205.7	40	40	36					
	25-27C	15.875	25	25	151.6	25	25	35					
	32-27C	15.875	32	32	176.6	32	32	40	STA27	CTH27	ATE27	ATI27	TW25L
	40-27C	15.875	40	40	206.6	40	40	40					
	50-27C	15.875	50	50	256.6	50	50	40					

↻ Applicable inserts D10-D13, D16, D18, D19, D22, D23-D26 • Helix angle is 1.5° for all holders

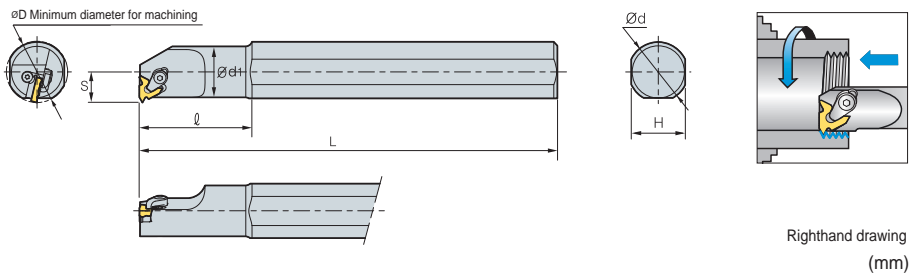
## IR(L)H (Screw on system)



Designation	Inscribed circle	ØD	Ød	Ød1	H	L	S	l	Insert screw	Shim screw	Screw RH	Screw LH	Wrench
IR(L)H	10DN-11	6.35	13	10	10.0	9.5	100	7.3	-	-	-	-	-
	10N-11	6.35	13	20	10.0	18.0	180	7.3	ST11N	-	-	-	TW08P
	13N-11	6.35	16	20	13.0	18.0	180	8.9	-	-	-	-	-
	13N-16	9.525	17	20	12.7	18.0	180	10.3	-	-	-	-	-
	16N-16	9.525	20	20	16.0	18.0	180	11.5	ST16N	-	-	-	TW10P
	16DN-16	9.525	20	16	16.0	15.2	150	11.3	-	-	-	-	-
	20-16	9.525	24	20	20.0	18.0	180	13.4	-	-	-	-	-
	25-16	9.525	29	32	25.0	29.0	250	16.3	-	-	-	-	-
	25D-16	9.525	29	25	24.5	22.6	200	16.1	ST16	STA16	ATI16	ATE16	TW10P
	32-16	9.525	36	32	32.0	29.0	250	19.6	-	-	-	-	-
	40-16	9.525	44	40	40.0	36.0	300	23.8	-	-	-	-	-
	20N-22	12.7	27	20	20.0	18.0	180	15.6	ST22N	-	-	-	TW20P
	25-22	12.7	32	32	25.0	29.0	250	17.4	-	-	-	-	-
	25D-22	12.7	32	25	24.6	22.6	200	17.2	ST22	STA22	ATI22	ATE22	TW20P
	32-22	12.7	39	32	32.0	29.0	250	21.5	-	-	-	-	-
40-22	12.7	47	40	40.0	36.0	300	25.8	-	-	-	-	-	
32-27	15.875	40	32	32.0	29.0	250	22.4	-	-	-	-	-	
40-27	15.875	48	40	40.0	36.0	300	26.4	-	-	-	-	-	
50-27	15.875	58	50	50.0	45.0	350	31.4	-	-	-	-	-	
60-27	15.875	69	60	60.0	54.0	400	36.4	ST27	STA27	ATI27	ATE27	TW25L	

➔ Applicable inserts D10, D11, D14, D15, D17, D20-D25, D27-D30 • Helix angle is 1.5° for all holders • No shim needed for N type holder

## IR(L)H-C (Clamp on system)



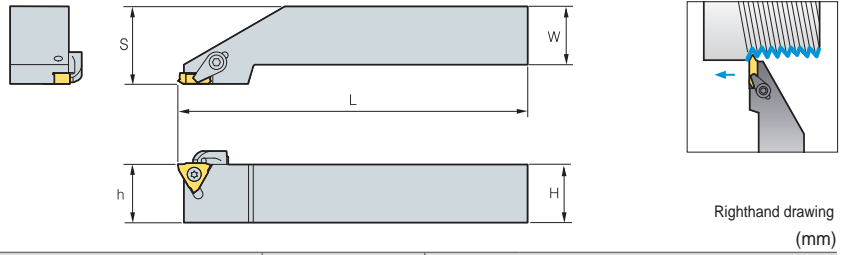
Designation	Inscribed circle	ØD	Ød	Ød1	H	L	S	l	Shim screw	Clamp	Screw RH	Screw LH	Wrench
IR(L)H	20-16C	9.525	24	20	20.0	18.0	13.4	50	-	-	-	-	-
	25-16C	9.525	29	32	25.0	28.0	250	16.3	STA16	CTH16	ATI16	ATE16	TW10P TW15P
	25D-16C	9.525	29	25	24.6	22.6	200	16.1	-	-	-	-	-
	32-16C	9.525	36	32	32.0	29.0	250	19.6	-	-	-	-	-
	40-16C	9.525	44	40	40.0	36.0	300	23.8	-	-	-	-	-
	25-22C	12.7	32	32	25.0	29.0	250	17.4	-	-	-	-	-
	25D-22C	12.7	32	25	24.6	22.6	200	17.2	-	-	-	-	-
	32-22C	12.7	39	32	32.0	29.0	250	21.5	STA22	CTH22	ATI22	ATE22	TW20P
	40-22C	12.7	47	40	40.0	36.0	300	25.8	-	-	-	-	-
	32-27C	15.875	40	32	32.0	29.0	250	22.4	-	-	-	-	-
	40-27C	15.875	48	40	40.0	36.0	300	26.4	-	-	-	-	-
	50-27C	15.875	58	50	50.0	45.0	350	31.4	-	-	-	-	-
	60-27C	15.875	69	60	60.5	54.0	400	36.4	STA27	CTH27	ATI27	ATE27	TW25L

➔ Applicable inserts D10, D11, D14, D15, D17, D20-D25, D27-D30 • Helix angle is 1.5° for all holders

## VTH



VETR



Designation	H = (h)	W	L	S	Insert	Clamp	Clamp screw	Screw	Wrench	
VTH	2020R	20	20	125	26.4	VETR	CS6R1	DHA0617	FTKA03510	TW15P HW30L
	2525R	25	25	150	33.4					
	3225R	32	25	170	33.4					

## Vertical type thread insert

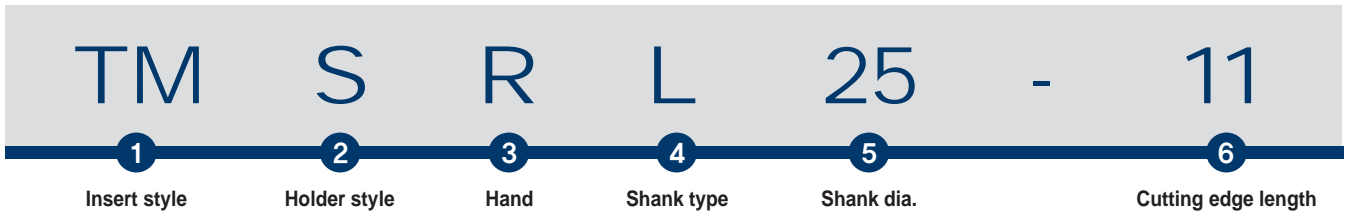
Picture	Designation	Uncoated	Insert			Configuration
		ST10	Pitch (mm)	$\theta$	f	
	VETR 080		0.8	60°	1.4	<p>d: 9.525 t: 4.76</p>
	100	●	1.0	60°	1.4	
	125		1.25	60°	1.4	
	150	●	1.5	60°	1.2	
	175		1.75	60°	1.2	
	200	●	2.0	60°	1.2	
	250		2.5	60°	1.4	
	300	●	3.0	60°	1.6	
	150F	●	0.8~1.5	60°	1.4	
	300F	●	1.5~3.0	60°	1.6	

● : Stock item



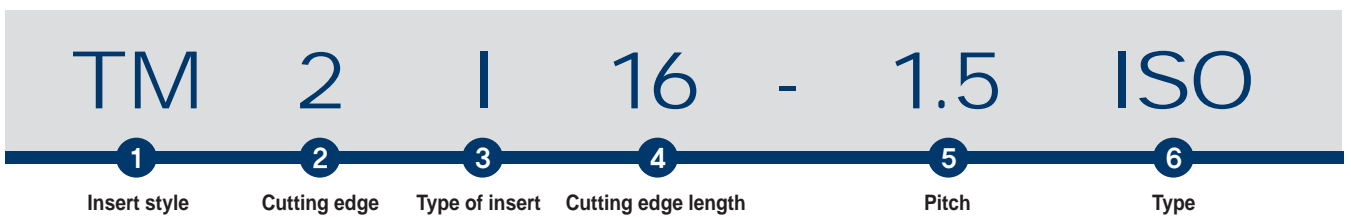
# D Technical Information for Thread Milling

## Thread milling holders code system



<p><b>1</b> Insert style</p> <p>TM S R L 25 - 11</p> <p>Thread Milling Holder</p>	<p><b>3</b> Hand</p> <p>TM S R L 25 - 11</p> <p>R: Right Hand    L: Left Hand</p>	<p><b>5</b> Shank dia.</p> <p>TM S R L 25 - 11</p> <p>25: 25.0</p>						
<p><b>2</b> Holders style</p> <p>TM S R L 25 - 11</p> <p>S: Shank Type</p>	<p><b>4</b> Shank type</p> <p>TM S R L 25 - 11</p> <p>None: Standard L: Long Type T: Taper Type</p>	<p><b>6</b> Cutting edge length</p> <p>TM S R L 25 - 11</p> <table border="0"> <tr> <td>10: 10.4</td> <td>22: 22</td> </tr> <tr> <td>11: 11</td> <td>27: 27</td> </tr> <tr> <td>16: 16</td> <td>38: 38.5</td> </tr> </table>	10: 10.4	22: 22	11: 11	27: 27	16: 16	38: 38.5
10: 10.4	22: 22							
11: 11	27: 27							
16: 16	38: 38.5							

## Thread milling inserts code system



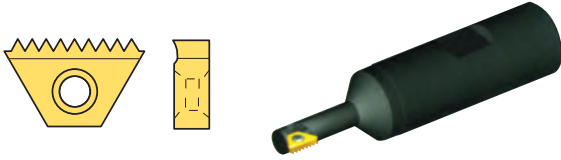
<p><b>1</b> Insert style</p> <p>TM 2 I 16 - 1.5 ISO</p> <p>Thread Milling Holder</p>	<p><b>4</b> Cutting edge length</p> <p>TM 2 I 16 - 1.5 ISO</p> <p>10: 10.4 11: 11 16: 16 22: 22 27: 27 38: 38.5</p>	<p><b>6</b> Type</p> <p>TM 2 I 16 - 1.5 ISO</p> <p>ISO Metric American UN (UNC, UNF, UNEF) UNJ Whit Worth (BSW, BSF, BSP, BSB) National Pipe Thread (NPT) National Pipe Thread (NPTF) British Standard Pipe Thread (BSPT)</p>
<p><b>2</b> Cutting edge</p> <p>TM 2 I 16 - 1.5 ISO</p> <p>None: 1 cutting edge 2: 2 cutting edge</p>	<p><b>5</b> Pitch</p> <p>TM 2 I 16 - 1.5 ISO</p> <p>mm: 0.5~6.0      tpi: 48~6</p>	
<p><b>3</b> Type of insert</p> <p>TM 2 I 16 - 1.5 ISO</p> <p>I: Internal E: External EI: External &amp; Internal</p>		



## Thread milling

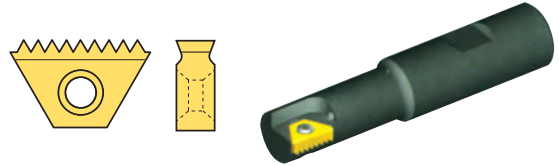
### ➤ The right tool for the job

#### Small diameter type



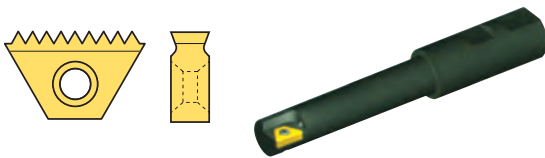
**Tool holder:** TMSR **Insert:** TM L = 10.4 mm  
For small bore diameters down to 9.5 mm

#### Standard type



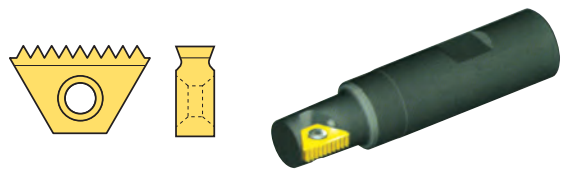
**Tool holder:** TMSR **Insert:** TM2  
For standard length threads

#### Long type



**Tool holder:** TMSR **Insert:** TM2  
For long or remote threads

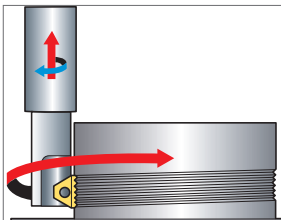
#### Tapered type



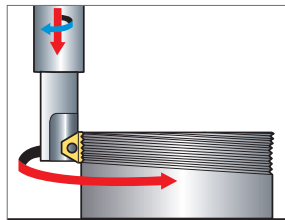
**Tool holder:** TMSR **Insert:** TM2 (BSPT, NPT, NPTF)  
For standard length threads

### ➤ Thread milling methods

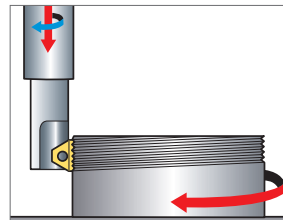
#### External threading



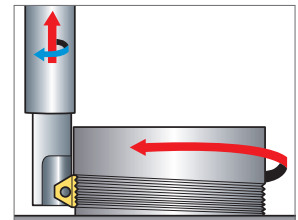
Right handed thread  
conventional milling



Left handed thread  
down milling

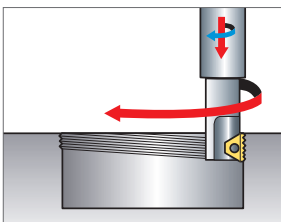


Right handed thread  
down milling

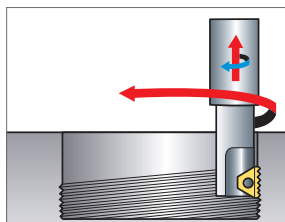


Left handed thread  
conventional milling

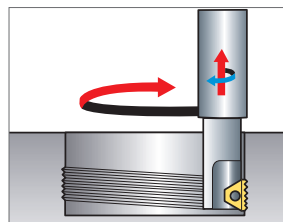
#### Internal threading



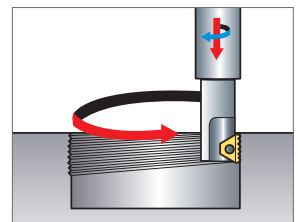
Right handed thread  
down milling



Left handed thread  
conventional milling



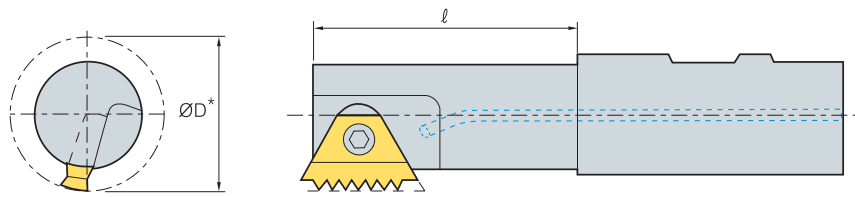
Right handed thread  
conventional milling



Left handed thread  
down milling

# D Technical Information for Thread Milling

## Tooling recommendation for given internal thread specification

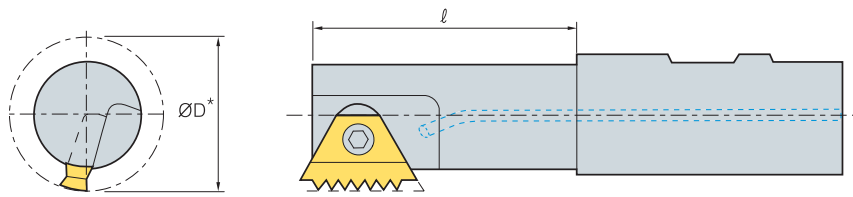


### ISO

Pitch (mm)	Nominal dia. (mm)	Holder	Insert	ℓ-Tool holder overhang	D-Tool cutting dia.*	Min.Thread depth (Profile depth)
0.75	11	TMSR 12-10	TM2I 10-0.75ISO	12.0	9.0	0.43
1.0	12-14	TMSR 12-10	TM2I 10-1.0ISO	12.0	9.0	0.58
	15-18	TMSR 12-11	TM2I 11-1.0ISO	12.0	11.5	
	20	TMSR 16-16	TM2I 16-1.0ISO	22.0	17.0	
	22	TMSR 20-22	TM2I 22-1.0ISO	29.0	19.0	
	24	TMSR 20-16	TM2I 16-1.0ISO	43.0	20.0	
	25-28	TMSRL 25-16	TM2I 16-1.0ISO	25.0	22.0	
1.25	14	TMSR 12-10	TM2I 10-1.25ISO	12.0	9.0	0.72
1.5	14-15	TMSR 12-10	TM2I 10-1.5ISO	12.0	9.0	0.87
	16-20	TMSR 12-11	TM2I 11-1.5ISO	12.0	11.5	
	22	TMSR 16-16	TM2I 16-1.5ISO	22.0	17.0	
	24	TMSR 20-22	TM2I 22-1.5ISO	29.0	19.0	
	25-26	TMSR 20-16	TM2I 16-1.5ISO	43.0	20.0	
	27-30	TMSRL 25-16	TM2I 16-1.5ISO	25.0	22.0	
	35-42	TMSR 25-27	TM2I 27-1.5ISO	52.0	30.0	
	45	TMSR 32-27	TM2I 27-1.5ISO	58.0	37.0	
2.0	22	TMSRT 16-16	TM2I16-2.0ISO	22.0	15.5	1.15
	24	TMSR 16-16	TM2I 16-2.0ISO	22.0	17.0	
	25	TMSR 20-22	TM2I 22-2.0ISO	29.0	19.0	
	27	TMSR 20-16	TM2I 16-2.0ISO	43.0	20.0	
	28-32	TMSRL 25-16	TM2I 16-2.0ISO	25.0	22.0	
	39-42	TMSR 25-27	TM2I 27-2.0ISO	52.0	30.0	
	45-48	TMSR 32-27	TM2I 27-2.0ISO	58.0	37.0	
3.0	42-48	TMSR 25-27	TM2I 27-3.0ISO	52.0	30.0	1.73
	50-52	TMSR 32-27	TM2I 27-3.0ISO	58.0	37.0	
	45-52	TMSR 25-27	TM2I 27-4.0ISO	52.0	30.0	
4.0	55	TMSR 32-38	TM2I 38-4.0ISO	55.0	35.0	2.31
	56-58	TMSR 32-27	TM2I 27-4.0ISO	58.0	37.0	
	60-65	TMSR 40-38	TM2I 38-4.0ISO	65.0	46.0	
	48-52	TMSR 32-38	TM2I 38-5.0ISO	55.0	35.0	
5.0	48-52	TMSR 32-38	TM2I 38-5.0ISO	55.0	35.0	2.89
5.5	56	TMSR 32-38	TM2I 38-5.5ISO	55.0	35.0	3.17
	60	TMSR 40-38	TM2I 38-5.5ISO	65.0	46.0	
6.0	64-68	TMSR 40-38	TM2I 38-6.0ISO	65.0	46.0	3.46

• The recommended holder is the largest for the given thread specification  
 \* Holder with smaller or equal cutting diameters (D2) can also be used

## Tooling recommendation for given internal thread specification



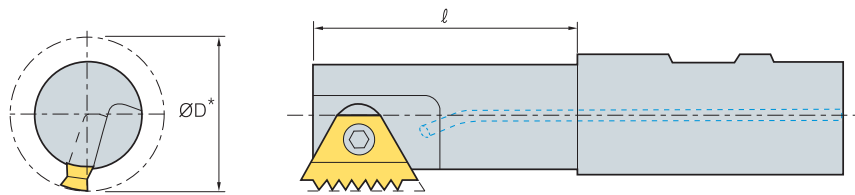
**UN**

Pitch (tpi)	Nominal dia. (inch)	Holder	Insert	ℓ-Tool holder overhang	D-Tool cutting dia.*	Min.Thread depth (Profile depth)
32	7/16-1/2	TMSR 12-10	TMI 10-32UN	12.0	9.0	0.46
	9/16-11/16	TMSR 12-11	TM2I 11-32UN	12.0	11.5	
	3/4-13/16	TMSR 16-16	TM2I 16-32UN	22.0	17.0	
	7/8-15/16	TMSR 20-16	TM2I 16-32UN	43.0	20.0	
28	1	TMSR 25-16	TM2I 16-32UN	25.0	22.0	0.52
	7/16-1/2	TMSR 12-10	TMI 10-28UN	12.0	9.0	
	9/16-3/4	TMSR 12-11	TM2I 11-28UN	12.0	11.5	
	13/16-7/8	TMSR 16-16	TM2I 16-28UN	22.0	17.0	
	15/16	TMSR 20-16	TM2I 16-28UN	43.0	20.0	
24	1-1 1/8	TMSRL 25-16	TM2I 16-28UN	25.0	22.0	0.61
	9/16-11/16	TMSR 12-11	TM2I 11-24UN	12.0	11.5	
20	1/2-9/16	TMSR 12-10	TMI 10-20UN	12.0	9.0	0.73
	5/8-13/16	TMSR 12-11	TM2I 11-20UN	12.0	11.5	
	7/8	TMSR 16-16	TM2I 16-20UN	22.0	17.0	
	15/16-1	TMSR 20-16	TM2I 16-20UN	43.0	20.0	
	1 1/16-1 1/8	TMSRL 25-16	TM2I 16-20UN	25.0	22.0	
	1 3/8-1 5/8	TMSR 25-27	TM2I 27-20UN	52.0	30.0	
18	1 11/16-1 13/16	TMSR 32-27	TM2I 27-20UN	28.0	37.0	0.81
	5/8	TMSR 12-11	TM2I 11-18UN	12.0	11.5	
	1 1/16-1 3/16	TMSRL 25-16	TM2I 16-18UN	25.0	22.0	
	1 7/16-1 5/8	TMSR 25-27	TM2I 27-18UN	52.0	30.0	
16	1 11/16	TMSR 32-27	TM2I 27-18UN	58.0	37.0	0.92
	11/16-13/16	TMSR 12-11	TM2I 11-16UN	12.0	11.5	
	7/8-15/16	TMSR 16-16	TM2I 16-16UN	22.0	17.0	
	1	TMSR 20-16	TM2I 16-16UN	43.0	20.0	
	1 1/16-1 3/16	TMSRL 25-16	TM2I 16-16UN	25.0	22.0	
	1 7/16-1 5/8	TMSR 25-27	TM2I 27-16UN	52.0	30.0	
14	1 11/16-1 7/8	TMSR 32-27	TM2I 27-16UN	58.0	37.0	1.05
	7/8	TMSR 12-11	TM2I 11-14UN	12.0	11.5	
12	7/8	TMSRT 16-16	TM2I 16-12UN	22.0	15.5	1.22
	15/16	TMSR 16-16	TM2I 16-12UN	22.0	17.0	
	1	TMSR 20-22	TM2I 22-12UN	29.0	19.0	
	1 1/16	TMSR 20-16	TM2I 16-12UN	43.0	20.0	
	1 1/8-1 1/4	TMSRL 25-16	TM2I 16-12UN	25.0	22.0	
	1 1/2-1 11/16	TMSR 25-27	TM2I 27-12UN	52.0	30.0	
	1 3/4-1 15/16	TMSR 32-27	TM2I 27-12UN	58.0	37.0	
8	1 11/16-1 15/16	TMSR 25-27	TM2I 27-8UN	52.0	30.0	1.83
	2-1 1/8	TMSR 32-27	TM2I 27-8UN	58.0	37.0	
6	2-2 1/8	TMSR 25-27	TM2I 27-6UN	52.0	30.0	2.44
	2 1/4	TMSR 32-27	TM2I 27-6UN	58.0	37.0	
	2 3/8-2 1/2	TMSR 40-38	TM2I 38-6UN	65.0	46.0	
4.5	2-2 1/4	TMSR 32-38	TM2I 38-4.5UN	55.0	35.0	3.26
4	2 1/2	TMSR 40-38	TM2I 38-4UN	65.0	46.0	3.67

• The recommended holder is the largest for the given thread specification  
 \* Holder with smaller or equal cutting diameters (D2) can also be used

# D Technical Information for Thread Milling

## Tooling recommendation for given internal thread specification



### UNJ

Pitch (tpi)	Nominal dia. (inch)	Holder	Insert	ℓ-Tool holder overhang	D-Tool cutting dia.*	Min.Thread depth (Profile depth)
24	9/16-11/16	TMSR 12-11	TM2I 11-24UNJ	12.0	11.5	0.55
20	1/2	TMSR 12-10	TMI 10-20UNJ	12.0	9.0	0.66
	3/4-13/16	TMSR 12-11	TM2I 11-20UNJ	12.0	11.5	
	7/8	TMSR 16-16	TM2I 16-20UNJ	22.0	17.0	
	15/16-1	TMSR 20-16	TM2I 16-20UNJ	43.0	20.0	
18	5/8	TMSR 12-11	TM2I 11-18UNJ	12.0	11.5	0.74
	1 1/16-1 3/16	TMSRL 25-16	TM2I 16-18UNJ	25.0	22.0	
16	11/16-13/16	TMSR 12-11	TM2I 11-16UNJ	12.0	11.5	0.83
	7/8-15/16	TMSR 16-16	TM2I 16-16UNJ	22.0	17.0	
	1	TMSR 20-16	TM2I 16-16UNJ	43.0	20.0	
	1 1/16-1 3/16	TMSRL 25-16	TM2I 16-16UNJ	25.0	22.0	
	1 7/16-1 5/8	TMSR 25-27	TM2I 27-16UNJ	52.0	30.0	
	1 11/16-1 7/8	TMSR 32-27	TM2I 27-16UNJ	58.0	37.0	
14	7/8	TMSR 12-11	TM2I 11-14UNJ	12.0	11.5	0.95
12	7/8	TMSRT 16-16	TM2I 16-12UNJ	22.0	15.5	1.11
	15/16-1	TMSR 16-16	TM2I 16-12UNJ	22.0	17.0	
	1 1/16	TMSR 20-16	TM2I 16-12UNJ	43.0	20.0	
	1 1/8-1 1/4	TMSRL 25-16	TM2I 16-12UNJ	25.0	22.0	
	1 1/2-1 11/16	TMSR 25-27	TM2I 27-12UNJ	52.0	30.0	
	1 3/4-1 15/16	TMSR 32-27	TM2I 27-12UNJ	58.0	37.0	

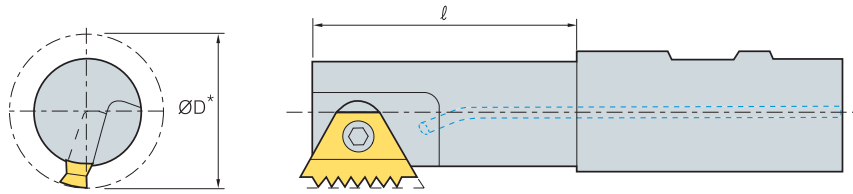
### W

Pitch (tpi)	Nominal dia. (inch)	Holder	Insert	ℓ-Tool holder overhang	D-Tool cutting dia.*	Min.Thread depth (Profile depth)
26	1/2-9/16	TMSR 12-10	TMEI 10-26W	12.0	9.0	0.63
	5/8-3/4	TMSR 12-11	TM2EI 11-26 W	12.0	11.5	
	13/16-7/8	TMSR 16-16	TM2EI 16-26W	22.0	17.0	
	15/16-1	TMSR 20-16	TM2EI 16-26W	43.0	20.0	
20	1 1/16-1 1/8	TMSRL 25-16	TM2EI 16-26W	25.0	22.0	0.81
	9/16	TMSR 12-10	TM2EI 10-20W	12.0	9.0	
	5/8-13/16	TMSR 12-11	TM2EI 11-20W	12.0	11.5	
	7/8-15/16	TMSR 16-16	TM2EI 16-20W	22.0	17.0	
	1	TMSR 20-16	TM2EI 16-20W	43.0	20.0	
16	1 1/16-1 3/16	TMSRL 25-16	TM2EI 16-20W	25.0	22.0	1.02
	13/16	TMSR 16-16	TM2EI 16-16W	22.0	15.5	
	7/8-15/16	TMSR 16-16	TM2EI 16-16W	22.0	17.0	
	1-1 1/16	TMSR 20-16	TM2EI 16-16W	43.0	20.0	
	1 1/8-1 1/4	TMSRL 25-16	TM2EI 16-16W	25.0	22.0	
	1.4-1 5/8	TMSR 25-27	TM2EI 27-16W	52.0	30.0	
12	1 3/4-1.9	TMSR 32-27	TM2EI 27-16W	28.0	37.0	1.36
	1 1/2-1 3/4	TMSR 25-27	TM2EI 27-12W	52.0	30.0	
8	1 7/8-1.9	TMSR 25-27	TM2EI 27-12W	58.0	37.0	2.03
	2.1-2 1/8	TMSR 32-27	TM2EI 27-8W	52.0	30.0	
7	2	TMSR 25-27	TM2EI 27-8W	58.0	37.0	2.32
	2.1-2 1/8	TMSR 25-27	TM2EI 27-7W	52.0	30.0	
6	2.1-2 1/8	TMSR 25-27	TM2EI 27-6W	52.0	30.0	2.71
	2 1/4	TMSR 32-38	TM2EI 38-6W	55.0	35.0	
	2 3/8-2.6	TMSR 32-27	TM2EI 27-6W	58.0	37.0	
	2 5/8-2 3/4	TMSR 40-38	TM2EI 38-6W	65.0	46.0	
5	3	TMSR 40-38	TM2EI 38-5W	65.0	46.0	3.25
4.5	3 1/2	TMSR 40-38	TM2EI 38-4.5W	65.0	46.0	3.61

\* The recommended holder is the largest for the given thread specification  
 \* Holder with smaller or equal cutting diameters (D2) can also be used



## Tooling recommendation for given internal thread specification



### BSPT

Pitch (tpi)	Nominal dia. (inch)	Holder	Insert	Ø-Tool holder overhang	D-Tool cutting dia.*	Min.Thread depth (Profile depth)
19	3/8	TMSR 21-11	TM2EI 11-19 BSPT	20.0	11.5	0.86
14	1/2-3/4	TMSRT 16-11	TM2EI 16-14 BSPT	22.0	15.5	1.16
11	1-1 1/4	TMSRT 20-16	TM2EI 16-11 BSPT	23.0	19.0	1.48
	1 1/2	TMSR 25-27	TM2EI 27-11 BSPT	52.0	30.0	
	2-6	TMSRT 32-27	TM2EI 27-11 BSPT	58.0	37.0	

### NPT

Pitch (tpi)	Nominal dia. (inch)	Holder	Insert	Ø-Tool holder overhang	D-Tool cutting dia.*	Min.Thread depth (Profile depth)
14	1/2	TMSRT 16-16	TM2EI 16-14 NPT	22.0	15.5	1.33
	3/4	TMSRT 20-16	TM2EI 16-14 NPT	23.0	19.0	
11.5	1	TMSRT 20-16	TM2EI 16-11.5 NPT	23.0	19.0	1.64
	1 1/4	TMSR 25-27	TM2EI 27-11.5 NPT	52.0	30.0	
	1 1/2-2	TMSRT 32-27	TM2EI 27-11.5 NPT	58.0	37.0	
8	2 1/2	TMSRT 32-27	TM2EI 27-8 NPT	58.0	37.0	2.42
	3-24	TMSR 40-38	TM2EI 38-8 NPT	65.0	46.0	

### NPTF

Pitch (tpi)	Nominal dia. (inch)	Holder	Insert	Ø-Tool holder overhang	D-Tool cutting dia.*	Min.Thread depth (Profile depth)
14	1/2	TMSRT 16-16	TM2EI 16-14 NPTF	22.0	15.5	1.35
	3/4	TMSRT 20-16	TM2EI 16-14 NPTF	23.0	19.0	
11.5	1	TMSRT 20-16	TM2EI 16-11.5 NPTF	23.0	19.0	1.63
	1 1/2	TMSR 25-27	TM2EI 27-11.5 NPTF	52.0	30.0	
	2	TMSRT 32-27	TM2EI 27-11.5 NPTF	58.0	37.0	
8	2 1/2	TMSRT 32-27	TM2EI 27-8 NPTF	58.0	37.0	2.38
	3	TMSR 40-38	TM2EI 38-8 NPTF	65.0	46.0	

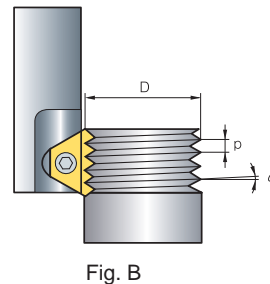
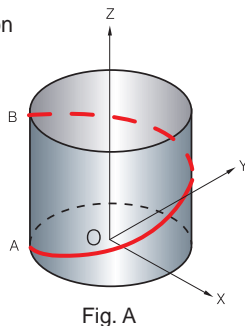
\* The recommended holder is the largest for the given thread specification  
 \* Holder with smaller or equal cutting diameters (D2) can also be used

## Minimum bore diameters for thread milling

Pitch	mm	0.5	0.6	0.7	0.75 0.80	0.9	1.0	1.25	1.5	1.75	2.0	-	2.5	3.0	3.5	4.0	4.5	5.0	5.5	-	6.0	-	
	tpi	48	44	36	32	28	26 24	20 19	18 16	14	13 12	11.5 11	10	9 8	7	6	-	5	-	4.5	-	4	
Holder designation	diameter	Minimum diameter for machining																					
TMSR 12-10	9.0	9.5	9.7	9.9	10.0	10.4	10.7	11.4	12.0														
TMSR 20-10	9.0	9.5	9.7	9.9	10.0	10.4	10.7	11.4	12.0														
TMSR 12-11	11.5	12.0	12.2	12.4	12.5	12.9	13.2	13.9	14.5	15.1													
TMSR 20-11	11.5	12.0	12.2	12.4	12.5	12.9	13.2	13.9	14.5	15.1													
TMSRL 25-11	11.5	12.0	12.2	12.4	12.5	12.9	13.2	13.9	14.5	15.1													
TMSRT 16-16	15.5	16.0	16.2	16.4	16.5	16.9	17.2	17.9	18.5	19.0	19.5	20.0											
TMSR 16-16	17.0	17.6	17.8	18.0	18.2	18.7	19.0	19.6	20.0	20.5	21.0	21.5											
TMSR 16-22	17.0	17.6	17.8	18.0	18.2	18.7	19.0	19.6	20.0	20.5	21.0	21.5											
TMSR 20-22	19.0	19.7	20.0	20.2	20.4	20.8	21.0	21.6	22.0	22.5	23.0	23.5											
TMSRT 20-16	19.0	19.7	20.0	20.2	20.4	20.8	21.0	21.6	22.0	22.5	23.0	23.5											
TMSR 20-16	20.0	20.7	21.0	21.2	21.4	21.8	22.0	22.6	23.0	23.5	24.0	24.5											
TMSRW 25-22	22.0	22.7	23.0	23.2	23.4	23.8	24.0	24.6	25.0	25.5	26.0	26.5											
TMSRL 25-22	22.0	22.7	23.0	23.2	23.4	23.8	24.0	24.6	25.0	25.5	26.0	26.5											
TMSRL 25-16	22.0	22.7	23.0	23.2	23.4	23.8	24.0	24.6	25.0	25.5	26.0	26.5											
TMSR 25-27	30.0	30.7	31.0	31.2	31.4	31.8	32.0	32.8	33.5	34.1	34.6	35.6	36.6	39.0	42.0	45.0	48.0						
TMSRL 25-27	30.0	30.7	31.0	31.2	31.4	31.8	32.0	32.8	33.5	34.1	34.6	35.6	36.6	39.0	42.0	45.0	48.0						
TMSR 32-38	35.0								38.5	39.1	39.6	40.6	42.0	44.0	47.0	50.0	53.4	42.5	50.0	44.6	57.5	56.6	
TMSR 32-27	37.0	38.0	38.2	38.4	38.6	39.1	39.5	40.4	41.0	41.5	42.0	43.0	44.0	46.5	49.0	52.0	55.5						
TMSRL 32-27	37.0	38.0	38.2	38.4	38.6	39.1	39.5	40.4	41.0	41.5	42.0	43.0	44.0	46.5	49.0	52.0	55.5						
TMSRT 32-27	37.0	38.0	38.2	38.4	38.6	39.1	39.5	40.0	41.0	41.5	42.0	43.0	44.0	46.5	49.0	52.0	55.5						
TMSR 40-38	46.0								49.5	50.1	50.6	51.6	53.0	55.0	55.2	55.6	55.0	52.5	54.0	54.5	57.5	56.6	
TMSRL 40-38	46.0								49.5	50.1	50.6	51.6	53.0	55.0	55.2	55.6	55.0	52.5	54.0	54.5	57.5	56.6	

- In order to perform a thread milling operation, a milling machine with three-axis control capability of helical interpolation is required
- Helical interpolation is a CNC function producing tool movement along a helical path. This helical motion combines circular movement in one plane with a simultaneous linear motion in a plane perpendicular to the first. For example, the path from point A to point B (Fig.A) on the envelope of the cylinder combines a circular movement in the x-y plane with a linear displacement in the z direction
- On most CNC systems this function can be executed in two different ways:

- GO2: Helical interpolation in a clockwise direction
- GO3: Helical interpolation in a counter-clockwise direction



- The thread milling operation (Fig. B) consists of circular rotation of the tool around its own axis together with an orbiting motion along the bore or workpiece circumference. During one such orbit, the tool will shift vertically one pitch length. These movements combined with the insert geometry create the required thread form. There are three acceptable ways of approaching the workpiece with the tool to initiate production of the thread:

1. Tangential Arc Approach
2. Radial Approach
3. Tangential Line Approach

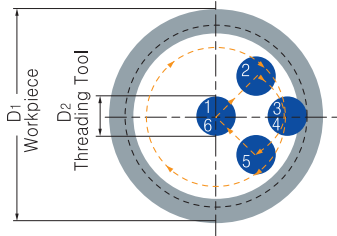




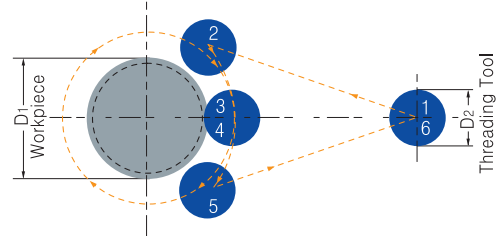
## Tangential arc approach

- With this method, the tool enters and exits the workpiece smoothly. No marks are left on the workpiece and there is no vibration, even with harder materials. Although it requires slightly more complex programming than the radial approach (see below), this is the method recommended for machining the highest quality threads

### Internal thread



### External thread

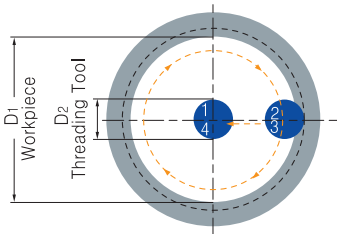


- 1-2: rapid approach
- 2-3: tool entry along tangential arc, with simultaneous feed along z-axis
- 3-4: helical movement during one full orbit (360°)
- 4-5: tool exit along tangential arc, with continuing feed along z-axis
- 5-6: rapid return

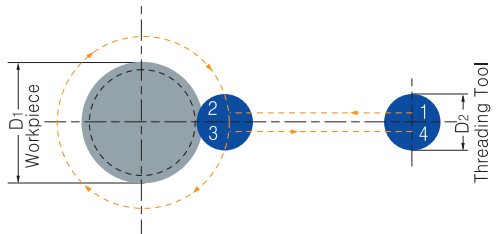
## Radial approach

- This is the simplest method. There are two characteristics worth noting about the radial approach:
  - A. a small vertical mark may be left at the entry (and exit) point. This is of no significance to the thread itself
  - B. when using this method with very hard materials, there may be a tendency of the tool to vibrate as it approaches the full cutting depth
- Note: Radial feed during entry to the full profile depth should only be 1/3 of the subsequent circular feed

### Internal thread



### External thread

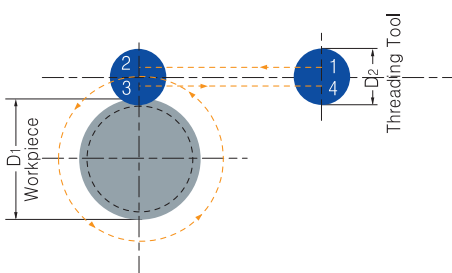


- 1-2: radial entry
- 2-3: helical movement during one full orbit (360°)
- 3-4: radial exit

## Tangential line approach

- This method is very simple, and has all of the advantages of the tangential arc method. However, it is applicable only with external threads

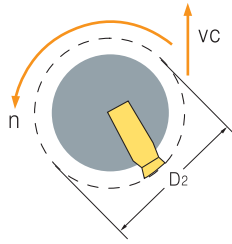
### External thread



- 1-2: radial entry with simultaneous feed along z axis
- 2-3: helical movement during one full orbit (360°)
- 3-4: radial exit

## Preparing for the thread milling operation

### ➤ Calculation of rotational velocity and feed at the cutting edge



$$n = \frac{vc \times 1000}{\pi \times D_2}$$

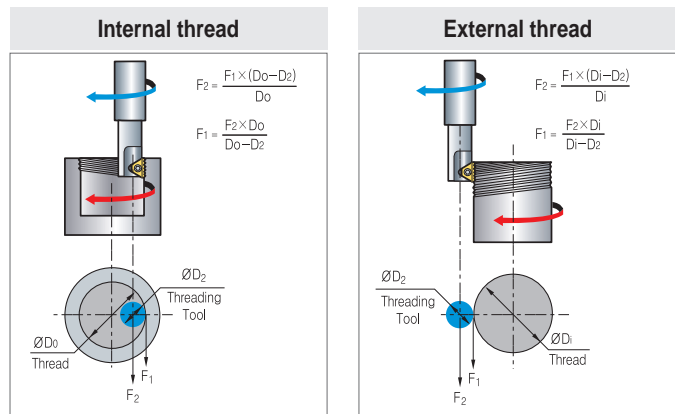
$$vc = \frac{n \times \pi \times D_2}{1000}$$

$$F_1 = n \times z \times f_n$$

- n:** Rotational Velocity (min<sup>-1</sup>)
- vc:** Cutting Speed (m/min)
- D2:** Tool holder Cutting Dia. (mm)
- F1:** Real Feed rate at the Cutting edges (mm/min)
- z:** No. of Cutting Edges
- fn:** Feed per Root per Rotation (mm/rev)

### ➤ Calculation of feed rates at the tool center line

- On most CNC machines, the feed rate required for programming is that of the center-line of the tool. When dealing with linear tool movement, the feed rate at the cutting edge and the center line are identical, but with circular tool movement this is not the case. The equations define the relationship between feed rates at the cutting edge and at the tool center line.



### ➤ Grades and applications

- Grade: PC9570T
- Application: First Choice for steel and cast iron. A tough sub-micron substrate with TiCN coating. Provides good fracture toughness and excellent wear resistance.

### ➤ Trouble shooting

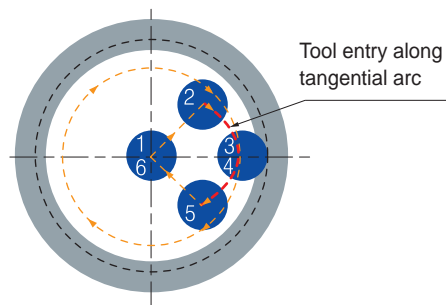
Problem	Possible	Solution
<b>Increased insert flank wear</b>	Cutting speed too high .....> Chip is too thin .....> Insufficient coolant .....>	Reduce cutting speed/use coated insert Increase feed rate Increase coolant flow rate
<b>Chipping of cutting edge</b>	Chip is too thick .....> Vibration .....>	Reduce feed rate/Use the tangential arc method Increase RPM Check stability
<b>Material built-up on the cutting edge</b>	Incorrect cutting speed .....> Unsuitable carbide grade .....>	Change cutting speed Use a coated carbide grade
<b>Chatter/vibration</b>	Feed rate is too high .....> Profile is too deep .....> Thread length is too long .....>	Reduce the feed. Execute two passes, each with increased cutting depth/ Execute two passes, each cutting only half the thread length Execute two passes, each cutting only half the thread length
<b>Insufficient thread accuracy</b>	Tool deflection .....>	Reduce feed rate/Execute a "zero" cut

## Recommended cutting condition

	Workpiece	Hardness brinell (HB)	vc (m/min)		Feed fz (mm/t)		
			Grade		Indexable insert	Solid endmill	
			PC9570T	PC9070M			
<b>P</b>	Unalloyed steel	Low carbon (C+0.1-0.25%)	125	100~210	80~250	0.05~0.3	0.03~0.15
		Medium carbon (C = 0.25-0.55%)	150	100~180	80~230	0.05~0.25	0.03~0.1
		High carbon (C = 0.55-0.85%)	170	100~170	80~200	0.05~0.2	0.03~0.08
	Low alloy steel	Non-hardened	180	90~160	60~180	0.05~0.25	0.03~0.1
		Hardened	275	80~150	60~170	0.05~0.2	0.03~0.07
		Hardened	350	70~140	60~160	0.05~0.15	0.01~0.03
	High alloy steel	Annealed	200	60~130	40~100	0.05~0.2	0.03~0.05
		Hardened	325	70~110	30~80	0.05~0.1	0.01~0.03
	Cast steel	Low alloy	200	100~170	80~250	0.05~0.15	0.03~0.1
		High alloy	225	70~120	60~170	0.05~0.1	0.01~0.03
<b>M</b>	Stainless steel ferritic	Non-hardened	200	100~170	60~150	0.05~0.15	0.04~0.1
		Hardened	330	100~170	60~120	0.05~0.1	0.01~0.05
	Stainless steel Austenitic	Austenitic	180	70~140	60~140	0.05~0.15	0.04~0.1
		Super austenitic	200	70~140	60~130	0.05~0.1	0.04~0.1
	Stainless steel cast ferritic	Non-hardened	200	70~140	60~160	0.05~0.15	0.04~0.1
		Hardened	330	70~140	60~110	0.05~0.1	0.03~0.05
	Stainless steel cast austenitic	Austenitic	200	70~120	60~150	0.05~0.15	0.04~0.1
		Hardened	330	70~120	60~100	0.05~0.1	0.03~0.05
	High temperature alloys	Annealed (Iron based)	200	20~45	30~60	0.05~0.1	0.04~0.1
		Aged (Iron based)	280	20~30	20~50	0.02~0.05	0.01~0.03
		Annealed (Nickel or Cobalt based)	250	15~20	15~35	0.02~0.05	0.01~0.03
		Aged (Nickel or Cobalt based)	350	10~15	15~30	0.02~0.05	0.01~0.03
	Titanium alloys	Pure 99.5 Ti	400Rm	70~140	40~80	0.02~0.05	0.03~0.05
		α+β alloys	1050Rm	20~50	20~50	0.02~0.05	0.03~0.05
<b>K</b>	Extra hard steel	Hardened & tempered	55HrC	20~45	15~45	0.01~0.03	0.005~0.01
	Malleable cast iron	Ferritic (short chips)	130	60~130	70~160	0.02~0.08	0.01~0.03
		Pearlitic (long chips)	230	60~120	60~150	0.02~0.05	0.03~0.05
	Grey cast iron	Low tensile strength	180	60~130	70~160	0.05~0.15	0.05~0.1
		High tensile strength	260	60~100	40~120	0.05~0.1	0.03~0.05
	Nodular SG iron	Ferritic	160	60~125	40~110	0.05~0.15	0.05~0.1
		Pearlitic	260	50~90	40~100	0.05~0.1	0.03~0.05
	<b>N</b>	Aluminum alloys Wrought	Non-aging	60	100~250	200~300	0.1~0.4
Aged			100	100~180	150~250	0.1~0.3	0.1~0.2
Aluminum alloys		Cast	75	150~400	100~200	0.1~0.3	0.1~0.2
		Cast & aged	90	150~280	120~220	0.05~0.25	0.1~0.15
		Cast Si 13-22%	130	80~150	200~300	0.1~0.3	0.1~0.2
Copper and copper alloys		Brass	90	120~210	200~300	0.1~0.3	0.1~0.25
		Bronze and non-leaded copper	100	120~210	150~250	0.05~0.25	0.1~0.2

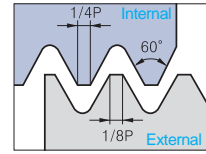
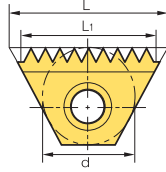
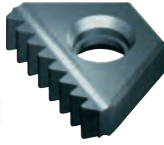
## Example

- At tool entry, set the Feed fz (mm/tooth) to 70% lower than the threading Feed
- Threading Feed: 0.3 (mm/t)
- Tool entry Feed: 0.09 (mm/t)



# D Thread Milling Inserts

## ISO Metric



Defined by: R262 (DIN 13)  
Tolerance class: 6g/6H

(mm)

External/Internal

Insert size		Pitch (mm)	Designation				L1	Tooth	Tool holder
d	L		External	PC9570T	Internal	PC9570T			
6.0	10.4	0.5	-		<b>TMI</b>	<b>10-0.5ISO</b>	●	10.0	TMSR - 10
		0.75	-			<b>10-0.75ISO</b>		9.75	
		1.0	-			<b>10-1.0ISO</b>	●	9.0	
		1.25	-			<b>10-1.25ISO</b>		8.75	
		1.5	-			<b>10-1.5ISO</b>		9.0	
6.35	11	0.5	-		<b>TM2I</b>	<b>11-0.5ISO</b>		10.0	TMSR - 11
		0.75	<b>TM2E</b>	<b>11-0.75ISO</b>			●	10.5	
		1.0		<b>11-1.0ISO</b>			●	10.0	
		1.25		<b>11-1.25ISO</b>				10.0	
		1.25		-				8.75	
		1.5		<b>11-1.5ISO</b>				9.0	
		1.5		-				10.5	
9.525	16	0.5	-		<b>TM2I</b>	<b>16-0.5ISO</b>		15.0	TMSR - 16
		0.75	<b>TM2E</b>	<b>16-0.75ISO</b>				15.0	
		0.8		-				14.4	
		1.0		<b>16-1.0ISO</b>				14.0	
		1.0		-			●	15.0	
		1.25		<b>16-1.25ISO</b>			●	15.0	
		1.5		<b>16-1.5ISO</b>	●		●	15.0	
		1.75		<b>16-1.75ISO</b>			●	14.0	
9.525B	22	1.0	<b>TM2E</b>	<b>22-1.0ISO</b>		<b>TM2I</b>	<b>22-1.0ISO</b>		TMSR - 22
		1.25		<b>22-1.25ISO</b>				21.25	
		1.5		<b>22-1.5ISO</b>			●	21.0	
		1.75		<b>22-1.75ISO</b>				21.0	
		2.0		<b>22-2.0ISO</b>	●		●	22.0	
15.875	27	1.0	<b>TM2E</b>	<b>27-1.0ISO</b>		<b>TM2I</b>	<b>27-1.0ISO</b>		TMSR - 27
		1.25		<b>27-1.25ISO</b>				25.0	
		1.5		<b>27-1.5ISO</b>			●	25.5	
		1.75		<b>27-1.75ISO</b>				24.5	
		2.0		<b>27-2.0ISO</b>			●	24.0	
		2.5		<b>27-2.5ISO</b>			●	25.0	
		3.0		<b>27-3.0ISO</b>			●	24.0	
		3.5		<b>27-3.5ISO</b>				24.5	
		4.0		<b>27-4.0ISO</b>			●	24.0	
19.05B	38.5	1.5	<b>TM2E</b>	<b>38-1.5ISO</b>		<b>TM2I</b>	<b>38-1.5ISO</b>		TMSR - 38
		2.0		<b>38-2.0ISO</b>				36.0	
		3.0		<b>38-3.0ISO</b>				36.0	
		4.0		<b>38-4.0ISO</b>				32.0	
		4.5		<b>38-4.5ISO</b>				31.5	
		5.0		<b>38-5.0ISO</b>				30.0	
		5.5		<b>38-5.5ISO</b>				33.0	
6.0		<b>38-6.0ISO</b>				30.0			

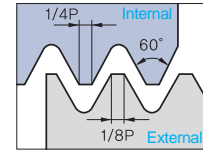
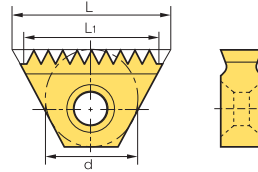
➔ Applicable holders **D49**

All inserts except TMI10 code have 2 cutting edges

●: Stock item



## American UNC



Defined by: ANSI B1.1.74  
Tolerance class: Class 2A/2B

(mm)

External/Internal

Insert size		Pitch (tpi)	Designation				L1	Tooth	Tool holder		
d	L		External	PC9570T	Internal	PC9570T					
6.0	10.4	32	-		<b>TMI</b>	<b>10-32UN</b>		9.53	12	TMSR - 10	
		28	-			<b>10-28UN</b>		9.07	10		
		24	-			<b>10-24UN</b>		9.53	9		
		20	-			<b>10-20UN</b>	●	8.89	7		
		18	-			<b>10-18UN</b>		8.47	6		
		16	-			<b>10-16UN</b>		7.94	5		
6.35	11	48	-		<b>TM2I</b>	<b>11-48UN</b>		10.05	19	TMSR - 11	
		40	-			<b>11-40UN</b>		10.16	16		
		32	-			<b>11-32UN</b>		10.32	13		
		28	<b>TM2E</b>	<b>11-28UN</b>			<b>11-28UN</b>		9.98		11
		27		<b>11-27UN</b>			<b>11-27UN</b>		10.35		11
		24		<b>11-24UN</b>			<b>11-24UN</b>		9.53		9
		20		<b>11-20UN</b>			<b>11-20UN</b>		10.16		8
		18		<b>11-18UN</b>			<b>11-18UN</b>	●	9.88		7
		16		<b>11-16UN</b>			<b>11-16UN</b>		9.53		6
14		<b>11-14UN</b>			<b>11-14UN</b>		9.07	5			
9.525	16	40	-		<b>TM2I</b>	<b>16-40UN</b>		14.61	40	TMSR - 16	
		32	-			<b>16-32UN</b>		15.08	32		
		28	<b>TM2E</b>	<b>16-28UN</b>			<b>16-28UN</b>		14.51		28
		27		<b>16-27UN</b>			<b>16-27UN</b>		14.11		27
		24		<b>16-24UN</b>			<b>16-24UN</b>		14.82		24
		20		<b>16-20UN</b>			<b>16-20UN</b>		13.97		20
		18		<b>16-18UN</b>			<b>16-18UN</b>		14.11		18
		16		<b>16-16UN</b>			<b>16-16UN</b>	●	14.29		16
		14		<b>16-14UN</b>			<b>16-14UN</b>		14.51		14
		13		<b>16-13UN</b>			<b>16-13UN</b>		13.68		13
		12		<b>16-12UN</b>			<b>16-12UN</b>	●	14.82		12
11.5		<b>16-11.5UN</b>			<b>16-11.5UN</b>		13.25	11.5			
9.525B	22	24	<b>TM2E</b>	<b>22-24UN</b>		<b>TM2I</b>	<b>22-24UN</b>		21.16	20	TMSR - 22
		20		<b>22-20UN</b>			<b>22-20UN</b>		21.59	17	
		18		<b>22-18UN</b>			<b>22-18UN</b>		21.17	15	
		16		<b>22-16UN</b>			<b>22-16UN</b>		20.64	13	
		14		<b>22-14UN</b>			<b>22-14UN</b>		21.77	12	
		13		<b>22-13UN</b>			<b>22-13UN</b>		21.49	11	
		12		<b>22-12UN</b>			<b>22-12UN</b>		21.17	10	
		11.5		<b>22-11.5UN</b>			<b>22-11.5UN</b>		24.30	11	
15.875	27	24	<b>TM2E</b>	<b>27-24UN</b>		<b>TM2I</b>	<b>27-24UN</b>		25.40	24	TMSR - 27
		20		<b>27-20UN</b>			<b>27-20UN</b>		25.40	20	
		18		<b>27-18UN</b>			<b>27-18UN</b>		25.40	18	
		16		<b>27-16UN</b>			<b>27-16UN</b>		25.40	16	
		14		<b>27-14UN</b>			<b>27-14UN</b>		25.40	14	
		13		<b>27-13UN</b>			<b>27-13UN</b>		25.40	13	
		12		<b>27-12UN</b>			<b>27-12UN</b>		25.40	12	
		11.5		<b>27-11.5UN</b>			<b>27-11.5UN</b>		24.30	11	
		11		<b>27-11UN</b>			<b>27-11UN</b>		25.40	11	
		10		<b>27-10UN</b>			-		22.86	9	
		10		-			<b>27-10UN</b>		25.40	10	
		9		<b>27-9UN</b>			<b>27-9UN</b>		22.58	8	
		8		<b>27-8UN</b>			<b>27-8UN</b>		22.23	7	
		7		<b>27-7UN</b>			-		21.77	6	
7		-			<b>27-7UN</b>		25.40	7			
6		<b>27-6UN</b>			-		21.17	5			
6		-			<b>27-6UN</b>		25.40	6			
19.05	38.5	6	<b>TM2E</b>	<b>38-6UN</b>		<b>TM2I</b>	<b>38-6UN</b>		38.87	8	TMSR - 38
		5		<b>38-5UN</b>			<b>38-5UN</b>		30.48	6	
		4.5		<b>38-4.5UN</b>			<b>38-4.5UN</b>		33.87	6	
		4		<b>38-4UN</b>			<b>38-4UN</b>		31.75	5	

Applicable holders **D49**

All inserts except TMI10 code have 2 cutting edges

● : Stock item

Threading

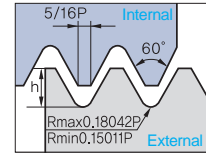
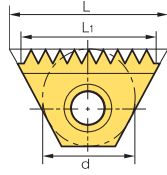
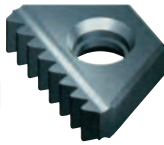


**D**

# D Thread Milling Inserts

## UNJ(Unified Constant Thread)

External/Internal



Defined by: MIL-S-8879C  
Tolerance class: 3A/3B

(mm)

Insert size		Pitch (tpi)	Designation				L <sub>1</sub>	Tooth	Tool holder	
d	L		External	PC9570T	Internal	PC9570T				
6.0	10.4	24	-		TMI	10-24UNJ	9.53	9	TMSR - 10	
		20	-			10-20UNJ	8.89	7		
		18	-			10-18UNJ	8.47	6		
		16	-			10-16UNJ	9.53	8		
6.35	11	24	TM2E	11-24UNJ		TM2I	11-24UNJ	9.53	9	TMSR - 11
		20		11-20UNJ			11-20UNJ	10.16	8	
		18		-			11-18UNJ	9.88	7	
		16		11-16UNJ			11-16UNJ	9.53	6	
		14		11-14UNJ			11-14UNJ	9.07	5	
9.525	16	24	TM2E	16-24UNJ		TM2I	16-24UNJ	14.82	14	TMSR - 16
		20		16-20UNJ			16-20UNJ	13.97	11	
		18		16-18UNJ			16-18UNJ	14.11	10	
		16		16-16UNJ			16-16UNJ	14.29	9	
		14		16-14UNJ			16-14UNJ	14.51	8	
		13		16-13UNJ			-	13.68	7	
		12		16-12UNJ			16-12UNJ	14.82	7	
15.875	27	16	TM2E	27-16UNJ		TM2I	27-16UNJ	25.40	16	TMSR - 27
		12		27-12UNJ			27-12UNJ	25.40	12	
		11		27-11UNJ			27-11UNJ	25.40	11	

Applicable holders **D49**

All inserts except TMI10 code have 2 cutting edges

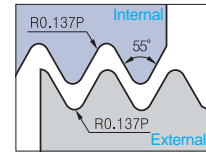
●: Stock item



D

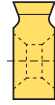
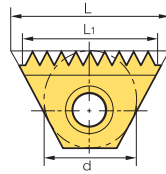
Threading

## Whitworth (BSW, BSF, BSP, BSB)



BSW Defined by: B.S.84:1956, DIN 259, ISO228/1:1982  
 BSP Defined by: B.S.2779:1956  
 Tolerance class: BSW-Medium class A, BSP-Medium class

External/Internal



Insert size		Pitch (tpi)	Designation		PC9570T	L1	Tooth	Tool holder
d	L		External+Internal					
6.0	10.4	28	TMEI	10-28W		9.07	10	TMSR - 10
		26		10-26W		8.79	9	
		24		10-24W		9.53	9	
		20		10-20W		8.89	7	
		19		10-19W		9.36	7	
6.35	11	28	TM2EI	11-28W		9.98	11	TMSR - 11
		26		11-26W		9.77	10	
		24		11-24W		9.53	9	
		20		11-20W		10.16	8	
		19		11-19W		9.36	7	
		14		11-14W		9.07	5	
9.525	16	26	TM2EI	16-26W		14.65	15	TMSR - 16
		24		16-24W		14.82	14	
		20		16-20W		13.97	11	
		19		16-19W		14.71	11	
		18		16-18W		14.11	10	
		16		16-16W		14.29	9	
		14		16-14W		14.51	8	
		12		16-12W		14.82	7	
9.525B	22	24	TM2EI	22-24W	●	21.17	20	TMSR - 22
		20		22-20W		21.59	17	
		19		22-19W		21.39	16	
		18		22-18W		21.17	15	
		16		22-16W		20.64	13	
		14		22-14W		21.77	12	
		12		22-12W		21.17	10	
		11		22-11W		20.78	9	
15.875	27	16	TM2EI	27-16W		25.4	16	TMSR - 27
		14		27-14W		25.4	14	
		12		27-12W		23.28	11	
		11		27-11W		23.09	10	
		10		27-10W		25.40	10	
		9		27-9W		22.58	8	
		8		27-8W		22.23	7	
		7		27-7W		21.77	6	
19.05B	38.5	11	TM2EI	38-11W		34.64	15	TMSR - 38
		6		38-6W		33.87	8	
		5		38-5W		30.48	6	
		4.5		38-4.5W		33.87	6	
		-		38-15W		-	-	

➔ Applicable holders **D49**

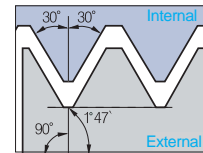
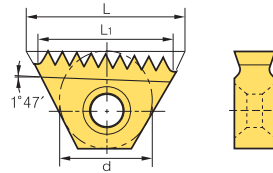
All inserts except TMI10 code have 2 cutting edges

● : Stock item



# D Thread Milling Inserts

## NPT



Defined by: USAS B2.1:1968  
Tolerance class: Standard NPT

(mm)

External/Internal

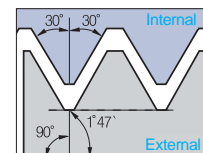
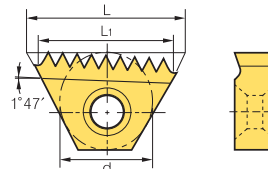
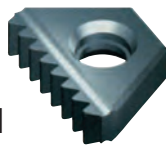
Insert size		Pitch (tpi)	Designation		PC9570T	L <sub>1</sub>	Tooth	Tool holder	
d	L		External+Internal					RH	LH
9.525	16	18	TM2E	16-18NPT *		14.11	10	TMSRT - 16	TMSLT - 16
		14	TM2EI	16-14NPT		14.51	8		
		11.5		16-11.5NPT		13.25	6		
9.525B	22	14	TM2EI	22-14NPT		21.77	12	TMSRT - 22	TMSLT - 22
15.875	27	11.5	TM2EI	27-11.5NPT	●	24.30	11	TMSR - 27	TMSL - 27
		8		27-8NPT	●	22.23	7		
19.05B	38.5	11.5	TM2EI	38-11.5NPT		35.34	16	TMSR - 38	TMSL - 38
		8		38-8NPT		31.75	10		

➔ Applicable holders D49

\* TM2E16-18NPT is for external threading

●: Stock item

## NPTF



Defined by: ANSI 1.20.3-1976  
Tolerance class: Standard NPTF

(mm)

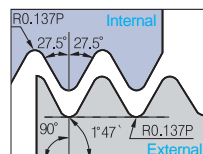
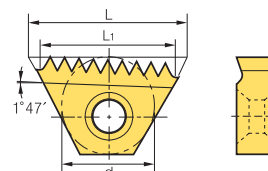
External/Internal

Insert size		Pitch (tpi)	Designation		PC9570T	L <sub>1</sub>	Tooth	Tool holder	
d	L		External+Internal					RH	LH
9.525	16	14	TM2EI	16-14NPTF	●	14.51	8	TMSRT - 16	TMSLT - 16
		11.5		16-11.5NPTF		13.25	6		
9.525B	22	14	TM2EI	22-14NPTF		21.77	12	TMSRT - 22	TMSLT - 22
		11.5		22-11.5NPTF		19.88	9		
15.875	27	11.5	TM2EI	27-11.5NPTF		24.30	11	TMSR - 27	TMSL - 27
		8		27-8NPTF		22.23	7		
19.05B	38.5	11.5	TM2EI	38-11.5NPTF		35.34	16	TMSR - 38	TMSL - 38
		8		38-8NPTF		31.75	10		

➔ Applicable holders D49

●: Stock item

## BSPT



Defined by: B.S 21:1985  
Tolerance class: Standard BSPT

(mm)

External/Internal

Insert size		Pitch (tpi)	Designation		PC9570T	L <sub>1</sub>	Tooth	Tool holder	
d	L		External+Internal					RH	LH
6.35	11	19	TM2EI	11-19BSPT		9.36	7	TMSR - 10	TMSL - 10
9.525	16	14	TM2EI	16-14BSPT		14.51	8	TMSRT - 16	TMSLT - 16
		11		16-11BSPT		13.85	6		
15.875	27	11	TM2EI	27-11BSPT		23.09	10	TMSR - 27	TMSL - 27

➔ Applicable holders D49

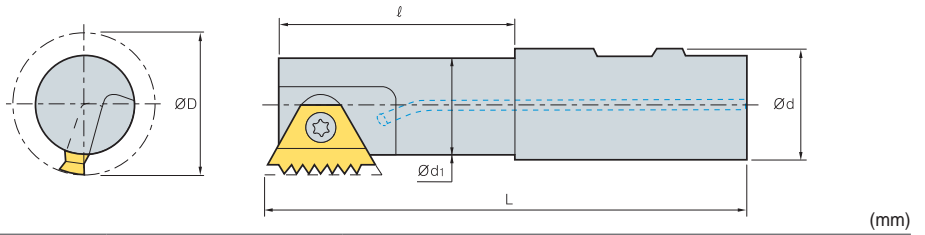
●: Stock item



D

Threading

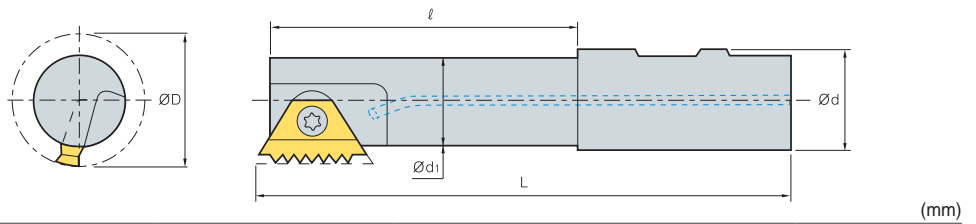
## Standard Type



Insert size d	Designation	ØD	Ød	Ød <sub>1</sub>	ℓ	L	Screw	Wrench
6.0	TMSR 12-10	9.0	12	6.8	12.0	69.0	STM10	TW07P
	20-10	9.0	20	6.8	17.0	84.0		
6.35	TMSR 12-11	11.5	12	8.9	12.0	70.0	STM11	TW08P
	20-11	11.5	20	8.9	20.0	85.0		
9.525	TMSR 16-16	17.0	16	13.6	22.0	90.0	STM1622	TW10P
	20-16	20.0	20	16.6	43.0	95.0		
9.525B	TMSR 16-22	17.0	16	13.5	29.0	79.5	STM1622	TW10P
	20-22	19.0	20	15.5	29.0	81.5		
	TMSRW 25-22	22.0	25	18.5	30.0	90.8		
15.875	TMSR 25-27	30.0	25	24.0	52.0	110.0	STM27	TW25L
	TMSL 25-27	30.0	25	24.0	52.0	110.0		
	TMSR 32-27	37.0	32	31.0	58.0	120.0		
19.05	TMSR 32-38	35.0	32	27.0	53.0	115.0	STM38	TW30L
	40-38	46.0	40	38.0	63.0	135.0		

➔ Applicable inserts D44-48

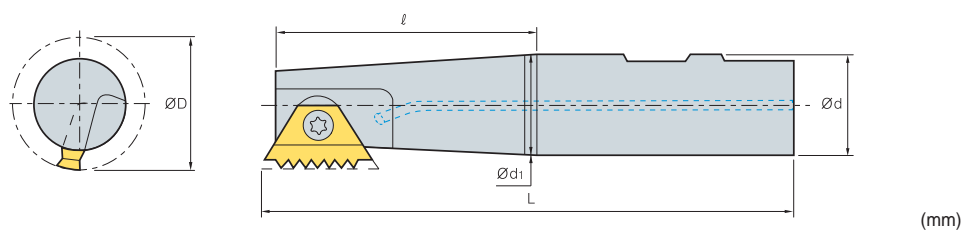
## Long Type



Insert size d	Designation	ØD	Ød	Ød <sub>1</sub>	ℓ	L	Screw	Wrench
6.35	TMSRL 25-11	11.5	25	8.9	17.0	125.0	STM11	TW08P
9.525B	TMSRL 25-16	22.0	25	18.6	25.0	125.0	STM1622	TW10P
9.525B	TMSRL 20-22	19.0	20	15.5	44.0	96.5	STM1622	TW10P
	25-22	22.0	25	18.6	63.5	125.0		
15.875	TMSRL 25-27	30.0	25	24.0	92.0	150.0	STM27	TW25L
	32-27	37.0	32	31.0	98.0	160.0		
19.05B	TMSRL 40-38	46.0	40	38.0	93.0	168.0	STM38	TW30L

➔ Applicable inserts D44-48

## Tapered Type



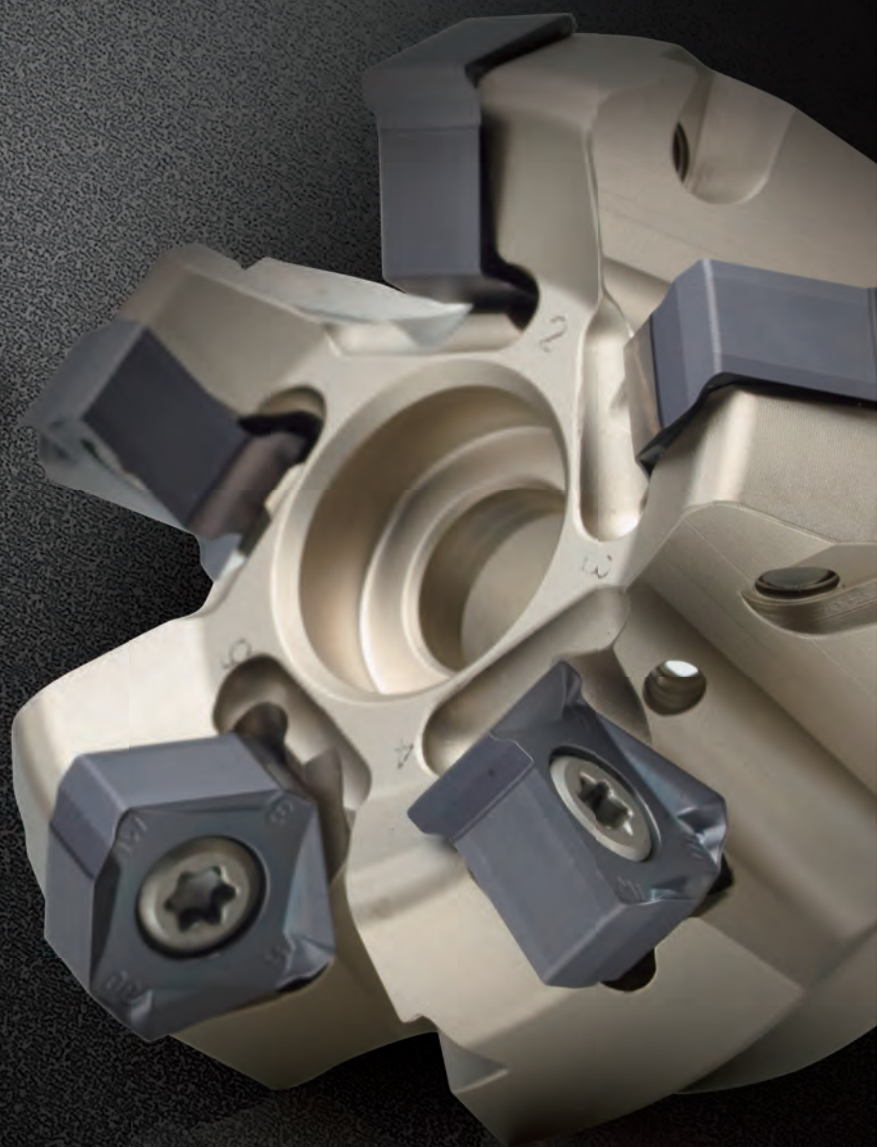
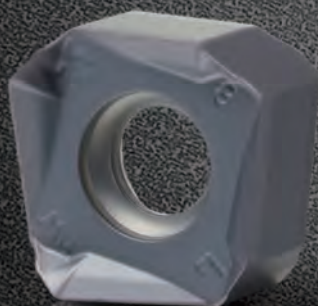
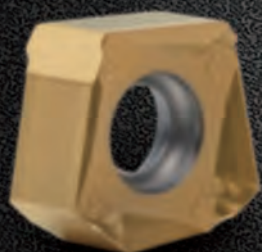
Insert size d	Designation	ØD	Ød	Ød <sub>1</sub>	ℓ	L	Screw	Wrench
9.525	TMSRT 16-16	15.5	16	12.5	22.0	90.0	STM1622	TW10P
	20-16	19.0	20	15.0	23.0	85.0	STMT16	
9.525B	TMSRT 16-22	17.0	16	13.5	29.0	79.5	STM1622	TW10P
	20-22	19.0	20	15.5	29.0	81.5		
15.875	TMSRT 32-27	37.0	32	31.0	58.0	120.0	STM27	TW25L

➔ Applicable inserts D44-48



# MILLING

Milling tools that provide the best quality and improve productivity for every customer needs.





## Insert

- E02** Milling Insert Code System (ISO)
- E04** Milling Inserts
- E34** KORLOY Cutters
- E42** KORLOY Shanks
- E45** KORLOY Modular Adaptors

## Face Milling Cutters

- E47** Mill-max/Mill-max Plus (E48, E54)
- E57** Technical Information for Mill-max Heavy
- E58** Mill-max Heavy
- E59** Turbo Mill
- E62** Double Mill
- E64** Technical Information for Power Buster
- E68** Power Buster
- E71** Technical Information for Rich Mill
- E99** Rich Mill
- E147** Technical Information for Aero Mill/Aero Mill-Plus/Aero Mill-Mini
- E151** Aero Mill
- E152** Aero Mill-Plus
- E154** Aero Mill-Mini
- E156** PCD face cutter

## Cutters for Molds

- E157** Technical Information for Alpha Mill
- E158** Technical Information for Alpha Mill Nick
- E164** Alpha Mill
- E193** Technical Information for Alpha Mill-X
- E197** Alpha Mill-X
- E201** Technical Information for Future Mill
- E211** Technical Information for Future Mill P-Positive
- E216** Future Mill
- E242** Future Mill P-Positive
- E254** Technical Information for Triple Mill
- E258** Triple Mill

## Cutters for Molds

- E262** Technical Information for HFMD
- E267** HFMD
- E277** Technical Information for HFM
- E281** HFM
- E284** Technical Information for HRMDouble
- E289** HRMDouble
- E300** HRM
- E307** Tank Mill
- E308** Technical Information for TP2P
- E311** TP2P
- E317** Technical Information for Laser Mill/GBE/BRE
- E326** Laser Mill
- E331** BFE
- E332** GBE
- E335** BRE
- E337** Technical Information for HAVE
- E339** HAVE (Multi-edge, Single-edge)
- E341** Technical Information for BT/HSK Tooling System
- E342** BT Tooling System (Alpha Mill)
- E347** BT Tooling System (Mono-Tool)
- E353** HSK Tooling System (Alpha Mill)
- E358** HSK Tooling System (Mono-Tool)
- E363** HSK Tooling System (Pro-V Mill)
- E364** O-ring Cutter
- E366** Chamfer Tool (Multi-functional, Solid)
- E374** T-Cutter (TFE)

## Milling Cutter for Aluminum

- E375** Technical Information for Pro-A Mill/Pro-X Mill/Pro-L Mill/Pro-XL Mill/Pro-V Mill
- E385** Pro-A Mill
- E388** Pro-X Mill
- E394** Pro-L Mill
- E398** Pro-XL Mill
- E399** Pro-V Mill
- E401** Modular Adaptor (MAT/BT/HSK)

## Side Milling Cutters

- E405** Technical Information for Side Milling Cutters
- E407** Side Milling Cutters
- E411** Side Cutter
- E414** Wind Mill

## Milling Cutter for Cast iron at high feed

- E418** Technical information for High feed Cutter
- E420** Technical information for Cube Mill
- E421** Technical information for Couple Mill
- E423** Technical information for Shave Mill
- E425** Technical information for Shave Mill Ultra

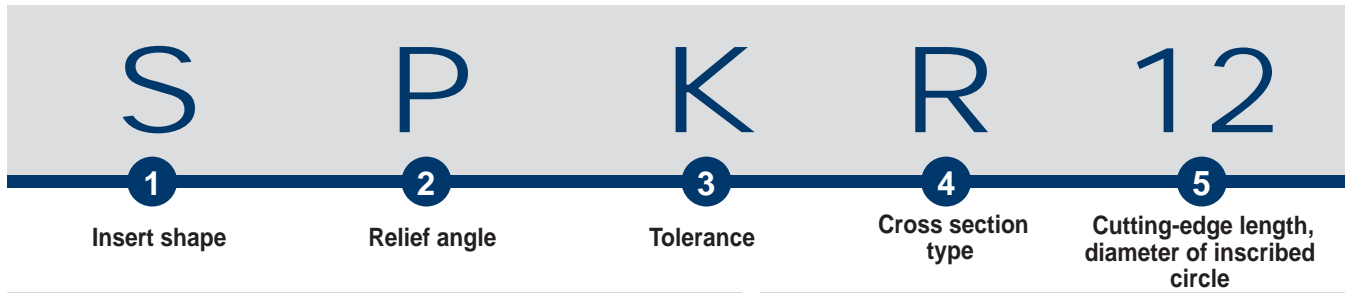
## Detail Information of Milling Cutter and Arbor

- E426** Actual Designation of Milling Cutter and Arbor

## Gear Tools

- E429** Technical information for Gear Cutter Tools
- E430** Gear Cutter Table
- E431** Gear Cutter
- E439** Gear Cutter Order Form
- E440** Indexable HOB
- E441** Indexable HOB Cutter Order Form

# E Milling Insert Code System (ISO)



### 1 Insert shape

S P K R 12 03 <sup>ED</sup>08 S R - MX

### 2 Relief angle

S P K R 12 03 <sup>ED</sup>08 S R - MX

### 3 Tolerance

S P K R 12 03 <sup>ED</sup>08 S R - MX

d: Inscribed circle  
t: Thickness  
m: Refer to figure

■ Tolerance on C, E, H, M, O, P, R, S, T, W Insert Shape (exceptional case) (mm)

Class	d	m	t	Tolerance on d		Tolerance on m	
				J, K, L, M, N	U	M, N	U
A	±0.025	±0.005	±0.025	6.35	±0.05 ±0.08	±0.08	±0.13
C	±0.025	±0.013	±0.025	9.525	±0.05 ±0.08	±0.08	±0.13
H	±0.013	±0.013	±0.025	12.7	±0.08 ±0.13	±0.13	±0.20
E	±0.025	±0.025	±0.025	15.875	±0.10 ±0.18	±0.15	±0.27
G	±0.025	±0.025	±0.13	19.05	±0.10 ±0.18	±0.15	±0.27
J	±0.05 ~ ±0.15	±0.005	±0.025	25.4	±0.13 ±0.25	±0.18	±0.38
K	±0.05 ~ ±0.15	±0.013	±0.025	Tolerance on D Insert Shape (exceptional case)			
L	±0.05 ~ ±0.15	±0.025	±0.025	d	Tolerance on d	Tolerance on m	
M	±0.05 ~ ±0.15	±0.08 ~ ±0.20	±0.13	6.35	±0.05	±0.11	
U	±0.08 ~ ±0.25	±0.13 ~ ±0.38	±0.13	9.525	±0.05	±0.11	
				12.7	±0.08	±0.15	
				15.875	±0.10	±0.18	
				19.05	±0.10	±0.18	

### 4 Cross section type

S P K R 12 03 <sup>ED</sup>08 S R - MX

### 5 Cutting-edge length, diameter of inscribed circle

S P K R 12 03 <sup>ED</sup>08 S R - MX

■ Metric system \* Decimal integer constant

■ Inch system

· Use 1/32" unit for a insert having smaller I.C under 1/4"  
· Use 1/8" unit for a insert having larger I.C over 1/4"

■ Cross over chart for "Metric" and "Inch" system

	06	09	11	16	22	27	33	44
Inscribed circle	5/32"	7/32"	1/4"	3/8"	1/2"	5/8"	3/4"	1"
Inch system	5	7	2 (8)	3	4	5	6	8

\* In case of rectangular and rhombic insert indicate cutting-edge length instead of inscribed circle.



03

ED  
08

S

R - MX

6

Height of cutting-edge

7

Nose radius (Nose R)

8

Edge preparation

9

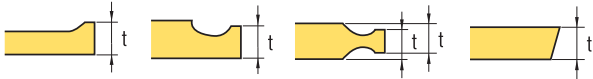
Hand

10

Chip breaker for milling

**6** Height of cutting-edge

S P K R 12 03 ED 08 S R - MX

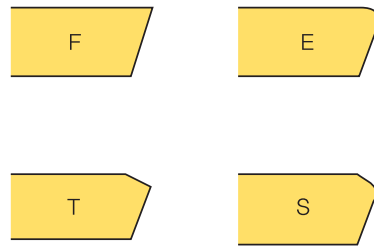


Symbol		Height of cutting-edge (t)	
Metric	Inch	Metric	Inch
01	1 (2)	1.59	1/16
T0	1.125	1.79	9/128
T1	1.2	1.98	5/64
02	1.5 (3)	2.38	3/32
T2	1.75	2.78	7/64
03	2	3.18	1/8
T3	2.5	3.97	5/32
04	3	4.76	3/16
05	3.5	5.56	7/32
06	4	6.35	1/4
07	5	7.94	5/16
09	6	9.52	3/8
11	7	11.11	7/16
12	8 (16)	12.70	1/2

( ) Symbol for small size insert

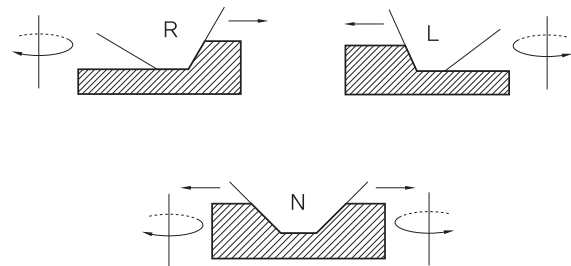
**8** Edge preparation

S P K R 12 03 ED 08 S R - MX



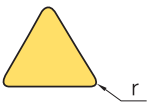
**9** Hand

S P K R 12 03 ED 08 S R - MX

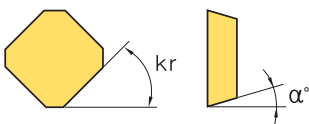


**7** Nose radius (Nose R)

S P K R 12 03 ED 08 S R - MX



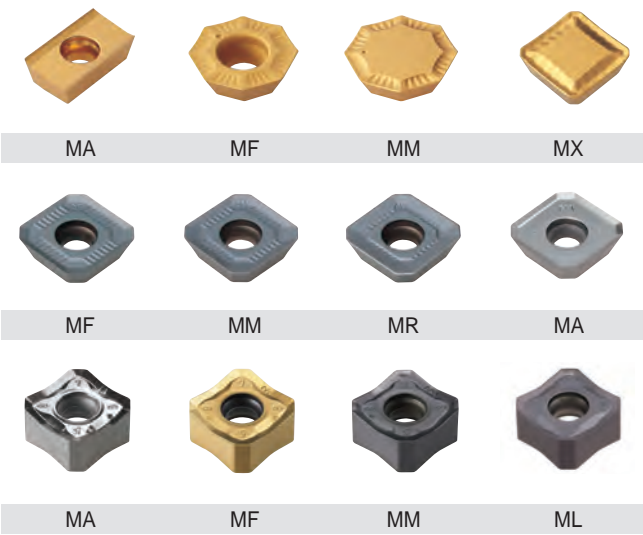
Symbol		r		Symbol		r	
Metric	Inch	Metric	Inch	Metric	Inch	Metric	Inch
00	0	0.0		12	3	1.2	3/64
02		0.2		15		1.5	
04	1	0.4	1/64	16	4	1.6	4/64
05		0.5		24	6	2.4	6/64
08	2	0.8	2/64	32	8	3.2	8/64
10		1.0		40		4.0	



Parallel Land		Relief Angle	
kr		α°	
A - 45°		A - 3°	F - 25°
D - 60°		B - 5°	G - 30°
E - 75°		C - 7°	N - 0°
F - 85°		D - 15°	P - 11°
P - 90°		E - 20°	
Z - Special			

**10** Chip breaker for milling

S P K R 12 03 ED 08 S R - MX




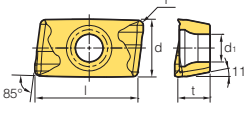

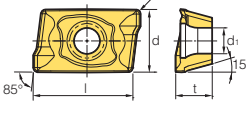

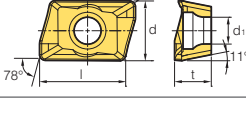
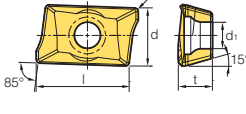
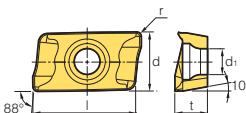
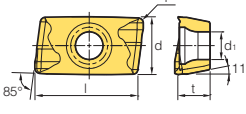


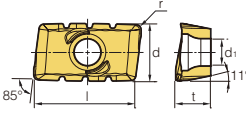






# E Milling Inserts

Workpiece	Steel	P											Machining types
	Stainless steel	M											
	Cast iron	K											<ul style="list-style-type: none"> <li>● Continuous cutting</li> <li>● General cutting</li> <li>● Interrupted cutting</li> </ul>
	Non-ferrous metal	N											
	Heat resistant alloy, Titanium alloy	S											
	Hardened steel	H											

Inserts	Designation	Cermets		Coated										PCD		Dimensions (mm)					Geometries	Available tools		
		CN2500	CN30	NC5330	NCM325	NCM535	PC2505	PC2510	PC2010	PC3700	PC6510	PC9530	PC9540	PC5300	PC5400	DP150	DP200	l	d	t			r	d <sub>1</sub>
	160404PDER-ML																16.4	9.41	5.76	0.4	4.5		E167	
	1604PDER-ML																16.4	9.41	5.76	0.8	4.5		E173	
																								E179
		180604PDER-ML																17.4	10.98	6.35	0.4	4.5		E169
		1806PDER-ML																17.4	10.98	6.35	0.8	4.5		E174
		180612PDER-ML																17.4	10.98	6.35	1.2	4.5		E181
		180616PDER-ML																17.4	10.98	6.35	1.6	4.5		E182
180620PDER-ML																	17.4	10.98	6.35	2.0	4.5	E187		
180624PDER-ML																	17.4	10.98	6.35	2.4	4.5			
180630R-ML																	17.4	10.98	6.35	3.0	4.5			
	060202PDSR-MM			●						●							6	4.24	2.6	0.2	2.0		E164, 170	
	0602PDSR-MM			●			●	●		●	●						6	4.24	2.6	0.4	2.0		E175, 183	
	060208PDSR-MM			●						●							6	4.24	2.6	0.8	2.0		E185, 188	
	060212R-MM			●													6	4.24	2.6	1.2	2.0	E190		
	060216R-MM *																6	4.24	2.6	1.6	2.0			
	0903PDSR-MM			●			●	●		●	●						9.4	6.21	3.6	0.4	2.8		E165	
	090308PDSR-MM			●					●							9.4	6.21	3.6	0.8	2.8	E176			
	090312R-MM								●							9.4	6.21	3.6	1.2	2.8	E177			
	090316R-MM			●						●						9.4	6.21	3.6	1.6	2.8	E185			
	090320R-MM									●						9.2	6.21	3.6	2.0	2.8	E191			
	090332R-MM *															9.2	6.21	3.6	3.2	2.8				
	11T3PDSR-MM			●	●	●	●	●		●	●	●					11.2	6.467	3.6	0.5	2.85		E166, 170	
	11T308PDSR-MM			●						●		●	●			11.2	6.467	3.6	0.8	2.85	E172, 178			
	11T312PDSR-MM			●							●					11.2	6.467	3.6	1.2	2.85	E183, 186			
	11T316R-MM			●							●					11.0	6.467	3.6	1.6	2.85	E189, 192			
	11T318R-MM											●				11.0	6.467	3.6	1.8	2.85				
	11T324R-MM			●							●					11.0	6.467	3.6	2.4	2.85				
	160404PDSR-MM																16.4	9.41	5.76	0.8	4.5		E167	
	1604PDSR-MM			●	●	●	●	●		●	●	●	●			16.4	9.41	5.76	0.8	4.5	E171			
	160410PDSR-MM										●					16.4	9.41	5.76	1.0	4.5	E173			
	160416PDSR-MM			●							●					16.4	9.41	5.76	1.6	4.5	E179			
	160420R-MM																						E184	
	160424R-MM			●							●					16	9.41	5.76	2.4	4.5	E189			
	160430R-MM										●					16	9.41	5.76	3.0	4.5				
	160432R-MM			●							●					16	9.41	5.76	3.2	4.5				
	160450R-MM *										●					16	9.41	5.76	5.0	4.5				
	160464R-MM *															16	9.41	5.76	6.4	4.5				
1806PDSR-MM			●			●	●		●	●	●	●			17.4	10.98	6.35	0.8	4.5		E169			
180612PDSR-MM			●						●					17.4	10.98	6.35	1.2	4.5	E174					
180616PDSR-MM			●											17.4	10.98	6.35	1.6	4.5	E181					
180620PDSR-MM															17.4	10.98	6.35	2.0	4.5	E182				
180624PDSR-MM			●							●					17.4	10.98	6.35	2.4	4.5	E187				
180630R-MM															16.7	10.98	6.35	3.0	4.5					
180632R-MM			●												16.7	10.98	6.35	3.2	4.5					
180640R-MM *															16.7	10.98	6.35	4.0	4.5					
180648R-MM *															16.7	10.98	6.35	4.8	4.5					
180650R-MM *															16.7	10.98	6.35	5.0	4.5					
180660R-MM *															16.7	10.98	6.35	6.0	4.5					
180664R-MM *															16.7	10.98	6.35	6.4	4.5					
	11T3PDSR-MN2															11.2	6.467	3.6	0.5	2.85		E166, 167		
	11T3PDSR-MN3															11.2	6.467	3.6	0.5	2.85		E172, 173		
	1604PDSR-MN3															16.4	9.41	5.76	0.8	4.5		E174, 178		
	1604PDSR-MN4															16.4	9.41	5.76	0.8	4.5		E179, 181		
	1806PDSR-MN3															17.4	10.98	6.35	0.8	4.5		E182, 186		
	1806PDSR-MN4															17.4	10.98	6.35	0.8	4.5		E187, 192		

\* Inserts marked with an asterisk (\*) require a custom-made order for special holders.


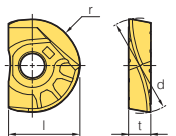

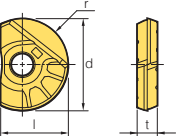
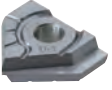
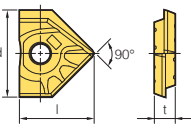

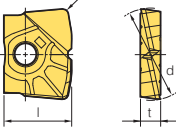
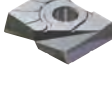
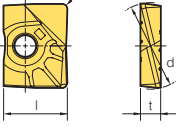
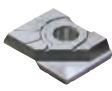
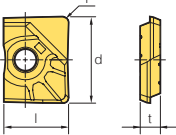
● : Stock item







Workpiece	Steel	P	●	●	●	●	●	●	●	●	●	●	●	●	●	●	Machining types
	Stainless steel	M	●	●	●	●	●	●	●	●	●	●	●	●	●	●	
Cast iron	K	●	●	●	●	●	●	●	●	●	●	●	●	●	●	●	● Continuous cutting ● General cutting ● Interrupted cutting
Non-ferrous metal	N	●	●	●	●	●	●	●	●	●	●	●	●	●	●		
Heat resistant alloy, Titanium alloy	S	●	●	●	●	●	●	●	●	●	●	●	●	●	●		
Hardened steel	H	●	●	●	●	●	●	●	●	●	●	●	●	●	●		

Inserts	Designation	Cermets		Coated								Uncoated		Dimensions (mm)					Geometries	Available tools			
		CN2500	CN30	NC5330	NCM535	NCM545	PC2505	PC2010	PC210F	PC3700	PC6510	PC9530	PC9540	PC5300	PC5400	ST30A	H01	l			d	t	r
 LBH-KH	080-KH							●									7.0	8	2.4	4.0	-		E324 E325
	100-KH						●	●									8.5	10	2.6	5.0	-		
	120-KH						●	●									10.0	12	3.0	6.0	-		
	130-KH						●	●									20.5	13	3.0	6.5	-		
	160-KH						●	●									12.0	16	4.0	8.0	-		
	170-KH						●	●									12.5	17	4.0	8.5	-		
	200-KH						●	●									15.0	20	5.0	10.0	-		
	210-KH						●	●									15.5	21	5.0	10.5	-		
	250-KH						●	●									18.5	25	6.0	12.5	-		
	260-KH						●	●									19.0	26	6.0	13.0	-		
	300-KH						●	●									22.5	30	7.0	15.0	-		
	320-KH							●									23.5	32	7.0	16.0	-		
	330-KH								●								24.0	33	7.0	16.5	-		
 LBS	080																7.0	8	2.4	4.0	-		E325- E328
	090																7.5	9	2.4	4.5	-		
	100																8.5	10	2.6	5.0	-		
	110																9.0	11	2.6	5.5	-		
	120																10.0	12	3.0	6.0	-		
	130																10.5	13	3.0	6.5	-		
	160																12.0	16	4.0	8.0	-		
	170																12.5	17	4.0	8.5	-		
	200																15.0	20	5.0	10.0	-		
	210																15.5	21	5.0	10.5	-		
	250																18.5	25	6.0	12.5	-		
	260																19.0	26	6.0	13.0	-		
 LCF	160-D90								●								13.7	16	4.0	-	-		E325- E328
	200-D90								●								17.0	20	5.0	-	-		
	250-D90																21.5	25	6.0	-	-		
 LFH	100																8.5	10	2.6	1.0	-		E325- E328
	120								●								10.0	12	3.0	1.0	-		
	160								●								12.0	16	4.0	1.5	-		
	200																15.0	20	5.0	1.5	-		
	250																18.5	25	6.0	2.0	-		
	300																22.5	30	7.0	2.0	-		
 LRH	100-R05																8.5	10	2.6	0.5	-		E325- E328
	100-R10																8.5	10	2.6	1.0	-		
	100-R20																8.5	10	2.6	2.0	-		
	110-R05																9.0	11	2.6	0.5	-		
	120-R05																10.0	12	3.0	0.5	-		
	120-R10																10.0	12	3.0	1.0	-		
	120-R20																10.0	12	3.0	2.0	-		
	130-R05																10.5	13	3.0	0.5	-		
	130-R10																10.5	13	3.0	1.0	-		
	160-R05																12.0	16	4.0	0.5	-		
 LR (Special type)	160-R10																12.0	16	4.0	1.0	-		
	160-R20																12.0	16	4.0	2.0	-		
	160-R30																12.0	16	4.0	3.0	-		
	170-R05																12.5	17	4.0	0.5	-		
	170-R10																12.5	17	4.0	1.0	-		
	200-R05																15.0	20	5.0	0.5	-		
	200-R10																15.0	20	5.0	1.0	-		
	200-R20																15.0	20	5.0	2.0	-		
200-R30																15.0	20	5.0	3.0	-			
210-R05																15.5	21	5.0	0.5	-			

● : Stock item




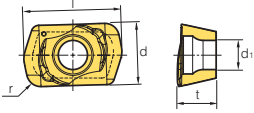

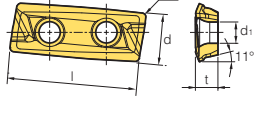

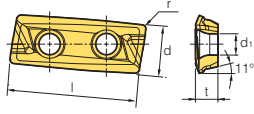








Workpiece	Steel	P	●	●	●	●	●	●	●	●	●	●	●	●	Machining types
	Stainless steel	M													
Cast iron	K		●	●	●	●	●	●	●	●	●	●	●	●	● Continuous cutting ● General cutting ✦ Interrupted cutting
Non-ferrous metal	N														
Heat resistant alloy, Titanium alloy	S														
Hardened steel	H														

Inserts	Designation	Cermets		Coated							Uncoated		Dimensions (mm)					Geometries	Available tools			
		CN2500	CN30	NC5330	NCM535	NCM545	PC2505	PC2510	PC2010	PC3700	PC6510	PC9530	PC9540	PC5300	PC5400	ST30A	H01			l	d	t
LPMW 	040210R						●	●					●			6.4	4.2	2.6	1.0	2.0		E281- E283
	040220R						●	●					●			6.4	4.2	2.6	2.0	2.0		
LXET-MA 	250404PEFR-32-MA															25	10.775	4.76	0.4	4.5		E394- E397
	2504PEFR-32-MA													●		25	10.775	4.76	0.8	4.5		
	250412PEFR-32-MA															25	10.775	4.76	1.2	4.5		
	250416PEFR-32-MA															25	10.775	4.76	1.6	4.5		
	250404PEFR-40-MA															25	10.618	4.76	0.4	4.5		
	2504PEFR-40-MA															25	10.618	4.76	0.8	4.5		
	250412PEFR-40-MA															25	10.618	4.76	1.2	4.5		
	250416PEFR-40-MA															25	10.618	4.76	1.6	4.5		
	340504PEFR-50-MA														●	34	13.765	5.56	0.4	5.56		
	3405PEFR-50-MA													●	34	13.765	5.56	0.8	5.56			
	340512PEFR-50-MA															34	13.765	5.56	1.2	5.56		
	340516PEFR-50-MA															34	13.765	5.56	1.6	5.56		
	340504PEFR-63-MA															34	13.803	5.56	0.4	5.56		
	3405PEFR-63-MA													●	34	13.803	5.56	0.8	5.56			
340512PEFR-63-MA															34	13.803	5.56	1.2	5.56			
340516PEFR-63-MA															34	13.803	5.56	1.6	5.56			
LXET-ML 	250404PEER-32-ML															25	10.775	4.76	0.4	4.5		E394- E397
	2504PEER-32-ML															25	10.775	4.76	0.8	4.5		
	250412PEER-32-ML															25	10.775	4.76	1.2	4.5		
	250416PEER-32-ML															25	10.775	4.76	1.6	4.5		
	250404PEER-40-ML															25	10.618	4.76	0.4	4.5		
	2504PEER-40-ML															25	10.618	4.76	0.8	4.5		
	250412PEER-40-ML															25	10.618	4.76	1.2	4.5		
	250416PEER-40-ML															25	10.618	4.76	1.6	4.5		
	340504PEER-50-ML															34	13.765	5.56	0.4	5.56		
	3405PEER-50-ML													●	34	13.765	5.56	0.8	5.56			
	340512PEER-50-ML															34	13.765	5.56	1.2	5.56		
	340516PEER-50-ML															34	13.765	5.56	1.6	5.56		
	340504PEER-63-ML															34	13.803	5.56	0.4	5.56		
	3405PEER-63-ML															34	13.803	5.56	0.8	5.56		
340512PEER-63-ML															34	13.803	5.56	1.2	5.56			
340516PEER-63-ML															34	13.803	5.56	1.6	5.56			


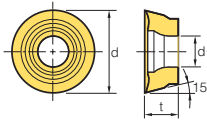


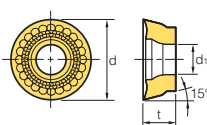

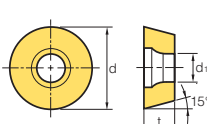



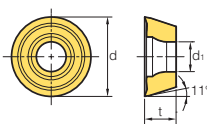
● : Stock item







Workpiece	Machining types											
	P	M	K	N	S	H	●	⦿	✱	●	⦿	✱
Steel	●	●	●	●	●	●	●	●	●	●	●	●
Stainless steel	●	●	●	●	●	●	●	●	●	●	●	●
Cast iron	●	●	●	●	●	●	●	●	●	●	●	●
Non-ferrous metal	●	●	●	●	●	●	●	●	●	●	●	●
Heat resistant alloy, Titanium alloy	●	●	●	●	●	●	●	●	●	●	●	●
Hardened steel	●	●	●	●	●	●	●	●	●	●	●	●


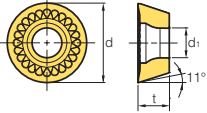

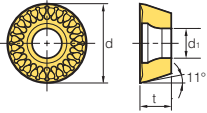

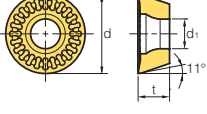

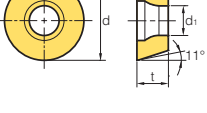


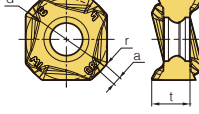

Inserts	Designation	Cermets		Coated							Uncoated		Dimensions (mm)						Geometries	Available tools					
		CN2500	CN30	NC5330	NCM325	NCM535	NCM545	PC2505	PC2510	PC3700	PC6510	PC9530	PC9540	PC5300	PC5400	ST30A	H01	l			d	t	r	d <sub>1</sub>	a
RDKT-MF 	10T3M0-MF										●	●				-	10	3.97	-	3.85	-				E228~
	1204M0-MF										●	●	●			-	12	4.76	-	4.5	-				E230
	1605M0-MF											●	●	●			-	16	5.56	-	5.5	-			
RDKT-ML 	1605M0-ML															-	16	5.56	-	5.5	-			E230 E236 E240 E241	
RDKT-MM 	10T3M0-MM				●					●	●	●	●			-	10	3.97	-	3.85	-				E228~
	1204M0-MM				●					●	●	●	●			-	12	4.76	-	4.5	-				E231
	1605M0-MM									●	●	●	●			-	16	5.56	-	5.5	-				E234~
	2006M0-MM									●	●	●	●			-	20	6.35	-	5.5	-				E237 E240 E241
RDKW 	0501M0E									●						-	5	1.59	-	2.3	-				E232
	06T1M0E									●						-	6	1.98	-	2.5	-				E233
	0702M0E									●						-	7	2.38	-	2.8	-				E238
	0803M0E									●						-	8	3.18	-	3.4	-				E239
REKR-MM 	170400-MM															-	17.8	4.76	-	-	-			E63	
RNMX-ML 	1204M0E-ML															-	12.0	4.75	6.0	-	2.0			E145 E146	
RPCT-MA 	10T3M0-MA													●		-	10	3.97	-	4.0	-				E242~
	1204M0-MA													●		-	12	4.76	-	4.5	-				E245
	1606M0-MA													●		-	16	6.35	-	5.5	-				E247~
	2007M0-MA													●		-	20	7.00	-	7.0	-				E253

● : Stock item

# E Milling Inserts

Workpiece	Steel	P											Machining types			
	Stainless steel	M														
Cast iron	K		●	●	●	●	●	●	●	●	●	●	●	●	●	●
Non-ferrous metal	N															
Heat resistant alloy, Titanium alloy	S															
Hardened steel	H															

● Continuous cutting  
 ● General cutting  
 ✱ Interrupted cutting


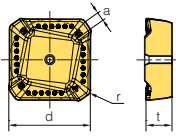

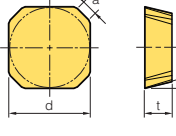

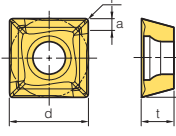

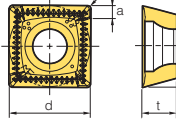

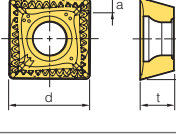

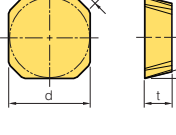
Inserts	Designation	Cermet		Coated							Uncoated		Dimensions (mm)						Geometries	Available tools					
		CN2500	CN30	NC5330	NCM325	NCM535	NCM545	PC2505	PC2510	PC3700	PC6510	PC9530	PC9540	PC5300	PC5400	ST30A	H01	l			d	t	r	d <sub>1</sub>	a
 RPMT-MF	0803M0E-MF												●	●			-	8	3.18	-	3.4	-			E242~ E253
	10T3M0E-MF												●	●			-	10	3.97	-	4.0	-			
	1204M0E-MF												●	●			-	12	4.76	-	4.5	-			
	1606M0E-MF												●	●			-	16	6.35	-	5.5	-			
	2007M0E-MF												●	●			-	20	7.00	-	7.0	-			
 RPET-ML	0803M0E-ML												●	●			-	8	3.18	-	3.4	-			E242~ E253
	10T3M0E-ML												●	●			-	10	3.97	-	4.0	-			
	1204M0E-ML												●	●			-	12	4.76	-	4.5	-			
	1606M0E-ML												●	●			-	16	6.35	-	5.5	-			
	2007M0E-ML												●	●			-	20	7.00	-	7.0	-			
 RPMT-MM	0803M0S-MM							●	●				●	●			-	8	3.18	-	3.4	-			E242~ E253
	10T3M0S-MM							●	●				●	●			-	10	3.97	-	4.0	-			
	1204M0S-MM								●	●			●	●			-	12	4.76	-	4.5	-			
	1606M0S-MM								●	●			●	●			-	16	6.35	-	5.5	-			
	2007M0S-MM								●	●			●	●			-	20	7.00	-	7.0	-			
 RPMW	0803M0E1							●	●				●	●			-	8	3.18	-	3.4	-			E242~ E253
	10T3M0E1							●	●				●	●			-	10	3.97	-	4.0	-			
	1204M0S1								●	●	●		●	●			-	12	4.76	-	4.5	-			
	1204M0S2												●	●			-	12	4.76	-	4.5	-			
	1606M0S1								●	●			●	●			-	16	6.35	-	5.5	-			
2007M0S1								●	●			●	●			-	20	7.00	-	7.0	-				
 SAGX-ML	140808ANER-ML												●	●			-	14	6.58	0.8	-	1.21			E181
 SAGX-MM	140808ANER-MM												●				-	14	6.58	0.8	-	1.21		E181	
 SNMX-MM	140808ANER-MM												●	●	●		-	14	6.58	0.8	-	1.21		E181	

● : Stock item






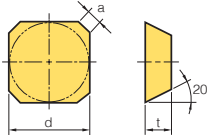

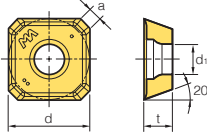

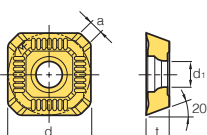

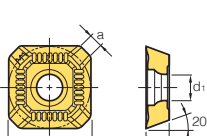

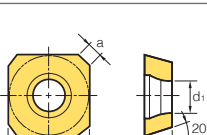

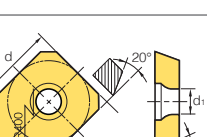
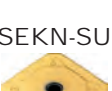
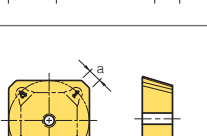
Workpiece	Machining types										
	P	M	K	N	S	H	●	●	●	●	●
Steel	●	●	●	●	●	●	●	●	●	●	●
Stainless steel	●	●	●	●	●	●	●	●	●	●	●
Cast iron	●	●	●	●	●	●	●	●	●	●	●
Non-ferrous metal	●	●	●	●	●	●	●	●	●	●	●
Heat resistant alloy, Titanium alloy	●	●	●	●	●	●	●	●	●	●	●
Hardened steel	●	●	●	●	●	●	●	●	●	●	●

Inserts	Designation	Material										Dimensions (mm)						Geometries	Available tools								
		Cermets		Coated					Uncoated			l	d	t	r	d <sub>1</sub>	a										
		CN2500	CN30	NCM325	NCM335	NCM535	NCM545	PC3700	PC6510	PC9530	PC9540	PC5300	PD1010	PD2000	ST30A	G10	H01	H05									
SCKN 	220715DDSR-MM			●	●	●	●	●	●	●	●	●	●	●	●	●	●	●	-	22.0	7.0	1.5	-	2.5		E58	
	280920DDSR-MM			●	●	●	●	●	●	●	●	●	●	●	●	●	●	●	-	28.0	9.0	2.0	-	3.0			
SDCN 	42M														●				-	12.7	3.18	-	-	1.5		E47 E48 E59 E60	
	42M-G														●				-	12.7	3.18	-	-	1.5			
	42MT	●	●	●											●				-	12.7	3.18	-	-	1.5			
	42MT-RH														●				-	12.7	3.18	-	-	1.5			
	42MT-S20									●					●				-	12.7	3.18	-	-	1.5			
	53M														●				-	15.875	4.76	-	-	1.5			
	53M-G														●				-	15.875	4.76	-	-	1.5			
	53MT	●	●												●				-	15.875	4.76	-	-	1.5			
	53MT-RH														●				-	15.875	4.76	-	-	1.5			
	53MT-S20									●					●				-	15.875	4.76	-	-	1.5			
	1203AEEN														●				-	12.7	3.18	-	-	1.5			
	1203AEEN-RH														●				-	12.7	3.18	-	-	1.43			
	1203AESN														●				-	12.7	3.18	-	-	1.5			
	1203AESN-RH														●				-	12.7	3.18	-	-	1.43			
1504AEEN														●				-	15.875	4.76	-	-	1.5				
1504AEEN-RH									●			●		●				-	15.875	4.76	-	-	1.43				
1504AESN														●				-	15.875	4.76	-	-	1.5				
1504AESN-RH									●					●				-	15.875	4.76	-	-	1.43				
SDET-MA 	09M402R-MA													●	●	●		-	9.525	3.923	0.2	4.0	1.2		E222~ E227		
	09M404R-MA													●	●	●		-	9.525	3.923	0.4	4.0	1.2				
	09M405R-MA													●	●	●		-	9.525	3.923	0.5	4.0	1.2				
	130504R-MA													●	●	●		-	13.5	5.56	0.4	5.56	2.2				
SDET-MF 	09M405R-MF													●	●	●		-	9.525	4	0.5	4	1.2		E222~ E227		
	130508R-MF													●	●	●		-	13.5	5.56	0.8	5.56	2.2				
SDET-MM 	09M405R-MM													●	●	●		-	9.525	4	0.5	4	1.2		E222~ E227		
	130508R-MM													●	●	●		-	13.5	5.56	0.8	5.56	2.2				
SDKN-CM 	42MT-CM	●																-	12.7	3.18	-	-	1.5		-		

● : Stock item



Workpiece	Material		Machining types												
	Color	Symbol	●	⦿	⦿	⦿	⦿	⦿	⦿	⦿	⦿	⦿	⦿	⦿	⦿
Steel	P	●	●	●	●	●	●	●	●	●	●	●	●	●	●
Stainless steel	M	●	●	●	●	●	●	●	●	●	●	●	●	●	●
Cast iron	K	●	●	●	●	●	●	●	●	●	●	●	●	●	●
Non-ferrous metal	N	●	●	●	●	●	●	●	●	●	●	●	●	●	●
Heat resistant alloy, Titanium alloy	S	●	●	●	●	●	●	●	●	●	●	●	●	●	●
Hardened steel	H	●	●	●	●	●	●	●	●	●	●	●	●	●	●

Inserts	Designation	Cermets		Coated							Uncoated			Dimensions (mm)						Geometries	Available tools		
		CN2500	CN30	NCM325	NCM335	PC3700	PC6510	PC9530	PC9540	PC5300	PD1010	PD2000	ST30A	G10	H01	H05	l	d	t			r	d <sub>1</sub>
 SECN	1203AFFN		●									●	●		-	12.7	3.18	-	-	-	2.36	 ► Shape of Edge - S20: STS - RH: Strengthened edge, STS	E49 E50
	1203AFTN	●	●									●			-	12.7	3.18	-	-	-	2.36		
	1203AFEN														-	12.7	3.18	-	-	-	2.36		
	1203AFSN			●	●										-	12.7	3.18	-	-	-	2.36		
	1203AFEN-RH						●			●					-	12.7	3.18	-	-	-	2.36		
	1203AFSN-RH														-	12.7	3.18	-	-	-	2.36		
	1203AFTN-S20									●					-	12.7	3.18	-	-	-	2.36		
	1504AFFN												●		-	15.875	4.76	-	-	-	2.4		
	1504AFTN		●												-	15.875	4.76	-	-	-	2.4		
	1504AFEN														-	15.875	4.76	-	-	-	2.4		
	1504AFSN														-	15.875	4.76	-	-	-	2.4		
	1504AFEN-RH														-	15.875	4.76	-	-	-	2.4		
	1504AFSN-RH							●							-	15.875	4.76	-	-	-	2.4		
	1504AFTN-S20														-	15.875	4.76	-	-	-	2.4		
 SEET-MA	0903AGFN-MA												●	●	-	9.525	3.18	-	3.4	2.11		E216- E221	
	14M4AGFN-MA												●	●	-	14.0	4.0	-	4.4	2.64			
 SEET-MF	0903AGSN-MF					●	●		●	●					-	9.525	3.18	-	3.4	2.11		E216- E221	
	14M4AGSN-MF					●	●		●	●					-	14.0	4.0	-	4.4	2.64			
 SEET-MM	0903AGSN-MM			●		●			●	●					-	9.525	3.18	-	3.4	2.11		E216- E221	
	14M4AGSN-MM			●	●	●	●		●	●					-	14.0	4.0	-	4.4	2.64			
 SEEW	0903AGTN														-	9.525	3.18	-	3.4	2.11		E216- E221	
	14M4AGTN	●													-	14.0	4.0	-	4.4	2.64			
 SEEW-W	14M4AGFN-W														-	14.0	4.0	-	4.4	8.5		E217 E219 E221	
	14M4AGSN-W									●					-	14.0	4.0	-	4.4	8.5			
	14M4AGTN-W						●								-	14.0	4.0	-	4.4	8.5			
 SEKN-SU	1203AFSN-SU				●										-	12.7	3.18	-	-	1.98		E49 E50	
	1504AFSN-SU				●				●						-	15.875	4.76	-	-	2.04			

● : Stock item





Workpiece	Steel	P												Machining types			
	Stainless steel	M															
Cast iron	K																
Non-ferrous metal	N																
Heat resistant alloy, Titanium alloy	S																
Hardened steel	H																

● Continuous cutting  
 ● General cutting  
 ✱ Interrupted cutting







Inserts	Designation	Cermets		Coated							Uncoated		Dimensions (mm)								Geometries	Available tools			
		CN2500	CN30	NC5330	NCM325	NCM535	NCM545	PC2505	PC2010	PC3700	PC6510	PC9530	PC9540	PC5300	PC5400	ST30A	H01	l	d	t			r	d <sub>1</sub>	a
SNC(M)F-MF	SNMF 1206QNN-MF								●								-	12.7	6.6	0.8	-	1	-		E140
	SNCF 1206QNN-MF								●								-	12.7	6.6	0.8	-	1	-		
SNC(M)F-MM	SNMF 1206ANN-MM																-	12.7	6.6	-	-	2	-		E136
	1507ANN-MM																-	15.875	7.35	-	-	2.1	-		
	SNCF 1206ANN-MM																-	12.7	6.6	-	-	2	-		
	1507ANN-MM																-	15.875	7.35	-	-	2.1	-		
SNC(M)F-MM	SNMF 1206ENN-MM								●								-	12.7	6.6	-	-	1.8	-		E138
	1507ENN-MM								●								-	15.875	7.35	-	-	1.8	-		
	SNCF 1206ENN-MM																-	12.7	6.6	-	-	1.8	-		
	1507ENN-MM																-	15.875	7.35	-	-	1.8	-		
SNC(M)F-MM	SNMF 1206QNN-MM								●								-	12.7	6.6	0.8	-	1	-		E140
	SNCF 1206QNN-MM								●								-	12.7	6.6	0.8	-	1	-		
SNCN	1204ENN			●											●		-	12.7	4.76	-	-	1.4	1.0		E52
	1504ENN																-	15.875	4.76	-	-	1.4	1.0		
SNEF	435								●								-	12.7	4.76	2.0	-	-	-		-
	535																-	15.875	4.76	2.0	-	-	-		
SNEU-MF	120420-MF								●								-	12.7	4.76	2.0	5.7	(2.3)	-		E423
SNEU-MF	1204ANN-MF																-	12.7	4.76	-	5.7	(2.0)	-		E423

● : Stock item





Workpiece	Machining types									
	P	M	K	N	S	H	●	⊕	⊛	⊚
Steel	●	●	●	●	●	●	●	●	●	●
Stainless steel	●	●	●	●	●	●	●	●	●	●
Cast iron	●	●	●	●	●	●	●	●	●	●
Non-ferrous metal	●	●	●	●	●	●	●	●	●	●
Heat resistant alloy, Titanium alloy	●	●	●	●	●	●	●	●	●	●
Hardened steel	●	●	●	●	●	●	●	●	●	●

Inserts	Designation	Cermets		Coated						PCD		Dimensions (mm)							Geometries	Available tools			
		CN2500	CN30	NC5330	NCM535	NCM545	PC2010	PC3700	PC6510	PC9530	PC9540	PC5300	PC5400	DP150	DP200	l	d	t			r	d <sub>1</sub>	a
SNHT-WX 	1102308R-WX									●				-	11	2.30	-	4	-	-			
	110308R-WX									●				-	11	3.00	-	4	-	-			
	1203508R-WX									●				-	12.7	3.50	-	5	-	-			
	120408R-WX									●				-	12.7	4.00	-	5	-	-			
	1204508R-WX									●				-	12.7	4.54	-	5	-	-			
	120508R-WX									●				-	12.7	5.00	-	5	-	-			
	1205408R-WX									●				-	12.7	5.47	-	5	-	-			
	120608R-WX									●				-	12.7	6.00	-	5	-	-			
	1206508R-WX									●				-	12.7	6.50	-	5	-	-			
	120708R-WX									●				-	12.7	7.00	-	5	-	-			
	1207508R-WX									●				-	12.7	7.5	-	5	-	-			
	1102308L-WX										●				-	11	2.30	-	4	-	-		
	110308L-WX										●				-	11	3.00	-	4	-	-		
	120308L-WX										●				-	12.7	3.25	-	5	-	-		
	1203508L-WX										●				-	12.7	3.50	-	5	-	-		
	120408L-WX										●				-	12.7	4.00	-	5	-	-		
	1204508L-WX										●				-	12.7	4.54	-	5	-	-		
	120508L-WX										●				-	12.7	5.00	-	5	-	-		
	1205408L-WX										●				-	12.7	5.47	-	5	-	-		
	120608L-WX										●				-	12.7	6.00	-	5	-	-		
1206508L-WX										●				-	12.7	6.50	-	5	-	-			
120708L-WX										●				-	12.7	7.00	-	5	-	-			
1207508L-WX										●				-	12.7	7.5	-	5	-	-			
SNKN 	1204ENN									●				-	12.7	4.76	-	-	1.4	1.0			
	1504ENN									●				-	15.875	4.76	-	-	1.4	1.0			
SNM(E)X-MF 	SNMX 1206ANN-MF				●		●	●	●	●	●			-	12.7	6.35	-	4.5	2.36	-			
	1507ANN-MF				●		●	●	●	●	●			-	15.875	7.94	-	5.6	3.15	-			
	SNEX 1206ANN-MF							●	●	●	●			-	12.7	6.35	-	4.5	2.36	-			
	1507ANN-MF								●	●	●			-	15.875	7.94	-	5.6	3.15	-			
SNM(E)X-MF 	SNMX 1206ENN-MF				●		●	●	●	●	●			-	12.7	6.35	-	5.2	1.82	-			
	1507ENN-MF				●		●	●	●	●	●			-	15.875	7.94	-	5.6	2.66	-			
	SNEX 1206ENN-MF							●	●	●	●			-	12.7	6.35	-	5.2	1.82	-			
	1507ENN-MF								●	●	●			-	15.875	7.94	-	5.6	2.66	-			
SNM(E)X-MF 	SNMX 1206QNN-MF				●		●	●	●	●	●			-	12.7	6.35	-	5.2	2.36	-			
	120612-MF							●	●	●	●			-	12.7	6.35	1.2	5.2	-	-			
	SNEX 1206QNN-MF							●	●	●	●			-	12.7	6.35	-	5.2	2.36	-			
	120612-MF								●	●	●			-	12.7	6.35	1.2	5.2	-	-			
SNM(E)X-MM 	SNMX 1206ANN-MM				●	●		●	●	●	●			-	12.7	6.35	-	4.5	2.36	-			
	1507ANN-MM				●			●	●	●	●			-	15.875	7.94	-	5.6	3.15	-			
	SNEX 1206ANN-MM							●	●	●	●			-	12.7	6.35	-	4.5	2.36	-			
	1507ANN-MM								●	●	●			-	15.875	7.94	-	5.6	3.15	-			

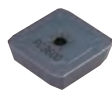
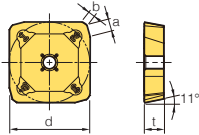

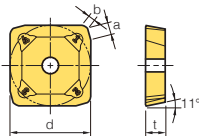

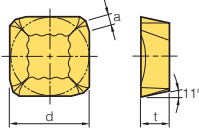
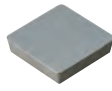
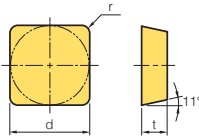

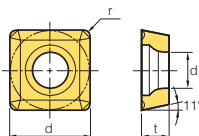

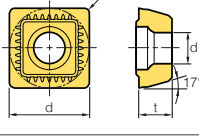

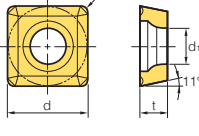

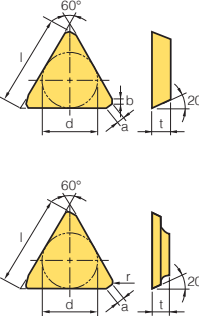

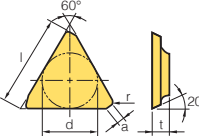
● : Stock item





Workpiece	Steel	P											Machining types						
	Stainless steel	M																	
Cast iron	K																		
Non-ferrous metal	N																		
Heat resistant alloy, Titanium alloy	S																		
Hardened steel	H																		

● Continuous cutting  
 ● General cutting  
 ✱ Interrupted cutting

Inserts	Designation	Cermet		Coated							Uncoated		Dimensions (mm)						Geometries	Available tools					
		CN2500	CN30	NC5330	NCM325	NCM335	NCM535	NCM545	PC3700	PC6510	PC9530	PC9540	PC5300	PC5400	ST30A	G10	H01	l			d	t	r	d <sub>i</sub>	a
SPKN-MU 	1203EDSR-MU								●								-	12.7	3.18	-	-	0.86	1.87		E53 E54
	1504EDSR-MU								●								-	15.875	4.76	-	-	0.84	1.92		
SPKN-SU 	1203EDSR-SU								●								-	12.7	3.18	-	-	1.66	0.92		E53 E54
	1203EDSL-SU								●								-	12.7	3.18	-	-	1.66	0.92		
	1504EDSR-SU								●								-	15.875	4.76	-	-	1.62	0.93		
	1504EDSL-SU								●								-	15.875	4.76	-	-	1.62	0.93		
SPKR-MX 	1203EDSR-MX				●	●											-	12.7	3.18	-	-	1.4	-		E53 E54
	1203EDSL-MX																-	12.7	3.18	-	-	1.4	-		
	1504EDR-MX				●												-	15.875	4.76	-	-	1.45	-		
	1504EDSR-MX																-	15.875	4.76	-	-	1.45	-		
SPMN 	120308																-	12.7	3.18	0.8	-	-	-		E369
SPMT 	060304				●												-	6.35	3.18	0.4	2.8	-	-		E307 E334 E335
SPMT-KC 	110408-KC								●								-	11.5	4.8	0.8	4.5	-	-		E369
SPMT-MM 	120408-MM								●								-	12.7	4.76	0.8	5.6	-	-		E307 E334 E336 E352
	120508-MMN																-	12.7	5.56	0.8	5.6	-	-		
TEC(E)N 	TECN 22R																11.0	6.35	3.18	-	-	1.0	0.5		E61
	22TR				●												11.0	6.35	3.18	0.8	-	0.5	-		
	32R																16.5	9.525	3.18	-	-	1.0	0.5		
	32R-G																16.5	9.525	3.18	-	-	1.0	0.5		
	32TR				●	●											16.5	9.525	3.18	0.8	-	0.5	-		
	32TR-S20																16.5	9.525	3.18	0.8	-	0.5	-		
	43R-G																22.0	12.7	4.76	-	-	2.0	0.5		
43TR-Z																22.0	12.7	4.76	0.8	-	1.5	-			
TEEN 	TEEN 32TR																16.5	9.525	3.18	0.8	-	0.5	-		
	43R-Z																22.0	12.7	4.76	-	-	2.0	0.5		
	43TR-Z																22.0	12.7	4.76	0.8	-	1.5	-		
	43TR-ZH																22.0	12.7	4.76	0.8	-	1.5	-		
	43R																22.0	12.7	4.76	-	-	2.0	0.5		
	43R-G																22.0	12.7	4.76	-	-	2.0	0.5		
43TR				●	●				●							22.0	12.7	4.76	0.8	-	1.5	-			
43TR-S20																22.0	12.7	4.76	0.8	-	1.5	-			


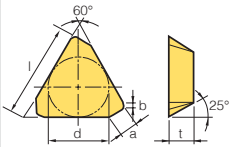
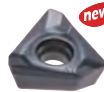
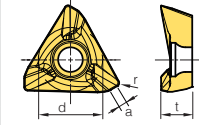

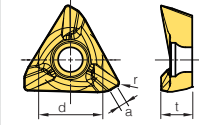

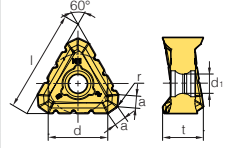

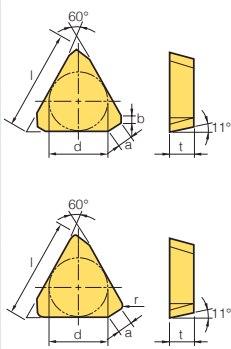
▶ Shape of Edge  
 - G: Light side, Sharp edge  
 - S20: STS  
 - ZH: Hole added

● : Stock item

# E Milling Inserts

Workpiece	Steel	P	●	●	●	●	●	●	●	●	●	●	●	Machining types					
	Stainless steel	M			●	●					●	●	●	●	●	●	●	●	●
	Cast iron	K		●										●	●	●	●	●	●
	Non-ferrous metal	N																	●
	Heat resistant alloy, Titanium alloy	S																	●
Hardened steel	H																		●

● Continuous cutting  
 ● General cutting  
 ✱ Interrupted cutting

Inserts	Designation	Cermets		Coated								Uncoated		Dimensions (mm)							Geometries	Available tools				
		CN2500	CN30	NC5330	NCM325	NCM335	NCM535	NCM545	PC3700	PC6510	PC9530	PC9540	PC5300	PC5400	ST30A	G10	H01	l	d	t			r	d <sub>1</sub>	a	b
TFCN 	2203PFR													●			22.0	12.7	3.18	-	-	2.42	0.71		E55	
	2203PFL																22.0	12.7	3.18	-	-	2.42	0.71			
TNKT-ML 	110508PEER-ML																-	8.0	4.500	0.8	-	1.3	-		E258~ E261	
	160608PEER-ML																-	11.7	5.500	0.8	-	1.5	-			
	200708PEER-ML																-	14.5	7.000	0.8	-	2.0	-			
TNKT-MM 	110508PESR-MM																-	8.0	4.531	0.8	-	1.3	-		E258~ E261	
	160608PESR-MM																-	11.7	5.531	0.8	-	1.5	-			
	200708PESR-MM																-	14.5	7.031	0.8	-	2.0	-			
TNMX-NM 	2710AZNR-NM			●													27	15.875	10	0.8	5.6	2.63	-		E68~ E70	
	2710AZNL-NM																27	15.875	10	0.8	5.6	2.63	-			
	3012PNR-NM																30	17.462	11.970	0.8	5.6	3.5	-			
TPCN 	1103PPN	●												●	●		11.0	6.35	3.18	-	-	0.7	0.7		E56	
	1103PPTN																11.0	6.35	3.18	-	-	0.7	0.7			
	1603PDR			●													16.5	9.525	3.18	-	-	1.2	0.7			
	1603PPN	●	●											●	●		16.5	9.525	3.18	-	-	1.2	1.2			
	1603PPR	●	●											●	●		16.5	9.525	3.18	-	-	1.2	1.0			
	1603PPR-RH																16.5	9.525	3.18	-	-	1.2	1.0			
	1603PPR-G													●			16.5	9.525	3.18	-	-	1.2	1.0			
	1603PPSR																16.5	9.525	3.18	-	-	1.2	1.0			
	1603PPTN																16.5	9.525	3.18	-	-	1.2	1.2			
	1603PPTR																16.5	9.525	3.18	-	-	1.2	1.0			
	1603PPTR-RH																16.5	9.525	3.18	-	-	1.2	1.0			
	1603PDER-RH																16.5	9.525	3.18	0.8	-	1.5	-			
	1603PDSR-RH																16.5	9.525	3.18	0.8	-	1.5	-			
	1603PDR-S20																16.5	9.525	3.18	-	-	1.2	0.7			
	1603PDR-RN																16.5	9.525	3.18	-	-	1.5	1.1			
	2204PDR	●	●												●	●		22.0	12.7	4.76	-	-	1.4			0.7
	2204PDR-RH																22.0	12.7	4.76	-	-	1.4	0.7			
	2204PDR-RN																22.0	12.7	4.76	-	-	1.42	0.52			
	2204PDR-G														●		22.0	12.7	4.76	-	-	1.4	0.7			
	2204PDL														●		22.0	12.7	4.76	-	-	1.4	0.7			
	2204PDSR				●												22.0	12.7	4.76	-	-	1.4	0.7			
	2204PDTR																22.0	12.7	4.76	-	-	1.4	0.7			
	2204PPN																22.0	12.7	4.76	-	-	1.2	1.2			
	2204PPTN																22.0	12.7	4.76	-	-	1.2	1.2			
	2204PDR-RH																22.0	12.7	4.76	0.8	-	1.8	-			
	2204PDER-RH																22.0	12.7	4.76	0.8	-	1.8	-			
2204PDSR-RH																22.0	12.7	4.76	0.8	-	1.8	-				
2204PDR-S20																22.0	12.7	4.76	-	-	1.4	0.7				

※ In this page, TPC(K)N □□□□P-N is for FC·HC and □□□□P-R is for Cutter (face).

● : Stock item


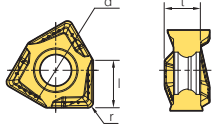

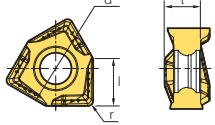

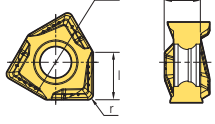

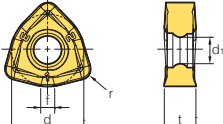

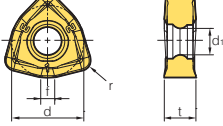

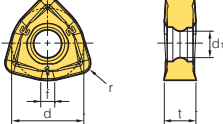




# E Milling Inserts

Workpiece	Steel	P											Machining types							
	Stainless steel	M		●	●	●	●	●	●	●	●	●	●	●	●	●	●	●	●	●
Cast iron	K		●	●	●	●	●	●	●	●	●	●	●	●	●	●	●	●	●	●
Non-ferrous metal	N																			
Heat resistant alloy, Titanium alloy	S																			
Hardened steel	H		●	●	●															

● Continuous cutting  
 ● General cutting  
 ● Interrupted cutting

Inserts	Designation	Cermets		Coated							Uncoated		Dimensions (mm)						Geometries	Available tools				
		CN2500	CN30	NCM535	NCM545	PC2010	PC2505	PC2510	PC3700	PC6510	PC9530	PC9540	PC5300	PC5400	ST30A	H01	l	d			t	r	d <sub>1</sub>	f
	040304PNFR-MA													●	4.3	7.0	3.46	0.4	-	-				E120- E125
	040308PNFR-MA														4.3	7.0	3.46	0.8	-	-				
	040312PNFR-MA													●	4.3	7.0	3.46	1.2	-	-				
	040316PNFR-MA													●	4.3	7.0	3.46	1.6	-	-				
	080604PNFR-MA													●	8.2	13.0	6.4	0.4	-	-				
	080608PNFR-MA													●	8.2	13.0	6.4	0.8	-	-				
	080612PNFR-MA													●	8.2	13.0	6.4	1.2	-	-				
	080616PNFR-MA													●	8.2	13.0	6.4	1.6	-	-				
	080620PNFR-MA													●	8.2	13.0	6.4	2.0	-	-				
	040304PNER-ML									●		●	●		4.3	7.0	3.46	0.4	-	-				E120- E125
	040308PNER-ML											●	●		4.3	7.0	3.46	0.8	-	-				
	040312PNER-ML												●		4.3	7.0	3.46	1.2	-	-				
	040316PNER-ML												●		4.3	7.0	3.46	1.6	-	-				
	080604PNER-ML								●		●	●	●		8.2	13.0	6.4	0.4	-	-				
	080608PNER-ML			●					●	●	●	●	●		8.2	13.0	6.4	0.8	-	-				
	080612PNER-ML								●	●	●	●	●		8.2	13.0	6.4	1.2	-	-				
	080616PNER-ML											●	●		8.2	13.0	6.4	1.6	-	-				
	080620PNER-ML											●	●		8.2	13.0	6.4	2.0	-	-				
	040304PNSR-MM									●		●	●		4.3	7.0	3.46	0.4	-	-				E120- E125
	040308PNSR-MM											●	●		4.3	7.0	3.46	0.8	-	-				
	040312PNSR-MM												●		4.3	7.0	3.46	1.2	-	-				
	040316PNSR-MM												●		4.3	7.0	3.46	1.6	-	-				
	080604PNSR-MM								●		●	●	●		8.2	13.0	6.4	0.4	-	-				
	080608PNSR-MM			●					●	●	●	●	●		8.2	13.0	6.4	0.8	-	-				
	080612PNSR-MM								●	●	●	●	●		8.2	13.0	6.4	1.2	-	-				
	080616PNSR-MM											●	●		8.2	13.0	6.4	1.6	-	-				
	080620PNSR-MM											●	●		8.2	13.0	6.4	2.0	-	-				
	060312ZNN-MF											●	●		-	6.35	3.18	1.2	2.86	1.2				E289- E299
	09T316ZNN-MF								●			●	●		-	9.525	3.97	1.6	3.6	1.7				
	130520ZNN-MF											●	●		-	12.7	5.56	2.0	4.7	2.5				
	160720ZNN-MF											●	●		-	16.0	7.0	2.0	5.8	3.0				
	060312ZNN-ML											●	●		-	6.35	3.18	1.2	2.86	1.2				E289- E299
	09T316ZNN-ML											●	●		-	9.525	3.97	1.6	3.6	1.7				
	130520ZNN-ML											●	●		-	12.7	5.56	2.0	4.7	2.5				
	160720ZNN-ML											●	●		-	16.0	7.0	2.0	5.8	3.0				
	060312ZNN-MM					●	●	●				●	●		-	6.35	3.18	1.2	2.86	1.2				E289- E299
	09T316ZNN-MM					●	●	●	●			●	●		-	9.525	3.97	1.6	3.6	1.7				
	130520ZNN-MM					●	●	●	●	●		●	●		-	12.7	5.56	2.0	4.7	2.5				
	160720ZNN-MM					●	●	●				●	●		-	16.0	7.0	2.0	5.8	3.0				

● : Stock item




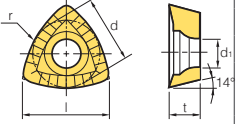

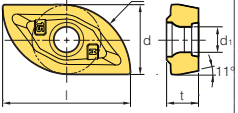

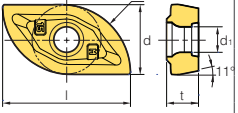

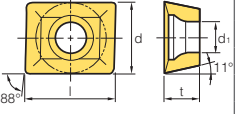

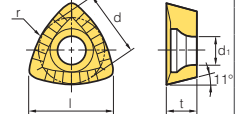

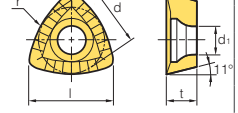



















Workpiece	Machining types										
	P	M	K	N	S	H	●	⊙	⊛	⊞	⊟
Steel	●	●	●	●	●	●	●	●	●	●	●
Stainless steel	●	●	●	●	●	●	●	●	●	●	●
Cast iron	●	●	●	●	●	●	●	●	●	●	●
Non-ferrous metal	●	●	●	●	●	●	●	●	●	●	●
Heat resistant alloy, Titanium alloy	●	●	●	●	●	●	●	●	●	●	●
Hardened steel	●	●	●	●	●	●	●	●	●	●	●










Inserts	Designation	Cermets		Coated							Uncoated		Dimensions (mm)					Geometries	Available tools		
		CN2500	CN30	NC5330	NCM535	NCM545	PC2505	PC2510	PC3700	PC6510	PC9530	PC9540	PC5300	PC5400	ST30A	H01	l			d	t
 ZDMT-R-MM	080310R-MM							●				●			8.4	6.73	3.2	10	2.8		E339 E340
	110312.5R-MM							●				●			10.6	8.5	3.65	12.5	2.8		
	130416R-MM								●				●			13.2	10.5	4.76	16		
 ZPET-MM Internal	080M-MM														16	8.0	3.5	8	2.9		E332~ E334
	090M-MM														17.7	7.2	4.3	9	3.4		
	100M-MM							●	●			●			19	10.4	4.5	10	3.4		
	110M-MM														22.2	11.4	4.8	11	4.5		
	125M-MM							●	●			●			24	12.9	5.3	12.5	4.5		
	130M-MM														25.7	13.4	5.3	13	4.5		
	140M-MM														27.2	14.3	6.3	14	5.6		
	150M-MM								●				●		28	15.4	7	15	5.6		
	160M-MM								●	●			●		28.5	16.4	7	16	5.6		
	200M-MM								●						38	20.7	8	20	6.6		
250M-MM														48	25.9	9.5	25	8.6			
 ZPET-MM External	080S-MM														15	6.6	3.1	8	2.9		E332~ E334
	090S-MM														15.5	7.4	3.7	9	3.4		
	100S-MM							●	●			●			15.5	8.4	3.8	10	3.4		
	110S-MM														18.1	9	4.4	11	4.5		
	125S-MM							●	●			●			20.5	10.7	4.5	12.5	4.5		
	130S-MM														22.2	11	4.4	13	4.5		
	140S-MM														24.1	11.2	5.7	14	5.6		
	150S-MM								●				●		25	12.4	6.5	15	5.6		
	160S-MM								●	●			●		26	13.4	6.5	16	5.6		
	200S-MM								●						32	16.7	7	20	6.6		
250S-MM														40	20.7	8.5	25	8.6			
 ZPMT-MM	1504PPSR-MM							●				●			15.9	12.7	4.76	-	5.6		E307 E352
	1505PPSR-MMN														15.9	12.7	5.76	-	5.6		
 ZPMT-R-MM	160520R-MM							●				●			16.1	12.7	5.56	20	5.6		E336
	160525R-MM							●				●			16.9	12.7	5.56	25	5.6		
	160531.5R-MM												●			17.6	12.7	5.56	31.5		
 ZPMT-R-MR	160525R-MR														17.6	12.7	5.56	25	5.6		E335 E336

● : Stock item











Type	Cutter	Designation	Shape	A.A	Diameter range	Features	Application					Page
							Facing	Shouldering	Slotting	Copying	Ramping, Helical	
Cutters for face milling	Mill-max	ADN(M) 4000/5000+		45°	Ø80-Ø315	Excellent cutting-edge strength and chip flow	●					E47 E48
		AE(M) 4000/5000		45°	Ø80-Ø315	Low cutting load and good machinability	●					E49 E50
		EF(M) 4000	<span>Al</span> 	75°	Ø80-Ø315	High rake angle to prevents welding	●					E51
		EN(M) 4000		75°	Ø80-Ø315	Economical because double sided inserts applied	●					E52
		EPN(M) 4000/5000+		75°	Ø80-Ø315	Double posi rake angle and low cutting force	●					E53 E54
		PF(M) 4000	<span>Al</span> 	90°	Ø80-Ø315	High rake angle and good machinability	●	●	●			E55
		PPN(M) 4000		90°	Ø80-Ø315	Double posi rake angle and low cutting force	●	●	●			E56
	Mill-max Heavy	HDDCM 7000/9000 <span>new</span>		55°	Ø125-Ø315	Deep roughing availability thanks to highly rigid inserts	●					E58
	Turbo Mill	ADS 4000/5000		45°	Ø50-Ø63	Anti-vibration	●					E59 E60
		PES 2000/3000/ 4000		90°	Ø20-Ø63	High rake angle, Cutting efficiency	●	●	●			E61
	Double Mill	AFO(M)4000		45°	Ø80-Ø125	High rake angle low cutting force	●					E62
		AFO(M)5000			Ø80-Ø315	Economical (8 corners available)						E63

Al Cutter for aluminum





















Type	Cutter	Designation	Shape	A.A	Diameter range	Features	Application					Page
							Facing	Shouldering	Slotting	Copying	Ramping, Helical	
Cutters for face milling	Power Buster	PBAC(M)5000		45°	Ø80-Ø315		●					E68
		PBZC(M)5000		90°	Ø80-Ø315	Double-sided Insert High depth High feed roughing	●					E69
		PBPCM6000 <small>new</small>			Ø80-Ø315		● ●				E70	
	Aero Mill	APD(M) A type	<b>Al</b> 	90°	Ø80-Ø315	Aluminum cutter body suitable for high speed machining. Both cemented carbides and PCD inserts are available, G2.5 balance possible	●					E151
	Aero Mill - Plus	APD(M)-PB	<b>Al</b> 	90°	Ø80-Ø315	Prevent overload to the spindle bearings through weight reduction of the Al alloy body and enable high-speed processing	●					E152 E153
	Aero Mill-Mini	MAPDS	<b>Al</b> 	90°	Ø40-Ø63	Available with small Machining center-Carbide, PCD insert	●					E154
		MAPD	<b>Al</b> 	90°	Ø32-Ø40	Application-Balancing class G2.5	●					E155
	Rich Mill	RM8AC(M)4000 RMH8AC(M)4000		45°	Ø50-Ø400	8 corners available Double-sided insert for steel, cast iron, stainless steel, aluminum	●					E126 E127
		RM8AC(M)5000 RMH8AC(M)5000			Ø80-Ø400		●				E128 E129	
		RM8EC(M)4000 RMH8EC(M)4000		75°	Ø50-Ø400	8 corners available Double-sided insert for steel, cast iron	●					E130 E131
		RM8EC(M)5000 RM8HEC(M)5000			Ø80-Ø400		●				E132 E133	

**Al** Cutter for aluminum
















Type	Cutter	Designation	Shape	A.A	Diameter range	Features	Application					Page
							Facing	Shouldering	Slotting	Copying	Ramping, Helical	
Cutters for face milling	Rich Mill	RM8QC(M)4000 RMH8QC(M)4000		88°	Ø63~Ø200	8 corners available Reduced cutting interruption at cast Iron	●					E134 E135
		RMT8A(M) 4000/5000		45°	Ø80~Ø315		●					E136 E137
		RMT8E(M) 4000/5000		75°	Ø80~Ø315	Easy insert change and good machinability due to latch clamping system 8 corners available Excellent surface finish	●					E138 E139
		RMT8Q(M) 4000		88°	Ø80~Ø315		●					E140
		RMX8AC(M)- SA14 <small>new</small>		45°	Ø50~Ø125	Double sided insert with 8 corners Stable cutting performance due to double reversal positive relief surface Good machinability in stainless cutting with High helix cutting edge	●					E141
		RM14XCM- XN06 <small>new</small>		51°	Ø50~Ø160	Double sided insert with 14 corners Suitable for automobile components machining	●					E142
		RM16AC(M) 6000/8000		45°	Ø63~Ø400	16 corners available Wiper inserts can be applied for good surface finish Strong insert and powerful clamping	●					E143 E144
		RMRC(M)-RN12 <small>new</small>		-	Ø50~Ø125	High cost efficiency due to double sided round typed cutting edge Excellent rotating prevention by strong clamping system Suitable for Inconel cutting	●					E145
Cutters for molds	Rich Mill	RM3PC(M)3000 <small>new</small>			Ø40~Ø80						E99	
		RM3PC(M)4000 <small>new</small>		90°	Ø40~Ø125	Perfect perpendicularity Strong clamping	●	●	●	●	E100	
		RM3PC(M)5000 <small>new</small>			Ø80~Ø125						E101	
		RM4PC(M)3000		90°	Ø40~Ø100	4 corners available High rake angle insert reduces cutting force. Excellent insert rigidity	●	●	●	●	E105 E106	
		RM4PC(M)4000			Ø50~Ø160							




Type	Cutter	Designation	Shape	A.A	Diameter range	Features	Application					Page							
							Facing	Shouldering	Slotting	Copying	Ramping, Helical								
Cutters for molds	Rich Mill	RM4ZCM3000		90°	Ø40~Ø52	4 corners available In vertical machining, the maximum cutting depth for RM4Z3000: 9.00 mm, RM4Z4000: 14.0 mm	●	●	●	●	●	E118							
		RM4ZC(M)4000			Ø63~Ø100														
		RM6PCM-WN04 <small>new</small>		90°	Ø40~Ø63								Improved productivity and high-quality shouldering through high speed and high feed machining	●	●	●	●	●	E120
		RM6PC(M)-WN08 <small>new</small>			Ø50~Ø125														
	Alpha Mill-X	AMXCM-AD10/12/17 <small>new</small>		90°	Ø40~Ø125	High rake angle cutting edge and chip breaker reduce cutting load and improve chip evacuation. High rigidity due to special design	●	●	●	●	●	E197 E198							
	Alpha Mill	AMC(M) 1000S/1500S/2000S		90°	Ø32~Ø100	3-dimensional shape and high rake angle lowers cutting load and ensures better chip evacuation Inner coolant system for better chip control increases tool life Wide size range of inserts enlarges application range. Various types of Alpha Mills available for high depth of cut and high feed machining	●	●	●	●	●	E164~ E166							
		AMC(M) 3000S/3000S-K /4000S		90°	Ø40~Ø200		●	●	●	●	●	E167~ E169							
		AMC(M) 1000SE 2000SE 3000SE		75°	Ø40~Ø100		●	●	●	●	●	E170 E171							
		AMC(M) 2000M 3000M 4000M		90°	Ø50~Ø125		●	●	●	●	●	E172~ E174							
	Future Mill	FMAC(M)3000		45°	Ø50~Ø125	Accurate inserts and cutter, Excellent chip flow	●					E226							
		FMAC(M)4000			Ø50~Ø200								E227						
		FMAC(M)3000-A		45°	Ø63~Ø125	Excellent in high speed cutting and tapping center, low power machine due to light aluminum body	●					E228							
		FMAC(M)4000-A			Ø63~Ø315								E229						














Type	Cutter	Designation	Shape	A.A	Diameter range	Features	Application					Page	
							Facing	Shouldering	Slotting	Copying	Ramping, Helical		
Cutters for molds	Future Mill	FMPC(M)3000		90°	Ø50~Ø100	4 corners available various inserts can be applied to machine for different types of workpiece	●	●	●			E222	
		Ø63~Ø125			E223								
		FMPC(M)3000A		90°	Ø63~Ø100	Excellent in high speed cutting and tapping center, low power machine due to light aluminum body	●	●	●			E224	
		Ø63~Ø315			E225								
		FMRC(M)3000		-	Ø40~Ø100	4-8 corners available Double contact faces between insert & seat part of cutter for stable clamping	●	●	●	●	●	E228	
		FMRC(M)4000			Ø50~Ø125		E229						
		FMRC(M)5000			Ø50~Ø125		Excellent rotating-free machining	●	●	●	●	●	E230
		FMRC(M)6000			Ø63~Ø160		E231						
	Future Mill P-positive	FMRC(M) <sup>new</sup> 3000 4000 5000 6000		-	Ø40~Ø250	Stable clamping system enables stable machining and productivity Varied product line-up ensures wide application range Optimal shape and grade with high hardness for hard-to-cut material machining.	●	●	●	●	●	E242~ E245	
	Triple Mill	TPMCM-TN16		90°	Ø50~Ø125	3-cornered insert for shouldering	●	●	●			E258	
		TPMCM-TN20			Ø63~Ø125	-Reduced cutting resistance due to high rake angled cutting edge and chip breaker	E259						
	HFMD	HFMDCM-LN06		-	Ø32~Ø66	Double sided with 4 corners insert for small diameter machining	●	●	●		●	E272	
		HFMD(M)-LN10			Ø40~Ø100	For high feed and multi-functional machining Strong clamping realizes stable machining.	E273						
	HRM	HRMC(M)13		15°	Ø50~Ø80	Powerful clamping by double clamping system	●	●	●		●	E300	
		HRMC(M)15			Ø63~Ø160	3 corners available high feed cutting with low cutting load	E301						
	HRMD	HRMDC(M)09		14°	Ø40~Ø100	Double side insert with 6 corner High feed cutting with strong simple screw-on clamp	●	●	●		●	E289	
		HRMDC(M)13			Ø50~Ø125		E290						
		HRMDC(M)16 <sup>new</sup>			Ø80~Ø315		E291						
	Tangen-Pro	TP2PC(M)-LN08 <sup>new</sup>		90°	Ø40~Ø63	High-quality results available even under harsh cutting conditions, thanks to the stable clamping force	●	●	●			E311	
		TP2PC(M)-LN14 <sup>new</sup>			Ø40~Ø125		E312						
TP2PC(M)-LN17 <sup>new</sup>		Ø40~Ø125			E313								















Type	Cutter	Designation	Shape	A.A	Diameter range	Features	Application					Page
							Facing	Shouldering	Slotting	Copying	Ramping, Helical	
Cutters for molds	BT/HSK Tooling System	BT30/40/50		90°	Ø10~Ø50	BT/HSK one solid type has been accepted to increase the precision	●	●	●		●	E342~E346
		HSK63									E353~E357	
		BT30/40/50		90°	Ø16~Ø100	Inner coolant system can also make it possible to evacuate the chip effectively High feed and high depth	●	●	●			E347~E351
		HSK63/100									E358~E362	
		BT30/40/50-MAT		90°	Ø12~Ø40	Alpha Mill, Rich Mill, FMR, Laser Mill, HRM(D), Pro-A, Pro-X Modular head M06~M16 applicable	●	●	●	●	●	E403
		HSK63/100-MAT										E404
BT50 HAT4000		90°	Ø50~Ø80	Head only replacement possible and higher efficiency by self assembly head	●	●	●			E352		
Cutters for aluminum	Pro-A Mill	PAC(M) 2000/4000	 	90°	Ø40~Ø100	Buffed insert controls chip flow without built-up edge	●	●	●	●	●	E385
	Pro-X Mill	PAXC(M)5000	 	90°	Ø40~Ø125	Powerful clamping Excellent body rigidity for rectangular and curve machining	●	●	●	●	●	E388
		PAXC(M)6000										E389
	Pro-L Mill	PALC(M)	 	90°	Ø63	High helix and high depth of cut High perpendicularity Low cutting load	●	●	●	●	●	E394
	Pro-V Mill	PAVCM-XD19	 	90°	Ø40~Ø125	Exclusive milling tool for high speed aluminum machining with key to key way structure ensures stable clamping.	●	●	●	●	●	E399
Indexable side cutter	Tangential type	Full-side cutter	TAFCP		-	Ø100~Ø315	Various cutting depth can be possible because of adjustable length control. Medium to Roughing based on strengthened edge		●	●		E407
			TAFCB		-	Ø100~Ø315		●	●	●	E407	
	Half-side cutter	TAHCP		-	Ø100~Ø315	●		●		E408		
		TAHCB		-	Ø100~Ø315	●		●	●	E408		












 Cutter for aluminum












Type	Cutter	Designation	Shape	A.A	Diameter range	Features	Application					Page	
							Facing	Shouldering	Slotting	Copying	Ramping, Helical		
Indexable side cutter	Radial type	Full-side cutter	RAFCP		-	Ø100~Ø315	Wide range of machining width with only one side cutter due to adjustable cutting-edge height Suitable for medium and finishing in narrow width side cutting due to good chip evacuation by 3-dimensional chip breaker		●	●			E409
		RAFCB		-	Ø100~Ø315	●		●	●			E409	
	Half-side cutter	RAHCP		-	Ø100~Ø315			●	●			E410	
	RAHCB		-	Ø100~Ø315	●	●		●			E410		
Side cutters	Full-side cutter	SPP(M)		-	Ø80~Ø200	Economical by using pentagonal insert Suitable for narrow & deep grooving			●			E411	
		SPB(M)		-	Ø80~Ø200	Economical by using pentagonal insert Suitable for narrow & deep grooving			●			E412	
		SPS		-	Ø50~Ø200	For narrow and deep width grooving			●			E413	
	Full-side cutter	RM4PFCB		-	Ø80~Ø160	4 corner usage with double-sided insert can be economical			●			E107 E108	
		RM4PFCP		-	Ø80~Ø160				●			E111 E112	
	Half-side cutter	RM4PHCB		-	Ø80~Ø160	4 corner usage with double-sided insert can be economical			●			E109 E110	
		RM4PHCP		-	Ø80~Ø160				●			E113 E114	
	Wind Mill	WFSB(M)		-	Ø100~Ø250	The nose R shape of insert ensures long tool life. Wide applications with various widths and corner R sizes.	●	●	●			E416	
		WFSP(M)		-	Ø100~Ø250				●	●			E417












Type	Cutter	Designation	Shape	A.A	Diameter range	Features	Application					Page		
							Facing	Shouldering	Slotting	Copying	Ramping, Helical			
Cutters for face milling	Turbo Mill	ADS 4000/5000		45°	Ø50~Ø63	Uneven insert spacing prevents chattering	●					E59 E60		
		PES 2000/3000/4000		90°	Ø20~Ø63	Good machinability due to the high rake angle	●	●	●			E61		
Cutters for molds	Rich Mill	RM3PS3000		90°	Ø20~Ø40	Perfect perpendicularity Strong clamping	●	●	●	●		E102		
		RM3PS4000 <b>new</b>			Ø32~Ø63							E103		
		RM4PS3000		90°	Ø14~Ø50	4 corners available High rake angle insert reduces cutting force	●	●	●		●		E115	
		RM4PS4000 <b>new</b>			Ø32~Ø63	Excellent insert rigidity	●	●	●		●		E116	
		RM4ZS3000		90°	Ø25~Ø40	In vertical machining, the maximum cutting width: 9.0 mm	●	●	●		●		E119	
		RM6PS-WN04 <b>new</b>		90°	Ø20~Ø32	Improved productivity and high-quality shouldering through high speed and high feed machining	●	●	●		●		E122	
		RM6PS-WN08 <b>new</b>			Ø32~Ø50								E123	
				RMRS-RN12 <b>new</b>		-	Ø32~Ø63	High cost efficiency due to double sided round typed cutting edge Excellent rotating prevention by strong clamping system Suitable for Inconel cutting	●					E146
			Alpha Mill-X	AMXS-AD10/12/17 <b>new</b>		90°	Ø20~Ø40	High rake angle cutting edge and chip breaker reduce cutting resistance and improve chip evacuation. High rigidity due to special design	●	●	●	●	●	E199 E200
			Alpha Mill	AMS 1000S/1500S 2000S/3000S 3000S-K/4000S		90°	Ø10~Ø63	The combination of a 3-dimensional curve design & high rake angle helps chip-evacuation effectively with a low cutting force Inner coolant system The various range of inserts can provide the widened choice High depth and high feed can be available during operation	●	●	●	●	●	E175~ E182
		AMS 1000SE/2000SE 3000SE			75°	Ø25~Ø63	E183 E184							
		AMS 1000M/1500M 2000M/4000M			90°	Ø16~Ø50	E185~ E187							
AMS 1000MH/1500MH 2000MH/3000MH(-K)		90°		Ø14~Ø40	E188 E189									

Type	Cutter	Designation	Shape	A.A	Diameter range	Features	Application					Page
							Facing	Shouldering	Slotting	Copying	Ramping, Helical	
Cutters for molds	Future Mill	FMAS3000		45°	Ø25-Ø63	For precision machining Excellent chip evacuation	●					E220
		FMAS4000			Ø50-Ø63							E221
		FMPS3000		90°	Ø25-Ø63	4 corners available Strong cutting-edge with low cutting load	●					E226
		FMPS4000			Ø40-Ø63							E227
		FMRS 1000/1500/2000 2500/3000/4000 5000/6000		-	Ø8-Ø63	2 touch clamping system, convenient insert change	●	●	●	●	●	E232- E237
	Future Mill P-positive	FMRS <sup>new</sup> 2500/3000 4000/5000 6000		-	Ø17-Ø50	P-positive relief angle ensures high rigidity and high machinability in die steel and high-resistant alloy machining Flat clearance face of insert prevents interference and revolution while machining	●	●	●	●	●	E246- E249
	Triple Mill	TPMS-TN11 <sup>new</sup>		90°	Ø25-Ø40	3-cornered insert for shouldering Reduced cutting resistance due to high rake angled cutting edge and chip breaker	●	●	●			E260
	TPMS-TN16 <sup>new</sup>	Ø32-Ø40			E261							
	HFMD	HFMS-LN04 <sup>new</sup>		-	Ø8-Ø21	Double sided insert with 4 corners for small diameter machining	●	●	●	●	●	E267 E268
	HFMS-LN06 <sup>new</sup>	Ø16-Ø40			E269 E270							
	HFMS-LN10	Ø25-Ø42			Strong clamping system for stable machining	E271						
	HFM	HFMS <sup>new</sup> 1000		13°	Ø8-Ø21	Apply helix cutting-edge on insert, low cutting load and reinforce toughness on corner Increased rigidity with double relief angle (11, 13), prevent interference with high feed To apply the negative axial rake angle when set up the holder, increased chipping resistance	●	●	●	●	●	E281 E282
	HRM	HRMS 08/10/13/15		15°	Ø20-Ø63	Powerful clamping by double clamping system 3 corners available High feed cutting with low cutting load	●	●	●	●	●	E302- E304
	HRMD	HRMS 06/09/13		14°	Ø16-Ø63	6 corners available, High feed, multi-function, only one screw application	●	●	●	●	●	E292- E296
	Tangen-Pro	TP2PS-LN08 <sup>new</sup>		90°	Ø16-Ø25	High-quality results available even under harsh cutting conditions, thanks to the stable clamping force	●	●	●			E311
	TP2PS-LN14 <sup>new</sup>	Ø25-Ø50			E312							
	TP2PS-LN17 <sup>new</sup>	Ø32-Ø50			E313							
Tank Mill	THE		90°	Ø25-Ø50	Right-hand helix angle employed for good chip evacuation. Special surface treatment prevents body breaking and improves rigidity. Strong cutting-edge	●	●				E307	













Type	Cutter	Designation	Shape	A.A	Diameter range	Features	Application					Page	
							Facing	Shouldering	Slotting	Copying	Ramping, Helical		
Cutters for molds	Laser Mill	LBE□□ LRE□□		-	Ø8~Ø32	Indexable ball endmill for precise mold. Rigid holder with simple design finishing MQL is available	●	●	●	●		E326~ E330	
		LBE□□-C LRE□□-C		-	Ø8~Ø32	Indexable ball endmill for precise mold. Rigid holder with simple design finishing MQL is available Carbide shank	●	●	●			E326~ E330	
	Mach Mill	BFE		-	Ø16~Ø32	Upgraded cutting performance with S type curve design V clamping application	●	●	●	●		E331	
		GBE		-	Ø16~Ø50	Helical design of edge can reduce the force during operation. Safe application to prevent rotation guarantee the increased tool life	●	●	●	●		E332 E333	
		BRE		-	Ø20~Ø63	Flute type chip-pocket can make chip-evacuation Customized edge design can prevent the breakage of holder's body	●	●	●	●		E335	
	HAVE	Multi-edge		90°	Ø16~Ø50	Tools for Z-axis feed plunge machining to cut faster and more effectively in vertical machining Machining with whole diameter	●	●	●	●		E339	
		Single-edge										E340	
	O-ring Cutter	ORC		90°	Ø11~Ø46	For grooving the seat of an O-Ring in a plastic mold Superior surface roughness and cutting performance compared to HSS and brazed tool	-	-	-	-	-	E365	
	Chamfer Tool	CE		75°	Ø25~Ø30	For Back & Front high quality chamfering and various Chamfering angle machining	●						E369
				60°	Ø25~Ø35								
				45°	Ø7~Ø39								
				30°	Ø25~Ø42								
CE			30°	Ø5~Ø35	Various chamfer degrees available Effective long chamfer cutting available	●	●	●				E370	
			45°	Ø5~Ø48									
			60°	Ø5~Ø57									
			45°	~Ø28	Centering, Grooving, Chamfering	●	●	●		●	E371		

Type	Cutter	Designation	Shape	A.A	Diameter range	Features	Application					Page			
							Facing	Shouldering	Slotting	Copying	Ramping, Helical				
Cutters for molds	Chamfer Tool	CCT		30°	Ø3~Ø16	Centering, Countersinking, Chamfering						E373			
				45°											
				60°											
	T-Cutter	TFE		90°	Ø21~Ø50	For slotting	●	●	●	●	●	E374			
				Pro-A Mill	PAS 2000/4000		90°	Ø12~Ø42 Ø32~Ø40	Polished face increases chip flow and reduces built-up edge	●	●	●	●	●	E386
							Pro-X Mill	PAXS 5000/6000		90°	Ø20~Ø40 Ø25~Ø40	Square shoulder and corner machining	●	●	●
Pro-L Mill	PALS-HR (Single-edge)		90°	Ø32~Ø63	High helix and high depth of cut	●				●	●	●	●	E395 E396	
				Pro-L Mill	PALS-HM (Multi-edge)		Ø63	High perpendicularity Low cutting load	●	●	●	●	●	E397	
Pro-V Mill	PAVS-XD19 <sup>new</sup>		90°				Ø25~Ø40	Exclusive milling tool for high speed aluminum machining with key to key way structure ensures stable machining.	●	●	●	●	●	E400	
				Pro-V Mill	HSK-XD19 <sup>new</sup>		Ø32~Ø50		●	●	●	●	●	E363	
Thread milling	-	TM					-	Ø32~Ø50	For internal and external threading	●				D49	



<p>FMRM type</p> <p>➔ E238-241 E250-253</p>			<p>Steel Shank type</p> <p>➔ E401</p>
<p>LBE-MHD type</p> <p>➔ E330</p>			<p>Carbide Shank type</p> <p>➔ E402</p>
<p>PAM type</p> <p>➔ E387</p>			<p>BT Arbors type</p> <p>➔ E403</p>
<p>PAXM type</p> <p>➔ E392</p>			<p>HSK Arbors type</p> <p>➔ E404</p>
<p>AMM type</p> <p>➔ E190-192</p>			
<p>RM3PM type</p> <p>➔ E104</p>			
<p>RM4PM type</p> <p>➔ E117</p>			

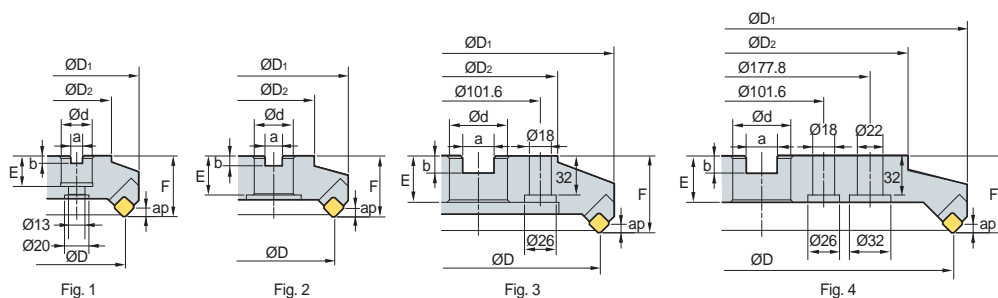
# E KORLOY Modular Adaptors

<p>RM4ZM type → E119</p>			<p>Steel Shank type → E401</p>
<p>RM6PM type → E124, 125</p>			<p>Carbide Shank type → E402</p>
<p>HFMDM type → E274-276</p>			<p>BT Arbors type → E403</p>
<p>HFMM type → E283</p>			<p>HSK Arbors type → E404</p>
<p>HRMM type → E305, 306</p>			
<p>HRMDM type → E297-299</p>			
<p>GBEM type → E334</p>			





# ADN(M)4000



AA  
45°  
• AR: 15°  
• RR: -4°

(mm)

Designation	ØD	ØD1	ØD2	Ød	a	b	E	F	ap	kg	Fig.
ADN 4080R/L	80	57	57	25.4 (27)	9.5 (12.4)	6 (7)	25 (22)	50	6	1.9	1
(ADNM) 4100R/L	100	67	67	31.75 (32)	12.7 (14.4)	8 (8)	32 (28)	50	6	2.5	2
4125R/L	125	87	87	38.1 (40)	15.9 (16.4)	10 (9)	38 (30)	63	6	4.3	2
4160R/L	160	107	107	50.8 (40)	19.0 (16.4)	11 (9)	38 (30)	63	6	6.4	2
4200R/L	200	130	130	47.625 (60)	25.4 (25.7)	14 (14)	38 (38)	63	6	8.7	3
4250R/L	250	180	180	47.625 (60)	25.4 (25.7)	14 (14)	38 (38)	63	6	14.0	3
4315R/L	315	240	240	47.625 (60)	25.4 (25.7)	14 (14)	38 (38)	63	6	21.0	4

( ) Metric size

## Available inserts

SDCN	SDKN-MU	SDKN-SU	SDKR-MX		
Designation	Cermet	Coated		Uncoated	page
	CN2500 CN30	NCM325 NCM335 NCM535 NCM545	PC3700 PC6510 PC9530 PC9540 PC5300 PC5400	ST30A G10 H01	
SDCN 42M				●	
42M-G					●
42MT	●●	●		●	
42MT-RH					
42MT-S20			●		E19
1203AEEN					
1203AEEN-RH					
1203AESN					
1203AESN-RH					
SDKN 1203AESN-MU		●			E20
1203AESN-SU		●	●●		
SDKR 1203AESN-MX					E20
1203AETN-MX					
1203AEN-MX		●			

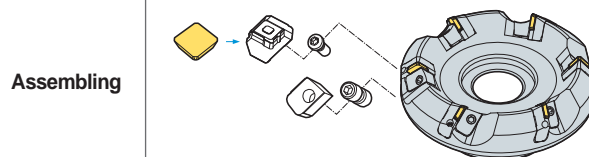
## Available arbors

Designation	General arbor	NC arbors	
		ADN	ADNM
ADN 4080R/L	NT*□□ (MU)-FMA25.4-25	BT**□□-FMA25.4-□□	FMC27
(ADNM) 4100R/L	NT*□□ (MU)-FMA31.75-□□	BT**□□-FMA31.75-□□	FMC32
4125R/L	NT*□□ (MU)-FMA38.1-□□	BT**□□-FMA38.1-□□	FMB40
4160R/L	NT*□□ (MU)-FMA50.8-□□	BT**□□-FMA50.8-□□	FMB40
4200R/L	NT*□□ (MU)-FMA47.625-25, KCP-8***	BT**□□-FMA47.625-□□	FMB60
4250R/L	NT*□□ (MU)-FMA47.625-25, KCP-8***	BT**□□-FMA47.625-□□	FMB60
4315R/L	KCP-8*** (Center ring plug)		

\*□□-NT number \*\*□□-BT number \*\*\*Over milling 5

## Recommended cutting condition

Workpiece	Cutting condition		Grades
	vc (m/min)	fz (mm/t)	
P	190~320	0.05~0.20	NCM325 PC3700 ST30A
	161~270	0.05~0.20	
	80~140	0.05~0.20	
M	90~150	0.05~0.20	PC9530
K	140~230	0.05~0.30	PC6510 G10
	50~90	0.05~0.30	



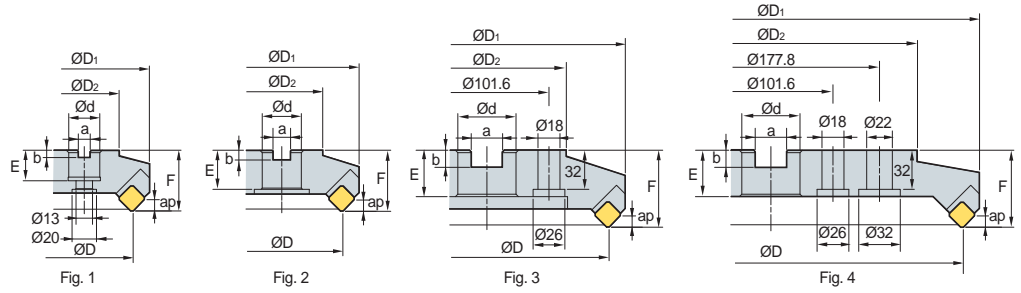
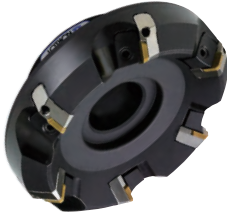
## Parts

Specification					
Ø80-Ø315	LADN4R/L	WEPN4R/L	DHA0821F	LTX0514	HW40

Available inserts E19, E20

Available arbors and bolt E426-E428

## ADN(M)5000+



(mm)

Designation		ØD	ØD1	ØD2	Ød	a	b	E	F	ap	kg	Fig.
ADN (ADNM)	5080R/L+	80	107	65	25.4(27)	9.5 (12.4)	6 (7)	25 (22)	63	8	2.4	1
	5100R/L+	100	126	75	31.75(32)	12.7 (14.4)	8 (8)	32 (28)	63	8	3.0	2
	5125R/L+	125	150	100	38.1(40)	15.9 (16.4)	10 (9)	38 (30)	63	8	4.7	2
	5160R/L+	160	185	120	50.8(40)	19.0 (16.4)	11 (9)	38 (30)	63	8	6.5	2
	5200R/L+	200	225	140	47.625(60)	25.4 (25.7)	14 (14)	38 (38)	63	8	8.7	3
	5250R/L+	250	275	220	47.625(60)	25.4 (25.7)	14 (14)	38 (38)	63	8	15.5	3
	5315R/L+	315	340	280	47.625(60)	25.4 (25.7)	14 (14)	38 (38)	63	8	23.7	4

( ) Metric size

### Available inserts

		SDCN	SDKN-MU	SDKN-SU	SDKR-MX													
Designation	page	Cermet		Coated			Uncoated											
		CN2500	CN30	NC5330	NCM325	NCM335	NCM535	NCM545	PC3700	PC6510	PC9530	PC9540	PC5300	PC5400	ST30A	G10	H01	
SDCN	53M																	
	53M-G																	
	53MT		●	●														
	53MT-RH																	
	53MT-S20																	E19
	1504AEEN																	
	1504AEEN-RH																	
	1504AESN																	
	1504AESN-RH																	
SDKN	1504AESN-MU																	E20
	1504AESN-SU																	
SDKR	1504AESN-MX																	E20
	1504AETN-MX																	
	1504AEN-MX																	

### Available arbors

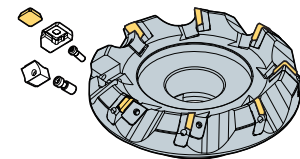
Designation	General arbor	NC arbors	
		ADN	ADNM
ADN 5080R/L+	NT*□□ (MU)-FMA25.4-25	BT**□□ -FMA25.4-□□	FMC27
(ADNM) 5100R/L+	NT*□□ (MU)-FMA31.75-□□	BT**□□ -FMA31.75-□□	FMC32
5125R/L+	NT*□□ (MU)-FMA38.1-□□	BT**□□ -FMA38.1-□□	FMB40
5160R/L+	NT*□□ (MU)-FMA50.8-□□	BT**□□ -FMA50.8-□□	FMB40
5200R/L+	NT*□□ (MU)-FMA47.625-25, KCP-8***	BT**□□ -FMA47.625-□□	FMB60
5250R/L+	NT*□□ (MU)-FMA47.625-25, KCP-8***	BT**□□ -FMA47.625-□□	FMB60
5315R/L+	KCP-8*** (Center ring plug)		

\*□□-NT number \*\*□□-BT number \*\*\*Over milling 5

### Recommended cutting condition

Workpiece	Cutting condition		Grades
	vc (m/min)	fz (mm/t)	
P	190~320	0.05~0.20	NCM325 PC3700 ST30A
	161~270	0.05~0.20	
	80~140	0.05~0.20	
M	90~150	0.05~0.20	PC9530
K	140~230	0.05~0.30	PC6510 G10
	50~90	0.05~0.30	

### Assembling



### Parts

Specification					
Ø80~Ø315	LADN5R/L	WHPS5R/L	WHX0817 WHX0813*	LTX0514	HW40

\*: Ø80

Available inserts E19, E20 Available arbors and bolt E426-E428



# AE(M)4000

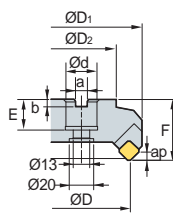


Fig. 1

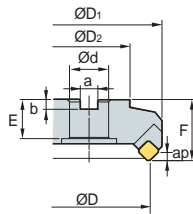


Fig. 2

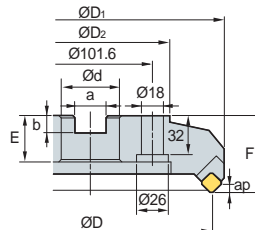


Fig. 3

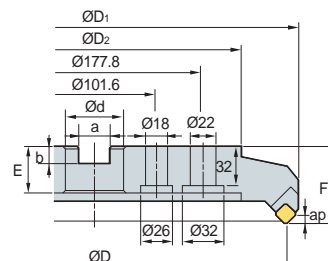


Fig. 4



AA  
45°

- AR: 20°
- RR: -3°

(mm)

Designation	ØD	ØD1	ØD2	Ød	a	b	E	F	ap	kg	Fig.
<b>AE (AEM)</b> 4080R/L	80	103	60	25.4 (27)	9.5 (12.4)	6 (7)	25 (22)	50	5.5	1.7	1
4100R/L	100	122	80	31.75 (32)	12.7 (14.4)	8 (8)	32 (28)	50	5.5	2.9	2
4125R/L	125	146	100	38.1 (40)	15.9 (16.4)	10 (9)	38 (30)	63	5.5	4.4	2
4160R/L	160	181	120	50.8 (40)	19.0 (16.4)	11 (9)	38 (30)	63	5.5	6.1	2
4200R/L	200	220	130	47.625 (60)	25.4 (25.7)	13.5 (14)	38 (38)	63	5.5	8.9	3
4250R/L	250	270	180	47.625 (60)	25.4 (25.7)	13.5 (14)	38 (38)	63	5.5	15.7	3
4315R/L	315	335	240	47.625 (60)	25.4 (25.7)	13.5 (14)	38 (38)	63	5.5	25.1	4

( )Metric size

## Available inserts

SECN

SEKN-SU

SEKR-MX



Designation	Cermet	Coated						Uncoated		page
	CN2500 CN30	NC5330 NCM325 NCM335 NCM535 NCM545 PC3700	PC6510 PC9540 PC5300 PC5400	ST30A G10 H01						
SECN 1203AFFN								● ●		
1203AFTN	● ●							●		
1203AFEN										
1203AFSN		● ●							E21	
1203AFEN-RH				●		●				
1203AFSN-RH										
1203AFTN-S20						●				
SEKN 1203AFSN-SU						●			E21	
SEKR 1203AFSN-MX		● ●				●			E22	

## Available arbors

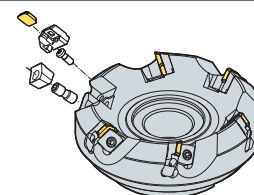
Designation	General arbor	NC arbors	
		ADN	ADNM
<b>AE (AEM)</b> 4080R/L	NT*□□ (MU)-FMA25.4-25	BT**□□-FMA25.4-□□	FMC27
4100R/L	NT*□□ (MU)-FMA31.75-□□	BT**□□-FMA31.75-□□	FMC32
4125R/L	NT*□□ (MU)-FMA38.1-□□	BT**□□-FMA38.1-□□	FMB40
4160R/L	NT*□□ (MU)-FMA50.8-□□	BT**□□-FMA50.8-□□	FMB40
4200R/L	NT*□□ (MU)-FMA47.625-25, KCP-8***	BT**□□-FMA47.625-□□	FMB60
4250R/L	NT*□□ (MU)-FMA47.625-25, KCP-8***	BT**□□-FMA47.625-□□	FMB60
4315R/L	KCP-8*** (Center ring plug)		

\*□□-NT number \*\*□□-BT number \*\*\*Over milling 5

## Recommended cutting condition

Workpiece	Cutting condition		Grades
	vc (m/min)	fz (mm/t)	
<b>P</b>	190~320	0.05~0.20	<b>NCM325</b> <b>PC3700</b> <b>ST30A</b>
	161~270	0.05~0.20	
	80~140	0.05~0.20	
<b>M</b>	90~150	0.05~0.20	<b>PC9530</b>
<b>K</b>	140~230	0.05~0.30	<b>PC6510</b> <b>G10</b>
	50~90	0.05~0.30	

Assembling



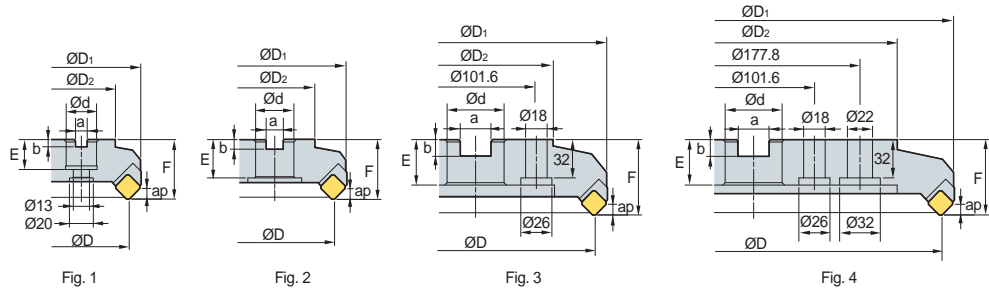
## Parts

Specification					
Ø80-Ø315	LAE4R/L	WAE4R/L	DHA0821F	LTX0512	HW40

Available inserts E21, E22

Available arbors and bolt E426-E428

# AE(M)5000



AA  
45°  
•AR: 20°  
•RR: -3°

(mm)

Designation	ØD	ØD1	ØD2	Ød	a	b	E	F	ap	kg	Fig.
<b>AE</b> 5080R/L	80	103	60	25.4 (27)	9.5 (12.4)	6 (7)	25 (22)	50	7.5	1.7	1
<b>(AEM)</b> 5100R/L	100	122	80	31.75 (32)	12.7 (14.4)	8 (8)	32 (28)	50	7.5	2.9	2
5125R/L	125	146	100	38.1 (40)	15.9 (16.4)	10 (9)	38 (30)	63	7.5	4.4	2
5160R/L	160	181	120	50.8 (40)	19.0 (16.4)	11 (9)	38 (30)	63	7.5	6.1	2
5200R/L	200	220	130	47.625 (60)	25.4 (25.7)	13.5 (14)	38 (38)	63	7.5	8.9	3
5250R/L	250	270	180	47.625 (60)	25.4 (25.7)	13.5 (14)	38 (38)	63	7.5	15.7	3
5315R/L	315	335	240	47.625 (60)	25.4 (25.7)	13.5 (14)	38 (38)	63	7.5	25.1	4

( ) Metric size

## Available inserts



Designation	Cermet		Coated						Uncoated		page					
	CN2500	CN30	NC5330	NCM325	NCM335	NCM535	NCM545	PC3700	PC6510	PC9530		PC9540	PC5300	PC5400	ST30A	G10
SECN 1504AFFN																
1504AFTN		●														
1504AFEN																
1504AFSN																E21
1504AFEN-RH																
1504AFSN-RH																
1504AFTN-S20																
SEKN 1504AFSN-SU																E21
1504AFSN-MX																
SEKR 1504AFSN-MX																E22

## Available arbors

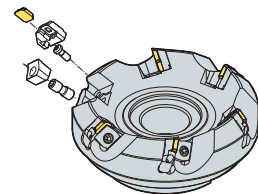
Designation	General arbor	NC arbors	
		AE	AEM
<b>AE</b> 5080R/L	NT*□□ (M/U)-FMA25.4-25	BT**□□ -FMA25.4-□□	FMC27
<b>(AEM)</b> 5100R/L	NT*□□ (M/U)-FMA31.75-□□	BT**□□ -FMA31.75-□□	FMC32
5125R/L	NT*□□ (M/U)-FMA38.1-□□	BT**□□ -FMA38.1-□□	FMB40
5160R/L	NT*□□ (M/U)-FMA50.8-□□	BT**□□ -FMA50.8-□□	FMB40
5200R/L	NT*□□ (M/U)-FMA47.625-25, KCP-8***	BT**□□ -FMA47.625-□□	FMB60
5250R/L	NT*□□ (M/U)-FMA47.625-25, KCP-8***	BT**□□ -FMA47.625-□□	FMB60
5315R/L	KCP-8*** (Center ring plug)		

\*□□-NT number \*\*□□-BT number \*\*\*Over milling 5

## Recommended cutting condition

Workpiece	Cutting condition		Grades
	vc (m/min)	fz (mm/t)	
<b>P</b>	190~320	0.05~0.20	<b>NCM325</b> <b>PC3700</b> <b>ST30A</b>
	161~270	0.05~0.20	
	80~140	0.05~0.20	
<b>M</b>	90~150	0.05~0.20	<b>PC9530</b>
<b>K</b>	140~230	0.05~0.30	<b>PC6510</b> <b>G10</b>
	50~90	0.05~0.30	

## Assembling



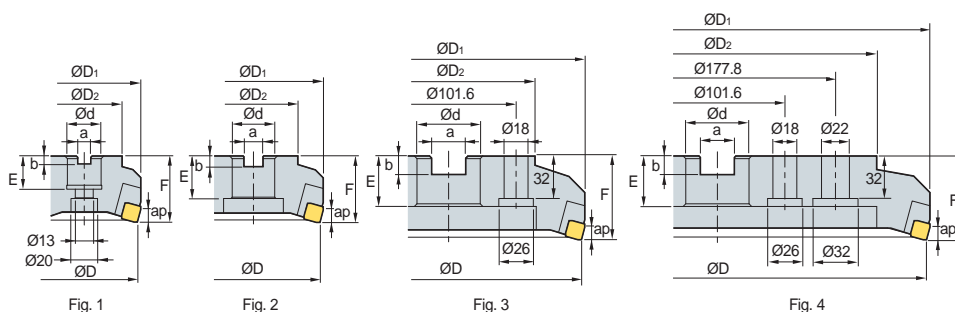
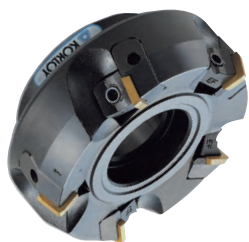
## Parts

Specification	Locator	Wedge	Wedge screw	Locator screw	Wrench
Ø80~Ø315	LAE5R/L	WAE5R/L	DHA0821F	LTX0512	HW40

Available inserts E21, E22 Available arbors and bolt E426-E428



# EF(M)4000



AA  
**75°**  
•AR: 18°  
•RR: 11°

(mm)

Designation	⊙	ØD	ØD1	ØD2	Ød	a	b	E	F	ap	kg	Fig.	
<b>EF (EFM)</b>	<b>4080R/L</b>	4	80	89	57	25.4 (27)	9.5 (12.4)	6 (7)	25 (22)	50	8.0	1.5	1
	<b>4100R/L</b>	5	100	108	70	31.75 (32)	12.7 (14.4)	8 (8)	32 (28)	50	8.0	2.1	2
	<b>4125R/L</b>	6	125	133	87	38.1 (40)	15.9 (16.4)	10 (9)	38 (30)	63	8.0	3.8	2
	<b>4160R/L</b>	8	160	168	107	50.8 (40)	19.0 (16.4)	11 (9)	38 (30)	63	8.0	5.5	2
	<b>4200R/L</b>	10	200	208	130	47.625 (60)	25.4 (25.7)	13.5 (14)	38 (38)	63	8.0	8.2	3
	<b>4250R/L</b>	12	250	257	180	47.625 (60)	25.4 (25.7)	13.5 (14)	38 (38)	63	8.0	13.4	3
<b>4315R/L</b>	16	315	322	240	47.625 (60)	25.4 (25.7)	13.5 (14)	38 (38)	63	8.0	21.2	4	

( ) Metric size

## Available inserts

SFCN



Designation	Cermet		Coated						Uncoated		page					
	CN2500	CN30	NC5330	NCM325	NCM535	NCM545	PC2010	PC3700	PC6510	PC9530		PC9540	PC5300	PC5400	ST30A	G10
SFCN 1203EFR																● E22

## Available arbors

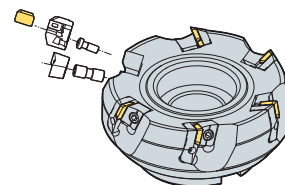
Designation	General arbor	NC arbors	
		EF	EFM
<b>EF (EFM)</b> 4080R/L	NT*□□ (MU)-FMA25.4-25-□□	BT**□□-FMA25.4-□□	FMC27
4100R/L	NT*□□ (MU)-FMA31.75-□□	BT**□□-FMA31.75-□□	FMC32
4125R/L	NT*□□ (MU)-FMA38.1-□□	BT**□□-FMA38.1-□□	FMB40
4160R/L	NT*□□ (MU)-FMA50.8-□□	BT**□□-FMA50.8-□□	FMB40
4200R/L	NT*□□ (MU)-FMA47.625-25. KCP-8***	BT**□□-FMA47.625-□□	FMB60
4250R/L	NT*□□ (MU)-FMA47.625-25. KCP-8***	BT**□□-FMA47.625-□□	FMB60
4315R/L	KCP-8*** (Center ring plug)		

\*□□-NT number \*\*□□-BT number \*\*\*Over milling 5

## Recommended cutting condition

Workpiece	Cutting condition		Grades
	vc (m/min)	fz (mm/t)	
<b>K</b>	75~125	0.05~0.30	<b>H01</b>

Assembling



## Parts

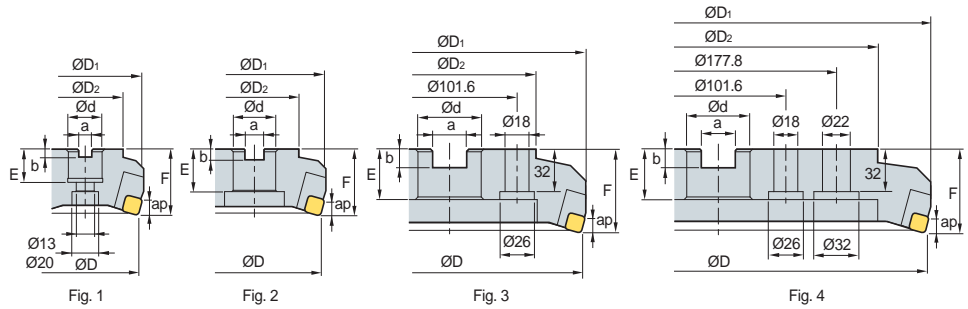
Specification					
Ø80-Ø315	LEF4R/L LEF4R1*/L1*	WEFR/L	DHA0821F	LTX0512	HW40

Available inserts **E22** Available arbors and bolt **E426-E428**

\* : Ø80-Ø125



## EN(M)4000



Designation		⊙	ØD	ØD1	ØD2	Ød	a	b	E	F	ap	kg	Fig.
EN (ENM)	4080R/L	5	80	87	57	25.4 (27)	9.5 (12.4)	6 (7)	25 (22)	50	8.5	1.4	1
	4100R/L	6	100	107	67	31.75 (32)	12.7 (14.4)	8 (8)	32 (28)	50	8.5	2.1	2
	4125R/L	8	125	132	87	38.1 (40)	15.9 (16.4)	10 (9)	38 (30)	63	8.5	3.8	2
	4160R/L	10	160	167	107	50.8 (40)	19.0 (16.4)	11 (9)	38 (30)	63	8.5	5.7	2
	4200R/L	12	200	207	130	47.625 (60)	25.4 (25.7)	13.5 (14)	38 (38)	63	8.5	8.4	3
	4250R/L	16	250	257	180	47.625 (60)	25.4 (25.7)	13.5 (14)	38 (38)	63	8.5	13.8	3
	4315R/L	20	315	322	240	47.625 (60)	25.4 (25.7)	13.5 (14)	38 (38)	63	8.5	21.6	4

( ) Metric size

### Available inserts

		SNCN		SNKN				
Designation		Coated						page
		Cermet	Coated				Uncoated	
		CN2500 CN30	NCM325 NCM330	NCM535 NCM545	PC2010 PC3700	PC6510 PC9530	PC5300 PC5400	ST30A G10 H01
SNCN	1204ENN		●					E23
SNKN	1204ENN				●			E25

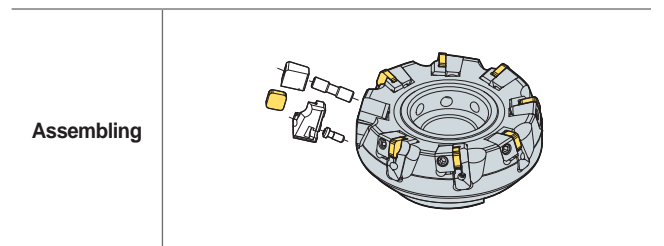
### Available arbors

Designation	General arbor	NC arbors		
		EN	ENM	
EF (EFM)	4080R/L	NT*□□ (MU)-FMA25.4-25-□□	BT**□□ -FMA25.4-□□	FMC27
	4100R/L	NT*□□ (MU)-FMA31.75-□□	BT**□□ -FMA31.75-□□	FMC32
	4125R/L	NT*□□ (MU)-FMA38.1-□□	BT**□□ -FMA38.1-□□	FMB40
	4160R/L	NT*□□ (MU)-FMA50.8-□□	BT**□□ -FMA50.8-□□	FMB40
	4200R/L	NT*□□ (MU)-FMA47.625-25, KCP-8***	BT**□□ -FMA47.625-□□	FMB60
	4250R/L	NT*□□ (MU)-FMA47.625-25, KCP-8***	BT**□□ -FMA47.625-□□	FMB60
	4315R/L	KCP-8*** (Center ring plug)		

\*□□-NT number \*\*□□-BT number \*\*\*Over milling 5

### Recommended cutting condition

Workpiece	Cutting condition		Grades
	vc (m/min)	fz (mm/t)	
P	190~320	0.05~0.20	NCM325 PC3700 ST30A
	161~270	0.05~0.20	
	80~140	0.05~0.20	
M	90~150	0.05~0.20	PC9530
K	140~230	0.05~0.30	PC6510 G10
	50~90	0.05~0.30	



### Parts

Specification					
Ø80~Ø315	LEN4R/L	WENR/L WENR1*/L1*	DHA0830 DHA0825*	LTX0512	HW40

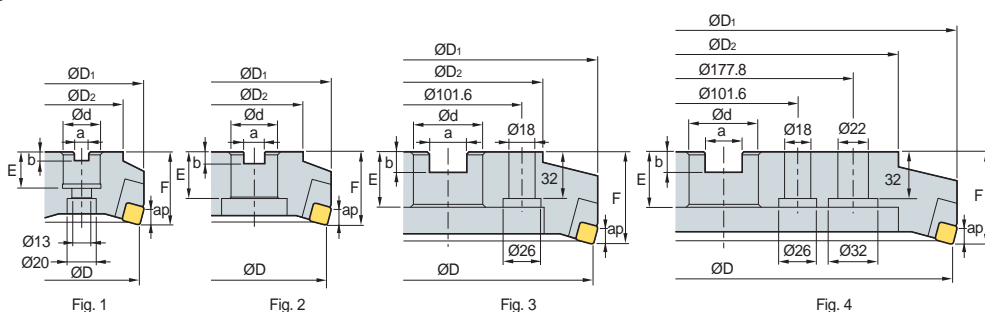
\* : Ø80-Ø100

Available inserts E23, E25 Available arbors and bolt E426-E428





# EPN(M)4000



AA  
75°  
• AR: 7°  
• RR: 0°

(mm)

Designation	ØD	ØD1	ØD2	Ød	a	b	E	F	ap	kg	Fig.	
<b>EPN (EPNM)</b> 4080R/L	5	80	86	57	25.4 (27)	9.5 (12.4)	6 (7)	25 (22)	50	9	1.4	1
4100R/L	6	100	107	67	31.75 (32)	12.7 (14.4)	8 (8)	32 (28)	50	9	2.1	2
4125R/L	8	125	132	87	38.1 (40)	15.9 (16.4)	10 (9)	38 (30)	63	9	3.8	2
4160R/L	10	160	166	107	50.8 (40)	19.0 (16.4)	11 (9)	38 (30)	63	9	5.7	2
4200R/L	12	200	206	130	47.625 (60)	25.4 (25.7)	14 (14)	38 (38)	63	9	8.2	3
4250R/L	16	250	256	180	47.625 (60)	25.4 (25.7)	14 (14)	38 (38)	63	9	13.5	3
4315R/L	20	315	321	240	47.625 (60)	25.4 (25.7)	14 (14)	38 (38)	63	9	21.1	4

( ) Metric size

## Available inserts



Designation	Cermet		Coated							Uncoated		page					
	CN2500	CN30	NC5330	NCM325	NCM335	NCM535	NCM545	PC3700	PC6510	PC9530	PC9540		PC5300	PC5400	ST30A	G10	H01
<b>SPCN</b> 1203EDR	●		●	●										●	●	●	E26
1203EDL														●			
1203EDR-G																●	
1203EDER-RH								●		●							
1203EDSR-RH								●									
1203EDTR-RH																	
1203EDR-S20									●								
<b>SPKN</b> 1203EDSR-MU								●									E27
1203EDSR-SU								●		●	●						
1203EDSL-SU								●									
<b>SPKR</b> 1203EDSR-MX			●	●													E27
1203EDSL-MX																	
<b>SPEX</b> 1203EDR/L-1																	E26

## Available arbors

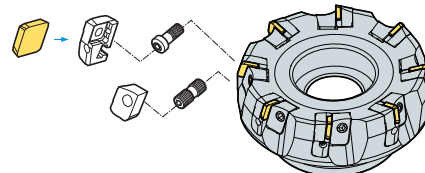
Designation	General arbor	NC arbors	
		EPN	EPNM
<b>EPN (EPNM)</b> 4080R/L	NT*□□ (MU)-FMA25.4-25	BT**□□-FMA25.4-□□	FMC27
4100R/L	NT*□□ (MU)-FMA31.75-□□	BT**□□-FMA31.75-□□	FMC32
4125R/L	NT*□□ (MU)-FMA38.1-□□	BT**□□-FMA38.1-□□	FMB40
4160R/L	NT*□□ (MU)-FMA50.8-□□	BT**□□-FMA50.8-□□	FMB40
4200R/L	NT*□□ (MU)-FMA47.625-25, KCP-8***	BT**□□-FMA47.625-□□	FMB60
4250R/L	NT*□□ (MU)-FMA47.625-25, KCP-8***	BT**□□-FMA47.625-□□	FMB60
4315R/L	KCP-8*** (Center ring plug)		

\*□□-NT number \*\*□□-BT number \*\*\*Over milling 5

## Recommended cutting condition

Workpiece	Cutting condition		Grades
	vc (m/min)	fz (mm/t)	
<b>P</b>	190~320	0.05~0.20	<b>NCM325</b> <b>PC3700</b> <b>ST30A</b>
	161~270	0.05~0.20	
	80~140	0.05~0.20	
<b>M</b>	90~150	0.05~0.20	<b>PC9530</b>
<b>K</b>	140~230	0.05~0.30	<b>PC6510</b> <b>G10</b>
	50~90	0.05~0.30	

## Assembling



## Parts

Specification	Locator	Wedge	Wedge screw	Locator screw	Wrench
Ø80-Ø315	LEPN4R/L LEPN4R1*/L1*	WEPN4R/L	DHA0821F DHA0817F*	LTX0514	HW40

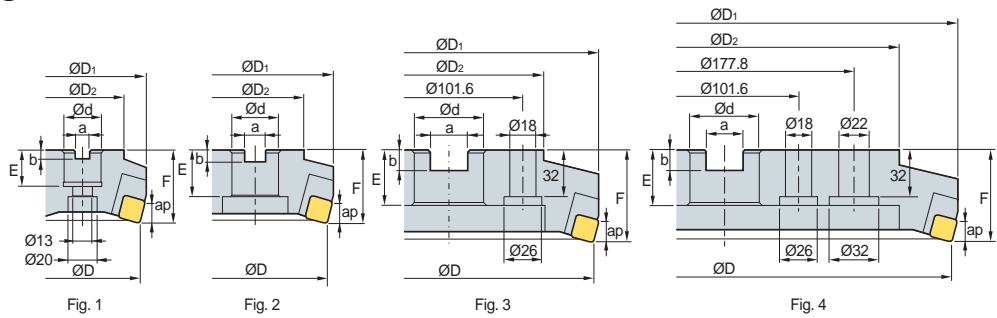
Available inserts E26, E27

Available arbors and bolt E426-E428

\*: Ø80-Ø100



## EPN(M)5000+

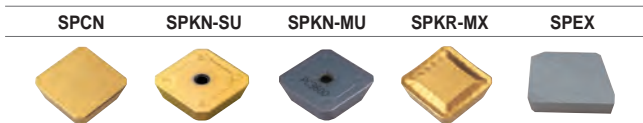


(mm)

Designation	ØD	ØD1	ØD2	Ød	a	b	E	F	ap	kg	Fig.
<b>EPN</b> 5080R/L+	80	91	60	25.4 (27)	9.5 (12.4)	6 (7)	25 (22)	63	12	1.7	1
<b>(EPNM)</b> 5100R/L+	100	110	70	31.75 (32)	12.7 (14.4)	8 (8)	32 (28)	63	12	2.5	1
5125R/L+	125	134	90	38.1 (40)	15.9 (16.4)	10 (9)	38 (30)	63	12	3.8	2
5160R/L+	160	169	110	50.8 (40)	19.0 (16.4)	11 (9)	38 (30)	63	12	5.5	2
5200R/L+	200	209	150	47.625 (60)	25.4 (25.7)	14 (14)	38 (38)	63	12	8.0	3
5250R/L+	250	259	230	47.625 (60)	25.4 (25.7)	14 (14)	38 (38)	63	12	14.8	3
5315R/L+	315	324	270	47.625 (60)	25.4 (25.7)	14 (14)	38 (38)	63	12	22.4	4

( ) Metric size

### Available inserts



Designation	Cermet		Coated						Uncoated		page					
	CN2500	CN30	NC5330	NCM325	NCM535	NCM545	PC2010	PC3700	PC6510	PC9530		PC9540	PC5300	PC5400	ST30A	G10
<b>SPCN</b> 150412T																
1504EDR	●		●											●	●	
1504EDSR																
1504EDL								●								
1504EDR-G															●	
1504EDER-RH								●	●							
1504EDSR-RH								●								
1504EDTR-RH																
1504EDR-S20									●							
<b>SPKN</b> 1504EDSR-MU								●								
1504EDSR-SU								●	●	●						
1504EDSL-SU								●								
<b>SPKR</b> 1504EDR-MX			●													
1504EDSR-MX																
<b>SPEX</b> 1504EDR/L-1																

### Available arbors

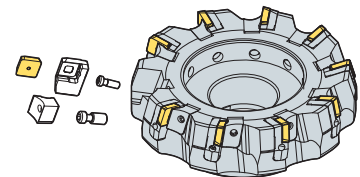
Designation	General arbor	NC arbors	
		EPN	EPNM
<b>EPN</b> 5080R/L+	NT*□□(MU)-FMA25.4-25	BT**□□-FMA25.4-□□	FMC27
<b>(EPNM)</b> 5100R/L+	NT*□□(MU)-FMA31.75-□□	BT**□□-FMA31.75-□□	FMC32
5125R/L+	NT*□□(MU)-FMA38.1-□□	BT**□□-FMA38.1-□□	FMB40
5160R/L+	NT*□□(MU)-FMA50.8-□□	BT**□□-FMA50.8-□□	FMB40
5200R/L+	NT*□□(MU)-FMA47.625-25, KCP-8***	BT**□□-FMA47.625-□□	FMB60
5250R/L+	NT*□□(MU)-FMA47.625-25, KCP-8***	BT**□□-FMA47.625-□□	FMB60
5315R/L+	KCP-8*** (Center ring plug)		

\*□□-NT number \*\*□□-BT number \*\*\*Over milling 5

### Recommended cutting condition

Workpiece	Cutting condition		Grades
	vc (m/min)	fz (mm/t)	
<b>P</b>	190~320	0.05~0.20	<b>NCM325</b> <b>PC3700</b> <b>ST30A</b>
	161~270	0.05~0.20	
	80~140	0.05~0.20	
<b>M</b>	90~150	0.05~0.20	<b>PC9530</b>
<b>K</b>	140~230	0.05~0.30	<b>PC6510</b> <b>G10</b>
	50~90	0.05~0.30	

### Assembling



### Parts

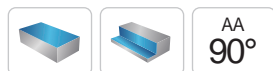
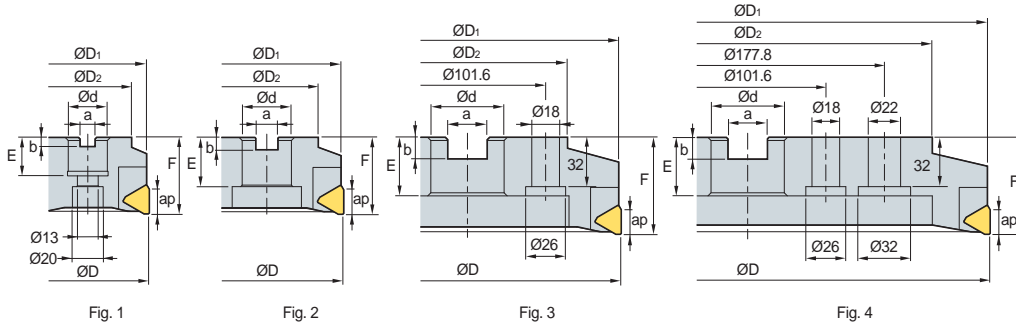
Specification	Locator	Wedge	Wedge screw	Locator screw	Wrench
Ø80~Ø315	LEPN5R/L LEPN5R1*/L1*	WHPS5R/L	WHX0817 WHX0813*	LTX0514	HW40

\* : Ø80

Available inserts E26, E27 Available arbors and bolt E426-E428



# PF(M)4000



•AR: 15°  
•RR: 14°

Designation	ØD	ØD1	ØD2	Ød	a	b	E	F	ap	kg	Fig.
<b>PF</b> 4080R/L	80	79	57	25.4 (27)	9.5 (12.4)	6 (7)	25 (22)	50	16	1.2	1
<b>(PFM)</b> 4100R/L	100	97	67	31.75 (32)	12.7 (14.4)	8 (8)	32 (28)	50	16	1.8	2
4125R/L	125	122	87	38.1 (40)	15.9 (16.4)	10 (9)	38 (30)	63	16	3.1	2
4160R/L	160	158	107	50.8 (40)	19.0 (16.4)	11 (9)	38 (30)	63	16	5.6	2
4200R/L	200	197	130	47.625 (60)	25.4 (25.7)	13.5 (14)	38 (38)	63	16	8.8	3
4250R/L	250	247	180	47.625 (60)	25.4 (25.7)	13.5 (14)	38 (38)	63	16	16	3
4315R/L	315	311	240	47.625 (60)	25.4 (25.7)	13.5 (14)	38 (38)	63	16	22	4

(mm)

( ) Metric size

## Available inserts

TFCN



Designation	Cermet		Coated						Uncoated		page					
	CN2500	CN30	NC5330	NCM325	NCM635	NCM645	PC2010	PC3700	PC6510	PC9530		PC9540	PC5300	PC5400	ST30A	G10
TFCN 2203PFR																
2203PFL																E28

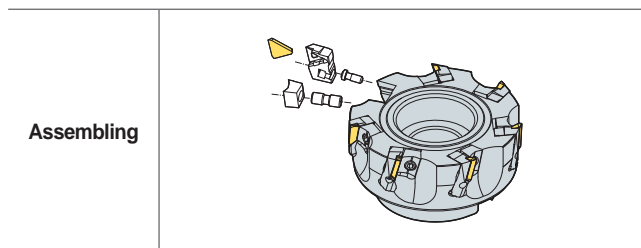
## Available arbors

Designation	General arbor	NC arbors	
		PF	PFM
<b>PF</b> 4080R/L	NT*□□ (M/U)-FMA25.4-25	BT**□□-FMA25.4-□□	FMC27
<b>(PFM)</b> 4100R/L	NT*□□ (M/U)-FMA31.75-□□	BT**□□-FMA31.75-□□	FMC32
4125R/L	NT*□□ (M/U)-FMA38.1-□□	BT**□□-FMA38.1-□□	FMB40
4160R/L	NT*□□ (M/U)-FMA50.8-□□	BT**□□-FMA50.8-□□	FMB40
4200R/L	NT*□□ (M/U)-FMA47.625-25, KCP-8***	BT**□□-FMA47.625-□□	FMB60
4250R/L	NT*□□ (M/U)-FMA47.625-25, KCP-8***	BT**□□-FMA47.625-□□	FMB60
4315R/L	KCP-8*** (Center ring plug)		

\*□□-NT number \*\*□□-BT number \*\*\*Over milling 5

## Recommended cutting condition

Workpiece	Cutting condition		Grades
	vc (m/min)	fz (mm/t)	
<b>P</b>	190~320	0.05~0.20	<b>NCM325</b> <b>PC3700</b> <b>ST30A</b>
	161~270	0.05~0.20	
	80~140	0.05~0.20	
<b>M</b>	90~150	0.05~0.20	<b>PC9530</b>
<b>K</b>	140~230	0.05~0.30	<b>PC6510</b> <b>G10</b>
	50~90	0.05~0.30	



## Parts

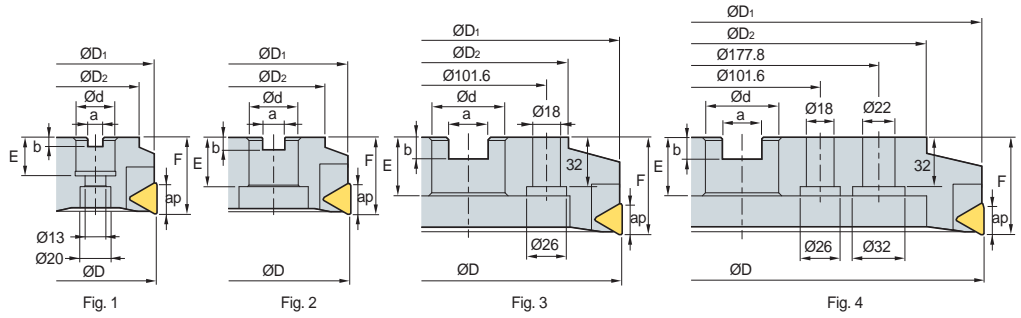
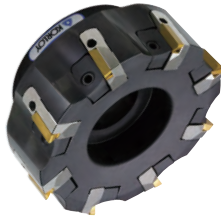
Specification	Locator	Wedge	Wedge screw	Locator screw	Wrench
Ø80-Ø315	LPF4R/L LPF4R1**/L1**	WPR/L	DHA0821F DHA0817F*	LTX0512	HW40

Available inserts **E28** Available arbors and bolt **E426-E428**

\* : Ø80-Ø100 / \*\* : Ø80-Ø125



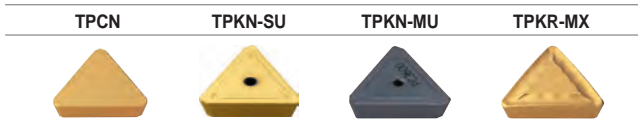
# PPN(M)4000



Designation		⊙	ØD	ØD1	ØD2	Ød	a	b	E	F	ap	kg	Fig.
PPN (PPNM)	4080R/L	5	80	79	57	25.4 (27)	9.5 (12.4)	6 (7)	25 (22)	50	18	1.3	1
	4100R/L	6	100	99	67	31.75 (32)	12.7 (14.4)	8 (8)	32 (28)	50	18	1.9	2
	4125R/L	8	125	124	87	38.1 (40)	15.9 (16.4)	10 (9)	38 (30)	63	18	3.5	2
	4160R/L	10	160	158	107	50.8 (40)	19.0 (16.4)	11 (9)	38 (30)	63	18	5.6	2
	4200R/L	12	200	198	130	47.625 (60)	25.4 (25.7)	14 (14)	38 (38)	63	18	8.1	3
	4250R/L	16	250	248	180	47.625 (60)	25.4 (25.7)	14 (14)	38 (38)	63	18	13.3	3
	4315R/L	20	315	313	240	47.625 (60)	25.4 (25.7)	14 (14)	38 (38)	63	18	21.4	4

( ) Metric size

## Available inserts



Designation	Cermet	Coated						Uncoated		page
		CN2500 CN30	NCM325 NCM335 NCM535 NCM545	PC3700 PC6510 PC9540 PC5300 PC5400	ST30A G10 H01					
TPCN	2204PDR	●	●				●	●	E28	
	2204PDR-G							●		
	2204PDL						●			
	2204PDSR		●							
	2204PDTR									
	2204PDR-RH									
	2204PDER-RH				●	●				
TPKN	2204PDSR-MU		●					E29		
	2204PDSR-SU		●		●	●				
	2204PDSL-SU		●							
TPKR	2204PDR-MX		●					E29		
	2204PDSR-MX		●	●						
	2204PPR-MX									

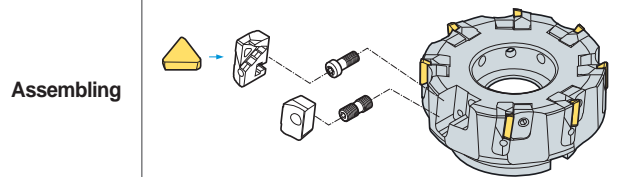
## Available arbors

Designation	General arbor	NC arbors	
		PPN	PPNM
PPN 4080R/L	NT*□□ (M/U)-FMA25.4-25	BT**□□-FMA25.4-□□	FMC27
(PPNM) 4100R/L	NT*□□ (M/U)-FMA31.75-□□	BT**□□-FMA31.75-□□	FMC32
4125R/L	NT*□□ (M/U)-FMA38.1-□□	BT**□□-FMA38.1-□□	FMB40
4160R/L	NT*□□ (M/U)-FMA50.8-□□	BT**□□-FMA50.8-□□	FMB40
4200R/L	NT*□□ (M/U)-FMA47.625-25, KCP-8***	BT**□□-FMA47.625-□□	FMB60
4250R/L	NT*□□ (M/U)-FMA47.625-25, KCP-8***	BT**□□-FMA47.625-□□	FMB60
4315R/L	KCP-8*** (Center ring plug)		

\*□□-NT number \*\*□□-BT number \*\*\*Over milling 5

## Recommended cutting condition

Workpiece	Cutting condition		Grades
	vc (m/min)	fz (mm/t)	
P	190~320	0.05~0.20	NCM325 PC3700 ST30A
	161~270	0.05~0.20	
	80~140	0.05~0.20	
M	90~150	0.05~0.20	PC9530
K	140~230	0.05~0.30	PC6510 G10
	50~90	0.05~0.30	



## Parts

Specification	Locator	Wedge	Wedge screw	Locator screw	Wrench
Ø80~Ø315	LPPN4R/L LPPN4R1*/L1*	WPPN4R/L	DHA0821F DHA0817F*	LTX0514	HW40

\* : Ø80~Ø100

Available inserts E28, E29 Available arbors and bolt E426~E428



Highly rigid inserts for roughing

# Mill-max Heavy **new**

- Productivity - Cutting time is reduced by the cutting-edge design specialized for rough facing at high depth of cuts
- High rigidity - The highly rigid inserts and cutter seams prevent tool breakage in rough facing
- Clamping stability- The wedge-type clamping system, which is easy-to-use and strong, reduces time for replacing inserts, and improves clamping stability

### Features of insert

**• Highly rigid inserts**  
- Ideally suited for roughing at high depth of cuts

**• Wide chip pocket area**  
- Improved chip evacuation  
- Reduced cutting loads

**• Minor cutting-edge**  
- Improved surface finish thanks to the wiper function

**• Major cutting-edge**  
- High rake angle

**• 2-level flank relief surface**  
- Relief angle availability even at high feed rates

**MAX. ap**  
SCKN22: 10.5 mm  
SCKN28: 14.5 mm

### Features of chip breakers

Insert	Cutting-edge	Uses	Features
MM		For roughing	Highly rigid chip breaker ideally suited for roughing at high depth of cuts

### Features of cutter

**• Cutter seams**  
- Prevent cutter breakage even under harsh cutting conditions

**• Wide chip pockets**  
- Improve chip evacuation

**• Wedge-type clamping system**  
- Provides clamping stability  
- Reduces time for replacing inserts

### Recommended cutting condition

	Workpiece	Grades	Cutting condition		
			vc (m/min)	fz (mm/t)	ap (mm)
P	Low carbon steel/Mild steel	PC5300, NC5340, NCM535	140~270	0.2~0.4	2.0~10.0 [SCKN22], 3.0~14.0 [SCKN28]
	High carbon steel	PC5300, NC5340, NCM535	100~220	0.2~0.4	2.0~10.0 [SCKN22], 3.0~14.0 [SCKN28]
	Alloy steel	PC5300, NC5340, NCM535	100~180	0.2~0.4	2.0~10.0 [SCKN22], 3.0~14.0 [SCKN28]
M	Stainless steel	PC5300, NC5340, NCM535	90~180	0.2~0.4	2.0~10.0 [SCKN22], 3.0~14.0 [SCKN28]
K	Cast iron	PC5300, NC5340, NCM535	100~180	0.2~0.4	2.0~10.0 [SCKN22], 3.0~14.0 [SCKN28]

## HDDCM 7000/9000 new

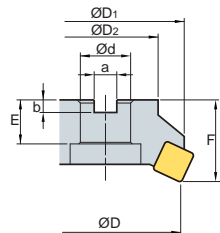


Fig. 1

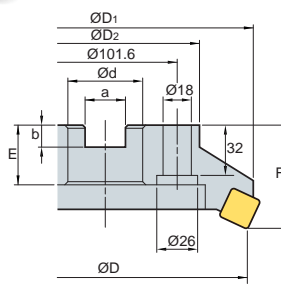


Fig. 2

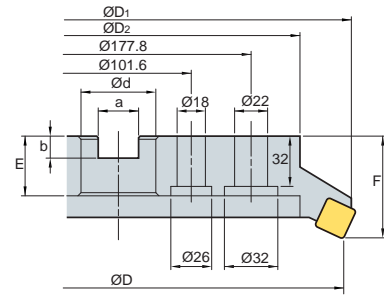


Fig. 3



AA  
**55°**  
•AR: 15°  
•RR: 5°

(mm)

Designation		ØD	ØD1	ØD2	Ød	a	b	E	F	ap		Fig.	
HDDCM	7125R/L-5	5	125	135.6	90	40	16.4	9	32	63	10.5	3.43	1
	7160R/L-6	6	160	169.8	110	40	16.4	9	32	63	10.5	4.89	2
	7160R/L-8	8	160	169.8	110	40	16.4	9	32	63	10.5	4.62	2
	7200R/L-8	8	200	209.2	130	60	25.7	14	38	80	10.5	8.49	2
	7200R/L-10	10	200	209.2	130	60	25.7	14	38	80	10.5	8.74	2
	7250R/L-10	12	250	258.6	180	60	25.7	14	38	80	10.5	13.44	2
	7250R/L-12	10	250	258.6	180	60	25.7	14	38	80	10.5	13.41	2
	7315R/L-12	12	315	323.2	240	60	25.7	14	38	80	10.5	21.69	3
HDDCM	7315R/L-14	14	315	323.2	240	60	25.7	14	38	80	10.5	21.41	3
	9125R/L-5	5	125	140.4	90	40	16.4	9	32	63	14.5	3.4	1
	9160R/L-6	6	160	177.6	110	40	16.4	9	32	80	14.5	6.39	2
	9200R/L-8	8	200	213.6	130	60	25.7	14	38	80	14.5	8.76	2
	9250R/L-10	10	250	265	180	60	25.7	14	38	80	14.5	13.84	2
	9250R/L-12	12	250	265	180	60	25.7	14	38	80	14.5	13.41	2
	9315R/L-12	12	315	327.4	240	60	25.7	14	38	80	14.5	21.02	3

### Available inserts

SCKN-MM



Designation	Cermet	Coated						Uncoated		page
	CN2500 CN30	NC5330 NCM325	NCM535 NCM545	PC2010 PC3700	PC6510 PC9530	PC5300 PC5400	ST30A G10	H01		
7000 type SCKN 220715DDSR-MM			●	●		●			E19	
9000 type SCKN 280920DDSR-MM										

### Recommended cutting condition

Workpiece	Cutting condition		Grades
	vc (m/min)	fz (mm/t)	
P	140~270	0.2~0.4	NC5340 NCM535
	100~220		
	100~180		
M	90~180		
K	100~180		

### Parts

Specification					
Ø125~Ø315 (7000 type)	WHD7R/L	WHX0817	SS64DPR	FTGA0614	HW40
Ø125~Ø315 (9000 type)	WHD9R/L	WHX0817	SS84DPR	FTGA0818	HW40

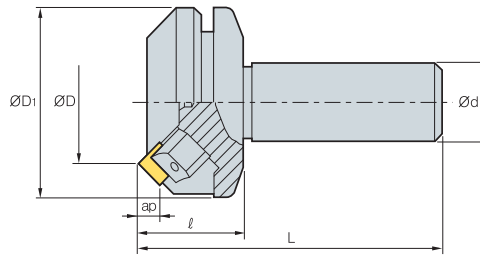
### Available arbors

Designation	General arbor	
HDDCM	7125R/L-5	NT*□□(M/U)-FMC40
	7160R/L-6	
	7160R/L-8	
	7200R/L-8	
HDDCM	7200R/L-10	NT*□□(M/U)-FMC60
	7250R/L-10	
	7250R/L-12	
	7315R/L-12	
	7315R/L-14	
HDDCM	9125R/L-5	NT*□□(M/U)-FMC40
	9160R/L-6	
	9200R/L-8	NT*□□(M/U)-FMC60
	9250R/L-10	
	9250R/L-12	
	9315R/L-12	

\*□□-NT number \*\*□□-BT number \*\*\*Over milling 5



# ADS4000



AA  
45°  
• AR: 15°  
• RR: -3°

(mm)

Designation		ØD	ØD1	Ød	l	L	ap	
ADS	4050R/L	3	50	75	32	40	120	1.8
	4050R/L-S42	3	50	75	42	40	120	2.2
	4063R/L	4	63	87	32	40	120	2.3
	4063R/L-S42	4	63	87	42	40	120	2.7

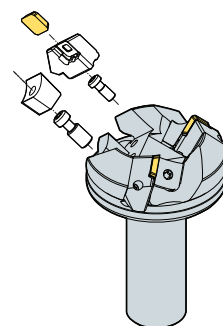
## Available inserts

		SDCN	SDKN-MU	SDKN-SU	SDKR-MX		
Designation	page	Cermet	Coated			Uncoated	
		CN2500 CN30	NCM325 NCM335 NCM335 NCM535 NCM545 PC3700 PC6510 PC9530 PC9540 PC5300 PC5400	ST30A G10 H01			
SDCN 42M							
42M-G							
42MT		●	●			●	
42MT-RH							
42MT-S20	E19				●		
1203AEEN							
1203AEEN-RH							
1203AESN							
1203AESN-RH							
SDKN 1203AESN-MU	E20			●			
1203AESN-SU				●	●	●	
SDKR 1203AESN-MX							
1203AETN-MX	E20						
1203AEN-MX			●				

## Recommended cutting condition

Workpiece	Cutting condition		Grades
	vc (m/min)	fz (mm/t)	
P	190~320	0.05~0.20	NCM325 PC3700 ST30A
	161~270	0.05~0.20	
	80~140	0.05~0.20	
M	90~150	0.05~0.20	PC9530
K	140~230	0.05~0.30	PC6510 G10
	50~90	0.05~0.30	

Assembling



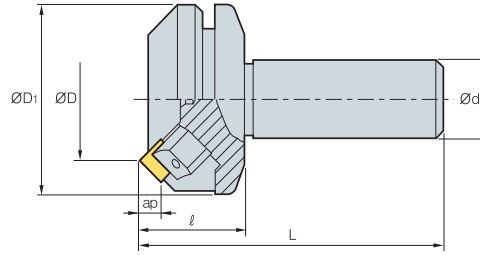
## Parts

Specification					
Ø50~Ø63	LASS4R/L	WASR/L	WTX0817	LTX0512	TW25

Available inserts E19, E20



## ADS5000



AA  
45°  
•AR: 15°  
•RR: -3°

(mm)

Designation			ØD	ØD1	Ød	ℓ	L	ap	
ADS	5050R/L	3	50	75	32	40	120	8.5	1.9
	5050R/L-S42	3	50	75	42	40	120	8.5	2.3
	5063R/L	4	63	87	32	40	120	8.5	2.4
	5063R/L-S42	4	63	87	42	40	120	8.5	2.8

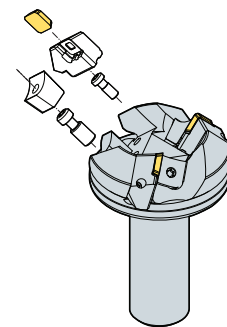
### Available inserts

		SDCN	SDKN-MU	SDKN-SU	SDKR-MX			
Designation	page	Cermet	Coated				Uncoated	
		CN2500 CN30	NC5330 NCM325 NCM335 NCM535 NCM545	PC3700 PC6510 PC9530 PC9540 PC5300 PC5400	ST30A G10 H01			
SDCN 53M							●	
53M-G							●	
53MT		●	●				●	
53MT-RH								
53MT-S20	E19				●			
1504AEEN								
1504AEEN-RH					●	●		
1504AESN								
1504AESN-RH					●			
SDKN 1504AESN-MU	E20				●			
1504AESN-SU				●		● ●		
SDKR 1504AESN-MX			●					
1504AETN-MX	E20							
1504AEN-MX			●					

### Recommended cutting condition

Workpiece	Cutting condition		Grades
	vc (m/min)	fz (mm/t)	
P	190~320	0.05~0.20	NCM325 PC3700 ST30A
	161~270	0.05~0.20	
	80~140	0.05~0.20	
M	90~150	0.05~0.20	PC9530
K	140~230	0.05~0.30	PC6510 G10
	50~90	0.05~0.30	

### Assembling



### Parts

Specification					
Ø50-Ø63	LASS5R/L	WASR/L	WTX0817	LTX0512	TW25

Available inserts E19, E20



# PES2000/3000/4000

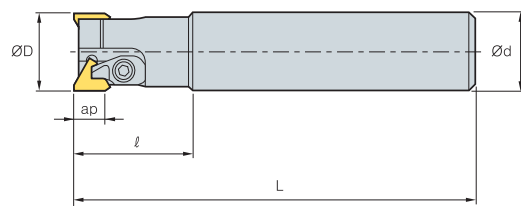


Fig. 1

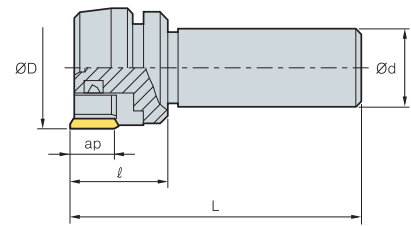
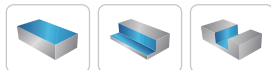


Fig. 2



AA  
**90°**  
•AR: 10°~15°  
•RR: 2°~3°

(mm)

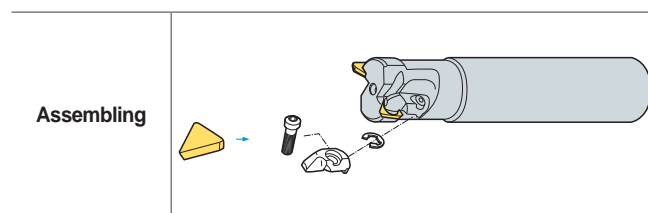
Designation		ØD	Ød	l	L	ap		Fig.	
PES	2020R/L	2	20	20	30	110	0.3	1	
	2025R/L	2	25	25	35	120	0.5	1	
	3030R/L	2	30	32	45	160	0.9	1	
	3032R/L	2	32	32	45	160	1.0	1	
	3033R/L	2	33	32	45	160	1.1	1	
	3035R/L	2	35	32	45	160	1.2	1	
	3036R/L	2	36	32	45	160	1.3	1	
	3040R/L	2	40	32	45	160	1.4	1	
	4050R/L	3	50	32	40	120	16.5	1.2	2
	4050R/L-S42	3	50	42	40	120	16.5	1.5	2
	4063R/L	4	63	32	40	120	16.5	1.5	2
	4063R/L-S42	4	63	42	40	120	16.5	1.8	2

## Available inserts

		TECN	TEEN																	
Designation		Cermet		Coated				Uncoated	page											
		CN2500	CN30	NC5330	NCM325	NCM335	NCM535			NCM545	PC3700	PC6510	PC9530	PC9540	PC5300	PC5400	ST30A	G10	H01	
2000 type	TECN 22R																			
	22TR		●												●					E27
3000 type	TECN 32R																			
	32TR		●												●					E27
	32TR-S20										●									
4000 type	TEEN 43R																			
	43R-G																			
	43TR		●	●											●					
	43TR-S20																			E27
	43TR-Z																			
	43TR-ZH																			

## Recommended cutting condition

Workpiece	Cutting condition		Grades
	vc (m/min)	fz (mm/t)	
P	190~320	0.05~0.20	NCM325 PC3700 ST30A
	161~270	0.05~0.20	
	80~140	0.05~0.20	
M	90~150	0.05~0.20	PC9530
K	140~230	0.05~0.30	PC6510 G10
	50~90	0.05~0.30	

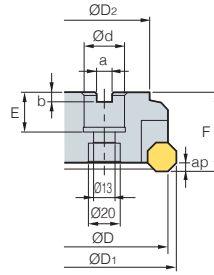


## Parts

Specification								
Ø20~Ø25 (2000 type)	-	-	-	CHX0407	HW25L	-	CH4R1	ER03
Ø30~Ø40 (3000 type)	-	-	-	CHX0510	HW30L	-	CH5R1	ER04
Ø50~Ø63 (4000 type)	LPTS4R/L	WPTS	DHA0815	LTX0512	-	HW40	-	-

Available inserts E27

## AFO(M)4000



AA  
45°  
•AR: 15°  
•RR: 5°

(mm)

Designation		ØD	ØD1	ØD2	Ød	a	b	E	F	ap		
<b>AFO</b>	<b>4080R/L</b>	5	80	88	60	25.4 (27)	9.5 (12.4)	6 (7)	25 (22)	50	3.3	1.4
<b>(AFOM)</b>	<b>4100R/L</b>	6	100	108	80	31.75 (32)	12.7 (14.4)	8 (8)	32 (28)	50	3.3	2.0
	<b>4125R/L</b>	8	125	133	100	38.1 (40)	15.9 (16.4)	10 (9)	38 (30)	63	3.3	3.1

( ) Metric size

### Available inserts

	OFCW	OFKT-MF	OFKT-MM	OFKT-MA		
Designation	Cermet	Coated			Uncoated	page
	CN2500 CN30	NC5330 NCM325 NCM535 NCM545	PC2010 PC3700 PC6510 PC9530 PC9540 PC5300 PC5400	ST30A G10 H01		
OFCW	05T3SN 05T3FN 05T308FN					E14
OFKT	05T3SN-MF 05T308SN-MF 05T3SN-MM 05T308SN-MM 05T3FN-MA 05T3EN-MA		● ● ● ● ● ● ●		●	E14 E15

### Available arbors

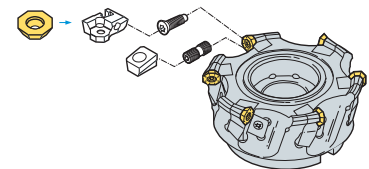
Designation	General arbor	NC arbors		
		AFO	AFOM	
<b>AFO</b>	<b>4080R/L</b>	NT*□□(M/U)-FMA25.4-25	BT**□□-FMA25.4-□□	FMC27
<b>(AFOM)</b>	<b>4100R/L</b>	NT*□□(M/U)-FMA31.75-□□	BT**□□-FMA31.75-□□	FMC32
	<b>4125R/L</b>	NT*□□(M/U)-FMA38.1-□□	BT**□□-FMA38.1-□□	FMB40

\*□□-NT number \*\*□□-BT number \*\*\*Over milling 5

### Recommended cutting condition

Workpiece	Cutting condition		Grades
	vc (m/min)	fz (mm/t)	
<b>P</b>	190~320	0.05~0.20	<b>NCM325</b> <b>PC3700</b> <b>ST30A</b>
	161~270	0.05~0.20	
	80~140	0.05~0.20	
<b>M</b>	90~150	0.05~0.20	<b>PC9530</b>
<b>K</b>	140~230	0.05~0.30	<b>PC6510</b> <b>G10</b>
	50~90	0.05~0.30	

### Assembling



### Parts

Specification					
Ø80~Ø125	LAF04R/L	WAFO4R/L	DHA0815	FTKA0408	TW15S

Available inserts E14, E15 Available arbors and bolt E426-E428



# AFO(M)5000

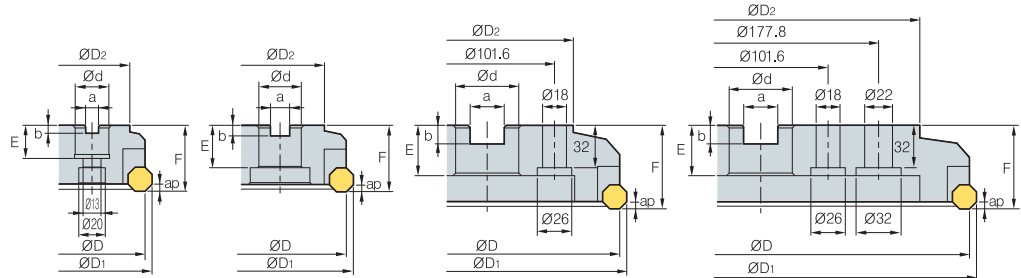


Fig. 1 Fig. 2 Fig. 3 Fig. 4



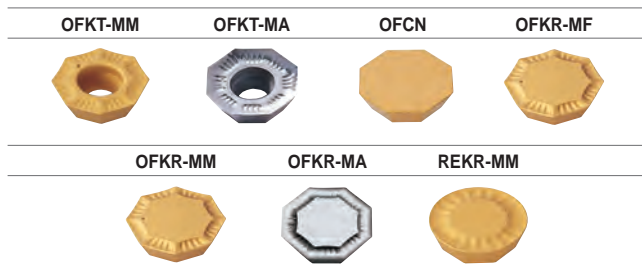
AA  
45°  
•AR: 15°  
•RR: 5°

(mm)

Designation	ØD	ØD1	ØD2	Ød	a	b	E	F	ap	kg	Fig.
AFO (AFOM) 5080R/L	80	91	60	25.4 (27)	9.5 (12.4)	6 (7)	25 (22)	50	4.8	1.4	1
5100R/L	100	111	80	31.75	12.7 (14.4)	8 (8)	32 (28)	50	4.8	2.0	2
5125R/L	125	136	100	38.1 (40)	15.9 (16.4)	10 (9)	38 (30)	63	4.8	3.1	2
5160R/L	160	171	120	50.8 (40)	19.0 (16.4)	11 (9)	38 (30)	63	4.8	5.2	2
5200R/L	200	211	130	47.625 (60)	25.4 (25.7)	13.5 (14)	38 (38)	63	4.8	7.5	3
5250R/L	250	261	180	47.625 (60)	25.4 (25.7)	13.5 (14)	38 (38)	63	4.8	16.1	3
5315R/L	315	326	240	47.625 (60)	25.4 (25.7)	13.5 (14)	38 (38)	63	4.8	22.8	4

( ) Metric size

## Available inserts



Designation	Cermet	Coated							Uncoated	page			
	CN2500 CN30	NC5330 NCM325	NCM335	NCM535	NCM545	PC3700	PC6510	PC9530	PC9540		PC5300	PC5400	ST30A G10 H01
OFCN 0704SN							●						E14
0704FN													
070408SN													
070408FN													
OFKR 0704SN-MF		●●											E14
070408SN-MF													
0704SN-MM		●●	●●	●●	●●	●							
070408SN-MM		●											
0704FN-MA												●	
0704EN-MA													
OFKT 0704SN-MM													E14
0704FN-MA												●	
0704EN-MA													
REKR 170400-MM													E17

## Available arbors

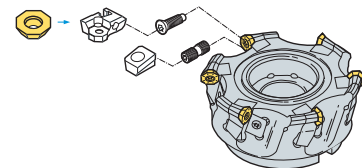
Designation	General arbor	NC arbors	
		AFO	AFOM
AFO (AFOM) 5080R/L	NT*□□ (M/U)-FMA25.4-25	BT**□□-FMA25.4-□□	FMC27
5100R/L	NT*□□ (M/U)-FMA31.75-□□	BT**□□-FMA31.75-□□	FMC32
5125R/L	NT*□□ (M/U)-FMA38.1-□□	BT**□□-FMA38.1-□□	FMB40
5160R/L	NT*□□ (M/U)-FMA50.8-□□	BT**□□-FMA50.8-□□	FMB40
5200R/L	NT*□□ (M/U)-FMA47.625-25, KCP-8***	BT**□□-FMA47.625-□□	FMB60
5250R/L	NT*□□ (M/U)-FMA47.625-25, KCP-8***	BT**□□-FMA47.625-□□	FMB60
5315R/L	KCP-8*** (Center ring plug)		

\*□□-NT number \*\*□□-BT number \*\*\*Over milling 5

## Recommended cutting condition

Workpiece	Cutting condition		Grades
	vc (m/min)	fz (mm/t)	
P	190~320	0.05~0.20	NCM325 PC3700 ST30A
	161~270	0.05~0.20	
	80~140	0.05~0.20	
M	90~150	0.05~0.20	PC9530
K	140~230	0.05~0.30	PC6510 G10
	50~90	0.05~0.30	

## Assembling



## Parts

Specification	Locator	Wedge	Wedge screw	Locator screw	Wrench
Ø80~Ø315	LAF05R/L LAF05R*/L-1*	WEFR/L	DHA0821F	LTX0512	HW40

Available inserts E14-E17

Available arbors and bolt E426-E428

\*: Ø80-Ø100



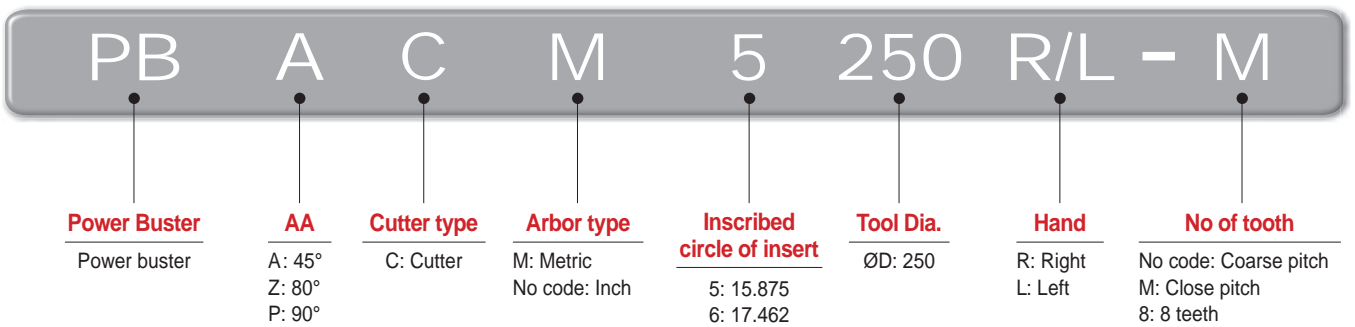
# E Technical Information for Power Buster

New serrated edge design increases productivity by reducing insert cutting load

## Power Buster

- New tooling utilizing a specially designed serrated edge to increase productivity by reducing the cutting load.
- Double-sided 6 corner insert geometry ensures high rigidity, long tool life and cost efficiency
- The serrated edge divides the chips into smaller pieces. This feature provides excellent chip control, reduces interference of the cutter and ensures good durability of the cutter body.
- Two types of inserts are available-TNMX27 for PBA (Approach angle: 45°) and PBZ (AA: 80°), and TNMX30 for PBP (AA: 90°)
- Application: High depth of cut and feed rate (Steel, Cast iron)

### Code system

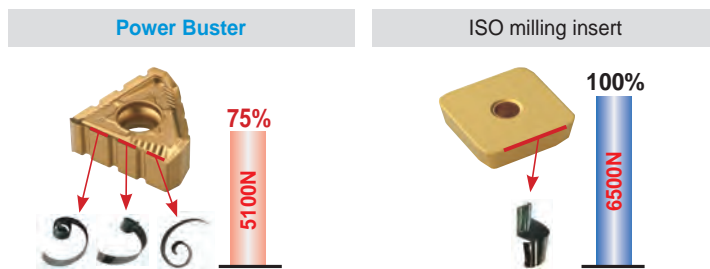


### Features of insert

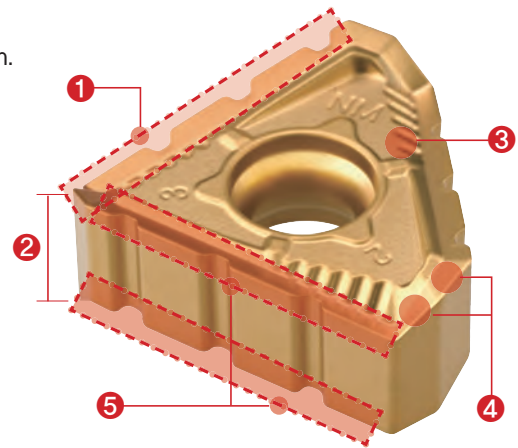
#### 1 Major cutting-edge (Serrated edge)

- Low cutting force
- Ideal for chip control, divides chips into small pieces for proper chip evacuation.
- Ideal edge design for Steel and Cast iron rough milling

#### Comparison of chip control and cutting force

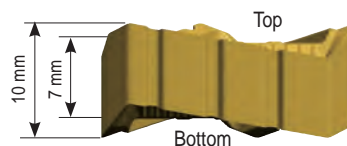


- **Workpiece** SCM440
- **Cutting condition** vc = 200 m/min, ap = 8 mm, ae = 90 mm, fz = 0.3 mm/t



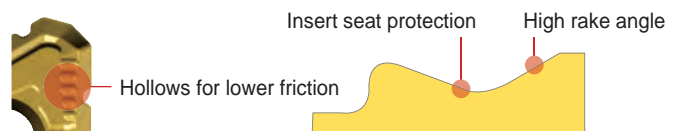
#### 2 Thicker insert

- Thick insert guarantees high rigidity
- Balanced insert design for stable mounting



#### 3 NM Chip breaker

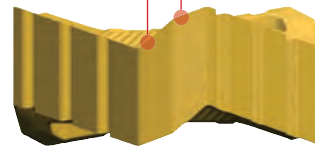
- High rake angle for low cutting force
- Good chip flow at various feed and depth of cut
- Inserts are protected with seats for a precise mounting
- Low friction and good heat evacuation at high depth cut



## 4 Insert shape applied to PBA/Z cutters (AA: 45°/80°)

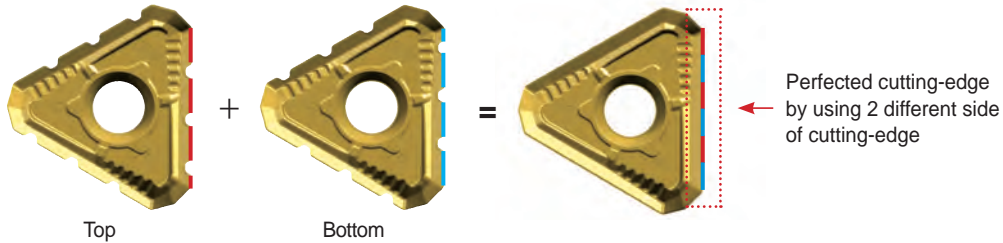
- High rake angle to avoid interference with chip
- Calculated minor cutting-edge angel for both AA 45° & 80° cutter

2<sup>nd</sup> minor cutting-edge for AA 80°      1<sup>st</sup> minor cutting-edge for AA 45°



## 5 Mirror system

- Cutting-edge on the both side of insert covers all overlapped cutting area



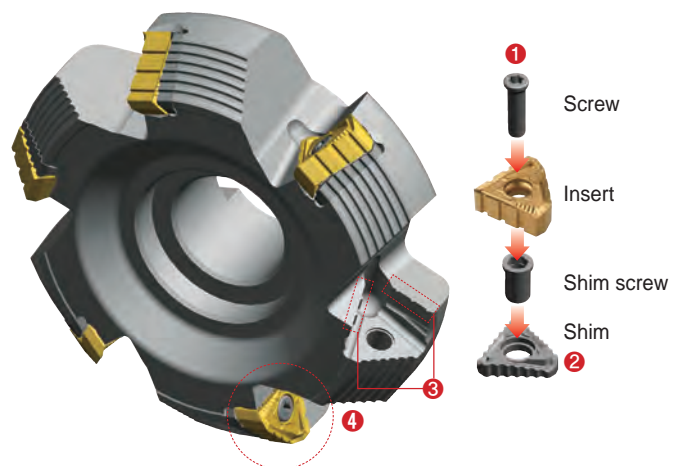
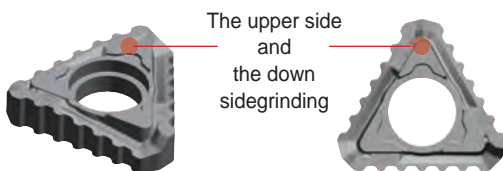
## Features of cutter

### 1 Screw-on clamping system

- Simple and strong screw on clamping system

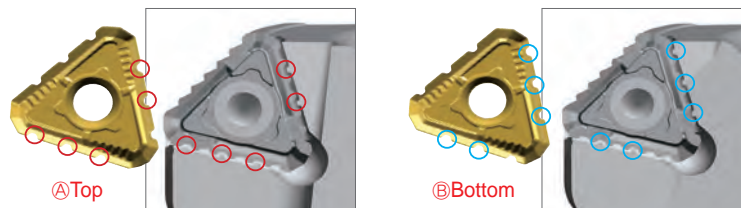
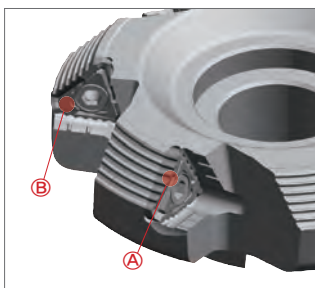
### 2 Better rigidity & Stable Assembly system

- The shim protects the cutter from insert damage
- High accuracy shim ensures tighter clamping



### 3 Foolproof System

- Insert serrations match pocket design to prevent improper seating and alignment

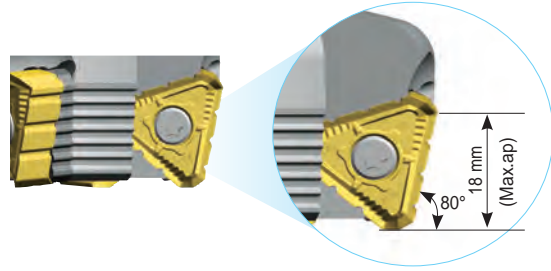
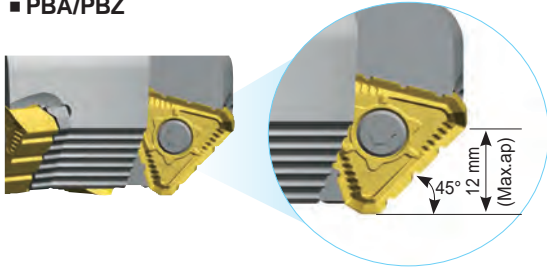


# E Technical Information for Power Buster

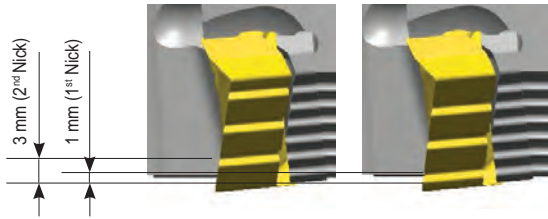
## 4 Multi-application system

- Same insert for multi-use (45° and 80°)

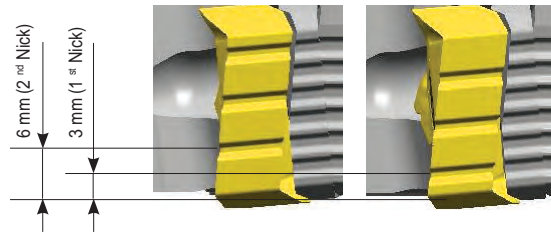
### ■ PBA/PBZ



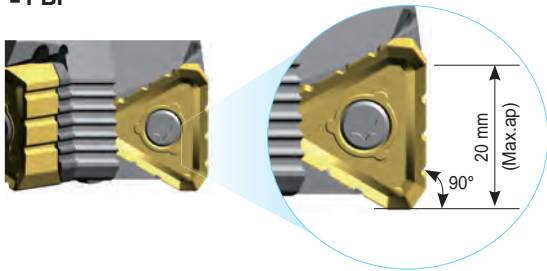
The serrations are effective with a depth of cut larger than 1 mm



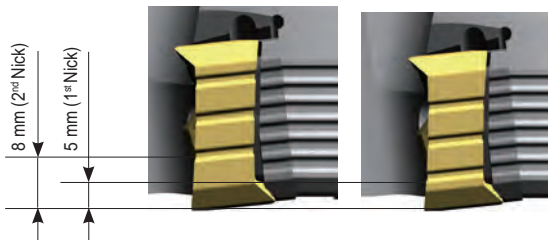
The serrations are effective with a depth of cut larger than 3 mm



### ■ PBP



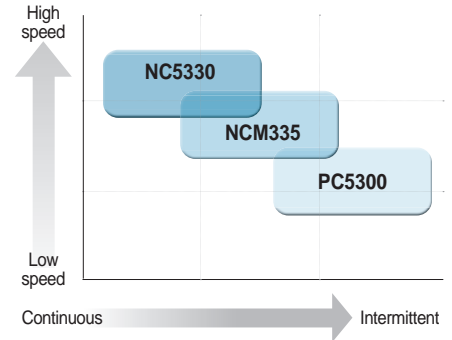
For the AA 90° cutter, nicks function properly at depth of cuts over 5 mm





## Recommended cutting condition

ISO	Workpiece	Material	NC5330	NCM335	PC5300	
			fz (mm/t)			
			0.1-0.2-0.3	0.1-0.2-0.3	0.1-0.2-0.3	
			vc (m/min)			
P	Carbon steel	-	SUM22, C = 0.1~25	400	335	280
		-	C = 0.30~55	365	305	255
		-	C = 0.55~80	340	285	240
	Low alloy steel (Alloy constituent < 5%)	-	SCM415(H), SCM420, SCM440	280	235	195
		Hardened		165	140	115
		High alloy steel (Alloy constituent > 5%)	Annealed	SKD61	210	180
	Hardened	SKH51, SKH55	175	145	120	
K	Gray cast iron	Low tensile	FC200, FC250	125	-	145
		High tensile	FC300, FC350	105	-	120
		Ferric	FCD400, FCD500	80	-	95
		Pearlitic	FCD600, FCD700	75	-	85

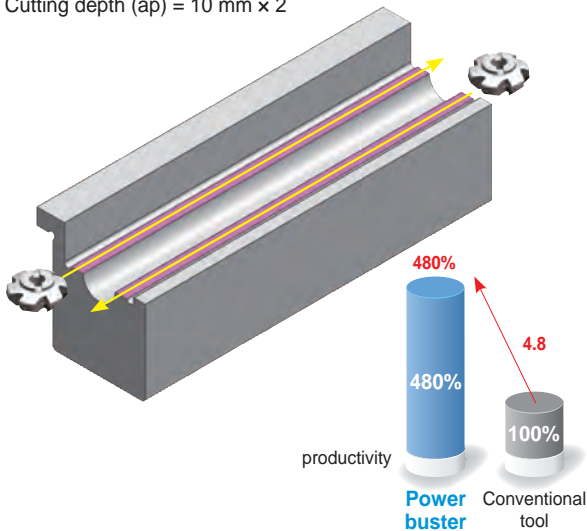


## Power Buster test

### ■ Cylinder block for ship engine (Cast iron)

Cutting width (ae) = 160 mm x 2

Cutting depth (ap) = 10 mm x 2

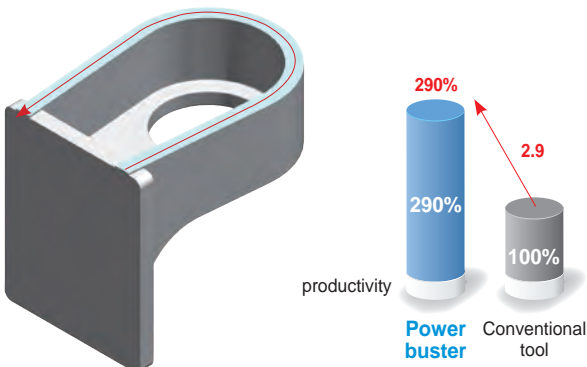


Item	Power buster	Conventional tool
Diameter (ØD)	200 mm	200 mm
	12 tooth	12 tooth
Grades	NC5330	PVD coating for Cast iron
vc	170 m/min	130 m/min
fz	0.24 mm/t	0.16 mm/t
ap	10 mm x 2 passes	4 mm x 5 passes
min	28.2 min/ea	137.5 min/ea
<b>4.8 times productivity increased</b>		<ul style="list-style-type: none"> <li>• One-sided 4 corner insert (Without nick)</li> <li>• AA 45° cutter</li> </ul>

### ■ Heavy machinery part (Alloy steel)

Cutting width (ae) = 35 mm

Cutting depth (ap) = 10 mm



Item	Power Buster	Conventional tool
Diameter (ØD)	125 mm	100 mm
	8 tooth	8 tooth
Grades	NCM335	PVD coating for Cast iron
vc	180 m/min	150 m/min
fz	0.15 mm/t	0.10 mm/t
ap	5 mm x 2 passes	2.5 mm x 4 passes
min	5 min/ea	14.7 min/ea
<b>2.9 times productivity increased</b>		<ul style="list-style-type: none"> <li>• Double-sided 8 corner insert (Without nick)</li> <li>• AA 45° cutter</li> </ul>



## PBAC(M)5000

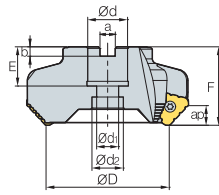


Fig. 1

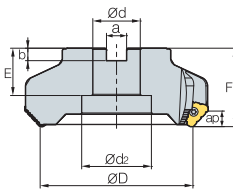


Fig. 2

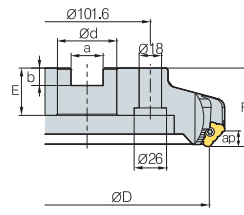


Fig. 3

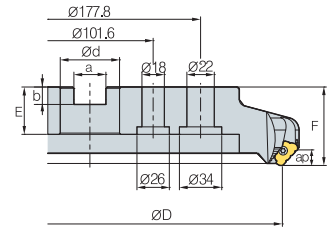


Fig. 4



AA  
45°  
•AR: -5°  
•RR: -11°

(mm)

Designation		⊙	ØD	Ød	Ød1	Ød2	a	b	E	F	ap	Fig.
Coarse pitch	PBAC (PBACM) 5080R/L	4	80	25.4 (27)	14	20	9.5 (12.4)	6 (7)	25 (22)	50	12	1
	5100R/L	4	100	31.75 (32)	-	45	12.7 (14.4)	8 (8)	32 (28)	50	12	2
	5125R/L	6	125	38.1 (40)	-	56	15.9 (16.4)	10 (9)	38 (32)	63	12	2
	5160R/L	8	160	50.8 (40)	-	100	19 (16.4)	11 (9)	38 (32)	63	12	2
	5200R/L	10	200	47.625 (60)	-	-	25.4 (25.7)	14 (14)	38 (38)	63	12	3
	5250R/L	12	250	47.625 (60)	-	-	25.4 (25.7)	14 (14)	38 (38)	63	12	3
5315R/L	14	315	47.625 (60)	-	-	25.4 (25.7)	14 (14)	38 (38)	63	12	4	
Close pitch	PBAC (PBACM) 5080R/L-M	6	80	25.4 (27)	14	20	9.5 (12.4)	6 (7)	25 (22)	50	12	1
	5100R/L-M	6	100	31.75 (32)	-	45	12.7 (14.4)	8 (8)	32 (28)	50	12	2
	5125R/L-M	8	125	38.1 (40)	-	56	15.9 (16.4)	10 (9)	38 (32)	63	12	2
	5160R/L-M	10	160	50.8 (40)	-	100	19 (16.4)	11 (9)	38 (32)	63	12	2
	5200R/L-M	12	200	47.625 (60)	-	-	25.4 (25.7)	14 (14)	38 (38)	63	12	3
	5250R/L-M	14	250	47.625 (60)	-	-	25.4 (25.7)	14 (14)	38 (38)	63	12	3
5315R/L-M	16	315	47.625 (60)	-	-	25.4 (25.7)	14 (14)	38 (38)	63	12	4	

( )Metric size

### Available inserts

TNMX-NM



Designation	Cermet		Coated										Uncoated			page			
	CN2500	CN30	NC5330	NCM325	NCM335	NCM535	NCM545	PC2505	PC2010	PC3700	PC6510	PC9530	PC9540	PC5300	PC5400		ST30A	G10	H01
TNMX 2710AZNR-NM 2710AZNL-NM			●			●				●		●		●					E28

### Available arbors

Designation	Available arbors	
	PBAC	PBACM
PBAC (PBACM) 5080R/L-□	BT□□-FMA25.4-□□	BT□□-FMC27-□□
5100R/L-□	BT□□-FMA31.75-□□	BT□□-FMC32-□□
5125R/L-□	BT□□-FMA38.1-□□	BT□□-FMB40-□□
5160R/L-□	BT□□-FMA50.8-□□	BT□□-FMC40-□□
5200R/L-□	BT□□-FMA47.625-□□	BT□□-FMB60-□□
5250R/L-□		
5315R/L-□		

### Parts

Specification				
Ø80~Ø315	FTGA0518	ST53AZR	SHXN0712F	TW20-100

Available inserts E28 Available arbors and bolt E426-E428



# PBZC(M)5000

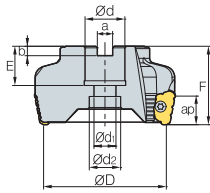


Fig. 1

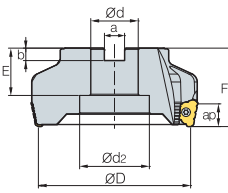


Fig. 2

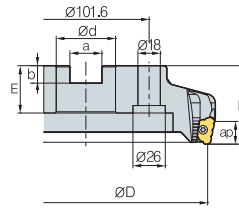


Fig. 3

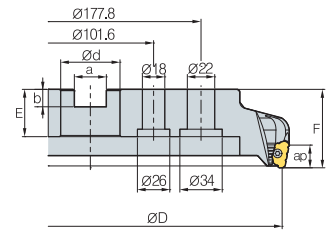


Fig. 4



AA  
80°

- AR: -5°
- RR: -12°

(mm)

Designation			ØD	Ød	Ød1	Ød2	a	b	E	F	ap	Fig.
Coarse pitch	<b>PBZC (PBZCM)</b> 5080R/L	4	80	25.4 (27)	14	20	9.5 (12.4)	6 (7)	25 (22)	50	18	1
	5100R/L	4	100	31.75 (32)	-	45	12.7 (14.4)	8 (8)	32 (28)	50	18	2
	5125R/L	6	125	38.1 (40)	-	56	15.9 (16.4)	10 (9)	38 (32)	63	18	2
	5160R/L	8	160	50.8 (40)	-	100	19 (16.4)	11 (9)	38 (32)	63	18	2
	5200R/L	10	200	47.625 (60)	-	-	25.4 (25.7)	14 (14)	38 (38)	63	18	3
	5250R/L	12	250	47.625 (60)	-	-	25.4 (25.7)	14 (14)	38 (38)	63	18	3
	5315R/L	14	315	47.625 (60)	-	-	25.4 (25.7)	14 (14)	38 (38)	63	18	4
Close pitch	<b>PBZC (PBZCM)</b> 5080R/L-M	6	80	25.4 (27)	14	20	9.5 (12.4)	6 (7)	25 (22)	50	18	1
	5100R/L-M	6	100	31.75 (32)	-	45	12.7 (14.4)	8 (8)	32 (28)	50	18	2
	5125R/L-M	8	125	38.1 (40)	-	56	15.9 (16.4)	10 (9)	38 (32)	63	18	2
	5160R/L-M	10	160	50.8 (40)	-	100	19 (16.4)	11 (9)	38 (32)	63	18	2
	5200R/L-M	12	200	47.625 (60)	-	-	25.4 (25.7)	14 (14)	38 (38)	63	18	3
	5250R/L-M	14	250	47.625 (60)	-	-	25.4 (25.7)	14 (14)	38 (38)	63	18	3
	5315R/L-M	16	315	47.625 (60)	-	-	25.4 (25.7)	14 (14)	38 (38)	63	18	4

( ) Metric size

## Available inserts

TNMX-NM



Designation	Cermet		Coated										Uncoated			page			
	CN2500	CN30	NC5330	NCM325	NCM335	NCM635	NCM645	PC2505	PC2010	PC3700	PC6510	PC9530	PC9540	PC5300	PC5400		ST30A	G10	H01
TNMX 2710AZNR-NM			●			●				●		●		●					E28
2710AZNL-NM																			

## Available arbors

Designation	Available arbors	
	PBZC	PBZCM
<b>PBZC (PBZCM)</b> 5080R/L-□	BT□□ -FMA25.4-□□	BT□□ -FMC27-□□
5100R/L-□	BT□□ -FMA31.75-□□	BT□□ -FMC32-□□
5125R/L-□	BT□□ -FMA38.1-□□	BT□□ -FMB40-□□
5160R/L-□	BT□□ -FMA50.8-□□	BT□□ -FMC40-□□
5200R/L-□		
5250R/L-□	BT□□ -FMA47.625-□□	BT□□ -FMB60-□□
5315R/L-□		

## Parts

Specification				
Ø80-Ø315	FTGA0518	ST53AZR	SHXN0712F	TW20-100

Available inserts E28 Available arbors and bolt E426-E428

## PBPCM6000 new

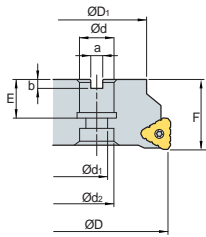
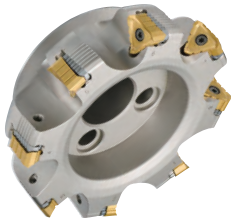


Fig. 1

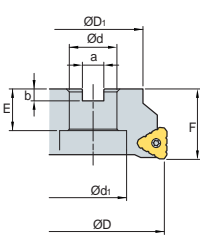


Fig. 2

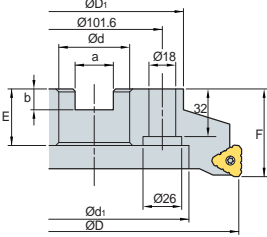


Fig. 3

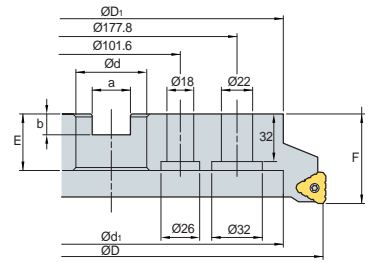


Fig. 4



AA  
90°  
• AR: -5°  
• RR: -12°

(mm)

Designation	ØD	ØD1	Ød	Ød1	Ød2	a	b	E	F	ap	kg	Fig.
<b>PBPCM 6080R-4</b>	80	60	27	14	20	12.4	7	24	50	20	0.85	1
<b>6100R-6</b>	100	70	32	-	54	14.4	8	30	50	20	1.16	2
<b>6125R-6</b>	125	90	40	-	56	16.4	9	32	63	20	2.84	2
<b>6160R-8</b>	160	107	40	-	90	16.4	9	32	63	20	3.58	3
<b>6200R-10</b>	200	130	60	-	132	25.7	14	38	63	20	5.13	3
<b>6250R-12</b>	250	180	60	-	180	25.7	14	38	63	20	9.6	3
<b>6315R-14</b>	315	240	60	-	238	25.7	14	38	63	20	16.85	4

### Available inserts

TNMX-NM



Designation	Cermet		Coated										Uncoated			page			
	CN2500	CN30	NC5330	NCM325	NCM335	NCM535	NCM545	PC2505	PC2010	PC3700	PC6510	PC9530	PC9540	PC5300	PC5400		ST30A	G10	H01
TNMX 3012PNR-NM																			E28

### Available arbors

Designation	General arbor
<b>PBPCM 6080R-4</b>	BT□□-FMC27-□□
<b>6100R-6</b>	BT□□-FMC32-□□
<b>6125R-6</b>	
<b>6160R-8</b>	BT□□-FMC40-□□
<b>6200R-10</b>	
<b>6250R-12</b>	BT□□-FMC60-□□
<b>6315R-14</b>	

### Parts

Specification	Screw	Shim	Shim Screw	Wrench
Ø80~Ø315	FTGA0518	ST53PNR	SHXN0712F	TW20-100

Available inserts E28 Available arbors and bolt E426-E428



Rich Mill series is one of innovations that provides more available cutting-edges by double-sided insert and longer tool life for our customers

# Rich Mill Series

- Rich Mill series is one of the innovations that provides more available cutting-edges with double-sided inserts and longer tool life for our customers
- The unique geometry and special cutting-edge guarantees low cutting loads and long tool life
- Rich Mill series has a wide application range from steel and stainless steel to cast iron and aluminum
- Applying negative inserts makes it even stronger and provides longer tool life
- Rich Mill series has both screw-on clamping system and latch clamping system

## Code system

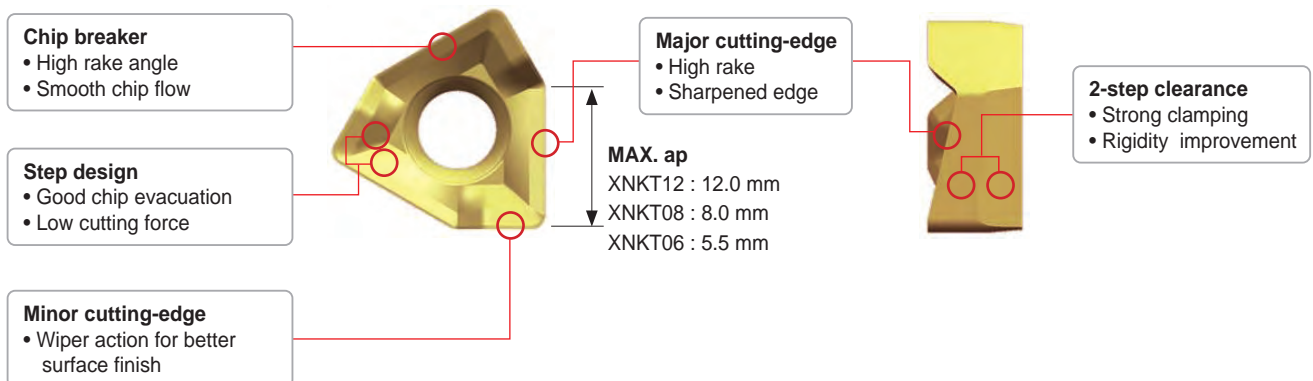
RM16	A	C	M	4	100	H	R - M	
Number of edges	Approach angle	Tool type	Arbors type	Inscribed circle of insert	Tool Dia.	Coolant type	Hand	Pitch type
RM3 : Number of edges-3	A : 45°	C : Cutter	M : Metric	3 : 9.525	Ø100	H : Thru-Hole	R : Right	M : Close
RM4 : Number of edges-4	D : 30°	S : Shank	A : Inch	4 : 12.7		No code : None	L : Left	H : Extra Close
RM6 : Number of edges-6	E : 15°			5 : 15.875				
RM8 : Number of edges-8	F : 5°							
RM8-X : Number of edges-8 (High helix)	P : 0°							
RM14 : Number of edges-14	Q : 2°							
RM16 : Number of edges-16	Z : Plunging							
RMT8 : Number of edges-8 (Latch Clamp)								
RMH8 : Number of edges-8 (Shim)								
RMR : Number of edges-8 (Round Type)								

## Rich Mill RM3

### Features

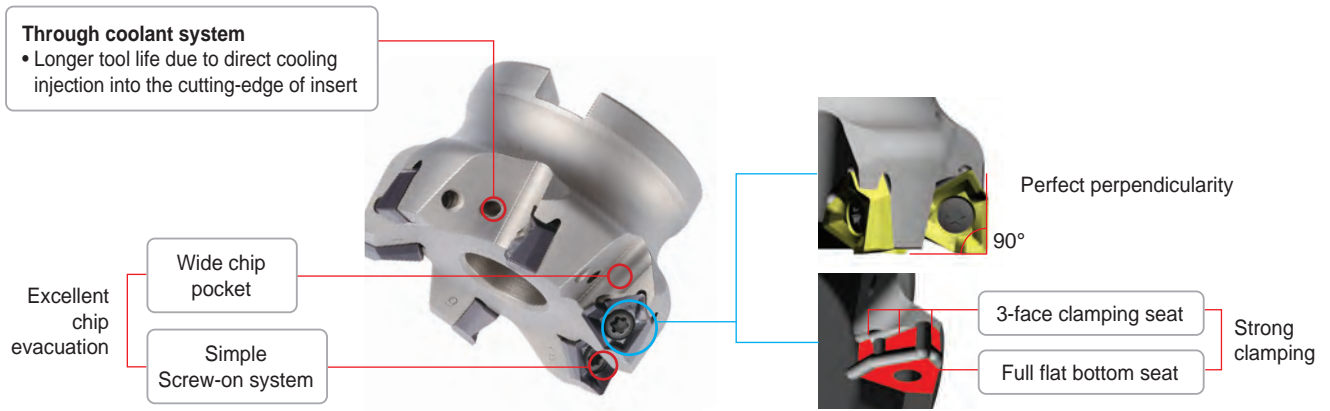
- High Quality - True 90° shouldering operation
- High Productivity - Strong thick insert and 3-face clamping ensure stable operation even tough condition.
- High Economics - Long tool life due to optimized manufacturing process

### Features of insert



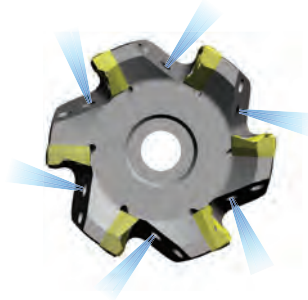
## Rich Mill RM3

### Features of cutter



### Through coolant system

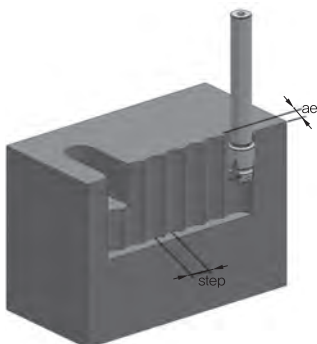
- Exclusive through coolant bolt required
- Effective coolant distribution directly to cutting-edge
- Coolant supporting arbor required



### Features of chip breakers

Insert	Cutting-edge	Uses	Features
MA		Aluminum	Superior cutting quality for aluminum due to sharp cutting-edge and buffed surface
ML		Light	Superior cutting quality for light and light cutting, difficult-to-cut material machining through the low cutting load of chip breaker
MM		General	Suitable for various cutting due to special shape design for general cutting

### Max step in plunging



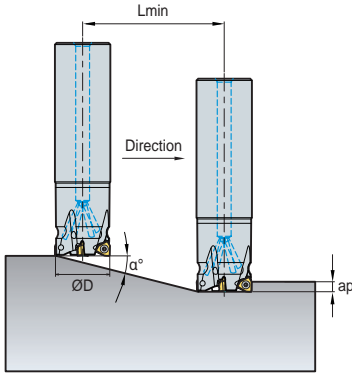
Type	max. ae	Cutter Diameter (Ø)												
		Ø20	Ø21	Ø25	Ø26	Ø32	Ø33	Ø40	Ø50	Ø63	Ø80	Ø100	Ø125	
3000 type	2.5	max step (mm)												
4000 type	3.0	1	8.5	8.9	9.7	10	11.1	11.3	12.4	14	15.7	17.7	19.9	22.2
5000 type	3.5	2	12	12.3	13.5	13.8	15.4	15.7	17.4	19.5	22	24.9	28	31.3
		3	-	-	-	-	-	-	21	23.7	26.8	30.3	34.1	38.2



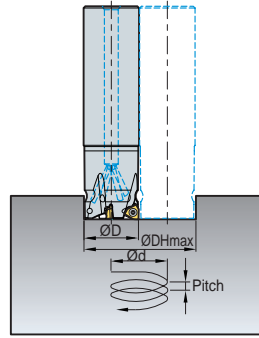
# Rich Mill RM3

## Ramping and helical cutting

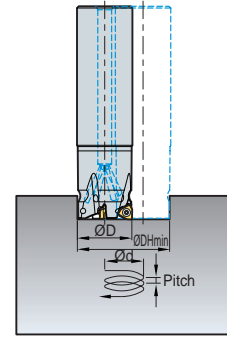
1. Ramping



2. Helical cutting for blind hole



3. Helical cutting for through hole



(mm)

Type	Tool Dia. ØD	ap	1. Ramping		2. Helical cutting for blind hole				3. Helical cutting for through hole	
			Max. rake angle α°	Lmin	Min. machining Dia. ØDHmin	Max. pitch	Max. machining Dia. ØDHmax	Max. pitch	Min. machining Dia. ØDHmin	Max. pitch
3000 type	20	5.5	15.5	19.8	36.5	5.5	38.5	5.5	33.0	5.5
	21	5.5	14.0	22.1	38.5	5.5	40.5	5.5	35.0	5.5
	25	5.5	10.0	31.2	46.5	5.5	48.5	5.5	43.0	5.5
	26	5.5	9.5	32.9	48.34	5.5	51.0	5.5	45.0	5.5
	32	5.5	6.5	48.3	60.5	5.5	62.5	5.5	59.0	5.5
	33	5.5	6.0	52.3	62.5	5.5	64.5	5.5	59.0	5.5
	40	5.5	4.5	69.9	46.5	5.5	78.5	5.5	73.0	5.5
	50	5.5	3.5	89.9	96.5	5.5	98.5	5.5	93.0	5.5
	63	5.5	2.5	126.0	122.5	5.5	124.5	5.5	119.0	5.5
	80	8	2.0	157.5	156.5	5.5	158.5	5.5	153.0	5.5
	100	8	1.5	210.0	194.5	5.5	198.5	5.5	193.0	5.5
125	8	1.0	315.1	246.5	5.5	248.5	5.5	243.0	5.5	
4000 type	25	8	24.0	18.0	44.5	8.0	48.0	8.0	38.5	8.0
	32	8	13.0	34.7	58.5	8.0	62.0	8.0	52.5	8.0
	33	8	12.0	37.6	60.02	8.0	64.4	8.0	54.5	8.0
	40	8	8.5	53.5	74.5	8.0	78.0	8.0	68.5	8.0
	50	8	6.0	76.1	94.5	8.0	98.0	8.0	88.5	8.0
	63	8	4.0	114.4	120.5	8.0	124.0	8.0	114.5	8.0
	80	8	3.0	152.6	154.5	8.0	158.0	8.0	148.5	8.0
	100	8	2.0	229.1	194.5	8.0	198.0	8.0	188.5	8.0
	125	8	1.5	305.5	244.5	7.7	248.0	7.8	238.5	7.7
5000 type	80	12	5.5	124.6	153.5	12.0	158.0	12.0	146.5	12.0
	100	12	4.5	152.5	193.5	12.0	198.0	12.0	159.5	12.0
	125	12	3.5	196.2	242.5	12.0	248.0	12.0	236.5	12.0

\* Please be sure to use cutting oil or air for ramping and helical machining  
 $Lmin = ap / \tan(\alpha^\circ)$

## Rich Mill RM3

### Application guideline for grade

Workpiece		P	M	K	N	
		Carbon steel	Alloy steel	Stainless steel	Cast iron	Aluminum
Chip breaker	First choice	MM	MM	ML	ML	MA
	Second choice	ML	ML	-	MM	-
Grades	High speed machining	PC3700	PC3700	PC5300	PC6510	H01
	General machining	PC5400	PC5300	PC5400	PC5300	
	Interrupted machining	PC5400	PC5400	PC5400	PC5400	

### Recommended cutting condition

#### • RM3 3000 type

Workpiece	Grades	Cutting conditions				Cutting conditions				
		vc (m/min)	fz (mm/t)	max ap (mm)	Available inserts	vc (m/min)	fz (mm/t)	max ap (mm)	Available inserts	
P	steel	PC3700	160~270	0.25~0.05	5.5	XNKT0604□□ PNSR-MM	160~270	0.2~0.05	5.5	XNKT0604□□ PNER-ML
		PC5300	150~240	0.25~0.05			150~240	0.25~0.05		
		PC5400	130~210	0.25~0.05			130~210	0.25~0.05		
M	Stainless steel	PC5300	90~150	0.2~0.05			90~150	0.1~0.05		
		PC5400	70~120	0.2~0.05			70~120	0.1~0.05		
K	Cast iron	PC6510	140~230	0.3~0.08			140~230	0.25~0.08		
		PC5300	120~200	0.3~0.08	120~200	0.25~0.08				

\* Maximum cutting condition: vc = 350 m/min, fz = 0.5 mm/t according to cutting environment

#### • RM3 4000 type

Workpiece	Grades	Cutting conditions				Cutting conditions				
		vc (m/min)	fz (mm/t)	max ap (mm)	Available inserts	vc (m/min)	fz (mm/t)	max ap (mm)	Available inserts	
P	steel	PC3700	160~270	0.3~0.05	8.0	XNKT0805□□ PNSR-MM	160~270	0.25~0.05	8.0	XNKT0805□□ PNER-ML
		PC5300	150~240	0.3~0.05			150~240	0.25~0.05		
		PC5400	130~210	0.3~0.05			130~210	0.25~0.05		
M	Stainless steel	PC5300	90~150	0.25~0.05			90~150	0.2~0.05		
		PC5400	70~120	0.25~0.05			70~120	0.2~0.05		
K	Cast iron	PC6510	140~230	0.35~0.08			140~230	0.3~0.08		
		PC5300	120~200	0.35~0.08	120~200	0.3~0.08				
N	Aluminum	H01	400~1200	0.4~0.1		XNCT0805□□PNFR-MA	-	-	-	-

\* Maximum cutting condition: vc = 350 m/min, fz = 0.5 mm/t according to cutting environment

#### • RM3 5000 type

Workpiece	Grades	Cutting conditions				Cutting conditions				
		vc (m/min)	fz (mm/t)	max ap (mm)	Available inserts	vc (m/min)	fz (mm/t)	max ap (mm)	Available inserts	
P	steel	PC3700	160~270	0.3~0.05	12.0	XNKT1206□□ PNSR-MM	160~270	0.25~0.05	12.0	XNKT1206□□ PNER-ML
		PC5300	150~240	0.3~0.05			150~240	0.25~0.05		
		PC5400	130~210	0.3~0.05			130~210	0.25~0.05		
M	Stainless steel	PC5300	90~150	0.25~0.05			90~150	0.2~0.05		
		PC5400	70~120	0.25~0.05			70~120	0.2~0.05		
K	Cast iron	PC6510	140~230	0.35~0.08			140~230	0.3~0.08		
		PC5300	120~200	0.35~0.08	120~200	0.3~0.08				
N	Aluminum	H01	400~1200	0.4~0.1		XNCT1206□□PNFR-MA	-	-	-	-

\* Maximum cutting condition: vc = 350 m/min, fz = 0.5 mm/t according to cutting environment





## Rich Mill RM4

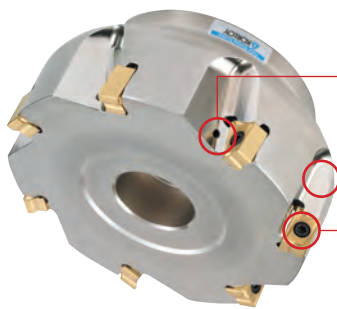
### Features

- Economical 4 cutting-edges by using double-sided insert
- RM4, as a multi-functional milling tool, offers economical 4 cutting-edges by using an innovative double-sided insert
- Special designed chip breaker consists of high rake angle and strong cutting-edge to decrease the cutting load
- RM4 is multi-functional tool that can cover facing, side cutting, shouldering, slotting, ramping & helical cutting
- Optimal matching of the special cutting-edge geometry with variety of new grades provides consistence & long tool life of insert



### Features of cutter

- 4 cutting - edges can be used by using double-sided insert
- High rake angle chip breaker and cutting-edge can make smooth cutting with low cutting load
- Strong negative insert
- High efficiency, economical, multi-functional tool



#### Through coolant system

- Longer tool life due to direct cooling injection into the cutting-edge of insert

#### Wide chip pocket for better chip evacuation

Improving chip control

#### Simple screw on system

### Features of insert

- Double-sided insert using 4 cutting-edges
- High rake angle chip breaker, cutting-edge
- Flexibility of product
- High efficiency, economical, multi-functional tool
- Negative insert has strong cutting-edge

- Chip breaker**
- High rake angle chip breaker
  - Improving chip control

#### Step design

- Improving chip control
- Reducing cutting load

#### Minor cutting-edge

- Special design of cutting-edge to improve surface roughness

- Major cutting-edge**
- High rake angle chip breaker
  - Better surface roughness

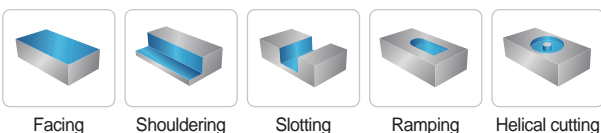
#### Concave design

- 4 cutting-edges
- Minimize interference

#### Clearance face

- Strong negative face
- Strong cutting-edge

### Uses



Facing

Shouldering







Slotting

Ramping


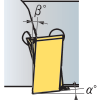
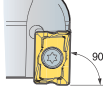
Helical cutting

## Rich Mill RM4

### Features of chip breakers

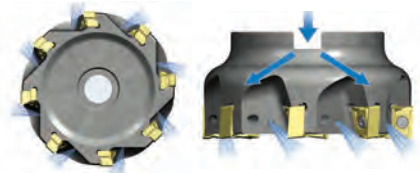
Insert	Cutting-edge	Uses	Features
MA 		Aluminum, Light machining	With sharp edge application the better productivity has been accomplished, especially for Aluminum or low force cut
MF 		Light cutting	Due to low cutting load, it is good for light cutting and difficult-to-cut material
MM 		General cutting	It is suitable design for general milling

### Setting configuration

Shape	Setting angle of insert	Features
	 $\beta^\circ$ $\alpha^\circ$	High rake chip breaker & positive setting angle for low cutting load → Improving machinability
	 $90^\circ$	Multi applications for facing, shouldering, slotting, ramping, helical cutting, etc

### Through coolant system

- By using on exclusive coolant bolt (hexagonal socket bolt) powerful cooling & better chip evacuation can be acquired
- To get optimal chip control, the direction of coolant injection has been designed to reach to each cutting-edge directly (through coolant arbor is required)

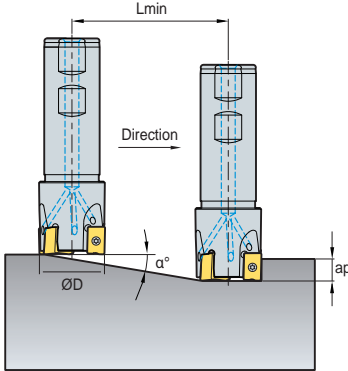


Through coolant system for decreasing cutting heat and good chip evacuation

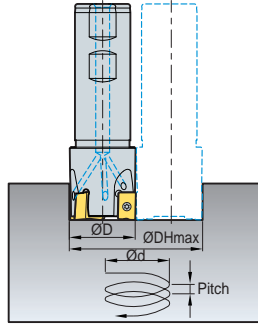
# Rich Mill RM4

## Ramping and helical cutting

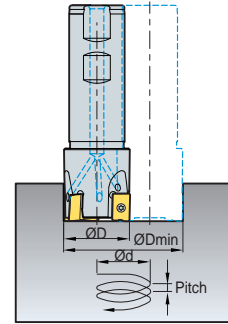
1. Ramping



2. Helical cutting for blind hole



3. Helical cutting for through hole



(mm)

Designation	Tool Dia. ØD	ap	1. Ramping		2. Helical cutting for blind hole			3. Helical cutting for through hole		
			Max. rake angle α°	Lmin	Min. machining Dia. ØDHmin	Max. pitch	Max. machining Dia. ØDHmax	Max. pitch	Min. machining Dia. ØDHmin	Max. pitch
RM4PS3014HR	14	9	4.5	125	25	2.7	27	3.1	19	1.3
RM4PS3016HR	16	9	3.5	160	29	2.5	31	2.7	23	1.4
RM4PS3018HR	18	9	3.0	185	33	2.4	35	2.7	27	1.5
RM4PS3020HR	20	9	2.7	204	37	2.5	39	2.7	31	1.6
RM4PS3025HR	25	9	1.8	301	47	2.1	49	2.3	41	1.6
RM4PS3032HR	32	9	1.2	451	61	1.9	63	2.0	55	1.5
RM4PS3040HR	40	9	0.9	616	77	1.8	79	1.8	71	1.5
RM4PS3050HR	50	9	0.6	843	97	1.5	99	1.5	91	1.3
RM4PC(M)3040HR	40	9	0.9	616	77	1.8	79	1.8	71	1.5
RM4PC(M)3050HR	50	9	0.6	843	97	1.5	99	1.5	91	1.3
RM4PC(M)3063HR	63	9	0.5	1123	123	1.6	125	1.6	117	1.4
RM4PC(M)3080HR	80	9	0.3	1508	157	1.2	159	1.2	151	1.1
RM4PC(M)3100HR	100	9	0.2	1910	197	1.0	199	1.0	191	0.9
RM4PS4032HR	32	14	2.5	229	59.5	3.0	62	4	49	2.0
RM4PS4040HR	40	14	2.0	286	75.5	3.0	78	4	65	2.0
RM4PS4050HR	50	14	2.0	286	95.5	4.0	98	5	85	3.5
RM4PS4063HR	63	14	2.0	286	121.5	5.0	124	5	111	5.0
RM4PC(M)4050HR	50	14	2.0	286	95.5	4.0	98	5	85	3.5
RM4PC(M)4063HR	63	14	2.0	286	121.5	5.0	124	5	111	5.0
RM4PC(M)4080HR	80	14	1.5	382	155.5	5.0	158	5	145	5.0
RM4PC(M)4100HR	100	14	1.0	573	195.5	4.5	198	5	185	4.0
RM4PC(M)4125HR	125	14	1.0	573	245.5	5.0	248	5	235	5.0
RM4PC(M)4160R	160	14	0.5	1146	315.5	3.5	318	4	305	3.5

\* Please be sure to use cutting oil or air for ramping and helical machining  
 $Lmin = ap / \tan(\alpha^\circ)$

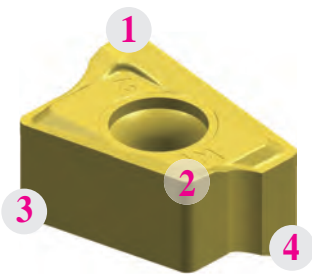
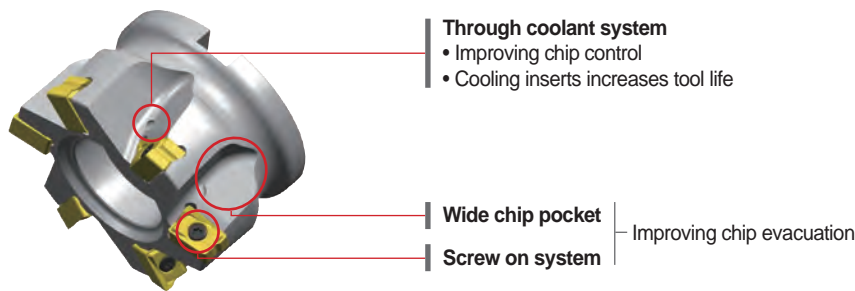
## Recommended cutting condition

ISO	Grades	LNM(E)X100605PNR-MF		LNM(E)X100605PNR-MM		LNEX100605PNR-MA		Max-ap (mm)	LNM(E)X151008PNR-MF		LNM(E)X151008PNR-MM		LNEX151008PNR-MA		Max-ap (mm)
		vc (m/min)	fz (mm/t)	vc (m/min)	fz (mm/t)	vc (m/min)	fz (mm/t)		vc (m/min)	fz (mm/t)	vc (m/min)	fz (mm/t)	vc (m/min)	fz (mm/t)	
P	NCM535	-	-	-	-	-	-	9.0	150-300	0.05-0.30	120-300	0.05-0.35	150-300	0.03-0.20	14.0
	PC3700	150-300	0.05-0.25	120-300	0.05-0.30	150-300	0.03-0.20		150-300	0.05-0.30	120-300	0.05-0.35	150-300	0.03-0.20	
M	PC5300	120-180	0.05-0.25	100-180	0.05-0.30	120-200	0.03-0.20		120-180	0.05-0.30	100-180	0.05-0.3	120-200	0.03-0.20	
K	PC6510	150-300	0.08-0.30	120-300	0.08-0.35	-	-		150-300	0.08-0.35	120-300	0.08-0.35	-	-	

## Rich Mill RM4Z

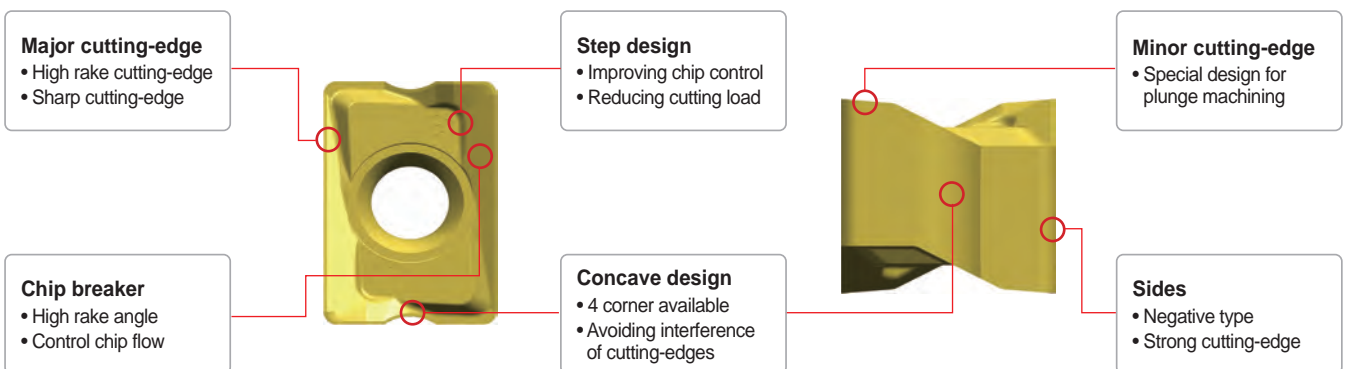
### Features

- Rich mill series RM4Z is a plunge mill for high efficiency vertical machining such as slotting and pocketing in roughing applications
- Rich mill series RM4Z is a highly efficient milling tool for plunging, shouldering and facing. It makes operations more economical with the use of its double-sided 4-corner insert
- Plunge machining reduces lead time for high productivity and precision machining.
- In plunging the max depth of RM4Z 3000 type is 9.0 mm and that of RM4Z 4000 type is 14.0 mm

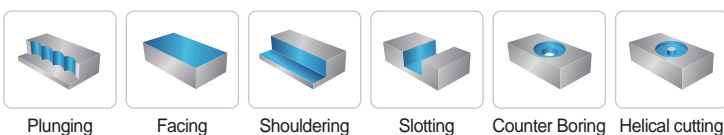


- Double-sided insert ... 4 corner available
- High rake angle chip breaker and cutting-edge
- Various available machining types
- High efficiency and economical insert
- Negative type insert - Strong cutting-edge

### Features of insert



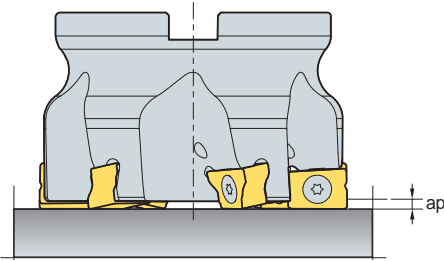
### Uses



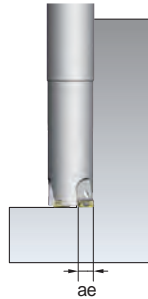
## Rich Mill RM4Z

### ➤ The depth of cut by machining type

• In horizontal machining, Depth of cut =  $a_p$  (mm)

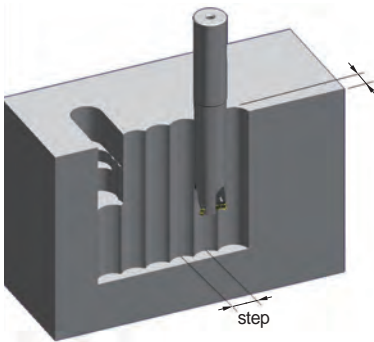


• In plunging, Depth of cut =  $a_e$  (mm)



RM4Z	Horizontality	Verticality	
	max $a_p$ (mm)	max $a_e$ (mm)	step
RM4Z3000	1.5	9	< 0.7D
RM4Z4000	2.5	14	< 0.7D

### ➤ Max step in plunging

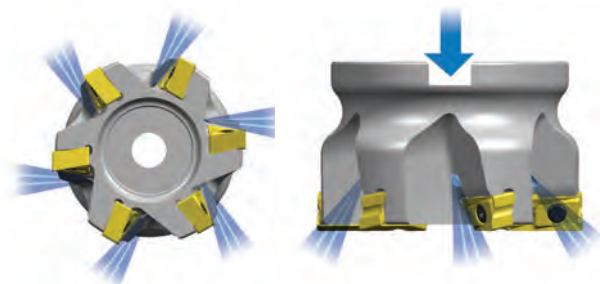


ae	Cutter Diameter (mm)								
	25	32	40	50	52	63	66	80	100
	Max step (mm)								
1	9.7	11.1	12.4	14	14.2	15.7	16.1	17.7	19.9
2	13.5	15.4	17.4	19.5	20	22	22.6	24.9	28
3	16.2	18.6	21	23.7	24.2	26.8	27.4	30.3	34.1
4	18.3	21.1	24	27.1	27.7	30.7	31.4	34.8	39.1
5	20	23.2	26.4	30	30.6	34	34.9	38.7	43.5
6	21.3	24.9	28.5	32.4	33.2	36.9	37.9	42.1	47.4
7	22.4	26.4	30.3	34.6	35.4	39.5	40.6	45.2	51
8	23.3	27.7	32	36.6	37.5	41.9	43	48	54.2
9	24	28.7	33.4	38.4	39.3	44	45.2	50.5	57.2
10	-	-	-	-	-	46	47.3	52.9	60
11	-	-	-	-	-	47.8	49.1	55.1	62.5
12	-	-	-	-	-	49.4	50.9	57.1	64.9
13	-	-	-	-	-	50.9	52.4	59	67.2
14	-	-	-	-	-	52.3	53.9	60.7	69.3

### ➤ Through coolant system

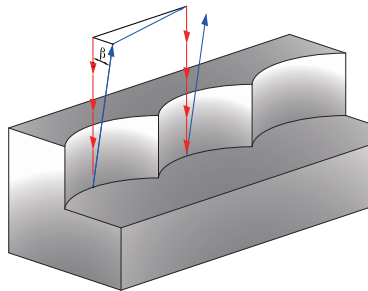
- Exclusive hexagonal coolant socket bolt provides excellent cooling and chip evacuation
- Direct coolant injection to cutting-edge improves cooling effectiveness
- Coolant type arbor should be used

\*Coolant bolt is not included, it is for sale



## Rich Mill RM4Z

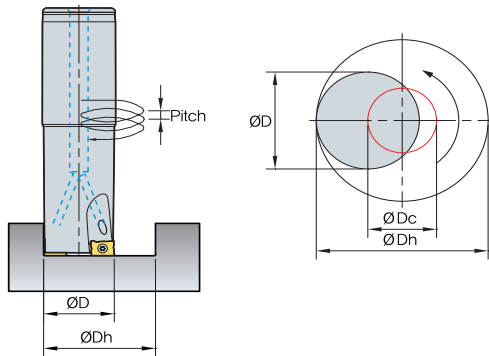
### Programming tip



- - - Plunging feed direction
- Tool escape
- $\beta$  Escape angle ( $\beta \geq 1^\circ$ )

- When your tool steps back after plunging, please get over  $1^\circ$  more escape angle

### Helical machining



$$\text{ØDc} = \text{ØDh} - \text{ØD}$$

- ØDc = Tool center path
- ØDh = Desired hole diameter
- ØD = Tool Dia.

(mm)

Designation	Diameter ØD (mm)	Helical data				
		Min. machining Dia. ØDHmin	Max. pitch	Max. machining Dia. ØDHmax	Max. pitch	
RM4ZS	3025HR-L25	25	30	0.4	48	1.8
	3032HR-L32	32	43	0.3	62	0.9
	3040HR-L32	40	59	0.3	78	0.6
RM4ZCM	3040HR	40	59	0.3	78	0.6
	3050HR	50	79	0.3	98	0.5
	3052HR	52	83	0.3	102	0.5
RM4ZM	3025HR-M12	25	30	0.4	48	1.8
	3032HR-M16	32	43	0.3	62	0.9
	3040HR-M16	40	59	0.3	78	0.6
RM4ZCM	4063HR	63	95	0.5	124	1.0
	4066HR	66	101	0.5	130	1.0
	4080HR	80	129	0.5	158	0.8
	4100HR	100	169	0.3	198	0.5

### Recommended cutting condition

ISO	Grades	LNM(E)X100605PNL-MM				LNM(E)X151008PNL-MM			
		vc (m/min)	fz (mm/t)	* max ae (mm)	** max ap (mm)	vc (m/min)	fz (mm/t)	* max ae (mm)	** max ap (mm)
P	PC3700	100~250	0.05~0.25	9	1.5	120~250	0.05~0.25	14	2.5
M	PC5300	100~250	0.08~0.30			120~250	0.08~0.30		
K	PC6510	80~180	0.05~0.20			100~180	0.05~0.20		

\* max ae (mm): (Plunging) max. radial depth of cut

\*\* max ap (mm): (Shouldering/Facing) max depth of cut

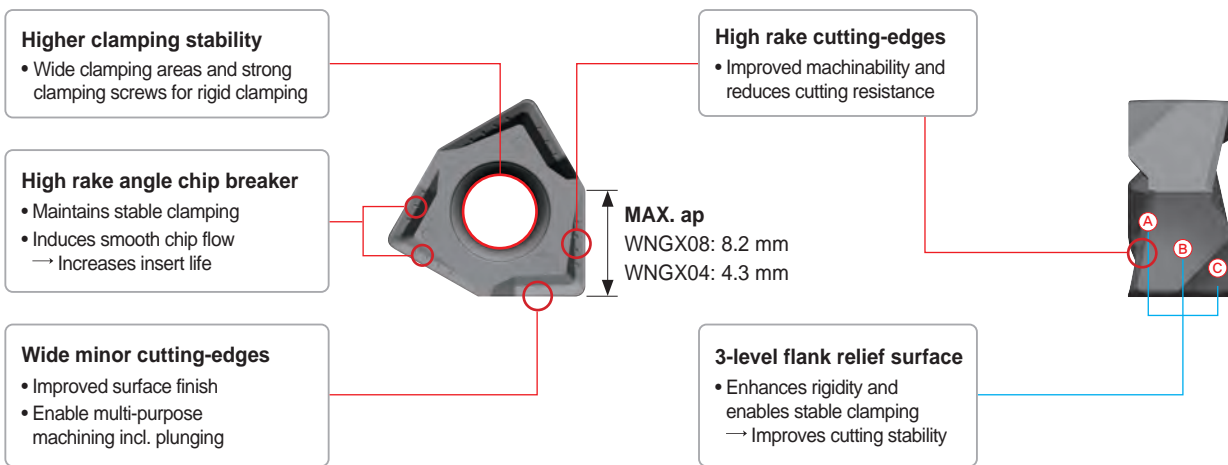


## Rich Mill RM6

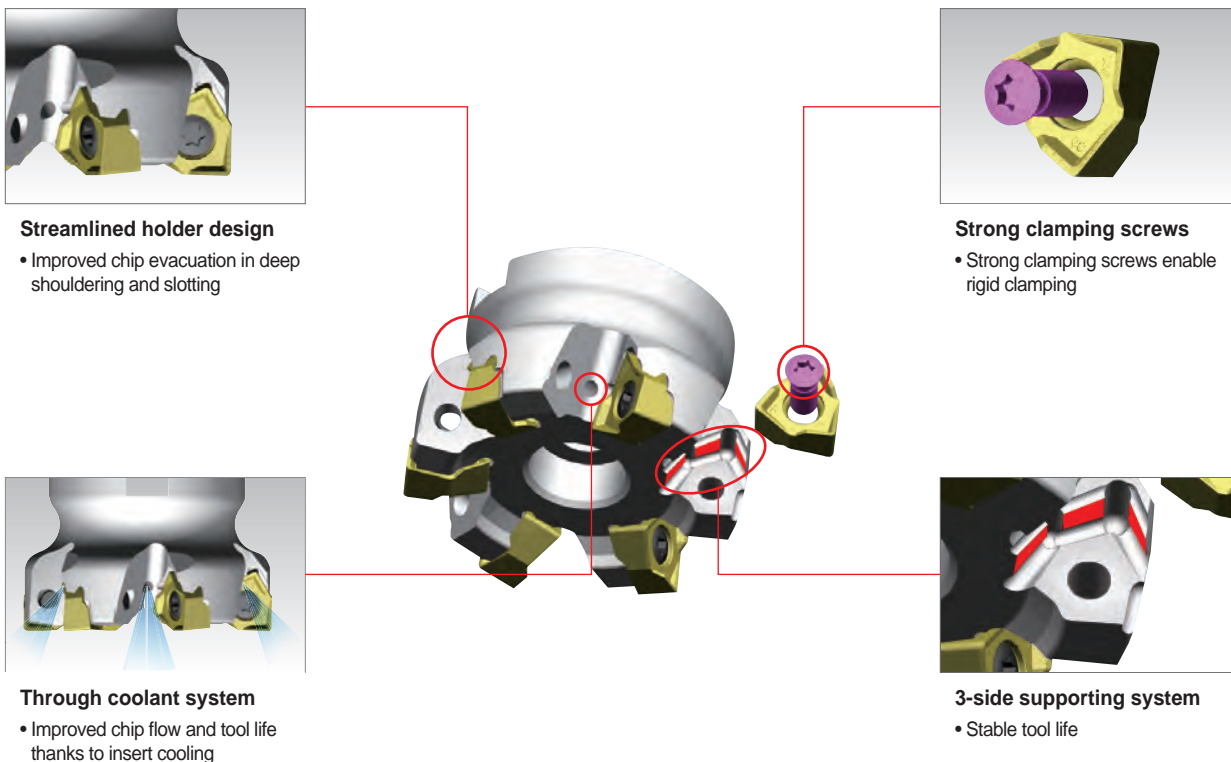
### Features

- Stable clamping - 3 clamping surfaces on the side and strong clamping screws  
→ Improves cutting stability
- High quality results - High precision, excellent perpendicularity, outstanding surface finish on the flank, accurate tolerance
- High productivity - High rake angle and sharp cutting-edges for lower cutting resistance  
→ Ideal for high speed and high feed machining

### Features of insert






### Features of cutter





## Rich Mill RM6

### Features of chip breakers

Insert	Cutting-edge	Uses	Features
MA		For aluminum	Sharp cutting-edges for excellent cutting performance in aluminum machining Buffed surface for excellent chip flow and welding resistance
ML		For light cutting	Chip breaker design of low cutting resistance, ideal for light cutting and machining hard-to-cut materials Excellent tool life and quality results
MM		For general cutting	Chip breaker design ideal for general shoulder milling and most applications

### Application guideline for grade

Workpiece		P	M	K	N	
		Carbon steel	Alloy steel	Stainless steel	Cast iron	Non-ferrous metal
Shape	1st recommended	MM	MM	ML	ML	MA
	2nd recommended	ML	ML	-	MM	MA
Grades	High speed milling	PC3700	PC3700	PC5300	PC6510	H01
	General milling	PC5400	PC5300	PC5400	PC5300	H01
	Interrupted milling	PC5400	PC5400	PC5400	PC5400	H01

### Recommended cutting condition

#### • WNGX04

Workpiece	Grades	WNGX040304PNSR-MM			WNGX040304PNER-ML			WNGX040304PNFR-MA		
		vc (m/min)	fz (mm/t)	max. ap(mm)	vc (m/min)	fz (mm/t)	max. ap(mm)	vc (m/min)	fz (mm/t)	max. ap(mm)
P Steel	PC3700	160~270	0.25~0.05	4.3	160~270	0.20~0.05	4.3	-	-	4.3
	PC5300	150~240	0.25~0.05		150~240	0.25~0.05		-	-	
	PC5400	130~210	0.25~0.05		130~210	0.25~0.05		-	-	
M Stainless steel	PC5300	90~150	0.20~0.05		90~150	0.10~0.05		-	-	
	PC5400	70~120	0.20~0.05		70~120	0.10~0.05		-	-	
K Cast iron	PC6510	140~230	0.30~0.08		140~230	0.25~0.08		-	-	
	PC5300	120~200	0.30~0.08	120~200	0.25~0.08	-	-			
N Non-ferrous metal	H01	-	-	-	-	-	500~1000	0.2~0.05	4.3	

※ The above data refer to general cutting conditions and can be adjustable up to 300 m/min and 0.4 mm/t depending on user environment.

#### • WNGX08

Workpiece	Grades	WNGX080608PNSR-MM			WNGX080608PNER-ML			WNGX080608PNFR-MA		
		vc (m/min)	fz (mm/t)	max. ap(mm)	vc (m/min)	fz (mm/t)	max. ap(mm)	vc (m/min)	fz (mm/t)	max. ap(mm)
P Steel	PC3700	160~270	0.25~0.05	8.2	160~270	0.20~0.05	8.2	-	-	8.2
	PC5300	150~240	0.25~0.05		150~240	0.25~0.05		-	-	
	PC5400	130~210	0.25~0.05		130~210	0.25~0.05		-	-	
M Stainless steel	PC5300	90~150	0.20~0.05		90~150	0.10~0.05		-	-	
	PC5400	70~120	0.20~0.05		70~120	0.10~0.05		-	-	
K Cast iron	PC6510	140~230	0.30~0.08		140~230	0.25~0.08		-	-	
	PC5300	120~200	0.30~0.08	120~200	0.25~0.08	-	-			
N Non-ferrous metal	H01	-	-	-	-	-	500~1000	0.2~0.05	8.2	

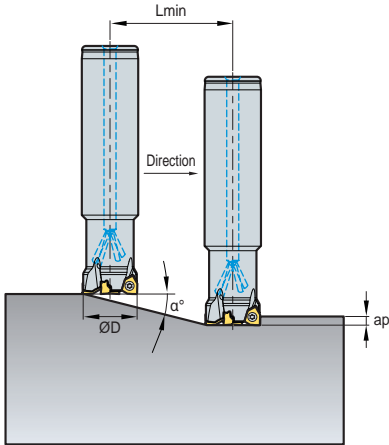
※ The above data refer to general cutting conditions and can be adjustable up to 300 m/min and 0.4 mm/t depending on user environment.



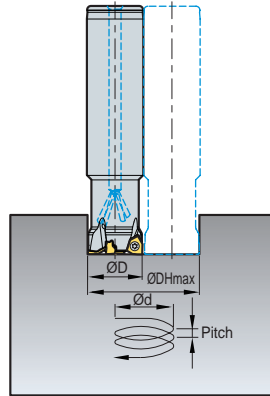
# Rich Mill RM6

## Ramping

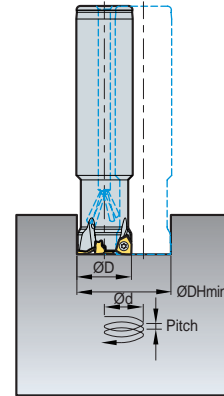
### 1. Ramping



### 2. Helical cutting for blind holes



### 3. Helical cutting for through holes



(mm)

Designation	Tool Dia. ØD	ap	1. Ramping		2. Helical cutting for blind holes				3. Helical cutting for through holes		
			Max. rake angle α°	Lmin	Min. machining Dia. ØDHmin	Max. pitch	Max. machining Dia. ØDHmax	Max. pitch	Min. machining Dia. ØDHmin	Max. pitch	
RM6PS	032R-2W32-120-WN08	32	8	0.8	572.9	54	0.96	62	1.3	38.5	0.5
	040R-3W32-120-WN08	40	8	0.5	916.7	70	0.82	78	1.0	54.5	0.4
	050R-4W32-120-WN08	50	8	0.3	1527.9	90	0.66	98	0.8	74.5	0.3
RM6PCM	063R-22-6-WN08	63	8	0.2	2291.3	116	0.58	124	0.6	100.5	0.3
	080R-27-7-WN08	80	8	0.1	4583.7	150	0.38	158	0.4	134.5	0.2
	100R-32-8-WN08	100	8	0.1	4583.7	190	0.49	198	0.5	174.5	0.3
	125R-40-11-WN08	125	8	0.1	4583.7	240	0.63	248	0.6	224.5	0.3

$L_{min} = ap / \tan(\alpha^\circ)$

Lmin: Cutting length at min. rake angle  
 ap: Axial depth of cut  
 α°: Available rake angle for ramping

## Rich Mill RM8

### Features

- Double-sided insert to use 8 cutting-edges
- Innovative double-sided insert makes it possible to use 8 cutting-edges  
It is more economical than conventional single sided insert
- The unique geometry and high rake angle of cutting-edge guarantees excellent surface finish  
Applicable for various workpieces like steel, stainless steel, cast iron, aluminum
- Combined with the innovative geometry and various grades provided the tool offers durability and excellent tool life
- Various pitches and chip breakers can be applicable for diverse machining
- Light Rich Mill cutter can be useful for high speed machining and low power machine



### Through coolant system

- Exclusive coolant bolt is adapted to get better chip evacuation and more powerful cooling. To get optimal chip evacuation, the direction of coolant injection has been designed to reach to each cutting-edge directly. Through coolant arbor is required



Through coolant system for decreasing cutting heat and good chip evacuation

### Features of chip breakers

Insert	Cutting-edge	Uses	Features
MA		For aluminum	Due to sharp cutting-edge and buffed surface, it has good chip flow and welding resistance
ML		For hard-to-cut material	Chip breaker with low cutting load is optimal for machining hard-to-cut materials
MF		For light cutting	Due to low cutting load, it is good for light cutting and difficult-to-cut material
MM		For general cutting	It is suitable design for general milling
W		For wiper	Specialized edge design can be suitable for excellent surface roughness operation

### Uses




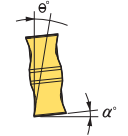
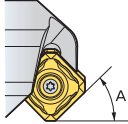
Facing

### Features of insert

Insert	Cutting-edge	Features
	<p>View-A</p>	High rake chip breaker & positive setting angle for low cutting load
	<p>View-B</p>	Designed wiper technology in minor cutting-edge for improved surface roughness
	<p>칩브레이커</p>	Low cutting load due to the positive setting and high rake angle chip breaker

## Rich Mill RM8

### Features of cutter

Shape	Setting angle of insert	Features
		High rake angle makes positive setting angle for low cutting load
		Suitable for facing and chamfering • RM8A A = 45° • RM8E A = 75° • RM8Q A = 88°

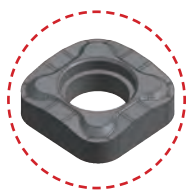
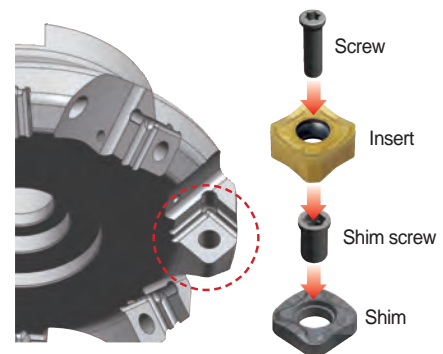
### Recommended cutting condition

ISO	Grades	SNM(E)X1206A(E)NN-MF		SNM(E)X1206A(E)NN-MM		SNEX1206A(E)NN-MA		Max-ap (mm)	SNM(E)X1507A(E)NN-MF		SNM(E)X1507A(E)NN-MM		Max-ap (mm)
		vc (m/min)	fz (mm/t)	vc (m/min)	fz (mm/t)	vc (m/min)	fz (mm/t)		vc (m/min)	fz (mm/t)	vc (m/min)	fz (mm/t)	
P	NC5330	-	-	150~300	0.10~0.35	150~300	0.10~0.35	RM8A 6.0	-	-	150~300	0.10~0.35	RM8A 7.5
	NCM535	200~300	0.05~0.30	150~300	0.10~0.35	150~300	0.10~0.35		200~300	0.05~0.30	150~300	0.10~0.35	
	PC3700	200~300	0.05~0.30	150~300	0.10~0.35	150~300	0.10~0.35		200~300	0.05~0.30	150~300	0.10~0.35	
M	PC9530	90~150	0.05~0.25	90~150	0.10~0.35	-	-	RM8E 9.0	90~150	0.10~0.30	90~150	0.10~0.35	RM8E 11
	PC5300	90~150	0.05~0.25	90~150	0.10~0.35	-	-		90~150	0.10~0.30	90~150	0.10~0.35	
K	PC6510	150~300	0.08~0.35	150~300	0.10~0.40	150~300	0.10~0.40	RM8Q 11.5	150~300	0.08~0.35	150~300	0.10~0.40	
	PC5300	150~300	0.08~0.35	150~300	0.10~0.40	150~300	0.10~0.40		150~300	0.08~0.35	150~300	0.10~0.40	

## Rich Mill RMH8

### Features

- Screw on clamping system - Adaptable and Stable clamping system
- Reinforced rigidity and enhanced clamping power
  - Appling shim system, prevent cutter damage when insert breaks
- Adapting/exchangeable shim
  - Using various kinds of cutter (Approach angle 45°, 75°, 88°)
  - Stable clamping power with insert



RMH8A  
(AA 45°)



RMH8E  
(AA 75°)



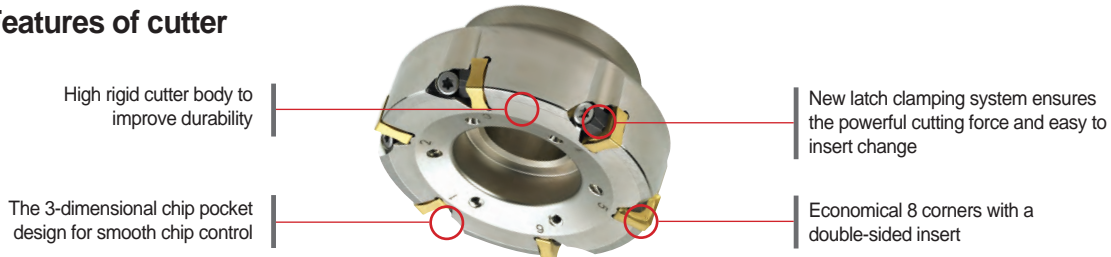
RMH8Q  
(AA 88°)

## Rich Mill RMT8

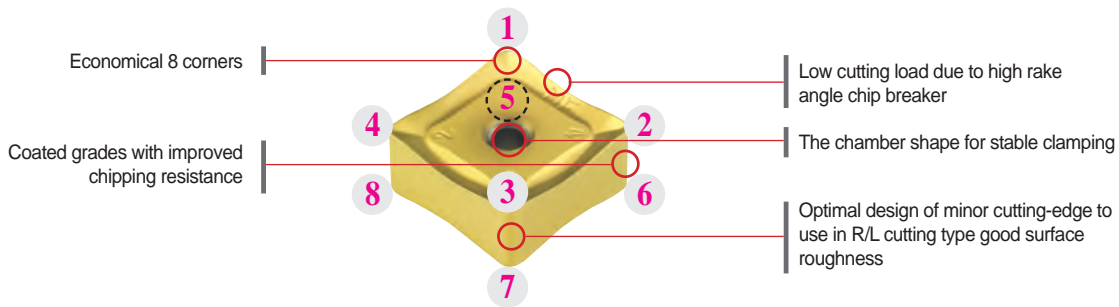
### Features

- New latch clamping system provides a powerful cutting force and an easy insert change
- New grades with chipping resistance provides good surface roughness and better tool life
- Due to the specially designed chip breaker, all operations are possible
- RMT with various pitches can replace conventional ISO milling tool

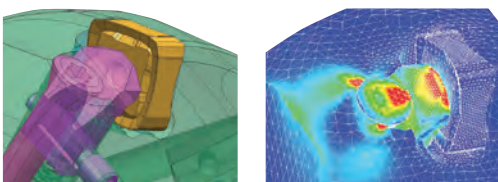
### Features of cutter



### Features of insert (Using R/L)



### Clamping force analysis



### Features of chip breakers

	Insert	Cutting-edge	Uses	Features
MF			For fine finishing	Our specialized insert design creates low cutting forces suitable for light cutting, HRSA
MM			For strengthen	Suitable geometry design for general milling has wider ranges of machining

### Recommended grades and chip breakers

ISO	Grades	MM	MF
P	NCM535	⊙	○
	PC5300	⊙	○
M	PC9530	○	⊙
K	PC6510	○	⊙

⊙: Optimum ○: Proper

### Recommended cutting condition

ISO	Grades	MM		MF	
		vc (m/min)	fz (mm/t)	vc (m/min)	fz (mm/t)
P	NC5330	190~310	0.10~0.35	190~310	0.05~0.30
	NCM535	160~270	0.10~0.35	160~270	0.05~0.30
	PC3700	130~210	0.10~0.35	130~210	0.05~0.30
M	PC9530	90~150	0.05~0.30	90~150	0.05~0.30
K	PC6510	140~230	0.10~0.40	140~230	0.08~0.35

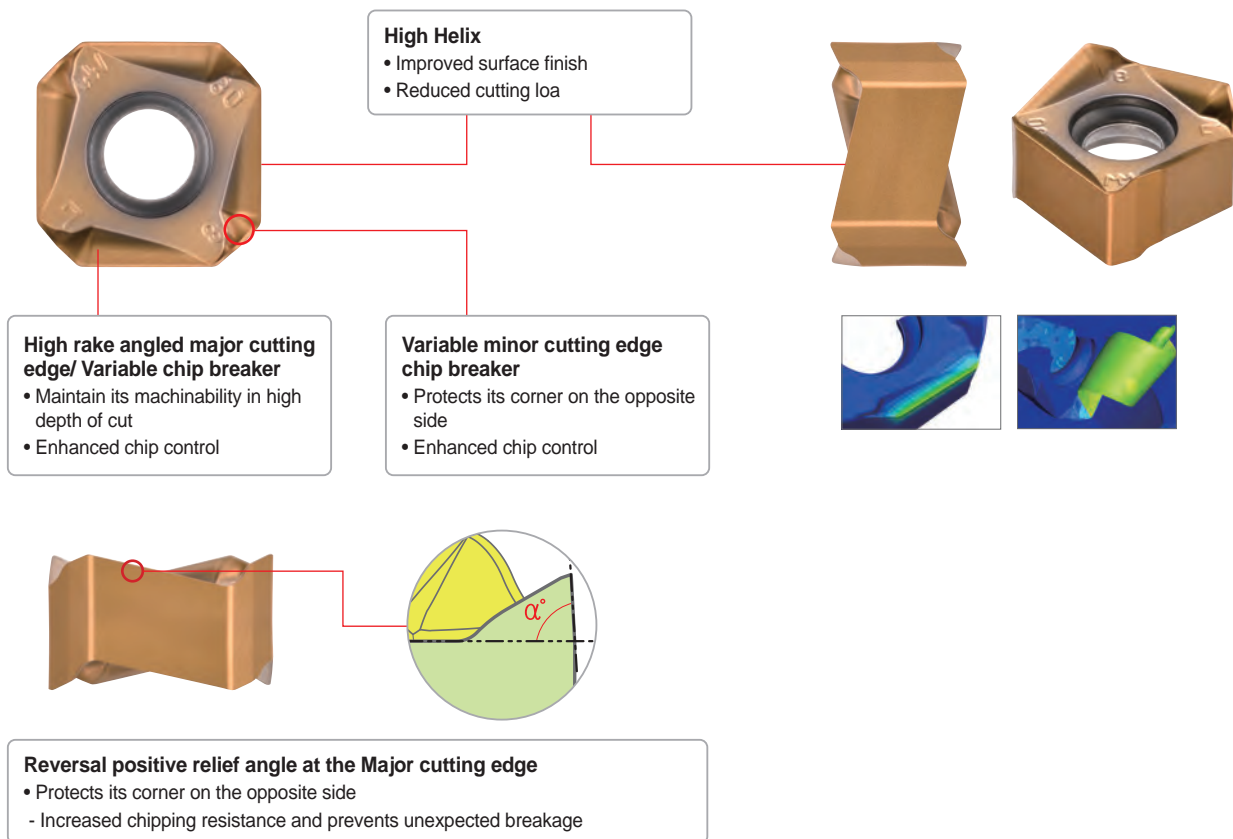


## Rich Mill RM8-X

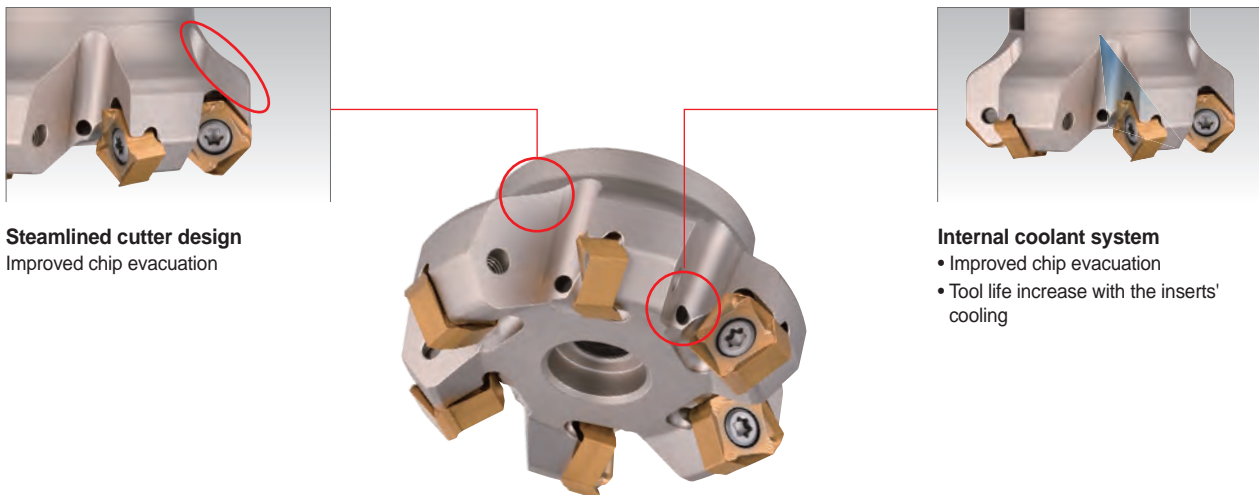
### Features

- High helix face milling tool with 8-cornered double-side inserts
- High performance in stainless steel machining due to sharp cutting edge and double reverse positive relief surface structure
- Economic tool by double-sided 8 corners and high helix right-handed shape realizing high depth of cut machining

### Insert features



### Cutter features



## Rich Mill RM8-X

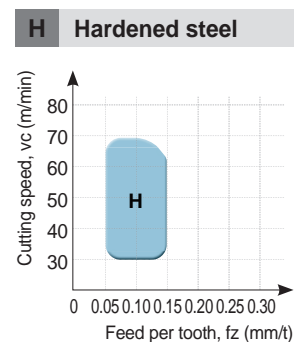
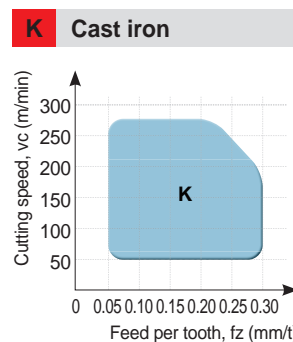
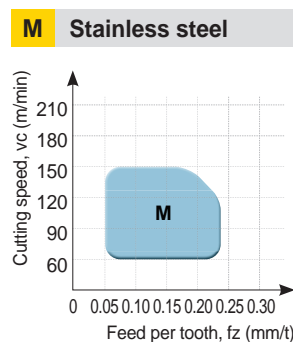
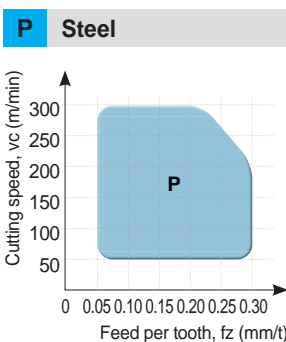
### Recommended grade and cutting edge

Type	SAGX			SNMX	
Features	Strong relief surface			Relief surface for surface finish	
Workpiece	M	S	H	P	K
Geometry	<p>SAGX-ML                      SAGX-MM</p> <p>[Double reverse positive relief surface]</p>			<p>SNMX-MM</p> <p>[Negative relief surface]</p>	

Type	Recommended insert and grade for different workpieces (●: 1 <sup>st</sup> recommendation)									
	P		M		K		S		H	
	C/B	Grades	C/B	Grades	C/B	Grades	C/B	Grades	C/B	Grades
SAGX140808ANER	○ ML ○ MM	○ PC5300 ○ PC3700	● ML ○ MM	● PC9540 ○ PC5300	○ ML ○ MM	○ PC6510 ○ PC5300	● ML ○ MM	● PC5300	● MM	● PC2510 ○ PC2505
SNMX140808ANER	● MM	● PC3700	-	-	● MM	● PC6510	-	-	-	-

### Recommended cutting condition

Grades	Machining types	Recommended grade	Recommended cutting speed (m/min)	ISO	Application range	
P	Steel	Continuous cutting	PC3700 <sup>new</sup>	235 (180~290)	P30	
		Interrupted cutting	PC5300	195 (150~240)	P40	
M	Stainless steel	Continuous cutting	PC5300	130 (100~160)	M20	
		Interrupted cutting	PC9540	110 (80~140)	M40	
K	Cast iron	Continuous cutting	PC6510	180 (140~230)	K05	
		Interrupted cutting	PC5300	145 (110~180)	K10	
					K20	
			K30			
H	Hardened steel	Continuous cutting	PC2510 <sup>new</sup>	55 (40~70)	H10	





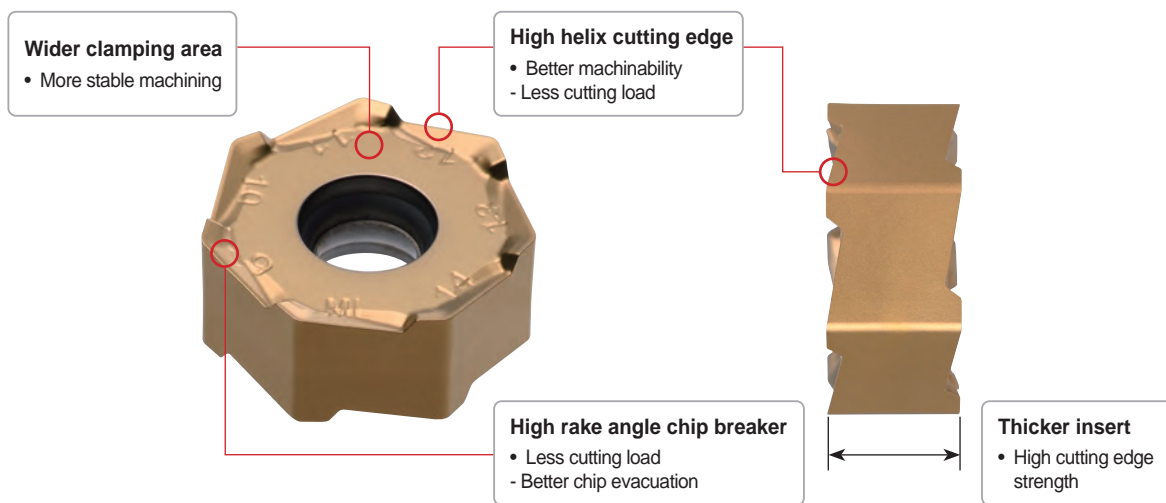
## Rich Mill RM14

### Features

- Economical face mill with 14 double-sided corners
- Minimized chattering of workpiece due to minimum lead angle and sharp cutting edge
- Reduced cutting resistance and improved chip emissions by high helix angle application

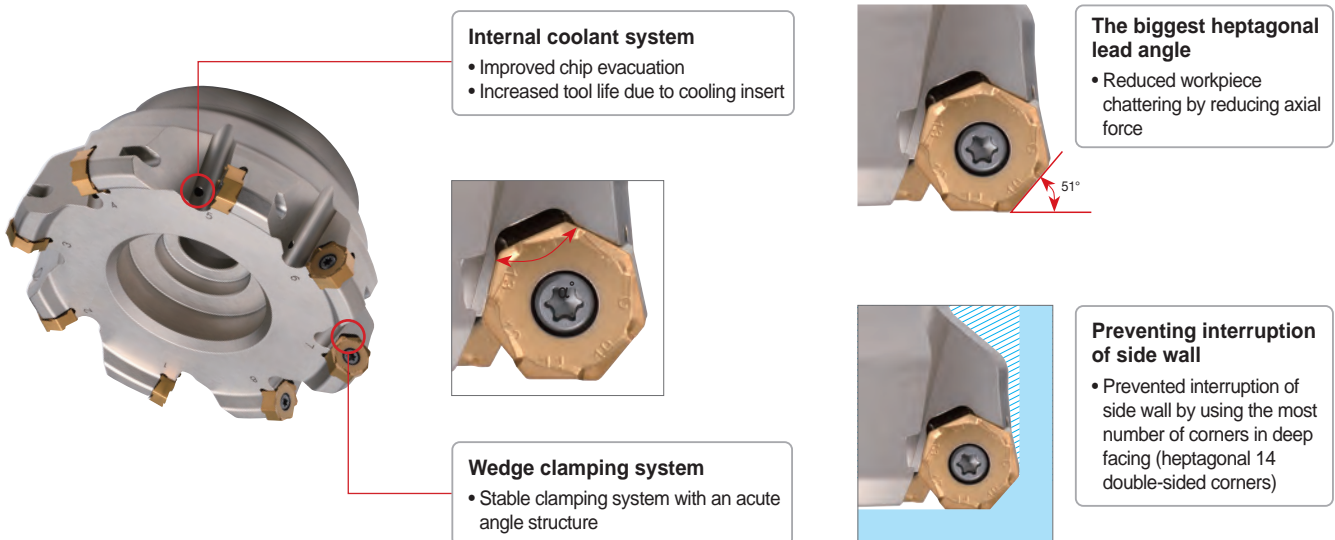
### Insert features

- Wide supporting area of insert ensures stable clamping system.
- High rake angle cutting edge reduces cutting load and increases chip evacuation.
- Thicker insert realizes stability in machining.







### Cutter features

- The biggest heptagonal lead angle reduces chatter in machining.
- Wedge type clamping system ensures stable clamping.
- Stepped machining is available without interruption of side wall of insert.





## Rich Mill RM14

### Features of chip breakers

Insert	Cutting-edge	Uses	Features
		Neutral type Flat cutting edge	1 <sup>st</sup> recommended for heat resistant stainless steel machining Generally applied in various machining Applicable for both right handed and left handed
		Right handed type High helix cutting edge	1 <sup>st</sup> recommended for cast iron machining Applicable for stainless steel machining with less than 3 mm depth of cut For high speed and high feed machining

### Recommended grade and cutting edge

(● : 1<sup>st</sup> recommendation)

Type		Recommended grade and cutting edge by workpiece							
		M				K			
		Austenitic stainless steel		Heat resistance stainless steel		Gray cast iron		Ductile cast iron	
		Type	Grade	Type	Grade	Type	Grade	Type	Grade
Flat		-	● PC9540 ○ PC5300 ○ PC5400	●	● PC9540 ○ PC5300 ○ PC5400	-	○ PC6510 ○ PC5300 ● NCM535	-	● PC6510 ○ PC5300 ○ NCM535
Helix		●	● PC9540 ○ PC5300 ○ PC5400	-	● PC9540 ○ PC5300 ○ PC5400	●	○ PC6510 ○ PC5300 ● NCM535	●	● PC6510 ○ PC5300 ○ NCM535

### Recommended cutting condition

ISO	Workpiece	ISO (DIN)*	AISI	KS	HB	Grades	Cutting conditions					
							Helix			Flat		
							vc (m/min)	fz (mm/t)	ap (mm)	vc (m/min)	fz (mm/t)	ap (mm)
M	Austenite	STS304 STS316	X5CrNi18-9 X5CrNiMo17-12-2	304 316	160-180	PC9540 (PC5300)	80-160	0.3-0.05	1-3	90-150	0.25-0.05	1-3
	Heat resistance stainless steel	-	(1.48□□)	-	160-200	PC9540 (PC5300)	60-100	0.2-0.05	1-2	60-100	0.25-0.05	1-3
K	Gray cast iron	GC250	250 (GG 25)	No 35 B	180-240	NCM535 (PC6510)	200-300	0.3-0.1	2-3	200-300	0.25-0.1	2-3
	Ductile cast iron	GCD500	500-7 (GGG 50)	80-55-06	150-230	PC6510 (PC5300)	110-230	0.3-0.1	2-3	150-200	0.3-0.1	2-3
		GCD600	600-3 (GGG 60)	-	170-270	PC6510 (PC5300)	85-200	0.25-0.15	2-3	150-200	0.25-0.15	2-3








# Rich Mill RM16







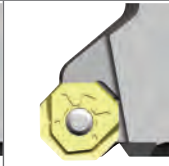


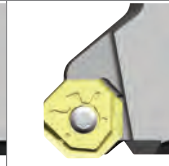
## Features

- Economical 16 cutting-edges
- Reduces cost in medium cutting
- Wiper insert can be used for good surface roughness
- Optimal matching of the special cutting-edge geometry with variety of new grades provides consistence & long tool
- When it is used 16 corners, maximum cutting depth is 5.5 mm, but it is used 8 corners, maximum cutting depth is 13 mm
- Wiper insert is placed 0.05 mm lower than facing insert in cutter
- When feed is bigger than wiper cutting-edge length (7 mm), 2 wiper inserts are placed in symmetrical position

## Features of chip breakers

Insert	Cutting-edge	Uses	Features
MA		For aluminum cutting light	With sharp edge application, the better productivity has been accomplished, especially for aluminum cutting
ML		For hard-to-cut material	Chip breaker with low cutting load is optimal for machining hard-to-cut materials
MF		For light cutting	Due to low cutting load, it is good for light cutting and difficult-to-cut material
MM		For general cutting	It is suitable design for general milling
W		For wiper	It has better surface roughness than MM and MF chip breakers

## Instruction for wiper insert

Hand	Correct setting	Incorrect setting			
Right hand					
Decision	○	×	×	×	×
Left hand					
Decision	○	×	×	×	×

## Through coolant system

- Well designed chip pocket for better chip flow
- Through coolant system reduces cutting heat and improves chip evacuation



## Recommended cutting condition

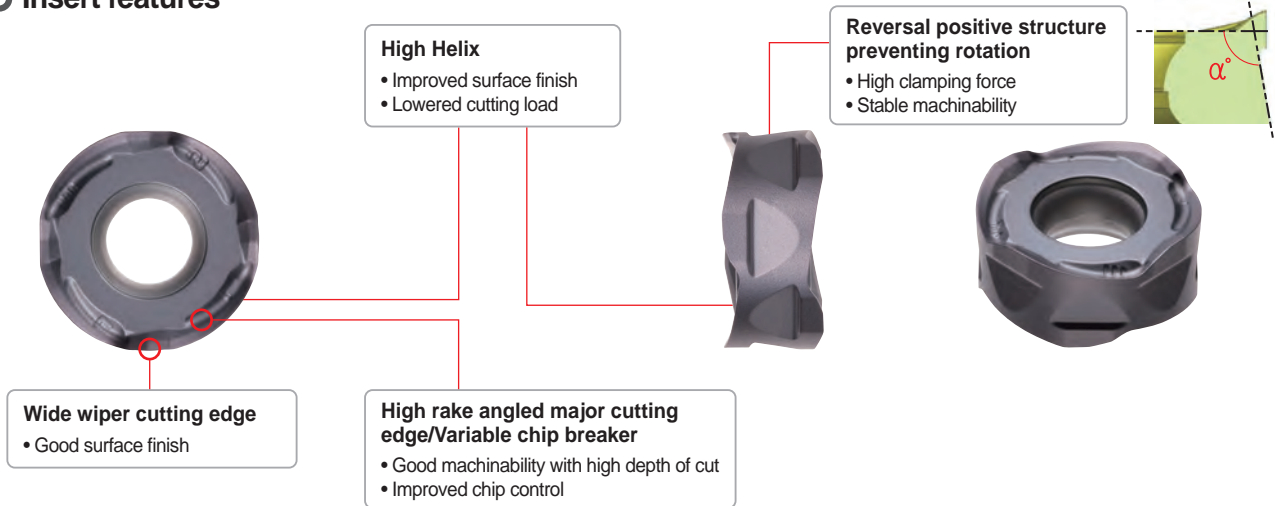
ISO	Grades	(mm)											
		ONM(H)X060608-MM		ONM(H)X060608-MF		ONHX060608-W		ONM(H)X080608-MM		ONM(H)X080608-MF		ONHX080608-W	
		vc (m/min)	fz (mm/t)	vc (m/min)	fz (mm/t)	vc (m/min)	fz (mm/t)	vc (m/min)	fz (mm/t)	vc (m/min)	fz (mm/t)	vc (m/min)	fz (mm/t)
P	NCM535	150~300	0.10~0.35	200~300	0.05~0.30	200~300	0.05~0.20	150~300	0.10~0.40	200~300	0.05~0.35	200~300	0.05~0.25
	PC3700	150~300	0.10~0.35	200~300	0.05~0.30	200~300	0.05~0.20	150~300	0.10~0.40	200~300	0.05~0.35	200~300	0.05~0.25
M	PC9530	120~180	0.10~0.35	100~180	0.05~0.30	100~180	0.05~0.20	120~180	0.10~0.40	100~180	0.05~0.35	100~180	0.05~0.25
K	PC6510	150~300	0.10~0.40	150~300	0.08~0.35	150~300	0.05~0.25	150~300	0.10~0.45	150~300	0.08~0.40	150~300	0.05~0.30

## Rich Mill RMR

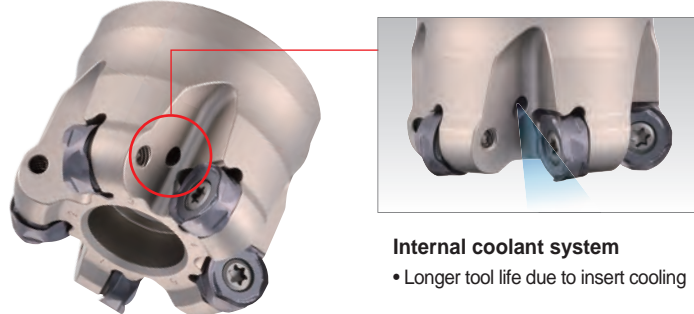
### Features

- Improved machining stability with the combination of the reversal positive structure preventing rotation and wide upper and lower clamping sides.
- Helix cutting edge and sharp chip breaker realize smooth cutting.
- Wide minor cutting edge and optimized holder angle enhance high surface finish.

### Insert features



### Cutter features

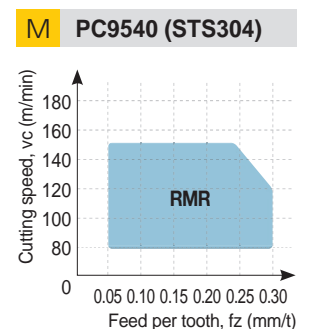
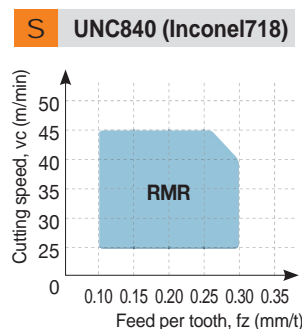


### Recommended grade and cutting edge


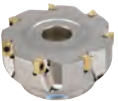


Chip breaker	Cutting-edge	Recommended grade and cutting edge by workpiece (●: 1 <sup>st</sup> recommendation)	
		S	M
		Grade	Grade
ML		● UNC840 ○ UPC845	● PC9540 ○ UPC845

### Recommended cutting condition





Workpiece	Grades	ISO	AISI	KS	Cutting conditions		
					vc (m/min)	fz (mm/t)	ap (mm)
S High temperature alloys	UNC840	15156-3	7718	Inconel718	30-50	0.4-0.1	1.0-3.0
	UPC845	15156-3	7718	Inconel718	20-40	0.6-0.2	1.5-4.0
M Stainless steel	PC9540	X5CrNi18-9	304	STS304	80-160	0.3-0.05	1.0-3.0
		X5CrNiMo17-12-2	316	STS316			



**Cutters**




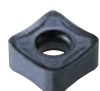


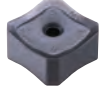

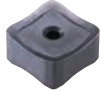

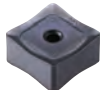
Type	A.A	Designation	Shape	Cutter Diameter	Application	Features	Page	
RM3	90°	RM3PC(M)3000		Ø40-Ø80	XNKT060405PNER-ML XNKT060405PNSR-MM		E99	
		RM3PC(M)4000		Ø40-Ø125	XNCT080508PNFR-MA XNKT080508PNER-ML XNKT080508PNSR-MM XNKT080512PNSR-MM XNKT080516PNSR-MM XNKT080520PNSR-MM		<ul style="list-style-type: none"> <li>Economical 3 corners</li> <li>Perfect perpendicularity</li> <li>Longer tool life due to direct injection into the cutting-edge of insert</li> </ul>	E100
		RM3PC(M)5000 <small>new</small>		Ø80-Ø125	XNCT120608PNER-MA XNKT120608PNER-ML XNKT120612PNER-ML XNKT120616PNER-ML XNKT120620PNER-ML XNKT120608PNSR-MM XNKT120612PNSR-MM XNKT120616PNSR-MM XNKT120620PNSR-MM		E101	
RM4	90°	RM4PC(M)3000		Ø40-Ø100	LNEX100605PNR-MF LNMX100605aPNR-MF LNEX100605PNR-MM LNMX100605PNR-MM LNEX100608PNR-MF LNMX100608PNR-MF LNEX100608PNR-MM LNMX100608PNR-MM		E105	
		RM4PC(M)4000		Ø50-Ø160	LNEX151004PNR-MF LNMX151004PNR-MF LNEX151004PNR-MM LNMX151004PNR-MM LNEX151008PNR-MF LNMX151008PNR-MF LNEX151008PNR-MM LNMX151008PNR-MM LNEX151016PNR-MF LNMX151016PNR-MF LNEX151016PNR-MM LNMX151016PNR-MM LNEX151004PNR-MA LNEX151008PNR-MA LNEX151008PNL-MM LNMX151008PNL-MM		<ul style="list-style-type: none"> <li>Economical 4 corners</li> <li>Screw on type for slotting, facing</li> </ul>	E106
		RM4ZCM3000	Ø40-Ø52	LNEX100605PNL-MM LNMX100605PNL-MM			<ul style="list-style-type: none"> <li>Economical 4 corners</li> <li>Optimal insert application for vertical machining</li> </ul>	E118
		RM4ZC(M)4000	Ø63-Ø100	LNEX151008PNL-MM LNMX151008PNL-MM				

## Cutters

Type	A.A	Designation	Shape	Cutter Diameter	Application	Features	Page
RM6	90°	RM6PCM-WN04 <small>new</small>		Ø40-Ø63	WNGX040304PNFR-MA WNGX040312PNER-ML WNGX040308PNFR-MA WNGX040316PNER-ML WNGX040312PNFR-MA WNGX040304PNSR-MM WNGX040316PNFR-MA WNGX040308PNSR-MM WNGX040304PNER-ML WNGX040312PNSR-MM WNGX040308PNER-ML WNGX040316PNSR-MM	   <ul style="list-style-type: none"> <li>Improved productivity and high-quality shouldering through high speed and high feed machining</li> </ul>	E120
		RM6PC(M)-WN08 <small>new</small>		Ø50-Ø125	WNGX080604PNFR-MA WNGX080616PNER-ML WNGX080608PNFR-MA WNGX080620PNER-ML WNGX080612PNFR-MA WNGX080604PNSR-MM WNGX080616PNFR-MA WNGX080608PNSR-MM WNGX080620PNFR-MA WNGX080612PNSR-MM WNGX080604PNER-ML WNGX080616PNSR-MM WNGX080608PNER-ML WNGX080620PNSR-MM WNGX080612PNER-ML		E121
RM8	45°	RM8AC(M)4000		Ø50-Ø400	SNEX1206ANN-MA SNEX1206ANN-MM SNEX1206ANN-MF SNMX1206ANN-MM SNMX1206ANN-MF SNEX1206ANN-W SNEX1206ANN-ML		E126
		RM8AC(M)5000		Ø80-Ø400	SNEX1507ANN-MF SNEX1507ANN-MM SNMX1507ANN-MF SNMX1507ANN-MM SNEX1507ANN-ML		E128
	75°	RM8EC(M)4000		Ø50-Ø400	SNEX1206ENN-MA SNEX1206ENN-ML SNEX1206ENN-MF SNEX1206ENN-MM SNMX1206ENN-MF SNMX1206ENN-MM	 <ul style="list-style-type: none"> <li>Economical 8 corners</li> <li>Low cutting load and excellent smooth cutting</li> </ul>	E130
		RM8EC(M)5000		Ø80-Ø400	SNEX1507ENN-MF SNEX1507ENN-MM SNMX1507ENN-MF SNMX1507ENN-MM SNEX1507ENN-ML		E132
88°	RM8QC(M)4000		Ø63-Ø200	SNEX1206QNN-MA SNEX120612-MA SNEX1206QNN-MF SNEX120612-MF SNMX1206QNN-MF SNMX120612-MF SNEX1206QNN-ML SNEX120612-ML SNEX1206QNN-MM SNEX120612-MM SNMX1206QNN-MM SNMX120612-MM		E134	












**Cutters**

Type	A.A	Designation	Shape	Cutter Diameter	Application		Features	Page	
RM8	45°	RMH8AC(M)4000		Ø50-Ø400	SNEX1206ANN-MA SNEX1206ANN-MF SNMX1206ANN-MF	SNEX1206ANN-ML SNEX1206ANN-MM SNMX1206ANN-MM SNEX1206ANN-W		E127	
		RMH8AC(M)5000		Ø80-Ø400	SNEX1507ANN-MF SNMX1507ANN-MF SNEX1507ANN-ML	SNEX1507ANN-MM SNMX1507ANN-MM		E129	
	75°	RMH8EC(M)4000		Ø50-Ø400	SNEX1206ENN-MA SNEX1206ENN-MF SNMX1206ENN-MF	SNEX1206ENN-ML SNEX1206ENN-MM SNMX1206ENN-MM		<ul style="list-style-type: none"> <li>• Economical 8 corners</li> <li>• Low cutting load and excellent smooth cutting</li> </ul>	E131
		RMH8EC(M)5000		Ø80-Ø400	SNEX1507ENN-MF SNMX1507ENN-MF SNEX1507ENN-ML	SNEX1507ENN-MM SNMX1507ENN-MM			E133
	88°	RMH8QC(M)4000		Ø63-Ø200	SNEX1206QNN-MA SNEX1206QNN-MF SNMX1206QNN-MF SNEX1206QNN-ML SNEX1206QNN-MM SNMX1206QNN-MM	SNEX120612-MA SNEX120612-MF SNMX120612-MF SNEX120612-ML SNEX120612-MM SNMX120612-MM		E135	
RMT8	45°	RMT8A(M) 4000/5000		Ø80-Ø315	SNCF1206ANN-MF SNCF1507ANN-MF SNMF1206ANN-MF SNMF1507ANN-MF	SNCF1206ANN-MM SNCF1507ANN-MM SNMF1206ANN-MM SNMF1507ANN-MM		E136 E137	
		RMT8E(M) 4000/5000		Ø80-Ø315	SNCF1206ENN-MF SNCF1507ENN-MF SNMF1206ENN-MF SNMF1507ENN-MF	SNCF1206ENN-MM SNCF1507ENN-MM SNMF1206ENN-MM SNMF1507ENN-MM			E138 E139
	88°	RMT8Q(M)4000		Ø80-Ø315	SNCF1206QNN-MF	SNMF1206QNN-MF		E140	



## Cutters





Type	A.A	Designation	Shape	Cutter Diameter	Application		Features	Page
RM8-X	45°	<b>RMX8AC(M)-SA14</b> <small>new</small>		Ø50-Ø125	SAGX140808ANER-ML SAGX140808ANER-MM SNMX140808ANER-MM		<ul style="list-style-type: none"> <li>• Double sided insert with 8 corners</li> <li>• Stable cutting performance due to double reversal positive relief surface</li> <li>• Good machinability in stainless cutting with High helix cutting edge</li> </ul>	E141
RM14	51°	<b>RM14XCM-XN06</b> <small>new</small>		Ø50-Ø160	XNMX0606XNR-ML XNMX060608-ML	  	<ul style="list-style-type: none"> <li>• Reduced vibration with the application of maximum approach angle on heptagonal shape</li> <li>• Stable clamping from wedge type clamping structure</li> <li>• Available for multiple-staged cutting without interference of the cutter's side wall</li> </ul>	E 142
RM16	45°	<b>RM16AC(M) 6000/8000</b>		Ø63-Ø400	ONHX060608-MF ONMX060608-MF ONHX0606ANN-MF ONMX0606ANN-MF ONHX080608-MF ONMX080608-MF ONHX0806ANN-MF ONMX0806ANN-MF ONHX060608-ML ONMX060608-ML ONHX080608-ML ONMX060608-MM ONHX0606ANN-MM ONMX0606ANN-MM ONHX080608-MM ONMX080608-MM ONHX0806ANN-MM ONMX0806ANN-MM ONHX060608-MA ONMX060608-W ONHX080608-MA ONMX080608-W		<ul style="list-style-type: none"> <li>• Economical 16 corners</li> <li>• Wiper insert for surface roughness</li> </ul>	E143 E144
RMR	-	<b>RMRC(M)-RN12</b> <small>new</small>		Ø50-Ø125	RNMX1204M0E-ML		<ul style="list-style-type: none"> <li>• High cost efficiency due to double sided round typed cutting edge</li> <li>• Excellent rotating prevention by strong clamping system</li> <li>• Suitable for Inconel cutting</li> </ul>	E145



**Shanks/Modulars**

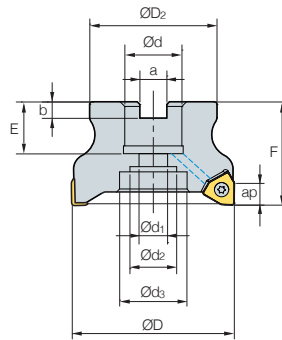
Type	A.A	Designation	Shape	Cutter Diameter	Application		Features	Page
RM3	90°	RM3PS3000 <small>new</small>		Ø20-Ø40	XNKT060405PNER-ML	XNKT060405PNSR-MM	<ul style="list-style-type: none"> <li>Economical 3 corners</li> <li>Perfect perpendicular shouldering operation multi milling tool</li> </ul>	E102
		Ø32-Ø63		XNKT080508PNER-ML XNKT080508PNSR-MM XNKT080512PNSR-MM	XNKT080516PNSR-MM XNKT080520PNSR-MM			E103
		RM3PM <small>new</small> 3000/4000		Ø20-Ø50	XNKT060405PNER-ML XNKT060405PNSR-MM XNKT060408PNER-ML XNKT060408PNSR-MM XNCT080504PNFR-MA XNCT080508PNFR-MA XNCT080512PNFR-MA XNCT080520PNFR-MA			XNKT080508PNER-ML XNKT080508PNSR-MM XNKT080512PNER-ML XNKT080512PNSR-MM XNKT080516PNER-ML XNKT080516PNSR-MM XNKT080520PNER-ML XNKT080520PNSR-MM
RM4	90°	RM4PS3000		Ø14-Ø50	LNEX100605PNR-MF LNMX100605PNR-MF LNEX100605PNR-MM LNMX100605PNR-MM LNEX100608PNR-MF LNMX100608PNR-MF	LNEX100608PNR-MM LNMX100608PNR-MM LNEX100605PNR-MA LNEX100605PNL-MM LNMX100605PNL-MM	<ul style="list-style-type: none"> <li>Economical 4 corners</li> <li>Screw on type for slotting, facing</li> </ul>	E115
		RM4PS4000		Ø32-Ø63	LNEX151004PNR-MF LNMX151004PNR-MF LNEX151004PNR-MM LNMX151004PNR-MM LNEX151008PNR-MF LNMX151008PNR-MF LNEX151008PNR-MM LNMX151008PNR-MM	LNEX151016PNR-MF LNMX151016PNR-MF LNEX151016PNR-MM LNMX151016PNR-MM LNEX151004PNR-MA LNEX151008PNR-MA LNEX151008PNL-MM LNMX151008PNL-MM		E116
	RM4ZS3000		Ø25-Ø40	LNEX100605PNL-MM	LNMX100605PNL-MM		<ul style="list-style-type: none"> <li>Economical 4 corners</li> <li>Optimal insert application for vertical machining</li> </ul>	E119
	RM4PM3000		Ø14-Ø50	LNEX100605PNR-MF LNMX100605PNR-MF LNEX100605PNR-MM LNMX100605PNR-MM LNEX100608PNR-MF LNMX100608PNR-MF	LNEX100608PNR-MM LNMX100608PNR-MM LNEX100605PNR-MA LNEX100605PNL-MM LNMX100605PNL-MM			<ul style="list-style-type: none"> <li>Economical 4 corners</li> <li>Screw on type for slotting, facing</li> </ul>
			RM4ZM3000		Ø25-Ø40	LNEX100605PNL-MM	LNMX100605PNL-MM	<ul style="list-style-type: none"> <li>Economical 4 corners</li> <li>Optimal insert application for vertical machining</li> </ul>

## Shanks/Modulars

Type	A.A	Designation	Shape	Cutter Diameter	Application	Features	Page
RM6	90°	RM6PS-WN04 <b>new</b>		Ø20-Ø32	WNGX040304PNFR-MA WNGX040312PNER-ML WNGX040308PNFR-MA WNGX040316PNER-ML WNGX040312PNFR-MA WNGX040304PNSR-MM WNGX040316PNFR-MA WNGX040308PNSR-MM WNGX040304PNER-ML WNGX040312PNSR-MM WNGX040308PNER-ML WNGX040316PNSR-MM		E122
		RM6PS-WN08 <b>new</b>		Ø32-Ø50	WNGX080604PNFR-MA WNGX080616PNER-ML WNGX080608PNFR-MA WNGX080620PNER-ML WNGX080612PNFR-MA WNGX080604PNSR-MM WNGX080616PNFR-MA WNGX080608PNSR-MM WNGX080620PNFR-MA WNGX080612PNSR-MM WNGX080604PNER-ML WNGX080616PNSR-MM WNGX080608PNER-ML WNGX080620PNSR-MM WNGX080612PNER-ML		E123
		RM6PM-WN04 <b>new</b>		Ø20-Ø32	WNGX040304PNFR-MA WNGX040312PNER-ML WNGX040308PNFR-MA WNGX040316PNER-ML WNGX040312PNFR-MA WNGX040304PNSR-MM WNGX040316PNFR-MA WNGX040308PNSR-MM WNGX040304PNER-ML WNGX040312PNSR-MM WNGX040308PNER-ML WNGX040316PNSR-MM		E124
		RM6PM-WN08 <b>new</b>		Ø32-Ø40	WNGX080604PNFR-MA WNGX080616PNER-ML WNGX080608PNFR-MA WNGX080620PNER-ML WNGX080612PNFR-MA WNGX080604PNSR-MM WNGX080616PNFR-MA WNGX080608PNSR-MM WNGX080620PNFR-MA WNGX080612PNSR-MM WNGX080604PNER-ML WNGX080616PNSR-MM WNGX080608PNER-ML WNGX080620PNSR-MM WNGX080612PNER-ML		E125
RMR	-	RMRS-RN12 <b>new</b>		Ø32-Ø63	RNMX1204M0E-ML	<ul style="list-style-type: none"> <li>• High cost efficiency due to double sided round typed cutting edge</li> <li>• Excellent rotating prevention by strong clamping system</li> <li>• Suitable for Inconel cutting</li> </ul>	E146



# RM3PC(M)3000 new



AA  
90°

- AR: -5°
- RR: -9°~-6°

Designation		⊙	ØD	ØD2	Ød	Ød1	Ød2	Ød3	a	b	E	F	ap	kg
RM3PCM	3040HR	5	40	35	16	9	14	-	8.4	5.6	16	40	5.5	0.2
	3040HR-M	6	40	35	16	9	14	-	8.4	5.6	16	40	5.5	0.2
	3050HR	6	50	41	22	11	18	-	10.4	6.3	20	40	5.5	0.3
	3050HR-M	7	50	41	22	11	18	-	10.4	6.3	20	40	5.5	0.3
	3063HR	7	63	49	22	11	18	-	10.4	6.3	20	40	5.5	0.49
	3063HR-M	8	63	49	22	11	18	-	10.4	6.3	20	40	5.5	0.49
RM3PC (RM3PCM)	3080HR	8	80	57	25.4 (27)	14	25	35	9.5 (12.4)	6 (7)	25 (23)	50	5.5	0.87
	3080HR-M	10	80	57	25.4 (27)	14	25	35	9.5 (12.4)	6 (7)	25 (23)	50	5.5	0.88

( ) Metric size

## Available inserts

XNKT-ML XNKT-MM



Designation	Cermet		Coated										Uncoated			page		
	CN2500	CN30	NC5330	NCM325	NCM335	NCM535	NCM545	PC2505	PC2510	PC3700	PC6510	PC9530	PC9540	PC5300	PC5400		ST30A	G10
XNKT	060405PNER-ML								●	●	●		●	●	●			
	060405PNSR-MM							●	●	●	●		●	●	●			
	060408PNER-ML										●			●	●			
	060408PNSR-MM							●	●	●	●			●	●			

E32

## Available arbors

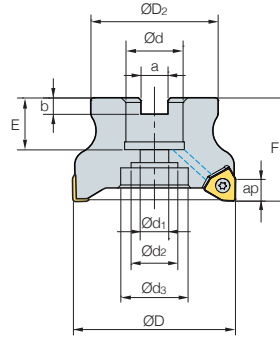
Designation	Available arbors	
	RM3PC	RM3PCM
RM3PC(M)	3040HR	
	3040HR-M	BT□□-FMC16-□□
	3050HR	
	3050HR-M	
	3063HR	
	3063HR-M	BT□□-FMC22-□□
	3080HR	
	3080HR-M	BT□□-FMA25.4-□□

## Parts

Specification		
Ø40~Ø80	FTNA0306	TW09S

Available inserts E32 Available arbors and bolt E426~E428

# RM3PC(M)4000 new



(mm)

Designation	Flutes	ØD	ØD2	Ød	Ød1	Ød2	Ød3	a	b	E	F	ap	kg	
RM3PCM	4040HR	3	40	35	16	9	14	-	8.4	5.6	19	40	8.0	0.19
	4040HR-M	4	40	35	16	9	14	-	8.4	5.6	19	40	8.0	0.19
	4050HR	4	50	42	22	11	18	-	10.4	6.3	20	40	8.0	0.28
	4050HR-M	5	50	42	22	11	18	-	10.4	6.3	20	40	8.0	0.29
	4063HR	5	63	49	22	11	18	-	10.4	6.3	20	40	8.0	0.54
	4063HR-M	6	63	49	22	11	18	-	10.4	6.3	20	40	8.0	0.53
RM3PC (RM3PCM)	4080HR	5	80	57	25.4 (27)	14	20	35	9.5 (12.4)	6 (7)	25 (23)	50	8.0	1.08
	4080HR-M	7	80	57	25.4 (27)	14	20	35	9.5 (12.4)	6 (7)	25 (23)	50	8.0	1.06
	4100HR	7	100	67	31.75 (32)	18	26	42	12.7 (14.4)	8 (8)	33 (25)	63 (50)	8.0	1.68
	4100HR-M	8	100	67	31.75 (32)	18	26	42	12.7 (14.4)	8 (8)	33 (25)	63 (50)	8.0	1.67
	4125HR	8	125	90	38.1 (40)	22	32	52	15.9 (16.4)	9 (10)	38 (29)	63	8.0	3.45
	4125HR-M	10	125	90	38.1 (40)	22	32	52	15.9 (16.4)	9 (10)	38 (29)	63	8.0	3.45

## Available inserts

( )Metric size

XNCT-MA XNKT-ML XNKT-MM



Designation	Cermet		Coated										Uncoated			page			
	CN2500	CN30	NC5330	NCM325	NCM335	NCM535	NCM545	PC2505	PC2510	PC3700	PC6510	PC9530	PC9540	PC5300	PC5400		ST30A	G10	H01
XNCT	080504PNFR-MA																		●
	080508PNFR-MA																		●
	080512PNFR-MA																		●
	080520PNFR-MA																		●
XNKT	080504PNER-ML													●	●				
	080504PNSR-MM									●				●	●				
	080508PNER-ML					●			●	●	●		●	●	●				E31
	080508PNSR-MM					●		●	●	●	●		●	●	●				E32
	080512PNER-ML													●	●				
	080512PNSR-MM								●	●	●			●	●				
	080516PNER-ML													●	●				
	080516PNSR-MM								●	●	●			●	●				
	080520PNER-ML													●	●				
	080520PNSR-MM								●	●				●	●				

## Available arbors

Designation	Available arbors	
	RM3PC	RM3PCM
RM3PC(M) 4040HR	-	BT□□-FMC16-□□
4050HR	-	BT□□-FMC22-□□
4063HR		
4080HR	BT□□-FMA25.4-□□	BT□□-FMC27-□□
4100HR	BT□□-FMA31.75-□□	BT□□-FMC32-□□
4125HR	BT□□-FMA38.1-□□	BT□□-FMC40-□□

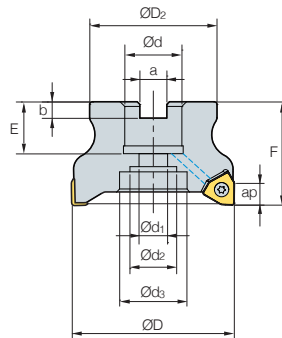
## Parts

Specification	Screw	Wrench
Ø40~Ø125	FTNA0408	TW15S

Available inserts E31, E32 Available arbors and bolt E426-E428



# RM3PC(M)5000 new



Designation			ØD	ØD2	Ød	Ød1	Ød2	Ød3	a	b	E	F	ap	
RM3PC (RM3PCM)	5080HR	5	80	57	25.4 (27)	14	20	35	9.5 (12.4)	6 (7)	24 (23)	50	12.0	0.84
	5080HR-M	7	80	57	25.4 (27)	14	20	35	9.5 (12.4)	6 (7)	24 (23)	50	12.0	0.84
	5100HR	7	100	67	31.75 (32)	18	28	45	12.7 (14.4)	8 (8)	32 (25)	63	12.0	1.76
	5100HR-M	8	100	67	31.75 (32)	18	28	45	12.7 (14.4)	8 (8)	32 (25)	63	12.0	1.76
	5125HR	8	125	90	38.1 (40)	22	32	52	15.9 (16.4)	9 (10)	38 (30)	63	12.0	2.70
	5125HR-M	10	125	90	38.1 (40)	22	32	52	15.9 (16.4)	9 (10)	38 (30)	63	12.0	2.70

(mm)

( ) Metric size

## Available inserts



Designation	Cermet		Coated											Uncoated			page										
	CN2500	CN30	NC5330	NCM325	NCM335	NCM535	NCM545	PC2505	PC2510	PC3700	PC6510	PC9530	PC9540	PC5300	PC5400	ST30A		G10	H01								
XNCT	120608PNFR-MA																										
XNKT	120604PNSR-MM																										
	120608PNER-ML																										
	120608PNSR-MM																										
	120612PNER-ML																										
	120612PNSR-MM																										
	120616PNER-ML																										
	120616PNSR-MM																										
	120620PNER-ML																										
	120620PNSR-MM																										

E31  
E32

## Available arbors

Designation	Available arbors	
	RM3PC	RM3PCM
RM3PC(M) 5080HR	BT□□ -FMA25.4-□□	BT□□ -FMC27-□□
5100HR	BT□□ -FMA31.75-□□	BT□□ -FMC32-□□
5125HR	BT□□ -FMA38.1-□□	BT□□ -FMC40-□□

## Parts

Specification		
Ø80-Ø125	FTNA0511	TW20-100

Available inserts E31, E32 Available arbors and bolt E426-E428

# RM3PS3000 new

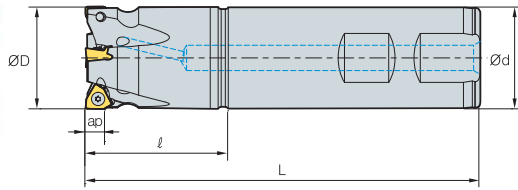


Fig. 1

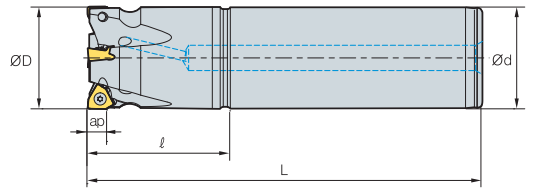


Fig. 2



AA **90°**  
 •AR: -5°  
 •RR: -16°--9°

(mm)

Designation		ØD	Ød	ℓ	L	ap		Fig.
RM3PS 3020HR-2S20	2	20	20	35	100	5.5	0.21	2
3020HR-2L20	2	20	20	35	200	5.5	0.43	1
3021HR-2S20	2	21	20	30	100	5.5	0.21	2
3021HR-2L20	2	21	20	30	200	5.5	0.43	1
3025HR-3S20	3	25	20	35	115	5.5	0.27	2
3025HR-3L20	3	25	20	35	200	5.5	0.46	1
3025HR-3S25	3	25	25	40	115	5.5	0.36	2
3025HR-3L25	3	25	25	40	200	5.5	0.66	1
3026HR-2S20	2	26	20	35	115	5.5	0.29	2
3026HR-2L20	2	26	20	35	200	5.5	0.47	1
3026HR-3S20	3	26	20	35	115	5.5	0.28	2
3026HR-3L20	3	26	20	35	200	5.5	0.47	1
3026HR-2S25	2	26	25	35	115	5.5	0.37	2
3026HR-2L25	2	26	25	35	200	5.5	0.68	1
3026HR-3S25	3	26	25	35	115	5.5	0.37	2
3026HR-3L25	3	26	25	35	200	5.5	0.68	1
3032HR-3S25	3	32	25	42	125	5.5	0.48	2
3032HR-3L25	3	32	25	42	200	5.5	0.74	1
3032HR-4S25	4	32	25	42	125	5.5	0.48	2
3032HR-4L25	4	32	25	42	200	5.5	0.74	1
3032HR-4S32	4	32	32	42	125	5.5	0.68	2
3032HR-4L32	4	32	32	42	200	5.5	1.13	1
3033HR-3S25	3	33	25	42	125	5.5	0.49	2
3033HR-3L25	3	33	25	42	200	5.5	0.75	1
3033HR-4S25	4	33	25	42	125	5.5	0.49	2
3033HR-4L25	4	33	25	42	200	5.5	0.75	1
3033HR-4S32	4	33	32	42	125	5.5	0.70	2
3033HR-4L32	4	33	32	42	200	5.5	1.14	1
3040HR-4S32	4	40	32	45	130	5.5	0.83	2
3040HR-4L32	4	40	32	45	200	5.5	1.24	1
3040HR-5S32	5	40	32	45	130	5.5	0.83	2
3040HR-5L32	5	40	32	45	200	5.5	1.24	1

## Available inserts

XNKT-ML XNKT-MM



Designation	Cermet		Coated										Uncoated			page			
	CN2500	CN30	NC5330	NCM325	NCM335	NCM535	NCM545	PC2505	PC2510	PC3700	PC6510	PC9530	PC9540	PC5300	PC5400		ST30A	G10	H01
XNKT 060405PNER-ML								●	●	●			●	●	●				E32
060405PNSR-MM								●	●	●			●	●	●				
060408PNER-ML														●	●				
060408PNSR-MM								●	●	●				●	●				

## Parts

Specification		
Ø20~Ø40	FTNA0306	TW09S

Available inserts E32





# RM3PS4000 new

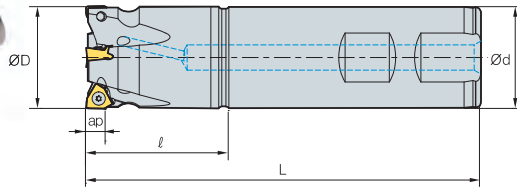


Fig. 1

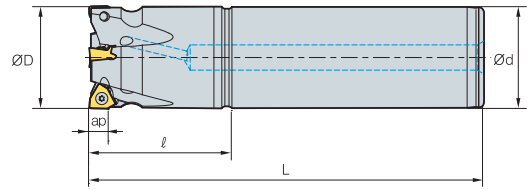


Fig. 2



AA  
90°

- AR: -5°
- RR: -11°~-7°

(mm)

Designation		ØD	Ød	ℓ	L	ap		Fig.
RM3PS 4032HR-3S32	3	32	32	42	125	8	0.67	2
4032HR-3L32	3	32	32	42	200	8	1.11	1
4033HR-3S32	3	33	32	42	125	8	0.68	2
4033HR-3L32	3	33	32	42	200	8	1.13	1
4040HR-3S32	3	40	32	42	130	8	0.8	2
4040HR-3L32	3	40	32	42	200	8	1.21	1
4040HR-4S32	4	40	32	42	130	8	0.81	2
4040HR-4L32	4	40	32	42	200	8	1.22	1
4050HR-4S32	4	50	32	42	135	8	0.99	2
4050HR-4L32	4	50	32	42	200	8	1.38	1
4050HR-4S40	4	50	40	42	135	8	1.32	2
4050HR-4L40	4	50	40	42	200	8	1.94	1
4050HR-5S32	5	50	32	42	135	8	1.02	2
4050HR-5L32	5	50	32	42	200	8	1.4	1
4050HR-5S40	5	50	40	42	135	8	1.35	2
4050HR-5L40	5	50	40	42	200	8	1.96	1
4063HR-5S32	5	63	32	42	135	8	1.31	2
4063HR-5L32	5	63	32	42	200	8	1.7	1
4063HR-5S40	5	63	40	42	135	8	1.64	2
4063HR-5L40	5	63	40	42	200	8	2.25	1
4063HR-6S32	6	63	32	42	135	8	1.31	2
4063HR-6L32	6	63	32	42	200	8	1.7	1
4063HR-6S40	6	63	40	42	135	8	1.64	2
4063HR-6L40	6	63	40	42	200	8	2.26	1

## Available inserts



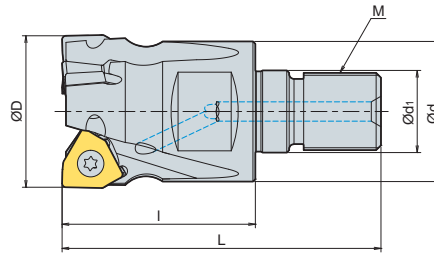
Designation	Cermet		Coated											Uncoated			page		
	CN2500	CN30	NC5330	NCM325	NCM335	NCM535	NCM545	PC2505	PC2510	PC3700	PC6510	PC9530	PC9540	PC5300	PC5400	ST30A		G10	H01
XNCT 080504PNFR-MA																		●	E31
080508PNFR-MA																		●	
080512PNFR-MA																		●	
080520PNFR-MA																		●	
XNKT 080504PNER-ML														●	●				E32
080504PNSR-MM														●	●				
080508PNER-ML					●			●	●	●			●	●					
080508PNSR-MM					●			●	●	●			●	●					
080512PNER-ML														●	●				
080512PNSR-MM								●	●					●	●				
080516PNER-ML														●	●				
080516PNSR-MM								●	●					●	●				
080520PNER-ML														●	●				
080520PNSR-MM								●	●					●	●				

## Parts

Specification		
Ø32-Ø63	FTNA0408	TW15S

Available inserts E31, E32

# RM3PM3000/4000 new



AA 90°  
 • AR: -5°  
 • RR: -16°~-7°

(mm)

Designation		ØD	Ød	Ød1	I	L	M	ap		
RM3PM	3020HR-2-M10	2	20	18	10.5	30	50	M10	5.5	0.06
	3025HR-3-M12	3	25	21	12.5	35	58	M12	5.5	0.1
	3032HR-4-M16	4	32	29	17	40	66	M16	5.5	0.21
	3040HR-5-M16	5	40	29	17	40	66	M16	5.5	0.26
RM3PM	4032HR-3-M16	3	32	29	17	40	66	M16	8	0.21
	4040HR-4-M16	4	40	29	17	50	76	M16	8	0.33
	4050HR-5-M16	5	50	29	17	55	81	M16	8	0.49

## Available inserts



Designation	Cermet		Coated										Uncoated			page				
	CN2500	CN30	NC5330	NCM325	NCM335	NCM535	NCM545	PC2505	PC2510	PC3700	PC6510	PC9530	PC9540	PC5300	PC5400		ST30A	G10	H01	
3000 type	XNKT	060405PNER-ML							●	●	●		●	●	●				E32	
		060405PNSR-MM						●	●	●		●	●	●						
		060408PNER-ML									●		●	●						
		060408PNSR-MM						●	●	●	●			●	●					
4000 type	XNCT	080504PNFR-MA																●	E31 E32	
		080508PNFR-MA																●		
		080512PNFR-MA																●		
		080520PNFR-MA																●		
	XNKT	080504PNER-ML													●	●				
		080504PNSR-MM									●			●	●					
		080508PNER-ML					●			●	●			●	●					
		080508PNSR-MM					●		●	●	●			●	●					
		080512PNER-ML							●	●				●	●					
		080512PNSR-MM							●	●				●	●					
		080516PNER-ML												●	●					
		080516PNSR-MM							●	●				●	●					
080520PNER-ML													●	●						
080520PNSR-MM							●	●					●	●						

## Available adaptor

Designation	Available adaptor	
RM3PM	3020HR-2-M10	MAT-M10
	3025HR-3-M12	MAT-M12
	3032HR-4-M16	MAT-M16
	3040HR-5-M16	MAT-M16
RM3PM	4032HR-3-M16	MAT-M16
	4040HR-4-M16	MAT-M16
	4050HR-5-M16	MAT-M16

Designation : RM3PM4032HR-M16  
 Modular head threading measure size (M16)

II

Adaptor spec.: MAT-M16-035-S32S  
 Adaptor threading measure (M16)

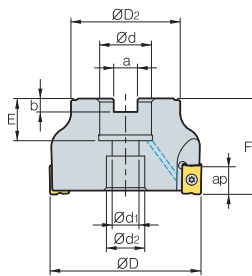
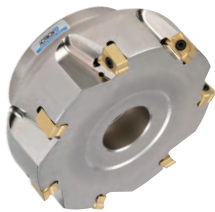
## Parts

Specification		
Ø20~Ø40 (3000 type)	FTNA0306	TW09S
Ø32~Ø50 (4000 type)	FTNA0408	TW15S

Available inserts E31, E32 Available adaptor E401-E402



# RM4PC(M)3000



AA 90°  
 • AR: -6°  
 • RR: -19°--13°

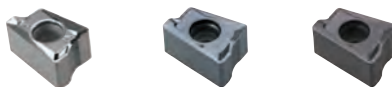
(mm)

Designation		ØD	ØD2	Ød	Ød1	Ød2	a	b	E	F	ap		Bolt	
RM4PCM	3040HR	4	40	35	16	9	14	8.4	5.6	19	40	9.0	0.24	SB0825
	3040HR-M	5	40	35	16	9	14	8.4	5.6	19	40	9.0	0.23	SB0825
	3050HR	5	50	42	22	11	18	10.4	6.3	20	40	9.0	0.36	SB1025
	3050HR-M	7	50	42	22	11	18	10.4	6.3	20	40	9.0	0.35	SB1025
	3063HR	7	63	49	22	11	18	10.4	6.3	20	40	9.0	0.61	SB1025
3063HR-M	9	63	49	22	11	18	10.4	6.3	20	40	9.0	0.6	SB1025	
RM4PC (RM4PCM)	3080HR	8	80	57	25.4 (27)	14	20	9.5 (12.4)	6.0 (7.0)	25 (23)	50	9.0	1.25 (1.24)	SB1230
	3080HR-M	10	80	57	25.4 (27)	14	20	9.5 (12.4)	6.0 (7.0)	25 (23)	50	9.0	1.24 (1.23)	SB1230
	3100HR	9	100	67	31.75 (32)	18	26	12.7 (14.4)	8.0 (8.0)	33 (25)	63 (50)	9.0	2.46 (1.94)	SB1630
	3100HR-M	12	100	67	31.75 (32)	18	26	12.7 (14.4)	8.0 (8.0)	33 (25)	63 (50)	9.0	2.44 (1.93)	SB1630

( ) Metric size

## Available inserts

LNEX-MA LNM(E)X-MF LNM(E)X-MM



Designation	Cermet		Coated											Uncoated			page	
	CN2500	CN30	NC5330	NCM325	NCM335	NCM535	NCM545	PC2505	PC2010	PC3700	PC6510	PC9530	PC9540	PC5300	PC5400	ST30A		G10
LNEX	100605PNR-MF										●			●	●			
	100605PNR-MM									●	●			●	●			
	100605PNR-MA																	●
	100608PNR-MF									●	●			●	●			
	100608PNR-MM										●			●	●			
LNMX	100605PNR-MF										●			●	●			
	100605PNR-MM									●	●	●		●	●			
	100608PNR-MF										●			●	●			
	100608PNR-MM									●				●	●			

E11

## Available arbors

Designation	Available arbors	
	RM4PC	RM4PCM
RM4PC(M)	3040HR	BT□□-FMC16-□□
	3040HR-M	
	3050HR	
	3050HR-M	BT□□-FMC22-□□
	3063HR	
	3063HR-M	

Designation	Available arbors	
	RM4PC	RM4PCM
RM4PC(M)	3080HR	BT□□-FMA25.4-□□
	3080HR-M	
	3100HR	BT□□-FMA31.75-□□
	3100HR-M	

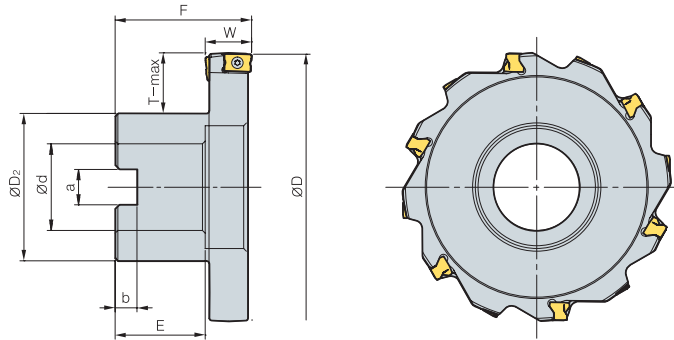
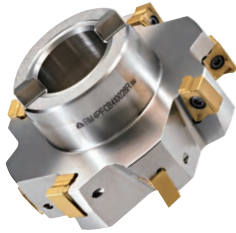
## Parts

Specification		
Ø40-Ø100	FTKA0307	TW09S

Available inserts E11 Available arbors and bolt E426-E428



# RM4PFCB3000



(mm)

Designation		ØD	ØD <sub>2</sub>	Ød	a	b	E	F	W	T-max	
RM4PFCB 308015R		10	80	40	25.4	9.5	6	25	50	15	19
		10	80	40	25.4	9.5	6	25	50	17	19
310015R		12	100	54	31.75	12.7	8	32	50	15	22
		12	100	54	31.75	12.7	8	32	50	17	22
312515R		14	125	70	38.1	15.9	10	38	60	15	26
		14	125	70	38.1	15.9	10	38	60	17	26
316015R		16	160	70	38.1	15.9	10	38	60	15	44
		16	160	70	38.1	15.9	10	38	60	17	44

## Available inserts

LNM(E)X-MM



Designation	Cermet		Coated										Uncoated			page		
	CN2500	CN30	NC5330	NCM325	NCM335	NCM535	NCM545	PC2505	PC2010	PC3700	PC6510	PC9530	PC9540	PC5300	PC5400		ST30A	G10
LNEX 100605PNR-MM 100605PNL-MM										●	●			●	●			
											●			●	●			
LNMX 100605PNR-MM 100605PNL-MM										●	●	●		●	●			
										●	●			●	●			

## Available arbors

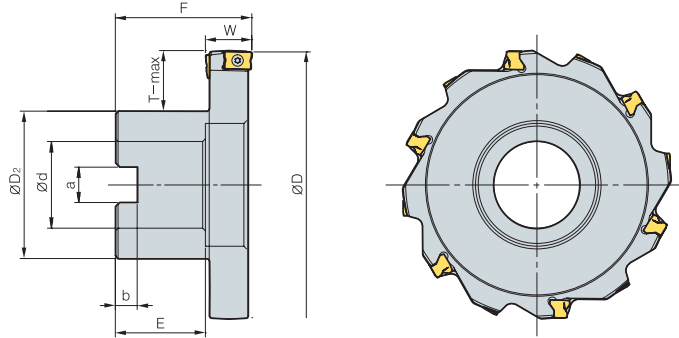
Designation	Available arbors
RM4PFCB 308015R 308017R	BT□□ -FMA25.4-□□
	BT□□ -FMA31.75-□□
310015R 310017R 312515R 312517R	BT□□ -FMA38.1-□□
316015R 316017R	

## Parts

Specification		
Ø80-Ø160	FTKA0307	TW09S

Available inserts E11 Available arbors and bolt E426-E428

# RM4PFCB4000



(mm)

Designation		ØD	ØD <sub>2</sub>	Ød	a	b	E	F	W	T-max
RM4PFCB	408022R	6	80	40	25.4	9.5	25	50	22	19
	408024R	6	80	40	25.4	9.5	25	50	24	19
	408026R	6	80	40	25.4	9.5	25	50	26	19
	408028R	6	80	40	25.4	9.5	25	50	28	19
	410022R	8	100	54	31.75	12.7	32	50	22	22
	410024R	8	100	54	31.75	12.7	32	50	24	22
	410026R	8	100	54	31.75	12.7	32	50	26	22
	410028R	8	100	54	31.75	12.7	32	50	28	22
	412522R	10	125	70	38.1	15.9	38	60	22	26
	412524R	10	125	70	38.1	15.9	38	60	24	26
	412526R	10	125	70	38.1	15.9	38	60	26	26
	412528R	10	125	70	38.1	15.9	38	60	28	26
	416022R	12	160	70	38.1	15.9	38	60	22	44
	416024R	12	160	70	38.1	15.9	38	60	24	44
	416026R	12	160	70	38.1	15.9	38	60	26	44
	416028R	12	160	70	38.1	15.9	38	60	28	44

## Available inserts

LNM(E)X-MM



Designation	Cermet		Coated										Uncoated			page		
	CN2500	CN30	NC5330	NCM325	NCM335	NCM535	NCM545	PC2505	PC2010	PC3700	PC6510	PC9530	PC9540	PC5300	PC5400		ST30A	G10
LNEX	151008PNR-MM									●	●			●	●			
	151008PNL-MM										●	●		●	●			
LNMX	151008PNR-MM					●				●	●	●		●	●			
	151008PNL-MM													●	●			

## Available arbors

Designation	Available arbors	Designation	Available arbors
RM4PFCB	408022R	RM4PFCB	412522R
	408024R		412524R
	408026R		412526R
	408028R		412528R
	410022R		416022R
	410024R		416024R
410026R	416026R	416028R	
410028R	416028R		

BT□□-FMA25.4-□□

BT□□-FMA31.75-□□

BT□□-FMA38.1-□□

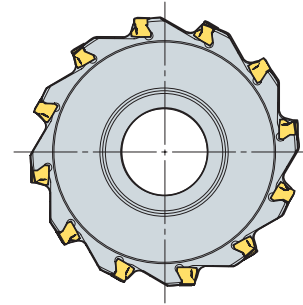
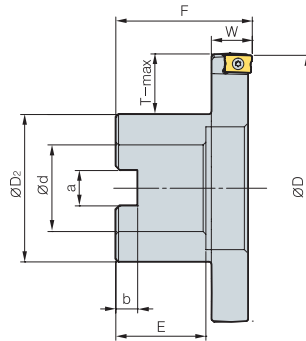
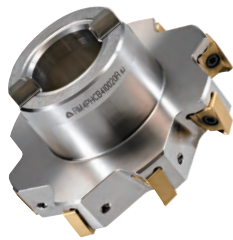
## Parts

Specification		
Ø80~Ø160	FTKA0412B	TW15S

Available inserts E11 Available arbors and bolt E426-E428



# RM4PHCB3000

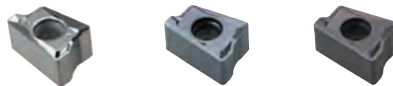


(mm)

Designation		ØD	ØD2	Ød	a	b	E	F	W	T-max	
RM4PHCB	308015R	10	80	40	25.4	9.5	6	25	50	15	19
	310015R	12	100	54	31.75	12.7	8	32	50	15	22
	312515R	14	125	70	38.1	15.9	10	38	60	15	26
	316015R	16	160	70	38.1	15.9	10	38	60	15	44

## Available inserts

LNEX-MA LNM(E)X-MF LNM(E)X-MM



Designation	Cermet		Coated											Uncoated			page		
	CN2500	CN30	NC5330	NCM325	NCM335	NCM535	NCM545	PC2505	PC2010	PC3700	PC6510	PC9530	PC9540	PC5300	PC5400	ST30A		G10	H01
LNEX	100605PNR-MF										●			●	●				
	100605PNR-MM									●	●			●	●				
	100605PNR-MA																	●	
	100608PNR-MF									●	●				●	●			
	100608PNR-MM										●				●	●			
LNMX	100605PNR-MF										●			●	●				
	100605PNR-MM									●	●	●		●	●				
	100608PNR-MF										●			●	●				
	100608PNR-MM									●				●	●				

## Available arbors

Designation	Available arbors
RM4PHCB 308015R	BT□□ -FMA25.4-□□
310015R	BT□□ -FMA31.75-□□
312515R	BT□□ -FMA38.1-□□
316015R	

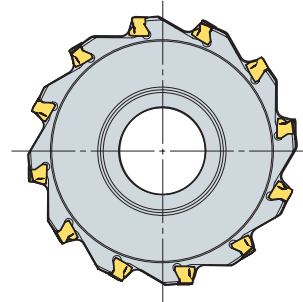
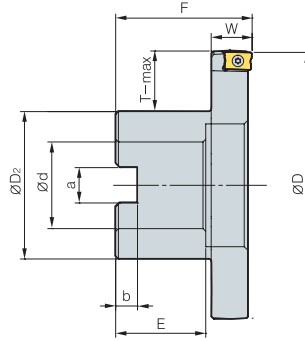
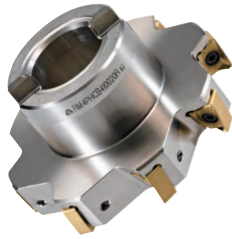
## Parts

Specification		
Ø80-Ø160	FTKA0307	TW09S

Available inserts E11 Available arbors and bolt E426-E428



# RM4PHCB4000

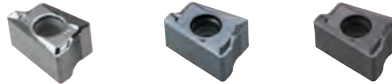


(mm)

Designation		ØD	ØD <sub>2</sub>	Ød	a	b	E	F	W	T-max	
RM4PHCB	408020R	6	80	40	25.4	9.5	6	25	50	20	19
	410020R	8	100	54	31.75	12.7	8	32	50	20	22
	412520R	10	125	70	38.1	15.9	10	38	60	20	26
	416020R	12	160	70	38.1	15.9	10	38	60	20	44

## Available inserts

LNEX-MA      LNM(E)X-MF      LNM(E)X-MM



Designation	Cermet		Coated										Uncoated			page			
	CN2500	CN30	NC5330	NCM325	NCM335	NCM535	NCM545	PC2505	PC2010	PC3700	PC6510	PC9530	PC9540	PC5300	PC5400		ST30A	G10	H01
LNEX	151004PNR-MF										●			●	●				E11
	151004PNR-MM										●			●	●				
	151004PNR-MA																	●	
	151008PNR-MF										●			●	●				
	151008PNR-MM										●	●		●	●				
	151008PNR-MA																	●	
	151016PNR-MF											●		●	●				
	151016PNR-MM											●		●	●				
LNMX	151004PNR-MF									●	●			●	●				
	151004PNR-MM										●			●	●				
	151008PNR-MF						●			●	●			●	●				
	151008PNR-MM						●			●	●	●		●	●				
	151016PNR-MF										●			●	●				
	151016PNR-MM										●			●	●				

## Available arbors

Designation	Available arbors
RM4PHCB 408020R	BT□□-FMA25.4-□□
410020R	BT□□-FMA31.75-□□
412520R	BT□□-FMA38.1-□□
416020R	

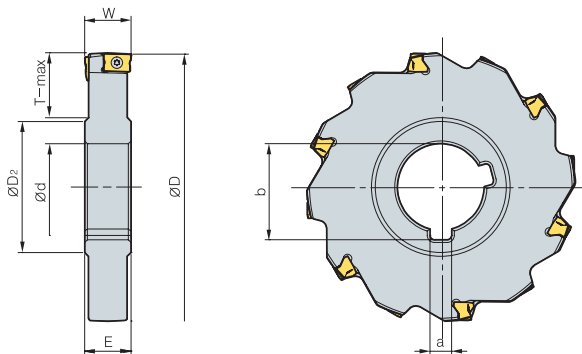
## Parts

Specification		
Ø80~Ø160	FTKA0412B	TW15S

Available inserts E11      Available arbors and bolt E426-E428



# RM4PFCP3000



(mm)

Designation		ØD	ØD <sub>2</sub>	Ød	a	b	E	W	T-max	
RM4PFCP	308015R	10	80	41.5	25.4	6.35	28	15	15	17
	308017R	10	80	41.5	25.4	6.35	28	17	17	17
	310015R	12	100	48	31.75	7.94	35.2	15	15	24
	310017R	12	100	48	31.75	7.94	35.2	17	17	24
	312515R	14	125	58	38.1	9.53	42.3	15	15	32
	312517R	14	125	58	38.1	9.53	42.3	17	17	32
	316015R	16	160	58	38.1	9.53	42.3	15	15	49
	316017R	16	160	58	38.1	9.53	42.3	17	17	49

## Available inserts

LNM(E)X-MM



Designation	Cermet		Coated										Uncoated			page			
	CN2500	CN30	NC5330	NCM325	NCM335	NCM535	NCM545	PC2505	PC2010	PC3700	PC6510	PC9530	PC9540	PC5300	PC5400		ST30A	G10	H01
LNEX	100605PNR-MM									●	●			●	●				E11
	100605PNL-MM										●			●	●				
LNMX	100605PNR-MM									●	●	●		●	●				
	100605PNL-MM									●	●			●	●				

## Available arbors

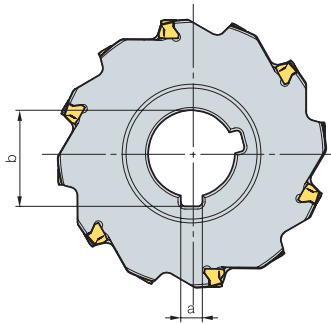
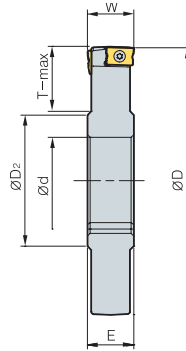
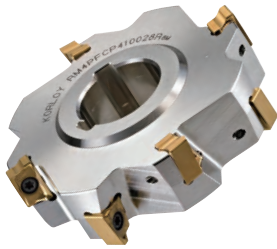
Designation	Available arbors	
RM4PFCP	308015R	BT□□ -SCA25.4-□□
	308017R	
310015R	BT□□ -SCA31.75-□□	
310017R		
312515R	BT□□ -SCA38.1-□□	
312517R		
316015R		
316017R		

## Parts

Specification		
Ø80-Ø160	FTKA0307	TW09S

Available inserts E11 Available arbors and bolt E426-E428

# RM4PFCP4000



(mm)

Designation		ØD	ØD <sub>2</sub>	Ød	a	b	E	W	T-max	
RM4PFCP	408022R	6	80	41.5	25.4	6.35	28	22	22	17
	408024R	6	80	41.5	25.4	6.35	28	24	24	17
	408026R	6	80	41.5	25.4	6.35	28	26	26	17
	408028R	6	80	41.5	25.4	6.35	28	28	28	17
	410022R	8	100	48	31.75	7.94	35.2	22	22	24
	410024R	8	100	48	31.75	7.94	35.2	24	24	24
	410026R	8	100	48	31.75	7.94	35.2	26	26	24
	410028R	8	100	48	31.75	7.94	35.2	28	28	24
	412522R	10	125	58	38.1	9.53	42.3	22	22	32
	412524R	10	125	58	38.1	9.53	42.3	24	24	32
	412526R	10	125	58	38.1	9.53	42.3	26	26	32
	412528R	10	125	58	38.1	9.53	42.3	28	28	32
416022R	12	160	58	38.1	9.53	42.3	22	22	49	
416024R	12	160	58	38.1	9.53	42.3	24	24	49	
416026R	12	160	58	38.1	9.53	42.3	26	26	49	
416028R	12	160	58	38.1	9.53	42.3	28	28	49	

## Available inserts

LNM(E)X-MM



Designation	Cermet		Coated										Uncoated			page			
	CN2500	CN30	NC6330	NCM325	NCM335	NCM535	NCM545	PC2505	PC2010	PC3700	PC6510	PC9530	PC9540	PC5300	PC5400		ST30A	G10	H01
LNEX 151008PNR-MM										●	●			●	●				E11
151008PNL-MM											●			●	●				
LNMX 151008PNR-MM						●				●	●	●		●	●				
151008PNL-MM														●	●				

## Available arbors

Designation	Available arbors	Designation	Available arbors
RM4PFCP	408022R	RM4PFCP	412522R
	408024R		412524R
	408026R		412526R
	408028R		412528R
	410022R		416022R
	410024R		416024R
	410026R		416026R
	410028R		416028R

BT□□-SCA25.4-□□

BT□□-SCA31.75-□□

BT□□-SCA38.1-□□

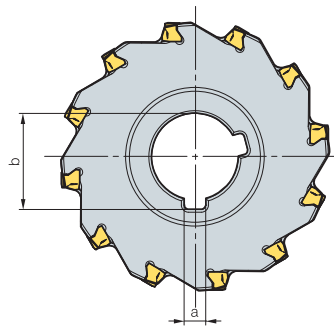
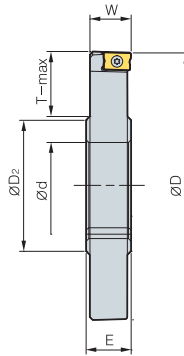
## Parts

Specification		
Ø80-Ø160	FTKA0412B	TW15S

Available inserts E11 Available arbors and bolt E426-E428



# RM4PHCP3000

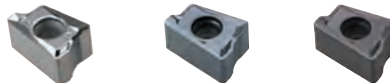


(mm)

Designation		ØD	ØD <sub>2</sub>	Ød	a	b	E	W	T-max	
RM4PHCP	308015R	10	80	41.5	25.4	6.35	28	16.5	15.1	17
	310015R	12	100	48	31.75	7.94	35.2	16.5	15.1	24
	312515R	14	125	58	38.1	9.52	42.3	16.5	15.1	32
	316015R	16	160	58	38.1	9.52	42.3	16.5	15.1	49

## Available inserts

LNEX-MA      LNM(E)X-MF      LNM(E)X-MM



Designation	Cermet		Coated											Uncoated			page	
	CN2500	CN30	NC5330	NCM325	NCM335	NCM535	NCM545	PC2505	PC2010	PC3700	PC6510	PC9530	PC9540	PC5300	PC5400	ST30A		G10
LNEX	100605PNR-MF										●			●	●			
	100605PNR-MM									●	●			●	●			
	100605PNR-MA																	●
	100608PNR-MF									●	●			●	●			
	100608PNR-MM										●	●		●	●			
LNMX	100605PNR-MF										●			●	●			
	100605PNR-MM									●	●	●		●	●			
	100608PNR-MF										●			●	●			
	100608PNR-MM									●	●			●	●			

## Available arbors

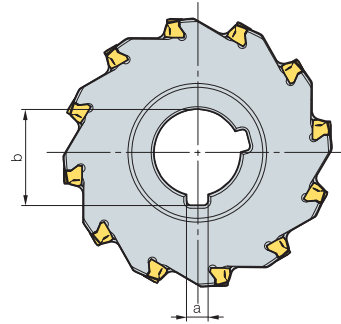
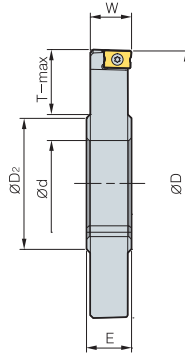
Designation	Available arbors
RM4PHCP 308015R	BT□□-SCA25.4-□□
310015R	BT□□-SCA31.75-□□
312515R	BT□□-SCA38.1-□□
316015R	

## Parts

Specification		
Ø80-Ø160	FTKA0307	TW09S

Available inserts E11      Available arbors and bolt E426-E428

# RM4PHCP4000

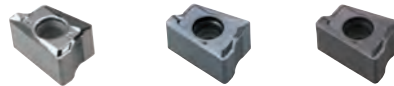


(mm)

Designation		ØD	ØD <sub>2</sub>	Ød	a	b	E	W	T-max	
RM4PHCP	408020R	6	80	41.5	25.4	6.35	28	22	19.8	17
	410020R	8	100	48	31.75	7.94	35.2	22	19.8	24
	412520R	10	125	58	38.1	9.53	42.3	22	19.8	32
	416020R	12	160	58	38.1	9.53	42.3	22	19.8	49

## Available inserts

LNEX-MA      LNM(E)X-MF      LNM(E)X-MM



Designation	Cermet		Coated												Uncoated			page
	CN2500	CN30	NC5330	NCM325	NCM335	NCM535	NCM545	PC2505	PC2010	PC3700	PC6510	PC9530	PC9540	PC5300	PC5400	ST30A	G10	
LNEX	151004PNR-MF										●			●	●			
	151004PNR-MM										●			●	●			
	151004PNR-MA																	
	151008PNR-MF										●			●	●			
	151008PNR-MM									●	●			●	●			
	151008PNR-MA																	
	151016PNR-MF											●			●	●		
	151016PNR-MM											●			●	●		
LNMX	151004PNR-MF									●	●			●	●			
	151004PNR-MM										●			●	●			
	151008PNR-MF						●			●	●			●	●			
	151008PNR-MM						●			●	●			●	●			
	151016PNR-MF										●			●	●			
	151016PNR-MM										●			●	●			

E11

## Available arbors

Designation	Available arbors
RM4PHCP 408020R	BT□□-SCA25.4-□□
410020R	BT□□-SCA31.75-□□
412520R	BT□□-SCA38.1-□□
416020R	

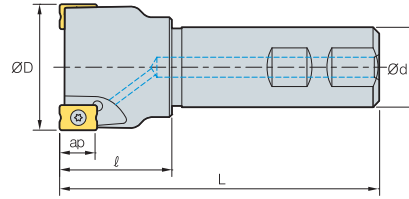
## Parts

Specification		
Ø80~Ø160	FTKA0412B	TW15S

Available inserts E11      Available arbors and bolt E426-E428



# RM4PS3000



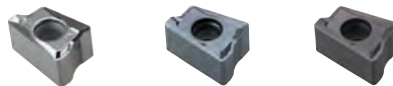
• AR: -6°  
• RR: -39°~-16°

(mm)

Designation		ØD	Ød	l	L	ap	kg
RM4PS	3014HR-S16	1	14	16	23	90	0.11
	3016HR-S16	1	16	16	25	90	0.11
	3018HR-S16	2	18	16	23	90	0.12
	3020HR-S20	2	20	20	30	100	0.21
	3020HR-S20M	3	20	20	30	100	0.21
	3025HR-S25	2	25	25	35	115	0.38
	3025HR-S25M	3	25	25	35	115	0.38
	3032HR-S32	3	32	32	40	125	0.69
	3032HR-S32M	4	32	32	40	125	0.7
	3040HR-S32	4	40	32	42	130	0.86
	3040HR-S32M	5	40	32	42	130	0.85
	3040HR-S40	4	40	40	42	130	1.17
	3040HR-S40M	5	40	40	42	130	1.17
	3040HR-S42	4	40	42	42	130	1.26
	3040HR-S42M	5	40	42	42	130	1.25
	3050HR-S32	5	50	32	45	135	1.06
	3050HR-S32M	7	50	32	45	135	1.05
	3050HR-S40	5	50	40	45	135	1.38
	3050HR-S40M	7	50	40	45	135	1.37
	3050HR-S42	5	50	42	45	135	1.48
3050HR-S42M	7	50	42	45	135	1.48	

## Available inserts

LNEX-MA LNM(E)X-MF LNM(E)X-MM



Designation	Cermet		Coated										Uncoated			page		
	CN2500	CN30	NC5330	NCM325	NCM335	NCM635	NCM645	PC2505	PC2010	PC3700	PC6510	PC9530	PC9540	PC5300	PC5400		ST30A	G10
LNEX	100605PNR-MF										●			●	●			
	100605PNR-MM									●	●			●	●			
	100605PNR-MA																	●
	100605PNL-MM									●	●			●	●			
	100608PNR-MF										●			●	●			
LNMX	100608PNR-MM										●			●	●			
	100605PNR-MF									●	●	●		●	●			
	100605PNR-MM										●			●	●			
	100608PNR-MF									●				●	●			
100608PNR-MM										●	●							

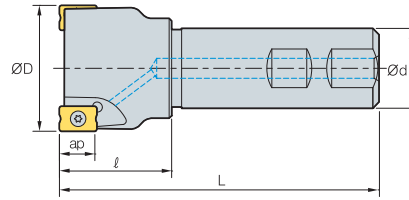
## Parts

Specification	Screw	Wrench
Ø14~Ø50	FTKA0307	TW09S

Available inserts E11



# RM4PS4000



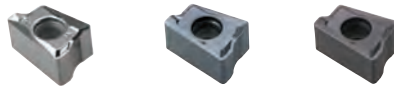
•AR: -6°  
•RR: -24°~14°

(mm)

Designation		ØD	Ød	ℓ	L	ap	
RM4PS	4032HR-S32	2	32	32	40	125	0.68
	4032HR-S32M	3	32	32	40	125	0.69
	4040HR-S32	3	40	32	42	125	0.83
	4040HR-S32M	4	40	32	42	125	0.83
	4040HR-S40	3	40	40	42	125	1.14
	4040HR-S42	3	40	42	42	125	1.23
	4050HR-S32	3	50	32	45	125	1.02
	4050HR-S32M	4	50	32	45	125	1.02
	4050HR-S40	3	50	40	45	125	1.35
	4050HR-S40M	4	50	40	45	125	1.34
	4050HR-S42	3	50	42	45	125	1.45
	4050HR-S42M	4	50	42	45	125	1.45
	4063HR-S32	4	63	32	45	125	1.25
	4063HR-S32M	6	63	32	45	125	1.24
	4063HR-S40	4	63	40	45	125	1.62
	4063HR-S40M	6	63	40	45	125	1.61
4063HR-S42	4	63	42	45	125	1.71	
4063HR-S42M	6	63	42	45	125	1.7	

## Available inserts

LNEX-MA LNM(E)X-MF LNM(E)X-MM



Designation	Cermet		Coated										Uncoated			page		
	CN2500	CN30	NC5330	NCM325	NCM335	NCM535	NCM545	PC2505	PC2010	PC3700	PC6510	PC9530	PC9540	PC5300	PC5400		ST30A	G10
LNEX	151004PNR-MF										●			●	●			
	151004PNR-MM										●			●	●			
	151004PNR-MA																	●
	151008PNR-MF										●			●	●			
	151008PNR-MM										●	●		●	●			
	151008PNR-MA																	
LNMX	151016PNR-MF										●			●	●			
	151016PNR-MM										●			●	●			
	151004PNR-MF									●	●			●	●			
	151004PNR-MM										●			●	●			
	151008PNR-MF						●			●	●			●	●			
	151008PNR-MM						●			●	●	●		●	●			
151016PNR-MF									●	●			●	●				
151016PNR-MM										●			●	●				

## Parts

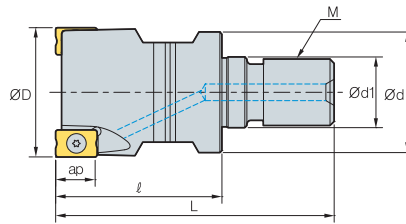
Specification		
Ø32-Ø63	FTKA0412B	TW15S

Available inserts E11





# RM4PM3000



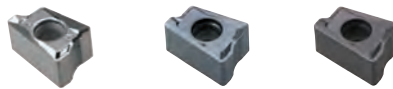
AA  
90°  
• AR: -6°  
• RR: -39°--16°

(mm)

Designation		ØD	Ød	Ød1	ℓ	L	M	ap	
RM4PM 3014HR-M06	1	14	12	6.5	25	40	M06	9.0	0.02
3016HR-M08	1	16	14.5	8.5	25	42	M08	9.0	0.02
3018HR-M08	2	18	14.5	8.5	25	42	M08	9.0	0.03
3020HR-M10	2	20	18	10.5	30	51	M10	9.0	0.06
3025HR-M12	2	25	23	12.5	35	59	M12	9.0	0.11
3032HR-M16	3	32	29	17	40	67	M16	9.0	0.21
3040HR-M16	4	40	29	17	40	67	M16	9.0	0.26
3050HR-M16	5	50	30	17	45	72	M16	9.0	0.41

## Available inserts

LNEX-MA LNM(E)X-MF LNM(E)X-MM



Designation	Cermet		Coated											Uncoated			page	
	CN2500	CN30	NC5330	NCM325	NCM335	NCM535	NCM545	PC2505	PC2010	PC3700	PC6510	PC9530	PC9540	PC5300	PC5400	ST30A		G10
LNEX 100605PNR-MF											●			●	●			
100605PNR-MM										●	●			●	●			
100605PNR-MA																		●
100608PNR-MF										●	●			●	●			
100608PNR-MM											●			●	●			
LNMX 100605PNR-MF											●			●	●			
100605PNR-MM										●	●	●		●	●			
100608PNR-MF											●			●	●			
100608PNR-MM										●				●	●			

## Available adaptor

Designation	Available adaptor
RM4PM 3014HR-M06	MAT-M06
3016HR-M08	MAT-M08
3018HR-M08	
3020HR-M10	
3025HR-M12	
3032HR-M16	MAT-M16
3040HR-M16	
3050HR-M16	

Designation : RM4PM3032HR-M16  
Modular head threading measure size (M16)

||

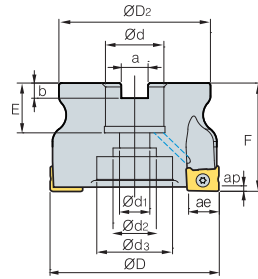
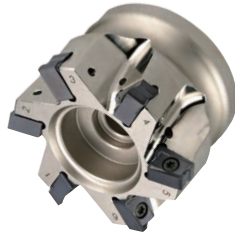
Adaptor spec.: MAT-M16-035-S32S  
Adaptor threading measure (M16)

## Parts

Specification		
Ø14~Ø50	FTKA0307	TW09S

Available inserts E11 Available adaptor E401-E402

# RM4ZC(M)3000/4000



AA  
90°  
•AR: -11°  
•RR: -12°--10°

(mm)

Designation	齿数	ØD	ØD2	Ød	Ød1	Ød2	Ød3	a	b	E	F	ap	ae	$\frac{G}{kg}$	
RM4ZCM	3040HR	4	40	37	16	9	14	-	8.4	5.6	19	40	1.5	9.0	0.21
	3050HR	5	50	47	22	11	18	-	10.4	6.3	20	40	1.5	9.0	0.33
	3052HR	5	52	48	22	11	18	-	10.4	6.3	20	40	1.5	9.0	0.37
	4063HR	5	63	58	22	11	18	-	10.4	6.3	20	40	2.5	14.0	0.56
RM4ZC (RM4ZCM)	4066HR	5	66	61	25.4 (27)	14	20	-	9.5 (12.4)	6 (7)	25	50	2.5	14.0	0.74
	4080HR	6	80	70	25.4 (27)	14	20	35	9.5 (12.4)	6 (7)	25 (23)	50	2.5	14.0	1.09
	4100HR	7	100	80	31.75 (32)	18	26	42	12.7 (14.4)	8 (8)	25 (33)	63 (50)	2.5	14.0	1.71

( )Metric size

## Available inserts

LNM(E)X-MM



Designation	Cermet		Coated										Uncoated			page		
	CN2500	CN30	NC5330	NCM325	NCM335	NCM535	NCM545	PC2505	PC2010	PC3700	PC6510	PC9330	PC9540	PC5300	PC5400		ST30A	G10
3000 type	LNEX	100605PNL-MM									●			●	●			
	LNMX	100605PNL-MM								●	●			●	●			
4000 type	LNEX	151008PNL-MM									●			●	●			
	LNMX	151008PNL-MM												●	●			

## Available arbors

Designation	Available arbors	
	RM4ZC	RM4ZCM
RM4ZCM	3040HR 3050HR 3052HR	BT□□-FMC16-□□ BT□□-SCA16-□□
		BT□□-FMC22-□□
		BT□□-FMC22-□□
RM4ZCM RM4ZC(M)	4063HR 4066HR 4080HR 4100HR	BT□□-FMA25.4-□□
		BT□□-FMA31.75-□□ BT□□-SCA31.75-□□
		BT□□-FMC27-□□ BT□□-FMC32-□□

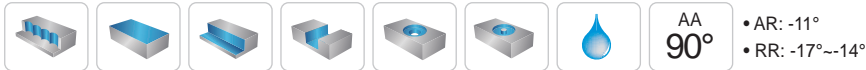
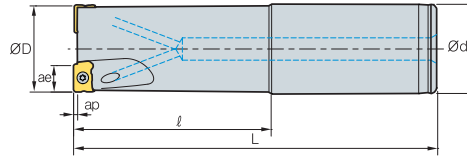
## Parts

Specification	Screw	Wrench
Ø40~Ø52 (3000 type)	FTKA0307	TW09S
Ø63~Ø100 (4000 type)	FTKA0412B	TW15S

Available inserts E11 Available arbors and bolt E426-E428

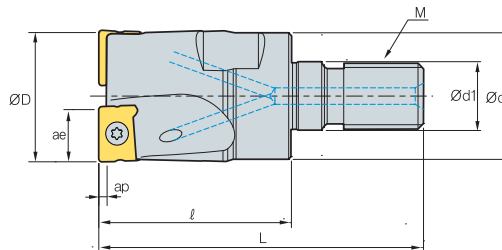


# RM4ZS3000



Designation		ØD	Ød	ℓ	L	ap	ae	
RM4ZS	3025HR-L25	2	25	25	120	200	1.5	0.62
	3032HR-L32	3	32	32	120	210	1.5	1.13
	3040HR-L32	4	40	32	120	250	1.5	1.53

# RM4ZM3000



Designation		ØD	Ød	Ød1	ℓ	L	M	ap	ae	
RM4ZM	3025HR-M12	2	25	23	12.5	35	M12	1.5	9.0	0.11
	3032HR-M16	3	32	29	17	40	M16	1.5	9.0	0.21
	3040HR-M16	4	40	29	17	40	M16	1.5	9.0	0.28

## Available inserts

LNM(E)X-MM



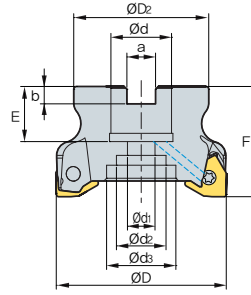
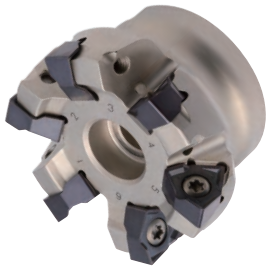
Designation	Cermet		Coated								Uncoated			page				
	CN2500	CN30	NC5330	NCM325	NCM335	NCM335	NCM645	PC2505	PC2010	PC3700	PC6510	PC9530	PC9540		PC5300	PC5400	ST30A	G10
LNEX 100605PNL-MM											●			●	●			
LNMX 100605PNL-MM										●	●			●	●			

## Parts

Specification		
Ø25~Ø40	FTKA0307	TW09S

Available inserts E11

# RM6PCM-WN04 new



AA  
90°

• AR: -6°  
• RR: -14°--11°

(mm)

Designation	ØD	ØD2	Ød	Ød1	Ød2	Ød3	a	b	E	F	ap		Available screw		
RM6PCM	040R-16-6-WN04	6	40	35	16	9	14	-	8.4	5.6	19	40	4.3	0.19	ETNA02506
	040R-16-7-WN04	7	40	35	16	9	14	-	8.4	5.6	19	40	4.3	0.19	ETNA02506
	050R-22-8-WN04	8	50	42	22	11	18	-	10.4	6.3	20	40	4.3	0.28	ETNA02506
	050R-22-9-WN04	9	50	42	22	11	18	-	10.4	6.3	20	40	4.3	0.28	ETNA02506
	063R-22-10-WN04	10	63	49	22	11	18	-	10.4	6.3	20	40	4.3	0.47	ETNA02506
	063R-22-11-WN04	11	63	49	22	11	18	-	10.4	6.3	20	40	4.3	0.47	ETNA02506

## Available inserts

WNGX-MA      WNGX-ML      WNGX-MM



Designation	Cermet		Coated										Uncoated			page			
	CN2500	CN30	NC5330	NCM325	NCM335	NCM535	NCM545	PC2505	PC2010	PC3700	PC6510	PC9530	PC9540	PC5300	PC5400		ST30A	G10	H01
WNGX	040304PNFR-MA																		●
	040308PNFR-MA																		●
	040312PNFR-MA																		●
	040316PNFR-MA																		●
	040304PNER-ML										●		●	●	●				
	040308PNER-ML												●	●					
	040312PNER-ML												●						
	040316PNER-ML												●						
	040304PNSR-MM										●		●	●	●				
	040308PNSR-MM												●	●					
	040312PNSR-MM												●						
	040316PNSR-MM												●						

## Available arbors

Designation	NC arbors	
RM6PCM	040R-16-6-WN04	BT□□-FMC16-□□
	040R-16-7-WN04	
050R-22-8-WN04	BT□□-FMC22-□□	
050R-22-9-WN04		
063R-22-10-WN04		
063R-22-11-WN04		

## Parts

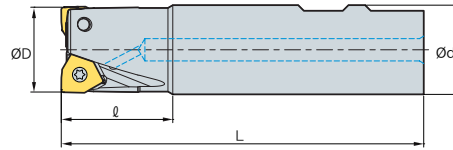
Specification		
Ø40~Ø63	ETNA02506	TW07S

Available inserts E30      Available arbors and bolt E426-E428





# RM6PS-WN04 new



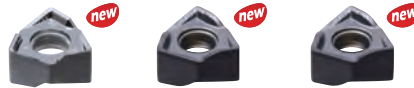
AA  
90°  
• AR: -6°  
• RR: -20°--14°

(mm)

Designation		ØD	Ød	ℓ	L	ap		Available screw
RM6PS	020R-2W20-110-WN04	2	20	20	35	110	0.22	ETNA02506
	020R-3W20-110-WN04	3	20	20	35	110	0.22	ETNA02506
	025R-3W25-110-WN04	3	25	25	35	110	0.36	ETNA02506
	025R-4W25-110-WN04	4	25	25	35	110	0.35	ETNA02506
	032R-5W32-110-WN04	5	32	32	35	110	0.60	ETNA02506
	032R-6W32-110-WN04	6	32	32	35	110	0.60	ETNA02506

## Available inserts

WNGX-MA      WNGX-ML      WNGX-MM



Designation	Cermet		Coated										Uncoated			page	
	CN2500	CN30	NC5330	NCM535	NCM545	PC2505	PC2010	PC3700	PC6510	PC9530	PC9540	PC5300	PC5400	ST30A	G10		H01
WNGX	040304PNFR-MA																●
	040308PNFR-MA																●
	040312PNFR-MA																●
	040316PNFR-MA																●
	040304PNER-ML								●		●	●	●				
	040308PNER-ML											●	●				
	040312PNER-ML											●					
	040316PNER-ML											●					
	040304PNSR-MM								●			●	●				
	040308PNSR-MM											●	●				
	040312PNSR-MM											●					
	040316PNSR-MM											●					

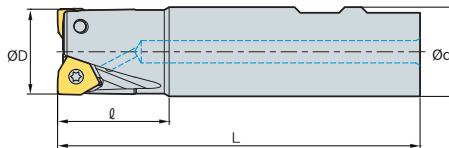
## Parts

Specification		
Ø20~Ø32	ETNA02506	TW07S

Available inserts E30



# RM6PS-WN08 new



(mm)

Designation		ØD	Ød	l	L	ap		Available screw
RM6PS	032R-2W32-120-WN08	2	32	32	40	120	0.65	FTNA0513
	040R-3W32-120-WN08	3	40	32	40	120	0.69	FTNA0513
	040R-4W32-120-WN08	4	40	32	40	120	0.69	FTNA0513
	050R-4W32-120-WN08	4	50	32	40	120	0.76	FTNA0513
	050R-5W32-120-WN08	5	50	32	40	120	0.76	FTNA0513

## Available inserts

WNGX-MA      WNGX-ML      WNGX-MM



Designation	Cermet		Coated											Uncoated			page		
	CN2500	CN30	NC5330	NCM325	NCM335	NCM535	NCM545	PC2505	PC2010	PC3700	PC6510	PC9530	PC9540	PC5300	PC5400	ST30A		G10	H01
WNGX	080604PNFR-MA																	●	E30
	080608PNFR-MA																	●	
	080612PNFR-MA																	●	
	080616PNFR-MA																	●	
	080620PNFR-MA																	●	
	080604PNER-ML									●			●	●	●				
	080608PNER-ML						●			●	●		●	●	●				
	080612PNER-ML														●				
	080616PNER-ML														●				
	080620PNER-ML														●				
	080604PNSR-MM									●					●	●			
	080608PNSR-MM						●			●	●		●	●	●				
	080612PNSR-MM														●				
	080616PNSR-MM														●				
	080620PNSR-MM														●				

## Parts

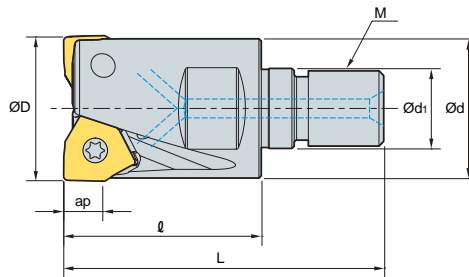
Specification		
Ø32-Ø50	FTNA0513	TW20-100

Available inserts E30





# RM6PM-WN08 new



Designation		ØD	Ød	Ød1	ℓ	L	M	ap	
RM6PM 032R-2-M16-WN08	2	32	29	17	43	69	16	8.2	0.22
040R-3-M16-WN08	3	40	29	17	43	69	16	8.2	0.31
040R-4-M16-WN08	4	40	29	17	43	69	16	8.2	0.30

## Available inserts

WNGX-MA WNGX-ML WNGX-MM



Designation	Cermet		Coated								Uncoated	page	Designation	Cermet		Coated								Uncoated	page									
	CN2500	CN30	NC5330	NCM325	NCM335	NCM335	NCM545	PC2505	PC2010	PC3700	PC6510			PC9530	PC9540	PC5300	PC5400	ST30A	H01	CN2500	CN30	NC5330	NCM325	NCM335		NCM335	NCM545	PC2505	PC2010	PC3700	PC6510	PC9530	PC9540	PC5300
WNGX 040304PNFR-MA																●	WNGX 080604PNFR-MA																	●
040308PNFR-MA																●	080608PNFR-MA																	●
040312PNFR-MA																●	080612PNFR-MA																	●
040316PNFR-MA																●	080616PNFR-MA																	●
040304PNER-ML										●	●	●	●				080620PNFR-MA																	●
040308PNER-ML													●	●			080604PNER-ML									●	●		●	●				
040312PNER-ML													●	●			080608PNER-ML									●	●		●	●				
040316PNER-ML													●	●			080612PNER-ML									●	●		●	●				
040304PNSR-MM										●		●	●				080616PNER-ML																	●
040308PNSR-MM												●	●				080620PNER-ML																	●
040312PNSR-MM												●	●				080604PNSR-MM									●	●		●	●				
040316PNSR-MM												●	●				080608PNSR-MM									●	●		●	●				
																	080612PNSR-MM																	●
																	080616PNSR-MM																	●
																	080620PNSR-MM																	●

## Available adaptor

Designation	Available adaptor
RM6PM 032R-2-M16-WN08	MAT-M16
040R-3-M16-WN08	MAT-M16
040R-4-M16-WN08	MAT-M16

Designation : RM6PM032R-5-M16-WN04  
 Modular head threading measure size (M16)

II

Adaptor spec.: MAT-M16-035-S32S  
 Adaptor threading measure (M16)

## Parts

Specification		
Ø32-Ø40	FTNA0513	TW20-100

Available inserts E30 Available adaptor E401-E402

# RM8AC(M)4000

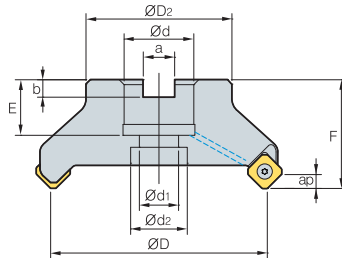
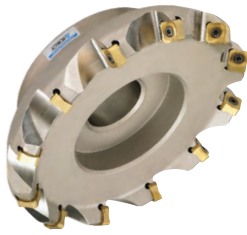


Fig. 1

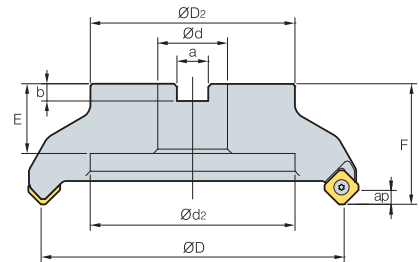


Fig. 2



AA  
45°

- AR: -6°
- RR: -9°~-6°

(mm)

Designation	ØD	ØD2	Ød	Ød1	Ød2	a	b	E	F	ap	kg	Fig.		
RM8ACM	4050HR-M	4	50	49	22	11	18	10.4	6.3	20	40	6.0	0.5	1
	4050HR-H	6	50	49	22	11	18	10.4	6.3	20	40	6.0	0.5	1
	4063HR-M	6	63	49	22	11	18	10.4	6.3	20	40	6.0	0.7	1
	4063HR-H	8	63	49	22	11	18	10.4	6.3	20	40	6.0	0.7	1
RM8AC (RM8ACM)	4080HR	5	80	57	25.4 (27)	14	20	9.5 (12.4)	6(7)	25 (23)	50	6.0	1.2	1
	4080HR-M	7	80	57	25.4 (27)	14	20	9.5 (12.4)	6(7)	25 (23)	50	6.0	1.2	1
	4080HR-H	10	80	57	25.4 (27)	14	20	9.5 (12.4)	6(7)	25 (23)	50	6.0	1.3	1
	4100HR	6	100	67	31.75 (32)	18	26	12.7 (14.4)	8	33 (25.5)	63 (50)	6.0	1.7	1
	4100HR-M	8	100	67	31.75 (32)	18	26	12.7 (14.4)	8	33 (25.5)	63 (50)	6.0	1.7	1
	4100HR-H	12	100	67	31.75 (32)	18	26	12.7 (14.4)	8	33 (25.5)	63 (50)	6.0	1.7	1
	4125HR	8	125	87	38.1 (40)	22	32	15.9 (16.4)	10(9)	36 (30)	63	6.0	3.6	1
	4125HR-M	10	125	87	38.1 (40)	22	32	15.9 (16.4)	10(9)	36 (30)	63	6.0	3.6	1
	4125HR-H	16	125	87	38.1 (40)	22	32	15.9 (16.4)	10(9)	36 (30)	63	6.0	3.7	1
	4160R	10	160	107	50.8 (40)	-	107	19 (16.4)	11(9)	38 (32)	63	6.0	4.8	2
	4160R-M	12	160	107	50.8 (40)	-	107	19 (16.4)	11(9)	38 (32)	63	6.0	5.3	2
	4160R-H	20	160	107	50.8 (40)	-	107	19 (16.4)	11(9)	38 (32)	63	6.0	5.4	2
	4200R-M	14	200	130	47.625 (60)	-	135	25.4 (25.7)	14	38 (32)	63	6.0	7.1	2
	4200R-H	24	200	130	47.625 (60)	-	135	25.4 (25.7)	14	38 (32)	63	6.0	7.1	2
	4250R-M	16	250	180	47.625 (60)	-	180	25.4 (25.7)	14	38 (32)	63	6.0	11.9	2
	4250R-H	30	250	180	47.625 (60)	-	180	25.4 (25.7)	14	38 (32)	63	6.0	12.0	2
4315R	18	315	240	47.625 (60)	-	238	25.4 (25.7)	14	38	63	6.0	18.8 (18.6)	2	
4315R-M	20	315	240	47.625 (60)	-	238	25.4 (25.7)	14	38	63	6.0	18.8 (18.6)	2	
4400R-M	28	400	260	47.625 (60)	-	238	25.4 (25.7)	14	38	80	6.0	37.7 (37.4)	2	

( ) Metric size

## Available inserts

SNM(E)X-MF    SNEX-ML    SNM(E)X-MM    SNEX-MA    SNEX-W



Designation	Cermet		Coated										Uncoated		page			
	CN2500	CN30	NC5330	NCM325	NCM335	NCM635	NCM645	PC2505	PC2010	PC3700	PC6510	PC9530	PC9540	PC5300		PC5400	ST30A	H01
SNEX 1206ANN-MF																		
SNEX 1206ANN-ML																		
SNEX 1206ANN-MM																		E24
SNEX 1206ANN-MA																		E25
SNEX 1206ANN-W																		E26
SNMX 1206ANN-MF																		
SNMX 1206ANN-MM																		

## Available arbors

Designation	Available arbors	
	RM8AC	RM8ACM
RM8ACM 4050HR-□	-	BT□□-FMC22-□□
RM8ACM 4063HR-□	-	BT□□-FMC27-□□
RM8AC 4080HR-□	BT□□-FMA25.4-□□	BT□□-FMC32-□□
RM8AC 4100HR-□	BT□□-FMA31.75-□□	BT□□-FMC32-□□
RM8AC 4125HR-□	BT□□-FMA38.1-□□	BT□□-FMB40-□□
RM8AC 4160R-□	BT□□-FMA50.8-□□	BT□□-FMC40-□□
RM8AC 4200R-□		
RM8AC 4250R-□	BT□□-FMA47.625-□□	BT□□-FMB60-□□
RM8AC 4315R-□		
RM8AC 4400R-□		

## Parts

Specification	Screw	Wrench
Ø50~Ø400	FTKA0410	TW15S

Available inserts E24-E26    Available arbors and bolt E426-E428



# RMH8AC(M)4000

Shim type

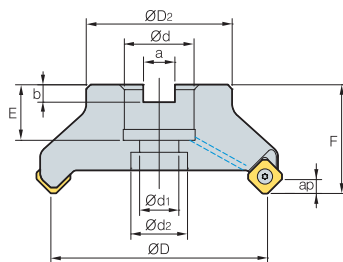


Fig. 1

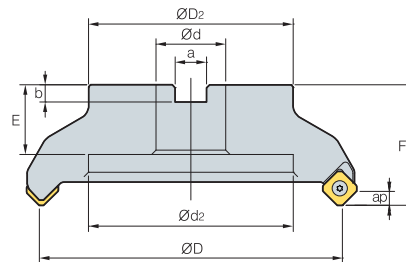


Fig. 2



AA  
45°

- AR: -6°
- RR: -9°~-6°

(mm)

Designation		ØD	ØD2	Ød	Ød1	Ød2	a	b	E	F	ap		Fig.	
<b>RMH8AC</b>	<b>4080HR-M</b>	7	80	57	25.4 (27)	14	20	9.5 (12.4)	6 (7)	25 (23)	50	6.0	1.2	1
<b>(RMH8ACM)</b>	<b>4100HR-M</b>	8	100	67	31.75 (32)	18	26	12.7 (14.4)	8	33 (25.5)	63 (50)	6.0	1.7	1
	<b>4125HR-M</b>	10	125	87	38.1 (40)	22	32	15.9 (16.4)	10 (9)	36 (30)	63	6.0	3.6	1
	<b>4160R-M</b>	12	160	107	50.8 (50)	-	107	19 (16.4)	11 (9)	38 (32)	63	6.0	5.3	2
	<b>4200R-M</b>	14	200	130	47.625 (60)	-	135	25.4 (25.7)	14	38 (32)	63	6.0	7.1	2
	<b>4250R-M</b>	16	250	180	47.625 (60)	-	180	25.4 (25.7)	14	38 (32)	63	6.0	11.9	2
	<b>4315R-M</b>	20	315	240	47.625 (60)	-	238	25.4 (25.7)	14	38	63	6.0	18.8 (18.6)	2
	<b>4400R-M</b>	26	400	260	47.625 (60)	-	238	25.4 (25.7)	14	38	80	6.0	37.7 (37.4)	2

( ) Metric size

## Available inserts

SNM(E)X-MF

SNEX-ML

SNM(E)X-MM

SNEX-MA

SNEX-W



Designation	Cermet		Coated										Uncoated			page			
	CN2500	CN30	NC5330	NCM325	NCM335	NCM635	NCM645	PC2505	PC2010	PC3700	PC6510	PC9530	PC9540	PC5300	PC5400		ST30A	G10	H01
<b>SNEX</b>										●	●			●	●				E24 E25 E26
										●	●	●		●	●				
										●	●			●					
										●	●			●					
<b>SNMX</b>							●			●	●		●	●	●				
							●			●	●		●	●	●				

## Available arbors

Designation	Available arbors	
	RMH8AC	RMH8ACM
<b>RMH8AC</b>	BT□□-FMA25.4-□□	BT□□-FMC27-□□
<b>(RMH8ACM)</b>	BT□□-FMA31.75-□□	BT□□-FMC32-□□
	BT□□-FMA38.1-□□	BT□□-FMB40-□□
	BT□□-FMA50.8-□□	BT□□-FMC40-□□
	BT□□-FMA47.625-□□	BT□□-FMB60-□□

## Parts

Specification				
Ø80-Ø400	FTKA0412B	SS42RM8	SHXN0609F	TW15S

Available inserts E24-E26

Available arbors and bolt E426-E428

# RM8AC(M)5000

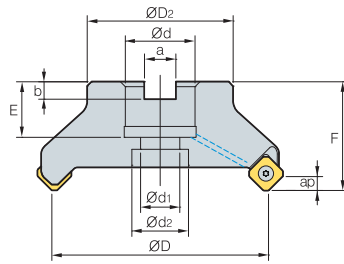


Fig. 1

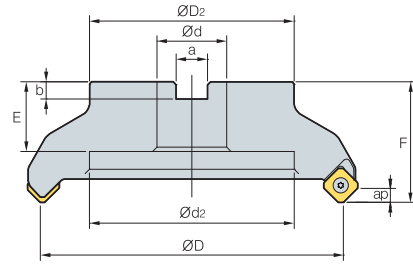


Fig. 2



AA  
45°

- AR: -6°
- RR: -9°~-6°

(mm)

Designation	ØD	ØD2	Ød	Ød1	Ød2	a	b	E	F	ap	$\rho_{kg}$	Fig.	
RM8AC (RM8ACM) 5080HR-M	6	80	57	25.4 (27)	14	20	9.5 (12.4)	6 (7)	25 (23)	50	7.5	1.2	1
5100HR-M	7	100	67	31.75 (32)	18	26	12.7 (14.4)	8.0	33 (25)	63 (50)	7.5	2.5 (1.8)	1
5125HR-M	8	125	87	38.1 (40)	22	32	15.9 (16.4)	10 (9)	35 (30)	63	7.5	3.6	1
5160R-M	10	160	107	50.8 (40)	-	107	19 (16.4)	11 (9)	38 (32)	63	7.5	5 (4.56)	2
5200R-M	12	200	130	47.625 (60)	-	135	25.4 (25.7)	14.0	38	63	7.5	7.1 (6.8)	2
5250R-M	15	250	180	47.625 (60)	-	180	25.4 (25.7)	14.0	38	63	7.5	11.9 (10.6)	2
5315R-M	20	315	240	47.625 (60)	-	238	25.4 (25.7)	14.0	38	63	7.5	19.1 (18.9)	2
5400R-M	28	400	260	47.625 (60)	-	238	25.4 (25.7)	14.0	38	80	7.5	37.7 (37.5)	2

( ) Metric size

## Available inserts

SNM(E)X-MF

SNEX-ML

SNM(E)X-MM



Designation	Cermet		Coated										Uncoated			page				
	CN2500	CN30	NC5330	NCM325	NCM335	NCM535	NCM545	PC2505	PC2010	PC3700	PC6510	PC9530	PC9540	PC5300	PC5400		ST30A	G10	H01	
SNEX 1507ANN-MF											●			●	●				E24	
1507ANN-ML														●	●					E25
1507ANN-MM														●	●					
SNMX 1507ANN-MF						●				●	●			●	●				E26	
1507ANN-MM						●				●	●			●	●					

## Available arbors

Designation	Available arbors	
	RM8AC	RM8ACM
RM8AC (RM8ACM) 5080HR-□	BT□□-FMA25.4-□□	BT□□-FMC27-□□
5100HR-□	BT□□-FMA31.75-□□	BT□□-FMC32-□□
5125HR-□	BT□□-FMA38.1-□□	BT□□-FMB40-□□
5160R-□	BT□□-FMA50.8-□□	BT□□-FMC40-□□
5200R-□		
5250R-□		
5315R-□	BT□□-FMA47.625-□□	BT□□-FMB60-□□
5400R-□		

## Parts

Specification	 Screw	 Wrench
Ø80~Ø400	FTGA0513	TW20-100

Available inserts E24-E26 Available arbors and bolt E426-E428



# RMH8AC(M)5000

Shim type

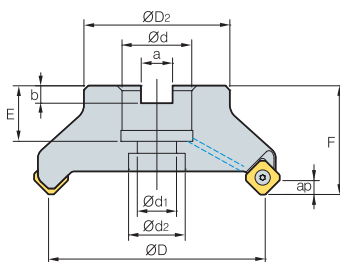


Fig. 1

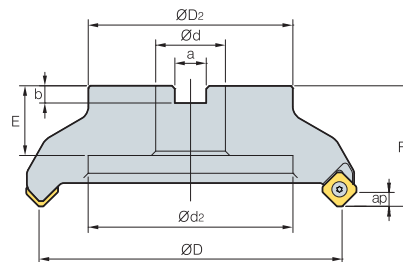


Fig. 2



AA  
45°

- AR: -6°
- RR: -9°--6°

(mm)

Designation	ØD	ØD2	Ød	Ød1	Ød2	a	b	E	F	ap	$\frac{V_c}{m/s}$	Fig.	
<b>RMH8AC (RMH8ACM)</b> 5080HR-M	6	80	57	25.4 (27)	14	20	9.5 (12.4)	6 (7)	25 (23)	50	7.5	1.2	1
5100HR-M	7	100	67	31.75 (32)	18	26	12.7 (14.4)	8.0	33 (25)	63 (50)	7.5	2.5 (1.8)	1
5125HR-M	8	125	87	38.1 (40)	22	32	15.9 (16.4)	10 (9)	36 (30)	63	7.5	3.6	1
5160R-M	10	160	107	50.8 (40)	-	107	19 (16.4)	11 (9)	38 (32)	63	7.5	5 (4.56)	2
5200R-M	12	200	130	47.625 (60)	-	135	25.4 (25.7)	14.0	38 (32)	63	7.5	7.1 (6.8)	2
5250R-M	15	250	180	47.625 (60)	-	180	25.4 (25.7)	14.0	38 (32)	63	7.5	11.9 (10.6)	2
5315R-M	20	315	240	47.625 (60)	-	238	25.4 (25.7)	14.0	38	63	7.5	19.1 (18.9)	2
5400R-M	22	400	260	47.625 (60)	-	238	25.4 (25.7)	14.0	38	80	7.5	37.7 (37.5)	2

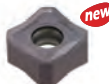
( ) Metric size

## Available inserts

SNM(E)X-MF

SNEX-ML

SNM(E)X-MM



Designation	Cermet		Coated											Uncoated			page			
	CN2500	CN30	NC5330	NCM325	NCM335	NCM535	NCM545	PC2505	PC2010	PC3700	PC6510	PC9530	PC9540	PC5300	PC5400	ST30A		G10	H01	
SNEX 1507ANN-MF											●			●	●				E24	
1507ANN-ML														●	●					E25
1507ANN-MM											●			●	●					
SNMX 1507ANN-MF						●				●	●			●	●				E26	
1507ANN-MM						●				●	●			●	●					

## Available arbors

Designation	Available arbors	
	RMH8AC	RMH8ACM
RMH8AC (RMH8ACM) 5080HR-□	BT□□-FMA25.4-□□	BT□□-FMC27-□□
5100HR-□	BT□□-FMA31.75-□□	BT□□-FMC32-□□
5125HR-□	BT□□-FMA38.1-□□	BT□□-FMB40-□□
5160R-□	BT□□-FMA50.8-□□	BT□□-FMC40-□□
5200R-□		
5250R-□		
5315R-□	BT□□-FMA47.625-□□	BT□□-FMB60-□□
5400R-□		

## Parts

Specification	 Screw	 Shim	 Shim Screw	 Wrench
Ø80-Ø400	FTGA0513	SS53RM8	SHXN0712F	TW20-100

Available inserts E24-E26

Available arbors and bolt E426-E428

# RM8EC(M)4000

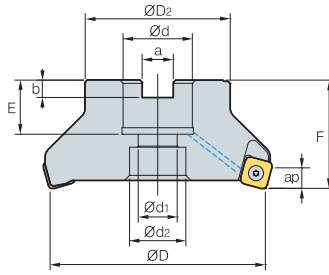


Fig. 1

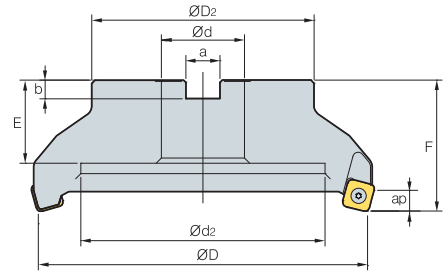


Fig. 2



AA  
75°

- AR: -6°
- RR: -8°~-6°

(mm)

Designation	⊙	ØD	ØD2	Ød	Ød1	Ød2	a	b	E	F	ap	$\frac{W}{kg}$	Fig.
RM8ECM 4050HR-M	4	50	49	22	11	18	10.4	6.3	20	40	9.0	0.4	1
4063HR-M	6	63	49	22	11	18	10.4	6.3	20	40	9.0	0.6	1
RM8EC (RM8ECM) 4080HR	5	80	57	25.4 (27)	14	20	9.5 (12.4)	6 (7)	25 (23)	50	9.0	1.2	1
4080HR-M	7	80	57	25.4 (27)	14	20	9.5 (12.4)	6 (7)	25 (23)	50	9.0	1.1	1
4100HR	6	100	67	31.75 (32)	18	26	12.7 (14.4)	8	33 (25)	63 (50)	9.0	1.6	1
4100HR-M	8	100	67	31.75 (32)	18	26	12.7 (14.4)	8	33 (25)	63 (50)	9.0	2.5	1
4125HR	8	125	87	38.1 (40)	22	32	15.9 (16.4)	10 (9)	35 (29)	63	9.0	2.9 (3.3)	1
4125HR-M	10	125	87	38.1 (40)	22	32	15.9 (16.4)	10 (9)	35 (29)	63	9.0	3.0	1
4160R	10	160	107	50.8 (40)	-	107	19 (16.4)	11 (9)	38 (32)	63	9.0	4.4	2
4160R-M	12	160	107	50.8 (40)	-	107	19 (16.4)	11 (9)	38 (32)	63	9.0	4.0	2
4200R-M	16	200	130	47.625 (60)	-	135	25.4 (25.7)	14	38 (32)	63	9.0	5.9	2
4250R-M	16	250	180	47.625 (60)	-	180	25.4 (25.7)	14	38	63	9.0	10.9 (10.6)	2
4315R-M	20	315	240	47.625 (60)	-	238	25.4 (25.7)	14	38	63	9.0	18.1 (17.9)	2
4400R-M	28	400	260	47.625 (60)	-	238	25.4 (25.7)	14	38	80	9.0	31.8 (31.5)	2

## Available inserts

( ) Metric size

SNM(E)X-MF

SNEX-ML

SNM(E)X-MM

SNEX-MA



Designation	Cermet		Coated										Uncoated			page			
	CN2500	CN30	NC5330	NCM325	NCM335	NCM535	NCM545	PC2505	PC2010	PC3700	PC6510	PC9530	PC9540	PC5300	PC5400		ST30A	G10	H01
SNEX 1206ENN-MF											●			●	●				E24 E25 E26
1206ENN-ML											●			●	●				
1206ENN-MM											●			●	●				
1206ENN-MA											●			●	●			●	
SNMX 1206ENN-MF						●				●	●		●	●	●				
1206ENN-MM						●				●	●		●	●	●				

## Available arbors

Designation	NC arbors	
	RM8EC	RM8ECM
RM8ECM 4050HR-□	-	BT□□-FMC22-□□
4063HR-□		
RM8EC 4080HR-□	BT□□-FMA25.4-□□	BT□□-FMC27-□□
(RM8ECM) 4100HR-□	BT□□-FMA31.75-□□	BT□□-FMC32-□□
4125HR-□	BT□□-FMA38.1-□□	BT□□-FMB40-□□
4160R-□	BT□□-FMA50.8-□□	BT□□-FMC40-□□
4200R-□		
4250R-□		
4315R-□	BT□□-FMA47.625-□□	BT□□-FMB60-□□
4400R-□		

## Parts

Specification	 Screw	 Wrench
Ø50~Ø400	PTKA0411-R3	TW15S

Available inserts E24-E26 Available arbors and bolt E426-E428





# RMH8EC(M)4000

Shim type

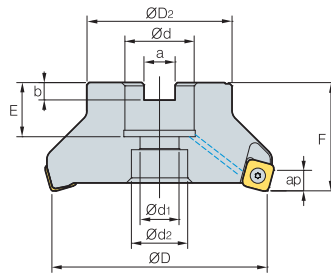


Fig. 1

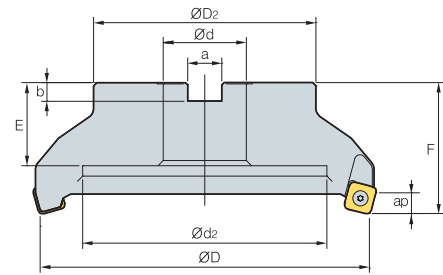


Fig. 2



AA  
75°

- AR: -6°
- RR: -8°~-6°

(mm)

Designation	ØD	ØD2	Ød	Ød1	Ød2	a	b	E	F	ap	$\frac{R}{r}$	Fig.	
<b>RMH8EC (RMH8ECM)</b> 4080HR-M	7	80	57	25.4 (27)	14	20	9.5 (12.4)	6 (7)	25 (23)	50	9.0	1.1	1
4100HR-M	8	100	67	31.75 (32)	18	26	12.7 (14.4)	8	33 (25.5)	63 (50)	9.0	2.5	1
4125HR-M	10	125	87	38.1 (40)	22	32	15.9 (16.4)	10 (9)	36 (30)	63	9.0	3.0	1
4160R-M	12	160	107	50.8 (40)	-	107	19 (16.4)	11 (9)	38 (32)	63	9.0	4.0	2
4200R-M	16	200	130	47.625 (60)	-	135	25.4 (25.7)	14	38 (32)	63	9.0	5.9	2
4250R-M	16	250	180	47.625 (60)	-	180	25.4 (25.7)	14	38 (32)	63	9.0	10.9 (10.6)	2
4315R-M	20	315	240	47.625 (60)	-	238	25.4 (25.7)	14	38	63	9.0	18.1 (17.9)	2
4400R-M	24	400	260	47.625 (60)	-	238	25.4 (25.7)	14	38	80	9.0	31.8 (31.5)	2

( ) Metric size

## Available inserts

SNM(E)X-MF

SNEX-ML

SNM(E)X-MM

SNEX-MA



Designation	Cermet		Coated										Uncoated			page			
	CN2500	CN30	NC5330	NCM325	NCM335	NCM535	NCM545	PC2505	PC2010	PC3700	PC6510	PC9530	PC9540	PC5300	PC5400		ST30A	G10	H01
<b>SNEX</b> 1206ENN-MF											●			●	●				E24 E25 E26
1206ENN-ML											●			●	●				
1206ENN-MM											●			●	●				
1206ENN-MA											●			●	●			●	
<b>SNMX</b> 1206ENN-MF						●				●	●		●	●	●				
1206ENN-MM						●				●	●		●	●	●				

## Available arbors

Designation	Available arbors	
	RMH8EC	RMH8ECM
<b>RMH8EC (RMH8ECM)</b> 4080HR-□	BT□□-FMA25.4-□□	BT□□-FMC27-□□
4100HR-□	BT□□-FMA31.75-□□	BT□□-FMC32-□□
4125HR-□	BT□□-FMA38.1-□□	BT□□-FMB40-□□
4160R-□	BT□□-FMA50.8-□□	BT□□-FMC40-□□
4200R-□		
4250R-□	BT□□-FMA47.625-□□	BT□□-FMB60-□□
4315R-□		
4400R-□		

## Parts

Specification	 Screw	 Shim	 Shim Screw	 Wrench
Ø80-Ø400	PTKA0411-R3	SS42RM8	SHXN0609F	TW15S

Available inserts E24-E26

Available arbors and bolt E426-E428

# RM8EC(M)5000

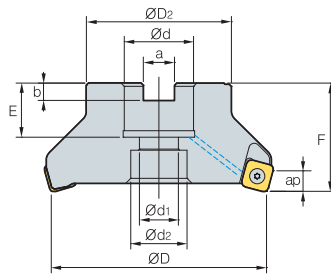


Fig. 1

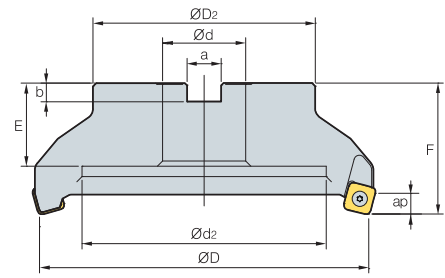


Fig. 2



AA  
75°

- AR: -6°
- RR: -8°~ -6°

(mm)

Designation	ØD	ØD2	Ød	Ød1	Ød2	a	b	E	F	ap	kg	Fig.	
RM8EC (RM8ECM) 5080HR-M	6	80	57	25.4 (27)	14	20	9.5 (12.4)	6 (7)	25 (23)	50	11.0	1.1	1
5100HR-M	7	100	67	31.75 (32)	18	26	12.7 (14.4)	8.0	33 (25)	63 (50)	11.0	2.1 (1.7)	1
5125HR-M	8	125	87	38.1 (40)	22	32	15.9 (16.4)	10 (9)	35 (30)	63	11.0	3.4 (3.3)	1
5160R-M	10	160	107	50.8 (40)	-	107	19 (16.4)	11 (9)	38 (32)	63	11.0	4.4 (4.1)	2
5200R-M	12	200	130	47.625 (60)	-	135	25.4 (25.7)	14.0	38	63	11.0	6.4 (6.1)	2
5250R-M	15	250	180	47.625 (60)	-	180	25.4 (25.7)	14.0	38	63	11.0	11.0 (10.7)	2
5315R-M	20	315	240	47.625 (60)	-	238	25.4 (25.7)	14.0	38	63	11.0	18.0 (17.7)	2
5400R-M	28	400	260	47.625 (60)	-	238	25.4 (25.7)	14.0	38	80	11.0	35.7 (35.4)	2

( ) Metric size

## Available inserts

SNM(E)X-MF      SNEX-ML      SNM(E)X-MM



Designation	Cermet		Coated										Uncoated			page			
	CN2500	CN30	NC5330	NCM325	NCM335	NCM535	NCM545	PC2505	PC2010	PC3700	PC6510	PC9530	PC9540	PC5300	PC5400		ST30A	G10	H01
SNEX 1507ENN-MF											●			●	●				E24
1507ENN-ML														●	●				
1507ENN-MM														●	●				
SNMX 1507ENN-MF						●				●	●			●	●				E26
1507ENN-MM						●				●	●			●	●				

## Available arbors

Designation	Available arbors	
	RM8EC	RM8ECM
RM8EC (RM8ECM) 5080HR-□	BT□□-FMA25.4-□□	BT□□-FMC27-□□
5100HR-□	BT□□-FMA31.75-□□	BT□□-FMC32-□□
5125HR-□	BT□□-FMA38.1-□□	BT□□-FMB40-□□
5160R-□	BT□□-FMA50.8-□□	BT□□-FMC40-□□
5200R-□		
5250R-□	BT□□-FMA47.625-□□	BT□□-FMB60-□□
5315R-□		
5400R-□		

## Parts

Specification	Screw	Wrench
Ø80~Ø400	FTGA0513	TW20-100

Available inserts E24~E26      Available arbors and bolt E426~E428



# RMH8EC(M)5000

Shim type

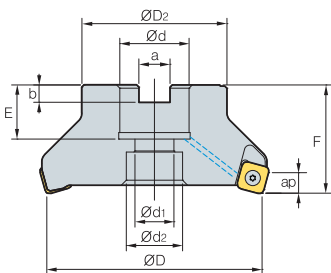


Fig. 1

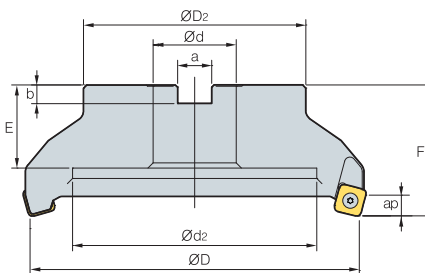


Fig. 2



AA  
75°

- AR: -6°
- RR: -8°~-6°

(mm)

Designation	⊙	ØD	ØD <sub>2</sub>	Ød	Ød <sub>1</sub>	Ød <sub>2</sub>	a	b	E	F	ap	kg	Fig.	
RMH8EC (RMH8ECM)	6080HR-M	6	80	57	25.4 (27)	14	20	9.5 (12.4)	6 (7)	25 (23)	50	11.0	1.1	1
	5100HR-M	7	100	67	31.75 (32)	18	26	12.7 (14.4)	8.0	33 (25.5)	63 (50)	11.0	2.1 (1.7)	1
	5125HR-M	8	125	87	38.1 (40)	22	32	15.9 (16.4)	10 (9)	36 (30)	63	11.0	3.4 (3.3)	1
	5160HR-M	10	160	107	50.8 (60)	-	107	19 (16.4)	11 (9)	38 (32)	63	11.0	4.4 (4.1)	2
	5200R-M	12	200	130	47.625 (60)	-	135	25.4 (25.7)	14.0	38 (32)	63	11.0	6.4 (6.1)	2
	5250R-M	15	250	180	47.625 (60)	-	180	25.4 (25.7)	14.0	38 (32)	63	11.0	110 (10.7)	2
	5315R-M	20	315	240	47.625 (60)	-	238	25.4 (25.7)	14.0	38	63	11.0	18.0 (17.7)	2
	5400R-H	22	400	260	47.625 (60)	-	238	25.4 (25.7)	14.0	38	80	11.0	35.7 (35.4)	2

( ) Metric size

## Available inserts

SNM(E)X-MF

SNEX-ML

SNM(E)X-MM



Designation	Cermet		Coated											Uncoated			page		
	CN2500	CN30	NC5330	NCM325	NCM335	NCM535	NCM545	PC2505	PC2010	PC3700	PC6510	PC9530	PC9540	PC5300	PC5400	ST30A		G10	H01
SNEX	1507ENN-MF										●				●	●			E24 E25
	1507ENN-ML														●	●			
	1507ENN-MM										●				●	●			
SNMX	1507ENN-MF					●				●	●				●	●			E26
	1507ENN-MM					●				●	●				●	●			

## Available arbors

Designation	Available arbors	
	RMH8EC	RMH8ECM
RMH8EC (RMH8ECM) 5080HR-□	BT□□-FMA25.4-□□	BT□□-FMC27-□□
5100HR-□	BT□□-FMA31.75-□□	BT□□-FMC32-□□
5125HR-□	BT□□-FMA38.1-□□	BT□□-FMB40-□□
5160R-□	BT□□-FMA50.8-□□	BT□□-FMC40-□□
5200R-□		
5250R-□	BT□□-FMA47.625-□□	BT□□-FMB60-□□
5315R-□		
5400R-□		

## Parts

Specification	 Screw	 Shim	 Shim Screw	 Wrench
Ø80-Ø400	FTGA0513	SS53RM8	SHXN0712F	TW20-100

Available inserts E24-E26

Available arbors and bolt E426-E428

# RM8QC(M)4000

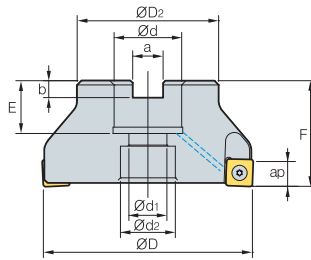


Fig. 1

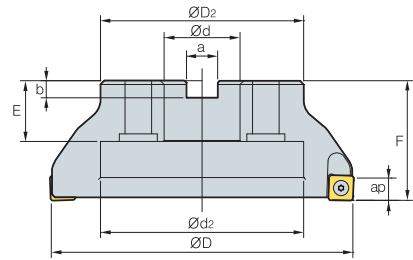


Fig. 2



AA  
88°

- AR: -6°
- RR: -8°~ -6°

(mm)

Designation		ØD	ØD2	Ød	Ød1	Ød2	a	b	E	F	ap		Fig.
RM8QCM 4063HR-M	6	63	49	22	11	18	10.4	6.3	20	40	11.5	0.6	1
4063HR-H	8	63	49	22	11	18	10.4	6.3	20	40	11.5	0.6	1
RM8QC (RM8QCM) 4080HR-M	7	80	57	25.4 (27)	14	20	9.5 (12.4)	6 (7)	25 (23)	50	11.5	1.1	1
4080HR-H	10	80	57	25.4 (27)	14	20	9.5 (12.4)	6 (7)	25 (23)	50	11.5	1.0	1
4100HR-M	8	100	67	31.75 (32)	18	26	12.7 (14.4)	8	33 (25.5)	63 (50)	11.5	1.7	1
4100HR-H	12	100	67	31.75 (32)	18	26	12.7 (14.4)	8	33 (25.5)	63 (50)	11.5	1.6	1
4125HR-M	10	125	87	38.1 (40)	22	32	15.9 (16.4)	10 (9)	36 (30)	63	11.5	3.3	1
4125HR-H	14	125	87	38.1 (40)	22	32	15.9 (16.4)	10 (9)	36 (30)	63	11.5	3.3	1
4160R-M	12	160	107	50.8 (40)	-	107	19 (16.4)	11 (9)	38 (32)	63	11.5	3.9	2
4160R-H	18	160	107	50.8 (40)	-	107	19 (16.4)	11 (9)	38 (32)	63	11.5	3.9	2
4200R-M	14	200	130	47.625 (60)	-	135	25.4 (25.7)	14	38 (32)	63	11.5	6.4	2
4200R-H	22	200	130	47.625 (60)	-	135	25.4 (25.7)	14	38 (32)	63	11.5	6.4	2

( ) Metric size

## Available inserts

SNM(E)X-MF

SNEX-ML

SNM(E)X-MM

SNEX-MA



Designation	Cermet		Coated										Uncoated			page		
	CN2500	CN30	NC5330	NCM325	NCM335	NCM535	NCM545	PC2505	PC2010	PC3700	PC6510	PC9530	PC9540	PC5300	PC5400		ST30A	G10
SNEX 1206QNN-MF										●	●			●	●			
1206QNN-ML														●	●			
1206QNN-MM														●	●			
1206QNN-MA																		●
120612-MF											●			●	●			
120612-ML														●	●			
120612-MM											●							
120612-MA																		●
SNMX 1206QNN-MF						●				●	●			●	●			
1206QNN-MM						●				●	●			●	●			
120612-MF											●			●	●			
120612-MM											●			●	●			

## Available arbors

Designation	Available arbors	
	RM8QC	RM8QCM
RM8QCM 4063HR-□	-	BT□□-FMC22-□□
RM8QC 4080HR-□	BT□□-FMA25.4-□□	BT□□-FMC27-□□
(RM8QCM) 4100HR-□	BT□□-FMA31.75-□□	BT□□-FMC32-□□
4125HR-□	BT□□-FMA38.1-□□	BT□□-FMB40-□□
4160R-□	BT□□-FMA50.8-□□	BT□□-FMC40-□□
4200R-□	BT□□-FMA47.625-□□	BT□□-FMB60-□□

## Parts

Specification		
Ø63~Ø200	PTKA0411-R3	TW15S

Available inserts E24-E26 Available arbors and bolt E426-E428



# RMH8QC(M)4000

Shim type

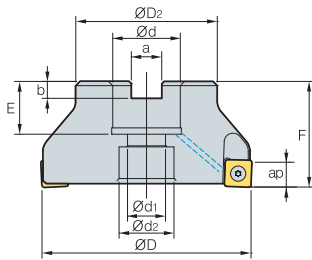


Fig. 1

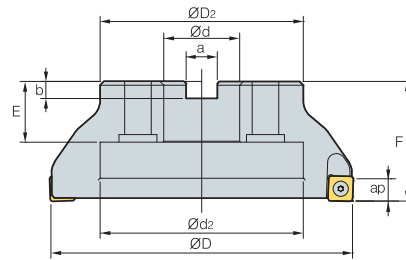


Fig. 2



(mm)

Designation	ØD	ØD2	Ød	Ød1	Ød2	a	b	E	F	ap	$r_{ts}$	Fig.		
RMH8QC (RMH8QCM)	4080HR-M	7	80	57	25.4 (27)	14	20	9.5 (12.4)	6 (7)	25 (23)	50	11.5	1.1	1
	4100HR-M	8	100	67	31.75 (32)	18	26	12.7 (14.4)	8	33 (25.5)	63 (50)	11.5	2.5	1
	4125HR-M	10	125	87	38.1 (40)	22	32	15.9 (16.4)	10 (9)	36 (30)	63	11.5	3.0	1
	4160R-M	12	160	107	50.8 (40)	-	107	19 (16.4)	11 (9)	38 (32)	63	11.5	4.0	2
	4200R-M	16	200	130	47.625 (60)	-	135	25.4 (25.7)	14	38 (32)	63	11.5	5.9	2

( ) Metric size

## Available inserts

SNM(E)X-MF    SNEX-ML    SNM(E)X-MM    SNEX-MA



Designation	Cermet		Coated										Uncoated			page			
	CN2500	CN30	NC5330	NCM325	NCM335	NCM535	NCM545	PC2505	PC2010	PC3700	PC6510	PC9530	PC9540	PC5300	PC5400		ST30A	G10	H01
SNEX	1206QNN-MF									●	●			●	●				E24 E25 E26
	1206QNN-ML													●	●				
	1206QNN-MM										●			●	●				
	1206QNN-MA																	●	
	120612-MF										●			●	●				
	120612-ML													●	●				
	120612-MM											●							
120612-MA																	●		
SNMX	1206QNN-MF					●				●	●			●	●				
	1206QNN-MM					●				●	●		●	●					
	120612-MF									●	●			●	●				
	120612-MM									●	●			●	●				

## Available arbors

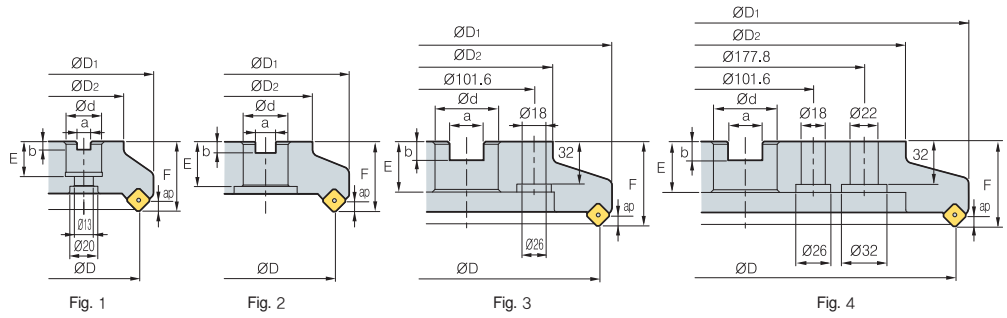
Designation	Available arbors	
	RMH8QC	RMH8QCM
RMH8QC 4080HR-□	BT□□-FMA25.4-□□	BT□□-FMC27-□□
(RMH8QCM) 4100HR-□	BT□□-FMA31.75-□□	BT□□-FMC32-□□
4125HR-□	BT□□-FMA38.1-□□	BT□□-FMB40-□□
4160R-□	BT□□-FMA50.8-□□	BT□□-FMC40-□□
4200R-□	BT□□-FMA47.625-□□	BT□□-FMB60-□□

## Parts

Specification	Screw	Shim	Shim Screw	Wrench
Ø80-Ø200	PTKA0411-R3	SS42RM8	SHXN0609F	TW15S

Available inserts E24-E26    Available arbors and bolt E426-E428

# RMT8A(M)4000



AA  
45°  
•AR: -6°  
•RR: -6°

(mm)

Designation	ØD	ØD1	ØD2	Ød	a	b	E	F	ap	kg	Fig.		
RMT8A (RMT8AM)	4080R	5	80	100	57	25.4 (27)	9.5 (12.4)	6 (7)	25 (22)	50	4	1.6	1
	4080R-M	6	80	100	57	25.4 (27)	9.5 (12.4)	6 (7)	25 (22)	50	4	1.6	1
	4100R	6	100	120	70	31.75 (32)	12.7 (14.4)	8 (8)	32 (28)	50	4	2.3	2
	4100R-M	8	100	120	70	31.75 (32)	12.7 (14.4)	8 (8)	32 (28)	50	4	2.3	2
	4125R	8	125	144	87	38.1 (40)	15.9 (16.4)	10 (9)	38 (30)	63	4	4.3	2
	4125R-M	10	125	144	87	38.1 (40)	15.9 (16.4)	10 (9)	38 (30)	63	4	4.3	2
	4160R	10	160	179	110	50.8 (40)	19.0 (16.4)	11 (9)	38 (30)	63	4	6.5	2
	4160R-M	14	160	179	110	50.8 (40)	19.0 (16.4)	11 (9)	38 (30)	63	4	6.5	2
	4200R	12	200	219	130	47.625 (60)	25.4 (25.7)	14 (14)	38 (38)	63	4	8.8	3
	4200R-M	18	200	219	130	47.625 (60)	25.4 (25.7)	14 (14)	38 (38)	63	4	8.8	3
	4250R	16	250	269	180	47.625 (60)	25.4 (25.7)	14 (14)	38 (38)	63	4	14.1	3
	4250R-M	22	250	269	180	47.625 (60)	25.4 (25.7)	14 (14)	38 (38)	63	4	14.1	3
	4315R	20	315	334	240	47.625 (60)	25.4 (25.7)	14 (14)	38 (38)	63	4	22.3	4
	4315R-M	28	315	334	240	47.625 (60)	25.4 (25.7)	14 (14)	38 (38)	63	4	22.3	4

## Available inserts

( ) Metric size

SNC(M)F-MF      SNC(M)F-MM



Designation	Cermet		Coated										Uncoated			page			
	CN2500	CN30	NC5330	NCM325	NCM335	NCM635	NCM645	PC2505	PC2010	PC3700	PC6510	PC9530	PC9540	PC5300	PC5400		ST30A	G10	H01
SNCF	1206ANN-MF																		E22
	1206ANN-MM																		
SNMF	1206ANN-MF																		E23
	1206ANN-MM																		

## Available arbors

Designation	General arbors	NC arbors		
		RMT8A	RMT8AM	
RMT8A (RMT8AM)	□080R	NT*□□(M/U)-FMA25.4-25	BT**□□-FMA25.4-□□	FMC27
	□100R	NT*□□(M/U)-FMA31.75-□□	BT**□□-FMA31.75-□□	FMC32
	□125R	NT*□□(M/U)-FMA38.1-□□	BT**□□-FMA38.1-□□	FMB40
	□160R	NT*□□(M/U)-FMA50.8-□□	BT**□□-FMA50.8-□□	
	□200R	NT*□□(M/U)-FMA47.625-25, KCP-8***	BT**□□-FMA47.625-□□	FMB60
	□250R			
□315R	KCP-8*** (Center ring plug)	-	-	

\*□□-NT number    \*\*□□-BT number    \*\*\*Over milling 5

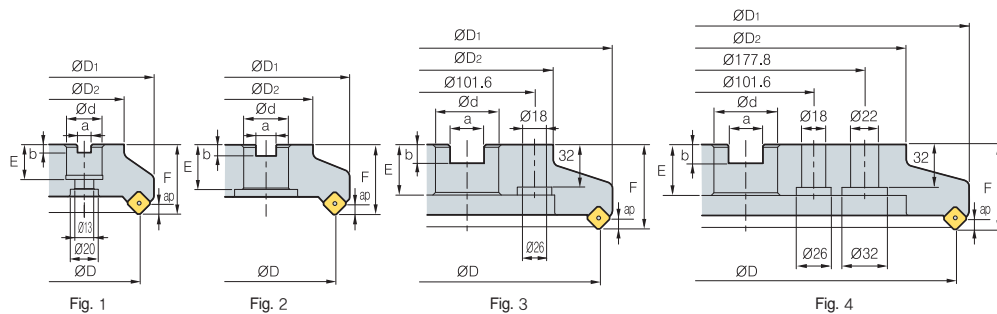
## Parts

Specification					
Ø80~Ø315	ETKA0523	KHB0417	SPR0315	LTC05SR-RM4	TW20-100

Available inserts E22, E23    Available arbors and bolt E426-E428



# RMT8A(M)5000



(mm)

Designation	⊙	ØD	ØD1	ØD2	Ød	a	b	E	F	ap	$\frac{\sigma}{kg}$	Fig.
<b>RMT8A (RMT8AM) 5080R</b>	5	80	104	57	25.4 (27)	9.5 (12.4)	6 (7)	25 (22)	50	6	1.8	1
<b>5080R-M</b>	6	80	104	57	25.4 (27)	9.5 (12.4)	6 (7)	25 (22)	50	6	1.8	1
<b>5100R</b>	6	100	124	70	31.75 (32)	12.7 (14.4)	8 (8)	32 (28)	50	6	2.6	2
<b>5100R-M</b>	8	100	124	70	31.75 (32)	12.7 (14.4)	8 (8)	32 (28)	50	6	2.6	2
<b>5125R</b>	8	125	149	87	38.1 (40)	15.9 (16.4)	10 (9)	38 (30)	63	6	4.3	2
<b>5125R-M</b>	10	125	149	87	38.1 (40)	15.9 (16.4)	10 (9)	38 (30)	63	6	4.3	2
<b>5160R</b>	10	160	184	110	50.8 (40)	19.0 (16.4)	11 (9)	38 (30)	63	6	6.5	2
<b>5160R-M</b>	14	160	184	110	50.8 (40)	19.0 (16.4)	11 (9)	38 (30)	63	6	6.5	2
<b>5200R</b>	12	200	224	130	47.625 (60)	25.4 (25.7)	14 (14)	38 (38)	63	6	9.0	3
<b>5200R-M</b>	18	200	224	130	47.625 (60)	25.4 (25.7)	14 (14)	38 (38)	63	6	9.0	3
<b>5250R</b>	16	250	274	180	47.625 (60)	25.4 (25.7)	14 (14)	38 (38)	63	6	14.4	3
<b>5250R-M</b>	22	250	274	180	47.625 (60)	25.4 (25.7)	14 (14)	38 (38)	63	6	14.4	3
<b>5315R</b>	20	315	339	240	47.625 (60)	25.4 (25.7)	14 (14)	38 (38)	63	6	22.2	4
<b>5315R-M</b>	28	315	339	240	47.625 (60)	25.4 (25.7)	14 (14)	38 (38)	63	6	22.2	4

## Available inserts

( ) Metric size

SNC(M)F-MF      SNC(M)F-MM



Designation	Cermet		Coated										Uncoated			page		
	CN2500	CN30	NC5330	NCM325	NCM335	NCM535	NCM545	PC2505	PC2010	PC3700	PC6510	PC9530	PC9540	PC5300	PC5400		ST30A	G10
<b>SNCF 1507ANN-MF</b>											●							
<b>1507ANN-MM</b>																		
<b>SNMF 1507ANN-MF</b>																		E22
<b>1507ANN-MM</b>																		E23

## Available arbors

Designation	General arbors	NC arbors	
		RMT8A	RMT8AM
<b>RMT8A (RMT8AM) □080R</b>	NT*□□(M/U)-FMA25.4-25	BT**□□-FMA25.4-□□	FMC27
<b>□100R</b>	NT*□□(M/U)-FMA31.75-□□	BT**□□-FMA31.75	FMC32
<b>□125R</b>	NT*□□(M/U)-FMA38.1-□□	BT**□□-FMA38.1	FMB40
<b>□160R</b>	NT*□□(M/U)-FMA50.8-□□	BT**□□-FMA50.8	
<b>□200R</b>	NT*□□(M/U)-FMA47.625-25,	BT**□□-FMA47.625-□□	FMB60
<b>□250R</b>	KCP-8***		
<b>□315R</b>	KCP-8*** (Center ring plug)	-	-

\*□□-NT number    \*\*□□-BT number    \*\*\*Over milling 5

## Parts

Specification					
Ø80-Ø315	ETKA0625	KHB0417	SPR0415	LTC06SR-RM5	TW20-100

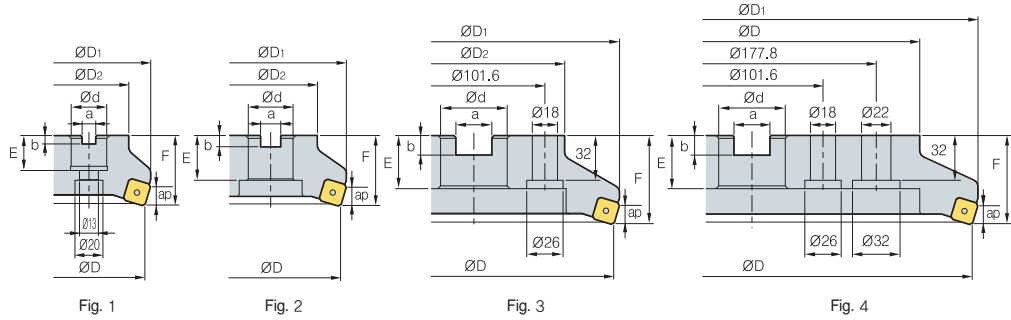
Available inserts E22, E23

Available arbors and bolt E426-E428





# RMT8E(M)4000



AA  
75°  
•AR: -6°  
•RR: -8°~-6°

(mm)

Designation	ØD	ØD1	ØD2	Ød	a	b	E	F	ap	kg	Fig.	
RMT8E (RMT8EM) 4080R	5	80	100	57	25.4 (27)	9.5 (12.4)	6 (7)	25 (22)	50	5	1.5	1
4080R-M	6	80	100	57	25.4 (27)	9.5 (12.4)	6 (7)	25 (22)	50	5	1.5	1
4100R	6	100	120	67	31.75 (32)	12.7 (14.4)	8 (8)	32 (28)	50	5	2	2
4100R-M	8	100	120	67	31.75 (32)	12.7 (14.4)	8 (8)	32 (28)	50	5	2	2
4125R	8	125	144	87	38.1 (40)	15.9 (16.4)	10 (9)	38 (30)	63	5	3.8	2
4125R-M	10	125	144	87	38.1 (40)	15.9 (16.4)	10 (9)	38 (30)	63	5	3.8	2
4160R	10	160	179	107	50.8 (40)	19.0 (16.4)	11 (9)	38 (30)	63	5	5.8	2
4160R-M	14	160	179	107	50.8 (40)	19.0 (16.4)	11 (9)	38 (30)	63	5	5.8	2
4200R	12	200	219	130	47.625 (60)	25.4 (25.7)	14 (14)	38 (38)	63	5	7.9	3
4200R-M	18	200	219	130	47.625 (60)	25.4 (25.7)	14 (14)	38 (38)	63	5	7.9	3
4250R	16	250	269	180	47.625 (60)	25.4 (25.7)	14 (14)	38 (38)	63	5	13.0	3
4250R-M	22	250	269	180	47.625 (60)	25.4 (25.7)	14 (14)	38 (38)	63	5	13.0	3
4315R	20	315	334	240	47.625 (60)	25.4 (25.7)	14 (14)	38 (38)	63	5	20.5	4
4315R-M	28	315	334	240	47.625 (60)	25.4 (25.7)	14 (14)	38 (38)	63	5	20.5	4

## Available inserts

( ) Metric size

SNC(M)F-MF      SNC(M)F-MM



Designation	Cermet		Coated										Uncoated			page			
	CN2500	CN30	NC5330	NCM325	NCM335	NCM635	NCM645	PC2505	PC2010	PC3700	PC6510	PC9530	PC9540	PC5300	PC5400		ST30A	G10	H01
SNCF 1206ENN-MF											●								E22
1206ENN-MM																			
SNMF 1206ENN-MF										●									E23
1206ENN-MM										●									

## Available arbors

Designation	General arbors	NC arbors	
		RMT8E	RMT8EM
RMT8E (RMT8EM) □080R	NT*□□(M/U)-FMA25.4-25	BT**□□-FMA25.4-□□	FMC27
□100R	NT*□□(M/U)-FMA31.75-□□	BT**□□-FMA31.75-□□	FMC32
□125R	NT*□□(M/U)-FMA38.1-□□	BT**□□-FMA38.1-□□	FMB40
□160R	NT*□□(M/U)-FMA50.8-□□	BT**□□-FMA50.8-□□	
□200R	NT*□□(M/U)-FMA47.625-25, KCP-8***	BT**□□-FMA47.625-□□	FMB60
□250R			
□315R	KCP-8*** (Center ring plug)	-	-

\*□□-NT number    \*\*□□-BT number    \*\*\*Over milling 5

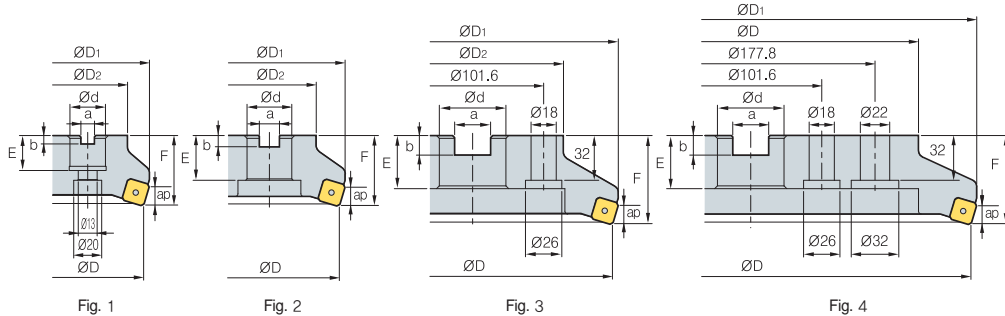
## Parts

Specification	Screw	Screw	Spring	Latch	Wrench
Ø80~Ø315	ETKA0523	KHB0417	SPR0315	LTC05SR-RM4	TW20-100

Available inserts E22, E23      Available arbors and bolt E426-E428



# RMT8E(M)5000



AA  
75°

- AR: -6°
- RR: -8°~-6°

(mm)

Designation		ØD	ØD1	ØD2	Ød	a	b	E	F	ap		Fig.
<b>RMT8E</b>												
<b>(RMT8EM)</b>												
5080R	5	80	88	57	25.4 (27)	9.5 (12.4)	6 (7)	25 (22)	50	8	1.4	1
5080R-M	6	80	88	57	25.4 (27)	9.5 (12.4)	6 (7)	25 (22)	50	8	1.4	1
5100R	6	100	108	67	31.75 (32)	12.7 (14.4)	8 (8)	32 (28)	50	8	1.9	2
5100R-M	8	100	108	67	31.75 (32)	12.7 (14.4)	8 (8)	32 (28)	50	8	1.9	2
5125R	8	125	133	87	38.1 (40)	15.9 (16.4)	10 (9)	38 (30)	63	8	3.7	2
5125R-M	10	125	133	87	38.1 (40)	15.9 (16.4)	10 (9)	38 (30)	63	8	3.7	2
5160R	10	160	168	107	50.8 (40)	19.0 (16.4)	11 (9)	38 (30)	63	8	5.7	2
5160R-M	14	160	168	107	50.8 (40)	19.0 (16.4)	11 (9)	38 (30)	63	8	5.7	2
5200R	12	200	208	130	47.625 (60)	25.4 (25.7)	14 (14)	38 (38)	63	8	7.5	3
5200R-M	18	200	208	130	47.625 (60)	25.4 (25.7)	14 (14)	38 (38)	63	8	7.5	3
5250R	16	250	258	180	47.625 (60)	25.4 (25.7)	14 (14)	38 (38)	63	8	12.4	3
5250R-M	22	250	258	180	47.625 (60)	25.4 (25.7)	14 (14)	38 (38)	63	8	12.4	3
5315R	20	315	323	240	47.625 (60)	25.4 (25.7)	14 (14)	38 (38)	63	8	19.9	4
5315R-M	28	315	323	240	47.625 (60)	25.4 (25.7)	14 (14)	38 (38)	63	8	19.9	4

( ) Metric size

## Available inserts

SNC(M)F-MF      SNC(M)F-MM



Designation	Cermet		Coated										Uncoated			page			
	CN2500	CN30	NC5330	NCM325	NCM335	NCM635	NCM645	PC2505	PC2010	PC3700	PC6510	PC9530	PC9540	PC5300	PC5400		ST30A	G10	H01
SNCF											●								E22
																			E23
SNMF											●								

## Available arbors

Designation	General arbors	NC arbors		
		RMT8E	RMT8EM	
<b>RMT8E</b>	□080R	NT*□□(M/U)-FMA25.4-□□	BT**□□-FMA25.4-□□	FMC27
<b>(RMT8EM)</b>	□100R	NT*□□(M/U)-FMA31.75-□□	BT**□□-FMA31.75-□□	FMC32
	□125R	NT*□□(M/U)-FMA38.1-□□	BT**□□-FMA38.1-□□	FMB40
	□160R	NT*□□(M/U)-FMA50.8-□□	BT**□□-FMA50.8-□□	
	□200R	NT*□□(M/U)-FMA47.625-25,	BT**□□-FMA47.625-□□	FMB60
	□250R	KCP-8***		
	□315R	KCP-8*** (Center ring plug)		

\*□□-NT number    \*\*□□-BT number    \*\*\*Over milling 5

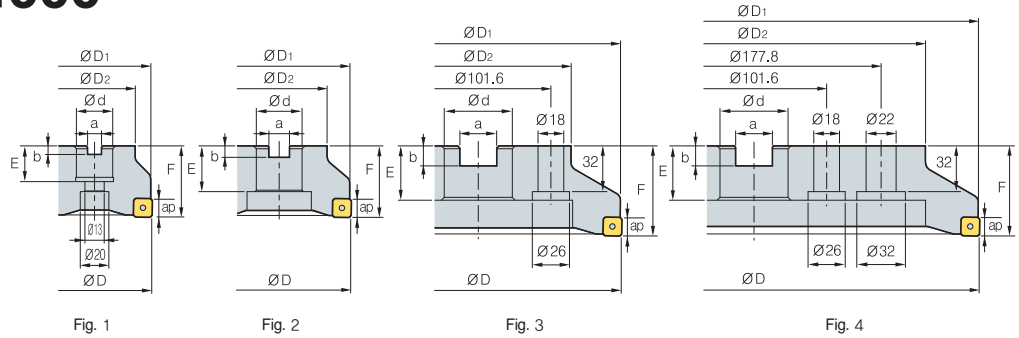
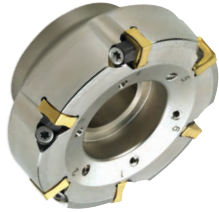
## Parts

Specification					
Ø80-Ø315	ETKA0625	KHB0417	SPR0415	LTC06SR-RM5	TW20-100

Available inserts E22, E23

Available arbors and bolt E426-E428

# RMT8Q(M)4000



AA  
88°  
•AR: -6°  
•RR: -11°~6°

(mm)

Designation	⊙	ØD	ØD1	ØD2	Ød	a	b	E	F	ap	kg	Fig.	
RMT8Q (RMT8QM)	4080R	5	80	79	57	25.4 (27)	9.5 (12.4)	6 (7)	25 (22)	50	5	1.4	1
	4080R-M	6	80	79	57	25.4 (27)	9.5 (12.4)	6 (7)	25 (22)	50	5	1.4	1
	4100R	6	100	99	67	31.75 (32)	12.7 (14.4)	8 (8)	32 (28)	50	5	1.8	2
	4100R-M	8	100	99	67	31.75 (32)	12.7 (14.4)	8 (8)	32 (28)	50	5	1.8	2
	4125R	8	125	124	87	38.1 (40)	15.9 (16.4)	10 (9)	38 (30)	63	5	3.6	2
	4125R-M	10	125	124	87	38.1 (40)	15.9 (16.4)	10 (9)	38 (30)	63	5	3.6	2
	4160R	10	160	159	107	50.8 (40)	19.0 (16.4)	11 (9)	38 (30)	63	5	5.7	2
	4160R-M	14	160	159	107	50.8 (40)	19.0 (16.4)	11 (9)	38 (30)	63	5	5.7	2
	4200R	12	200	199	130	47.625 (60)	25.4 (25.7)	14 (14)	38 (38)	63	5	7.5	3
	4200R-M	18	200	199	130	47.625 (60)	25.4 (25.7)	14 (14)	38 (38)	63	5	7.5	3
	4250R	16	250	249	180	47.625 (60)	25.4 (25.7)	14 (14)	38 (38)	63	5	12.5	3
	4250R-M	22	250	249	180	47.625 (60)	25.4 (25.7)	14 (14)	38 (38)	63	5	12.5	3
	4315R	20	315	314	240	47.625 (60)	25.4 (25.7)	14 (14)	38 (38)	63	5	19.9	4
	4315R-M	28	315	314	240	47.625 (60)	25.4 (25.7)	14 (14)	38 (38)	63	5	19.9	4

## Available inserts

( )Metric size

SNC(M)F-MF      SNC(M)F-MM



Designation	Cermet		Coated										Uncoated			page			
	CN2500	CN30	NC6330	NCM325	NCM335	NCM535	NCM545	PC2505	PC2010	PC3700	PC6510	PC9530	PC9540	PC5300	PC5400		ST30A	G10	H01
SNCF	1206QNN-MF										●								E22
	1206QNN-MM										●								
SNMF	1206QNN-MF									●									E23
	1206QNN-MM									●									

## Available arbors

Designation	General arbors	NC arbors		
		RMT8Q	RMT8QM	
RMT8Q (RMT8QM)	□080R	NT*□□(M/U)-FMA25.4-25	BT**□□-FMA25.4-□□	FMC27
	□100R	NT*□□(M/U)-FMA31.75-□□	BT**□□-FMA31.75-□□	FMC32
	□125R	NT*□□(M/U)-FMA38.1-□□	BT**□□-FMA38.1-□□	FMB40
	□160R	NT*□□(M/U)-FMA50.8-□□	BT**□□-FMA50.8-□□	
	□200R	NT*□□(M/U)-FMA47.625-25, KCP-8***	BT**□□-FMA47.625-□□	FMB60
	□250R			
□315R	KCP-8*** (Center ring plug)	-	-	-

\*□□-NT number    \*\*□□-BT number    \*\*\*Over milling 5

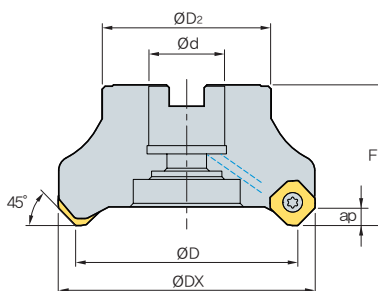
## Parts

Specification					
Ø80~Ø315	ETKA0523	KHB0417	SPR0315	LTC05SR-RM4	TW20-100

Available inserts E22, E23    Available arbors and bolt E426-E428



# RMX8AC(M)-SA14 new



AA  
45°

- AR: -8°
- RR: -11°--9°

(mm)

Designation		ØDX	ØD	ØD2	Ød	F	ap	
RMX8ACM	050R-22-4-SA14	4	62.5	50	42	22	40	0.34
	050R-22-5-SA14	5	62.5	50	42	22	40	0.38
	063R-22-5-SA14	5	75.5	63	42	22	40	0.56
	063R-22-6-SA14	6	75.5	63	42	22	40	0.54
	080R-27-6-SA14	6	92.5	80	60	27	50	1.00
	080R-27-8-SA14	8	92.5	80	60	27	50	1.04
	100R-32-8-SA14	8	112.5	100	70	32	50	2.05
	100R-32-10-SA14	10	112.5	100	70	32	50	2.06
	125R-40-8-SA14	8	137.5	125	90	40	63	3.34
	125R-40-12-SA14	12	137.5	125	90	40	63	3.34
RMX8AC	080R-25.4-6-SA14	6	92.5	80	60	25.4	50	1.02
	080R-25.4-8-SA14	8	92.5	80	60	25.4	50	1.06
	100R-31.75-8-SA14	8	112.5	100	70	31.75	63	2.08
	100R-31.75-10-SA14	10	112.5	100	70	31.75	63	2.09
	125R-38.1-8-SA14	8	137.5	125	90	38.1	63	3.43
	125R-38.1-12-SA14	12	137.5	125	90	38.1	63	3.35

## Available inserts

SAGX-ML

SAGX-MM

SNMX-MM



Designation	Cermet		Coated											Uncoated			page		
	CN2500	CN30	NC5330	NCM325	NCM335	NCM535	NCM545	PC2505	PC2510	PC2010	PC3700	PC6510	PC9530	PC9540	PC5300	ST30A		G10	H01
SAGX	140808ANER-ML													●	●				E18
	140808ANER-MM														●				
SNMX	140808ANER-MM										●	●			●				

## Available arbors

Designation	Ød	Available arborss
RMX8ACM 050R-22-□-SA14	22	BT□□-FMC22-□□
063R-22-□-SA14		BT□□-FMC27-□□
080R-27-□-SA14	27	BT□□-FMC32-□□
100R-32-□-SA14	32	BT□□-FMC40-□□
125R-40-□-SA14	40	

Designation	Ød	Available arbors
RMX8AC 080R-25.4-□-SA14	25.4	BT□□-FMC25.4-□□
100R-31.75-□-SA14	31.75	BT□□-FMC31.75-□□
125R-38.1-□-SA14	38.1	BT□□-FMC38.1-□□

## Parts

Specification		
Ø50~Ø125	FTNA0513	TW20-100

Available inserts E18 Available arbors and bolt E426-E428



# RM14XCM-XN06 new

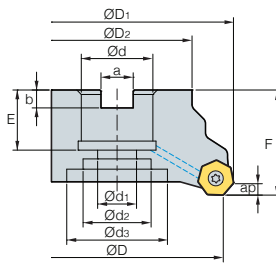


Fig. 1

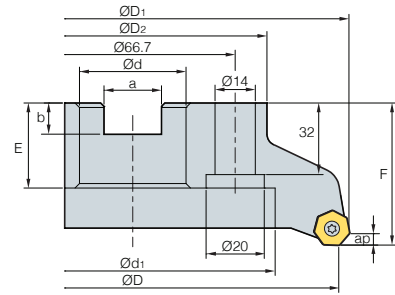


Fig. 2



(mm)

Designation		$\varnothing D$	$\varnothing D_1$	$\varnothing D_2$	$\varnothing d$	$\varnothing d_1$	$\varnothing d_2$	$\varnothing d_3$	a	b	E	F	ap		Fig.	
RM14XCM 050R-22-5-XN06		5	50	58.6	42	22	11	18	-	10.4	6.3	21	40	3.5	0.34	1
050R-22-6-XN06		6	50	58.6	42	22	11	18	-	10.4	6.3	21	40	3.5	0.34	1
063R-22-6-XN06		6	63	71.6	42	22	11	18	-	10.4	6.3	21	40	3.5	0.51	1
063R-22-8-XN06		8	63	71.6	42	22	11	18	-	10.4	6.3	21	40	3.5	0.58	1
080R-27-6-XN06		6	80	88.6	57	27	14	20	35	12.4	7.0	23	50	3.5	0.98	1
080R-27-8-XN06		8	80	88.6	57	27	14	20	35	12.4	7.0	23	50	3.5	1.08	1
080R-27-10-XN06		10	80	88.6	57	27	14	20	35	12.4	7.0	23	50	3.5	1.07	1
100R-32-10-XN06		10	100	108.6	67	32	18	26	42	14.4	8.0	25	63	3.5	1.60	1
100R-32-12-XN06		12	100	108.6	67	32	18	26	42	14.4	8.0	25	63	3.5	1.58	1
125R-40-12-XN06		12	125	133.6	90	40	22	32	54	16.4	9.0	29	63	3.5	3.43	1
125R-40-14-XN06		14	125	133.6	90	40	22	32	54	16.4	9.0	29	63	3.5	3.40	1
160NR-40-16-XN06		16	160	168.6	110	40	90	-	-	16.4	9.0	32	63	3.5	4.86	2
160NR-40-18-XN06		18	160	168.6	110	40	90	-	-	16.4	9.0	32	63	3.5	4.84	2

\* In applying XNMX060608-□□, Max. ap = 4.8 mm

## Available inserts

XNMX-ML XNMX-ML



Designation	Cermet		Coated										Uncoated			page			
	CN2500	CN30	NC5330	NCM325	NCM335	NCM535	NCM645	PC2505	PC2010	PC3700	PC6510	PC9530	PC9540	PC5300	PC5400		ST30A	G10	H01
XNMX 0606XNR-ML						●					●	●	●	●					E32
060608-ML						●					●	●	●	●					E32

## Available arbors

Designation	$\varnothing d$	Available arbors
RM14XCM 050R	22	BT□□-FMC22-□□
063R		
080R	27	BT□□-FMC27-□□
100R		
125R	32	BT□□-FMC32-□□
160R		
	40	BT□□-FMC40-□□

## Parts

Specification		
$\varnothing 50 \sim \varnothing 160$	FTKA0412B	TW15S

Available inserts E32 Available arbors and bolt E426-E428



# RM16AC(M)6000

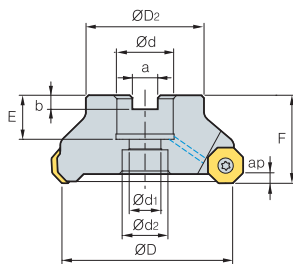


Fig. 1

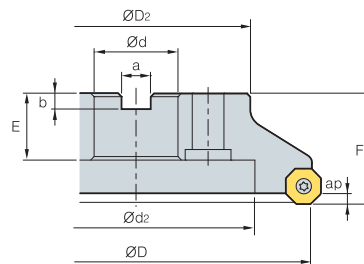




Fig. 2



AA  
45°

- AR: -6°
- RR: -6°

(mm)

Designation		ØD	ØD2	Ød	Ød1	Ød2	a	b	E	F	ap		Fig.	
<b>RM16ACM</b> 6063HR-M		5	63	49	22	11	18	10.4	6.3	20	40	4.0	0.7	1
<b>RM16AC (RM16ACM)</b> 6080HR-M		6	80	57	25.4 (27)	14	20	9.5 (12.4)	6 (7)	25 (23)	50	4.0	1.2	1
6100HR-M		7	100	67	31.75 (32)	18	26	12.7 (14.4)	8	33 (25)	63 (50)	4.0	1.9	1
6125HR-M		8	125	87	38.1 (40)	22	32	15.9 (16.4)	10 (9)	35 (29)	63	4.0	3.5	1
6160R-M		10	160	107	50.8 (40)	-	107	19 (16.4)	11 (9)	38 (32)	63	4.0	4.1	2
6200R-M		12	200	130	47.625 (60)	-	135	25.4 (25.7)	14	38 (32)	63	4.0	6.1	2
6250R-M		15	250	180	47.625 (60)	-	180	25.4 (25.7)	14	38	63	4.0	11.5	2
6315R-M		20	315	240	47.625 (60)	-	238	25.4 (25.7)	14	38	63	4.0	18.9	2
6400R-M		26	400	260	47.625 (60)	-	238	25.4 (25.7)	14	38	80	4.0	32.7	2

( ) Metric size

## Available inserts



Designation	Cermet		Coated										Uncoated			page		
	CN2500	CN30	NC5330	NCM325	NCM335	NCM335	NCM545	PC2505	PC2010	PC3700	PC6510	PC9530	PC9540	PC5300	PC5400		ST30A	G10
<b>ONHX</b> 060608-MM											●			●	●			
060608-MF											●			●	●			
060608-ML														●	●			
060608-MA																		●
060608-W											●	●		●	●			
0606ANN-MM											●			●	●			
0606ANN-MF											●			●	●			
<b>ONMX</b> 060608-MM											●		●	●	●			
060608-MF											●		●	●	●			
0606ANN-MM											●		●	●	●			
0606ANN-MF											●	●	●	●	●			

## Available arbors

Designation	Available arbors	
	RM16AC	RM16ACM
<b>RM16AC (RM16ACM)</b> 6063HR-M		BT□□-FMC22-□□
6080HR-M	BT□□-FMA25.4-□□	BT□□-FMC27-□□
6100HR-M	BT□□-FMA31.75-□□	BT□□-FMC32-□□
6125HR-M	BT□□-FMA38.1-□□	BT□□-FMB40-□□
6160R-M	BT□□-FMA50.8-□□	BT□□-FMC40-□□
6200R-M		
6250R-M		
6315R-M	BT□□-FMA47.625-□□	BT□□-FMB60-□□
6400R-M		

## Parts

Specification		
Ø63-Ø400	FTGA0513	TW20-100

Available inserts E15 Available arbors and bolt E426-E428

# RM16AC(M)8000

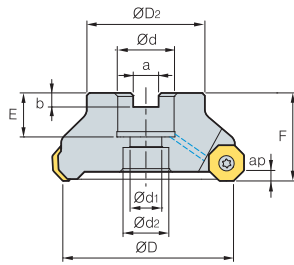


Fig. 1

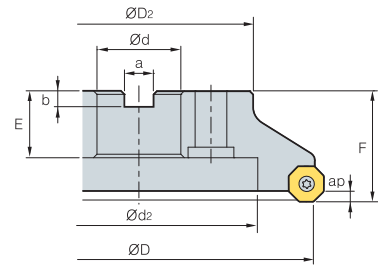


Fig. 2



AA  
45°

- AR: -6°
- RR: -6°

(mm)

Designation		ØD	ØD2	Ød	Ød1	Ød2	a	b	E	F	ap		Fig.	
RM16ACM 8063HR-M		5	63	49	22	11	18	10.4	6.3	20	40	5.5	0.7	1
RM16AC (RM16ACM) 8080HR-M		6	80	57	25.4 (27)	14	20	9.5 (12.4)	6 (7)	25 (23)	50	5.5	1.2	1
8100HR-M		7	100	67	31.75 (32)	18	26	12.7 (14.4)	8	33 (25)	63 (50)	5.5	1.8	1
8125HR-M		8	125	87	38.1 (40)	22	32	15.9 (16.4)	10 (9)	35 (29)	63	5.5	3.5	1
8160R-M		10	160	107	50.8 (40)	-	107	19 (16.4)	11 (9)	38 (32)	63	5.5	4.5	2
8200R-M		12	200	130	47.625 (60)	-	135	25.4 (25.7)	14 (14)	38 (32)	63	5.5	5.8	2
8250R-M		14	250	180	47.625 (60)	-	180	25.4 (25.7)	14	38	63	5.5	11.4	2
8315R-M		18	315	240	47.625 (60)	-	238	25.4 (25.7)	14	38	63	5.5	18.8	2
8400R-M		24	400	260	47.625 (60)	-	238	25.4 (25.7)	14	38	80	5.5	32.7	2

( ) Metric size

## Available inserts



Designation	Cermet		Coated										Uncoated			page			
	CN2500	CN30	NC5330	NCM325	NCM335	NCM535	NCM545	PC2505	PC2010	PC3700	PC6510	PC9530	PC9540	PC5300	PC5400		ST30A	G10	H01
ONHX 080608-MM											●			●	●				E15
080608-MF											●			●	●				
080608-ML														●	●				
080608-MA																		●	
080608-W											●								
0806ANN-MM											●			●	●				
0806ANN-MF											●			●	●				
ONMX 080608-MM						●				●	●	●		●	●				
080608-MF						●				●	●	●		●	●				
0806ANN-MM						●				●	●	●		●	●				
0806ANN-MF						●				●	●	●		●	●				

## Available arbors

Designation	Available arbors	
	RM16AC	RM16ACM
RM16AC 8063HR-M	-	BT□□-FMC22-□□
(RM16ACM) 8080HR-M	BT□□-FMA25.4-□□	BT□□-FMC27-□□
8100HR-M	BT□□-FMA31.75-□□	BT□□-FMC32-□□
8125HR-M	BT□□-FMA38.1-□□	BT□□-FMB40-□□
8160R-M	BT□□-FMA50.8-□□	BT□□-FMC40-□□
8200R-M		
8250R-M		
8315R-M	BT□□-FMA47.625-□□	BT□□-FMB60-□□
8400R-M		

## Parts

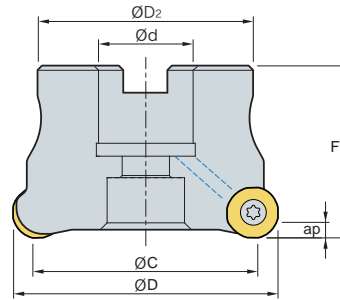
Specification		
Ø63~Ø400	FTGA0513	TW20-100

Available inserts E15 Available arbors and bolt E426-E428





# RMRC(M)-RN12 new



- AR: -7°
- RR: -13°

(mm)

Designation		ØD	ØC	ØD2	Ød	F	ap		
<b>RMRCM</b>	<b>050R-22-5-RN12</b>	5	50	40.4	42	22	40	3.5	0.28
	<b>050R-22-6-RN12</b>	6	50	40.4	42	22	40	3.5	0.29
	<b>063R-22-6-RN12</b>	6	63	53.4	42	22	40	3.5	0.45
	<b>063R-22-7-RN12</b>	7	63	53.4	42	22	40	3.5	0.46
	<b>080R-27-6-RN12</b>	6	80	70.4	60	27	50	3.5	0.83
	<b>080R-27-8-RN12</b>	8	80	70.4	60	27	50	3.5	0.82
	<b>100R-32-7-RN12</b>	7	100	90.4	70	32	63	3.5	1.67
	<b>100R-32-9-RN12</b>	9	100	90.4	70	32	63	3.5	1.67
	<b>125R-40-10-RN12</b>	10	125	115.4	90	40	63	3.5	2.82
	<b>125R-40-12-RN12</b>	12	125	115.4	90	40	63	3.5	2.83
<b>RMRC</b>	<b>080R-25.4-6-RN12</b>	6	80	70.4	60	25.4	50	3.5	0.85
	<b>080R-25.4-8-RN12</b>	8	80	70.4	60	25.4	50	3.5	0.85
	<b>100R-31.75-7-RN12</b>	7	100	90.4	70	31.75	63	3.5	1.71
	<b>100R-31.75-9-RN12</b>	9	100	90.4	70	31.75	63	3.5	1.71
	<b>125R-38.1-10-RN12</b>	10	125	115.4	90	38.1	63	3.5	2.88
	<b>125R-38.1-12-RN12</b>	12	125	115.4	90	38.1	63	3.5	2.88

## Available inserts

RNMX-ML



Designation	Cermet		Coated										Uncoated			page			
	CN2500	CN30	NC5330	NCM325	NCM335	NCM635	NCM545	PC2505	PC2010	PC3700	PC6510	PC9530	PC9540	UNC840	UPC845		ST30A	G10	H01
RNMX 1204M0E-ML														●	●				E17

## Available arbors

Designation	Ød	Available arbors	Designation	Ød	Available arbors		
<b>RMRCM</b>	<b>050R-22-□-RN12</b>	22	BT□□-FMC22-□□	<b>RMRC</b>	<b>080R-25.4-□-RN12</b>	25.4	BT□□-FMC25.4-□□
	<b>063R-22-□-RN12</b>		BT□□-FMC22-□□		<b>100R-31.75-□-RN12</b>	31.75	BT□□-FMC31.75-□□
	<b>080R-27-□-RN12</b>	27	BT□□-FMC27-□□		<b>125R-38.1-□-RN12</b>	38.1	BT□□-FMC38.1-□□
	<b>100R-32-□-RN12</b>	32	BT□□-FMC32-□□				
	<b>125R-40-□-RN12</b>	40	BT□□-FMC40-□□				

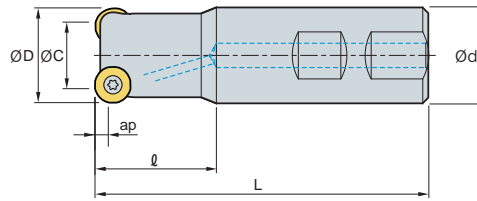
## Parts

Specification		
Ø50-Ø125	FTNA0411-A	TW15S

Available inserts E17

Available arbors and bolt E426-E428

# RMRS-RN12 new



• AR:  $-7^\circ$   
• RR:  $-15^\circ$ ~ $-13^\circ$

(mm)

	Designation		ØD	ØC	Ød	l	L	Shank	ap	
RMRS	032R-2W32-110-RN12	2	32	22.4	32	40	110	W	3.5	0.56
	032R-3W32-110-RN12	3	32	22.4	32	40	110	W	3.5	0.55
	032R-2C32-200-RN12	2	32	22.4	32	40	200	C	3.5	1.09
	032R-3C32-200-RN12	3	32	22.4	32	40	200	C	3.5	1.09
	040R-3W32-110-RN12	3	40	30.4	32	40	110	W	3.5	0.62
	040R-4W32-110-RN12	4	40	30.4	32	40	110	W	3.5	0.62
	040R-3C32-200-RN12	3	40	30.4	32	40	200	C	3.5	1.15
	040R-4C32-200-RN12	4	40	30.4	32	40	200	C	3.5	1.15
	050R-5W40-120-RN12	5	50	40.4	40	40	120	W	3.5	1.08
	050R-6W40-120-RN12	6	50	40.4	40	40	120	W	3.5	1.08
	050R-5C42-300-RN12	5	50	40.4	42	40	300	C	3.5	3.05
	050R-6C42-300-RN12	6	50	40.4	42	40	300	C	3.5	3.05
	063R-6W40-130-RN12	6	63	53.4	40	50	130	W	3.5	1.43
	063R-7W40-130-RN12	7	63	53.4	40	50	130	W	3.5	1.43
063R-6C42-300-RN12	6	63	53.4	42	50	300	C	3.5	3.30	
063R-7C42-300-RN12	7	63	53.4	42	50	300	C	3.5	3.26	

## Available inserts

RNMX-ML



Designation	Cermet		Coated										Uncoated			page			
	CN2500	CN30	NC5330	NCM325	NCM335	NCM535	NCM545	PC2505	PC2010	PC3700	PC6510	PC9530	PC9540	UNC840	UPC845		ST30A	G10	H01
RNMX 1204M0E-ML														●	●				E17

## Parts

Specification		
Ø32~Ø63	FTNA0411-A	TW15S

Available inserts E17 Available arbors and bolt E426-E428

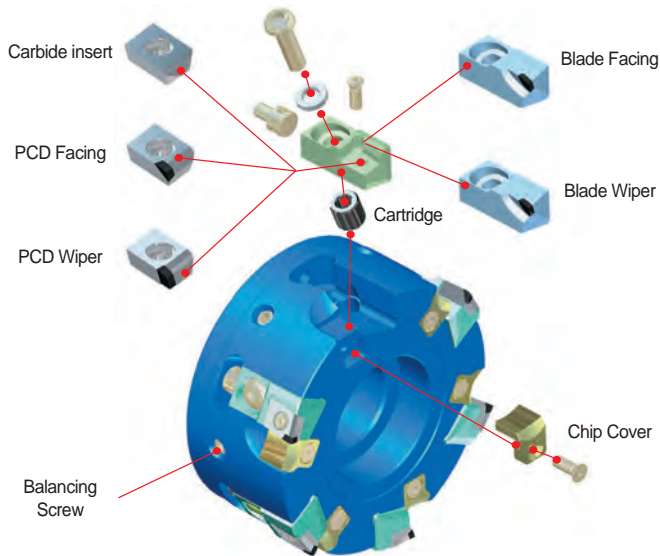


Lighter tool ensures excellent performance in high speed machining

# Aero Mill

- Excellent machining performance can be acquired especially at the high speeds due to the light aluminum cutter body that is 50% of the weight of a conventional steel cutter body
- High speed milling cutter for precise machining
- Special aluminum material and high rake angle of insert provide rigid & stable machining
- High tolerance surface finishes can be acquired due to the low cutting load provided from the high rake angle
- Balanceable up to G2.5 level

## ➤ Assembly structure of cutter



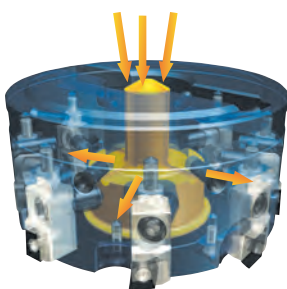
## ➤ Features of cutter

- Increased stability based on cartridge type application
- Both insert and blade can be available in the same cutter
- Finishing to roughing can be possible because of wide chip pocket space
- Roughing and finishing available with carbide, PCD insert application
- Cutter breakage can be solved by making use of the chip cover

## ➤ Coolant through system

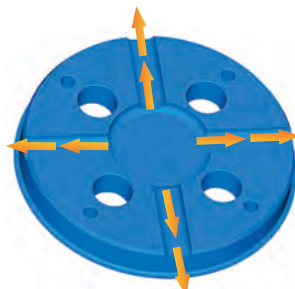
- Specially designed coolant through system provides coolant from the center of the cutter to the insert enhances the cooling rate and chip evacuation.
- Direction of coolant has designed to focus directly to the insert cutting-edge to maximize chip evacuation and improve tool life
- Coolant bolt is applicable up to  $\varnothing 160$ , coolant cover is applicable from  $\varnothing 200$  and over.  
Coolant devices are sold separately for through coolant system, through coolant arbor has to be used

Coolant Bolt



For  $\varnothing 80$ – $\varnothing 160$

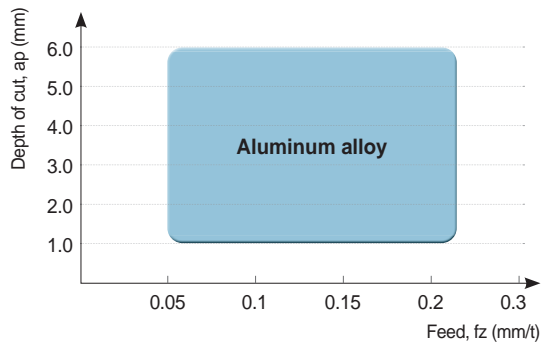
Coolant Cover



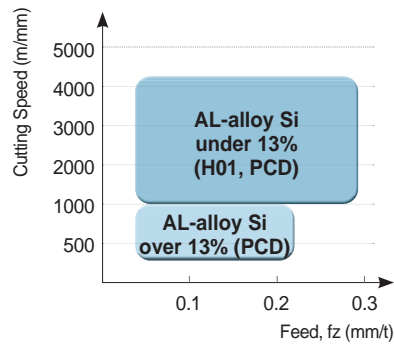
For  $\varnothing 200$  and over

## Aero Mill

### Application range

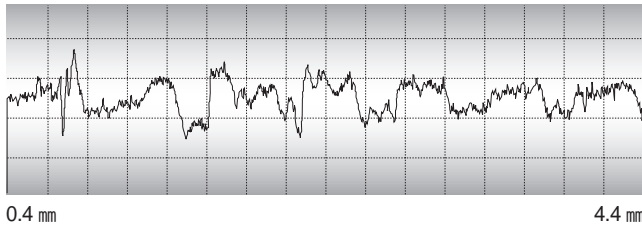


### Recommended cutting condition



### Surface finish

- **Workpiece** A6061
- **Cutting condition**  $vc = 1570 \text{ m/min}$   $vf = 3000 \text{ mm/min}$   
 $S = 5000 \text{ rpm}$   $fz = 0.1 \text{ mm/t}$   
 $ap = 0.5 \text{ mm}$  Machine = PCV620
- **Designation** **Cutter** APD100R-A6Z (6 Flutes)  
**Insert** CDEW1204R-XCF (H01)



### Max. revolution

Diameter (mm)	Max. revolution (rpm)
Ø80	16,000
Ø100	15,000
Ø125	12,500
Ø160	10,000
Ø200	8,000
Ø250	6,500
Ø315	5,000

### Coolant parts

Diameter (mm)	Type	Designation		Shape	Note
Ø80	Coolant Bolt	CBP080-IN/MM			Extra charge
Ø100	Coolant Bolt	CBP100-IN	CBP100-MM-1		
Ø125	Coolant Bolt	CBP125-IN	CBP125-MM-1		
Ø160	Coolant Bolt	CBP160-IN	CBP160-MM		
Ø200	Coolant Cover	CCP200			
Ø250	Coolant Cover	CCP250			
Ø315	Coolant Cover	CCP315			

• Choice: CBP100-IN:APD type, General for unmarked item

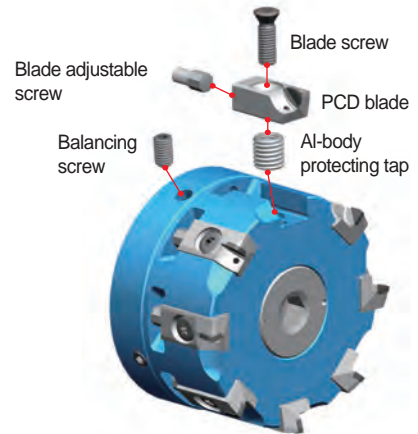


High speed milling tool with PCD blade

# Aero Mill-Plus

- Improve tool life up to 20% with a coolant system that enables direct spray cooling to cutting blades
- Enable high feed milling by increasing the number of cutting blades by 20% through a simply structured coupling method for clamps
- Reduces set up time up to 40% by applying a spanner adjustment method
- Introduce an aluminum cutter body to provide a superior cutting performance during high speed milling

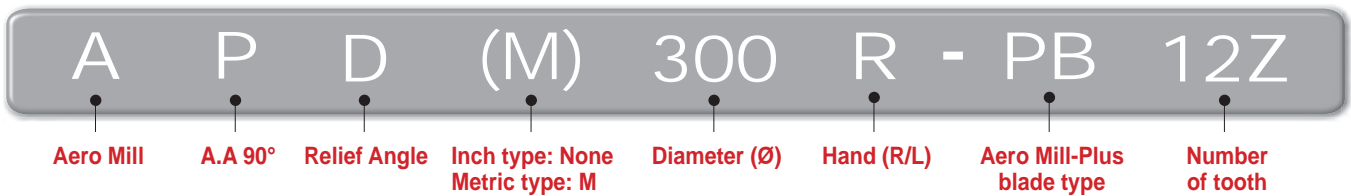
### Assembly structure of cutter



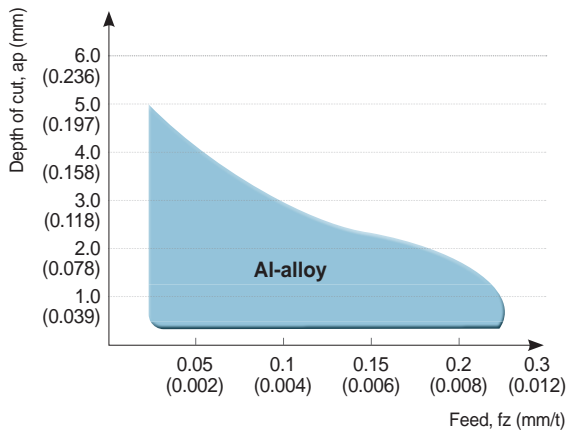
### Features of cutter

- Prevent overload to the spindle bearings through weight reduction of the Al alloy body and enable high-speed processing
- Provide PCD Blade-dedicated cutter design to offer stable tool life and increase of applied blades
- Improve the blade life by applying a coolant system that enables direct spray cooling to cutting blades
- Adopt a clamping method with simple structure without set screw
- Reduce weight and apply a coolant bolt that is exclusively used for Aero-Mill Plus that applies coolant to remove internal chip

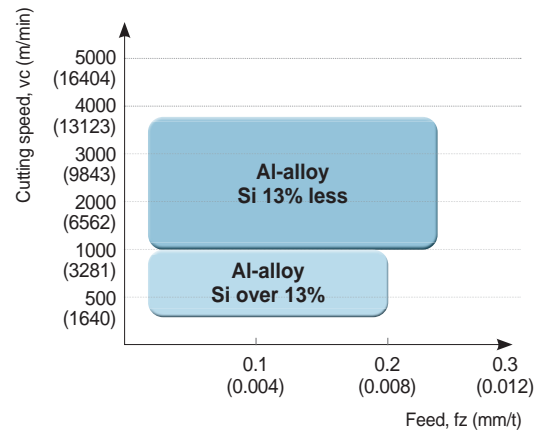
### Code system



### Application range



### Recommended cutting speed



### Max. RPM

Diameter (mm)	Max. revolution (rpm)
Ø80	20,000
Ø100	18,000
Ø125	16,000
Ø160	13,000
Ø200	10,000
Ø250	8,000
Ø315	7,000

### Coolant parts

Diameter (mm)	Type	inch/mm	Designation	Shape	Material	Note
Ø80	Coolant bolt	inch, mm	CB12-AMaP80		Steel	Included
		inch	CB16-AMP100			
		mm	CB16-AMP100M			
		inch	CB20-AMP125			
		mm	CB20-AMP125M			
		inch	CB24-AMP160			
Ø160	Coolant cover	inch, mm	CCV-AMP200		Aluminum	Extra charge
		inch, mm	CCV-AMP250			
		inch, mm	CCV-AMP315			

# E Technical information for Aero Mill-Mini

Good performance in small-medium size of operations

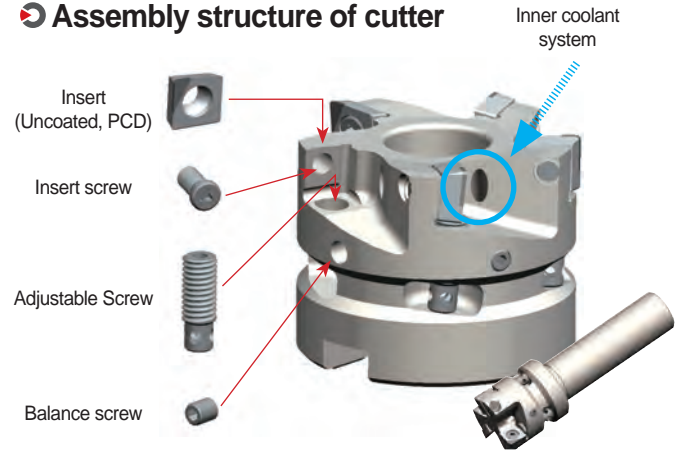
## Aero Mill-Mini

- Good performance in small-medium size of operations
- Good duration of the steel body
- Choice of Uncoated carbide/PCD grades can be applied to various kind of work material
- Balance level: G2.5

### Features of cutter

- Simple and strong design of Screw-on clamping.
- Adjustable range:  $\pm 0.1$  mm Max
- Adjustable step: Min. 2 micro meter
- Wide chip pocket area for Roughing and Aluminum machining.
- Inner coolant system

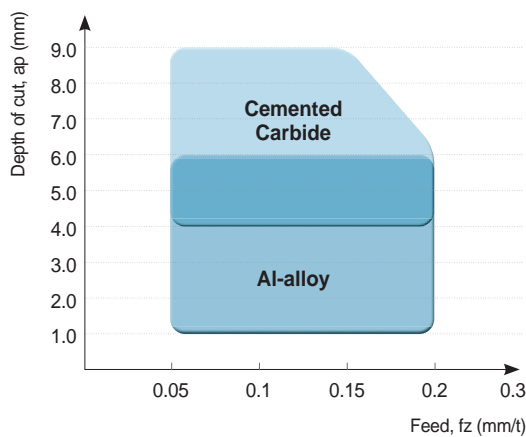
### Assembly structure of cutter



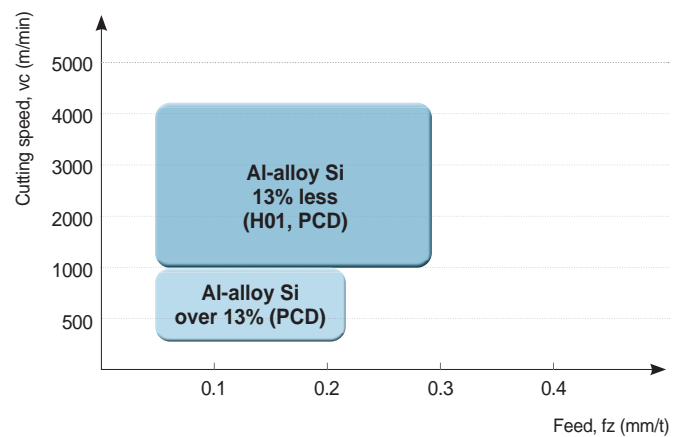
### Code system



### Application range



### Recommended cutting condition



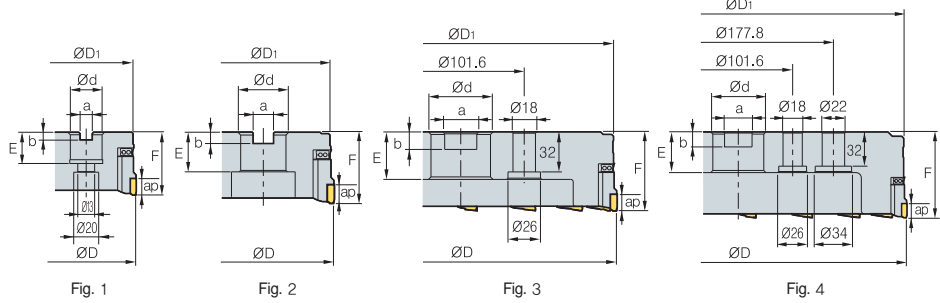
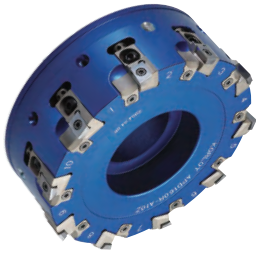
### Max. RPM

Diameter	Max. RPM (min <sup>-1</sup> )
Ø32	26,000
Ø40	24,500
Ø50	22,000
Ø63	20,000



# APD(M)-A

## Cartridge + insert



Designation		ØD	ØD1	Ød	a	b	E	F	ap	Max rpm		Fig.	
APD	080R/L-A6Z	6	80	76	25.4 (27)	9.5 (12.4)	6 (7)	25 (22)	50	10	16000	0.75	1
APDM	100R/L-A6Z	6	100	95	31.75 (32)	12.7 (14.4)	8 (8)	32 (28)	50	10	15000	0.95	2
	125R/L-A8Z	8	125	120	38.1 (40)	15.9 (16.4)	10 (9)	38 (30)	63	10	12500	1.8	2
	160R/L-A10Z	10	160	155	50.8 (40)	19.0 (16.4)	11 (9)	38 (30)	63	10	10000	2.9	2
	200R/L-A12Z	12	200	195	47.625 (60)	25.4 (25.7)	14 (14)	38 (38)	63	10	8000	4.0	3
	250R/L-A16Z	16	250	245	47.625 (60)	25.4 (25.7)	14 (14)	38 (38)	63	10	6500	6.3	3
	315R/L-A18Z	18	315	310	47.625 (60)	25.4 (25.7)	14 (14)	38 (38)	80	10	5000	11.3	4

( ) Metric size

### Available inserts

CDEW-XCF CDEW-XAF,NAF CDEW-XAW,NAW



Designation	Uncoated			PCD	page
	H01	G10	ST30A	DP200	
CDEW	1204R-XCF	●			E07
	1204L-XCF				
	1204R-XAF			●	
	1204L-XAF				
	1204R-NAF			●	
	1204L-NAF				
	1204R-XAW			●	
	1204L-XAW				
	1204R-NAW			●	
	1204L-NAW				

### Available arbors

Designation	General arbors	NC arbors
APD	080R/L NT*□□(M/U)-FMA25.4-25	BT**□□-FMA25.4
APDM	100R/L NT*□□(M/U)-FMA31.75-□□	BT**□□-FMA31.75
	125R/L NT*□□(M/U)-FMA38.1-□□	BT**□□-FMA38.1
	160R/L NT*□□(M/U)-FMA50.8-□□	BT**□□-FMA50.8
	200R/L NT*□□(M/U)-FMA47.625-25,	BT**□□-FMA47.625-□□
	250R/L KCP-8***	
	315R/L KCP-8*** (Center ring plug)	-

\*□□-NT number \*\*□□-BT number \*\*\*Over milling 5

### Recommended cutting condition

Workpiece	Cutting condition		Grades
	vc (m/min)	fz (mm/t)	
Aluminum	1,000~4,000 500~2,500	0.05~0.30 0.05~0.20	DP200 H01

### Parts

Specification								
Ø80-Ø315	LAPDR/L-AJ	CAPDR/L-AJ	PTMA0411	FTNA0411	AZ0514	BHA0619-NYLOK	TW15S	HW50

Available inserts E07 Available arbors and bolt E426-E428



## APD(M)-PB

Blade

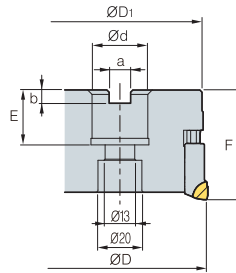
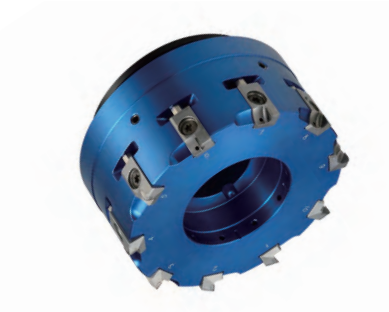


Fig. 1

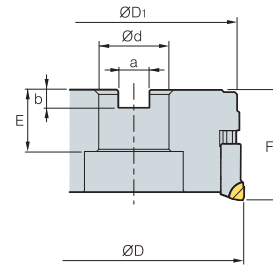


Fig. 2



AA  
90°

- AR: 6°
- RR: -4°~1°

(mm)

Designation		Max	ØD	ØD1	Ød	a	b	E	F	ap		Fig.
APD (APDM) 080R/L-PB6Z	6	10	80	77	25.4 (27)	9.5 (12.4)	6 (7)	23.5	50	5	0.55	1
080R/L-PB8Z	8	10	80	77	25.4 (27)	9.5 (12.4)	6 (7)	23.5	50	5	0.55	1
100R/L-PB6Z	6	12	100	97	31.75 (32)	12.7 (14.4)	8	34 (32)	50	5	0.92	2
100R/L-PB8Z	8	12	100	97	31.75 (32)	12.7 (14.4)	8	34 (32)	50	5	0.92	2
125R/L-PB8Z	8	14	125	122	38.1 (40)	15.9 (16.4)	10 (9)	40 (35)	63	5	1.9	2
125R/L-PB10Z	10	14	125	122	38.1 (40)	15.9 (16.4)	10 (9)	40 (35)	63	5	1.9	2
160R/L-PB10Z	10	20	160	157	50.8 (40)	19.0 (16.4)	11 (9)	41 (35)	63	5	3.3	2
160R/L-PB12Z	12	20	160	157	50.8 (40)	19.0 (16.4)	11 (9)	41 (35)	63	5	3.3	2

( ) Metric size

### Available blades

BAMPR-XAF BAMPR-XAW BAMPR-XAWR



Designation	PCD		page
	DP150		
BAMPR-XAF			E07
BAMPR-XAW	●		
BAMPR-XAWR	●		

### Available arbors

Designation	NC arbors
APD-PB 080R/L-PB□□Z	BT□□-FMA25.4(FMC27)-□□
(APDM-PB) 100R/L-PB□□Z	BT□□-FMA31.75(FMC32)-□□
125R/L-PB□□Z	BT□□-FMA38.1(FMB40)-□□
160R/L-PB□□Z	BT□□-FMA50.8(FMB/FMC40)-□□

### Parts

Specification						
Ø80~Ø160	ETKA0620	AZ0514-SPN6	UZD1010	KHE0610	SPN-6	TW25-100

Available inserts E07 Available arbors and bolt E426-E428



# APD(M)-PB

Blade

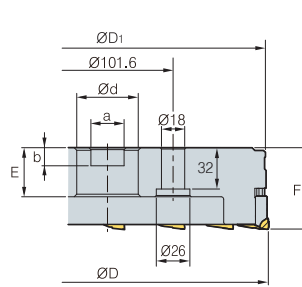
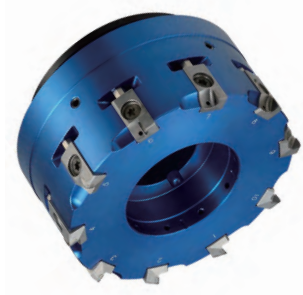


Fig. 1

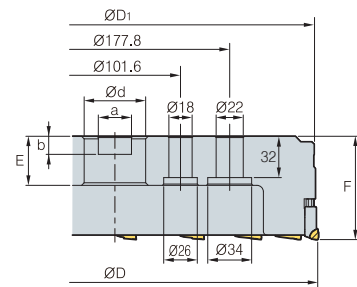


Fig. 2



AA  
90°

- AR: -6°
- RR: -39°--16°

(mm)

Designation		Max	ØD	ØD1	Ød	a	b	E	F	ap		Fig.
APD (APDM) 200R/L-PB12Z	12	26	200	197	47.625 (60)	25.4 (25.7)	14	40	63	5	4.0	1
250R/L-PB16Z	16	32	250	247	47.625 (60)	25.4 (25.7)	14	40	63	5	6.5	1
315R/L-PB18Z	18	42	315	312	47.625 (60)	25.4 (25.7)	14	40	63	5	11.3	2

( ) Metric size

## Available blades

BAMPR-XAF BAMPR-XAW BAMPR-XAWR



Designation	PCD		page
	DP150		
BAMPR-XAF			E07
BAMPR-XAW	●		
BAMPR-XAWR	●		

## Available arbors

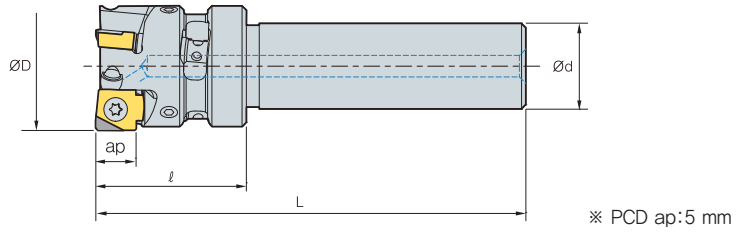
Designation	NC arbors
APD-PB 200R/L-PB□□Z	BT□□-FMA47.625(FMB60)-□□
(APDM-PB) 250R/L-PB□□Z	
315R/L-PB□□Z	

## Parts

Specification						
Ø200~Ø315	ETKA0620	AZ0514-SPN6	UZD1010	KHE0610	SPN-6	TW25-100

Available inserts E07 Available arbors and bolt E426-E428

# MAPDS000HR/L-Z0

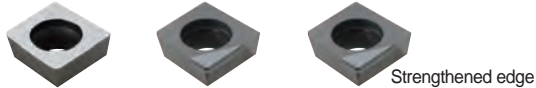


(mm)

Designation		ØD	Ød	l	L	ap	Max rpm		
MAPDS	032HR/L-Z3	3	32	20	35	100	9.5	26,000	0.35
	040HR/L-Z4	4	40	20	35	100	9.5	24,500	0.42

## Available inserts

SNEW SNEW-XAF SNEW-NAF



Designation	Uncoated			PCD	page
	H01	G10	ST30A	DP200	
SNEW	09T3ADFR	●			E24
	09T3ADTR-XAF			●	
	09T3ADTR-XAW			●	
	09T3ADTR-NAF			●	
	09T3ADTR-NAW			●	

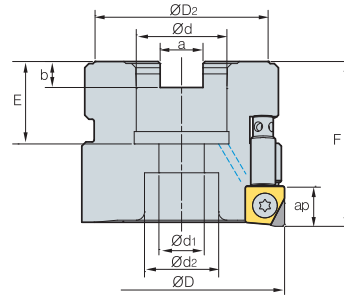
## Parts

Specification					
Ø32-Ø63	FTKA0408	AHX0617F-NYLOK	KHD0405	TW15S	HW20L

Available inserts E24



# MAPD000HR/L-Z0



※ PCD ap:5 mm



AA  
90°

- AR: 6°
- RR: -1°~12°

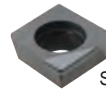
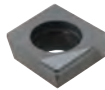
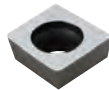
Designation		⊙	ØD	ØD2	Ød	a	b	E	F	Ød1	Ød2	ap	Max rpm	kg
MAPD	040HR/L-Z4	4	40	34	16	8.4	5.6	18	40	9	14	9.5	24,000	0.24
	050HR/L-Z5	5	50	42	22	10.4	6.3	20	40	11	18	9.5	22,000	0.35
	063HR/L-Z6	6	63	42	22	10.4	6.3	20	40	11	18	9.5	20,000	0.65

## Available inserts

SNEW

SNEW-XAF

SNEW-NAF



Strengthened edge

Designation	Uncoated				PCD	page
	H01	G10	ST30A	ST20	DP200	
SNEW	09T3ADFR	●				E24
	09T3ADTR-XAF				●	
	09T3ADTR-XAW				●	
	09T3ADTR-NAF				●	
	09T3ADTR-NAW				●	

## Available arbors

Designation	NC arbors
MAPD	
040HR/L-Z4	BT**□□-FMC16-□□
050HR/L-Z5	BT**□□-FMC22-□□
063HR/L-Z6	BT**□□-FMC22-□□

## Recommended cutting condition

Workpiece	Cutting condition		Grades
	vc (m/min)	fz (mm/t)	
Aluminum	1,000~4,000 500~2,500	0.05~0.30 0.05~0.20	DP200 H01

## Coolant bolt (Not included)

Designation	Applicable cutter	Available cutters
CB0525	MAPD040HR/L-Z4	Ø40
CB1025	MAPD050HR/L-Z5	Ø50
	MAPD063HR/L-Z6	Ø63

## Parts

Specification	Insert screw	Adjust screw	Balance screw	Wrench for insert	Adjust wrench
Ø32~Ø63	FTKA0408	AHX0617F-NYLOK	KHD0405	TW15S	HW20L

Available inserts E24 Available arbors and bolt E426-E428

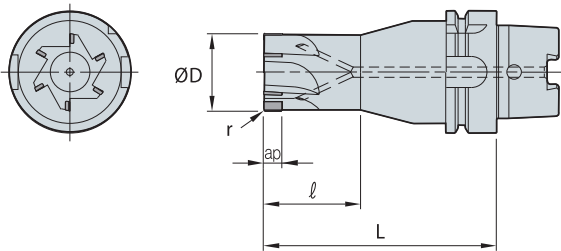
# E PCD Face Cutter

## Code system

PDF
6
032 - HSK63A

PCD Face cutter
Tooth
Diameter
Shank

## PCD Face cutter



(mm)

Designation		ØD	r	ap	l	L	
PDF	4032-HSK50A	4	32	0.5	8	120	
	4040-HSK50A	4	40	0.5	8	120	
	4032-HSK63A	4	32	0.5	8	120	
	4040-HSK63A	4	40	0.5	8	120	
	4050-HSK63A	4	50	0.5	8	120	
	6063-HSK63A	6	63	0.5	12	-	100
	6063-HSK100A	6	63	0.5	12	-	100

## Recommended cutting condition

Workpiece	vc (m/min)	fz (mm/t)	ap (mm)
Al, Brass, Alloy	200~2,000	0.02~0.1	0.05~4.0

## Special PCD order sheet

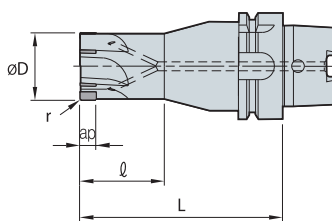
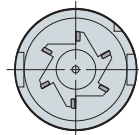


Fig. 1

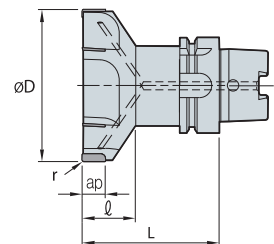


Fig. 2

Designation	Fig.	tooth	Dimensions (mm)					Shank spec.
			ØD	r	ap	l	L	
PDF								



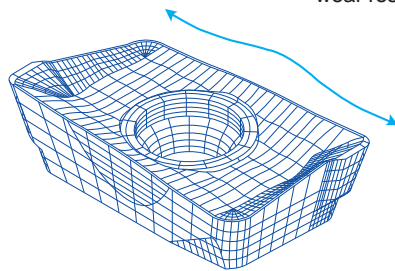
Various applications are available with multi-functional cutters

# Alpha Mill

- Innovative curve cutting-edge and chip-breaker design ensures ideal 90-degree cutting, lower cutting resistance, and improved insert life.
- Various applications are available with multi-functional cutters. (Facing, Slotting, Square shoulder milling, etc.)
- Excellent performance ensured at large depth of cut operations due to strong cutting-edge and low cutting resistance.

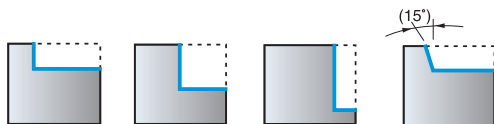
## Features of insert

- Long tool life at high speed, high feed and deeper cutting by low cutting resistance and strong cutting-edge
- Distinguished features of Alpha-Curve reduce cutting resistance and improve cutting-edge strength and wear resistance
- Low cutting resistance is realized by KORLOY unique design-the alpha curve cutting-edge and optimal convex and concave design
- Highly efficient machining is available by the ideal application of the grade to material



## Application example

### Shouldering



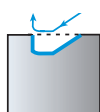
### Slotting



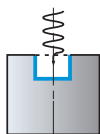
### Drilling



### Ramping



### Helical cutting

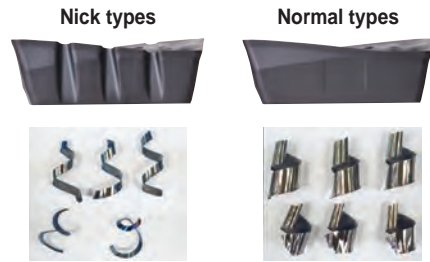


## Alpha Mill Nick new




- New nick cutting edge reduces cutting load
- High productivity
- APMT standard holders are compatible with Alpha Mill nick that is reducing stock management cost.

### Features

- Lower cutting load due to the overlapping system

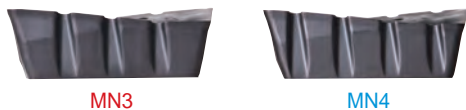


- ※ Nick types require both chip breaker types for application.
- ※ Can be used with the existing Alpha Mill holders. Use multi-edges for maximum results. (cutters with even-numbered teeth)

Type	Nick type		General type
Required No. of teeth	20		20
For AMCM3080M (4 Flute x 5 teeth)	 x 10 <b>APMT16-MN3</b>	 x 10 <b>APMT16-MN4</b>	 x 20 <b>APMT16-MM, MF, ML, MA</b>

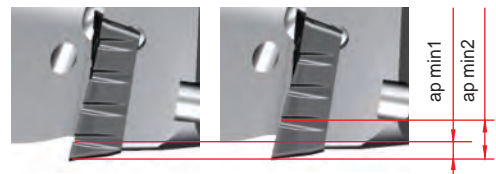
### How to clamp

- Alternate the two types of chip breakers when clamping an insert.



### Min. depth of cut

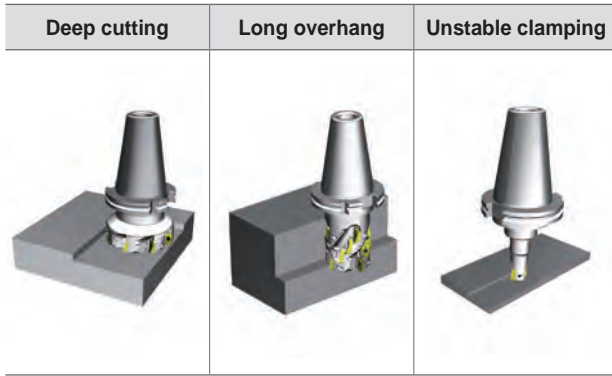
- The depth of cut must be greater than  $ap_{min1}$  for chip breaking.



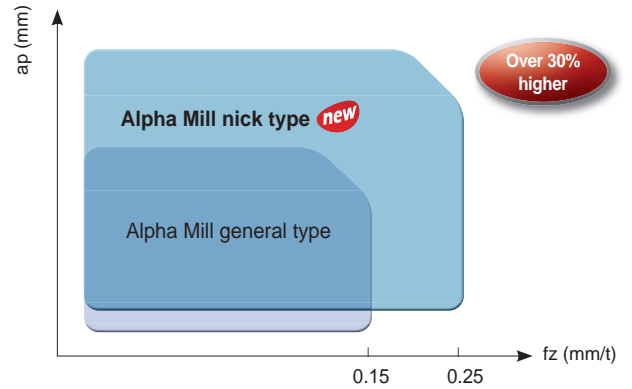
Type	$ap_{min1}$	$ap_{min2}$
APMT11 (2000 type)	1.6 mm	4.1 mm
APMT16 (3000 type)	2.2 mm	5 mm
APMT18 (4000 type)	2.3 mm	5.5 mm



## Application examples



## Application area



• 30% or higher cutting conditions available compared to normal types

## Recommended cutting condition

ISO	Grades	APMT 2000 type			APMT 3000 type			APMT 4000 type		
		vc (m/min)	fz (mm/t)	ap (mm)	vc (m/min)	fz (mm/t)	ap (mm)	vc (m/min)	fz (mm/t)	ap (mm)
P	PC3700	180~280	0.05~0.15	11	160~270	0.05~0.18	16	160~270	0.05~0.18	17
	PC5300	150~250	0.05~0.15		150~240	0.05~0.18		150~240	0.05~0.18	
M	PC5300	90~170	0.05~0.15		90~150	0.05~0.18		90~150	0.05~0.18	
K	PC5300	120~240	0.1~0.2		120~200	0.1~0.23		120~200	0.1~0.23	

※ Above cutting conditions can be applied up to cutting speed of 300 m/min and feed per tooth of 0.4 mm/t.

## Features of chip breakers

Insert	Cutting-edge	Uses	Features
MA		Al	Optimal cutting-edge and buffed surface for aluminum workpieces ensure high performance in machining
ML		Hard-to-cut material	Chip breaker with low cutting load is optimal for machining hard-to-cut materials
MF		Light cutting	Chip breaker with low cutting load and harder cutting-edge than ML's are optimal for light cutting
MM		General cutting	Optimal for milling in general ranges
MN		Roughing (Nick)	Design for easy chip cutting ensures high machinability in toughing

## Product constitution

Item description	Type	Nose R	MA	ML
APMT	1000 type	0.4	APMT0602PDFR-MA	-
		0.8	APMT060208PDFR-MA	-
	1500 type	0.4	APMT0903PDFR-MA	APMT0903PDER-ML
		0.8	APMT090308PDFR-MA	APMT090308PDER-ML
	2000 type	0.5	APMT11T3PDFR-MA	APMT11T3PDER-ML
		0.8	APMT11T308PDFR-MA	APMT11T308PDER-ML
	3000 type	0.4	APMT160404PDFR-MA	APMT160404PDER-ML
		0.8	APMT1604PDFR-MA	APMT1604PDER-ML
	4000 type	0.4	APMT180604PDFR-MA	APMT180604PDER-ML
		0.8	APMT1806PDFR-MA	APMT1806PDER-ML
		1.2	APMT180612PDFR-MA	APMT180612PDER-ML
		1.6	APMT180616PDFR-MA	APMT180616PDER-ML
		2.0	APMT180620PDFR-MA	APMT180620PDER-ML
		2.4	APMT180624PDFR-MA	APMT180624PDER-ML
		3.0	APMT180630R-MA	APMT180630R-ML

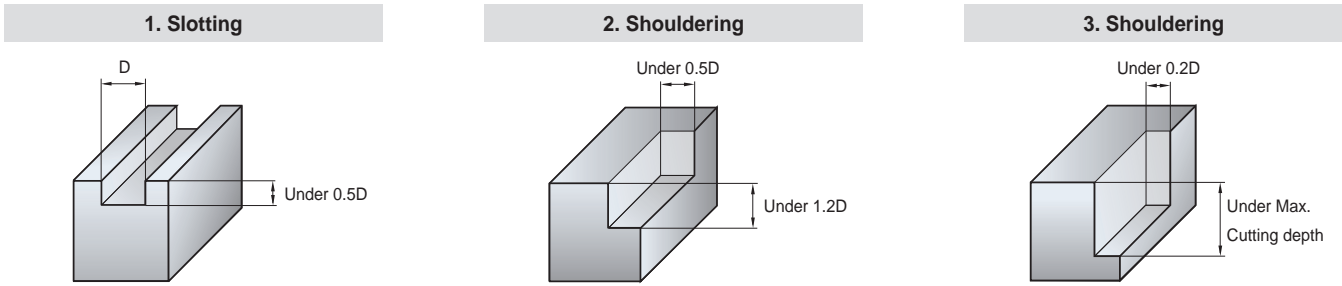
- The inserts can switch to the APMT type holders.

## Recommended grades and chip breakers by workpiece

Chip breaker	Cutter edge	Recommended C/B and grade as per workpiece (●: 1 <sup>st</sup> )											
		P				M		K		N		S	
		Low carbon steel/Mild steel		High carbon steel/Mild steel		Stainless steel		Cast iron		Aluminum alloy		Ti/Inconel	
		C/B	Grades	C/B	Grades	C/B	Grades	C/B	Grades	C/B	Grades	C/B	Grades
MA		-	-	-	-	-	-	-	-	●	●H01	-	-
ML		-	-	-	-	●	● PC5300 ○ PC5400 ○ PC9530	-	-	-	-	●	● PC5300 ○ PC5400
MF		●	● PC3700 ○ PC5300 ○ PC5400 ○ NCM325 ○ NCM335	-	○ PC3700 ○ NCM325 ○ NCM335	-	● PC5300 ○ PC5400 ○ PC9530	-	● PC6510 ○ PC5300 ○ PC5400	-	-	-	● PC5300 ○ PC5400
MM		-	● PC3700 ○ PC5300 ○ PC5400 ○ NCM325 ○ NCM335	●	● PC3700 ○ PC5300 ○ PC5400 ○ NCM325 ○ NCM335	-	● PC5300 ○ PC5400 ○ PC9530	●	● PC6510 ○ PC5300 ○ PC5400	-	-	-	● PC5300 ○ PC5400
MN		-	● PC3700 ○ PC5300 ○ PC5400	-	-	-	● PC5300 ○ PC5400 ○ PC9530	-	● PC6510 ○ PC5300 ○ PC5400	-	-	-	● PC5300 ○ PC5400



➤ Recommended depth of cut



➤ Recommended cutting condition (for Multi-edge type)

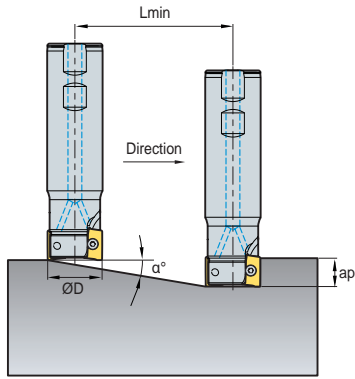
Workpiece	Grades	Fig.	Tool dia.									
			Ø10, 16		Ø20, 25		Ø32, 40		Ø50, 63		Ø80, 100	
			vc (m/min)	fz (mm/t)	vc (m/min)	fz (mm/t)	vc (m/min)	fz (mm/t)	vc (m/min)	fz (mm/t)	vc (m/min)	fz (mm/t)
Mild steel, Low carbon steel)	NCM535 NCM325 PC5400 PC5300 PC3700	①	50~80	0.05~0.08	80~100	0.05~0.08	100~120	0.05~0.08	100~120	0.05~0.08	100~120	0.05~0.08
		②	65~90	0.08~0.1	100~120	0.08~0.1	120~140	0.08~0.1	120~140	0.08~0.1	120~140	0.08~0.1
		③	65~95	0.1~0.15	100~120	0.1~0.15	120~140	0.1~0.15	120~140	0.1~0.15	130~150	0.1~0.15
High carbon steel, Alloy steel	NCM535 NCM325 PC5300 PC3700	①	45~60	0.05	60~80	0.05	80~100	0.05	80~100	0.05	80~100	0.05
		②	50~80	0.05~0.08	80~100	0.05~0.08	100~120	0.08~0.1	100~120	0.08~0.1	100~120	0.08~0.1
		③	50~80	0.1~0.15	80~100	0.1~0.15	110~130	0.1~0.15	100~120	0.1~0.15	110~130	0.1~0.15
Alloy tool steel	PC5300 PC3700 PC2510 PC2505	①	40~55	0.05	50~70	0.05	70~90	0.05	70~90	0.05	70~90	0.05
		②	45~60	0.05~0.08	60~80	0.05~0.08	90~120	0.05~0.08	100~120	0.05~0.08	100~120	0.05~0.08
		③	50~75	0.12~0.18	90~110	0.12~0.18	100~130	0.1~0.15	100~120	0.1~0.15	110~130	0.1~0.15
Stainless steel	PC5300 PC9530	①	35~50	0.054	50~70	0.054	70~90	0.05	70~90	0.05	70~90	0.05
		②	45~60	0.05~0.08	60~80	0.05~0.08	90~120	0.05~0.08	100~120	0.05~0.08	100~120	0.05~0.08
		③	50~75	0.1~0.15	90~110	0.1~0.15	100~130	0.1~0.15	110~130	0.1~0.15	110~130	0.1~0.15
Cast iron	PC6510 PC5300	①	50~70	0.1~0.12	70~90	0.1~0.12	70~90	0.1~0.12	90~120	0.1~0.12	90~120	0.1~0.12
		②	50~80	0.12	80~100	0.12	90~120	0.12	100~140	0.12	100~140	0.12
		③	50~80	0.15~0.2	80~100	0.15~0.2	100~130	0.15~0.2	120~150	0.15~0.2	120~150	0.15~0.2
Aluminum alloy	H01	①	160~600	0.1~0.2	200~800	0.1~0.2	300~900	0.1~0.2	400~1,000	0.1~0.2	400~1,000	0.1~0.2
		②	200~650	0.15~0.3	250~900	0.15~0.3	300~950	0.15~0.3	400~1,000	0.1~0.4	400~1,000	0.1~0.4
		③	200~650	0.15~0.3	250~900	0.15~0.3	300~950	0.15~0.3	400~1,000	0.1~0.4	400~1,000	0.1~0.4
Hardened steel	PC5300 PC2510 PC2505	①	35~50	0.03	50~70	0.03	60~90	0.03	60~90	0.03	60~90	0.03
		②	45~60	0.05~0.08	60~80	0.05~0.08	80~100	0.05~0.08	80~100	0.05~0.08	80~100	0.05~0.08
		③	50~80	0.05~0.08	80~100	0.05~0.08	80~100	0.05~0.08	80~100	0.05~0.08	80~100	0.05~0.08

➤ Recommended cutting condition (for Single-edge type)

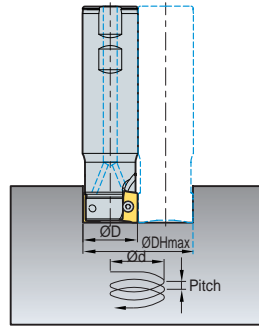
Workpiece	Grades	Fig.	Tool dia.									
			Ø10, 16		Ø20, 25		Ø32, 40		Ø50, 63		Ø80, 100	
			vc (m/min)	fz (mm/t)	vc (m/min)	fz (mm/t)	vc (m/min)	fz (mm/t)	vc (m/min)	fz (mm/t)	vc (m/min)	fz (mm/t)
Mild steel, low carbon steel	NCM535 NCM325 PC5400 PC5300 PC3700	①	45~60	0.05~0.08	60~80	0.05~0.08	80~120	0.05~0.08	120~200	0.05~0.08	150~200	0.05~0.08
		②	60~90	0.08~0.1	80~120	0.08~0.1	120~180	0.08~0.1	180~250	0.08~0.1	200~250	0.08~0.1
		③	60~90	0.1~0.15	80~120	0.1~0.15	120~180	0.1~0.15	180~250	0.1~0.15	200~250	0.1~0.15
High carbon steel, alloy steel	NCM535 NCM325 PC5300 PC3700	①	40~60	0.05	50~80	0.05	80~110	0.05	100~150	0.05	100~150	0.05
		②	50~80	0.05~0.08	80~100	0.05~0.08	110~150	0.05~0.1	150~200	0.05~0.1	150~200	0.05~0.1
		③	50~80	0.1~0.15	80~100	0.1~0.15	120~150	0.1~0.15	180~200	0.1~0.15	180~200	0.1~0.15
Alloy tool steel	PC5300 PC3700 PC2510 PC2505	①	35~50	0.05	50~70	0.05	80~100	0.05	100~130	0.05	100~130	0.05
		②	45~70	0.05~0.08	70~100	0.05~0.08	100~130	0.05~0.1	130~180	0.05~0.1	130~180	0.05~0.1
		③	45~70	0.1~0.15	70~100	0.1~0.15	100~150	0.1~0.15	130~180	0.1~0.15	130~180	0.1~0.15
Stainless steel	PC5300 PC9530	①	35~50	0.05	50~70	0.05	80~100	0.05	100~130	0.05	100~130	0.05
		②	45~70	0.05~0.08	70~100	0.05~0.08	100~130	0.05~0.1	130~180	0.05~0.1	130~180	0.05~0.1
		③	45~70	0.1~0.15	70~100	0.1~0.15	100~150	0.1~0.15	130~180	0.1~0.15	130~180	0.1~0.15
Cast iron	PC6510 PC5300	①	50~80	0.08~0.12	80~100	0.08~0.12	80~100	0.15	120~150	0.15	120~150	0.15
		②	65~90	0.12~0.15	100~120	0.12~0.15	100~130	0.15~0.18	150~200	0.15~0.18	150~200	0.15~0.18
		③	65~90	0.15~0.2	100~120	0.15~0.2	100~130	0.15~0.2	150~200	0.15~0.2	150~200	0.15~0.2
Aluminum alloy	H01	①	200~600	0.15~0.2	250~800	0.15~0.2	300~900	0.15~0.2	400~1,000	0.1~0.2	400~1,000	0.1~0.2
		②	200~650	0.2~0.25	250~900	0.2~0.25	350~950	0.2~0.25	400~1,000	0.2~0.3	400~1,000	0.2~0.3
		③	200~650	0.25~0.3	250~900	0.25~0.3	350~950	0.25~0.3	400~1,000	0.3~0.4	400~1,000	0.3~0.4
Hardened steel	PC5300 PC2510 PC2505	①	35~50	0.03	50~70	0.03	60~90	0.03	60~90	0.03	60~90	0.03
		②	45~65	0.05~0.08	60~80	0.05~0.08	80~100	0.05~0.08	80~100	0.05~0.08	80~100	0.05~0.08
		③	50~80	0.05~0.08	80~100	0.05~0.08	80~100	0.05~0.08	80~100	0.05~0.08	80~100	0.05~0.08

## ➤ Cutting condition for ramping and helical operation

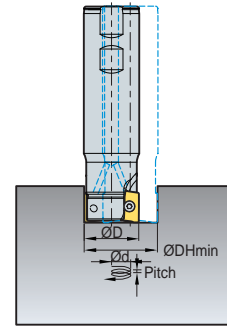
1. Ramping



2. Helical cutting for blind hole



3. Helical cutting for through hole



(mm)

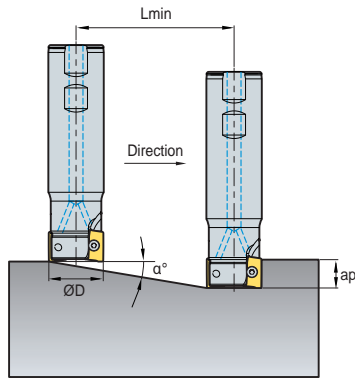
Designation	Tool dia. ØD (min)	ap	1. Ramping		2. Helical cutting for blind hole			3. Helical cutting for through hole		
			Maximum angle α(°)	Lmin	Min. desirable hole dia. ØDHmin	Max. pitch dmax	Max. desirable hole dia. ØDHmax	Max. pitch dmax	Min. desirable hole dia. ØDHmin	Max. pitch dmax
AMS1010HS	10	5	6.5	44	17.6	2.0	18.8	2.1	13	1.5
AMS1011HS	11		5.6	51	19.6	1.9	20.8	2.0	15	1.5
AMS1012HS	12		4.9	58	21.6	1.9	22.8	2.0	17	1.5
AMS1014HS	14		3.9	73	25.6	1.8	26.8	1.8	21	1.4
AMS1015HS	15		3.6	80	27.6	1.7	28.8	1.8	23	1.4
AMS1016HS	16		3.3	87	29.6	1.7	30.8	1.8	25	1.4
AMS1017HS	17		3.0	94	31.6	1.7	32.8	1.7	27	1.4
AMS1018HS	18		2.8	101	33.6	1.7	34.8	1.7	29	1.4
AMS1020HS	20		2.5	115	37.6	1.6	38.8	1.7	33	1.4
AMS1021HS	21		2.3	123	39.6	1.6	40.8	1.7	35	1.4
AMS1022HS	22		2.2	130	41.6	1.6	42.8	1.6	37	1.4
AMS1025HS	25		1.9	151	47.6	1.6	48.8	1.6	43	1.4
AMS1026HS	26		1.8	158	49.6	1.6	50.8	1.6	45	1.4
AMS1032HS	32		1.4	201	61.6	1.5	62.8	1.6	57	1.4
AMS1033HS	33		1.4	208	63.6	1.5	64.8	1.6	59	1.4
AMCM1032HS	32		1.4	201	61.6	1.5	62.8	1.6	57	1.4
AMCM1040HS	40		1.1	258	77.6	1.5	78.8	1.5	73	1.4
AMCM1050HS	50		0.9	330	97.6	1.5	98.8	1.5	93	1.4
AMCM1063HS	63		0.7	423	123.6	1.5	124.8	1.5	119	1.4
AMS1510HS	10		9	7.5	68	17.4	2.3	18.8	2.5	11
AMS1512HS	12	6.5		79	21.4	2.4	22.8	2.6	15	1.7
AMS1513HS	13	5.7		90	23.4	2.3	24.8	2.5	17	1.7
AMS1514HS	14	6.3		82	25.4	2.8	26.8	2.9	19	2.1
AMS1516HS	16	5.0		102	29.4	2.6	30.8	2.7	23	2.0
AMS1517HS	17	4.6		112	31.4	2.5	32.8	2.6	25	2.0
AMS1518HS	18	4.2		122	33.4	2.5	34.8	2.6	27	2.0
AMS1519HS	19	3.9		132	35.4	2.4	36.8	2.5	29	2.0
AMS1520HS	20	3.6		142	37.4	2.4	38.8	2.5	31	2.0
AMS1521HS	21	3.4		152	39.4	2.3	40.8	2.4	33	2.0
AMS1522HS	22	3.2		162	41.4	2.3	42.8	2.4	35	1.9
AMS1524HS	24	2.8		182	45.4	2.2	46.8	2.3	39	1.9
AMS1525HS	25	2.7		192	47.4	2.2	48.8	2.3	41	1.9
AMS1528HS	28	2.3		222	53.4	2.2	54.8	2.2	47	1.9
AMS1530HS	30	2.1		242	57.4	2.1	58.8	2.2	51	1.9
AMS1532HS	32	2.0		262	61.4	2.1	62.8	2.2	55	1.9
AMS1535HS	35	1.8		292	67.4	2.1	68.8	2.1	61	1.9
AMS1540HS	40	1.5		342	77.4	2.0	78.8	2.1	71	1.9
AMCM15040HS	40	1.5		342	77.4	2.0	78.8	2.1	71	1.9
AMCM15050HS	50	1.2		442	97.4	2.0	98.8	2.0	91	1.9
AMCM15063HS	63	0.9	572	123.4	1.9	124.8	2.0	117	1.8	
AMCM15080HS	80	0.7	742	157.4	1.9	158.8	1.9	151	1.8	
AMCM15100HS	100	0.5	942	197.4	1.9	198.8	1.9	191	1.8	

$$Lmin = \frac{ap}{\tan \alpha} \text{ (mm)}$$

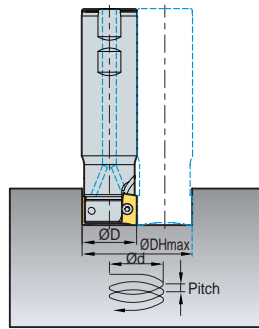


## Cutting condition for ramping and helical operation

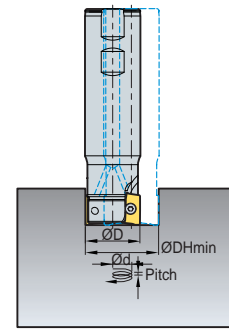
1. Ramping



2. Helical cutting for blind hole



3. Helical cutting for through hole



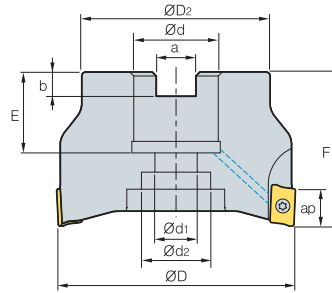
(mm)

Designation	Tool dia. ØD (min)	ap	1. Ramping		2. Helical cutting for blind hole				3. Helical cutting for through hole		
			Maximum angle α(°)	Lmin	Min. desirable hole dia. ØDHmin	Max. pitch dmax	Max. desirable hole dia. ØDHmax	Max. pitch dmax	Min. desirable hole dia. ØDHmin	Max. pitch dmax	
AMS2010HS	10	10	16.82	33	16.4	5.0	18	5.4	11	3.3	
AMS2012HS	12		11.69	48	20.4	4.2	22	4.6	15	3.1	
AMS2014HS	14		7.55	75	24.4	3.2	26	3.4	19	2.5	
AMS2016HS	16		10.30	55	28	5.1	30	5.5	23	4.2	
AMS2018HS	18		8.23	69	32	4.6	34	4.9	27	3.9	
AMS2020HS	20		5.60	102	36	3.5	38	3.7	31	3.0	
AMS2022HS	22		5.15	111	40	3.6	42	3.8	35	3.2	
AMS2025HS	25		3.92	146	46	3.2	48	3.3	41	2.8	
AMS2032HS	32		2.70	212	60	2.8	62	2.9	55	2.6	
AMS2040HS	40		1.98	289	76	2.6	78	2.7	71	2.5	
AMS2050HS	50		1.48	386	96	2.5	98	2.5	91	2.4	
AMS2063HS	63		1.11	514	122	2.4	124	2.4	117	2.3	
AMCM2040HS	40		1.29	445	76	2.5	78	2.6	71	2.1	
AMCM2050HS	50		0.36	1576	96	0.6	98	0.6	91	0.6	
AMCM2063HS	63		0.27	2104	122	0.6	124	0.6	117	0.6	
AMCM2080HS	80		0.21	2784	156	0.6	158	0.6	151	0.5	
AMCM2100HS	100		0.16	3584	196	0.5	198	0.6	191	0.5	
AMS3025HS	25		10	4.72	121	46	3.8	48	4.0	36	3.0
AMS3032HS	32			3.00	191	60	3.1	62	3.2	50	2.6
AMS3040HS	40			2.29	250	76	3.0	78	3.1	66	2.6
AMS3050HS	50	1.64		350	96	2.7	98	2.8	86	2.5	
AMS3063HS	63	1.22		470	122	2.6	124	2.6	112	2.4	
AMCM3040HS	40	1.99		288	76	2.6	78	2.7	66	2.3	
AMCM3050HS	50	1.67		343	96	2.8	98	2.9	86	2.5	
AMCM3063HS	63	1.22		470	122	2.6	124	2.6	112	2.4	
AMCM3080HS	80	0.90		636	156	2.5	158	2.5	146	2.3	
AMCM3100HS	100	0.69		830	196	2.4	198	2.4	186	2.2	
AMS2025MH	25	10	1.50	764	46	1.2	48	1.3	-	-	
AMS2032MH	32		1.50	1146	60	1.6	62	1.6	-	-	
AMS3040MH	40	16	1.50	1528	76	2.0	78	2.0	-	-	
AMS4020HS	20	16	9.5	98	37.4	6.2	38.8	6.5	31	5.2	
AMS4021HS	21		5.2	179	39.4	3.6	40.8	3.7	33	3.0	
AMS4025HS	25		7.6	122	47.4	6.3	48.8	6.5	41	5.5	
AMS4026HS	26		7.1	130	49.4	6.2	50.8	6.4	43	5.4	
AMS4032HS	32		3.4	276	61.4	3.6	62.8	3.7	55	3.3	
AMS4033HS	33		3.2	288	63.4	3.6	64.8	3.7	57	3.2	
AMS4040HS	40		2.5	376	77.4	3.4	78.8	3.4	71	3.1	
AMS4050HS	50		1.9	502	97.4	3.2	98.8	3.2	91	3.0	
AMS4063HS	63		1.4	665	123.4	3.0	124.8	3.1	117	2.9	
AMCM4050HS	50		1.9	502	97.4	3.2	98.8	3.2	91	3.0	
AMCM4063HS	63		1.4	665	123.4	3.0	124.8	3.1	117	2.9	
AMCM4080HS	80		1.1	878	157.4	2.9	158.8	2.9	151	2.8	
AMCM4100HS	100		0.8	1128	197.4	2.9	198.8	2.9	191	2.8	
AMCM4125HS	125		0.6	1442	247.4	2.8	248.8	2.8	241	2.7	

$$Lmin = \frac{ap}{\tan \alpha} \text{ (mm)}$$



## AMC(M)1000S



AA  
90°  
•AR: 9°~13°  
•RR: -14°~5°

(mm)

Designation		ØD	ØD2	Ød	Ød1	Ød2	a	b	E	F	ap		
AMCM	1032HS	8	32	30	16	9	14	8.4	5.6	19	40	5.6	0.15
	1040HS-16	10	40	34	16	9	14	8.4	5.6	19	40	5.6	0.24
	1040HS-22	10	40	34	22	11	18	10.4	6.3	21	40	5.6	0.24
	1050HS	12	50	42	22	11	18	10.4	6.3	21	40	5.6	0.36
	1063HS	14	63	49	22	11	18	10.4	6.3	21	40	5.6	0.61

### Available inserts

APMT-MA APMT-MM



Designation	Cermet		Coated											Uncoated		page		
	CN2500	CN30	NC5330	NCM325	NCM335	NCM535	NCM545	PC2505	PC2510	PC3700	PC6510	PC9530	PC9540	PC5300	PC5400		G10	H01
APMT 0602PDFR-MA																		●
060208PDFR-MA																		
060202PDSR-MM			●						●					●	●			
0602PDSR-MM			●					●	●	●	●			●	●			
060208PDSR-MM			●						●					●	●			
060212R-MM			●											●	●			
060216R-MM														●	●			

### Available arbors

Designation	Ød	NC arbors
AMCM 1032HS	16	BT□□-FMC16-□□
1040HS-16		
1040HS-22		
1050HS	22	BT□□-FMC22-□□
1063HS		

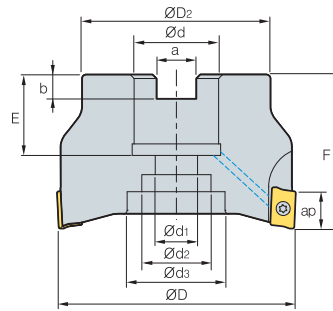
### Parts

Specification		
Ø32~Ø63	FTKA01842	TW06S-A

Available inserts E05 Available arbors and bolt E426-E428



# AMC(M)1500S



• AR: 9°~13°  
• RR: -14°~5°

(mm)

Designation		ØD	ØD2	Ød	Ød1	Ød2	Ød3	a	b	E	F	ap		
AMCM	15040HS	5	40	34	16	9	14	-	8.4	5.6	19	40	9	0.22
	15050HS	6	50	42	22	11	18	-	10.4	6.3	21	40	9	0.34
	15063HS	8	63	49	22	11	18	-	10.4	6.3	21	40	9	0.57
AMC (AMCM)	15080HS	10	80	57	25.4 (27)	14	25	35	9.5 (12.4)	6 (7)	24 (23)	50	9	1.10
	15100HS	12	100	67	31.75 (32)	18	26	42	12.7 (14.4)	8 (8)	32 (26)	63	9	2.10

( ) Metric size

## Available inserts

APMT-MA APMT-ML APMT-MM



Designation	Cermet		Coated											Uncoated		page			
	CN2500	CN30	NC5330	NCM325	NCM335	NCM335	NCM535	NCM545	PC2505	PC2510	PC3700	PC6510	PC9530	PC9540	PC6300		PC5400	G10	H01
APMT	0903PDFR-MA																	●	E05
	090308PDFR-MA																		
	0903PDER-ML														●	●			
	090308PDER-ML														●	●			
	0903PDSR-MM			●				●	●	●	●				●	●			
	090308PDSR-MM			●											●	●			
	090312R-MM														●	●			
	090316R-MM			●											●	●			
	090320R-MM														●	●			

## Available arbors

Designation	Ød	NC arbors	
AMCM	15040HS	16	BT□□-FMC16-□□
	15050HS	22	BT□□-FMC22-□□
	15063HS	22	BT□□-FMC22-□□
AMC (AMCM)	15080HS	25.4	BT□□-FMA25.4-□□
		27	BT□□-FMC27-□□
15100HS		31.75	BT□□-FMA31.75-□□
		32	BT□□-FMC32-□□

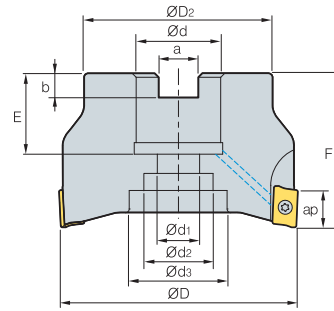
## Parts

Specification		
Ø40~Ø100	FTKA02565S	TW08S

Available inserts E05 Available arbors and bolt E426-E428



## AMC(M)2000S



AA  
90°  
•AR: 9°~13°  
•RR: -14°~5°

(mm)

Designation	ØD	ØD2	Ød	Ød1	Ød2	Ød3	a	b	E	F	ap	$\frac{Q}{kg}$		
AMCM	2040HS	5	40	34	16	9	14	-	8.4	5.6	18	40	11	0.22
	2050HS	6	50	42	22	11	18	-	10.4	6.3	20	40	11	0.34
	2063HS	8	63	49	22	11	18	-	10.4	6.3	20	40	11	0.57
AMC (AMCM)	2080HS	8	80	57	25.4 (27)	14	25	35	9.5 (12.4)	6 (7)	25 (22)	50	11	1.10
	2100HS	10	100	67	31.75 (32)	18	26	42	12.7 (14.4)	8 (8)	32 (28)	63	11	2.10

( )Metric size

### Available inserts



Designation	Cermet		Coated										Uncoated		page			
	CN2500	CN30	NC5330	NCM325	NCM335	NCM335	NCM545	PC2505	PC2510	PC3700	PC6510	PC9530	PC9540	PC5300		PC5400	G10	H01
APMT	11T3PDFR-MA																	●
	11T308PDFR-MA																	
	11T3PDER-ML													●	●			
	11T308PDER-ML													●	●			
	11T3PDSR-MM			●	●		●	●	●	●	●	●		●	●			
	11T3PDSR-MF			●					●	●				●	●			
	11T308PDSR-MM			●					●		●	●		●	●			
	11T312PDSR-MM			●					●		●			●	●			
	11T316R-MM			●					●					●	●			
	11T318R-MM			●					●					●	●			
	11T324R-MM			●					●					●	●			
	11T3PDSR-MN2													●				
	11T3PDSR-MN3													●				

E06

\* Please purchase 2 types of APMT-MN (nick type) inserts with different chip breakers. \* Please use the cutters with even teeth.

### Available arbors

Designation	Ød	NC arbors	
AMCM	2040HS	16	BT□□-FMC16-□□
	2050HS	22	BT□□-FMC22-□□
	2063HS		
AMC (AMCM)	2080HS	25.4	BT□□-FMA25.4-□□
		27	BT□□-FMC27-□□
	2100HS	31.75	BT□□-FMA31.75-□□
		32	BT□□-FMC32-□□

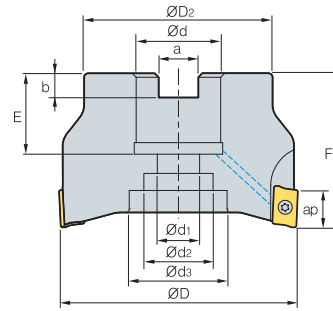
### Parts

Specification	Screw	Wrench
Ø40~Ø100	FTKA02565S	TW08S

Available inserts E06 Available arbors and bolt E426-E428



# AMC(M)3000S



AA  
90°  
• AR: 14°  
• RR: -12°-8°

(mm)

Designation		ØD	ØD2	Ød	Ød1	Ød2	Ød3	a	b	E	F	ap		
AMCM	3040HS	4	40	34	16	9	14	-	8.4	5.6	18	40	16	0.18
	3050HS	5	50	42	22	11	18	-	10.4	6.3	20	40	16	0.28
	3063HS	6	63	49	22	11	18	-	10.4	6.3	20	40	16	0.50
AMC (AMCM)	3080HS	7	80	57	25.4 (27)	14	25	35	9.5 (12.4)	6 (7)	25 (22)	50	16	1.02
	3100HS	8	100	67	31.75 (32)	18	26	42	12.7 (14.4)	8 (8)	32 (28)	63	16	2.05

( )Metric size

## Available inserts



Designation	Cermet		Coated											Uncoated		page		
	CN2500	CN30	NC5330	NCM325	NCM335	NCM535	NCM545	PC2505	PC2510	PC3700	PC6510	PC9530	PC9540	PC5300	PC5400		G10	H01
APMT	1604PDFR-MA																	●
	160404PDFR-MA																	
	1604PDER-ML																	
	160404PDER-ML																	
	1604PDSR-MM			●	●		●		●	●	●	●	●	●	●	●	●	
	1604PDSR-MF			●						●	●				●	●		
	160410PDSR-MM									●					●	●		
	160416PDSR-MM			●						●					●	●		
	160424R-MM			●						●					●	●		
	160430R-MM			●						●					●	●		
	160432R-MM			●						●					●	●		
	1604PDSR-MN3														●			
	1604PDSR-MN4														●			

※ Please purchase 2 types of APMT-MN (nick type) inserts with different chip breakers. ※ Please use the cutters with even teeth.

## Available arbors

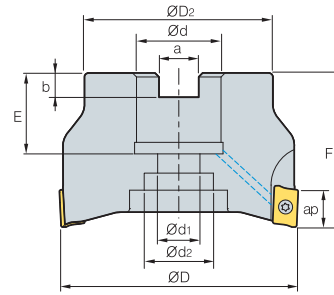
Designation	Ød	NC arbors	
AMCM	3040HS	16	BT□□-FMC16-□□
	3050HS	22	BT□□-FMC22-□□
	3063HS		
AMC (AMCM)	3080HS	25.4	BT□□-FMA25.4-□□
		27	BT□□-FMC27-□□
	3100HS	31.75	BT□□-FMA31.75-□□
		32	BT□□-FMC32-□□

## Parts

Specification		
Ø40-Ø100	FTKA0410	TW15S

Available inserts E06 Available arbors and bolt E426-E428

## AMC(M)3000S-K



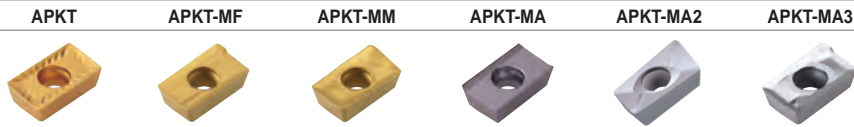
AA  
90°  
•AR: 14°  
•RR: -12°~8°

(mm)

Designation		ØD	ØD2	Ød	Ød1	Ød2	a	b	E	F	ap		
AMCM	3040HS-K	4	40	34	16	9	14	8.4	5.6	18	40	16	0.15
	3050HS-K	5	50	42	22	11	18	10.4	6.3	20	40	16	0.24
	3063HS-K	6	63	49	22	11	18	10.4	6.3	20	40	16	0.24
AMC (AMCM)	3080HS-K	7	80	57	25.4 (27)	14	20	9.5 (12.4)	6 (7)	25 (22)	50	16	0.36
	3100HS-K	8	100	67	31.75 (32)	18	26	12.7 (14.4)	8 (8)	32 (28)	63	16	0.61

( )Metric size

### Available inserts



Designation	Cermet		Coated											Uncoated			page	
	CN2500	CN30	NCM325	NCM335	NCM635	NCM545	PC2505	PC2510	PC3700	PC6510	PC9530	PC9540	PC5300	PC5400	PD2000	G10		H01
APKT 1604PDSR			●						●	●								
1604PDSR-MF			●										●					
1604PDSR-MM			●	●					●	●	●		●					
1604PDFR-MA														●			●	●
1604PDFR-MA2																	●	
160416FR-MA2																	●	
160432FR-MA2																	●	
1604PDFR-MA3																●	●	●
160420FR-MA3																	●	●

E04

### Available arbors

Designation	Ød	NC arbors
AMCM 3040HS-K	16	BT□□-FMC16-□□
3050HS-K	22	BT□□-FMC22-□□
3063HS-K		
AMC (AMCM) 3080HS-K	25.4	BT□□-FMA25.4-□□
	27	BT□□-FMC27-□□
	31.75	BT□□-FMA31.75-□□
3100HS-K	32	BT□□-FMC32-□□

### Parts

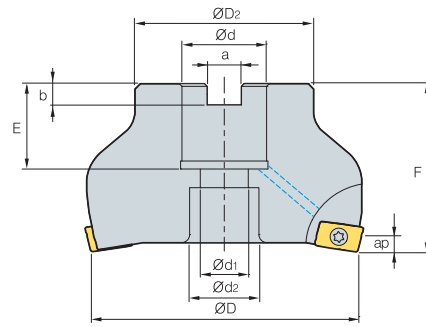
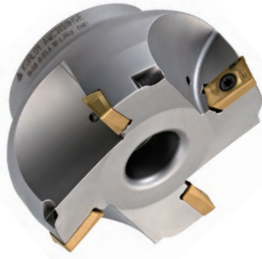
Specification		
Ø40~Ø100	FTKA0410	TW15S

Available inserts E04 Available arbors and bolt E426-E428





## AMC(M)1000SE/2000SE



(mm)

Designation		ØD	ØD2	Ød	Ød1	Ød2	a	b	E	F	ap	
AMCM 1040HSE	4	40	34	16	9	14	8.4	5.6	19	40	2.5	0.26
	5	50	42	22	11	18	10.4	6.3	21	40	2.5	0.39
AMC (AMCM) 2080HSE	5	80	57	25.4 (27)	14	20	9.5 (12.4)	6.0 (7.0)	25 (22)	50	4	1.2
	6	100	67	31.75 (32)	18	26	12.7 (14.4)	8.0 (8.0)	32 (28)	63	4	2.33

( )Metric size

### Available inserts

APMT-MM APMT-MF



Type	Designation	Cermet		Coated										Uncoated		page		
		CN2500	CN30	NC5330	NCM325	NCM335	NCM535	NCM545	PC2505	PC2510	PC3700	PC6510	PC9530	PC9540	PC5300		PC5400	G10
1000 type	APMT 060202PDSR-MM			●							●				●	●		
	0602PDSR-MM			●					●	●	●	●	●		●	●		
	060208PDSR-MM			●							●				●	●		
	060212R-MM			●											●	●		
2000 type	APMT 11T3PDSR-MM			●	●		●		●	●	●	●	●		●	●		
	11T3PDSR-MF			●						●	●				●	●		
	11T308PDSR-MM			●						●		●	●		●	●		
	11T312PDSR-MM			●						●		●			●	●		
	11T316R-MM			●						●					●	●		
	11T318R-MM			●						●					●	●		
	11T324R-MM			●						●					●	●		

E06

### Available arbors

Type	Designation	Ød	NC arbors
1000 type	AMC (AMCM) 1040HSE	16	BT□□-FMC16-□□
	1050HSE	22	BT□□-FMC22-□□
2000 type	AMC (AMCM) 2080HSE	25.4	BT□□-FMA25.4-□□
		27	BT□□-FMC27-□□
	2100HSE	31.75	BT□□-FMA31.75-□□
		32	BT□□-FMC32-□□

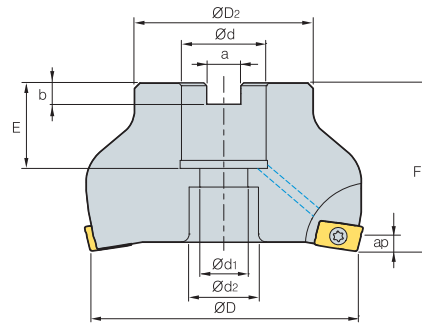
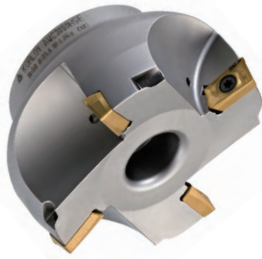
### Parts

Specification			
Ø40~Ø50 (1000 type)	FTKA01842	-	TW06S-A
Ø80~Ø100 (2000 type)	FTKA02565S	TW08S	-

Available inserts E06 Available arbors and bolt E426-E428



# AMC(M)3000SE



Designation			ØD	ØD <sub>2</sub>	Ød	Ød <sub>1</sub>	Ød <sub>2</sub>	a	b	E	F	ap	
AMC (AMCM)	3080HSE	4	80	57	25.4 (27)	14	20	9.5 (12.4)	6.0 (7.0)	25 (22)	50	6	1.3
	3100HSE	5	100	67	31.75 (32)	18	26	12.7 (14.4)	8.0 (8.0)	32 (28)	63	6	2.3

(mm)

( ) Metric size

## Available inserts

APMT-MM      APMT-MF



Designation	Cermet		Coated												Uncoated		page	
	CN2500	CN30	NC5330	NCM325	NCM335	NCM535	NCM545	PC2505	PC2510	PC3700	PC6510	PC9530	PC9540	PC5300	PC5400	G10		H01
APMT 1604PDSR-MM			●	●		●		●	●	●	●	●	●	●	●			E06
1604PDSR-MF			●							●	●			●	●			
160410PDSR-MM										●				●	●			
160416PDSR-MM			●							●				●	●			
160424R-MM			●							●				●	●			
160430R-MM										●				●	●			
160432R-MM			●							●				●	●			

## Available arbors

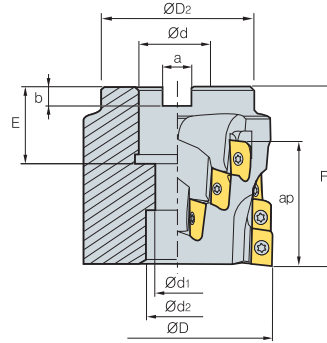
Designation	Ød	NC arbors
AMC (AMCM) 3080HSE	25.4	BT□□-FMA25.4-□□
	27	BT□□-FMC27-□□
3100HSE	31.75	BT□□-FMA31.75-□□
	32	BT□□-FMC32-□□

## Parts

Specification		
Ø80-Ø100	FTKA0410	TW08S

Available inserts **E06**      Available arbors and bolt **E426-E428**

## AMC(M)2000M



(mm)

Designation	Symbol	ØD	ØD <sub>2</sub>	Ød	Ød <sub>1</sub>	Ød <sub>2</sub>	a	b	E	F	No. of flute	ap	Weight (kg)	
AMCM 2050M		16	50	40	22	11	18	10.4	6.3	21	58	4	39	0.7
AMC (AMCM) 2063M		16	63	50	25.4 (27)	13.5	20	9.5 (12.4)	6 (7)	25 (25)	58	4	39	0.8
2080M		20	80	60	31.75 (32)	-	45	12.7 (14.4)	8 (8)	35 (28)	63	5	39	0.96
2100M		24	100	80	38.1 (40)	-	56	15.9 (16.4)	10 (9)	38 (30)	63	6	39	1.2

( )Metric size

### Available inserts



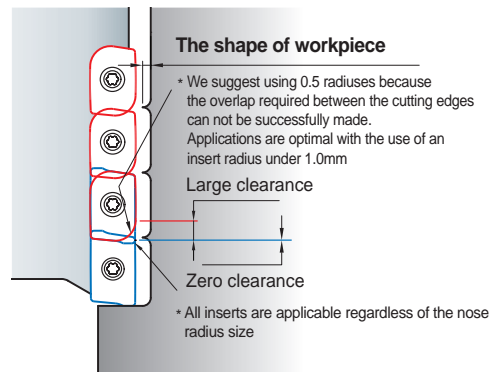
Designation	Cermet		Coated										Uncoated		page			
	CN2500	CN30	NC5330	NCM325	NCM335	NCM535	NCM545	PC2505	PC2510	PC3700	PC6510	PC9530	PC9540	PC5300		PC5400	G10	H01
APMT 11T3PDFR-MA																		●
11T308PDFR-MA																		
11T3PDER-ML														●	●			
11T308PDER-ML														●	●			
11T3PDSR-MM			●	●		●		●	●					●	●			
11T3PDSR-MF			●					●	●					●	●			
11T308PDSR-MM			●					●	●					●	●			
11T312PDSR-MM			●					●	●					●	●			
11T316R-MM			●					●	●					●	●			
11T318R-MM			●					●	●					●	●			
11T324R-MM			●					●	●					●	●			
11T3PDSR-MN2														●	●			
11T3PDSR-MN3														●	●			

※ Please purchase 2 types of APMT-MN (nick type) inserts with different chip breakers. ※ Please use the cutters with even teeth.

### Available arbors

Designation	Ød	NC arbors	
AMC 2050M	22	BT□□-FMC22-□□	BT□□-SMC22-□□
AMC (AMCM) 2063M	25.4	BT□□-FMA25.4-□□	BT□□-SMA25.4-□□
	27	BT□□-FMC27-□□	BT□□-SMC27-□□
2080M	31.75	BT□□-FMA31.75-□□	BT□□-SMA31.75-□□
	32	BT□□-FMC32-□□	BT□□-SMC32-□□
2100M	38.1	BT□□-FMA38.1-□□	BT□□-SMA38.1-□□
	40	BT□□-FMC40-□□	BT□□-SMC40-□□

### Caution when clamping the inserts



### Parts

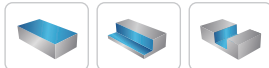
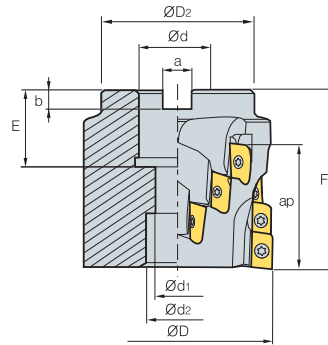
Specification	Screw	Wrench
Ø50~Ø100	FTKA02565S	TW08S

Available inserts E06 Available arbors and bolt E426-E428





# AMC(M)3000M



AA  
90°

- AR: 9°
- RR: -9°~-5°

(mm)

Designation	ØD	ØD2	Ød	Ød1	Ød2	a	b	E	F	No. of flute	ap	
AMC 3063M	63	57	25.4 (27)	14	20	9.5 (12.4)	6 (7)	38 (38)	85	4	57	1.1
(AMCM) 3080M	80	67	31.75 (32)	14	26	12.7 (14.4)	8 (8)	40 (40)	100	4	71	2.23
3100M	100	87	38.1 (40)	22	32	15.9 (16.4)	10 (9)	40 (40)	100	6	71	3.59

( )Metric size

## Available inserts



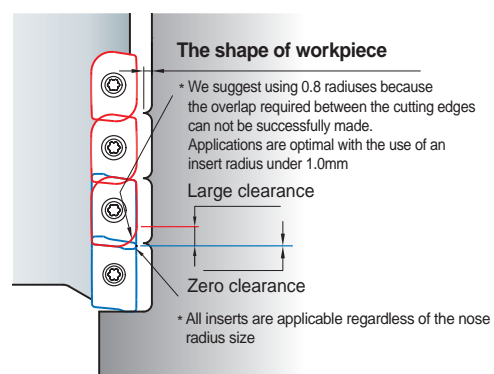
Designation	Cermet		Coated										Uncoated		page		
	CN2500	CN30	NC5330	NCM325	NCM335	NCM535	NCM545	PC2505	PC2510	PC3700	PC6510	PC9530	PC9540	PC5300		PC5400	G10
APMT 1604PDFR-MA																	●
16040PDFR-MA																	
1604PDER-ML														●	●		
16040PDER-ML														●	●		
1604PDSR-MM			●	●		●	●	●	●	●	●	●	●	●	●		
1604PDSR-MF			●						●	●				●	●		
160410PDSR-MM									●	●				●	●		
160416PDSR-MM			●						●	●				●	●		
160424R-MM			●						●	●				●	●		
160430R-MM									●	●				●	●		
160432R-MM			●						●	●				●	●		
1604PDSR-MN3														●			
1604PDSR-MN4														●			

※ Please purchase 2 types of APMT-MN (nick type) inserts with different chip breakers. ※ Please use the cutters with even teeth.

## Available arbors

Designation	Ød	NC arbors	
AMC (AMCM) 3063M	25.4	BT□□-FMA25.4-□□	BT□□-SMA25.4-□□
	27	BT□□-FMC27-□□	BT□□-SMC27-□□
3080M	31.75	BT□□-FMA31.75-□□	BT□□-SMA31.75-□□
	32	BT□□-FMC32-□□	BT□□-SMC32-□□
3100M	38.1	BT□□-FMA38.1-□□	BT□□-SMA38.1-□□
	40	BT□□-FMC40-□□	BT□□-SMC40-□□

## Caution when clamping the inserts

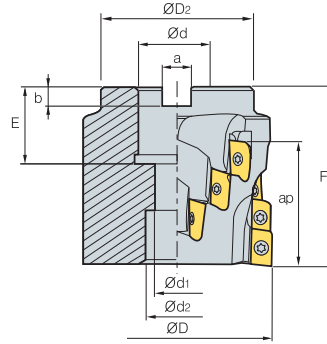


## Parts

Specification		
Ø63-Ø100	FTKA0410	TW15S

Available inserts **E06** Available arbors and bolt **E426-E428**

## AMC(M)4000M



(mm)

Designation	ØD	ØD2	Ød	Ød1	Ød2	a	b	E	F	No. of flute	ap	kg	
AMC 4063M	16	63	57	25.4 (27)	14	20	9.5 (12.4)	6 (7)	38 (38)	85	4	61.1	1.1
(AMCM) 4080M	20	80	67	31.75 (32)	14	26	12.7 (14.4)	8 (8)	40 (40)	100	4	76.1	2.23
4100M	30	100	87	38.1 (40)	22	32	15.9 (16.4)	10 (9)	40 (40)	100	6	76.1	3.59
4125M	18	125	87	38.1 (40)	22	32	15.9 (16.4)	10 (9)	36 (29)	68	6	46.1	4.0

( )Metric size

### Available inserts



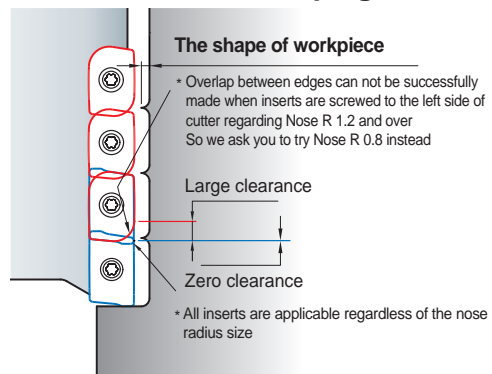
Designation	Coated								page	Designation	Coated								page											
	CN2500	CN30	NCM325	NCM335	NCM535	PC2505	PC2010	PC3700			PC6510	PC9530	PC9540	PC5300	PC5400	G10	H01	Designation		CN2500	CN30	NCM325	NCM335	NCM535	PC2505	PC2510	PC3700	PC6510	PC9530	PC9540
APMT 1806PDFR-MA										E06	APMT 180624PDER-ML											E06								
180604PDFR-MA											180630R-ML																			
180612PDFR-MA											1806PDSR-MM																			
180616PDFR-MA											1806PDSR-MF																			
180620PDFR-MA											180612PDSR-MM																			
180624PDFR-MA											180616PDSR-MM																			
180630R-MA											180620PDSR-MM																			
1806PDER-ML											180624PDSR-MM																			
180604PDER-ML											180630R-MM																			
180612PDER-ML											180632R-MM																			
180616PDER-ML											1806PDSR-MN3																			
180620PDER-ML											1806PDSR-MN4																			

\* Please purchase 2 types of APMT-MN (nick type) inserts with different chip breakers. \* Please use the cutters with even teeth.

### Available arbors

Designation	Ød	NC arbors	
AMC (AMCM) 4063M	25.4	BT□□-FMA25.4-□□	BT□□-SMA25.4-□□
	27	BT□□-FMC27-□□	BT□□-SMC27-□□
4080M	31.75	BT□□-FMA31.75-□□	BT□□-SMA31.75-□□
	32	BT□□-FMC32-□□	BT□□-SMC32-□□
4100M	38.1	BT□□-FMA38.1-□□	BT□□-SMA38.1-□□
	40	BT□□-FMC40-□□	BT□□-SMC40-□□
4125M	38.1	BT□□-FMA38.1-□□	BT□□-SMA38.1-□□
	40	BT□□-FMC40-□□	BT□□-SMC40-□□

### Caution when clamping the inserts



### Parts

Specification	Screw	Wrench
Ø63~Ø125	FTKA0410	TW15S

Available inserts E06 Available arbors and bolt E426-E428



# AMS1000S

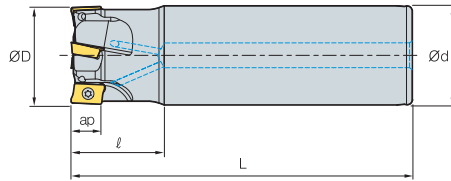


Fig. 1

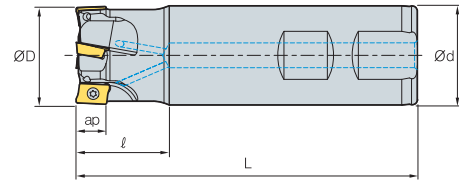


Fig. 2



AA  
90°

- AR: 7.5°~13°
- RR: -17°~-6°

(mm)

Designation		ØD	Ød	ℓ	L	ap		Fig.
<b>AMS</b>								
1010HS	2	10	10	20	80	5.6	0.04	2
1011HS	2	11	10	20	80	5.6	0.04	2
1012HS-2	2	12	12	25	80	5.6	0.06	2
1012HS-2L12	2	12	12	25	120	5.6	0.09	1
1012HS-3	3	12	12	25	80	5.6	0.06	2
1014HS-2	2	14	16	25	90	5.6	0.11	2
1014HS-2L16	2	14	16	25	140	5.6	0.18	1
1014HS-3	3	14	16	25	90	5.6	0.11	2
1015HS	3	15	16	25	90	5.6	0.11	2
1015HS-3L16	3	15	16	25	140	5.6	0.18	1
1016HS-3	3	16	16	25	90	5.6	0.12	2
1016HS-3L16	3	16	16	25	160	5.6	0.22	1
1016HS-4	4	16	16	25	90	5.6	0.12	2
1017HS	4	17	16	25	90	5.6	0.12	2
1017HS-3L16	3	17	16	25	160	5.6	0.22	1
1018HS	4	18	16	25	90	5.6	0.12	2
1018HS-4L16	4	18	16	25	180	5.6	0.25	1
1020HS-4	4	20	20	30	110	5.6	0.23	2
1020HS-4L20	4	20	20	30	200	5.6	0.43	1
1020HS-5	5	20	20	30	110	5.6	0.23	2
1021HS	5	21	20	30	110	5.6	0.24	2
1021HS-4L20	4	21	20	30	200	5.6	0.43	1
1022HS	5	22	20	30	110	5.6	0.27	2
1025HS	7	25	25	30	120	5.6	0.39	2
1026HS	7	26	25	30	120	5.6	0.39	2
1032HS	8	32	32	35	120	5.6	0.65	2
1033HS	8	33	32	35	120	5.6	0.65	2

## Available inserts

APMT-MA APMT-MM



Designation	Cermet		Coated										Uncoated		page			
	CN2500	CN30	NC5330	NCM325	NCM335	NCM535	NCM545	PC2505	PC2510	PC3700	PC6510	PC9530	PC9540	PC5300		PC5400	G10	H01
APMT																	●	E06
0602PDFR-MA																		
060208PDFR-MA																		
060202PDSR-MM			●							●				●	●			
0602PDSR-MM			●					●	●	●	●	●		●	●			
060208PDSR-MM			●							●				●	●			
060212R-MM			●											●	●			
060216R-MM														●	●			

## Parts

Specification		
Ø10~Ø33	FTKA01842	TW06S-A

Available inserts E06

## AMS1500S

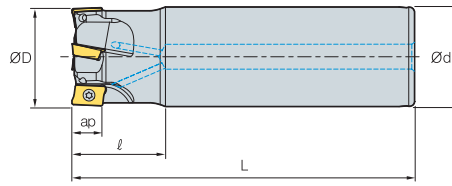


Fig. 1

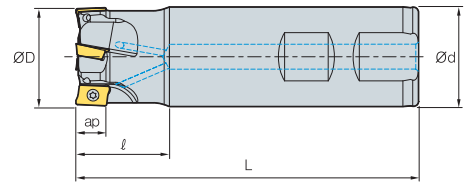


Fig. 2



AA  
90°

• AR: 7.5°~12.5°  
• RR: -28°~-14°

(mm)

Designation		ØD	Ød	ℓ	L	ap		Fig.
AMS 15010HS	1	10	10	25	80	9	0.04	2
15010HS-1L16	1	10	16	30	160	9	0.21	1
15012HS	1	12	16	25	80	9	0.10	2
15012HS-1L16	1	12	16	30	160	9	0.21	1
15013HS	1	13	16	25	80	9	0.10	2
15014HS	1	14	16	25	80	9	0.10	2
15014HS-1L16	1	14	16	30	160	9	0.21	1
15016HS	2	16	16	30	90	9	0.11	2
15016HS-2L16	2	16	16	30	160	9	0.21	1
15017HS	2	17	16	30	90	9	0.12	2
15017HS-2L16	2	17	16	30	160	9	0.21	1
15018HS	2	18	16	30	90	9	0.14	2
15018HS-2L16	2	18	16	30	160	9	0.21	1
15019HS	2	19	16	30	90	9	0.16	2
15020HS	2	20	20	30	90	9	0.18	2
15020HS-2L20	2	20	20	30	160	9	0.34	1
15020HS-3	3	20	20	30	90	9	0.18	2
15021HS	2	21	20	30	90	9	0.20	2
15021HS-2L20	2	21	20	30	160	9	0.34	1
15021HS-3	3	21	20	30	90	9	0.20	2
15022HS	3	22	20	30	110	9	0.23	2
15022HS-3L20	3	22	20	30	180	9	0.38	1
15024HS	3	24	20	30	110	9	0.30	2
15024HS-4	4	24	20	30	110	9	0.30	2
15025HS-3S20	3	25	20	30	110	9	0.35	2
15025HS	3	25	25	30	110	9	0.35	2
15025HS-3L25	3	25	25	30	180	9	0.59	1

### Available inserts

APMT-MA APMT-ML APMT-MM



Designation	Cermet		Coated										Uncoated		page			
	CN2500	CN30	NC5330	NCM325	NCM325	NCM635	NCM645	PC2505	PC2510	PC3700	PC6510	PC9530	PC9540	PC5300		PC5400	G10	H01
APMT 0903PDFR-MA																	●	E06
090308PDFR-MA																		
0903PDER-ML														●	●			
090308PDER-ML														●	●			
0903PDSR-MM			●					●	●	●	●			●	●			
090308PDSR-MM			●							●	●			●	●			
090312R-MM										●	●			●	●			
090316R-MM			●							●	●			●	●			
090320R-MM										●	●			●	●			

### Parts

Specification		
Ø10~Ø14	FTKA02555S	TW08S
Ø16~Ø25	FTKA02565S	

Available inserts E06



# AMS1500S

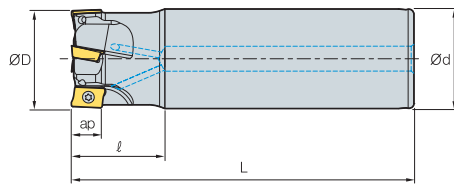


Fig. 1

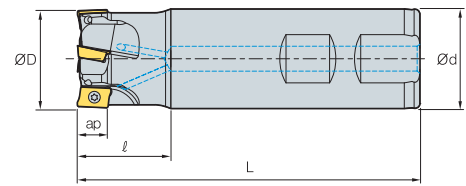


Fig. 2



AA  
90°  
• AR: 7.5°~12.5°  
• RR: -28°~-14°

(mm)

Designation		ØD	Ød	ℓ	L	ap		Fig.
AMS 15025HS-4S20	4	25	20	30	110	9	0.25	2
15025HS-4S25	4	25	25	30	110	9	0.25	2
15028HS	4	28	25	30	110	9	0.36	2
15028HS-4L25	4	28	25	30	180	9	0.61	1
15028HS-5	5	28	25	30	110	9	0.36	2
15030HS	4	30	25	30	110	9	0.38	2
15030HS-4L25	4	30	25	30	180	9	0.62	1
15030HS-5	5	30	25	30	110	9	0.38	2
15032HS	4	32	32	30	110	9	0.60	2
15032HS-4L32	4	32	32	30	180	9	1.00	1
15032HS-5	5	32	32	30	110	9	0.60	2
15035HS	5	35	32	30	110	9	0.70	2
15035HS-6	6	35	32	30	110	9	0.70	2
15040HS-S32	5	40	32	35	130	9	0.80	2
15040HS-5L32	5	40	32	35	200	9	1.20	1
15040HS-6S32	6	40	32	35	130	9	0.80	2
15040HS-S40	5	40	40	35	130	9	1.13	2
15040HS-6S40	6	40	40	35	130	9	1.13	2
15040HS-S42	5	40	42	35	130	9	1.23	2
15040HS-6S42	6	40	42	35	130	9	1.23	2

## Available inserts

APMT-MA APMT-ML APMT-MM



Designation	Cermet		Coated											Uncoated		page		
	CN2500	CN30	NC5330	NCM325	NCM335	NCM535	NCM545	PC2505	PC2510	PC3700	PC6510	PC9530	PC9540	PC5300	PC5400		G10	H01
APMT 0903PDFR-MA																	●	E06
090308PDFR-MA																		
0903PDER-ML														●	●			
090308PDER-ML														●	●			
0903PDSR-MM			●					●	●	●	●			●	●			
090308PDSR-MM			●							●	●			●	●			
090312R-MM										●	●			●	●			
090316R-MM			●							●	●			●	●			
090320R-MM										●	●			●	●			

## Parts

Specification		
Ø25~Ø40	FTKA02565S	TW08S

Available inserts E06

## AMS2000S

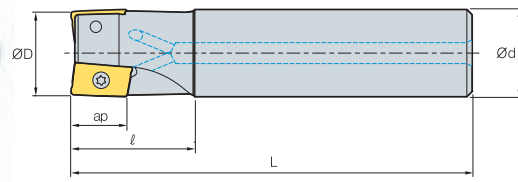


Fig. 1

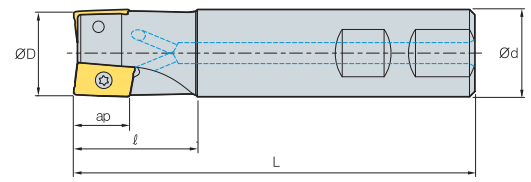


Fig. 2



AA  
90°

- AR: 3°~14°
- RR: -25°~-18°

(mm)

Designation		ØD	Ød	ℓ	L	ap		Fig.
AMS 2010HS	1	10	10	20	85	11	0.04	2
2010HS-1L16	1	10	16	30	160	11	0.21	1
2012HS	1	12	16	25	85	11	0.10	2
2012HS-1L16	1	12	16	30	160	11	0.21	1
2014HS	1	14	16	25	90	11	0.12	2
2014HS-1L16	1	14	16	30	160	11	0.21	1
2016HS	2	16	16	25	90	11	0.12	2
2016HS-2L16	2	16	16	30	180	11	0.21	1
2018HS	2	18	16	25	90	11	0.12	2
2018HS-2L16	2	18	16	30	180	11	0.21	1
2020HS	2	20	20	30	100	11	0.21	2
2020HS-2L20	2	20	20	30	210	11	0.49	1
2022HS	3	22	20	35	115	11	0.25	2
2022HS-3L20	3	22	20	35	180	11	0.38	1
2025HS	3	25	25	35	115	11	0.40	2
2025HS-3L25	3	25	25	40	180	11	0.59	1
2032HS	4	32	32	40	125	11	0.70	2
2032HS-4L32	4	32	32	50	180	11	1.00	1
2040HS	5	40	32	42	130	11	0.84	2
2040HS-5L32	5	40	32	50	200	11	1.20	1
2040HS-S40	5	40	40	42	130	11	1.15	2
2040HS-S42	5	40	42	42	130	11	2.00	2
2050HS	6	50	32	45	135	11	1.06	2
2050HS-S40	6	50	40	45	135	11	1.38	2
2050HS-S42	6	50	42	45	135	11	1.50	2
2063HS	8	63	32	45	135	11	1.31	2
2063HS-S40	8	63	40	45	135	11	1.62	2
2063HS-S42	8	63	42	45	135	11	1.70	2

### Available inserts



Designation	Cermet		Coated										Uncoated		page			
	CN2500	CN30	NC5330	NCM325	NCM335	NCM535	NCM545	PC2505	PC2510	PC3700	PC6510	PC9530	PC9540	PC5300		PC5400	G10	H01
APMT 11T3PDFR-MA																		●
11T308PDFR-MA																		
11T3PDER-ML																		
11T308PDER-ML																		
11T3PDSR-MM			●	●		●		●	●	●	●	●		●	●			
11T3PDSR-MF			●					●	●	●	●			●	●			
11T308PDSR-MM			●					●	●	●	●	●	●	●	●			
11T312PDSR-MM			●					●	●	●	●	●	●	●	●			
11T316R-MM			●					●	●	●	●	●	●	●	●			
11T318R-MM														●	●			
11T324R-MM			●							●				●	●			
11T3PDSR-MN2														●	●			
11T3PDSR-MN3														●	●			

### Parts

\* Please purchase 2 types of APMT-MN (nick type) inserts with different chip breakers. \* Please use the cutters with even teeth.

Specification		
Ø10~Ø14	FTKA02555S	TW08S
Ø16~Ø63	FTKA02565S	



# AMS3000S

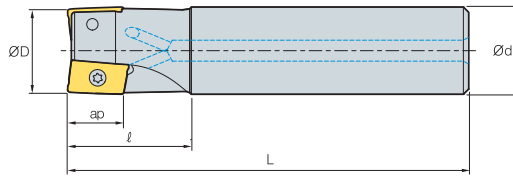


Fig. 1

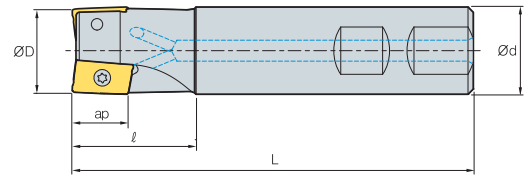


Fig. 2



- AR: 3°~14°
- RR: -18°~-10°

(mm)

Designation		ØD	Ød	ℓ	L	ap		Fig.
AMS 3025HS	2	25	25	35	115	16	0.40	2
3025HS-2M25	2	25	25	35	180	16	0.65	1
3025HS-2L25	2	25	25	60	220	16	0.75	1
3032HS	3	32	32	40	125	16	0.69	2
3032HS-2M32	2	32	32	40	200	16	1.13	1
3032HS-2L32	2	32	32	65	260	16	1.52	1
3032HS-3M32	3	32	32	40	200	16	1.12	1
3032HS-3L32	3	32	32	65	260	16	1.48	1
3040HS	4	40	32	42	130	16	0.80	2
3040HS-3M32	3	40	32	42	200	16	1.24	1
3040HS-3L32	3	40	32	42	260	16	1.61	1
3040HS-4M32	4	40	32	42	200	16	1.21	1
3040HS-4L32	4	40	32	42	260	16	1.58	1
3040HS-S40	4	40	40	42	130	16	1.10	2
3040HS-S42	4	40	42	42	130	16	1.20	2
3050HS	5	50	32	45	135	16	1.00	2
3050HS-S40	5	50	40	45	135	16	1.30	2
3050HS-S42	5	50	42	45	135	16	1.40	2
3063HS	6	63	32	45	135	16	1.25	2
3063HS-S40	6	63	40	45	135	16	1.50	2
3063HS-S42	6	63	42	45	135	16	1.54	2

## Available inserts



Designation	Cermet		Coated										Uncoated		page			
	CN2500	CN30	NC5330	NCM325	NCM335	NCM535	NCM545	PC2505	PC2510	PC3700	PC6510	PC9530	PC9540	PC5300		PC5400	G10	H01
APMT 1604PDR-MA																		
160404PDR-MA																		
1604PDR-ML																		
160404PDR-ML																		
1604PDR-MM			●	●		●		●	●	●	●	●	●	●	●			
1604PDR-MF			●							●	●			●	●			
160410PDR-MM										●				●	●			
160416PDR-MM			●							●				●	●			
160424R-MM			●							●				●	●			
160430R-MM										●				●	●			
160432R-MM			●							●				●	●			
1604PDR-MN3														●	●			
1604PDR-MN4														●	●			

※ Please purchase 2 types of APMT-MN (nick type) inserts with different chip breakers. ※ Please use the cutters with even teeth.

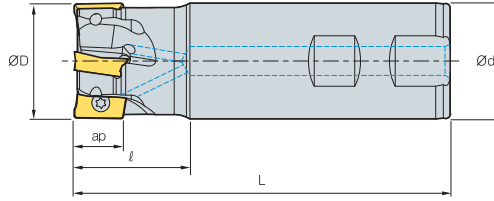
## Parts

Specification		
Ø25 Ø32-Ø63	FTKA0408 FTKA0410	TW15S

Available inserts E06



## AMS3000S-K

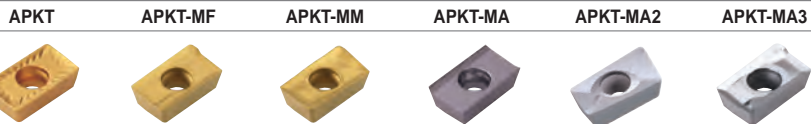


AA  
90°  
• AR: 14°  
• RR: -18°~-10°

(mm)

Designation		ØD	Ød	ℓ	L	ap	
AMS 3025HS-K	2	25	25	35	115	16	0.4
3032HS-K	3	32	32	40	125	16	0.69
3040HS-K	4	40	32	42	130	16	0.8
3040HS-K-S40	4	40	40	42	130	16	1.1
3040HS-K-S42	4	40	42	42	130	16	1.2
3050HS-K	5	50	32	45	135	16	1.0
3050HS-K-S40	5	50	40	45	135	16	1.3
3050HS-K-S42	5	50	42	45	135	16	1.4
3063HS-K	6	63	32	45	135	16	1.25
3063HS-K-S40	6	63	40	45	135	16	1.5
3063HS-K-S42	6	63	42	45	135	16	1.54

### Available inserts



Designation	Cermet		Coated												Uncoated			page
	CN2500	CN30	NCM325	NCM335	NCM635	NCM645	PC2505	PC2510	PC3700	PC6510	PC9530	PC9540	PC5300	PC5400	PD2000	G10	H01	
APKT 1604PDSR			●						●	●								
1604PDSR-MF			●										●					
1604PDSR-MM			●	●					●	●	●		●					
1604PDFR-MA															●		●	●
1604PDFR-MA2																	●	
160416FR-MA2																	●	
160432FR-MA2																	●	
1604PDFR-MA3																●	●	●

### Parts

Specification		
Ø25 Ø32-Ø63	FTKA0408 FTKA0410	TW15S

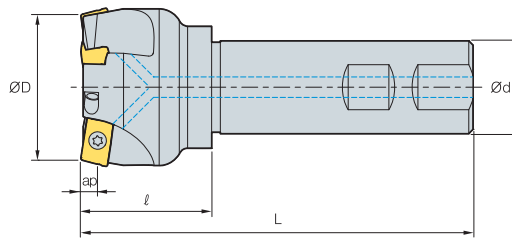
Available inserts E04







# AMS1000SE/2000SE



AA  
75°

- AR: -4.5°~-1°
- RR: -3°~0°

(mm)

Designation		ØD	Ød	ℓ	L	ap	
AMS 1025HSE	3	25	25	30	115	2.5	0.41
AMS 2025HSE	2	25	25	30	115	4	0.4
2032HSE	3	32	32	40	125	4	0.72
2040HSE	3	40	32	40	130	4	0.86
2040HSE-S40	3	40	40	40	130	4	1.2
2040HSE-S42	3	40	42	40	130	4	1.3
2050HSE	4	50	32	40	135	4	0.98
2050HSE-S40	4	50	40	40	135	4	1.3
2050HSE-S42	4	50	42	40	135	4	1.4
2063HSE	5	63	32	40	135	4	1.24
2063HSE-S40	5	63	40	40	135	4	1.57
2063HSE-S42	5	63	42	40	135	4	1.62

## Available inserts

APMT-MF      APMT-MM



Type	Designation	Cermet		Coated										Uncoated		page		
		CN2500	CN30	NC5330	NCM325	NCM335	NCM535	NCM545	PC2505	PC2510	PC3700	PC6510	PC9530	PC9540	PC5300		PC5400	G10
1000 type	APMT 060202PDSR-MM			●														
	0602PDSR-MM			●					●	●	●	●		●	●			
	060208PDSR-MM			●						●				●	●			
	060212R-MM			●										●	●			
	060216R-MM			●										●	●			
2000 type	APMT 11T3PDSR-MM			●	●		●		●	●	●	●		●	●			
	11T3PDSR-MF			●						●	●			●	●			
	11T308PDSR-MM			●						●		●		●	●			
	11T312PDSR-MM			●						●		●		●	●			
	11T316R-MM			●						●				●	●			
	11T318R-MM			●										●	●			
	11T324R-MM			●						●				●	●			

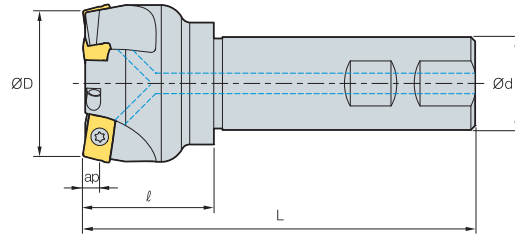
## Parts

Specification			
Ø25 (1000 type)	FTKA01842	-	TW06S-A
Ø25~Ø63 (2000 type)	FTKA02565S	TW08S	-

Available inserts **E06**



## AMS3000SE



AA  
75°

- AR: -4.5°~-1°
- RR: -3°~0°

(mm)

Designation		ØD	Ød	l	L	ap	
AMS 3050HSE	3	50	32	45	135	6	1.0
3050HSE-S40	3	50	40	45	135	6	1.3
3050HSE-S42	3	50	42	45	135	6	1.4
3063HSE	4	63	32	45	135	6	1.3
3063HSE-S40	4	63	40	45	135	6	1.6
3063HSE-S42	4	63	42	45	135	6	1.7

### Available inserts

APMT-MF

APMT-MM



Designation	Cermet		Coated										Uncoated		page			
	CN2500	CN30	NC5330	NCM325	NCM335	NCM535	NCM545	PC2505	PC2510	PC3700	PC6510	PC9530	PC9540	PC5300		PC5400	G10	H01
APMT 1604PDSR-MM			●	●		●		●	●	●	●	●	●	●	●			E06
1604PDSR-MF			●								●			●	●			
160410PDSR-MM										●				●	●			
160416PDSR-MM			●							●				●	●			
160424R-MM			●							●				●	●			
160430R-MM										●				●	●			
160432R-MM			●							●				●	●			

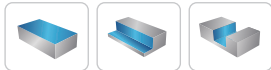
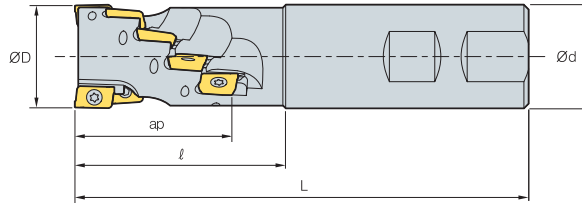
### Parts

Specification		
Ø50-Ø63	FTKA0410	TW15S

Available inserts E06



# AMS1000M/1500M



AA  
90°

- AR: 7°~9°
- RR: -13°~-10°

(mm)

Designation		ØD	Ød	l	L	No. of flute	ap	
AMS 1016M	6	16	16	30	80	2	15.5	0.3
	12	20	20	32	85	3	20.5	0.3
	20	25	25	39	95	4	25.5	0.3
AMS 15020M	3	20	20	42	105	1	26.5	0.3
	8	25	25	50	110	2	35	0.3
	10	32	32	60	120	2	44	0.3

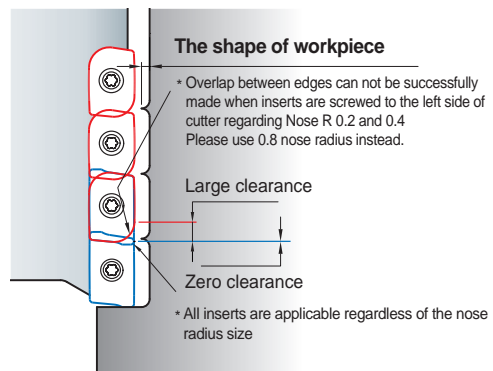
## Available inserts

APMT-MA APMT-ML APMT-MM



Type	Designation	Cermet		Coated											Uncoated		page		
		CN2500	CN30	NC5330	NCM325	NCM335	NCM635	NCM645	PC2505	PC2510	PC3700	PC6510	PC9530	PC9540	PC5300	PC5400		G10	H01
1000 type	APMT 0602PDFR-MA																	●	E06
	APMT 060208PDFR-MA																		
	APMT 060202PDSR-MM			●							●				●	●			
	APMT 0602PDSR-MM			●					●	●	●	●	●		●	●			
	APMT 060208PDSR-MM			●							●				●	●			
	APMT 060212R-MM			●											●	●			
1500 type	APMT 060216R-MM													●	●				
	APMT 0903PDFR-MA																●		
	APMT 090308PDFR-MA																		
	APMT 0903PDER-ML														●	●			
	APMT 090308PDER-ML														●	●			
	APMT 0903PDSR-MM			●					●	●	●	●			●	●			
	APMT 090308PDSR-MM			●							●				●	●			
	APMT 090312R-MM										●				●	●			
APMT 090316R-MM			●							●				●	●				
APMT 090320R-MM										●				●	●				

## Caution when clamping the inserts

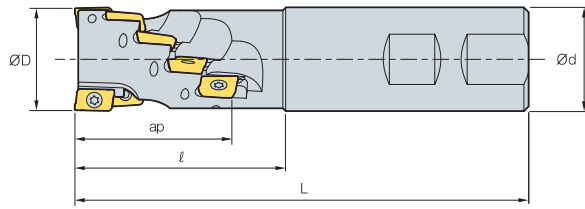


## Parts

Specification			
Ø16~Ø25 (1000 type)	FTKA01842	-	TW06S-A
Ø20~Ø32 (1500 type)	FTKA02565S	TW08S	-

Available inserts **E06**

## AMS2000M



AA  
90°  
• AR: 7°~9°  
• RR: -13°~-10°

(mm)

Designation		ØD	Ød	l	L	No. of flute	ap	
AMS 2020M	3	20	20	45	120	1	29.4	0.32
2025M	8	25	25	55	130	2	38.9	0.40
2032M	10	32	32	65	140	2	48.5	0.65
2040M	14	40	40	75	150	2	58	0.75

### Available inserts

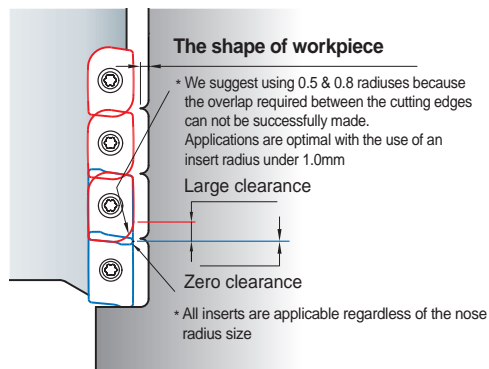


Designation	Cermet		Coated										Uncoated		page			
	CN2500	CN30	NC5330	NCM325	NCM335	NCM635	NCM645	PC2505	PC2510	PC3700	PC6510	PC9530	PC9540	PC5300		PC5400	G10	H01
APMT 11T3PDFR-MA																		●
11T308PDFR-MA																		
11T3PDER-ML														●	●			
11T308PDER-ML														●	●			
11T3PDSR-MM			●	●		●		●	●	●	●	●		●	●			
11T3PDSR-MF			●						●	●				●	●			
11T308PDSR-MM			●						●		●	●		●	●			
11T312PDSR-MM			●						●		●	●		●	●			
11T316R-MM			●						●					●	●			
11T318R-MM														●	●			
11T324R-MM			●						●					●	●			
11T3PDSR-MN2														●				
11T3PDSR-MN3														●				

E06

※ Please purchase 2 types of APMT-MN (nick type) inserts with different chip breakers. ※ Please use the cutters with even teeth.

### Caution when clamping the inserts



### Parts

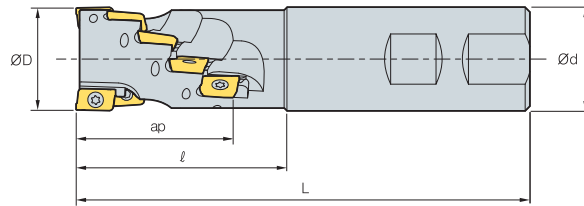
Specification		
Ø20~Ø40	FTKA02565S	TW08S

Available inserts E06





# AMS4000M



AA  
90°

- AR: 7°~9°
- RR: -13°~10°

(mm)

Designation		ØD	Ød	l	L	No. of flute	ap	
AMS	4032M	4	32	32	60	130	2	0.65
	4040M	6	40	40	70	140	2	1.11
	4050M-S40	6	50	40	55	125	2	1.22
	4050M	8	50	40	70	140	2	1.37

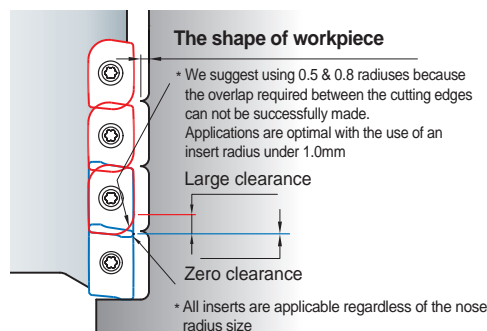
## Available inserts



Designation	Cermet		Coated											Uncoated		page																				
	CN2500	CN30	NC5330	NCM325	NCM335	NCM535	NCM545	PC2505	PC2510	PC3700	PC6510	PC9530	PC9540	PC5300	PC5400		G10	H01																		
APMT	<div style="display: flex; justify-content: space-between; align-items: center;"> <span>1806PDFR-MA</span> <span>180604PDFR-MA</span> <span>180612PDFR-MA</span> <span>180616PDFR-MA</span> <span>180620PDFR-MA</span> <span>180624PDFR-MA</span> <span>180630R-MA</span> <span>1806PDER-ML</span> <span>180604PDER-ML</span> <span>180612PDER-ML</span> <span>180616PDER-ML</span> <span>180620PDER-ML</span> <span>180624PDER-ML</span> <span>180630R-ML</span> <span>1806PDSR-MM</span> <span>1806PDSR-MF</span> <span>180612PDSR-MM</span> <span>180616PDSR-MM</span> <span>180620PDSR-MM</span> <span>180624PDSR-MM</span> <span>180630R-MM</span> <span>180632R-MM</span> <span>1806PDSR-MN3</span> <span>1806PDSR-MN4</span> </div>																		•	•	•	•	•	•	•	•	•	•	•	•	•	•	•	•	•	
																			•	•	•	•	•	•	•	•	•	•	•	•	•	•	•	•	•	•
																			•	•	•	•	•	•	•	•	•	•	•	•	•	•	•	•	•	•
																			•	•	•	•	•	•	•	•	•	•	•	•	•	•	•	•	•	•
																			•	•	•	•	•	•	•	•	•	•	•	•	•	•	•	•	•	•
																			•	•	•	•	•	•	•	•	•	•	•	•	•	•	•	•	•	•
																			•	•	•	•	•	•	•	•	•	•	•	•	•	•	•	•	•	•
																			•	•	•	•	•	•	•	•	•	•	•	•	•	•	•	•	•	•
																			•	•	•	•	•	•	•	•	•	•	•	•	•	•	•	•	•	•
																			•	•	•	•	•	•	•	•	•	•	•	•	•	•	•	•	•	•
																			•	•	•	•	•	•	•	•	•	•	•	•	•	•	•	•	•	•
																			•	•	•	•	•	•	•	•	•	•	•	•	•	•	•	•	•	•
																			•	•	•	•	•	•	•	•	•	•	•	•	•	•	•	•	•	•
																			•	•	•	•	•	•	•	•	•	•	•	•	•	•	•	•	•	•
																			•	•	•	•	•	•	•	•	•	•	•	•	•	•	•	•	•	•
																			•	•	•	•	•	•	•	•	•	•	•	•	•	•	•	•	•	•
																			•	•	•	•	•	•	•	•	•	•	•	•	•	•	•	•	•	•
																			•	•	•	•	•	•	•	•	•	•	•	•	•	•	•	•	•	•

※ Please purchase 2 types of APMT-MN (nick type) inserts with different chip breakers.  
 ※ Please use the cutters with even teeth.

## Caution when clamping the inserts



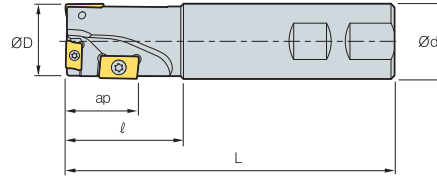
## Parts

Specification		
Ø32~Ø50	FTKA0410	TW15S

Available inserts **E06**



## AMS1000MH/1500MH



AA 90°  
 • AR: 9°~12°  
 • RR: -12°~-10°

(mm)

Designation		ØD	Ød	l	L	ap		APMT 0602	APMT 0903	APM(X)T 11T3 -	APMT 1604	APKT 1604 -
AMS 1014MH	3	14	12	30	120	11	0.16	3	-	-	-	-
	3	16	14	30	140	11	0.20	3	-	-	-	-
	3	18	16	30	140	11	0.21	3	-	-	-	-
AMS 15020MH	3	20	20	35	140	17	0.31	1	2	-	-	-

### Available inserts

APMT-MA APMT-ML APMT-MM



Type	Designation	Cermet		Coated										Uncoated		page		
		CN2500	CN30	NC5330	NCM325	NCM335	NCM535	NCM545	PC2505	PC2510	PC3700	PC6510	PC9530	PC9540	PC5300		PC5400	G10
1000 type	APMT 0602PDFR-MA																	●
	060208PDFR-MA																	
	060202PDSR-MM			●						●					●	●		
	0602PDSR-MM			●					●	●	●	●	●		●	●		
	060208PDSR-MM			●							●				●	●		
1500 type	APMT 0903PDFR-MA																	●
	090308PDFR-MA																	
	0903PDER-ML													●	●			
	090308PDER-ML													●	●			
	0903PDSR-MM			●					●	●	●	●		●	●			
090308PDSR-MM			●							●			●	●				

### Recommended cutting condition



	Drilling	Shouldering	Slotting
vc(m/min)	80~200	80~200	80~200
fz(mm/t)	0.03~0.06	0.05~0.25	0.05~0.20

- Please keep the drill depth under 0.25D when you're drilling
- Please keep the step depth from 0.2 to 0.3mm

### Parts

Specification			
	Screw	Wrench	Wrench
Ø14~Ø18 (1000 type)	FTKA01842	-	TW06S-A
Ø20 (1500 type)	FTKA02565S	TW08S	-

Available inserts E06



# AMS2000MH/3000MH(-K)

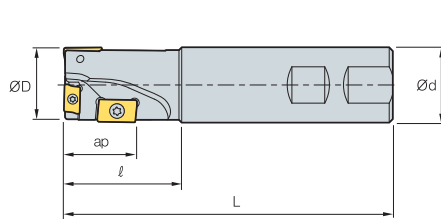


Fig. 1

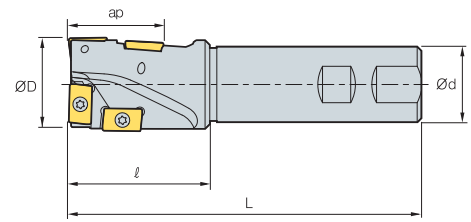


Fig. 2



- AR: 9°~12°
- RR: -12°~-10°

(mm)

Designation		ØD	Ød	l	L	ap		APMT 0602	APMT 0903	APM(X)T 11T3 -	APMT 1604	APKT 1604 -	Fig.
AMS 2025MH	3	25	25	40	130	20	0.45	-	-	3	-	-	1
2032MH	3	32	32	50	140	30	0.75	-	-	1	2	-	1
AMS 3040MH	4	40	32	60	150	40	0.90	-	-	-	4	-	2
3040MH-K	4	40	32	60	150	40	0.90	-	-	-	-	4	2

## Available inserts



Type	Designation	Cermet		Coated										Uncoated	page			
		CN2500	CN30	NC5330	NCM325	NCM335	NCM535	NCM545	PC2505	PC2510	PC3700	PC6510	PC9530			PC9540	PC5300	PC5400
2000 type	APMT 11T3PDFR-MA																●	E06
	11T308PDFR-MA																	
	11T3PDER-ML																	
	11T308PDER-ML																	
	11T3PDSR-MM			●	●		●		●	●	●	●		●	●			
	11T3PDSR-MF			●					●	●				●	●			
	11T308PDSR-MM			●					●		●	●		●	●			
	11T312PDSR-MM			●					●			●		●	●			
	11T316R-MM			●					●					●	●			
	11T318R-MM			●					●					●	●			
11T324R-MM			●					●		●			●	●				
3000 type	APMT 1604PDSR-MM			●	●				●	●	●	●		●	●			
	1604PDSR-MF			●					●	●			●	●				
3000-K type	APKT 1604PDSR-MM				●	●				●	●	●		●				
	1604PDSR-MF				●								●					

## Parts

Specification			
	Screw	Wrench	Wrench
Ø25 (2000 type)	FTKA02565S	TW08S	-
Ø32 (2000 type)	FTKA02565S+FTKA0410	TW08S+TW15S	-
Ø40 (3000 type)	FTKA0410	TW15S	-

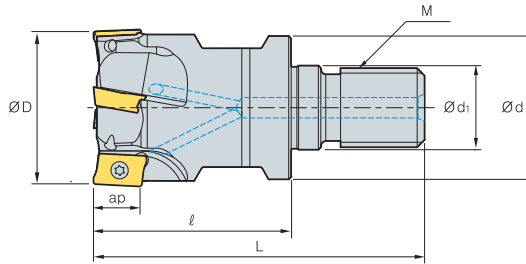
Available inserts **E06**

## Recommended cutting condition

	Drilling	Shouldering	Slotting
vc(m/min)	80~200	80~200	80~200
fz(mm/t)	0.03~0.06	0.05~0.25	0.05~0.20

- Please keep the drill depth under 0.25D when you're drilling
- Please keep the step depth from 0.2 to 0.3mm

## AMM1000



• AR: 7.5°~12.5°  
• RR: -28°~-6°

(mm)

Designation		ØD	Ød	Ød1	l	L	M	ap	
AMM 1012HR-M06	3	12	11	6.5	25	40	M06	5.6	0.02
1016HR-M08	4	16	14.5	8.5	25	42	M08	5.6	0.03
1020HR-M10	5	20	18	10.5	30	51	M10	5.6	0.07
1025HR-M12	7	25	23	12.5	35	59	M12	5.6	0.12
1032HR-M16	8	32	29	17	40	67	M16	5.6	0.23

### Available inserts

APMT-MA APMT-MM



Designation	Cermet		Coated										Uncoated		page			
	CN2500	CN30	NC5330	NCM325	NCM335	NCM535	NCM545	PC2505	PC2510	PC3700	PC6510	PC9530	PC9540	PC5300		PC5400	G10	H01
APMT 0602PDFR-MA																		●
060208PDFR-MA																		
060202PDSR-MM			●							●				●	●			
0602PDSR-MM			●					●	●	●	●			●	●			
060208PDSR-MM			●							●				●	●			
060212R-MM			●											●	●			
060216R-MM														●	●			

### Available adaptor

Designation	Available adaptor
AMM 1012HR-M06	MAT-M06
1016HR-M08	MAT-M08
1020HR-M10	MAT-M10
1025HR-M12	MAT-M12
1032HR-M16	MAT-M16

Designation : AMM1032HR-M16  
Modular head threading measure size (M16)

II

Adaptor spec.: MAT-M16-035-S32S  
Adaptor threading measure (M16)

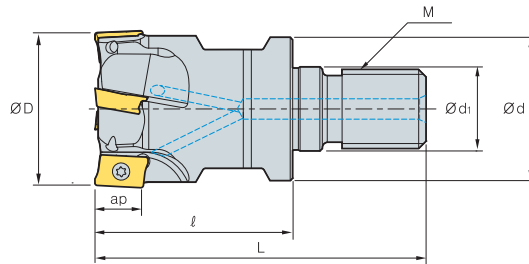
### Parts

Specification		
Ø12~Ø32	FTKA01842	TW06S-A

Available inserts E06 Available adaptor E401-E402



# AMM1500



• AR: 7.5°~12.5°  
• RR: -28°~-6°

(mm)

Designation		ØD	Ød	Ød1	l	L	M	ap	
AMM 15010HR-M06	1	10	9.5	6.5	25	40	M06	9	0.01
15012HR-M06	1	12	11	6.5	25	40	M06	9	0.02
15016HR-M08	2	16	14.5	8.5	25	42	M08	9	0.03
15020HR-M10	2	20	18	10.5	30	51	M10	9	0.06
15025HR-M12	3	25	23	12.5	35	59	M12	9	0.12
15032HR-M16	4	32	29	17	40	67	M16	9	0.22

## Available inserts

APMT-MA APMT-ML APMT-MM



Designation	Cermet		Coated											Uncoated		page		
	CN2500	CN30	NC5330	NCM825	NCM835	NCM835	NCM635	NCM645	PC2505	PC2510	PC3700	PC6510	PC9530	PC9540	PC6300		PC5400	G10
APMT 0903PDFR-MA																		●
090308PDFR-MA																		
0903PDER-ML															●	●		
090308PDER-ML															●	●		
0903PDSR-MM			●					●	●	●	●				●	●		
090308PDSR-MM			●												●	●		
090312R-MM															●	●		
090316R-MM			●												●	●		
090320R-MM															●	●		

## Available adaptor

Designation	Available adaptor
AMM 15010HR-M06	MAT-M06
15012HR-M06	
15016HR-M08	MAT-M08
15020HR-M10	MAT-M10
15025HR-M12	MAT-M12
15032HR-M16	MAT-M16

Designation : AMM15032HR-M16  
Modular head threading measure size (M16)

II

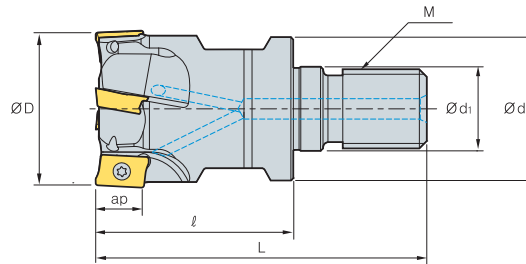
Adaptor spec.: MAT-M16-035-S32S  
Adaptor threading measure (M16)

## Parts

Specification		
Ø10~Ø14	FTKA02555S	TW08S
Ø16~Ø100	FTKA02565S	TW08S

Available inserts E06 Available adaptor E401-E402

## AMM2000



• AR: 7.5°~12.5°  
• RR: -28°~-6°

(mm)

Designation		ØD	Ød	Ød1	l	L	M	ap	
AMM 2016HR-M08	2	16	14.5	8.5	25	42	M08	11	0.04
2020HR-M10	2	20	18	10.5	30	51	M10	11	0.07
2025HR-M12	3	25	23	12.5	35	59	M12	11	0.04
2032HR-M16	4	32	29	17	40	67	M16	11	0.23
2040HR-M16	5	40	29	17	40	67	M16	11	0.25

### Available inserts



Designation	Cermet		Coated												Uncoated		page	
	CN2500	CN30	NC5330	NCM325	NCM335	NCM535	NCM545	PC2505	PC2510	PC3700	PC6510	PC9530	PC9540	PC5300	PC5400	G10		H01
APMT 11T3PDR-MA																		●
11T308PDR-MA																		
11T3PDR-ML																		
11T308PDR-ML																		
11T3PDR-MM			●	●		●		●	●	●	●	●	●	●	●	●	●	
11T3PDR-MF			●							●	●				●	●		
11T308PDR-MM			●							●	●		●		●	●		
11T312PDR-MM			●							●			●		●	●		
11T316R-MM			●							●					●	●		
11T318R-MM																		
11T324R-MM			●							●					●	●		
11T3PDR-MN2															●			
11T3PDR-MN3															●			

\* Please purchase 2 types of APMT-MN (nick type) inserts with different chip breakers. \* Please use the cutters with even teeth.

### Available adaptor

Designation	Available adaptor
AMM 2016HR-M08	MAT-M08
2020HR-M10	MAT-M10
2025HR-M12	MAT-M12
2032HR-M16	MAT-M16
2040HR-M16	

Designation : AMM2032HR-M16  
Modular head threading measure size (M16)

||

Adaptor spec.: MAT-M16-035-S32S  
Adaptor threading measure (M16)

### Parts

Specification		
Ø16~Ø40	FTKA02565S	TW08S

Available inserts E06 Available adaptor E401-E402



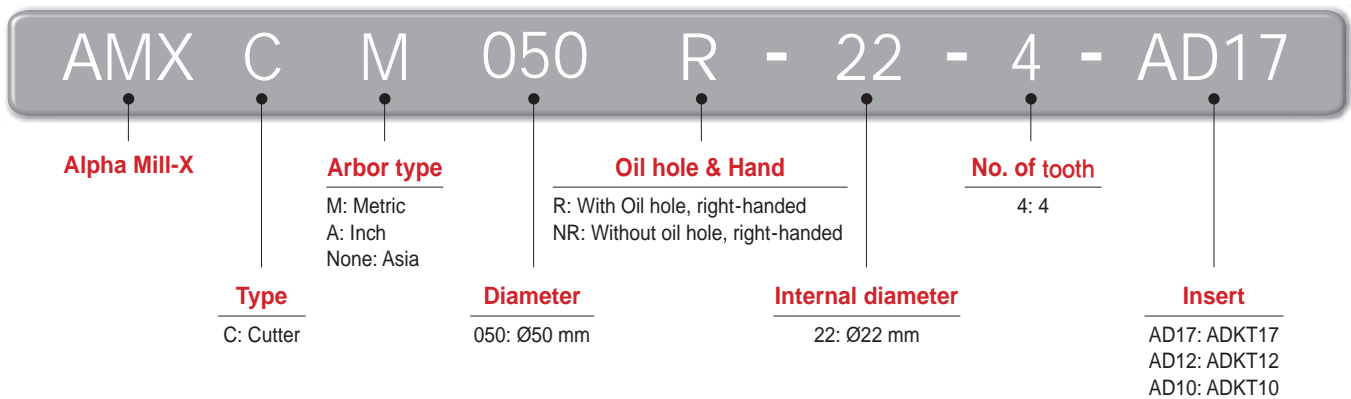
## Shoulder milling tool for high helix

# Alpha Mill-X **new**

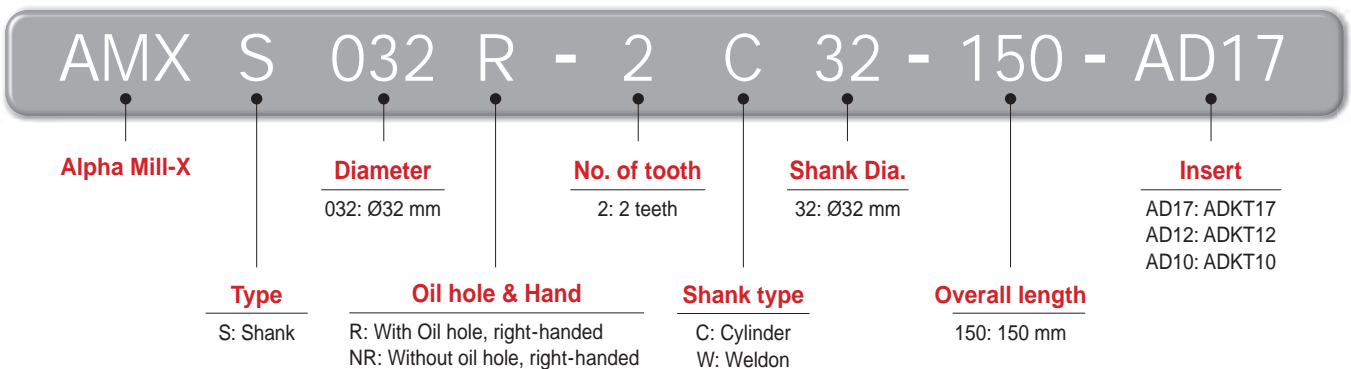
- High helix cutting edge realizes high speed and high feed machining (15% higher speed than conventional tool's machining) and increases 20% higher productivity.
- Highly precise cutting edge ensures high quality surface finish in milling.

### Code system

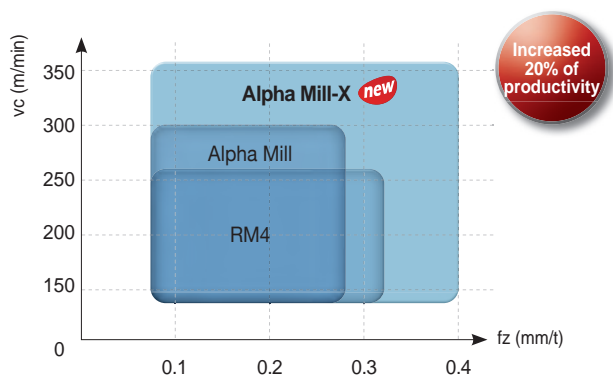
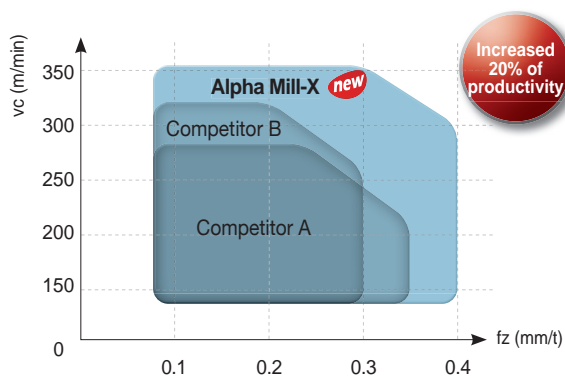
#### • Cutter



#### • Shank



### Application area





# E Technical Information for Alpha Mill-X

## Features of insert

**High rake angle chip breaker**

- Applied high rake angle
- Improved chip control

**Proprietary relief surface shape**

- High rigidity of insert

**Max. ap**  
 ADKT17 : 16.5 mm  
 ADKT12 : 11.5 mm  
 ADKT10 : 9.5 mm

**Applied minor cutting edge with a wiper function**

- Minor cutting edge design optimized for excellent surface finish

**Flat clamping area**

- Stable clamping in high speed and high feed machining

**High rake cutting edge**

- Better surface toughness
- Lower cutting load

**Existing Alpha Mill**  
(APMT1604PDSR-MM)

**Alpha Mill-X**  
(ADKT170608PESR-MM)

- Applying cutting edge with high rake angle: decreased cutting load
- Thicker insert: high rigidity of insert

▶ Optimal for high speed and high feed machining

## Cutter features

**High rake angle cutting edge**

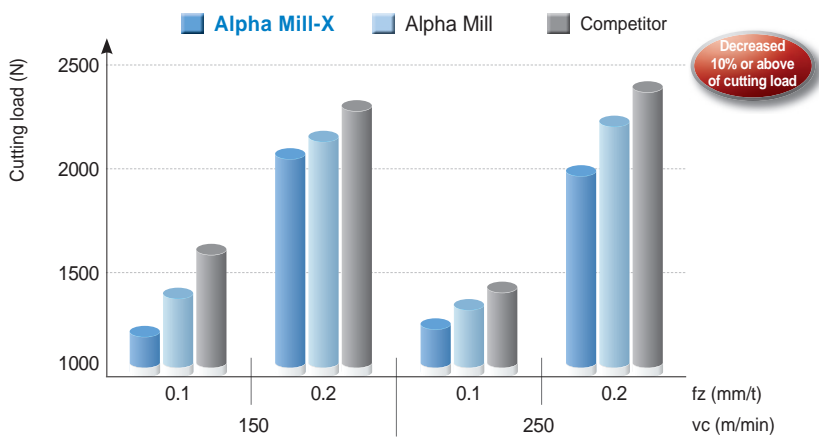
- Improved surface finish
- Decreased cutting load

**Wider chip pocket**

- Maximized chip control
- Outstanding chip control in high speed and high feed machining

Perfect perpendicularity

## Cutting load



## Recommended cutting conditions

### In face machining and shouldering

Workpiece		Grade	Cutting speed vc (m/min)	Feed, fz (mm/t)		
				ADKT17	ADKT12	ADKT10
P	Steel	PC5300	150-240	0.3-0.05	0.25-0.05	0.2-0.05
		PC5400	130-210			
		PC3700	160-270			
		NCM535	250-350			
M	Stainless steel	PC5300	90-150	0.25-0.05	0.2-0.05	0.15-0.05
		PC5400	70-120			
		PC9540	50-120			
K	Cast iron	PC6510	150-200	0.35-0.08	0.3-0.08	0.25-0.08
		PC5300	120-200			
		NCM535	200-300			
S	HRSA	PC5300	40-70	0.2-0.05	0.15-0.05	0.1-0.05
		PC5400	30-50			

\* The above data refer to general cutting conditions and can be adjustable up to 350 m/min and 0.4 mm/t depending on user environment.



### In grooving, ramping and helical machining

Workpiece		Grade	Cutting speed vc (m/min)	Feed, fz (mm/t)		
				ADKT17	ADKT12	ADKT10
P	Steel	PC5300	150-240	0.15-0.05	0.15-0.05	0.15-0.05
		PC5400	130-210			
		PC3700	160-270			
		NCM535	250-350			
M	Stainless steel	PC5300	90-150	0.15-0.05	0.15-0.05	0.15-0.05
		PC5400	70-120			
		PC9540	50-120			
K	Cast iron	PC6510	150-250	0.2-0.08	0.2-0.08	0.2-0.08
		PC5300	120-200			
		NCM535	200-300			
S	HRSA	PC5300	40-70	0.15-0.05	0.15-0.05	0.1-0.05
		PC5400	30-50			

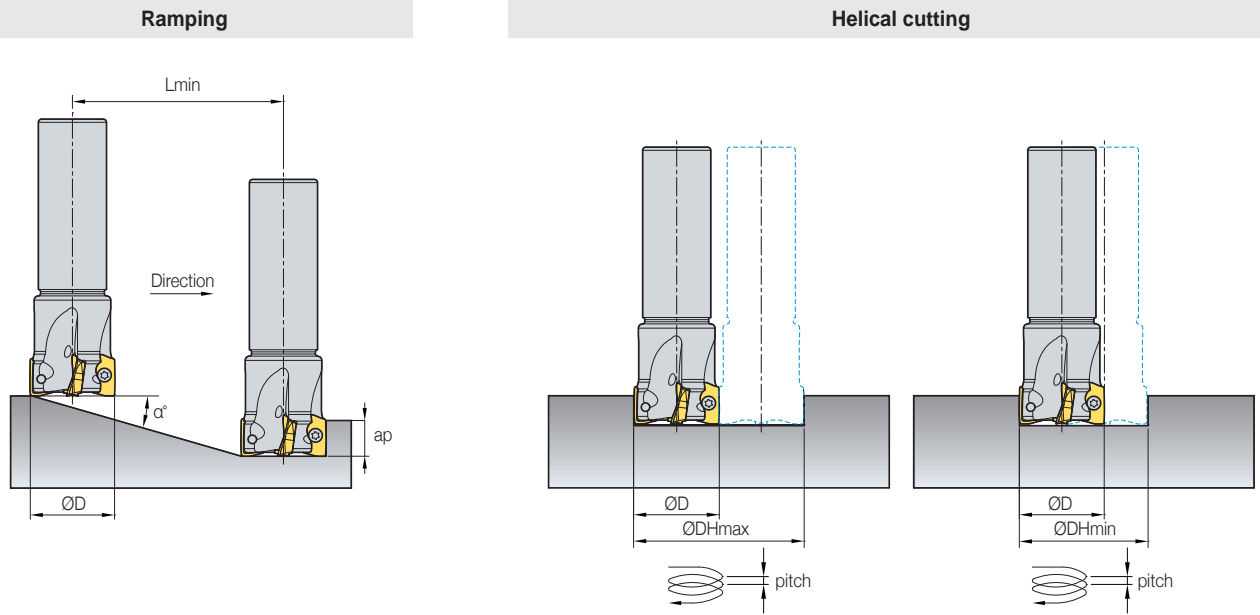
\* In deep grooving, set the ap under 5 mm and use coolant and air.

## Recommended grades and chip breakers

(● : 1<sup>st</sup> Recommendation)

C/B	Cutting edge	P		M		K		N		S			
		Low carbon steel/ Mild steel		High carbon steel/ Alloy steel		Stainless steel		Cast iron		Non-ferrous metal			
		C/B	Grade	C/B	Grade	C/B	Grade	C/B	Grade	C/B	Grade		
ML		-	● PC3700 ○ PC5300 ○ PC5400 ○ NCM535	-	● PC3700 ○ PC5300 ○ PC5400 ○ NCM535	●	● PC5300 ○ PC5400 ○ PC9540	-	● PC6510 ○ PC5300 ○ PC5400 ○ NCM535	-	-	●	● PC5300 ○ PC5400
MM		●	● PC3700 ○ PC5300 ○ PC5400 ○ NCM535	●	● PC3700 ○ PC5300 ○ PC5400 ○ NCM535	-	● PC5300 ○ PC5400 ○ PC9540	●	● PC6510 ○ PC5300 ○ PC5400 ○ NCM535	-	-	-	● PC5300 ○ PC5400

## ➤ Cutting condition for ramping and helical operation



(mm)

Designation	Tool dia. ØD (min)	ap	Ramping		Blind hole helical cutting				Through hole helical cutting	
			Max. rake angle $\alpha^\circ$	Lmin	Min. desirable hole dia. ØDHmin	Max. pitch dmax	Max. desirable hole dia. ØDHmax	Max. pitch dmax	Min. desirable hole dia. ØDHmin	Max. pitch dmax
ADKT17	20	16.5	13	71	30	7.0	38	8.9	21	4.8
	25		8.0	117	40	5.7	48	6.8	31	4.3
	32		3.7	255	54	3.5	62	4.0	45	2.9
	33		3.6	262	56	3.5	64	4.1	47	2.9
	40		2.6	363	70	3.2	78	3.6	61	2.8
	50		1.9	497	90	3.0	98	3.3	81	2.7
	63		1.3	727	116	2.6	124	2.8	107	2.4
	80		1.1	859	150	2.9	158	3.0	141	2.7
	100		0.7	1350	190	2.3	198	2.4	181	2.2
	125	0.5	1891	240	2.1	248	2.2	231	2.0	
ADKT12	18	11.5	7.0	98	29	3.6	34	4.2	23	2.8
	20		5.5	125	33	3.2	38	3.7	27	2.6
	25		3.5	196	43	2.7	48	3.0	37	2.3
	32		2.5	275	57	2.5	62	2.7	51	2.2
	33		2.4	286	59	2.5	64	2.7	53	2.2
	40		1.5	458	73	1.9	78	2.1	67	1.7
	50		1.2	573	93	2.0	98	2.1	87	1.8
	63		1.0	687	119	2.1	124	2.2	113	2.0
	80	0.7	982	153	1.9	158	1.9	147	1.8	
ADKT10	16	9.5	4.5	121	28	2.2	31	2.5	24	1.9
	18		3.5	155	32	2.0	35	2.2	28	1.7
	20		3.0	181	36	1.9	39	2.1	32	1.7
	25		2.2	247	46	1.8	49	1.9	42	1.6
	32		1.5	363	60	1.6	63	1.7	56	1.5
	33		1.4	389	62	1.5	65	1.6	58	1.4
	40		1.2	454	76	1.6	79	1.7	72	1.5
	50		0.8	680	96	1.3	99	1.4	92	1.3
	63		0.6	907	122	1.3	125	1.3	118	1.2
	80	0.5	1089	156	1.4	159	1.4	152	1.3	

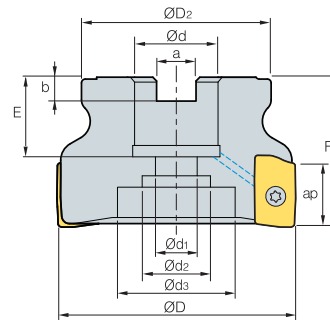
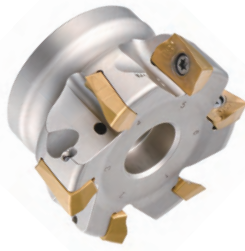
※ In ramping and helical machining, use coolant and air.

※ Lmin : Cutting length in machining with Min. rake angle  
 $\alpha^\circ$  : Rake angle for ramping  
 ap : Depth of cut in axial direction

$$Lmin = \frac{ap}{\tan \alpha^\circ} \text{ (mm)}$$



# AMXCM-AD10/12 new



• AR: 8°  
• RR: -10°~-3°

(mm)

Designation	⊙	ØD	ØD2	Ød	Ød1	Ød2	Ød3	a	b	E	F	ap	$\frac{kg}{kg}$	
AMXCM	040R-16-5-AD10	5	40	35	16	9	14	-	8.4	5.6	19	40	9.5	0.18
	040R-16-6-AD10	6	40	35	16	9	14	-	8.4	5.6	19	40	9.5	0.18
	050R-22-6-AD10	6	50	42	22	11	18	-	10.4	6.3	20	40	9.5	0.23
	050R-22-7-AD10	7	50	42	22	11	18	-	10.4	6.3	20	40	9.5	0.20
	063R-22-7-AD10	7	63	49	22	11	18	-	10.4	6.3	20	40	9.5	0.44
	063R-22-8-AD10	8	63	49	22	11	18	-	10.4	6.3	20	40	9.5	0.49
	080R-27-8-AD10	8	80	57	27	14	25	38	12.4	7	23	50	9.5	0.88
	080R-27-9-AD10	9	80	57	27	14	25	38	12.4	7	23	50	9.5	0.90
AMXCM	040R-16-4-AD12	4	40	35	16	9	14	-	8.4	5.6	19	40	11.5	0.18
	040R-16-5-AD12	5	40	35	16	9	14	-	8.4	5.6	19	40	11.5	0.16
	050R-22-5-AD12	5	50	42	22	11	18	-	10.4	6.3	20	40	11.5	0.23
	050R-22-7-AD12	7	50	42	22	11	18	-	10.4	6.3	20	40	11.5	0.20
	063R-22-6-AD12	6	63	49	22	11	18	-	10.4	6.3	20	40	11.5	0.44
	063R-22-7-AD12	7	63	49	22	11	18	-	10.4	6.3	20	40	11.5	0.49
	080R-27-7-AD12	7	80	57	27	14	25	38	12.4	7	23	50	11.5	0.88
	080R-27-8-AD12	8	80	57	27	14	25	38	12.4	7	23	50	11.5	0.90

## Available inserts

ADKT-ML      ADKT-MM



Type	Designation	Cermet		Coated										Uncoated		page		
		CN2500	CN30	NC5330	NCM325	NCM335	NCM535	NCM545	PC2505	PC2010	PC3700	PC6510	PC9530	PC9540	PC5300		PC5400	G10
10 type	ADKT 10T304PEER-ML						●			●	●		●	●	●			E04
	ADKT 10T304PESR-MM						●			●	●		●	●	●			
	ADKT 10T308PESR-MM																	
	ADKT 10T312PESR-MM																	
12 type	ADKT 120408PESR-ML						●			●	●		●	●	●			
	ADKT 120408PESR-MM						●			●	●		●	●	●			
	ADKT 120412PESR-MM									●	●		●	●	●			
	ADKT 120416PESR-MM									●	●		●	●	●			

## Available arbors

Designation	Ød	Available arbors
AMXCM 040R-16-□-AD□□	16	BT□□-FMC16-□□
AMXCM 050R-22-□-AD□□	22	BT□□-FMC22-□□

Designation	Ød	Available arbors
AMXCM 063R-22-□-AD□□	22	BT□□-FMC22-□□
AMXCM 080R-27-□-AD□□	27	BT□□-FMC27-□□

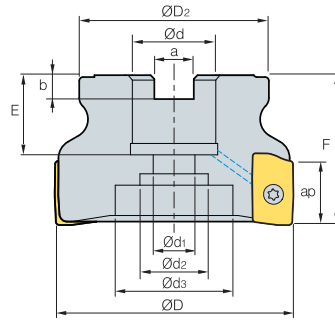
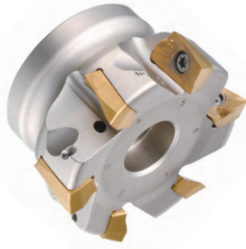
## Parts

Specification	Screw	Wrench
Ø40~Ø80 (10 type)	FTKA02555S	TW08S
Ø40~Ø80 (12 type)	FTNA0306	TW09S

Available inserts E04      Available arbors and bolt E426~E428



## AMXCM-AD17 new



AA  
**90°**  
• AR: 8°  
• RR: -10°~-3°

(mm)

Designation	ØD	ØD <sub>2</sub>	Ød	Ød <sub>1</sub>	Ød <sub>2</sub>	Ød <sub>3</sub>	a	b	E	F	ap	kg
AMXCM 040R-16-3-AD17	40	35	16	9	14	-	8.4	5.6	19	40	16.5	0.18
040R-16-4-AD17	40	35	16	9	14	-	8.4	5.6	19	40	16.5	0.18
050R-22-4-AD17	50	42	22	11	18	-	10.4	6.3	20	40	16.5	0.23
050R-22-5-AD17	50	42	22	11	18	-	10.4	6.3	20	40	16.5	0.20
063R-22-5-AD17	63	49	22	11	18	-	10.4	6.3	20	40	16.5	0.44
063R-22-6-AD17	63	49	22	11	18	-	10.4	6.3	20	40	16.5	0.49
080R-27-6-AD17	80	57	27	14	25	38	12.4	7	23	50	16.5	0.88
080R-27-7-AD17	80	57	27	14	25	38	12.4	7	23	50	16.5	0.90
100R-32-8-AD17	100	70	32	18	28	45	14.4	8	28	63	16.5	1.76
100R-32-10-AD17	100	70	32	18	28	45	14.4	8	28	63	16.5	1.68
125R-40-8-AD17	125	90	40	22	32	54	16.4	9	30	63	16.5	2.89
125R-40-10-AD17	125	90	40	22	32	54	16.4	9	30	63	16.5	4.83

### Available inserts

ADKT-ML ADKT-MM



Designation	Cermet		Coated												Uncoated		page	
	CN2500	CN30	NC5330	NCM325	NCM335	NCM535	NCM545	PC2505	PC2010	PC3700	PC6510	PC9530	PC9540	PC5300	PC5400	G10		H01
ADKT 170608PESR-ML						●				●	●		●	●	●			E04
170604PESR-MM										●				●				
170608PESR-MM						●				●	●		●	●	●			
170616PESR-MM														●	●			
170620PESR-MM														●	●			

### Available arbors

Designation	Ød	Available arbors	Designation	Ød	Available arbors
AMXCM 040R-16-□-AD□□	16	BT□□-FMC16-□□	AMXCM 080R-27-□-AD□□	27	BT□□-FMC27-□□
050R-22-□-AD□□	22	BT□□-FMC22-□□	100R-32-□-AD□□	32	BT□□-FMC32-□□
063R-22-□-AD□□			125R-40-□-AD□□	40	BT□□-FMC40-□□

### Parts

Specification	Screw	Wrench
Ø40~Ø125	FTKA0408	TW15S

Available inserts E04 Available arbors and bolt E426-E428



# AMXS-AD10/12 new

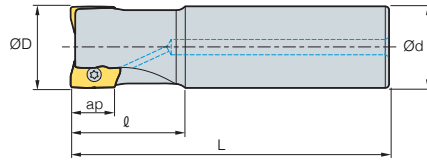


Fig. 1

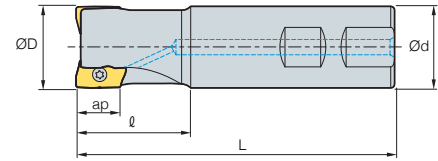


Fig. 2



- AR: 8°
- RR: -10°~-3°

(mm)

Designation		ØD	Ød	ℓ	L	ap		Fig.
AMXS	016R-2W16-90-AD10	2	16	16	25	90	0.110	2
	016R-2C16-180-AD10	2	16	16	25	180	0.190	1
	018R-2W16-100-AD10	2	18	16	35	100	0.120	2
	018R-2C16-200-AD10	2	18	16	35	200	0.210	1
	020R-3W20-100-AD10	3	20	20	35	100	0.250	2
	020R-3C20-200-AD10	3	20	20	35	200	0.490	1
	025R-4W25-115-AD10	4	25	25	40	115	0.400	2
	025R-4C25-200-AD10	4	25	25	40	200	0.590	1
	032R-4W32-125-AD10	4	32	32	45	125	0.700	2
	032R-4C32-200-AD10	4	32	32	45	200	1.000	1
	040R-5W32-130-AD10	5	40	32	50	130	1.050	2
	040R-5C32-200-AD10	5	40	32	50	200	1.200	1
AMXS	018R-2W16-100-AD12	2	18	16	35	100	0.120	2
	018R-2C16-200-AD12	2	18	16	35	200	0.210	1
	020R-2W20-100-AD12	2	20	20	35	100	0.250	2
	020R-2C20-200-AD12	2	20	20	35	200	0.490	1
	025R-3W25-115-AD12	3	25	25	40	115	0.400	2
	025R-3C25-200-AD12	3	25	25	40	200	0.590	1
	032R-4W32-125-AD12	4	32	32	45	125	0.700	2
	032R-4C32-200-AD12	4	32	32	45	200	1.000	1
	040R-4W32-130-AD12	4	40	32	50	130	1.050	2
	040R-4C32-200-AD12	4	40	32	50	200	1.200	1

## Available inserts

ADKT-ML      ADKT-MM



Type	Designation	Cermet		Coated										Uncoated		page		
		CN2500	CN30	NC5330	NCM325	NCM335	NCM535	NCM545	PC2505	PC2010	PC3700	PC6510	PC9530	PC9540	PC5300		PC5400	G10
10 type	ADKT 10T304PEER-ML						●				●	●		●	●			E04
	10T304PESR-MM						●			●	●		●	●				
	10T308PESR-MM													●	●			
	10T312PESR-MM														●	●		
12 type	ADKT 120408PESR-ML						●				●	●		●	●			E04
	120408PESR-MM						●			●	●		●	●				
	120412PESR-MM									●	●		●	●				
	120416PESR-MM									●	●		●	●				

## Parts

Specification		
Ø16-Ø40 (10 type)	FTKA02555S	TW08S
Ø18-Ø40 (12 type)	FTNA0306	TW09S

Available inserts E04      Available arbors and bolt E426-E428

## AMXS-AD17 new

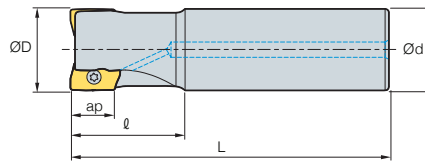


Fig. 1

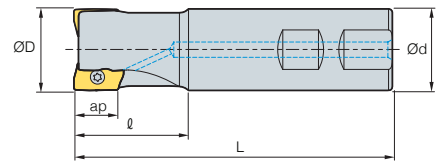


Fig. 2



AA  
90°  
•AR: 8°  
•RR: -10°~-3°

(mm)

	Designation		ØD	Ød	ℓ	L	ap		Fig.
AMXS	020R-1W20-100-AD17	1	20	20	35	100	16.5	0.170	2
	020R-1C20-200-AD17	1	20	20	35	200	16.5	0.360	1
	025R-2W25-115-AD17	2	25	25	35	115	16.5	0.610	2
	025R-2C25-200-AD17	2	25	25	35	200	16.5	0.450	1
	032R-3W32-125-AD17	3	32	32	45	125	16.5	0.620	2
	032R-3C32-200-AD17	3	32	32	45	200	16.5	1.050	1
	033R-3W32-125-AD17	3	33	32	45	125	16.5	0.620	2
	033R-3C32-200-AD17	3	33	32	45	200	16.5	1.050	1
	040R-3W32-130-AD17	3	40	32	50	130	16.5	0.750	2
	040R-3C32-200-AD17	3	40	32	50	200	16.5	1.170	1
	040R-4W32-130-AD17	4	40	32	50	130	16.5	0.740	2
	040R-4C32-200-AD17	4	40	32	50	200	16.5	1.200	1

### Available inserts

ADKT-ML ADKT-MM



Designation	Cermet		Coated											Uncoated		page		
	CN2500	CN30	NC5330	NCM325	NCM335	NCM535	NCM545	PC2505	PC2010	PC3700	PC6510	PC9530	PC9540	PC5300	PC5400		G10	H01
ADKT 170608PESR-ML						●				●	●		●	●	●			E04
170604PESR-MM										●				●				
170608PESR-MM						●				●	●		●	●	●			
170616PESR-MM														●	●			
170620PESR-MM														●	●			

### Parts

Specification		
Ø20-Ø40	FTKA0408	TW15S

Available inserts E04 Available arbors and bolt E426-E428





**Rigid body employs high tensile aluminum**

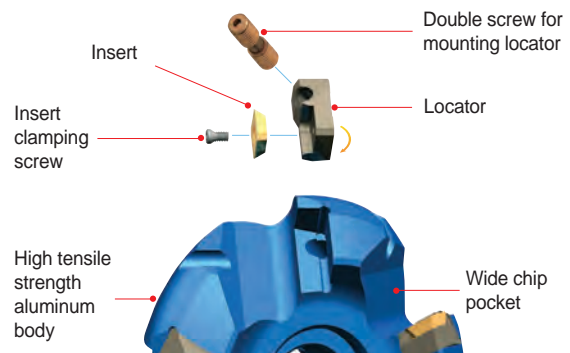
# Future Mill

- Light-weight aluminum body (50% of steel body) can be used for high speed cutting, tapping center, and on low power machines
- Easy handling
- It can be used for aluminum alloys, medium cutting of steel, and cast iron
- Rigid body employs high tensile aluminum
- Locators for excellent durability
- A variety of chip breaker are available
- The high rake angle provides low cutting loads and good surface roughness

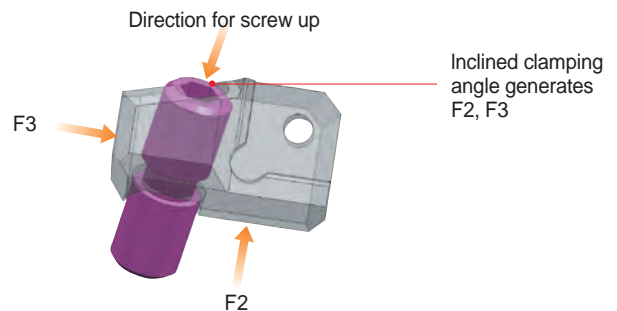
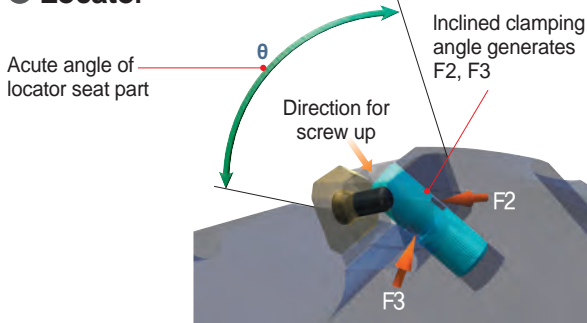
## Features of cutter

- Strong clamping between aluminum body and locator with double screw provides high efficiency
- Acute angle of locator seat provides strong clamping
- Wide chip pocket area provides good chip evacuation
- High tensile strength aluminum body

## Assembly structure of cutter

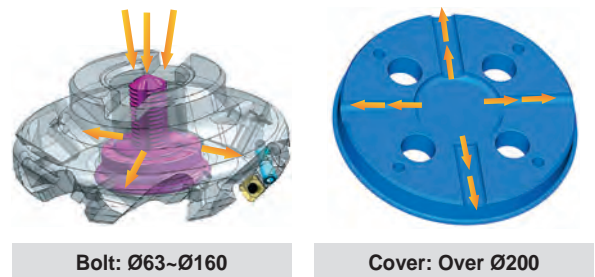


## Locator

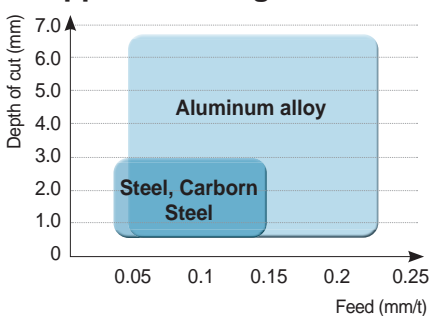


## Through coolant system

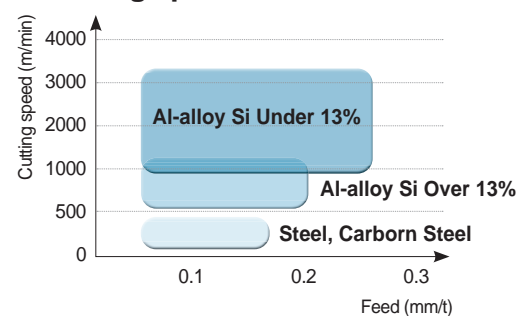
- Exclusively designed coolant bolt and cover provide excellent coolant action and chip evacuation for improved tool life
- Exact coolant direction to cutting area
- Exclusive coolant bolt and cover are sold separately. Through coolant arbor is required



## Application range



## Cutting speed



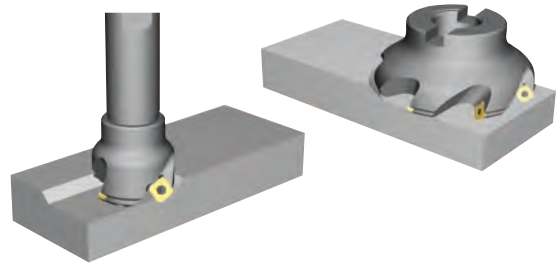
## Max. available revolution

Cutter diameter	Max. revolution (rpm)
Ø63	20,000
Ø80	16,000
Ø100	13,000
Ø125	10,000
Ø160	8,000
Ø200	6,500
Ø250	5,000
Ø315	4,000

## Future Mill (FMA)

### Features

- General milling cutter for high productivity
- Adjustable pitch of cutter and various chip breaker offer wide application range.
- Light cutter body allows high speed cutting and can be used in low horse power machine
- Smooth cutting with low cutting load is accomplished with high-rake angle



### Features of chip breaker

Insert	Cutting-edge	Uses	Features
None C/B		Light cutting	Superior surface roughness at finishing due to ground type cermet insert
MF		Light cutting	Superior cutting quality for light and difficult-to-cut material machining through the low cutting load of chip breaker
MM		General cutting	Suitable for various cutting due to special shape design for general cutting
MR		Roughing	Tough cutting-edge provides stable cutting performance in severe interruption
MA		For aluminum	Superior cutting quality for aluminum due to sharp cutting-edge and buffed surface - S□ET-MA: Sharp cutting-edge due to high accurate grinding - S□XT-MA: Suitable cutting-edge for roughing

### Recommended cutting condition

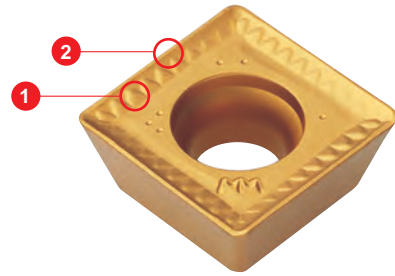
ISO	Grades	vc (m/min)	MF	MM	MR	MA
			fz (mm/t)	fz (mm/t)	fz (mm/t)	fz (mm/t)
P	NC5330	210~350	0.05~0.20	0.10~0.30	0.10~0.30	-
	NCM325	190~310	0.05~0.20	0.10~0.30	0.10~0.30	-
	PC3700	160~270	0.05~0.20	0.10~0.30	0.10~0.30	-
M	PC9530	90~150	0.05~0.15	0.10~0.30	-	-
	NCM335	70~120	0.05~0.15	0.10~0.30	-	-
K	PC5300	110~180	0.05~0.20	0.10~0.30	-	-
N	H01	260~440	-	-	-	0.10~0.35



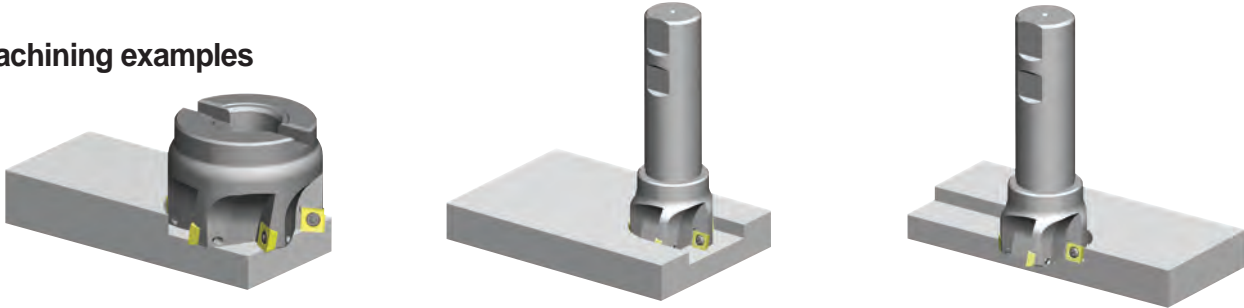
# Future Mill (FMP)

## Features

- The strong cutting-edge ensures excellent tool life in high feed and high speed, deep depth of cut, with low cutting loads
- Optimal grades for most workpieces make high efficiency cutting possible
- Unique chip breaker makes good chip evacuation and lower cutting loads (1)
- Innovative curve cutting-edge lowers cutting load and provides a stronger cutting-edge (2)



## Machining examples



## Features of chip breaker

- Innovative special cutting-edge and chip breaker design ensures ideal 90° cutting and low cutting load
- Various applications are available with multi functional cutters (Facing, Slotting, Shouldering)
- Improved tool life due to special coated grades
- Superior cutting quality at deep cutting depth through the low cutting load and strong cutting-edge

## Recommended C/B and grade as per workpiece

Insert	Cutting-edge	Uses	Recommended C/B and grade as per workpiece (●: 1st)										
			Low carbon steel/Mild steel		High carbon steel/Mild steel		Stainless steel		Cast iron		Aluminum alloy		
			C/B	Grades	C/B	Grades	C/B	Grades	C/B	Grades	C/B	Grades	
MF			Low cutting load type	●	○ NCM325 ○ NC5330 ● NCM335		● NCM325 ○ NC5330 ○ NCM335	●	○ NCM325 ○ NC5330 ● NCM335	●	● PC6510 ○ PC215K	-	-
MM			Reinforced cutting edge type		○ NCM325 ○ NC5330 ● NCM335		● NCM325 ○ NC5330 ○ NCM335		○ NCM325 ○ NC5330 ● NCM335		● PC6510 ○ PC215K	-	-
MA			Sharp cutting edge type	-	-	-	-	-	-	-	-	●	○ H01 ○ G10

## Recommended cutting condition

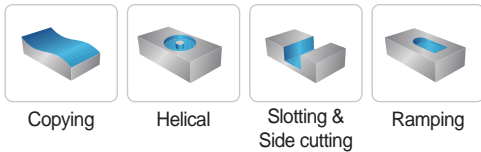
ISO	Cutting Speed vc (m/min)							
	CVD Coated		PVD Coated				Carbide	
	NCM325	NCM335	PC3700	PC6510	PC5300	PC9530	PC5400	H01
P	190-310	180-290	160-270	-	150-240	-	130-210	-
M	110-180	100-160	-	-	90-150	90-150	70-120	-
K	-	-	-	140-230	120-200	-	100-160	-
N	-	-	-	-	-	-	-	260-440

## Future Mill (FMR)

### Features

- Wide coverage for medium to roughing, general steel to high hardness mold materials
- 2 step shape of insert provides strong clamping and can minimize components to replace the shim
- 4-8 cutting-edge available per insert (Inscribed circle 05, 06, 07, 08, 10, 12, 16, 20)
- Uneven flute spacing prevents vibration on high speed applications and provides more stable machining
- Precise design of the insert seat prevents insert from chattering
- Special design of the insert bottom prevents movement and chatter of insert
- Easy to change cutting-edge due to the rotation prevention design of the insert

### Uses



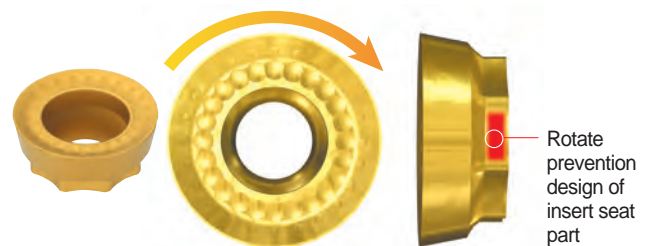
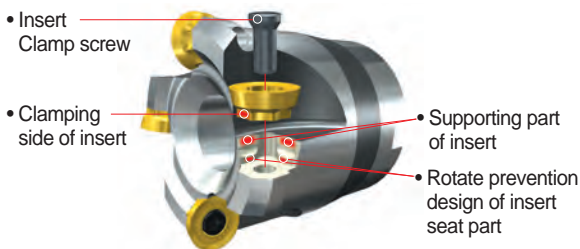
### FMR Insert cutting-edge shape

Designation	RDHW□□□□M0F	RDHW□□□□M0E	RDHW□□□□M0S
Cutting edge shape (G class)			

### Features of chip breaker

Insert	Cutting-edge	Uses	Features
MF		Light cutting	Low cutting resistance chip breaker design guarantees long tool life good performance at finishing and difficult-to-cut material machining
MM		General	Suitable for general milling at wide application range
MA		Aluminum	Sharp cutting-edge and buffed top face for aluminum machining prevent welding and control chip flow

### Clamping system

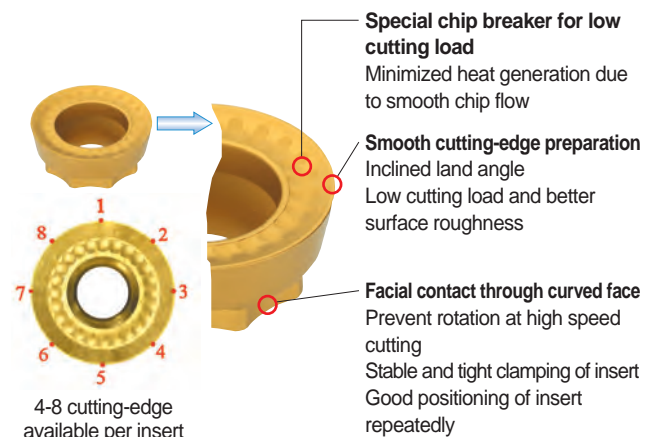
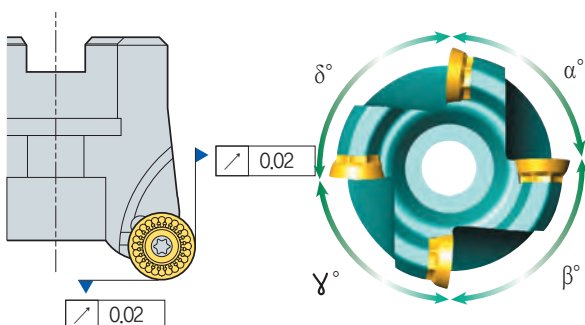


FMR□3000 type  
FMR□4000 type

FMR□5000 type  
FMR□6000 type

RDKT10T3M0-□□  
RDKT1204M0-□□

RDKT1605M0-MM  
RDKT2006M0-MM



Good surface finish due to the precise design of insert seat part of cutter

Uneven flute spacing prevents vibration at high speed application and provides stable machining

4-8 cutting-edge available per insert

**Special chip breaker for low cutting load**  
Minimized heat generation due to smooth chip flow

**Smooth cutting-edge preparation**  
Inclined land angle  
Low cutting load and better surface roughness

**Facial contact through curved face**  
Prevent rotation at high speed cutting  
Stable and tight clamping of insert  
Good positioning of insert repeatedly



## Future Mill (FMR)

### Chip removal rate (cm<sup>3</sup>/min)

Workpiece	Grades	Ø8	Ø10	Ø12	Ø15	Ø16	Ø20	Ø21	Ø25	Ø26	Ø32	Ø33	Ø40	Ø50	Ø63	Ø80	Ø100	Ø125	Ø160	
<b>P</b> General structure steel (under 200HB) General carbon steel (under 30 HRC) High carbon steel, Alloy steel (30-40 HRC) High carbon steel, Alloy steel (40-50 HRC) Alloy steel (over 50 HRC)	PC3700 PC5300	4.97	9.94	9.94	14.92	31.83	31.83	47.74	47.74	47.74	71.61	38.19	95.49	119.36	143.23	167.11	190.98	133.69	509.29	
		vc = 250, fz = 0.25, ap = 0.5, ae = 0.5D		vc = 300, fz = 0.4, ap = 1.0, ae = 0.5D		vc = 250, fz = 0.4, ap = 1.5, ae = 0.5D														vc = 200, fz = 0.5, ap = 4.0, ae = 0.5D
		3.97	7.95	7.95	11.93	25.46	25.46	38.19	38.19	38.19	57.29	38.19	76.39	95.49	114.59	133.69	152.78	133.69	458.36	
		vc = 200, fz = 0.25, ap = 0.5, ae = 0.5D		vc = 250, fz = 0.4, ap = 1.0, ae = 0.5D		vc = 200, fz = 0.4, ap = 1.5, ae = 0.5D														vc = 180, fz = 0.5, ap = 4.0, ae = 0.5D
		2.86	5.72	5.72	8.59	22.91	22.91	34.37	34.37	34.37	51.56	34.37	68.75	85.94	103.13	120.32	137.5	120.32	407.43	
		vc = 180, fz = 0.20, ap = 0.5, ae = 0.5D		vc = 200, fz = 0.4, ap = 1.0, ae = 0.5D		vc = 180, fz = 0.4, ap = 1.5, ae = 0.5D														vc = 160, fz = 0.5, ap = 4.0, ae = 0.5D
<b>M</b> Stainless steel	PC5300	1.24	2.48	2.48	3.72	11.45	11.45	14.32	17.18	14.32	21.48	14.32	28.64	35.8	42.97	50.13	57.29	50.13	249.55	
		vc = 130, fz = 0.15, ap = 0.4, ae = 0.5D		vc = 170, fz = 0.3, ap = 0.9, ae = 0.5D		vc = 150, fz = 0.3, ap = 1.0, ae = 0.5D														vc = 140, fz = 0.4, ap = 3.5, ae = 0.5D
		0.95	1.9	1.9	2.86	7.63	7.63	9.54	11.45	9.54	14.32	9.54	19.09	23.87	28.64	33.42	38.19	33.42	152.78	
<b>K</b> Cast iron	PC5300	vc = 100, fz = 0.15, ap = 0.4, ae = 0.5D		vc = 130, fz = 0.3, ap = 0.9, ae = 0.5D		vc = 100, fz = 0.3, ap = 1.0, ae = 0.5D														vc = 100, fz = 0.4, ap = 3.0, ae = 0.5D
		2.06	4.13	4.13	6.2	16.55	16.55	12.41	24.82	12.41	18.62	12.41	24.82	31.03	37.24	43.44	49.65	43.44	331.04	
<b>K</b> Cast iron	PC5300	vc = 130, fz = 0.20, ap = 0.5, ae = 0.5D		vc = 200, fz = 0.2, ap = 1.0, ae = 0.5D		vc = 100, fz = 0.3, ap = 1.0, ae = 0.5D														vc = 130, fz = 0.5, ap = 4.0, ae = 0.5D
		2.86	5.72	5.72	8.59	14.32	14.32	21.48	21.48	21.48	32.22	21.48	42.97	53.71	64.45	75.2	85.94	75.2	366.69	
<b>K</b> Cast iron	PC5300	vc = 180, fz = 0.20, ap = 0.5, ae = 0.5D		vc = 180, fz = 0.2, ap = 1.0, ae = 0.5D		vc = 180, fz = 0.2, ap = 1.5, ae = 0.5D														vc = 180, fz = 0.4, ap = 4.0, ae = 0.5D

### Required machine power (P<sub>KW</sub> = 0.75 x P<sub>HP</sub>)

• RDKT10

Workpiece	Grades	Ø21	Ø25	Ø26	Ø32	Ø40	Ø50	Ø63	Ø80	Ø100	Cutting condition			
											vc	fz	ap	ae
<b>P</b> General structure steel (under 200HB) General carbon steel (under 30 HRC) High carbon steel, Alloy steel (30-40 HRC) High carbon steel, Alloy steel (40-50 HRC) Alloy steel (over 50 HRC)	PC3700 PC5300	2.2	2.2	2.2	3.3	4.4	5.5	6.6	7.7	8.8	250	0.4	1.5	0.5D
		2.1	2.1	2.1	3.1	4.1	5.2	6.2	7.3	8.3	200	0.4	1.5	0.5D
		2.2	2.2	2.2	3.3	4.5	5.6	6.7	7.9	9	180	0.4	1.5	0.5D
		1.1	1.1	1.1	1.6	2.1	2.6	3.2	3.7	4.2	150	0.3	1.0	0.5D
		0.7	0.7	0.7	1.1	1.4	1.7	2.1	2.4	2.8	100	0.3	1.0	0.5D
<b>M</b> Stainless steel	PC5300	0.6	0.6	0.6	0.8	1.2	1.5	1.7	2	2.3	130	0.2	1.5	0.5D
<b>K</b> Cast iron	PC5300	0.6	0.6	0.6	0.9	1.2	1.5	1.8	2.1	2.4	180	0.2	1.5	0.5D

• The figures in the above chart means P<sub>HP</sub> value.

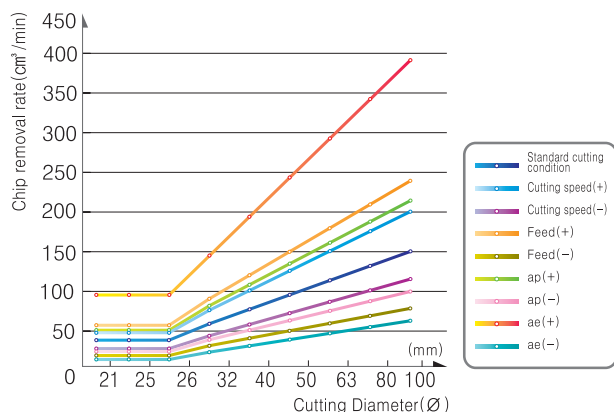
• RDKT12

Workpiece	Grades	Ø32	Ø33	Ø40	Ø50	Ø63	Ø80	Ø100	Ø125	Cutting condition			
										vc	fz	ap	ae
<b>P</b> General structure steel (under 200HB) General carbon steel (under 30 HRC) High carbon steel, Alloy steel (30-40 HRC) High carbon steel, Alloy steel (40-50 HRC) Alloy steel (over 50 HRC)	PC3700 PC5300	1.7	1.7	2.6	3.5	3.5	4.4	5.3	6.1	200	0.4	1.5	0.5D
		2	2	3.1	4.1	2.6	5.2	6.2	7.2	180	0.4	1.5	0.5D
		2.2	2.2	3.3	4.4	2.8	5.6	6.7	7.8	160	0.4	1.5	0.5D
		1	1	1.5	1.6	2.1	2.6	3.1	3.6	140	0.3	1.0	0.5D
		0.7	0.7	1	1.4	0.8	1.7	2.1	2.4	100	0.3	1.0	0.5D
<b>M</b> Stainless steel	PC5300	0.5	0.5	0.8	1.1	0.7	1.4	1.7	2	130	0.2	1.5	0.5D
<b>K</b> Cast iron	PC5300	0.6	0.6	0.9	1.2	0.7	1.5	1.8	2.1	180	0.2	1.5	0.5D

• The figures in the above chart means P<sub>HP</sub> value.

### Chip removal rate by cutting condition

• Used insert: RDKT10



### Variation of cutting condition

Standard	ISO			
	vc = 200	fz = 0.4	ap = 1.5	ae = 0.5D
Speed (+)	250			
Speed (-)	150			
Feed (+)	0.6			
Feed (-)	0.2			
ap (+)	2			
ap (-)	1			
ae (+)	D			
ae (-)	0.2D			

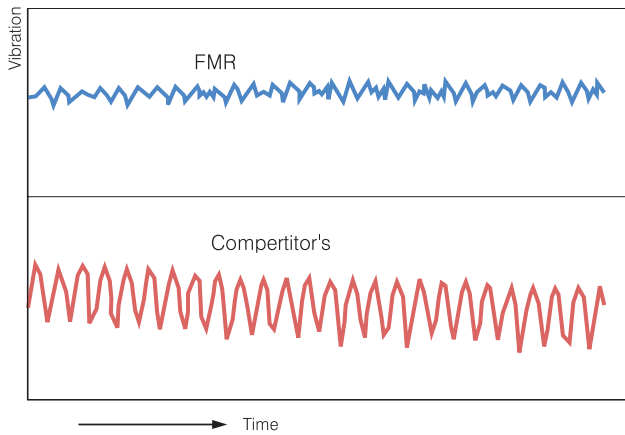




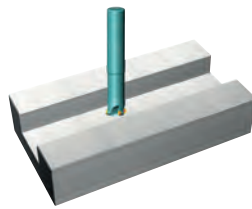


# Future Mill (FMR)

## FMR Vibration test



## Machining example



- **Workpiece** STD11
- **Cutting condition**
  - vc (m/min) = 200
  - fz (mm/t) = 0.40
  - ap (mm) = 2.0
  - ae (mm) = 4.0
- **Tools**
  - Insert** RDKT10T3M0-MM (PC3500)
  - Holder** FMRS3032RD-S

## Cutting condition formulas for milling

Cutting speed	RPM
---------------	-----

$$vc = \frac{\pi \times D \times n}{1000} \text{ (m/min)}$$

$$n = \frac{vc \times 1000}{\pi \times D} \text{ (min}^{-1}\text{)}$$

Feed (per tooth)	Feed (per minute)
------------------	-------------------

$$fz = \frac{vf}{Z \times n} \text{ (mm/t)}$$

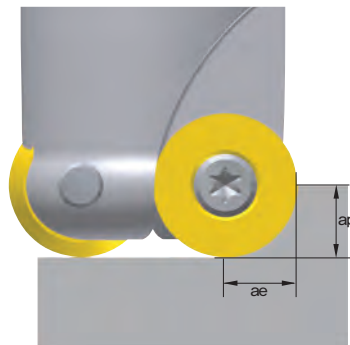
$$vf = fz \times n \times z \text{ (mm/min)}$$

Chip removal rate	Required machine power
-------------------	------------------------

$$Q = \frac{ap \times ae \times vf}{1000} \text{ (cm}^3\text{/min)}$$

$$P_{kw} = \frac{Q \times kc}{60 \times 102 \times \eta} \text{ (kW)}$$

$$P_{hp} = \frac{P_c}{0.75} \text{ (hp)}$$



vc = Cutting speed (m/min)	Pkw = Required machine power (kW)
n = Revolution per a minute (min <sup>-1</sup> )	Php = Horsepower requirement (hp)
D = Cutting diameter (mm)	Q = Chip removal amount (cm <sup>3</sup> /min)
De = Efficient cutting diameter (mm)	ap = Depth of cut (mm)
vf = Feed per a minute (mm/min)	ae = Width of cut (mm)
fz = Feed per tooth (mm/t)	kc = Specific cutting resistance (MPa)
z = Number of tooth	η = Mechanical efficiency (%)
Pc = Power requirement (kW)	

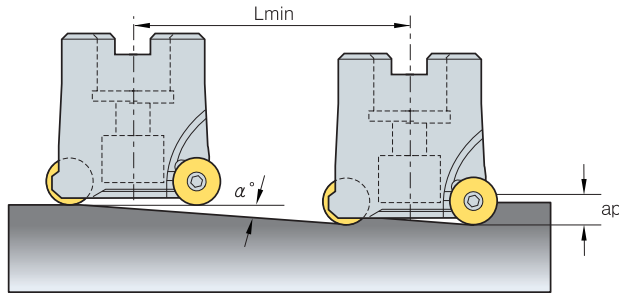
## Feed as per cutting depth

Designation	Chip breaker	Depth of cut (mm)									
		0.2~0.5	0.5~1.0	2.0	3.0	4.0	5.0	6.0	7.0	8.0	
RDHW0501M0	-	0.25	0.15	-	-	-	-	-	-	-	-
RDHW06T1M0	-	0.30	0.20	0.10	-	-	-	-	-	-	-
RDHW0702M0	-	0.35	0.25	0.10	0.07	-	-	-	-	-	-
RDHW0803M0	-	0.40	0.30	0.15	0.01	-	-	-	-	-	-
RDKT10T3M0 -	MF/MM	-	0.40	0.35	0.30	0.20	-	-	-	-	-
RDKT1204M0 -	MF/MM	-	0.50	0.45	0.30	0.25	0.22	-	-	-	-
RDHW1605M0	-	-	0.60	0.50	0.45	0.35	0.30	0.20	0.10	-	-
RDHW2006M0	-	-	-	0.60	0.50	0.40	0.30	0.25	0.15	0.10	-
RDKT1605M0 -	MM	-	0.60	0.50	0.45	0.35	0.30	0.20	0.10	-	-
RDKT2006M0 -	MM	-	-	0.60	0.50	0.40	0.30	0.25	0.15	0.10	-



## Future Mill (FMR)

### Ramping technical data



$$L_{min} = \frac{ap}{\tan \alpha^\circ} \text{ (mm)}$$

※ Lmin: Min. inclination cutting length  
 $\alpha^\circ$ : Max. ramping angle  
 ap: Depth of cut

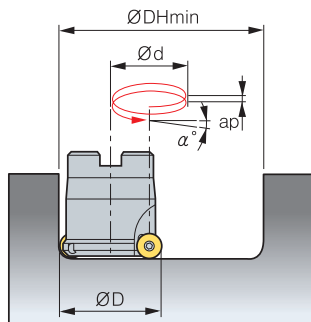
(mm)

Section	Tool dia.	Ramping angle $\alpha^\circ$ (Max)	Cutting length L (mm) by ramping angle									
			ap = 1	ap = 2	ap = 2.5	ap = 3	ap = 3.5	ap = 4	ap = 5	ap = 6	ap = 8	ap = 10
FMR1000	08	18.14	3	6	8	-	-	-	-	-	-	-
	10	11.7	5	10	12	-	-	-	-	-	-	-
	12	8.43	7	13	17	-	-	-	-	-	-	-
	15	5.93	10	19	24	-	-	-	-	-	-	-
FMR1500	10	20.67	21	5	7	8	-	-	-	-	-	-
	12	10.05	10	11	14	17	-	-	-	-	-	-
	16	6.12	6	19	23	28	-	-	-	-	-	-
	20	4.36	4	26	33	39	-	-	-	-	-	-
FMR2000	15	9.42	6	12	15	18	21	-	-	-	-	-
	20	5.85	10	20	24	29	34	-	-	-	-	-
FMR2500	16	13.7	4	8	10	12	14	16	-	-	-	-
	20	9.29	6	12	15	18	21	24	-	-	-	-
	25	6.56	9	17	22	26	30	35	-	-	-	-
FMR3000	25	21.8	3	5	6	8	9	10	13	-	-	-
	32	13.24	4	9	11	13	15	17	21	-	-	-
	40	9.09	6	13	16	19	22	25	31	-	-	-
	50	6.52	9	17	22	26	31	35	44	-	-	-
	63	4.76	12	24	30	36	42	48	60	-	-	-
	80	3.52	16	33	41	49	57	65	81	-	-	-
FMR4000	100	2.69	21	43	53	64	74	85	106	-	-	-
	32	15.95	3	7	9	10	12	14	17	21	-	-
	40	10.3	6	11	14	17	19	22	28	33	-	-
	50	7.13	8	16	20	24	28	32	40	48	-	-
	63	5.08	11	22	28	34	39	45	56	67	-	-
	80	3.69	16	31	39	47	54	62	78	93	-	-
	100	2.79	21	41	51	62	72	82	103	123	-	-
FMR5000	125	2.14	27	54	67	80	94	107	134	161	-	-
	40	7.4	8	15	19	23	27	31	38	46	62	-
	50	5.22	11	22	27	33	38	44	55	66	88	-
	63	3.79	15	30	38	45	53	60	75	91	121	-
	80	2.97	19	39	48	58	67	77	96	116	154	-
	100	2.09	27	55	69	82	96	110	137	164	219	-
FMR6000	125	1.63	35	70	88	105	123	141	176	211	281	-
	40	7.44	8	15	19	23	27	31	38	46	61	77
	50	4.97	11	23	29	34	40	46	57	69	92	46
	63	3.69	16	31	39	47	54	62	78	93	124	62
	80	2.72	21	42	53	63	74	84	105	126	168	84
	100	2.12	27	54	68	81	95	108	135	162	216	108
	125	1.57	36	73	91	109	128	146	182	219	292	146



# Future Mill (FMR)

## Helical cutting technical data - ØDHmin



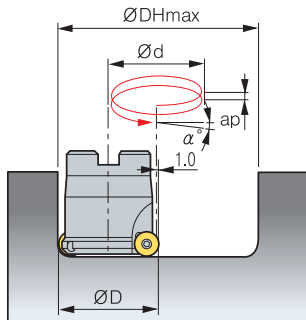
- ØD = Tool dia. (mm), ØDHmin, Max = Min, Max diameter (mm)
- Ød = Tool path (mm)
- ØDHmin (Min diameter) = ØD × 2 - Insert size, ØDHmax (Max diameter) = ØD × 2 - 2
- Ød (Tool path) = ØDHmin, Max - ØD

(mm)

Section	Insert	Tool dia.	ØDHmin	Ød	Ramping angle (α°)									
					ap = 1	ap = 2	ap = 2.5	ap = 3	ap = 3.5	ap = 4	ap = 5	ap = 6	ap = 8	ap = 10
FMR1000	5	08	11	3	6.11	12.35	15.57	-	-	-	-	-	-	-
	5	10	15	5	3.65	7.34	7.34	-	-	-	-	-	-	-
	5	12	19	7	2.61	5.23	5.23	-	-	-	-	-	-	-
	5	15	25	10	1.83	3.65	3.65	-	-	-	-	-	-	-
FMR1500	6	10	14	4	4.57	9.20	9.20	13.95	-	-	-	-	-	-
	6	12	18	6	3.04	6.11	6.11	9.20	-	-	-	-	-	-
	6	16	26	10	1.83	3.65	3.65	5.49	-	-	-	-	-	-
	6	20	34	14	1.30	2.61	2.61	3.92	-	-	-	-	-	-
FMR2000	7	15	23	8	2.28	4.57	4.57	6.88	8.04	-	-	-	-	-
	7	20	33	13	1.40	2.81	2.81	4.22	4.92	-	-	-	-	-
FMR2500	8	16	24	8	2.28	4.57	4.57	6.88	8.04	9.20	-	-	-	-
	8	20	32	12	1.52	3.04	3.04	4.57	5.34	6.11	-	-	-	-
	8	25	42	17	1.07	2.15	2.15	3.22	3.76	4.30	-	-	-	-
FMR3000	10	25	40	15	1.22	2.43	2.43	3.65	4.27	4.88	6.11	-	-	-
	10	32	54	22	0.83	1.66	1.66	2.49	2.91	3.32	4.15	-	-	-
	10	40	70	30	0.61	1.22	1.22	1.83	2.13	2.43	3.04	-	-	-
	10	50	90	40	0.46	0.91	0.91	1.37	1.60	1.83	2.28	-	-	-
	10	63	116	53	0.34	0.69	0.69	1.03	1.21	1.38	1.72	-	-	-
	10	80	150	70	0.26	0.52	0.52	0.78	0.91	1.04	1.30	-	-	-
FMR4000	12	32	52	20	0.91	1.83	1.83	2.74	3.20	3.65	4.57	5.49	-	-
	12	40	68	28	0.65	1.30	1.30	1.96	2.28	2.61	3.26	3.92	-	-
	12	50	88	38	0.48	0.96	0.96	1.44	1.68	1.92	2.40	2.88	-	-
	12	63	114	51	0.36	0.72	0.72	1.07	1.25	1.43	1.79	2.15	-	-
	12	80	148	68	0.27	0.54	0.54	0.81	0.94	1.07	1.34	1.61	-	-
	12	100	188	88	0.21	0.41	0.41	0.62	0.73	0.83	1.04	1.24	-	-
	12	125	238	113	0.16	0.32	0.32	0.48	0.57	0.65	0.81	0.97	-	-
FMR5000	16	40	64	24	0.76	1.52	1.52	2.28	2.66	3.04	3.81	4.57	6.11	-
	16	50	84	34	0.54	1.07	1.07	1.61	1.88	2.15	2.69	3.22	4.30	-
	16	63	110	47	0.39	0.78	0.78	1.16	1.36	1.55	1.94	2.33	3.11	-
	16	80	144	64	0.29	0.57	0.57	0.86	1.00	1.14	1.43	1.71	2.28	-
	16	100	184	84	0.22	0.43	0.43	0.65	0.76	0.87	1.09	1.30	1.74	-
	16	125	234	109	0.17	0.33	0.33	0.50	0.59	0.67	0.84	1.00	1.34	-
FMR6000	20	50	80	30	0.61	1.22	1.22	1.83	2.13	2.43	3.04	3.65	4.88	6.11
	20	63	106	43	0.42	0.85	0.85	1.27	1.49	1.70	2.12	2.55	3.40	4.25
	20	80	140	60	0.30	0.61	0.61	0.91	1.06	1.22	1.52	1.83	2.43	3.04
	20	100	180	80	0.23	0.46	0.46	0.68	0.80	0.91	1.14	1.37	1.83	2.28
	20	125	230	105	0.17	0.35	0.35	0.52	0.61	0.70	0.87	1.04	1.39	1.74
	20	160	300	140	0.13	0.26	0.26	0.39	0.46	0.52	0.65	0.78	1.04	1.30

## Future Mill (FMR)

### Helical cutting technical data - ØDHmax



- ØD = Tool dia. (mm), ØDHmin, Max = Min, Max diameter (mm)
- Ød = Tool path (mm)
- ØDHmin (Min diameter) = ØD × 2 - Insert size, ØDHmax (Max diameter) = ØD × 2 - 2
- Ød (Tool path) = ØDHmin, Max - ØD

(mm)

Section	Insert	Tool dia.	ØDHmax	Ød	Ramping angle (α°)									
					ap = 1	ap = 2	ap = 2.5	ap = 3	ap = 3.5	ap = 4	ap = 5	ap = 6	ap = 8	ap = 10
FMR1000	5	08	14	6	3.04	6.11	7.65	-	-	-	-	-	-	-
	5	10	18	8	2.28	4.57	5.72	-	-	-	-	-	-	-
	5	12	22	10	1.83	3.65	4.57	-	-	-	-	-	-	-
	5	15	28	13	1.40	2.81	3.51	-	-	-	-	-	-	-
FMR1500	6	10	18	8	2.28	4.57	5.72	6.88	-	-	-	-	-	-
	6	12	22	10	1.83	3.65	4.57	5.49	-	-	-	-	-	-
	6	16	30	14	1.30	2.61	3.26	3.92	-	-	-	-	-	-
	6	20	38	18	1.01	2.03	2.54	3.04	-	-	-	-	-	-
FMR2000	7	15	28	13	1.40	2.81	3.51	4.22	4.92	-	-	-	-	-
	7	20	38	18	1.01	2.03	2.54	3.04	3.55	-	-	-	-	-
FMR2500	8	16	30	14	1.30	2.61	3.26	3.92	4.57	5.23	-	-	-	-
	8	20	38	18	1.01	2.03	2.54	3.04	3.55	4.06	-	-	-	-
	8	25	48	23	0.79	1.59	1.98	2.38	2.78	3.18	-	-	-	-
FMR3000	10	25	48	23	0.79	1.59	1.98	2.38	2.78	3.18	3.97	-	-	-
	10	32	62	30	0.61	1.22	1.52	1.83	2.13	2.43	3.04	-	-	-
	10	40	78	38	0.48	0.96	1.20	1.44	1.68	1.92	2.40	-	-	-
	10	50	98	48	0.38	0.76	0.95	1.14	1.33	1.52	1.90	-	-	-
	10	63	124	61	0.30	0.60	0.75	0.90	1.05	1.20	1.50	-	-	-
	10	80	158	78	0.23	0.47	0.58	0.70	0.82	0.94	1.17	-	-	-
FMR4000	12	32	62	30	0.61	1.22	1.52	1.83	2.13	2.43	3.04	3.65	-	-
	12	40	78	38	0.48	0.96	1.20	1.44	1.68	1.92	2.40	2.88	-	-
	12	50	98	48	0.38	0.76	0.95	1.14	1.33	1.52	1.90	2.28	-	-
	12	63	124	61	0.30	0.60	0.75	0.90	1.05	1.20	1.50	1.80	-	-
	12	80	158	78	0.23	0.47	0.58	0.70	0.82	0.94	1.17	1.40	-	-
	12	100	198	98	0.19	0.37	0.47	0.56	0.65	0.74	0.93	1.12	-	-
	12	125	248	123	0.15	0.30	0.37	0.45	0.52	0.59	0.74	0.89	-	-
FMR5000	16	40	78	38	0.48	0.96	1.20	1.44	1.68	1.92	2.40	2.88	3.85	-
	16	50	98	48	0.38	0.76	0.95	1.14	1.33	1.52	1.90	2.28	3.04	-
	16	63	124	61	0.30	0.60	0.75	0.90	1.05	1.20	1.50	1.80	2.39	-
	16	80	158	78	0.23	0.47	0.58	0.70	0.82	0.94	1.17	1.40	1.87	-
	16	100	198	98	0.19	0.37	0.47	0.56	0.65	0.74	0.93	1.12	1.49	-
	16	125	248	123	0.15	0.30	0.37	0.45	0.52	0.59	0.74	0.89	1.19	-
FMR6000	20	50	98	48	0.38	0.76	0.95	1.14	1.33	1.52	1.90	2.28	3.04	3.81
	20	63	124	61	0.30	0.60	0.75	0.90	1.05	1.20	1.50	1.80	2.39	2.99
	20	80	158	78	0.23	0.47	0.58	0.70	0.82	0.94	1.17	1.40	1.87	2.34
	20	100	198	98	0.19	0.37	0.47	0.56	0.65	0.74	0.93	1.12	1.49	1.86
	20	125	248	123	0.15	0.30	0.37	0.45	0.52	0.59	0.74	0.89	1.19	1.48
	20	160	318	158	0.12	0.23	0.29	0.35	0.40	0.46	0.58	0.69	0.92	1.16



Future Mill series for mold making






# FMR P-positive

- Stable clamping system enables stable machining and productivity
- Varied product line-up ensures wide application range
- Optimal shape and grade with high hardness for hard-to-cut material machining

## Features

- P-positive relief angle (11°) ensures high rigidity and high machinability in die steel and high-resistant alloy machining
- Flat clearance face of insert prevents interference and revolution while machining
- Optimal grades and chip breakers for various workpieces
- Chip breaker
  - Concave shape ensures wide chip pocket and lowers cutting temperature
  - Clearance face for preventing rotation
    - Prevents rotation in machining
    - Divides corners
    - Prevents interference in high-feed machining
    - Ensures stable clamping
  - Through-coolant system
    - Superb chip evacuation
    - Low cutting heat ensures long tool life

## Features of chip breaker

Insert	Cutting-edge	Uses	Features
MA		Aluminum machining	Optimal cutting-edge for aluminum machining and buffed surface ensure high machinability
ML		Titanium & Inconel machining	Excellent results in titanium machining thanks to a high hardness cutting-edge and the chip breaker reducing the cutting load
MF		Light machining	Chip breaker for low cutting resistance enables fine finishing.
MM		General machining	Optimal for general machining
None C/B		Super hard material machining	Optimal for high hardness die steel and heat resistant alloy

## Recommended cutting condition

\* Recommended chip breaker: ● First ○ Second

Workpiece	Hardness	Grades	Cutting conditions				Chip breaker						
			vc (m/min)	fz (mm/t)	ap (mm)	ae (mm)	MA	ML	MF	MM	None C/B 1 2		
P	Low carbon steel	HB80~180	PC5400	100~250	0.12~0.70	0.3~6.0	0.7D~0.1D	-	-	●	○	-	-
	High carbon steel	HB180~280	PC5400	100~220	0.12~0.70	0.3~6.0	0.7D~0.1D	-	-	●	○	-	-
	Low alloy steel	Under Hrc27	PC3700	180~290	0.20~0.60	0.3~6.0	0.7D~0.1D	-	-	-	●	○	-
			PC5400/PC5300	100~200	0.20~0.60	0.3~6.0	0.7D~0.1D	-	-	-	●	○	-
	Low pre-hardened steel	Hrc20~50	PC3700	130~250	0.30~0.50	~ 0.5	0.7D~0.1D	-	-	-	-	●	○
			PC2510/PC5300	50~150	0.30~0.50	~ 0.5	0.7D~0.1D	-	-	-	-	●	○
	High alloy steel	Under Hrc27	PC3700	130~250	0.30~0.50	~ 0.5	0.7D~0.1D	-	-	-	●	○	-
PC5300			100~220	0.30~0.50	~ 0.5	0.7D~0.1D	-	-	-	●	○	-	
High pre-hardened steel	Hrc20~48	PC2510/PC5300	50~150	0.30~0.50	~ 0.5	0.7D~0.1D	-	-	-	-	●	○	
M	Stainless steel	Under HB270	PC5300/PC5400	100~150	0.20~0.60	0.3~6.0	0.7D~0.1D	-	-	○	●	-	-
K	Gray cast iron, Ductile cast iron	Under 350MPa	PC5300	120~210	0.20~0.60	0.3~6.0	0.7D~0.1D	-	-	○	●	-	-
N	Aluminum	-	H01	300~800	0.30~0.60	0.3~6.0	0.7D~0.1D	●	-	-	-	-	-
S	Heat resistant alloy	Fe	Hrc20~30	PC5300/PC5400	35~60	0.30~0.50	~ 0.5	0.7D~0.1D	-	●	○	-	-
		Ni or Co	Hrc40~45	PC5300/PC5400	30~50	0.30~0.50	~ 0.5	0.7D~0.1D	-	●	○	-	-
	Titanium	Hrc35~45	PC5300/PC5400	40~70	0.30~0.50	~ 1.5	0.7D~0.1D	-	●	○	-	-	
H	High hardened materials	Over Hrc50	PC2505/PC2510	30~50	0.30~0.50	~ 0.5	0.7D~0.1D	-	-	-	-	●	○

# E Technical Information for FMR P-positive

## ➤ Feed per tooth according to ap (fz, mm/t)

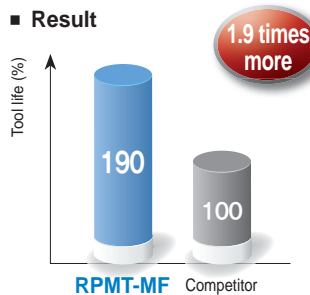
(mm)

Insert	Insert size (d)	Feed per tooth according to ap							
		ap = 1	ap = 2	ap = 3	ap = 4	ap = 5	ap = 6	ap = 8	ap = 10
RPMT08	8	0.30	0.22	0.18	0.15	-	-	-	-
RPMT10	10	0.40	0.28	0.25	0.20	0.12	-	-	-
RPMT12	12	0.60	0.45	0.35	0.30	0.25	0.20	-	-
RPMT16	16	0.65	0.45	0.40	0.32	0.30	0.28	0.23	-
RPMT20	20	0.70	0.50	0.42	0.35	0.32	0.29	0.25	0.22

## ➤ Performance evaluation

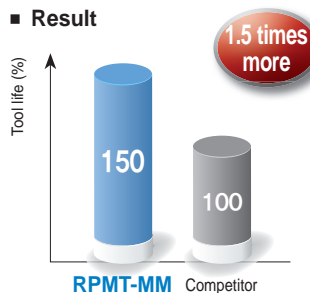
### Alloy steel (SM490A Heat treatment, HRC 38~40)

- Cutting conditions**
  - vc (m/min) = 250
  - fz (mm/tooth) = 0.6
  - ap (mm) = 1
  - wet
- Tools**
  - Insert: RPMT1204M0E-MF (PC5300)
  - Holder: FMRS4032HRP-3L25



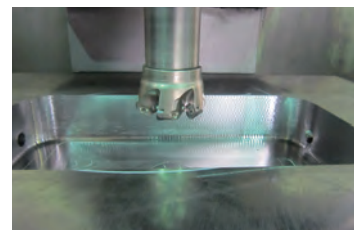
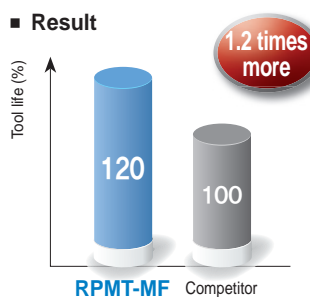
### Low pre-hardened steel (KP4M Heat treatment, HRC 30~45)

- Cutting conditions**
  - vc (m/min) = 178
  - fz (mm/tooth) = 0.72
  - ap (mm) = 1.5
  - dry
- Tools**
  - Insert: RPMT1606M0S-MM (PC5300)
  - Holder: FMRCM5063HRP-4



### Low pre-hardened steel (KP1, HRC 28~33)

- Cutting conditions**
  - vc (m/min) = 178
  - fz (mm/tooth) = 0.74
  - ap (mm) = 0.8
  - dry
- Tools**
  - Insert: RPMT1204M0E-MF (PC5300)
  - Holder: FMRCM4063HRP-6



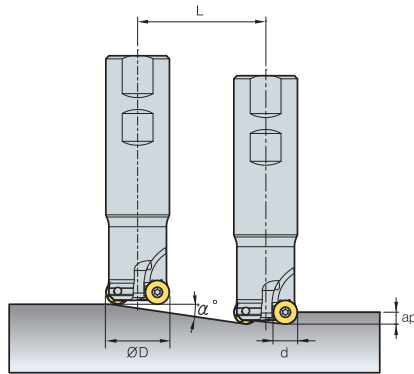
### High pre-hardened steel (STD61, HRC 50~52)

- Cutting conditions**
  - vc (m/min) = 50
  - fz (mm/tooth) = 0.15
  - ap (mm) = 4.0
  - dry
- Tools**
  - Insert: RPMW1204M0S1 (PC5300)
  - Holder: FMRS4032HRP-3L25



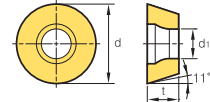
# FMR P-positive

## Maximum angle table for ramping machining



$$L_{min} = \frac{ap}{\tan \alpha^\circ} \text{ (mm)}$$

\* L (mm): Cutting length  
 α°: Max. ramping angle  
 ap: Depth of cut



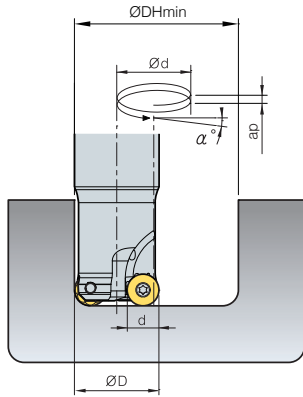
(mm)

Section	Insert size (d)	Tool dia. (ØD)	Ramping angle α° (max)	Cutting length L (mm) by ap									
				ap = 1	ap = 2	ap = 2.5	ap = 3	ap = 3.5	ap = 4	ap = 5	ap = 6	ap = 8	ap = 10
FMR2500	8	17	4.7	12	24	30	36	42	48	-	-	-	-
	8	18	4.1	14	28	34	41	48	55	-	-	-	-
	8	20	15.4	4	7	9	11	13	14	-	-	-	-
	8	21	13.9	4	8	10	12	14	16	-	-	-	-
	8	25	9.8	6	12	14	17	20	23	-	-	-	-
	8	26	9.2	6	12	16	19	22	25	-	-	-	-
FMR3000	10	25	13.8	4	8	10	12	14	16	20	-	-	-
	10	26	12.6	4	9	11	13	16	18	22	-	-	-
	10	32	8.4	7	14	17	20	24	27	34	-	-	-
	10	33	8.0	7	14	18	21	25	29	36	-	-	-
	10	40	5.8	10	20	25	30	34	39	49	-	-	-
	10	50	4.2	14	27	34	41	48	55	68	-	-	-
	10	63	3.1	19	37	47	56	65	75	93	-	-	-
FMR4000	12	25	4.5	13	25	32	38	44	51	63	76	-	-
	12	26	4.1	14	28	35	42	49	56	70	84	-	-
	12	32	14.7	4	8	10	11	13	15	19	23	-	-
	12	33	13.8	4	8	10	12	14	16	20	24	-	-
	12	40	9.6	6	12	15	18	21	24	30	36	-	-
	12	50	6.7	9	17	21	26	30	34	43	51	-	-
	12	63	4.8	12	24	30	36	42	48	60	72	-	-
	12	66	4.5	13	26	32	38	45	51	64	77	-	-
	12	80	3.5	17	33	41	50	58	66	83	99	-	-
FMR5000	16	40	17.8	3	6	8	9	11	12	16	19	25	-
	16	50	11.3	5	10	13	15	18	20	25	30	40	-
	16	63	7.6	7	15	19	22	26	30	37	45	60	-
	16	66	7.1	8	16	20	24	28	32	40	48	64	-
	16	80	5.3	11	21	27	32	37	43	53	64	85	-
	16	100	4.0	14	29	36	43	51	58	72	87	116	-
	16	125	3.0	19	38	48	58	67	77	96	115	154	-
	16	160	2.2	26	52	65	78	90	103	129	155	207	-
FMR6000	20	50	17.8	3	6	8	9	11	12	16	19	25	31
	20	63	11.1	5	10	13	15	18	20	25	30	41	51
	20	80	7.4	8	15	19	23	27	31	38	46	61	77
	20	100	5.3	11	21	27	32	37	43	53	64	85	107
	20	125	4.0	14	29	36	43	51	58	72	87	116	145
	20	160	2.9	20	40	49	59	69	79	99	119	158	198
	20	200	2.2	26	52	65	78	90	103	129	155	207	258
	20	250	1.7	33	67	84	100	117	134	167	200	267	334

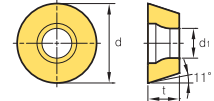
\* Insert size (d): Please refer page E16 applicable insert drawing.

## FMR P-positive

### Minimum hole diameter table for helical machining (ØDHmin)



- $\varnothing D$  = Tool dia. (mm)
- $\varnothing d$  (Tool path, mm) =  $\varnothing DH_{min}$ , Max -  $\varnothing D$
- $\varnothing DH_{min}$  (Minimum hole diameter) =  $\varnothing D \times 2$  - Insert size (d)
- $\varnothing DH_{max}$  (Maximum hole diameter) =  $\varnothing D \times 2$
- Ramping angle by ap ( $\alpha^\circ$ ) =  $\tan^{-1} \left( \frac{ap}{\pi \times \varnothing d} \right)$
- Helical angle adjusted by ap cannot exceed maximum angle
- ap = Depth of cut



(mm)

Section	Insert size (d)	Tool dia. (ØD)	Ramping angle $\alpha^\circ$ (max)	ØDHmin	Ød	Ramping angle ( $\alpha^\circ$ ) by ap										
						ap = 1	ap = 2	ap = 2.5	ap = 3	ap = 3.5	ap = 4	ap = 5	ap = 6	ap = 8	ap = 10	
FMR2500	8	17	4.7	26	9	2.03	4.06	-	-	-	-	-	-	-	-	-
	8	18	4.1	28	10	1.83	3.65	-	-	-	-	-	-	-	-	-
	8	20	15.4	32	12	1.52	3.04	3.81	4.57	5.34	6.11	-	-	-	-	-
	8	21	13.9	34	13	1.40	2.81	3.51	4.22	4.92	5.63	-	-	-	-	-
	8	25	9.8	42	17	1.07	2.15	2.69	3.22	3.76	4.30	-	-	-	-	-
	8	26	9.2	44	18	1.01	2.03	2.54	3.04	3.55	4.06	-	-	-	-	-
FMR3000	10	25	13.8	40	15	1.22	2.43	3.04	3.65	4.27	4.88	-	-	-	-	-
	10	26	12.6	42	16	1.14	2.28	2.85	3.43	4.00	4.57	-	-	-	-	-
	10	32	8.4	54	22	0.83	1.66	2.07	2.49	2.91	3.32	-	-	-	-	-
	10	33	8.0	56	23	0.79	1.59	1.98	2.38	2.78	3.18	-	-	-	-	-
	10	40	5.8	70	30	0.61	1.22	1.52	1.83	2.13	2.43	-	-	-	-	-
	10	50	4.2	90	40	0.46	0.91	1.14	1.37	1.60	1.83	-	-	-	-	-
	10	63	3.1	116	53	0.34	0.69	0.86	1.03	1.21	1.38	-	-	-	-	-
	10	66	2.9	122	56	0.33	0.65	0.81	0.98	1.14	1.30	-	-	-	-	-
FMR4000	12	25	4.5	38	13	1.40	2.81	3.51	-	-	-	-	-	-	-	-
	12	26	4.1	40	14	1.30	2.61	3.26	-	-	-	-	-	-	-	-
	12	32	14.7	52	20	0.91	1.83	2.28	2.74	3.20	3.65	4.57	5.49	-	-	-
	12	33	13.8	54	21	0.87	1.74	2.17	2.61	3.04	3.48	4.35	5.23	-	-	-
	12	40	9.6	68	28	0.65	1.30	1.63	1.96	2.28	2.61	3.26	3.92	-	-	-
	12	50	6.7	88	38	0.48	0.96	1.20	1.44	1.68	1.92	2.40	2.88	-	-	-
	12	63	4.8	114	51	0.36	0.72	0.89	1.07	1.25	1.43	1.79	2.15	-	-	-
	12	66	4.5	120	54	0.34	0.68	0.84	1.01	1.18	1.35	1.69	2.03	-	-	-
	12	80	3.5	148	68	0.27	0.54	0.67	0.81	0.94	1.07	1.34	1.61	-	-	-
	12	100	2.6	188	88	0.21	0.41	0.52	0.62	0.73	0.83	1.04	1.24	-	-	-
FMR5000	16	40	17.8	64	24	0.76	1.52	1.90	2.28	2.66	3.04	3.81	4.57	6.11	-	-
	16	50	11.3	84	34	0.54	1.07	1.34	1.61	1.88	2.15	2.69	3.22	4.30	-	-
	16	63	7.6	110	47	0.39	0.78	0.97	1.16	1.36	1.55	1.94	2.33	3.11	-	-
	16	66	7.1	116	50	0.36	0.73	0.91	1.09	1.28	1.46	1.83	2.19	2.92	-	-
	16	80	5.3	144	64	0.29	0.57	0.71	0.86	1.00	1.14	1.43	1.71	2.28	-	-
	16	100	4.0	184	84	0.22	0.43	0.54	0.65	0.76	0.87	1.09	1.30	1.74	-	-
	16	125	3.0	234	109	0.17	0.33	0.42	0.50	0.59	0.67	0.84	1.00	1.34	-	-
	16	160	2.2	304	144	0.13	0.25	0.32	0.38	0.44	0.51	0.63	0.76	1.01	-	-
FMR6000	20	50	17.8	80	30	0.61	1.22	1.52	1.83	2.13	2.43	3.04	3.65	4.88	6.11	-
	20	63	11.1	106	43	0.42	0.85	1.06	1.27	1.49	1.70	2.12	2.55	3.40	4.25	-
	20	80	7.4	140	60	0.30	0.61	0.76	0.91	1.06	1.22	1.52	1.83	2.43	3.04	-
	20	100	5.3	180	80	0.23	0.46	0.57	0.68	0.80	0.91	1.14	1.37	1.83	2.28	-
	20	125	4.0	230	105	0.17	0.35	0.43	0.52	0.61	0.70	0.87	1.04	1.39	1.74	-
	20	160	2.9	300	140	0.13	0.26	0.33	0.39	0.46	0.52	0.65	0.78	1.04	1.30	-
	20	200	2.2	380	180	0.10	0.20	0.25	0.30	0.35	0.41	0.51	0.61	0.81	1.01	-
	20	250	1.7	480	230	0.08	0.16	0.20	0.24	0.28	0.32	0.40	0.48	0.63	0.79	-

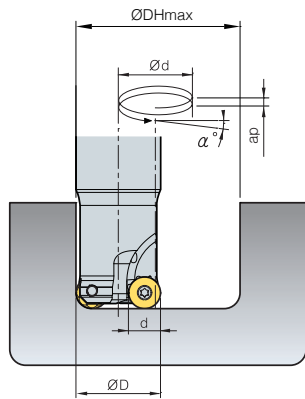
\* Insert size (d): Please refer page E16 applicable insert drawing.



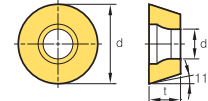


# FMR P-positive

## ➤ Maximum hole diameter table for helical machining (ØDHmax)



- $\varnothing D$  = Tool dia. (mm)
- $\varnothing d$  (Tool path, mm) =  $\varnothing DH_{min}$ , Max -  $\varnothing D$
- $\varnothing DH_{min}$  (Minimum hole diameter) =  $\varnothing D \times 2$  - Insert size ( $d$ )
- $\varnothing DH_{max}$  (Maximum hole diameter) =  $\varnothing D \times 2$
- Ramping angle by  $ap$  ( $\alpha^\circ$ ) =  $\tan^{-1} \left( \frac{ap}{\pi \times \varnothing d} \right)$
- Helical angle adjusted by  $ap$  cannot exceed maximum angle
- $ap$  = Depth of cut



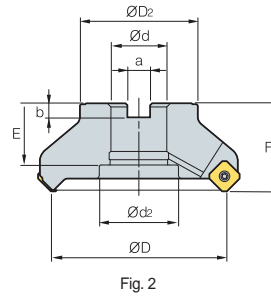
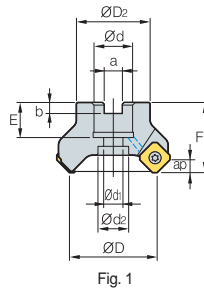
(mm)

Section	Insert size (d)	Tool dia. (ØD)	Ramping angle $\alpha^\circ$ (max)	ØDHmax	Ød	Ramping angle ( $\alpha^\circ$ ) by ap									
						ap = 1	ap = 2	ap = 2.5	ap = 3	ap = 3.5	ap = 4	ap = 5	ap = 6	ap = 8	ap = 10
FMR2500	8	17	4.7	32	15	1.22	2.43	3.04	3.65	-	-	-	-	-	-
	8	18	4.1	34	16	1.14	2.28	2.85	3.43	-	-	-	-	-	-
	8	20	15.4	38	18	1.01	2.03	2.54	3.04	3.55	4.06	-	-	-	-
	8	21	13.9	40	19	0.96	1.92	2.40	2.88	3.37	3.85	-	-	-	-
	8	25	9.8	48	23	0.79	1.59	1.98	2.38	2.78	3.18	-	-	-	-
	8	26	9.2	50	24	0.76	1.52	1.90	2.28	2.66	3.04	-	-	-	-
FMR3000	10	25	13.8	48	23	0.79	1.59	1.98	2.38	2.78	3.18	-	-	-	-
	10	26	12.6	50	24	0.76	1.52	1.90	2.28	2.66	3.04	-	-	-	-
	10	32	8.4	62	30	0.61	1.22	1.52	1.83	2.13	2.43	-	-	-	-
	10	33	8.0	64	31	0.59	1.18	1.47	1.77	2.06	2.36	-	-	-	-
	10	40	5.8	78	38	0.48	0.96	1.20	1.44	1.68	1.92	-	-	-	-
	10	50	4.2	98	48	0.38	0.76	0.95	1.14	1.33	1.52	-	-	-	-
	10	63	3.1	124	61	0.30	0.60	0.75	0.90	1.05	1.20	-	-	-	-
	10	66	2.9	130	64	0.29	0.57	0.71	0.86	1.00	1.14	-	-	-	-
FMR4000	12	25	4.5	48	23	0.79	1.59	1.98	2.38	2.78	3.18	-	-	-	-
	12	26	4.1	50	24	0.76	1.52	1.90	2.28	2.66	3.04	-	-	-	-
	12	32	14.7	62	30	0.61	1.22	1.52	1.83	2.13	2.43	3.04	3.65	-	-
	12	33	13.8	64	31	0.59	1.18	1.47	1.77	2.06	2.36	2.95	3.54	-	-
	12	40	9.6	78	38	0.48	0.96	1.20	1.44	1.68	1.92	2.40	2.88	-	-
	12	50	6.7	98	48	0.38	0.76	0.95	1.14	1.33	1.52	1.90	2.28	-	-
	12	63	4.8	124	61	0.30	0.60	0.75	0.90	1.05	1.20	1.50	1.80	-	-
	12	66	4.5	130	64	0.29	0.57	0.71	0.86	1.00	1.14	1.43	1.71	-	-
	12	80	3.5	158	78	0.23	0.47	0.58	0.70	0.82	0.94	1.17	1.40	-	-
	12	100	2.6	198	98	0.19	0.37	0.47	0.56	0.65	0.74	0.93	1.12	-	-
FMR5000	16	40	17.8	78	38	0.48	0.96	1.20	1.44	1.68	1.92	2.40	2.88	3.85	-
	16	50	11.3	98	48	0.38	0.76	0.95	1.14	1.33	1.52	1.90	2.28	3.04	-
	16	63	7.6	124	61	0.30	0.60	0.75	0.90	1.05	1.20	1.50	1.80	2.39	-
	16	66	7.1	130	64	0.29	0.57	0.71	0.86	1.00	1.14	1.43	1.71	2.28	-
	16	80	5.3	158	78	0.23	0.47	0.58	0.70	0.82	0.94	1.17	1.40	1.87	-
	16	100	4.0	198	98	0.19	0.37	0.47	0.56	0.65	0.74	0.93	1.12	1.49	-
	16	125	3.0	248	123	0.15	0.30	0.37	0.45	0.52	0.59	0.74	0.89	1.19	-
	16	160	2.2	318	158	0.12	0.23	0.29	0.35	0.40	0.46	0.58	0.69	0.92	-
FMR6000	20	50	17.8	98	48	0.38	0.76	0.95	1.14	1.33	1.52	1.90	2.28	3.04	3.81
	20	63	11.1	124	61	0.30	0.60	0.75	0.90	1.05	1.20	1.50	1.80	2.39	2.99
	20	80	7.4	158	78	0.23	0.47	0.58	0.70	0.82	0.94	1.17	1.40	1.87	2.34
	20	100	5.3	198	98	0.19	0.37	0.47	0.56	0.65	0.74	0.93	1.12	1.49	1.86
	20	125	4.0	248	123	0.15	0.30	0.37	0.45	0.52	0.59	0.74	0.89	1.19	1.48
	20	160	2.9	318	158	0.12	0.23	0.29	0.35	0.40	0.46	0.58	0.69	0.92	1.16
	20	200	2.2	398	198	0.09	0.18	0.23	0.28	0.32	0.37	0.46	0.55	0.74	0.92
	20	250	1.7	498	248	0.07	0.15	0.18	0.22	0.26	0.29	0.37	0.44	0.59	0.74

\* Insert size (d): Please refer page E16 applicable insert drawing.



# FMAC(M)3000



AA  
45°

• AR: 21°  
• RR: -17°~12°

(mm)

Designation		ØD	ØD <sub>2</sub>	Ød	a	b	E	F	Ød <sub>1</sub>	Ød <sub>2</sub>	ap		Fig.	
FMACM	3050HR	4	50	42	22	10.4	6.3	20	40	11	17.5	4.0	0.4	1
	3050HR-H	6	50	42	22	10.4	6.3	20	40	11	17.5	4.0	0.4	1
	3063HR	5	63	49	22	10.4	6.3	20	40	11	17.5	4.0	0.5	1
	3063HR-H	8	63	49	22	10.4	6.3	20	40	11	17.5	4.0	0.6	1
FMAC (FMACM)	3080HR	6	80	57	25.4 (27)	9.5 (12.4)	6 (7)	25 (23)	50	14	20	4.0	1.1	1
	3080HR-H	10	80	57	25.4 (27)	9.5 (12.4)	6 (7)	25 (23)	50	14	20	4.0	1.2	1
	3100HR	7	100	67	31.75 (32)	12.7 (14.4)	8 (8)	35 (25.5)	50	(18)	45 (26)	4.0	1.7	2 (1)
	3100HR-H	12	100	67	31.75 (32)	12.7 (14.4)	8 (8)	35 (25.5)	50	(18)	45 (26)	4.0	1.7	2 (1)
	3125HR	8	125	87	38.1 (40)	15.9 (16.4)	10 (9)	42 (29)	63	(22)	55 (32)	4.0	3.3 (3.5)	2 (1)
	3125HR-H	14	125	87	38.1 (40)	15.9 (16.4)	10 (9)	42 (29)	63	(22)	55 (32)	4.0	3.3 (3.5)	2 (1)

( )Metric size

## Available inserts

SEET-MF

SEET-MM

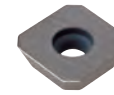
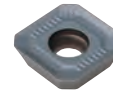
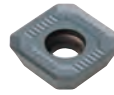
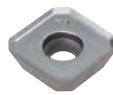
SEET-MA

SEXT-MF

SEXT-MM

SEXT-MR

SEEW



Designation	Cermet		Coated											Uncoated				page		
	CN2500	CN30	NC5330	NCM325	NCM335	NCM335	NCM545	PC2505	PC2010	PC3700	PC6510	PC9530	PC9540	PC5300	PC5400	ST30A	G10		H01	H05
SEET	0903AGFN-MA																			
	0903AGSN-MF										●	●		●	●			●	●	
	0903AGSN-MM				●						●	●		●	●					
SEXT	0903AGSN-MF										●	●		●	●					
	0903AGSN-MM									●	●			●	●					
	0903AGSN-MR																			
SEEW	0903AGTN																			

## Available arbors

Designation	Ød	NC arbors
FMACM	3050HR-□	BT□□-FMC22-□□
	3063HR-□	
FMAC (FMACM)	3080HR-□	BT□□-FMA25.4-□□
		BT□□-FMC27-□□
	3100HR-□	BT□□-FMA31.75-□□
		BT□□-FMC32-□□
	3125HR-□	BT□□-FMA38.1-□□
		BT□□-FMB/FMC40-□□

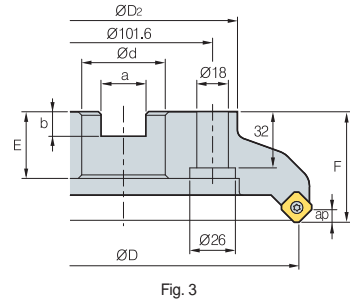
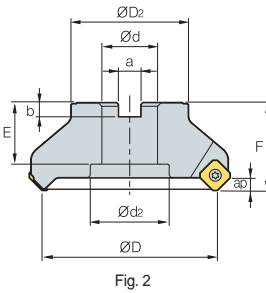
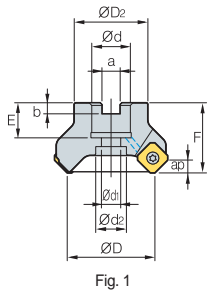
## Parts

Specification		
Ø50~Ø125	FTKA0307	TW09S

Available inserts E21, E22 Available arbors and bolt E426-E428



# FMAC(M)4000



AA  
45°

• AR: 21°  
• RR: -17°~12°

Designation	⊕	ØD	ØD <sub>2</sub>	Ød	a	b	E	F	Ød <sub>1</sub>	Ød <sub>2</sub>	ap	kg	Fig.	
FMACM	4050HR	3	50	42	22	10.4	6.3	20	40	11	18	6.5	0.4	1
	4063HR	4	63	49	22	10.4	6.3	20	40	11	18	6.5	0.6	1
	4063HR-M	5	63	49	22	10.4	6.3	20	40	11	18	6.5	0.6	1
	4063HR-H	6	63	49	22	10.4	6.3	20	40	11	18	6.5	0.6	1
FMAC (FMACM)	4080HR	5	80	57	25.4 (27)	9.5 (12.4)	6 (7)	25 (23)	50	14	20	6.5	1.1	1
	4080HR-M	6	80	57	25.4 (27)	9.5 (12.4)	6 (7)	25 (23)	50	14	20	6.5	1.1	1
	4080HR-H	8	80	57	25.4 (27)	9.5 (12.4)	6 (7)	25 (23)	50	14	20	6.5	1.1	1
	4100HR	5	100	67	31.75 (32)	12.7 (14.4)	8 (8)	33 (25)	63 (50)	18	26	6.5	2 (1.6)	1
	4100HR-M	7	100	67	31.75 (32)	12.7 (14.4)	8 (8)	33 (25)	63 (50)	18	26	6.5	2 (1.6)	1
	4100HR-H	10	100	67	31.75 (32)	12.7 (14.4)	8 (8)	33 (25)	63 (50)	18	26	6.5	2 (1.6)	1
	4125HR	6	125	87	38.1 (40)	15.9 (16.4)	10 (9)	35 (29)	63	22	32	6.5	3.1	1
	4125HR-M	8	125	87	38.1 (40)	15.9 (16.4)	10 (9)	35 (29)	63	22	32	6.5	3.1	1
	4125HR-H	12	125	87	38.1 (40)	15.9 (16.4)	10 (9)	35 (29)	63	22	32	6.5	3.1	1
	4160R	7	160	107	50.8 (40)	19.0 (16.4)	11 (9)	38 (35)	63	-	-	6.5	4.8	2
	4160R-M	10	160	107	50.8 (40)	19.0 (16.4)	11 (9)	38 (35)	63	-	-	6.5	4.8	2
	4160R-H	16	160	107	50.8 (40)	19.0 (16.4)	11 (9)	38 (35)	63	-	-	6.5	4.8	2
4200R	8	200	130	47.625 (60)	25.4 (25.7)	14	38 (32)	63	-	-	6.5	6.1	3	
4200R-M	12	200	130	47.625 (60)	25.4 (25.7)	14	38 (32)	63	-	-	6.5	6.1	3	
4200R-H	18	200	130	47.625 (60)	25.4 (25.7)	14	38 (32)	63	-	-	6.5	6.1	3	

## Available inserts

( ) Metric size

SEET-MF	SEET-MM	SEET-MA	SEXT-MF	SEXT-MM	SEXT-MR	SEEW	SEEW-W												
Designation	Cermet	Coated						Uncoated	page	Designation	Cermet	Coated						Uncoated	page
	CN2500 CN30	NC5330 NCM325	NCM335 NCM535	NCM545 PC3700	PC6510 PC9540	PC5300 PC5400	PD2000 PD1010	H01 H05			CN2500 CN30	NC5330 NCM325	NCM335 NCM535	NCM545 PC2505	PC2010 PC3700	PC6510 PC9540	PC5300 PC5400	H01 H05	
SEET 14M4AGFN-MA									E21	SEXT 14M4AGSN-MR									E21
14M4AGSN-MF		●		●	●	●	●	●	E22	SEEW 14M4AGTN	●								E22
14M4AGSN-MM		●		●	●	●	●	●		14M4AGFN-W									
SEXT 14M4AGSN-MF				●	●	●	●	●		14M4AGSN-W								●	
14M4AGSN-MM		●		●	●	●	●	●		14M4AGTN-W					●				

## Available arbors

Designation	Ød	NC arbors	Designation	Ød	NC arbors
FMACM 4050HR-□	22	BT□□-FMC22-□□	FMAC (FMACM) 4125HR-□	38.1	BT□□-FMA38.1-□□
4063HR-□		BT□□-FMA25.4-□□		40	BT□□-FMB40-□□
FMAC (FMACM) 4080HR-□	25.4	BT□□-FMC27-□□	4160R-□	50.8	BT□□-FMA50.8-□□
4100HR-□	27	BT□□-FMA31.75-□□		40	BT□□-FMB/FMC40-□□
	31.75	BT□□-FMC32-□□	4200R-□	47.625	BT□□-FMA47.625-□□
	32			60	BT□□-FMB60-□□

## Parts

Specification					
Ø50-Ø200	FTGA03512	SS42SAF	SHXN0509F	TW15S	HW35L

Available inserts E21, E22

Available arbors and bolt E426-E428

# FMAC(M)3000-A

Aluminum body

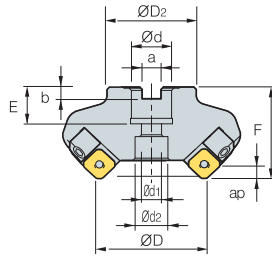


Fig. 1

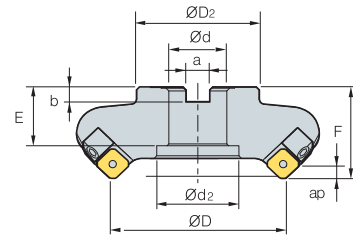


Fig. 2



AA  
45°  
• AR: 21°  
• RR: -16°~12°

(mm)

Designation		ØD	ØD <sub>2</sub>	Ød	a	b	E	F	Ød <sub>1</sub>	Ød <sub>2</sub>	ap		Fig.
FMACM 3063R-A	3	63	49	22	10.4	6.3	20	40	11	18	4	0.5	1
FMAC 3080R-A	4	80	57	25.4 (27)	9.5 (12.4)	6 (7)	25	50	13.5	20	4	0.6	1
(FMACM) 3100R-A	5	100	67	31.75 (32)	12.7 (14.4)	8 (8)	32	50	-	45	4	0.8	2
3100R-25.4-A	5	100	67	25.4	9.5	6	25	50	-	38	4	0.9	2
3125R-A	6	125	87	38.1 (40)	15.9 (16.4)	10 (9)	38	63	-	56	4	1.6	2
3125R-25.4-A	6	125	70	25.4	9.5	6	25	63	-	38	4	1.7	2

( ) Metric size

## Available inserts

		SEET-MF	SEET-MM	SEET-MA	SEXT-MF	SEXT-MM	SEXT-MR	SEEW														
Designation		Cermet		Coated										Uncoated				page				
		CN2500	CN30	NC5330	NCM325	NCM335	NCM535	NCM545	PC2505	PC2010	PC3700	PC6510	PC9530	PC9540	PC5300	PC5400	ST30A		G10	H01	H05	
SEET	0903AGFN-MA																					
	0903AGSN-MF										●	●								●	●	
	0903AGSN-MM				●						●	●										
SEXT	0903AGSN-MF										●	●										
	0903AGSN-MM									●	●											
	0903AGSN-MR																					
SEEW	0903AGTN																					

## Available arbors

Designation	Ød	NC arbors
FMACM 3063R-□	22	BT□□-FMC22-□□
FMAC (FMACM) 3080R-□	25.4	BT□□-FMA25.4-□□
	27	BT□□-FMC27-□□
3100R-□	31.75	BT□□-FMA31.75-□□
	32	BT□□-FMC32-□□
3125R-□	38.1	BT□□-FMA38.1-□□
	40	BT□□-FMB40-□□

## Parts

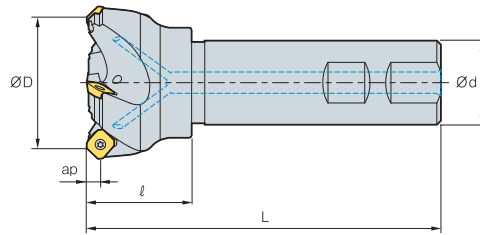
Specification					
Ø63~Ø125	FTKA0307	TW09S	HW30L	LFMA3R-A	DHA0620

Available inserts E21, E22 Available arbors and bolt E426-E428





## FMAS3000



AA  
45°

• AR: 23°  
• RR: -17°~13°

(mm)

Designation		ØD	Ød	ℓ	L	ap	
FMAS	3025HR	2	25	25	35	115	0.4
	3032HR	3	32	25	40	125	0.5
	3032HR-S32	3	32	32	40	130	0.8
	3040HR	3	40	32	40	130	0.9
	3040HR-S40	3	40	40	40	140	1.3
	3040HR-S42	3	40	42	40	140	1.4
	3050HR	4	50	32	40	135	1
	3050HR-S40	4	50	40	40	140	1.3
	3050HR-S42	4	50	42	40	140	1.5
	3063HR	5	63	32	45	135	1.2
	3063HR-S40	5	63	40	45	145	1.6
	3063HR-S42	5	63	42	45	145	1.7

### Available inserts

SEET-MF

SEET-MM

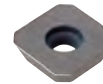
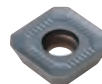
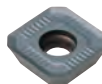
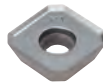
SEET-MA

SEXT-MF

SEXT-MM

SEXT-MR

SEEW



Designation	Cermet		Coated												Uncoated				page	
	CN2500	CN30	NC5330	NCM325	NCM335	NCM535	NCM545	PC2505	PC2010	PC3700	PC6510	PC9530	PC9540	PC5300	PC5400	ST30A	G10	H01		H05
SEET	0903AGFN-MA																			
	0903AGSN-MF										●	●		●	●			●	●	
	0903AGSN-MM				●						●			●	●					
SEXT	0903AGSN-MF										●			●	●					
	0903AGSN-MM								●	●				●	●					
	0903AGSN-MR																			
SEEW	0903AGTN																			

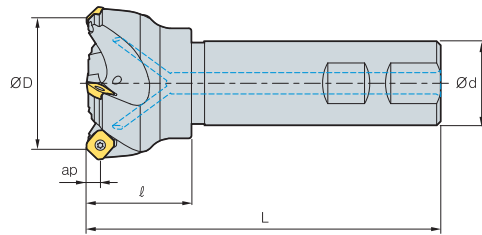
### Parts

Specification		
Ø25~Ø63	FTKA0307	TW09S

Available inserts E21, E22



# FMAS4000



AA  
45°

• AR: 23°  
• RR: -17°~-13°

(mm)

Designation		ØD	Ød	l	L	ap		
FMAS	4050HR	3	50	32	45	135	6.5	1
	4050HR-S40	3	50	40	45	135	6.5	1.3
	4050HR-S42	3	50	42	45	135	6.5	1.45
	4063HR	4	63	32	45	135	6.5	1.2
	4063HR-S40	4	63	40	45	135	6.5	1.5
	4063HR-S42	4	63	42	45	135	6.5	1.6

## Available inserts

SEET-MF

SEET-MM

SEET-MA

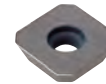
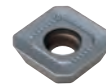
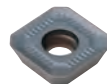
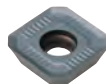
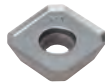
SEXT-MF

SEXT-MM

SEXT-MR

SEEW

SEEW-W



Designation	Cermet		Coated										Uncoated			page				
	CN2500	CN30	NC5330	NCM325	NCM335	NCM535	NCM545	PC2505	PC3700	PC6510	PC9530	PC9540	PC5300	PC5400	PD2000		PD1010	ST30A	H01	H05
SEET	14M4AGFN-MA																			
	14M4AGSN-MF					●				●	●		●	●				●	●	
	14M4AGSN-MM					●			●	●	●		●	●						
SEXT	14M4AGSN-MF									●	●		●	●						
	14M4AGSN-MM				●				●	●	●		●	●						E21
	14M4AGSN-MR										●		●							E22
SEEW	14M4AGTN		●																	
	14M4AGFN-W																			
	14M4AGSN-W												●							
	14M4AGTN-W									●										

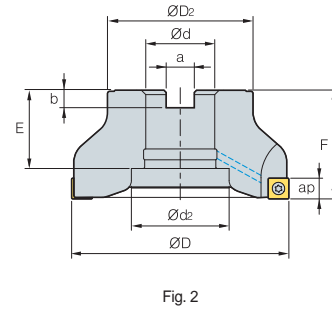
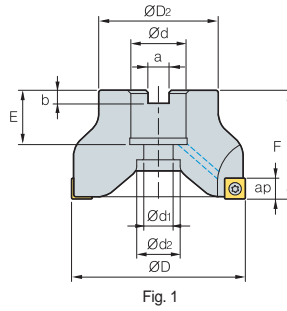
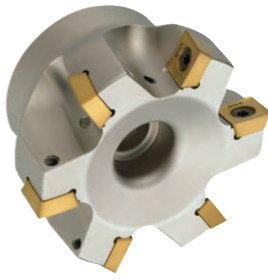
## Parts

Specification					
Ø50~Ø63	FTGA03512	SS42SAF	SHXN0509F	TW15S	HW35L

Available inserts E21, E22



# FMPC(M)3000



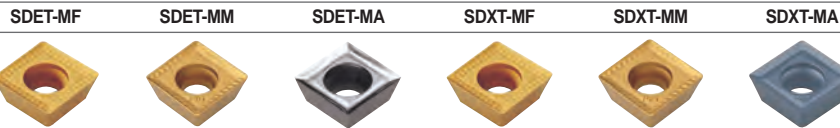
AA  
90°  
• AR: 10°  
• RR: -9°~8°

(mm)

Designation		$\varnothing D$	$\varnothing D_2$	$\varnothing d$	a	b	E	F	$\varnothing d_1$	$\varnothing d_2$	ap		Fig.	
FMPCM	3050HS	5	50	40	22	10.4	6.3	20	40	11	18	7	0.3	1
	3063HS	6	63	40	22	10.4	6.3	20	40	11	18	7	0.5	1
FMPC (FMPCM)	3080HS	7	80	55	25.4 (27)	9.5 (12.4)	6 (7)	25 (22)	50	14	20	7	1.0	1
	3100HS	8	100	67	31.75 (32)	12.7 (14.4)	8 (8)	36 (26)	50	18	45 (26)	7	1.5	2 (1)

( ) Metric size

## Available inserts



Designation	Cermet		Coated											Uncoated				page							
	CN2500	CN30	NC5330	NCM325	NCM335	NCM535	NCM545	PC2010	PC3700	PC6510	PC9530	PC9540	PC5300	PC5400	PD2000	ST30A	G10		H01	H05					
SDET	09M402R-MA																								
	09M405R-MF																								
	09M405R-MM																								
SDXT	09M405R-MF																								
	09M405L-MF																								
	09M405R-MM																								
	09M405L-MM																								
	09M405R-MA																								

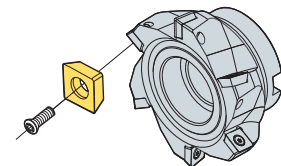
## Available arbors

Designation	$\varnothing d$	NC arbors
FMPCM	3050HS	BT□□-FMC22-□□
	3063HS	
FMPC (FMPCM)	3080HS	BT□□-FMA25.4-□□
		BT□□-FMC27-□□
	3100HS	BT□□-FMA31.75-□□
		BT□□-FMC32-□□

## Parts

Specification		
$\varnothing 50 \sim \varnothing 100$	Screw FTGA03508	Wrench TW15S

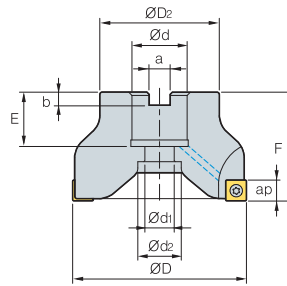
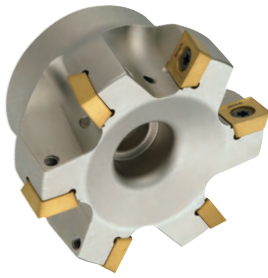
## Assembling



Available inserts E19, E20 Available arbors and bolt E426-E428



# FMPC(M)4000



AA  
90°  
• AR: 10°  
• RR: -9°~-8°

Designation			ØD	ØD <sub>2</sub>	Ød	a	b	E	F	Ød <sub>1</sub>	Ød <sub>2</sub>	ap	
FMPCM	4063HS	5	63	49	22	10.4	6.3	20 (20)	50 (50)	11	18	11	0.4
FMPC	4080HS	6	80	57	25.4 (27)	9.5 (12.4)	6 (7)	25 (23)	50 (50)	14	20	11	0.9
(FMPCM)	4100HS	7	100	67	31.75 (32)	12.7 (14.4)	8 (8)	33 (25)	63 (50)	18	26	11	1.9 (1.5)
	4125HS	8	125	87	38.1 (40)	15.9 (16.4)	10 (9)	35 (29)	63	22	32	11	3.1

(mm)

( )Metric size

## Available inserts

		SDET-MF	SDET-MM	SDET-MA	SDXT-MF	SDXT-MM	SDXT-MA																
Designation		Cermet		Coated								Uncoated				page							
		CN2500	CN30	NC5330	NCM325	NCM335	NCM535	NCM545	PC2010	PC3700	PC6510	PC9530	PC9540	PC5300	PC5400		PD1010	ST30A	G10	H01	H05		
SDET	130504R-MA																						
	130508R-MF																						
	130508R-MM																						
SDXT	130508R-MF																						E19
	130508R-MM																						E20
	130508R-MA																						

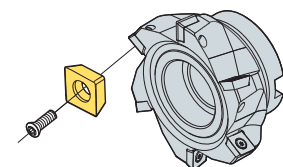
## Available arbors

Designation	Ød	NC arbors
FMPCM 4063HS	22	BT□□-FMC22-□□
FMPC 4080HS	25.4	BT□□-FMA25.4-□□
(FMPCM)	27	BT□□-FMC27-□□
	31.75	BT□□-FMA31.75-□□
	32	BT□□-FMC32-□□
	38.1	BT□□-FMA38.1-□□
	40	BT□□-FMB/FMC40-□□

## Parts

Specification		
Ø63-Ø125	FTNC04511	TW20S

## Assembling



Available inserts E19,E20 Available arbors and bolt E426-E428

# FMPC(M)3000-A

Aluminum body

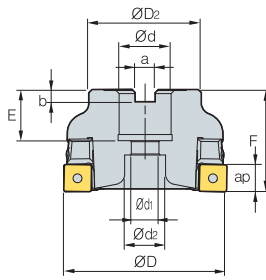
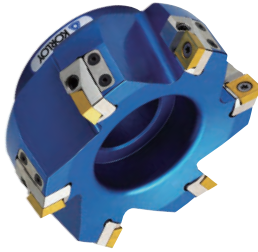


Fig. 1

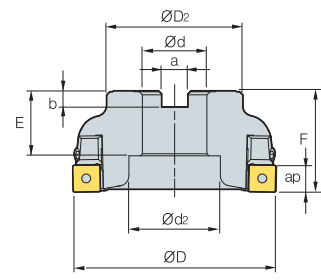


Fig. 2



AA  
90°

• AR: 10°  
• RR: -9°~-7.3°

(mm)

Designation	ØD	ØD <sub>2</sub>	Ød	a	b	E	F	Ød <sub>1</sub>	Ød <sub>2</sub>	ap	kg	Fig.
FMPCM 3063S-A	63	40	22	10.4	6.3	20	40	11.0	18	7	0.2	1
FMPC 3080S-A	80	55	25.4 (27)	9.5 (12.4)	6 (7)	25 (22)	50	13.5	20	7	0.4	1
(FMPCM) 3100S-A	100	67	31.75 (32)	12.7 (14.4)	8 (8)	32	50	-	45	7	0.6	2
3100S-25.4-A	100	67	25.4	9.5	6	25	50	-	38	7	0.7	2

( )Metric size

## Available inserts

SDET-MF

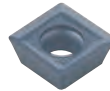
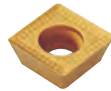
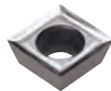
SDET-MM

SDET-MA

SDXT-MF

SDXT-MM

SDXT-MA



Designation	Cermet		Coated										Uncoated				page		
	CN2500	CN30	NC5330	NCM325	NCM335	NCM335	NCM345	PC2010	PC3700	PC6510	PC9530	PC9540	PC5300	PC5400	PD2000	ST30A		G10	H01
SDET 09M402R-MA															●			●	●
09M405R-MF																			
09M405R-MM																			
SDXT 09M405R-MF				●				●	●	●			●	●					
09M405L-MF																			
09M405R-MM				●	●			●	●	●			●	●					
09M405L-MM																			
09M405R-MA																		●	●

## Available arbors

Designation	Ød	NC arbors
FMPCM 3063S-□	22	BT□□-FMC22-□□
FMPC (FMPCM) 3080S-□	25.4	BT□□-FMA25.4-□□
	27	BT□□-FMC27-□□
3100S-□	31.75	BT□□-FMA31.75-□□
	32	BT□□-FMC32-□□
3100S-25.4-□	25.4	BT□□-FMA25.4-□□

## Parts

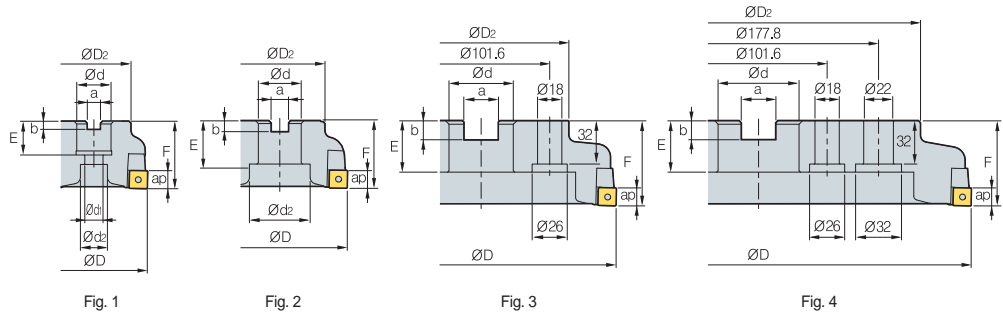
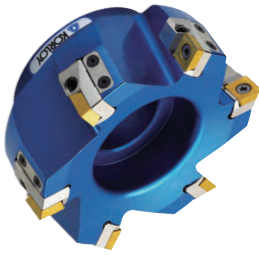
Specification	Screw	Insert wrench	Locator wrench	Locator	Locator screw	Chip cover	Chip cover screw
Ø63	FTGA03508	TW15S	HW30L	LFMP3R-A	DHA0624	CFMP3R14R1-A	PXMA0306
Ø80~Ø100	FTGA03508	TW15S	HW30L	LFMP3R-A	DHA0624	CFMP3R-A	PXMA0306

Available inserts E19, E20 Available arbors and bolt E426-E428



# FMPC(M)4000-A

Aluminum body



AA  
90°

• AR: 10°  
• RR: -9°~7.3°

(mm)

Designation		ØD	ØD <sub>2</sub>	Ød	a	b	E	F	Ød <sub>1</sub>	Ød <sub>2</sub>	ap		Fig.
FMPCM 4063S-A	3	63	49	22	10.4	6.3	20	50	11	18	11	0.6	1
FMPC 4080S-A	4	80	67	25.4 (27)	9.5 (12.4)	6 (7)	25 (22)	50	13.5	20	11	0.8	1
(FMPCM) 4100S-A	5	100	67	31.75 (32)	12.7 (14.4)	8(8)	32	50	-	45	11	1.1	2
4100S-25.4-A	5	100	67	25.4	9.5	6	25	50	-	38	11	1.2	2
4125S-A	6	125	87	38.1 (40)	15.9 (16.4)	10 (9)	38 (35)	63	-	56	11	1.7	2
4125S-25.4-A	6	125	70	25.4	9.5	6	25	63	-	38	11	1.8	2
4160S-A	8	160	107	50.8 (40)	19.0 (16.4)	11 (9)	38 (35)	63	-	75	11	2.5	2
4200S-A	10	200	130	47.625 (60)	25.4 (25.7)	14 (14)	38 (32)	63	-	-	11	3.2	3
4250S-A	12	250	180	47.625 (60)	25.4 (25.7)	14 (14)	38	63	-	-	11	4.1	3
4315S-A	15	315	240	47.625 (60)	25.4 (25.7)	14 (14)	38	63	-	-	11	6.7	4

( ) Metric size

## Available inserts

Designation	SDET-MF		SDET-MM		SDET-MA		SDXT-MF		SDXT-MM		SDXT-MA		page						
	Cermet		Coated									Uncoated							
	CN2500	CN30	NC5330	NCM325	NCM335	NCM535	NCM545	PC2010	PC3700	PC6510	PC9630	PC9540	PC5300	PC5400	PD1010	ST30A	G10	H01	H05
SDET																			
SDXT																			

## Available arbors

Designation	Ød	NC arbors	Designation	Ød	NC arbors
FMPCM 4063S-□	22	BT□□-FMC22-□□	FMPC 4125S-□	38.1	BT□□-FMA38.1-□□
FMPC 4080S-□	25.4	BT□□-FMA25.4-□□	(FMPCM) 4125S-□	40	BT□□-FMB40-□□
	27	BT□□-FMC27-□□	4125S-25.4-□	25.4	BT□□-FMA25.4-□□
	31.75	BT□□-FMA31.75-□□	4160S-□	50.8	BT□□-FMA38.1-□□
4100S-□	32	BT□□-FMC32-□□		40	BT□□-FMB/FMC40-□□
4100S-25.4-□	25.4	BT□□-FMA25.4-□□	4200S-□	47.625	BT□□-FMA47.625-□□
			4250S-□	60	BT□□-FMB60-□□
			4315S-□	60	BT□□-FMB60-□□

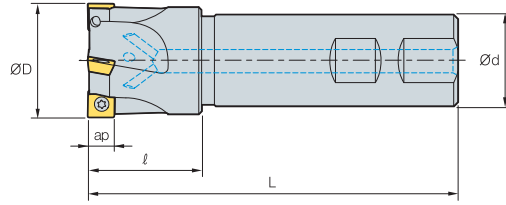
## Parts

Specification							
Ø63~Ø80	FTNC04509	TW20S	HW40L	LFMP4R1-A	DHA0825	CFMP3R14R1-A	PXMA0306
Ø100~Ø315	FTNC04509	TW20S	HW40L	LFMP4R-A	DHA0830	CFMP4R-A	PXMA0306

Available inserts E19, E20

Available arbors and bolt E426~E428

# FMPS3000

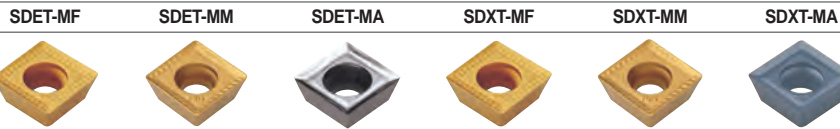


• AR: 10°  
• RR: -9°~8°

(mm)

Designation		ØD	Ød	l	L	ap	
FMPS	3025HS	2	25	25	35	115	0.4
	3032HS	3	32	25	40	125	0.5
	3040HS	4	40	32	40	130	0.8
	3040HS-S40	4	40	40	45	140	1.2
	3040HS-S42	4	40	42	45	140	1.3
	3050HS	5	50	32	40	135	1
	3050HS-S40	5	50	40	40	140	1.3
	3050HS-S42	5	50	42	40	140	1.4
	3063HS	6	63	32	45	135	1.2
	3063HS-S40	6	63	40	45	145	1.6
	3063HS-S42	6	63	42	45	145	1.7

## Available inserts

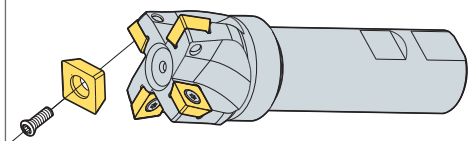


Designation	Cermet		Coated											Uncoated				page		
	CN2500	CN30	NC5330	NCM325	NCM335	NCM535	NCM545	PC2010	PC3700	PC6510	PC9530	PC9540	PC5300	PC5400	PD2000	ST30A	G10		H01	H05
SDET	09M402R-MA																			
	09M405R-MF																			
	09M405R-MM																			
SDXT	09M405R-MF																			E19
	09M405L-MF																			E20
	09M405R-MM																			
	09M405L-MM																			
	09M405R-MA																			

## Parts

Specification		
Ø25~Ø63	FTGA03508	TW15S

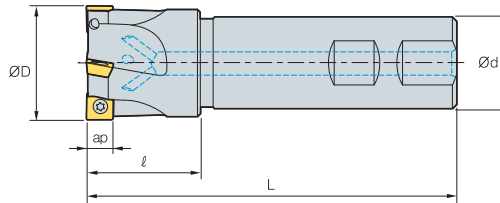
## Assembling



Available inserts E19, E20

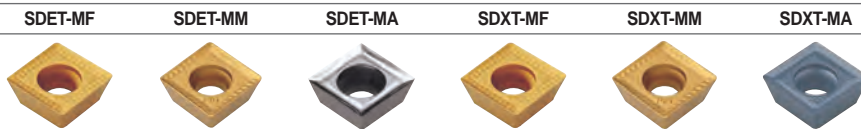


# FMPS4000



Designation			ØD	Ød	ℓ	L	ap	
FMPS	4040HS	3	40	32	40	130	11	1
	4040HS-S40	3	40	40	40	140	11	1.3
	4040HS-S42	3	40	42	40	140	11	1.4
	4050HS	4	50	32	45	135	11	1.5
	4050HS-S40	4	50	40	45	145	11	1.7
	4050HS-S42	4	50	42	45	145	11	1.6
	4063HS	5	63	32	45	135	11	2.1
	4063HS-S40	5	63	40	45	145	11	2.4
4063HS-S42	5	63	42	45	145	11	2.6	

## Available inserts

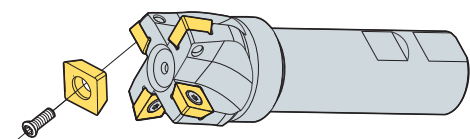


Designation	Cermet		Coated										Uncoated				page				
	CN2500	CN30	NC5330	NCM325	NCM335	NCM535	NCM545	PC2010	PC3700	PC6510	PC9530	PC9540	PC5300	PC5400	PD1010	ST30A		G10	H01	H05	
SDET	130504R-MA														●			●	●	E19	
	130508R-MF																				E20
	130508R-MM																				
SDXT	130508R-MF			●						●	●		●	●							
	130508R-MM			●	●				●	●	●		●	●							
	130508R-MA																	●	●		

## Parts

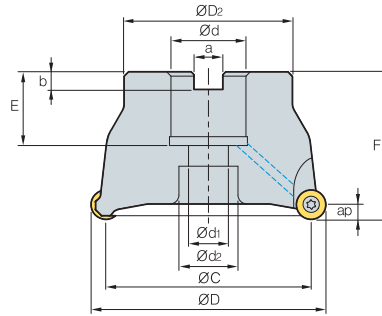
Specification		
Ø40~Ø63	FTNC04511	TW20S

## Assembling



Available inserts E19, E20

## FMRC(M)3000



• AR: 5°  
• RR: -5°

(mm)

Designation		ØD	ØC	ØD <sub>2</sub>	Ød	a	b	E	F	Ød <sub>1</sub>	Ød <sub>2</sub>	ap	kg	
FMRCM	3040HRD	3	40	30	36	16	8.4	5.6	18	40	9	14	5.0	0.2
	3040HRD-H	4	40	30	36	16	8.4	5.6	18	40	9	14	5.0	0.2
	3050HRD	4	50	40	42	22	10.4	6.3	20	40	11	16.5	5.0	0.3
	3050HRD-H	5	50	40	42	22	10.4	6.3	20	40	11	16.5	5.0	0.3
	3063HRD	5	63	53	49	22	10.4	6.3	20	50	11	16.5	5.0	0.64
	3063HRD-H	6	63	53	49	22	10.4	6.3	20	50	11	16.5	5.0	0.64
FMRC (FMRCM)	3080HRD	6	80	70	57	25.4 (27)	9.5 (12.4)	6 (7.0)	25 (22)	50 (50)	14	19	5.0	1.1
	3080HRD-H	7	80	70	57	25.4 (27)	9.5 (12.4)	6 (7.0)	25 (22)	50 (50)	14	19	5.0	1.1
	3100HRD	7	100	90	67	31.75 (32)	12.7 (14.4)	8 (8.0)	32 (28)	63 (63)	18	26	5.0	2.1
	3100HRD-H	8	100	90	67	31.75 (32)	12.7 (14.4)	8 (8.0)	32 (28)	63 (63)	18	26	5.0	2.1

Note) It's general that you measure of inner diameter when the diameter of FMRC/FMRCM is Ø40-Ø63

( ) Metric size

### Available inserts

RDKT-MF      RDKT-MM      RDCT-MA



Designation	Cermet		Coated										Uncoated		page		
	CN2500	CN30	NC5330	NCM325	NCM535	NCM545	PC2505	PC2010	PC3700	PC6510	PC9530	PC9540	PC5300	PC5400		ST30A	H01
RDCT 10T3M0-MA																●	E16 E17
RDKT 10T3M0-MF																	
10T3M0-MM				●					●	●	●		●				

### Available arbors

Designation	Ød	NC arbors
FMRCM	3040HRD	BT□□-FMC16-□□
	3040HRD-H	
	3050HRD	
	3050HRD-H	
	3063HRD	
	3063HRD-H	
FMRC (FMRCM)	3080HRD	BT□□-FMA/FMB25.4-□□ BT□□-FMB/FMC27-□□ BT□□-FMA31.75-□□ BT□□-FMC32-□□
	3080HRD-H	
	3100HRD	
	3100HRD-H	

### Parts

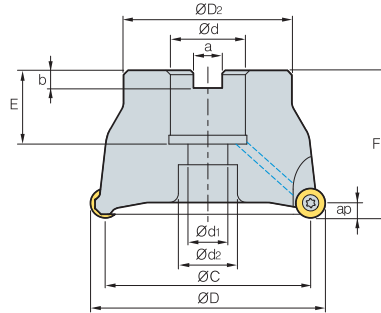
Specification	Screw	Wrench
Ø40~Ø100	FTGA03508	TW15S

Available inserts E16, E17      Available arbors and bolt E426-E428





# FMRC(M)4000



• AR: 5°  
• RR: -5°

(mm)

Designation		ØD	ØC	ØD <sub>2</sub>	Ød	a	b	E	F	Ød <sub>1</sub>	Ød <sub>2</sub>	ap		
FMRCM	4050HRD	4	50	38	42	22	10.4	6.3	20	50	11	18	6.0	0.4
	4063HRD	4	63	51	49	22	10.4	6.3	20	50	11	18	6.0	0.6
	4063HRD-M	5	63	51	49	22	10.4	6.3	20	50	11	18	6.0	0.6
FMRC (FMRCM)	4080HRD	5	80	68	57	25.4 (27)	9.5 (12.4)	6 (7.0)	25 (23)	50 (50)	14	20	6.0	1.0
	4080HRD-M	6	80	68	57	25.4 (27)	9.5 (12.4)	6 (7.0)	25 (23)	50 (50)	14	20	6.0	1.0
	4100HRD	6	100	88	67	31.75 (32)	12.7 (14.4)	8 (8.0)	33 (25)	63 (50)	18	26	6.0	1.9 (1.5)
	4100HRD-M	7	100	88	67	31.75 (32)	12.7 (14.4)	8 (8.0)	33 (25)	63 (50)	18	26	6.0	1.9 (1.5)
	4125HRD	7	125	113	87	38.1 (40)	15.9 (16.4)	10 (9.0)	35 (29)	63 (63)	22	32	6.0	3.0
4125HRD-M	8	125	113	87	38.1 (40)	15.9 (16.4)	10 (9.0)	35 (29)	63 (63)	22	32	6.0	3.0	

Note) It's general that you measure of inner diameter when the diameter of FMRC/FMRCM is Ø50-Ø63

( ) Metric size

## Available inserts

RDKT-MF      RDKT-MM      RDCT-MA



Designation	Cermet		Coated										Uncoated		page		
	CN2500	CN30	NC5330	NCM325	NCM535	NCM545	PC2505	PC2010	PC3700	PC6510	PC9530	PC9540	PC5300	PC5400		ST30A	H01
RDCT 1204M0-MA																●	E16 E17
RDKT 1204M0-MF								●		●		●					
1204M0-MM				●				●	●	●		●					

## Available arbors

Designation	Ød	NC arbors
FMRCM 4063HRD	22	BT□□-FMC22-□□
4063HRD-M		
FMRC (FMRCM) 4080HRD	25.4	BT□□-FMA/FMB25.4-□□
4080HRD-M		
4080HRD	27	BT□□-FMB/FMC27-□□
4080HRD-M		
4100HRD	31.75	BT□□-FMA31.75-□□
4100HRD-M		
4125HRD	38.1	BT□□-FMA/FMB38.1-□□
4125HRD-M		
4125HRD	40	BT□□-FMB/FMC40-□□
4125HRD-M		

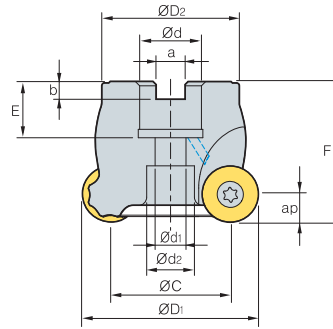
## Parts

Specification		
Ø50-Ø125	FTKA0410	TW15S

Available inserts E16, E17

Available arbors and bolt E426-E428

# FMRC(M)5000



• AR: 5°  
• RR: -5°

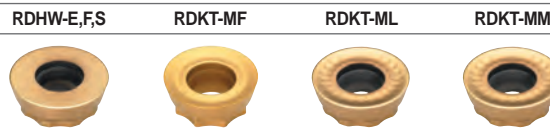
(mm)

Designation		ØD	ØC	ØD <sub>2</sub>	Ød	a	b	E	F	Ød <sub>1</sub>	Ød <sub>2</sub>	ap		
FMRCM	5050HRD	3	50	34	42	22	10.4	6.3	20	50	11	16.5	8.0	0.4
	5063HRD	4	63	47	49	22	10.4	6.3	20	50	11	18	8.0	0.6
	5063HRD-H	5	63	47	49	22	10.4	6.3	20	50	11	18	8.0	0.6
FMRC (FMRCM)	5080HRD	5	80	64	57	25.4 (27)	9.5 (12.4)	6 (7.0)	25 (23)	50 (50)	14	20	8.0	0.9
	5080HRD-H	6	80	64	57	25.4 (27)	9.5 (12.4)	6 (7.0)	25 (23)	50 (50)	14	20	8.0	0.9
	5100HRD	6	100	84	67	31.75 (32)	12.7 (14.4)	8 (8)	33 (25)	63 (50)	18	26	8.0	1.9 (1.4)
	5100HRD-H	7	100	84	67	31.75 (32)	12.7 (14.4)	8 (8)	33 (25)	63 (50)	18	26	8.0	1.9 (1.4)
	5125HRD	7	125	109	87	38.1 (40)	15.9 (16.4)	10 (9)	35 (29)	63 (63)	22	32	8.0	3
5125HRD-H	8	125	109	87	38.1 (40)	15.9 (16.4)	10 (9)	35 (29)	63 (63)	22	32	8.0	3	

Note) It's general that you measure of inner diameter when the diameter of FMRC/FMRCM is Ø50-Ø63

( ) Metric size

## Available inserts



Designation	Cermet		Coated										Uncoated		page		
	CN2500	CN30	NC5330	NCM325	NCM535	NCM545	PC2505	PC2010	PC3700	PC6510	PC9530	PC9540	PC5300	PC5400		ST30A	H01
RDHW	1605M0E																
	1605M0F																
	1605M0S																E16
RDKT	1605M0-MM							●									E17
	1605M0-MF																
	1605M0-ML																

## Available arbors

Designation	Ød	NC arbors
FMRCM	22	BT□□-FMC22-□□
5050HRD		
5063HRD		
5063HRD-H		
FMRC (FMRCM)	25.4	BT□□-FMA/FMB25.4-□□
5080HRD	27	BT□□-FMB/FMC27-□□
5080HRD-H	31.75	BT□□-FMA31.75-□□
5100HRD	32	BT□□-FMC32-□□
5100HRD-H	38.1	BT□□-FMA/FMB38.1-□□
5125HRD	40	BT□□-FMB/FMC40-□□
5125HRD-H		

## Parts

Specification		
Ø50~Ø125	FTGA0513-P	TW20-100

Available inserts E16, E17 Available arbors and bolt E426-E428



# FMRC(M)6000

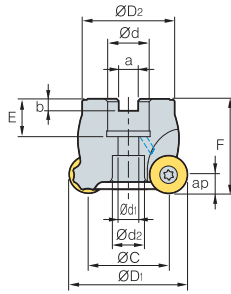


Fig. 1

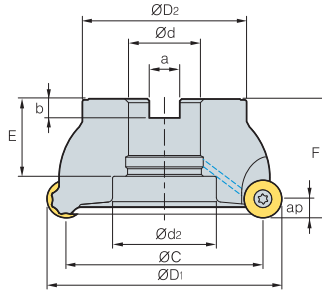


Fig. 2

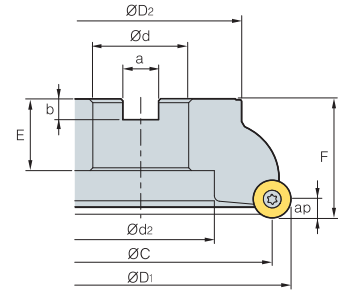


Fig. 3



• AR: 5°  
• RR: -5°

(mm)

Designation		ØD	ØC	ØD <sub>2</sub>	Ød	a	b	E	F	Ød <sub>1</sub>	Ød <sub>2</sub>	ap		Fig.	
FMRCM	6063HRD	3	63	43	49	22	10.4	6.3	20	50	11	17	10.0	0.5	1
	6063HRD-M	4	63	43	49	22	10.4	6.3	20	50	11	17	10.0	0.5	1
FMRC (FMRCM)	6080HRD	4	80	60	57	25.4 (27)	9.5 (12.4)	6 (7.0)	25 (22)	50	14	20	10.0	0.8	1
	6080HRD-M	5	80	60	57	25.4 (27)	9.5 (12.4)	6 (7.0)	25 (22)	50	14	20	10.0	0.8	1
	6100HRD	5	100	80	67	31.75 (32)	12.7 (14.4)	8 (8)	32 (28)	63	18	26	10.0	1.6	1
	6100HRD-M	6	100	80	67	31.75 (32)	12.7 (14.4)	8 (8)	32 (28)	63	18	26	10.0	1.6	1
	6125HRD	6	125	105	87	38.1 (40)	15.9 (16.4)	10 (9)	41 (29)	63	- (22)	55 (32)	10.0	2.7 (2.9)	2 (1)
	6125HRD-M	7	125	105	87	38.1 (40)	15.9 (16.4)	10 (9)	41 (29)	63	- (22)	55 (32)	10.0	2.7 (2.9)	2 (1)
6160RD	7	160	140	107	50.8 (40)	19 (16.4)	11 (9)	38 (35)	63	-	78	10.0	4.4	3	
6160RD-M	8	160	140	107	50.8 (40)	19 (16.4)	11 (9)	38 (35)	63	-	78	10.0	4.4	3	

( ) Metric size

## Available inserts

RDHW-E,F,S      RDKT-MM



Designation	Cermet		Coated											Uncoated		page	
	CN2500	CN30	NC5330	NCM325	NCM535	NCM545	PC2505	PC2010	PC3700	PC6510	PC9530	PC9540	PC5300	PC5400	ST30A		H01
RDHW	2006M0E																E16
	2006M0F																
	2006M0S																
RDKT	2006M0-MM							●									

## Available arbors

Designation	Ød	NC arbors
FMRCM	6063HRD	BT□□-FMC22-□□
	6063HRD-M	
FMRC (FMRCM)	6080HRD	BT□□-FMA/FMB25.4-□□
	6080HRD-M	BT□□-FMB/FMC27-□□
	6100HRD	BT□□-FMA31.75-□□
	6100HRD-M	BT□□-FMC32-□□
	6125HRD	BT□□-FMA/FMB38.1-□□
	6125HRD-M	BT□□-FMB/FMC40-□□
	6160RD	BT□□-FMA50.8-□□
	6160RD-M	BT□□-FMB/FMC40-□□

## Parts

Specification		
Ø63-Ø160	FTGA0515-P	TW20-100

Available inserts E16, E17

Available arbors and bolt E426-E428

# FMRS1000/1500

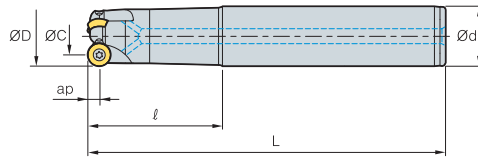


Fig. 1

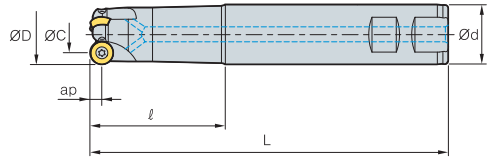


Fig. 2



• AR: 5°  
• RR: -5°~1°

(mm)

Designation			ØD	ØC	Ød	ℓ	L	ap		Fig.
FMRS	1008HRD-M	1	8	5.5	10	30	80	2.5	0.2	1
	1008HRD-L	1	8	5.5	10	50	100	2.5	0.2	1
	1010HRD-M	1	10	5	12	44	100	2.5	0.2	1
	1010HRD-L	1	10	5	12	64	120	2.5	0.2	1
	1012HRD-M	2	12	7	12	44	100	2.5	0.3	1
	1012HRD-L	2	12	7	16	80	160	2.5	0.3	1
	1015HRD-M	3	15	10	16	80	160	2.5	0.3	1
	1015HRD-L	3	15	10	16	100	200	2.5	0.4	1
FMRS	1510HRD-M	1	10	6	12	44	100	3.0	0.2	1
	1510HRD-L	1	10	6	12	64	120	3.0	0.2	1
	1512HRD-M	2	12	6	12	54	110	3.0	0.3	1
	1512HRD-L	2	12	6	16	80	160	3.0	0.3	1
	1516HRD-M	3	16	10	16	60	130	3.0	0.3	1
	1516HRD-L	3	16	10	20	90	180	3.0	0.4	1
	1520HRD-M	3	20	14	20	80	150	3.0	0.4	1
	1520HRD-L	3	20	14	20	90	200	3.0	0.5	1

## Available inserts

RDHW-E,FS      RDKW



Type	Designation	Cermet		Coated										Uncoated		page		
		CN2500	CN30	NC5330	NCM325	NCM535	NCM545	PC2505	PC2010	PC3700	PC6510	PC9530	PC9540	PC5300	PC5400		ST30A	H01
1000 type	RDHW	0501M0E										●						E16 E17
		0501M0F																
		0501M0S																
1500 type	RDKW	0501M0E								●								
	RDHW	06T1M0E									●							
		06T1M0F																
		06T1M0S																
	RDKW	06T1M0E								●								

## Parts

Specification		
Ø8~Ø15 (1000 type)	FTNA0203	TW06P
Ø10~Ø20 (1500 type)	FTNA02205	TW06P

Available inserts E16, E17



# FMRS2000/2500

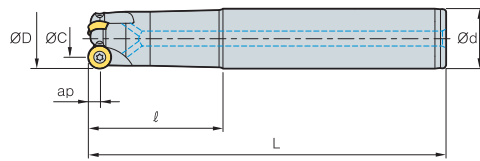


Fig. 1

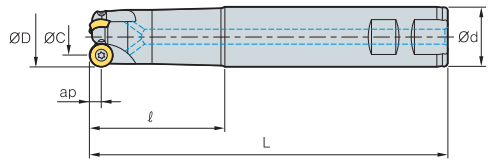


Fig. 2



• AR: 5°  
• RR: -5°~1°

(mm)

Designation		ØD	ØC	Ød	ℓ	L	ap		Fig.	
FMRS	2015HRD-S	2	15	8	16	55	115	3.5	0.3	2
	2015HRD-M	2	15	8	20	80	150	3.5	0.4	1
	2015HRD-L	2	15	8	20	90	200	3.5	0.5	1
	2020HRD-S	3	20	14	20	65	125	3.5	0.3	2
	2020HRD-M	3	20	14	20	80	150	3.5	0.4	1
	2020HRD-L	3	20	14	25	90	200	3.5	0.5	1
FMRS	2516HRD-S	2	16	8	16	65	125	4.0	0.3	2
	2516HRD-M	2	16	8	16	80	150	4.0	0.4	1
	2516HRD-L	2	16	8	20	90	200	4.0	0.5	1
	2520HRD-S	2	20	12	20	65	125	4.0	0.4	2
	2520HRD-M	2	20	12	20	80	150	4.0	0.5	1
	2520HRD-L	2	20	12	25	90	200	4.0	0.6	1
	2525HRD-S	3	25	17	25	55	125	4.0	0.5	2
	2525HRD-M	3	25	17	25	90	200	4.0	0.6	1
	2525HRD-L	3	25	17	32	110	250	4.0	0.7	1

## Available inserts

RDHW-E,F,S      RDKW



Type	Designation	Cermet		Coated										Uncoated		page			
		CN2500	CN30	NC5330	NCM325	NCM535	NCM545	PC2505	PC2010	PC3700	PC6510	PC9530	PC9540	PC5300	PC5400		ST30A	H01	
2000 type	RDHW	0702M0E																	E16
		0702M0F																	
		0702M0S																	
2500 type	RDKW	0702M0E																	E17
	RDHW	0803M0E																	
		0803M0F																	
		0803M0S																	
	RDKW	0803M0E																	

## Parts

Specification		
Ø15-Ø20 (2000 type)	FTNA02555	TW07S
Ø16-Ø25 (2500 type)	FTNA0305	TW09S
	FTNA0306 (Ø20 over)	

Available inserts E16, E17

# FMRS3000

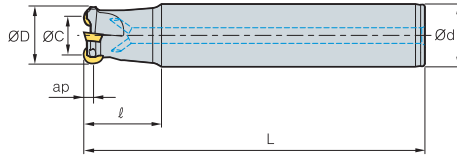


Fig. 1

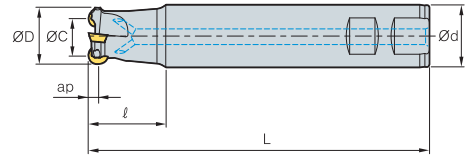


Fig. 2



• AR: 5°  
• RR: -8°~5°

(mm)

Designation		ØD	ØC	Ød	ℓ	L	ap		Fig.
FMRS	3021HRD-M	1	21	11	20	40	150	0.4	1
	3021HRD-M2	2	21	11	20	40	150	0.4	1
	3021HRD-L	1	21	11	20	50	200	0.6	1
	3021HRD-L2	2	21	11	20	50	200	0.6	1
	3025HRD-S	2	25	15	25	35	115	0.5	2
	3025HRD-M	2	25	15	25	70	200	0.7	1
	3025HRD-L	2	25	15	25	100	250	1	1
	3026HRD-M	2	26	16	25	70	200	0.65	1
	3026HRD-L	2	26	16	25	100	250	0.7	1
	3032HRD-S	3	32	22	32	40	125	1	2
	3032HRD-M	3	32	22	32	70	200	1.3	1
	3032HRD-L	3	32	22	32	150	300	1.6	1
	3040HRD-S	4	40	30	32	40	125	1.3	2
	3040HRD-M	4	40	30	32	70	200	1.5	1
3040HRD-L	4	40	30	32	150	300	1.8	1	

## Available inserts

RDKT-MF      RDKT-MM      RDCT-MA



Designation	Cermet		Coated										Uncoated		page		
	CN2500	CN30	NC5330	NCM325	NCM535	NCM545	PC2505	PC2010	PC3700	PC6510	PC9530	PC9540	PC5300	PC5400		ST30A	H01
RDCT 10T3M0-MA																●	E16 E17
RDKT 10T3M0-MF																	
10T3M0-MM				●					●	●	●		●				

## Parts

Specification		
Ø21 Ø25-Ø40	FTGA03507 FTGA03508	TW15S

Available inserts E16, E17



# FMRS4000

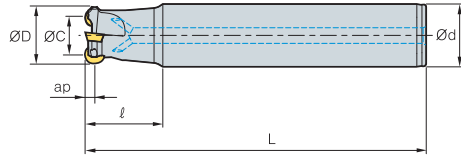


Fig. 1

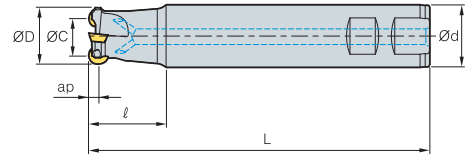


Fig. 2



• AR: 5°  
• RR: -8°~5°

(mm)

Designation		ØD	ØC	Ød	ℓ	L	ap		Fig.
<b>FMRS</b>									
4032HRD-S	2	32	20	32	40	125	6	0.8	2
4032HRD-M	2	32	20	32	70	200	6	1.1	1
4032HRD-L	2	32	20	32	150	300	6	1.6	1
4033HRD-S	2	33	21	32	40	125	6	0.9	2
4033HRD-M	2	33	21	32	70	200	6	1.1	1
4033HRD-L	2	33	21	32	150	300	6	1.7	1
4040HRD-S	3	40	28	32	40	125	6	1	2
4040HRD-M	3	40	28	32	70	200	6	1.6	1
4040HRD-L	3	40	28	32	150	300	6	1.8	1
4040HRD-S40	3	40	28	40	40	125	6	1.3	2
4040HRD-M40	3	40	28	40	70	200	6	2	1
4040HRD-L40	3	40	28	40	150	300	6	2.4	1
4040HRD-S42	3	40	28	42	40	125	6	1.6	2
4040HRD-M42	3	40	28	42	70	200	6	2.4	1
4040HRD-L42	3	40	28	42	150	300	6	2.8	1
4050HRD-S	4	50	38	42	50	125	6	1.5	2
4050HRD-M	4	50	38	42	50	250	6	2.1	1
4050HRD-L	4	50	38	42	50	300	6	2.7	1
4050HRD-S40	4	50	38	40	50	150	6	2	2
4050HRD-M40	4	50	38	40	50	250	6	2.6	1
4050HRD-L40	4	50	38	40	50	300	6	3.2	1

## Available inserts

RDKT-MF      RDKT-MM      RDCT-MA



Designation	Cermet		Coated										Uncoated		page			
	CN2500	CN30	NC5330	NCM325	NCM535	NCM545	PC2505	PC2010	PC3700	PC6510	PC9530	PC9540	PC5300	PC5400		ST30A	H01	
RDCT 1204M0-MA																	●	E16 E17
RDKT 1204M0-MF									●		●		●					
RDKT 1204M0-MM				●					●	●	●		●					

## Parts

Specification		
Ø32~Ø50	FTKA0410	TW15S

Available inserts E16, E17



# FMRS5000

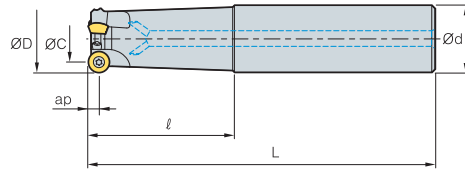


Fig. 1

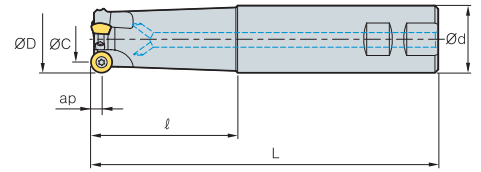


Fig. 2



• AR: 5°  
• RR: -8°~5°

(mm)

Designation			ØD	ØC	Ød	ℓ	L	ap		Fig.
FMRS	5040HRD-S	2	40	24	32	40	125	8	1.4	2
	5040HRD-M	2	40	24	32	70	200	8	1.8	1
	5040HRD-L	2	40	24	32	150	300	8	2.0	1
	5040HRD-S40	2	40	24	40	40	125	8	1.6	2
	5040HRD-M40	2	40	24	40	70	200	8	2.0	1
	5040HRD-L40	2	40	24	40	150	300	8	2.4	1
	5040HRD-S42	2	40	24	42	40	125	8	2.0	2
	5040HRD-M42	2	40	24	42	70	200	8	2.4	1
	5040HRD-L42	2	40	24	42	150	300	8	2.8	1
	5050HRD-S40	3	50	34	40	50	150	8	2.0	2
	5050HRD-M40	3	50	34	40	50	250	8	2.4	1
	5050HRD-L40	3	50	34	40	50	300	8	2.6	1
	5050HRD-S	3	50	34	42	50	150	8	1.5	2
	5050HRD-M	3	50	34	42	50	250	8	1.8	1
	5050HRD-L	3	50	34	42	50	300	8	2.0	1
	5063HRD-S40	4	63	47	40	50	150	8	1.7	2
	5063HRD-M40	4	63	47	40	50	250	8	2.0	1
	5063HRD-L40	4	63	47	40	50	300	8	2.3	1
	5063HRD-S	4	63	47	42	50	150	8	1.6	2
	5063HRD-M	4	63	47	42	50	250	8	1.8	1
5063HRD-L	4	63	47	42	50	300	8	2.0	1	

## Available inserts

RDHW-E,F,S      RDKT-MF      RDKT-ML      RDKT-MM



Designation	Cermet		Coated										Uncoated		page		
	CN2500	CN30	NC5330	NCM325	NCM635	NCM545	PC2505	PC2010	PC3700	PC6510	PC9530	PC9540	PC5300	PC5400		ST30A	H01
RDHW	1605M0E																
	1605M0F																
	1605M0S																E16
RDKT	1605M0-MF							●									E17
	1605M0-MM																
	1605M0-ML																

## Parts

Specification		
Ø40~Ø63	FTGA0513-P	TW20-100

Available inserts E16, E17



# FMRS6000

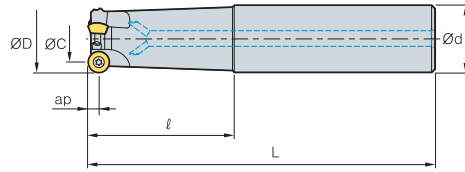


Fig. 1

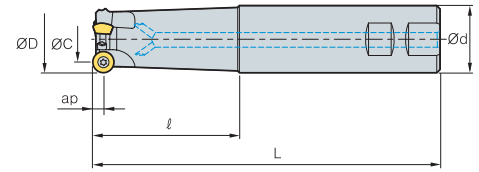


Fig. 2



• AR: 5°  
• RR: -8°~5°

(mm)

Designation		ØD	ØC	Ød	l	L	ap		Fig.	
FMRS	6050HRD-S40	3	50	31	40	50	150	1.3	2	
	6050HRD-S42	3	50	31	42	50	150	1.4	2	
	6050HRD-M40	3	50	31	40	250	10	2.2	1	
	6050HRD-M42	3	50	31	42	250	10	2.4	1	
	6050HRD-L40	3	50	31	40	50	300	10	2.7	1
	6050HRD-L42	3	50	31	42	50	300	10	3.0	1
	6063HRD-S40	4	63	44	40	50	150	10	1.5	2
	6063HRD-S42	4	63	44	42	50	150	10	1.6	2
	6063HRD-M40	4	63	44	40	50	250	10	2.5	1
	6063HRD-M42	4	63	44	42	50	250	10	2.7	1
	6063HRD-L40	4	63	44	40	50	300	10	3.0	1
	6063HRD-L42	4	63	44	42	50	300	10	3.2	1

## Available inserts

RDHW-E,F,S      RDKT-MM



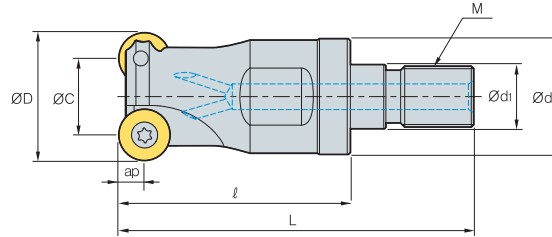
Designation	Cermet		Coated										Uncoated		page		
	CN2500	CN30	NC5330	NCM325	NCM535	NCM545	PC2505	PC2010	PC3700	PC6510	PC9530	PC9540	PC5300	PC5400		ST30A	H01
RDHW 2006M0E																	E16 E17
RDHW 2006M0F																	
RDHW 2006M0S																	
RDKT 2006M0-MM								●									

## Parts

Specification		
Ø50~Ø63	FTGA0515-P	TW20-100

Available inserts E16, E17

# FMRM1000/1500



• AR: 0°~5°  
• RR: -5°~-1°

(mm)

Designation	Inserts	ØD	ØC	Ød	Ød1	ℓ	L	M	ap	kg	
FMRM	1008HRD-M06	1	8	5.5	9.5	6.5	25	40	M06	2.5	0.02
	1010HRD-M06	2	10	5	9.5	6.5	25	40	M06	2.5	0.02
	1012HRD-M06	2	12	7	11	6.5	25	40	M06	2.5	0.02
	1015HRD-M08	3	15	10	14.5	8.5	30	47	M08	2.5	0.04
FMRM	1510HRD-M06	1	10	7	9.5	6.5	25	40	M06	3.0	0.02
	1512HRD-M06	2	12	6	11	6.5	25	40	M06	3.0	0.02
	1516HRD-M08	3	16	10	14.5	8.5	30	47	M08	3.0	0.02
	1520HRD-M10	3	20	14	18	10.5	35	56	M10	3.0	0.07

## Available inserts

RDHW-E,F,S      RDKW



Type	Designation	Cermet		Coated										Uncoated		page		
		CN2500	CN30	NC5330	NCM325	NCM635	NCM545	PC2505	PC2010	PC3700	PC6510	PC9530	PC9540	PC5300	PC5400		ST30A	H01
1000 type	RDHW	0501M0E																
		0501M0F																
		0501M0S																
1500 type	RDKW	0501M0E																E16
	RDHW	06T1M0E																E17
		06T1M0F																
	RDKW	06T1M0E																

## Available adaptor

Designation	Available adaptor
FMRM 1008HRD-M06	MAT-M06
1010HRD-M06	
1012HRD-M06	
1015HRD-M08	MAT-M08
1510HRD-M06	MAT-M06
1512HRD-M06	
1515HRD-M08	
1520HRD-M10	MAT-M10

Designation : FMRM1008HRD-M06  
Modular head threading measure size (M06)

||

Adaptor spec.: MAT-M06-020-S10S  
Adaptor threading measure (M06)

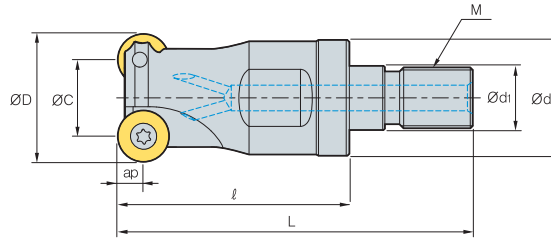
## Parts

Specification	Screw	Wrench
Ø8~Ø15 (1000 type)	FTNA0203	TW06P
Ø10~Ø20 (1500 type)	FTNA02205	TW06P

Available inserts E16, E17      Available adaptor E401-E402



# FMRM2000/2500



• AR: 0°~5°  
• RR: -5°~1°

(mm)

Designation		ØD	ØC	Ød	Ød1	l	L	M	ap		
FMRM	2015HRD-M08	2	15	8	14.5	8.5	30	47	M08	3.5	0.04
	2020HRD-M10	3	20	13	18	10.5	35	56	M10	3.5	0.07
FMRM	2516HRD-M08	2	16	8	14.5	8.5	30	47	M08	4.0	0.04
	2520HRD-M10	2	20	12	18	10.5	35	56	M10	4.0	0.07
	2525HRD-M12	3	25	17	22.5	12.5	45	69	M12	4.0	0.13

## Available inserts

RDHW-E,F,S      RDKW



Type	Designation	Cermet		Coated										Uncoated		page			
		CN2500	CN30	NC5330	NCM325	NCM535	NCM545	PC2505	PC2010	PC3700	PC6510	PC9530	PC9540	PC5300	PC5400		ST30A	H01	
2000 type	RDHW	0702M0E																	E16 E17
		0702M0F																	
		0702M0S																	
RDKW	0702M0E																		
2500 type	RDHW	0803M0E																	
		0803M0F																	
		0803M0S																	
RDKW	0803M0E																		

## Available adaptor

Designation	Available adaptor
FMRM 2015HRD-M08	MAT-M08
2020HRD-M10	MAT-M10
2516HRD-M08	MAT-M08
2520HRD-M10	MAT-M10
2525HRD-M12	MAT-M12

Designation : FMRM2015HRD-M08  
Modular head threading measure size (M08)

||

Adaptor spec.: MAT-M08-020-S16S  
Adaptor threading measure (M08)

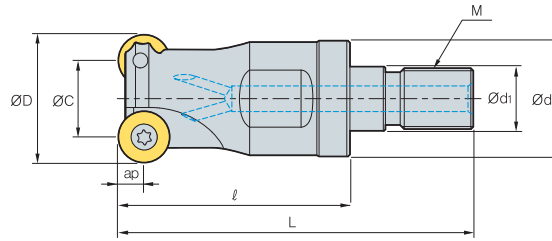
## Parts

Specification		
Ø15-Ø20 (2000 type)	FTNA02555	TW07S
Ø16-Ø25 (2500 type)	FTNA0305	TW09S

Available inserts E16, E17      Available adaptor E401-E402



## FMRM3000



• AR: 5°  
• RR: -8° ~ -5°

(mm)

Designation		ØD	ØC	Ød	Ød1	ℓ	L	M	ap		
FMRM	3021HRD-M10	2	21	11	18	10.5	35	56	M10	5.0	0.1
	3025HRD-M12	2	25	15	22.5	12.5	45	69	M12	5.0	0.15
	3032HRD-M16	3	32	22	29	17	50	77	M16	5.0	0.2
	3042HRD-M16	4	42	32	29	17	50	77	M16	5.0	0.24

### Available inserts

RDHW-E,FS    RDCT-MA    RDKT-MF    RDKT-ML    RDKT-MM



Designation	Cermet		Coated										Uncoated		page			
	CN2500	CN30	NC5330	NCM325	NCM535	NCM545	PC2505	PC2010	PC3700	PC6510	PC9530	PC9540	PC5300	PC5400		ST30A	H01	
RDCT	10T3M0-MA																●	E16 E17
RDKT	10T3M0-MF																	
	10T3M0-MM			●					●	●	●		●					

### Available adaptor

Designation	Available adaptor
FMRM 3021HRD-M10	MAT-M10
3025HRD-M12	MAT-M12
3032HRD-M16	MAT-M16
3042HRD-M16	

Designation : FMRM3021HRD-M10  
Modular head threading measure size (M10)

II

Adaptor spec.: MAT-M10-030-S20S  
Adaptor threading measure (M10)

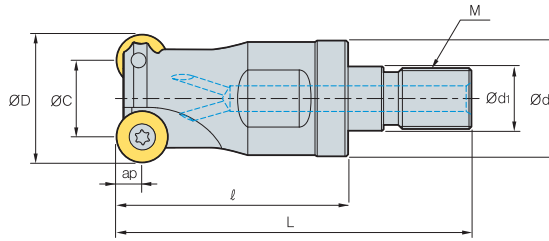
### Parts

Specification		
Ø21 Ø25-Ø42	FTGA03507 FTGA03508	TW15S

Available inserts E16, E17    Available adaptor E401-E402



# FMRM4000/5000



• AR: 5°  
• RR: -8°~5°

(mm)

Designation		ØD	ØC	Ød	Ød <sub>1</sub>	ℓ	L	M	ap		
FMRM	4025HRD-M12	2	25	13	22.5	12.5	45	69	M12	6.0	0.12
	4032HRD-M16	2	32	20	29	17	50	77	M16	6.0	0.22
	4040HRD-M16	3	40	28	29	17	50	77	M16	6.0	0.23
	4042HRD-M16	4	42	28	29	17	50	77	M16	6.0	0.25
FMRM	5040HRD-M16	2	40	24	29	17	50	77	M16	8.0	0.25

## Available inserts



Type	Designation	Cermet		Coated										Uncoated		page		
		CN2500	CN30	NC5330	NCM325	NCM635	NCM545	PC2505	PC2010	PC3700	PC6510	PC9530	PC9540	PC5300	PC5400		ST30A	H01
4000 type	RDCT 1204M0-MA																	
	RDKT 1204M0-MF																	
	RDKT 1204M0-MM																	
5000 type	RDHW 1605M0-E																	
	RDKT 1605M0-MF																	
	RDKT 1605M0-ML																	
	RDKT 1605M0-MM																	

## Available adaptor

Designation	Available adaptor
FMRM 4025HRD-M12	MAT-M12
4032HRD-M16	MAT-M16
4040HRD-M16	
4042HRD-M16	
5040HRD-M16	MAT-M16

Designation : FMRM4025HRD-M12  
Modular head threading measure size (M12)

||

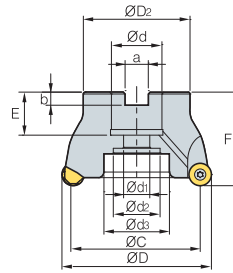
Adaptor spec.: MAT-M12-030-S25S  
Adaptor threading measure (M12)

## Parts

Specification		
Ø25~Ø42 (4000 type)	FTKA0410	TW15S
Ø40 (5000 type)	FTGA0513-P	TW20-100

Available inserts E16, E17    Available adaptor E401~E402

## FMRCM3000 new



• AR: 5°  
• RR: -4°~ 0°

(mm)

Designation		ØD	ØC	ØD <sub>2</sub>	Ød	Ød <sub>1</sub>	Ød <sub>2</sub>	d <sub>3</sub>	a	b	E	F	ap		
FMRCM	3040HRP-5	5	40	30	38	16	9	14	-	8.4	5.6	19	40	5	0.22
	3050HRP-6	6	50	40	45	22	11	18	-	10.4	6.3	20	40	5	0.35
	3052HRP-6	6	52	42	45	22	11	18	-	10.4	6.3	20	40	5	0.37
	3063HRP-6	6	63	53	50	22	11	18	-	10.4	6.3	20	40	5	0.55
	3063HRP-7	7	63	53	50	22	11	18	-	10.4	6.3	20	40	5	0.56
	3066HRP-7	7	66	56	50	22	11	18	-	10.4	6.3	20	40	5	0.60

### Available inserts

		RPCT-MA	RPET-ML	RPMT-MF	RPMT-MM	RPMW												
		Cermet		Coated						Uncoated								
Designation		CN2500	CN30	NC5330	NCM325	NCM535	NCM545	PC2505	PC2510	PC3700	PC6510	PC9530	PC9540	PC5300	PC5400	ST30A	H01	page
RPCT	10T3M0-MA																	E17 E18
RPET	10T3M0E-ML													●	●		●	
RPMT	10T3M0E-MF													●	●			
	10T3M0S-MM							●	●	●				●	●			
RPMW	10T3M0E1							●	●					●	●			

### Available arbors

Designation	Ød	Available arbors
FMRCM 3040HRP-5	16	BT□□-FMC16-□□
3050HRP-6	22	BT□□-FMC22-□□
3052HRP-6		
3063HRP-6		
3063HRP-7		
3066HRP-7		

### Parts

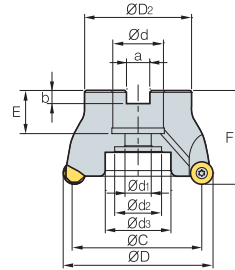
Specification		
Ø40~Ø66	FTGA03508	TW15S

Available inserts E17, E18 Available arbors and bolt E426-E428





# FMRC(M)4000 new



• AR: 5°  
• RR: -2°~0°

(mm)

Designation	ØD	ØC	ØD <sub>2</sub>	Ød	Ød <sub>1</sub>	Ød <sub>2</sub>	Ød <sub>3</sub>	a	b	E	F	ap	kg		
<b>FMRCM</b>	<b>4050HRP-4</b>	4	50	38	45	22	11	18	-	10.4	6.3	20	40	6	0.26
	<b>4050HRP-5</b>	5	50	38	45	22	11	18	-	10.4	6.3	20	40	6	0.28
	<b>4052HRP-5</b>	5	52	40	45	22	11	18	-	10.4	6.3	20	40	6	0.30
	<b>4063HRP-5</b>	5	63	51	50	22	11	18	-	10.4	6.3	20	40	6	0.44
	<b>4063HRP-6</b>	6	63	51	50	22	11	18	-	10.4	6.3	20	40	6	0.48
	<b>4066HRP-6</b>	6	66	54	50	22	11	18	-	10.4	6.3	20	40	6	0.50
<b>FMRC (FMRCM)</b>	<b>4080HRP-6</b>	6	80	68	57	25.4 (27)	14	25	35	9.5 (12.4)	6 (7)	24 (23)	50	6	0.92
	<b>4080HRP-7</b>	7	80	68	57	25.4 (27)	14	25	35	9.5 (12.4)	6 (7)	24 (23)	50	6	0.90
	<b>4100HRP-7</b>	7	100	88	67	31.75 (32)	18	26	42	12.7 (14.4)	8 (8)	32 (25)	63 (53)	6	1.46

( ) Metric size

## Available inserts

RPCT-MA    RPET-ML    RPMT-MF    RPMT-MM    RPMW



Designation	Cermet		Coated										Uncoated		page		
	CN2500	CN30	NC5330	NCM325	NCM535	NCM545	PC2505	PC2510	PC3700	PC6510	PC9530	PC9540	PC5300	PC5400		ST30A	H01
RPCT 1204M0-MA																	
RPET 1204M0E-ML																	
RPMT 1204M0E-MF																	
RPMT 1204M0S-MM																	
RPMW 1204M0S1																	
RPMW 1204M0S2																	

## Available arbors

Designation	Ød	Available arbors
<b>FMRCM</b>	4050HRP-4	BT□□-FMC22-□□
	4050HRP-5	
	4052HRP-5	
	4063HRP-5	
	4063HRP-6	
	4066HRP-6	
<b>FMRC (FMRCM)</b>	4080HRP-6	BT□□-FMA25.4-□□
		BT□□-FMC27-□□
	4080HRP-7	BT□□-FMA25.4-□□
		BT□□-FMC27-□□
	4100HRP-7	BT□□-FMA31.75-□□
	BT□□-FMC32-□□	

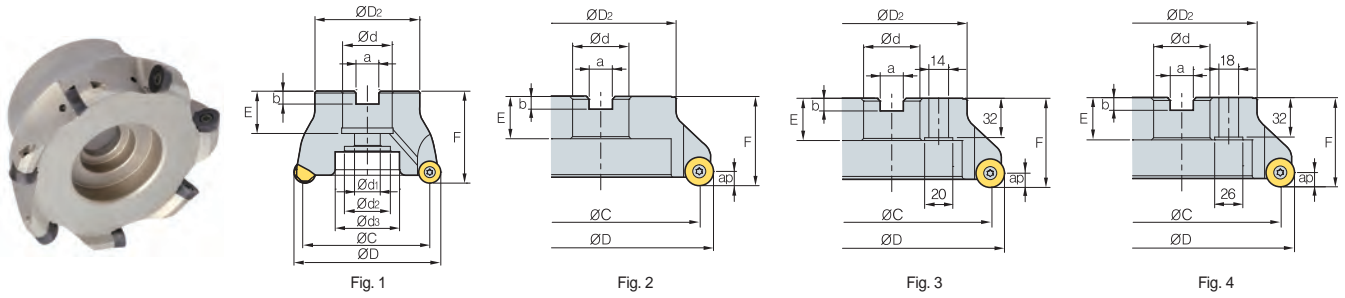
## Parts

Specification		
Ø50~Ø100	FTKA0410	TW15S

Available inserts E17, E18

Available arbors and bolt E426~E428

## FMRC(M)5000 new



Designation	ØD	ØC	ØD2	Ød	Ød1	Ød2	Ød3	a	b	E	F	ap		Fig.		
FMRCM	5063HRP-4	4	63	47	50	22	11	18	-	10.4	6.3	20	40	8	0.43	1
	5063HRP-5	5	63	47	50	22	11	18	-	10.4	6.3	20	40	8	0.44	1
	5066HRP-5	5	66	50	50	22	11	18	-	10.4	6.3	20	40	8	0.48	1
FMRC (FMRCM)	5080HRP-5	5	80	64	57	25.4 (27)	14	25	35	9.5 (12.4)	6 (7)	24 (23)	50	8	0.77	1
	5080HRP-6	6	80	64	57	25.4 (27)	14	25	35	9.5 (12.4)	6 (7)	24 (23)	50	8	0.82	1
	5100HRP-6	6	100	84	67	31.75 (32)	18	26	42	12.7 (14.4)	8 (8)	32 (25)	63 (55)	8	1.42	1
	5125HRP-7	7	125	109	87	38.1 (40)	22	32	52	15.9 (16.4)	10 (9)	35 (29)	68 (63)	8	2.78	1
	5125HRP-8	8	125	109	87	38.1 (40)	22	32	52	15.9 (16.4)	10 (9)	35 (29)	68 (63)	8	2.79	1
5160RP-8	8	160	144	107	50.8 (40)	-	-	100	19 (16.4)	11 (9)	38 (32)	63	8	4.01	2(3)	

( ) Metric size

### Available inserts

Designation	RPCT-MA		RPET-ML			RPMT-MF			RPMT-MM			RPMW		page		
	CN2500	CN30	NC6330	NCM325	NCM635	NCM645	PC2505	PC2510	PC3700	PC6510	PC9530	PC9540	PC5300		PC5400	ST30A
RPCT 1606M0-MA																
RPET 1606M0E-ML																
RPMT 1606M0E-MF																
1606M0S-MM																
RPMW 1606M0S1																

### Available arbors

Designation	Ød	Available arbors
FMRCM 5063HRP-4	22	BT□□-FMC22-□□
5063HRP-5		
5066HRP-5		
FMRC (FMRCM) 5080HRP-5	25.4	BT□□-FMA25.4-□□
	27	BT□□-FMC27-□□
5080HRP-6	25.4	BT□□-FMA25.4-□□
	27	BT□□-FMC27-□□
5100HRP-6	31.75	BT□□-FMA31.75-□□
	32	BT□□-FMC32-□□
5125HRP-7	38.1	BT□□-FMA38.1-□□
	40	BT□□-FMC40-□□
5125HRP-8	38.1	BT□□-FMA38.1-□□
	40	BT□□-FMC40-□□
5160RP-8	50.8	BT□□-FMA50.8-□□
	40	BT□□-FMC40-□□

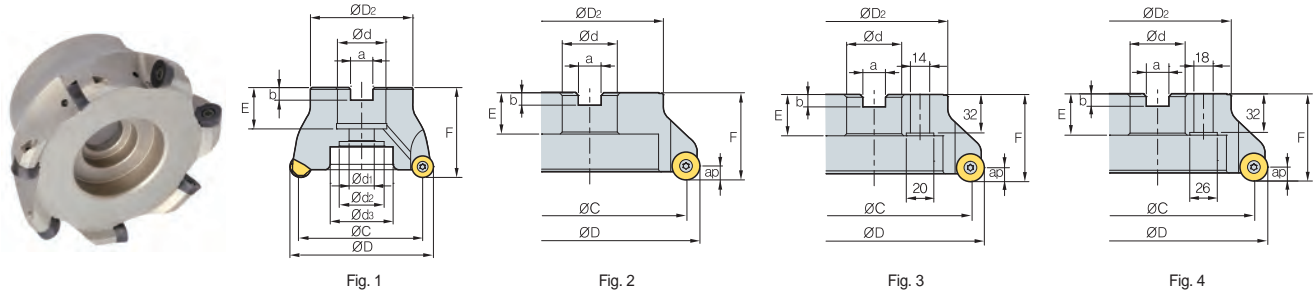
### Parts

Specification		
Ø63~Ø160	FTGA0512-P	TW20-100

Available inserts E17, E18 Available arbors and bolt E426-E428



# FMRC(M)6000 new



• AR: 5°  
• RR: 0°

(mm)

Designation	ØD	ØC	ØD <sub>2</sub>	Ød	Ød <sub>1</sub>	Ød <sub>2</sub>	Ød <sub>3</sub>	a	b	E	F	ap	kg	Fig.	
<b>FMRCM</b> 6063HRP-4	4	63	43	50	22	11	18	-	10.4	6.3	20	40	10	0.37	1
<b>FMRC</b> 6080HRP-5	5	80	60	57	25.4 (27)	14	25	35	9.5 (12.4)	6 (7)	24 (23)	50	10	0.87	1
<b>(FMRCM)</b> 6100HRP-5	5	100	80	67	31.75 (32)	18	26	42	12.7 (14.4)	8 (8)	32 (25)	63 (55)	10	1.31	1
6100HRP-6	6	100	80	67	31.75 (32)	18	26	42	12.7 (14.4)	8 (8)	32 (25)	63 (55)	10	1.40	1
6125HRP-5	5	125	105	87	38.1 (40)	22	32	52	15.9 (16.4)	10 (9)	35 (29)	68 (63)	10	2.77	1
6125HRP-7	7	125	105	87	38.1 (40)	22	32	52	15.9 (16.4)	10 (9)	35 (29)	68 (63)	10	2.89	1
6160RP-6	6	160	140	107	50.8 (40)	-	-	100	19 (16.4)	11 (9)	38 (32)	63	10	3.58	2 (3)
6160RP-8	8	160	140	107	50.8 (40)	-	-	100	19 (16.4)	11 (9)	38 (32)	63	10	3.53	2 (3)
6200RP-8	8	200	180	130	47.625 (60)	-	-	132	25.4 (25.7)	14 (14)	38	63	10	5.15	4
6250RP-9	9	250	230	180	47.625 (60)	-	-	180	25.4 (25.7)	14 (14)	38	63	10	9.72	4

( ) Metric size

## Available inserts



Designation	Cermet		Coated										Uncoated		page		
	CN2500	CN30	NC5330	NCM325	NCM635	NCM645	PC2505	PC2510	PC3700	PC6510	PC9530	PC9540	PC5300	PC5400		ST30A	H01
RPCT 2007M0-MA																	
RPET 2007M0E-ML													●	●			E17
RPMT 2007M0E-MF													●	●			E18
2007M0S-MM							●	●	●				●	●			
RPMW 2007M0S1							●	●					●	●			

## Available arbors

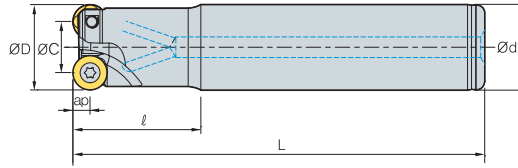
Designation	Ød	NC arbors	Designation	Ød	NC arbors
<b>FMRCM</b> 6063HRP-4	22	BT□□-FMC22-□□	<b>FMRC</b> 6125HRP-7	38.1	BT□□-FMA38.1-□□
<b>FMRC</b> 6080HRP-5	25.4	BT□□-FMA25.4-□□		40	BT□□-FMC40-□□
<b>(FMRCM)</b> 6100HRP-5	27	BT□□-FMC27-□□	<b>6160RP-6</b>	50.8	BT□□-FMA50.8-□□
6100HRP-5	31.75	BT□□-FMA31.75-□□		40	BT□□-FMC40-□□
6100HRP-6	32	BT□□-FMC32-□□	<b>6160RP-8</b>	50.8	BT□□-FMA50.8-□□
6100HRP-6	31.75	BT□□-FMA31.75-□□		40	BT□□-FMC40-□□
6125HRP-5	38.1	BT□□-FMA38.1-□□	<b>6200RP-8</b>	47.625	BT□□-FMA47.625-□□
6125HRP-5	40	BT□□-FMC40-□□		60	BT□□-FMC60-□□
			<b>6250RP-9</b>	47.625	BT□□-FMA47.625-□□
				60	BT□□-FMC60-□□

## Parts

Specification	Screw	Wrench
Ø63~Ø250	FTKA0615-P	TW25-100

Available inserts E17, E18 Available arbors and bolt E426-E428

## FMRS2500 new



• AR: -4°  
• RR: -4°~1°

(mm)

Designation			ØD	ØC	Ød	l	L	ap	
FMRS	2517HRP-2S16	2	17	9	16	35	90	4	0.11
	2517HRP-2M16	2	17	9	16	35	150	4	0.20
	2517HRP-2L16	2	17	9	16	35	200	4	0.27
	2518HRP-2M16	2	18	10	16	35	150	4	0.20
	2518HRP-2L16	2	18	10	16	35	200	4	0.28
	2520HRP-3S20	3	20	12	20	35	130	4	0.27
	2520HRP-3M20	3	20	12	20	100	180	4	0.36
	2520HRP-3L20	3	20	12	20	130	250	4	0.50
	2521HRP-3S20	3	21	13	20	35	130	4	0.28
	2521HRP-3M20	3	21	13	20	35	180	4	0.40
	2521HRP-3L20	3	21	13	20	35	250	4	0.55
	2525HRP-4S25	4	25	17	25	35	150	4	0.48
	2525HRP-4M25	4	25	17	25	60	180	4	0.60
	2525HRP-4L25	4	25	17	25	130	250	4	0.81
	2526HRP-4S25	4	26	18	25	35	150	4	0.48
2526HRP-4L25	4	26	18	25	130	250	4	0.85	

### Available inserts

		RPET-ML		RPMT-MF		RPMT-MM		RPMW										
Designation		Cermet		Coated								Uncoated		page				
		CN2500	CN30	NC5330	NCM325	NCM535	NCM545	PC2505	PC2510	PC3700	PC6510	PC9530	PC9540		PC5300	PC5400	ST30A	H01
RPET	0803M0E-ML													●	●			E17 E18
RPMT	0803M0E-MF													●	●			
	0803M0S-MM							●	●					●	●			
RPMW	0803M0E1							●	●					●	●			

### Parts

Specification		
Ø17 Ø18~Ø26	FTNA0305 FTNA0306	TW09S

Available inserts E17, E18



# FMRS3000 new

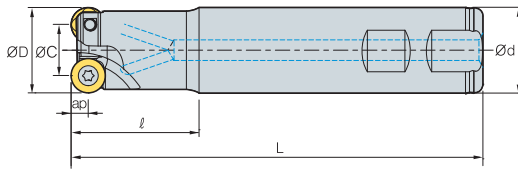


Fig. 1

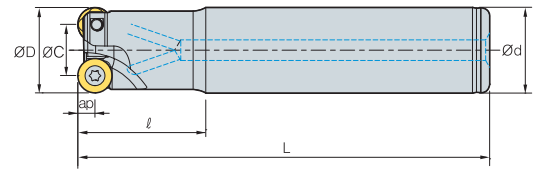


Fig. 2



• AR: -4°  
• RR: -1°

(mm)

Designation		ØD	ØC	Ød	ℓ	L	ap		Fig.
<b>FMRS</b> 3025HRP-2M20	2	25	15	20	40	170	5	0.40	2
3025HRP-2S25	2	25	15	25	40	120	5	0.39	1
3025HRP-2M25	2	25	15	25	60	160	5	0.52	2
3025HRP-2L25	2	25	15	25	130	250	5	0.80	2
3026HRP-2L25	2	26	16	25	30	200	5	0.69	2
3032HRP-3S32	3	32	22	32	40	125	5	0.68	1
3032HRP-3L32	3	32	22	32	60	200	5	1.08	2
3032HRP-4S32	4	32	22	32	40	125	5	0.66	1
3032HRP-4L25	4	32	22	25	60	200	5	0.74	2
3033HRP-4S32	4	33	23	32	40	125	5	0.67	1
3033HRP-4M32	4	33	23	32	60	180	5	1.00	2
3033HRP-4L32	4	33	23	32	180	300	5	1.64	2

## Available inserts



Designation	Cermet		Coated										Uncoated		page		
	CN2500	CN30	NC5330	NCM325	NCM535	NCM545	PC2505	PC2510	PC3700	PC6510	PC9530	PC9540	PC5300	PC5400		ST30A	H01
RPCT 10T3M0-MA																	
RPET 10T3M0E-ML													●	●		●	
RPMT 10T3M0E-MF													●	●			
10T3M0S-MM							●	●	●				●	●			
RPMW 10T3M0E1							●	●					●	●			

## Parts

Specification		
Ø25~Ø26 Ø32~Ø33	FTGA03507 FTGA03508	TW15S

Available inserts E17, E18

## FMRS4000 new

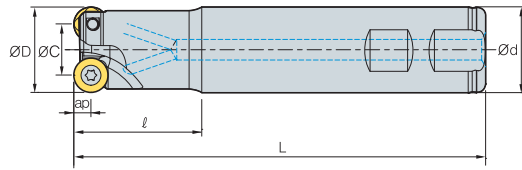


Fig. 1

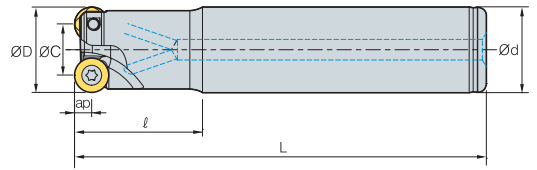


Fig. 2



• AR: -4°  
• RR: -2°~ 0°

(mm)

Designation		ØD	ØC	Ød	l	L	ap		Fig.
<b>FMRS</b> 4025HRP-2S25	2	25	13	25	60	160	6	0.46	1
4026HRP-2L25	2	26	14	25	60	200	6	0.48	2
4032HRP-2L25	2	32	20	25	40	190	6	0.68	2
4032HRP-2S32	2	32	20	32	50	125	6	0.64	1
4032HRP-2L32	2	32	20	32	50	250	6	1.40	2
4032HRP-3S32	3	32	20	32	50	125	6	0.64	1
4032HRP-3M32	3	32	20	32	60	160	6	0.85	2
4033HRP-3M32	3	33	21	32	60	200	6	1.01	2
4033HRP-3L32	3	33	21	32	60	300	6	1.67	2
4040HRP-3S32	3	40	28	32	35	105	6	0.60	1
4040HRP-3M32	3	40	28	32	50	160	6	0.96	2
4040HRP-4S32	4	40	28	32	35	105	6	0.60	1
4040HRP-4M32	4	40	28	32	35	150	6	0.87	2
4040HRP-4L32	4	40	28	32	35	250	6	1.46	2
4050HRP-4M32	4	50	38	32	50	150	6	1.10	2
4050HRP-4M40	4	50	38	40	50	150	6	1.44	2
4050HRP-4M42	4	50	38	42	50	150	6	1.55	2

### Available inserts

RPCT-MA    RPET-ML    RPMT-MF    RPMT-MM    RPMW



Designation	Cermet		Coated										Uncoated		page		
	CN2500	CN30	NC5330	NCM325	NCM635	NCM545	PC2505	PC2510	PC3700	PC6510	PC9530	PC9540	PC5300	PC5400		ST30A	H01
RPCT 1204M0-MA																	
RPET 1204M0E-ML													●	●			
RPMT 1204M0E-MF												●	●	●			E17
1204M0S-MM							●	●	●			●	●	●			E18
RPMW 1204M0S1							●	●	●				●	●			
1204M0S2													●	●			

### Parts

Specification		
Ø25-Ø26	FTKA0408	TW15S
Ø32-Ø50	FTKA0410	TW15S



# FMRS5000/6000 **new**

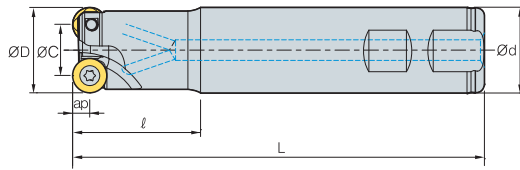


Fig. 1

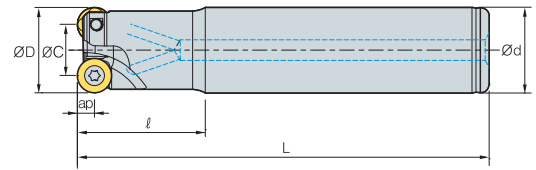


Fig. 2



• AR: -4°  
• RR: 0°

(mm)

Designation		ØD	ØC	Ød	l	L	ap		Fig.	
FMRS	5040HRP-2M32	2	40	24	32	50	160	8	0.92	2
	5040HRP-2L32	2	40	24	32	50	250	8	1.45	2
	5050HRP-3M40	3	50	34	40	50	160	8	1.48	2
	5050HRP-3L40	3	50	34	40	50	300	8	2.86	2
FMRS	6050HRP-3S32	3	50	30	32	50	160	10	1.06	1
	6050HRP-3M32	3	50	30	32	50	200	10	1.30	2
	6050HRP-3S40	3	50	30	40	50	125	10	1.45	1
	6050HRP-3M40	3	50	30	40	50	200	10	1.85	2

## Available inserts

RPCT-MA    RPET-ML    RPMT-MF    RPMT-MM    RPMW



Type	Designation	Cermet		Coated										Uncoated		page			
		CN2500	CN30	NC5330	NCM325	NCM635	NCM545	PC2505	PC2510	PC3700	PC6510	PC9530	PC9540	PC5300	PC5400		ST30A	H01	
5000 type	RPCT 1606M0-MA																●	E17	
	RPET 1606M0E-ML													●	●				E18
	RPMT 1606M0E-MF													●	●				
	RPMT 1606M0S-MM							●	●	●				●	●				
RPMW 1606M0S1							●	●					●	●					
6000 type	RPCT 2007M0-MA																●	E18	
	RPET 2007M0E-ML													●	●				
	RPMT 2007M0E-MF													●	●				
	RPMT 2007M0S-MM							●	●	●				●	●				
RPMW 2007M0S1							●	●					●	●					

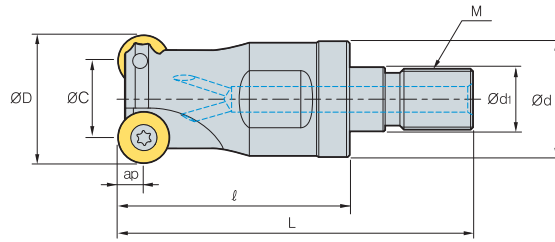
## Parts

Specification		
Ø40~Ø50 (5000 type)	FTGA0511-P	TW20-100
Ø50 (6000 type)	FTKA0615-P	TW25-100

Available inserts E17, E18



## FMRM2500 new



• AR: -4°  
• RR: -4°~ 0°

(mm)

Designation		ØD	ØC	Ød	Ød <sub>1</sub>	l	L	M	ap	
FMRM 2517HRP-M08	2	17	9	14.5	8.5	25	42	M08	4	0.03
2521HRP-M10	3	21	13	18	10.5	30	51	M10	4	0.06
2526HRP-M12	4	26	18	23	12.5	35	59	M12	4	0.11
2533HRP-M16	4	33	25	29	17	40	67	M16	4	0.22
2540HRP-M16	5	40	32	29	17	40	67	M16	4	0.26

### Available inserts

		RPCT-MA	RPET-ML	RPMT-MF	RPMT-MM	RPMW											
Designation		Cermet		Coated						Uncoated		page					
		CN2500	CN30	NC5330	NCM325	NCM535	NCM545	PC2505	PC2510	PC3700	PC6510		PC9530	PC9540	PC5300	PC5400	ST30A
RPET	0803M0E-ML												●	●			E17 E18
RPMT	0803M0E-MF												●	●			
	0803M0S-MM												●	●			
RPMW	0803M0E1												●	●			

### Available adaptor

Designation	Available adaptor
FMRM 2517HRP-M08	MAT-M08
2521HRP-M10	MAT-M10
2526HRP-M12	MAT-M12
2533HRP-M16	MAT-M16
2540HRP-M16	

Designation : FMRM2517HRP-M08  
Modular head threading measure size (M08)

II

Adaptor spec.: MAT-M08-020-S16S  
Adaptor threading measure (M08)

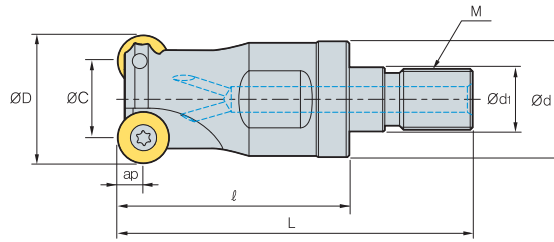
### Parts

Specification		
Ø17 Ø21~Ø40	FTNA0305 FTNA0306	TW09S

Available inserts E17, E18 Available adaptor E401-E402



# FMRM3000 new



• AR: -4°  
• RR: -1°~0°

(mm)

Designation		ØD	ØC	Ød	Ød1	ℓ	L	M	ap	
FMRM 3026HRP-M12	2	26	16	23	12.5	35	59	M12	5	0.10
3033HRP-M16	3	33	23	29	17	40	67	M16	5	0.20
3035HRP-M16	3	35	25	29	17	40	67	M16	5	0.22
3040HRP-M16	3	40	30	29	17	40	67	M16	5	0.25
3042HRP-M16	3	42	32	29	17	40	67	M16	5	0.27

## Available inserts



Designation	Cermet		Coated										Uncoated		page		
	CN2500	CN30	NC5330	NCM325	NCM535	NCM545	PC2505	PC2510	PC3700	PC6510	PC9530	PC9540	PC5300	PC5400		ST30A	H01
RPCT 10T3M0-MA																	
RPET 10T3M0E-ML													●	●			
RPMT 10T3M0E-MF													●	●			E17
10T3M0S-MM							●	●	●				●	●			E18
RPMW 10T3M0E1							●	●					●	●			

## Available adaptor

Designation	Available adaptor
FMRM 3026HRP-M12	MAT-M12
3033HRP-M16	
3035HRP-M16	
3040HRP-M16	MAT-M16
3042HRP-M16	

Designation : FMRM3026HRP-M12  
Modular head threading measure size (M12)

II

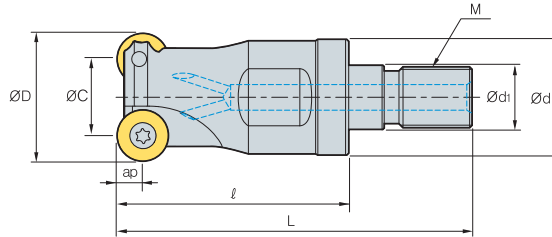
Adaptor spec.: MAT-M12-030-S25S  
Adaptor threading measure (M12)

## Parts

Specification		
Ø26	FTGA03507	TW15S
Ø33~Ø42	FTGA03508	

Available inserts E17, E18    Available adaptor E401-E402

## FMRM4000 new



• AR: -4°  
• RR: 0°

(mm)

Designation		ØD	ØC	Ød	Ød1	l	L	M	ap	
FMRM 4026HRP-M12	2	26	14	23	12.5	35	59	M12	6	0.10
4033HRP-M16	3	33	21	29	17	40	67	M16	6	0.21
4035HRP-M16	3	35	23	29	17	40	67	M16	6	0.21
4040HRP-M16	4	40	28	29	17	40	67	M16	6	0.24
4042HRP-M16	4	42	30	29	17	40	67	M16	6	0.25

### Available inserts



Designation	Cermet		Coated								Uncoated		page				
	CN2500	CN30	NC5330	NCM325	NCM535	NCM545	PC2505	PC2510	PC3700	PC6510	PC9530	PC9540		PC5300	PC5400	ST30A	H01
RPCT 1204M0-MA																●	E17 E18
RPET 1204M0E-ML													●	●			
RPMT 1204M0E-MF												●	●	●			
1204M0S-MM							●	●	●			●	●	●			
RPMW 1204M0S1							●	●	●				●	●			
1204M0S2													●	●			

### Available adaptor

Designation	Available adaptor
FMRM 4026HRP-M12	MAT-M12
4033HRP-M16	MAT-M16
4035HRP-M16	
4040HRP-M16	
4042HRP-M16	

Designation : FMRM4026HRP-M12  
Modular head threading measure size (M12)

II

Adaptor spec.: MAT-M12-030-S25S  
Adaptor threading measure (M12)

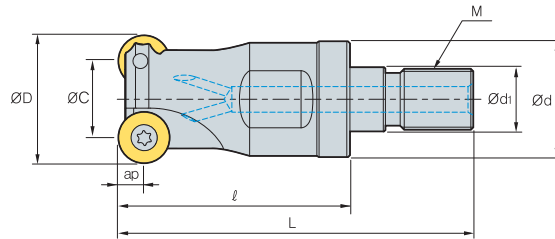
### Parts

Specification		
Ø26 Ø33-Ø42	FTKA0408 FTKA0410	TW15S

Available inserts E17, E18 Available adaptor E401-E402



# FMRM5000 new



• AR: -4°  
• RR: 0°

(mm)

Designation		ØD	ØC	Ød	Ød <sub>1</sub>	ℓ	L	M	ap	
FMRM 5040HRP-M16	2	40	24	29	17	40	67	M16	8	0.21
5042HRP-M16	2	42	26	29	17	40	67	M16	8	0.23

## Available inserts

		RPCT-MA	RPET-ML	RPMT-MF	RPMT-MM	RPMW												
Designation		Cermet		Coated										Uncoated		page		
		CN2500	CN30	NC5330	NCM325	NCM535	NCM545	PC2505	PC2510	PC3700	PC6510	PC9530	PC9540	PC5300	PC5400		ST30A	H01
RPCT	1606M0-MA																●	E17 E18
RPET	1606M0E-ML																	
RPMT	1606M0E-MF																	
	1606M0S-MM																	
RPMW	1606M0S1																	

## Available adaptor

Designation	Available adaptor
FMRM 5040HRP-M16 5042HRP-M16	MAT-M16

Designation : FMRM5040HRP-M16  
Modular head threading measure size (M16)

II

Adaptor spec.: MAT-M16-035-S32S  
Adaptor threading measure (M16)

## Parts

Specification			
Ø40~Ø42	FTGA0511-P	-	TW20-100

Available inserts E17, E18    Available adaptor E401-E402

# E Technical Information for Triple Mill

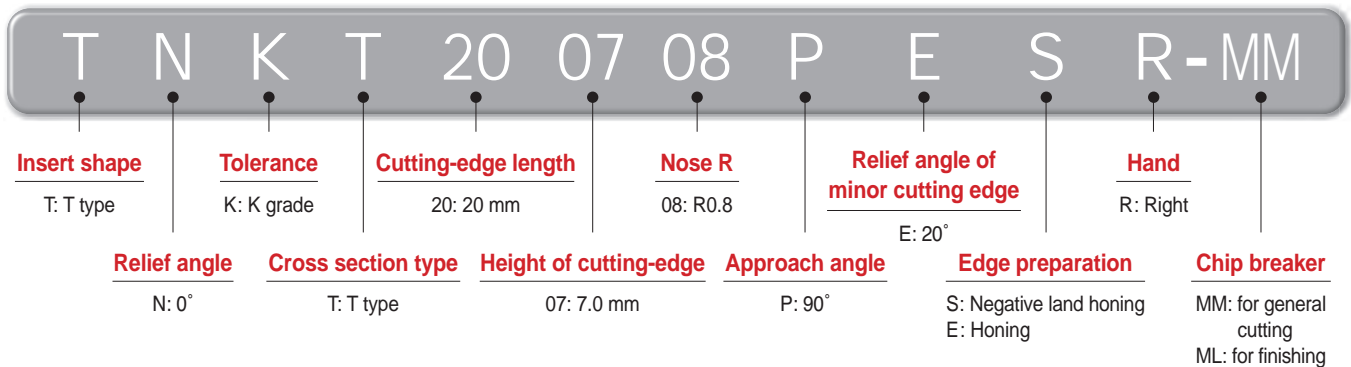
High depth of cut milling tool with 3 corners for perpendicularity

## Triple Mill

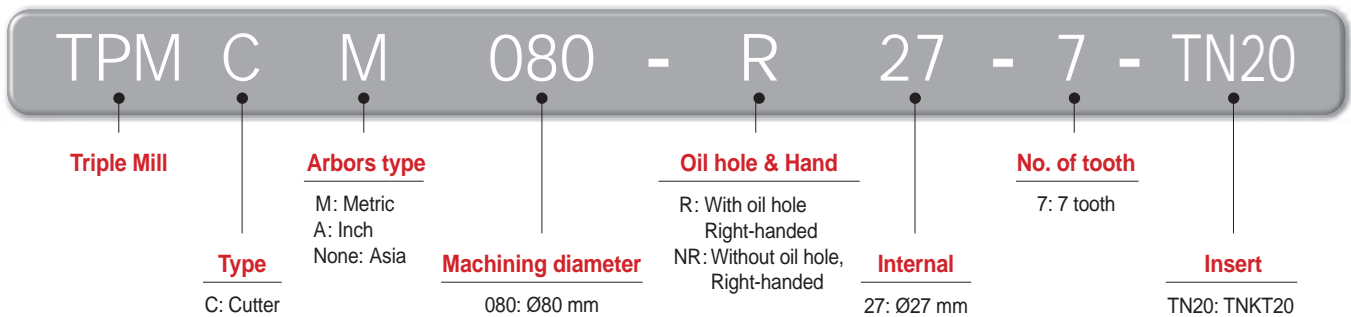
- Economical milling tool with 3 corners with positive cutting edge for high depth of cut machining
- Stable machinability in high feed machining due to enhanced chip evacuation and thicker insert
- High precision machining from less cutting load due to high helix and sharp cutting edge

### Code system

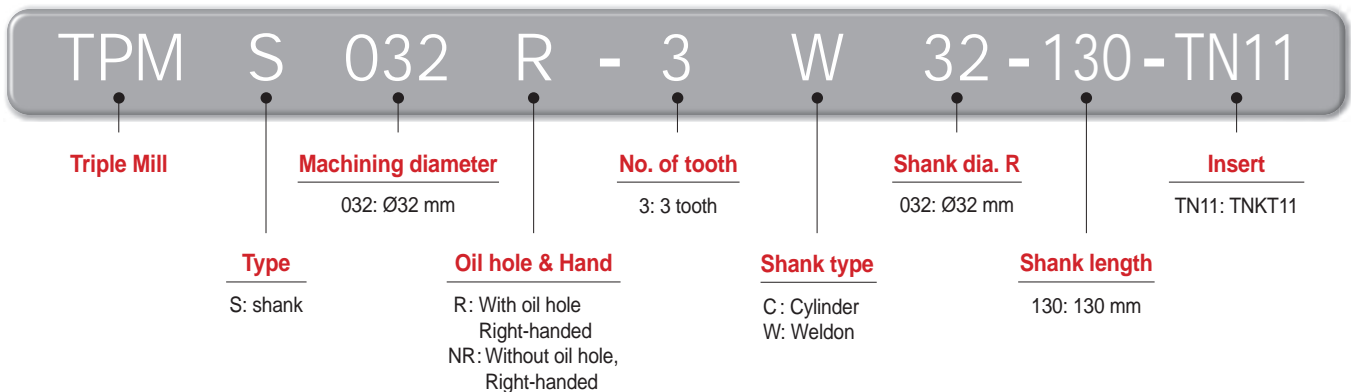
#### • Insert



#### • Cutter

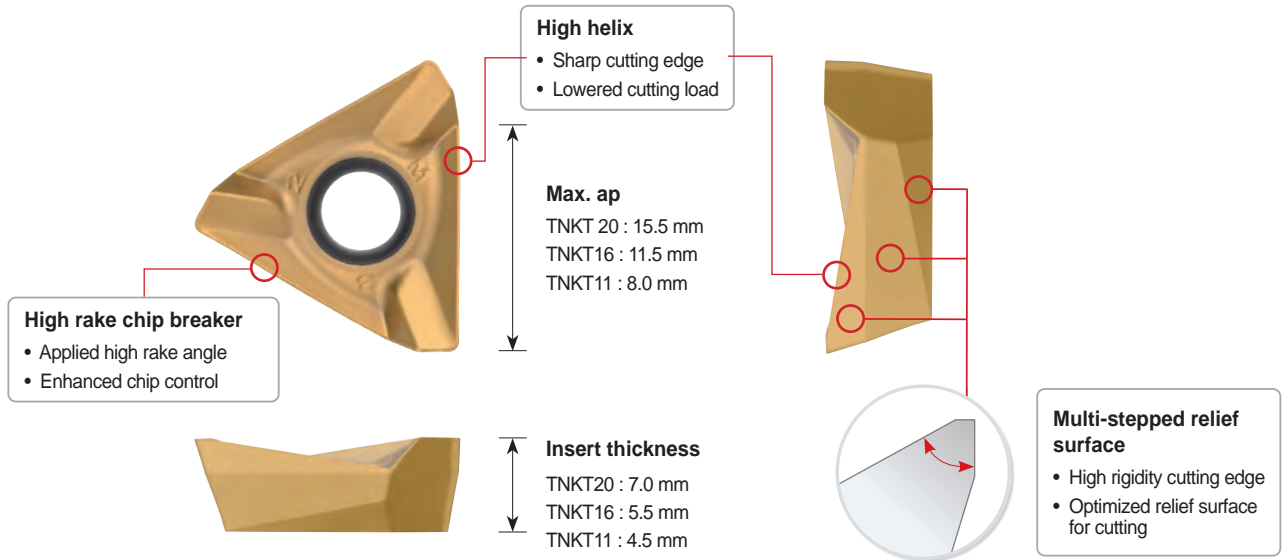


#### • Shank

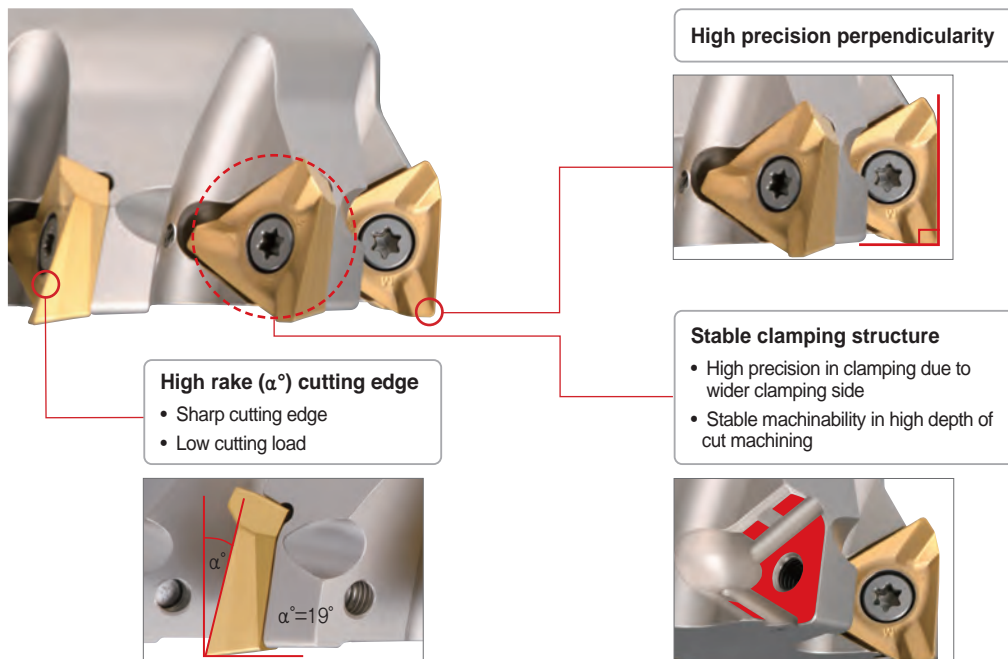


## ➤ Insert features

- Economical insert with 3 corners due to high depth of cut cutting edge
- Lowered cutting load and enhanced chip evacuation by sharp chip breaker and high helix cutting edge
- Stable machinability even in high cutting conditions from high rigidity design



## ➤ Cutter features



# E Technical Information for Triple Mill

## Recommended grade and chip breaker

(● : 1<sup>st</sup> Recommendation)

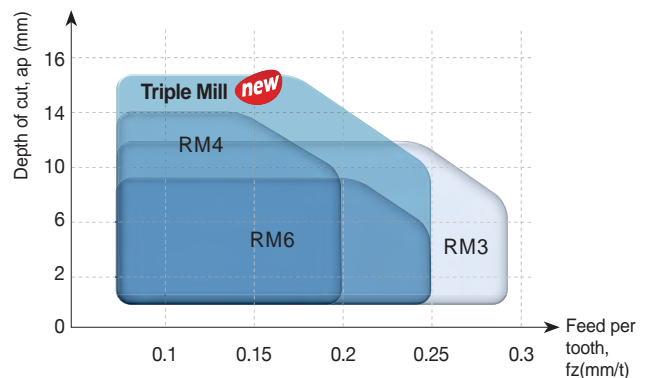
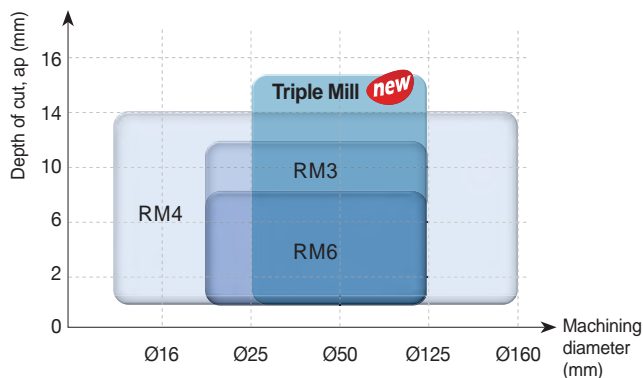
C/B	Cutting edge	P				M		K		S	
		Low carbon steel/ Mild steel		High carbon steel/ Alloy steel		Stainless steel		Cast iron		HRSA	
		C/B	Grade	C/B	Grade	C/B	Grade	C/B	Grade	C/B	Grade
ML		-	● PC3700 ○ PC5300 ○ PC5400	-	● PC3700 ○ PC5300 ○ PC5400	●	● PC5300 ○ PC5400 ○ PC9540	-	● PC6510 ○ PC5300 ○ PC5400	-	○ PC5300 ○ PC5400
MM		●	● PC3700 ○ PC5300 ○ PC5400	●	● PC3700 ○ PC5300 ○ PC5400	-	● PC5300 ○ PC5400 ○ PC9540	●	● PC6510 ○ PC5300 ○ PC5400	-	○ PC5300 ○ PC5400

## Recommended cutting condition

Workpiece	Grade	Cutting speed vc(m/min)	TNKT11		TNKT16		TNKT20	
			fz (mm/t)	Max. ap (mm)	fz (mm/t)	Max. ap (mm)	fz (mm/t)	Max. ap (mm)
P Steel	PC3700	160-270	0.25-0.1	8.0	0.25-0.1	11.5	0.25-0.1	15.5
	PC5300	140-240	0.25-0.1	8.0	0.25-0.1	11.5	0.25-0.1	15.5
M Stainless steel	PC5300	90-150	0.2 - 0.05	8.0	0.2-0.05	11.5	0.2-0.05	15.5
	PC5400	70-120	0.2 - 0.05	8.0	0.2-0.05	11.5	0.2-0.05	15.5
	PC9540	70-120	0.2-0.05	8.0	0.2-0.05	11.5	0.2-0.05	15.5
K Cast iron	PC6510	150-250	0.3-0.1	8.0	0.3-0.10	11.5	0.3-0.1	15.5
S HRSA	PC5300	20-50	0.15-0.05	8.0	0.15-0.05	11.5	0.15-0.05	15.5

※ The above data refer to general cutting conditions and can be adjustable to the speed of 350 m/min and the feed per tooth of 0.3 mm/t depending on user environment.

## Application range

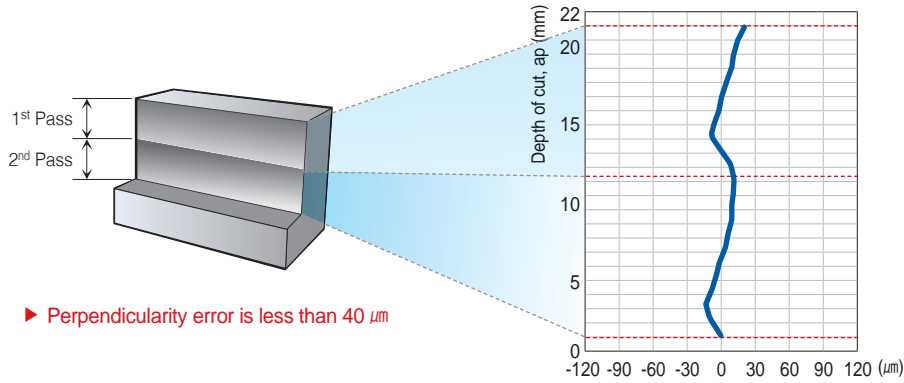




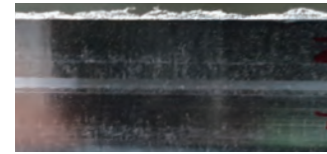
## Performance evaluation

### Perpendicularity

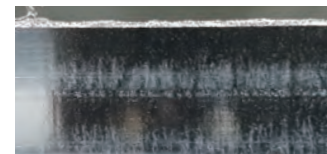
- Workpiece** Alloy steel (SCM440, HB200), 300(L) x 200(W) x 100(H)
- Cutting conditions**  $vc$  (m/min) = 200,  $fz$  (mm/t) = 0.2,  $ap$  (mm) = 12 mm x 2Passes (Total 24 mm),  $ae$  (mm) = 5, dry
- Tools** **Insert** TNKT200708PESR-MM (PC5300) **Holder** TPMCM080R-27-7-TN20



[Graph of measured perpendicularities]



Triple Mill

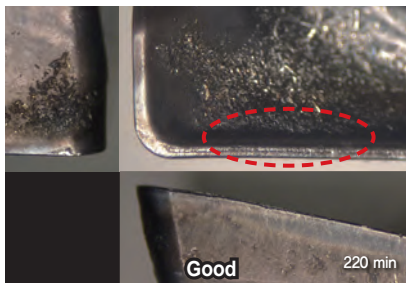


Competitor

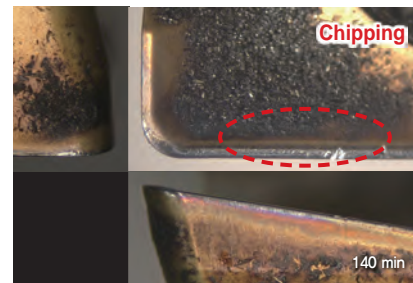
[Comparison picture of flank surface finish]

### Wear resistance

- Workpiece** Alloy steel (SCM440, HB200), 300(L) x 200(W) x 100(H)
- Cutting conditions**  $vc$  (m/min) = 200,  $fz$  (mm/t) = 0.2,  $ap$  (mm) = 7,  $ae$  (mm) = 10, dry
- Tools** **Insert** TNKT160608PESR-MM (PC5300) **Holder** TPMCM063R-22-6-TN16



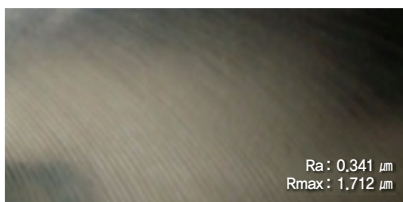
Triple Mill



Competitor

### Surface finish

- Workpiece** Alloy steel (SCM440, HB200), 300(L) x 200(W) x 100(H)
- Cutting conditions**  $vc$  (m/min) = 200,  $fz$  (mm/t) = 0.2,  $ap$  (mm) = 7,  $ae$  (mm) = 10, dry
- Tools** **Insert** TNKT160608PESR-MM (PC5300) **Holder** TPMCM063R-22-6-TN16



Triple Mill



Competitor

## TPMCM-TN16 new

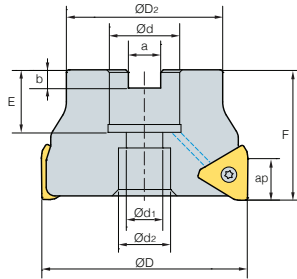


Fig. 1

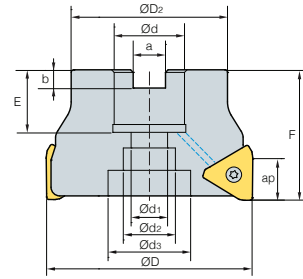


Fig. 2



AA  
90°

• AR: 10°  
• RR: -11°~-13.5°

(mm)

Designation		ØD	ØD2	Ød	Ød1	Ød2	Ød3	a	b	E	F	ap		Fig.	Available insert	
TPMCM	050R-22-4-TN16	4	50	42	22	11	18	-	10.4	6.3	21	40	11.5	0.26	1	TNKT16
	050R-22-5-TN16	5	50	42	22	11	18	-	10.4	6.3	21	40	11.5	0.26	1	
	063R-22-4-TN16	4	63	50	22	11	18	-	10.4	6.3	21	40	11.5	0.50	1	
	063R-22-6-TN16	6	63	50	22	11	18	-	10.4	6.3	21	40	11.5	0.48	1	
	080R-27-6-TN16	6	80	60	27	14	20	-	12.4	7	24	50	11.5	0.99	1	
	080R-27-8-TN16	8	80	60	27	14	20	-	12.4	7	24	50	11.5	0.99	1	
	100R-32-8-TN16	8	100	70	32	18	28	45	14.4	8	28	63	11.5	1.85	2	
	100R-32-10-TN16	10	100	70	32	18	28	45	14.4	8	28	63	11.5	1.83	2	
	125R-40-12-TN16	12	125	90	40	22	32	54	16.4	9	30	63	11.5	3.12	2	
125R-40-14-TN16	14	125	90	40	22	32	54	16.4	9	30	63	11.5	3.10	2		

### Available inserts

TNKT-ML

TNKT-MM



Designation	Cermet		Coated										page			
	CN2500	CN30	NC5330	NCM325	NCM535	NCM545	PC2505	PC2010	PC2015	PC3700	PC6510	PC9530		PC9540	PC5300	PC5400
TNKT 160608PEER-ML										●				●		E28
160608PESR-MM										●	●			●		

### Available arbors

Designation	Ød	NC arbors
TPMCM 050R-22-□-TN□□	22	BT□□-FMC22-□□
063R-22-□-TN□□		
080R-27-□-TN□□	27	BT□□-FMC27-□□
100R-32-□-TN□□	32	BT□□-FMC32-□□
125R-40-□-TN□□	40	BT□□-FMC40-□□

### Parts

Specification		
Ø50~Ø125	Screw FTKA0410	Wrench TW15S

Available inserts E28

Available arbors and bolt E426-E428



# TPMCM-TN20 new

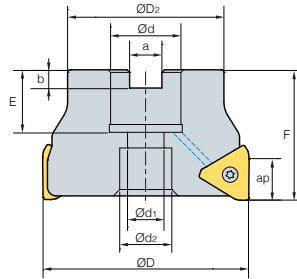


Fig. 1

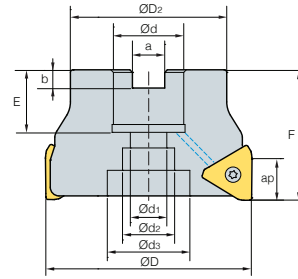
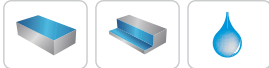


Fig. 2



AA **90°**  
 • AR: 10°  
 • RR: -10.5°~14°

Designation		⊙	ØD	ØD <sub>2</sub>	Ød	Ød <sub>1</sub>	Ød <sub>2</sub>	Ød <sub>3</sub>	a	b	E	F	ap	⊙ <sub>kg</sub>	Fig.	Available insert
TPMCM	063R-22-5-TN20	5	63	50	22	11	18	-	10.4	6.3	21	50	15.5	0.57	1	TNKT20
	063R-22-6-TN20	6	63	50	22	11	18	-	10.4	6.3	21	50	15.5	0.58	1	
	080R-27-5-TN20	5	80	60	27	14	20	-	12.4	7	24	50	15.5	0.92	1	
	080R-27-7-TN20	7	80	60	27	14	20	-	12.4	7	24	50	15.5	0.86	1	
	100R-32-7-TN20	7	100	70	32	18	28	45	14.4	8	28	63	15.5	1.79	2	
	100R-32-9-TN20	9	100	70	32	18	28	45	14.4	8	28	63	15.5	1.68	2	
	125R-40-8-TN20	8	125	90	40	22	32	52	16.4	9	30	63	15.5	3.08	2	
	125R-40-11-TN20	11	125	90	40	22	32	52	16.4	9	30	63	15.5	2.99	2	

## Available inserts

TNKT-ML      TNKT-MM



Designation	Cermet		Coated										page			
	CN2500	CN30	NC5330	NCM325	NCM635	NCM545	PC2505	PC2010	PC2015	PC3700	PC6510	PC9530		PC9540	PC5300	PC5400
TNKT 200708PEER-ML										●			●	●		E28
200708PESR-MM									●	●				●		

## Available arbors

Designation	Ød	NC arbors
TPMCM 063R-22-□-TN□□	22	BT□□-FMC22-□□
080R-27-□-TN□□	27	BT□□-FMC27-□□
100R-32-□-TN□□	32	BT□□-FMC32-□□
125R-40-□-TN□□	40	BT□□-FMC40-□□

## Parts

Specification	Screw	Wrench
Ø63-Ø125	FTGA0511-P	TW20-100

Available inserts **E28**      Available arbors and bolt **E426-E428**

## TPMS-TN11 new

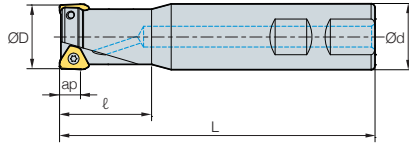


Fig. 1

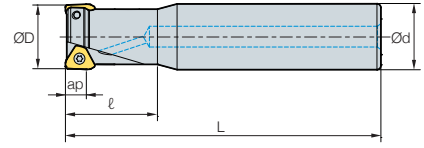


Fig. 2



AA  
90°  
• AR: 8°~10°  
• RR: -14°~-15°

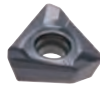
(mm)

Designation		ØD	Ød	ℓ	L	ap		Fig.	Available insert
TPMS	025R-2W25-120-TN11	2	25	25	35	120	0.37	1	TNKT11
	025R-2C25-200-TN11	2	25	25	35	200	0.65	2	
	025R-3W25-120-TN11	3	25	25	35	120	0.36	1	
	025R-3C25-200-TN11	3	25	25	35	200	0.64	2	
	032R-2W32-130-TN11	2	32	32	40	130	0.71	1	
	032R-2C32-200-TN11	2	32	32	40	200	1.12	2	
	032R-3W32-130-TN11	3	32	32	40	130	0.70	1	
	032R-3C32-200-TN11	3	32	32	40	200	1.14	2	
	032R-4W32-130-TN11	4	32	32	40	130	0.70	1	
	032R-4C32-200-TN11	4	32	32	40	200	1.11	2	
	040R-4W40-130-TN11	4	40	40	40	130	1.12	1	
	040R-5W40-130-TN11	5	40	40	40	130	1.11	1	

### Available inserts

TNKT-ML

TNKT-MM



Designation	Cermet		Coated											page		
	CN2500	CN30	NC5330	NCM325	NCM535	NCM545	PC2505	PC2010	PC2015	PC3700	PC6510	PC9530	PC9540		PC5300	PC5400
TNKT	110508PEER-ML									●			●	●		E28
	110508PESR-MM									●	●			●		

### Parts

Specification		
Ø25~Ø40	FTKA0307	TW09S

Available inserts E28 Available arbors and bolt E426-E428



# TPMS-TN16 new

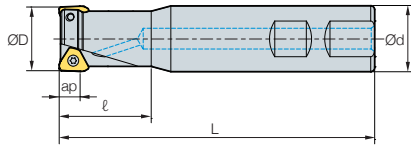


Fig. 1

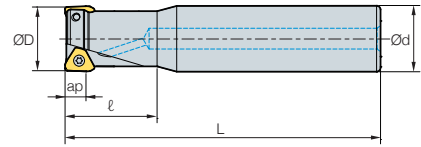


Fig. 2



AA  
**90°**

• AR: 10°  
• RR: -13.5°

(mm)

Designation		ØD	Ød	ℓ	L	ap		Fig.	Available insert
<b>TPMS</b> 032R-2W32-130-TN16	2	32	32	40	130	11.5	0.68	1	TNKT16
032R-2C32-200-TN16	2	32	32	40	200	11.5	1.10	2	
040R-3W40-130-TN16	3	40	40	40	130	11.5	1.09	1	
040R-3C40-200-TN16	3	40	40	40	200	11.5	1.75	2	
040R-4W40-130-TN16	4	40	40	40	130	11.5	1.08	1	

## Available inserts

TNKT-ML

TNKT-MM



Designation	Cermet		Coated										page			
	CN2500	CN30	NC5330	NCM325	NCM535	NCM545	PC2505	PC2010	PC2015	PC3700	PC6510	PC9530		PC9540	PC5300	PC5400
TNKT 160608PEER-ML										●				●		E28
160608PESR-MM									●	●				●		

## Parts

Specification		
Ø32~Ø40	FTKA0410	TW15S

Available inserts **E28**

Available arbors and bolt **E426-E428**

# E Technical Information for HFMD

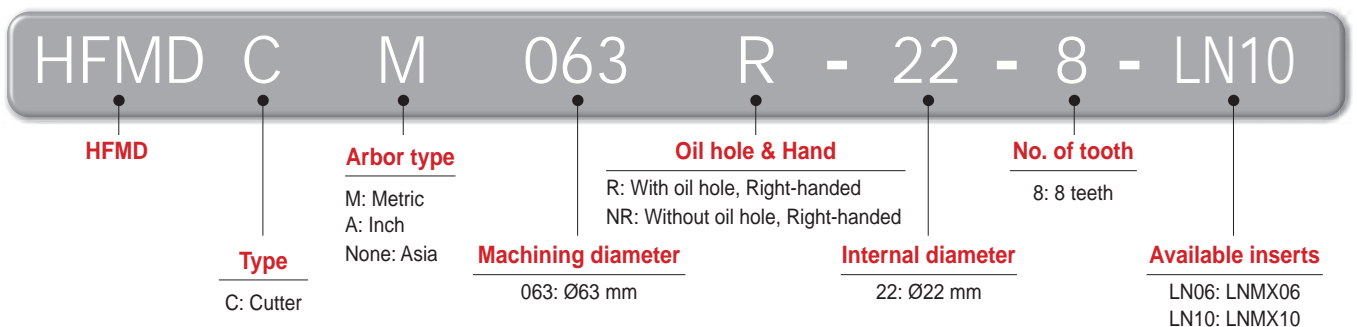
## High Feed Milling Tool with 4 Corners for Small Diameter

# HFMD new

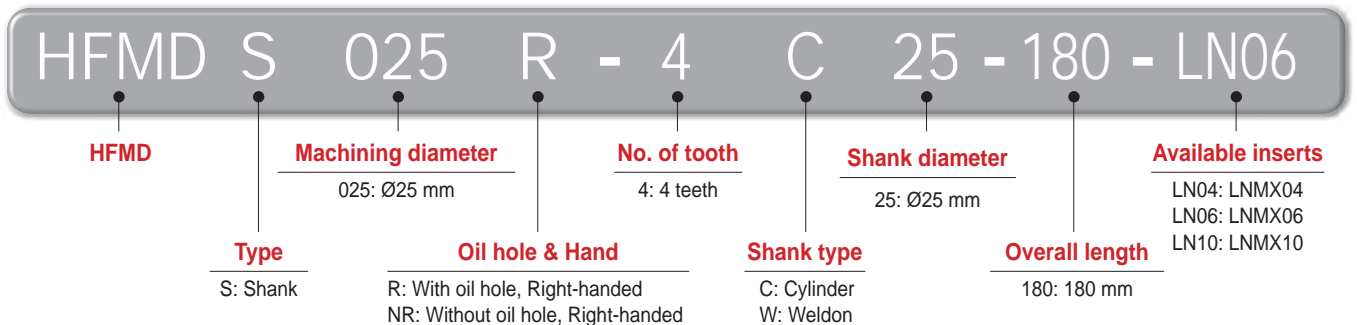
- Economical 4-corner double sided insert
- Increased productivity due to thinner and elongated shape of the insert which makes fine pitch available
- Insert designed for low cutting resistance with high rake angle and helix angle which reduces cutting load
- Inhibiting chipping and breakage due to concave clamping system and stronger screw

### Code system

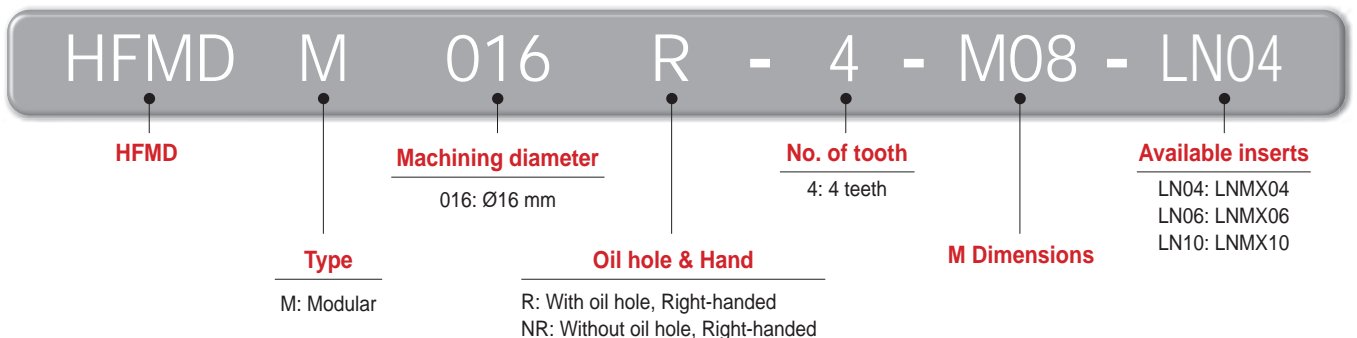
#### • Cutter



#### • Shank



#### • Modular



## Features

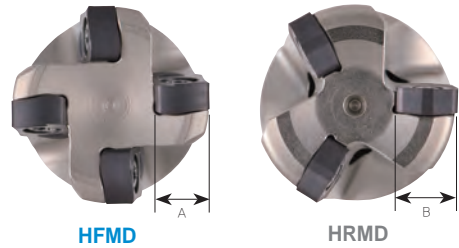
**Economical 4-corner insert**

- Can use 4 corners with 1 insert by utilizing front/back face; High feed due to finer pitch



**Highly efficient insert due to fine pitch**

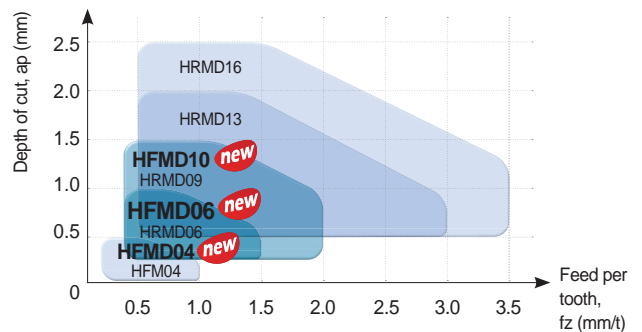
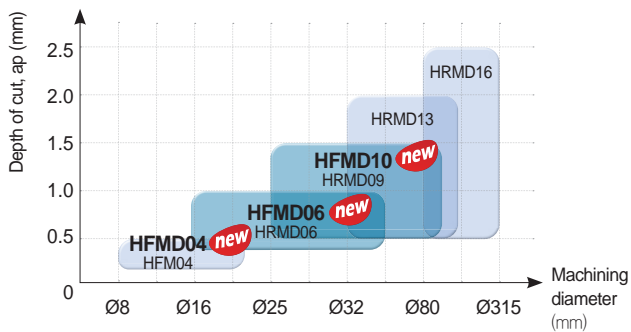
- Able to use fine pitch at the same machining diameter with typical types of milling cutters due to smaller inscribed circle ( $A < B$ )



## Features of chip breaker

Insert	Cutting-edge	Uses	Features
ML		For heat resistant alloy and titanium	Ensures superior machining quality by applying a low cutting resistance chip breaker and high-strength cutting edge design suitable for machining heat resistant alloy
MF		For light cutting	Suitable for light cutting with a low cutting resistance chip breaker design
MM		For multi-purpose	Available for most cutting area with its exclusive design suitable for general high feed machining

## Application area





## Recommended cutting condition

※ Recommended chip breaker: ● 1st ○ 2nd



ISO	Workpiece			Grade	vc (m/min)	LNMx04		LNMx06		LNMx10		ae	Available chip breaker			
	Workpiece materials	KS	HB (H <sub>R</sub> C)			fz (mm/t)	ap (mm)	fz (mm/t)	ap (mm)	fz (mm/t)	ap (mm)		ML	MF	MM	
P	Mild steel	SM20C	120 - 180	PC5400 (PC5300)	100-240	1.2-0.3	0.2-0.5	1.2-0.3	0.2-1.0	1.4-0.3	0.3-1.5	0.7D-0.1D	○	●		
	Carbon steel	SM45C	200	PC5400 (PC5300)	100-240	1.2-0.3	0.2-0.5	1.2-0.3	0.2-1.0	1.4-0.3	0.3-1.5	0.7D-0.1D	○	●		
	Alloy steel	SCM440	270 (28)	PC3700 (PC5300)	100-220	1.2-0.3	0.2-0.5	1.2-0.3	0.2-1.0	1.4-0.3	0.3-1.5	0.7D-0.1D		●	○	
	Pre-hardened steel	KP4M		300 (32)	PC3700 (PC5300)	100-200	1.0-0.3	0.2-0.4	1.0-0.3	0.2-0.8	1.2-0.3	0.3-1.2	0.7D-0.1D		○	●
		NIMAX		370 (40)	PC3700 (PC5300)	100-200	1.0-0.3	0.2-0.4	1.0-0.3	0.2-0.8	1.2-0.3	0.3-1.2	0.7D-0.1D		○	●
		CENA1		370 (40)	PC3700 (PC5300)	100-200	1.0-0.3	0.2-0.4	1.0-0.3	0.2-0.8	1.2-0.3	0.3-1.2	0.7D-0.1D		○	●
		NAK80		400 (43)	PC5300 (PC3700)	100-200	1.0-0.3	0.2-0.4	1.0-0.3	0.2-0.8	1.2-0.3	0.3-1.2	0.7D-0.1D		○	●
STAVAX		510 (52)	PC3700 (PC2510)	80-160	0.7-0.3	0.2-0.4	0.7-0.3	0.2-0.8	0.9-0.3	0.3-1.2	0.7D-0.1D		○	●		
Alloy tool steel	STD11 STD61		- (40-50)	PC2510 (PC5300)	80-130	0.7-0.3	0.2-0.3	0.65-0.3	0.2-0.6	0.8-0.3	0.3-0.9	0.7D-0.1D		○	●	
M	Stainless steel	STS316	Under 270	PC9540 (PC5400)	90-180	0.8-0.3	0.2-0.5	0.8-0.3	0.2-0.8	1.0-0.3	0.3-1.2	0.7D-0.1D	●	○		
K	Grey cast iron, Ductile cast iron	GCD450	Tensile Strength Over 450Mpa	PC5300 (PC5400)	130-220	0.9-0.3	0.2-0.5	0.9-0.3	0.2-1.0	1.2-0.3	0.3-1.5	0.7D-0.1D		●	○	
S	HRSA	Fe series	Incoroy901	- (25-35)	PC9540 (PC5300)	30-100	0.7-0.3	0.2-0.3	0.6-0.3	0.2-0.6	0.7-0.3	0.3-0.9	0.7D-0.4D	●	○	
		Ni or Co series	Inconel718	- (35-45)	PC9540 (PC5300)	30-45	0.7-0.3	0.2-0.3	0.7-0.3	0.2-0.6	0.8-0.3	0.3-0.9	0.7D-0.4D	○	●	
	Titanium	Ti-6AL-4V	- (40-45)	PC9540 (PC5300)	30-50	0.8-0.3	0.2-0.3	1.0-0.3	0.2-0.6	1.2-0.3	0.3-0.9	0.7D-0.1D	●	○		

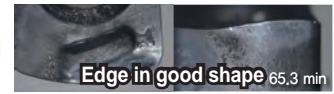
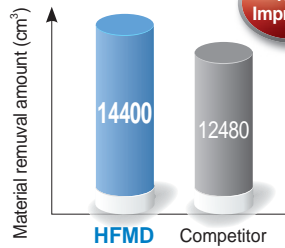


**Performance evaluation**

**Carbon steel (SM45C, HB200)**

- **Workpiece** Steel rectangular tube (300 × 200 × 100)
- **Cutting conditions** vc (m/min) = 200, fz (mm/t) = 1.2, ap (mm) = 0.8, ae (mm) = 20, dry
- **Tools** Insert LNMX060310R-MF (PC5300)  
Holder HFMSD032R-5C32-200-LN06

■ **Test result**



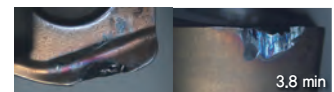
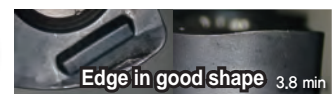
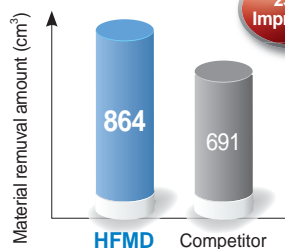
Competitor

- Material removal rate Q (cm³/min): 191.0
- Cutting time (min): 75.4

**Pre-hardened steel (KP4M, HRC30)**

- **Workpiece** Steel rectangular tube (300 × 200 × 100)
- **Cutting conditions** vc (m/min) = 160, fz (mm/t) = 1.2, ap (mm) = 1.2, ae (mm) = 20, dry
- **Tools** Insert LNMX100412R-MF (PC5300)  
Holder HFMSD032R-4C32-200-LN10

■ **Test result**



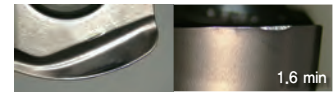
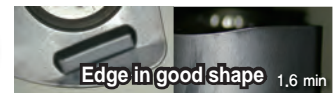
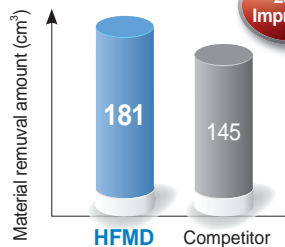
Competitor

- Material removal rate Q (cm³/min): 183.3
- Cutting time (min): 4.7

**Alloy tool steel (STD11, HRC40-45)**

- **Workpiece** Steel rectangular tube (300 × 200 × 100)
- **Cutting conditions** vc (m/min) = 160, fz (mm/t) = 1.2, ap (mm) = 0.9, ae (mm) = 20, dry
- **Tools** Insert LNMX100412R-MF (PC2510)  
Holder HFMSD032R-4C32-200-LN10

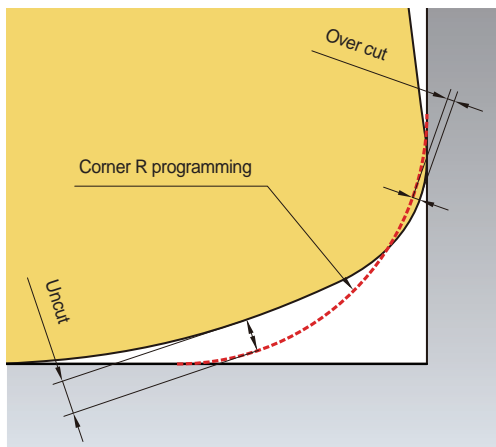
■ **Test result**



Competitor

- Material removal rate Q (cm³/min): 91.7
- Cutting time (min): 2.0

**Corner R programming**



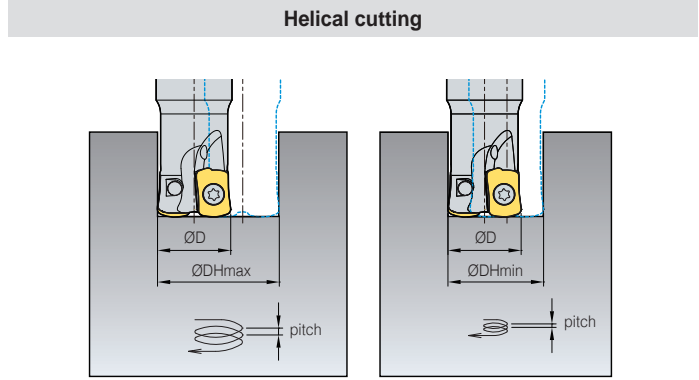
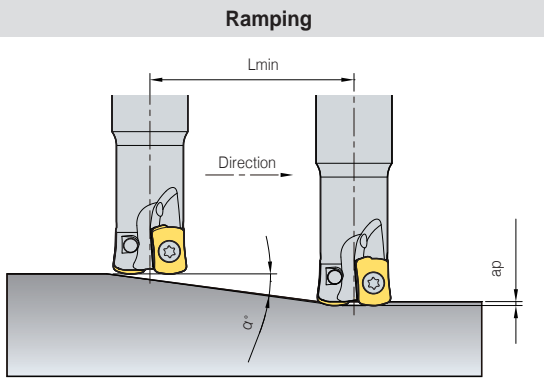
----- Corner R programming

Insert	Corner R programming	Cutting conditions		Over Cut	Uncut
		Nose R	Max. ap		
LNMX040205R-ML LNMX040205R-MM	R0.8	0.5	0.5	0	0.27
	R0.9(Standard)			0	0.24
	R1.0			0.01	0.22
LNMX060310R-ML LNMX060310R-MF LNMX060310R-MM	R1.5	1.0	1.0	0	0.41
	R1.6(Standard)			0	0.41
	R2.0			0.06	0.38
LNMX100412R-ML LNMX100412R-MF LNMX100412R-MM	R2.0	1.2	1.5	0	0.84
	R2.5(Standard)			0	0.60
	R3.0			0.06	0.51

- During usage of CNC program, over cut & uncut would be occurred on the corner processing site if entering the correct program corner R value for each insert
- To prevent overcut, you will need to complete a CNC program considering the above overcut



## Ramping and helical cutting



(mm)

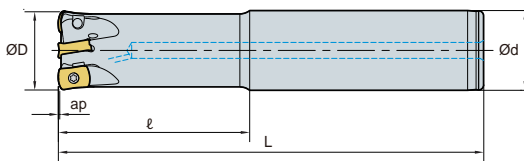
Designation	Tool dia. ØD	Depth of cut ap	Ramping		Blind hole helical cutting				Thru hole helical cutting	
			Max ramping angle $\alpha$ (°)	Lmin	Max diameter ØDHmax	Max pitch	Min diameter ØDHmin	Max pitch	Min diameter ØDHmin	Max pitch
LNMX04	8	0.4	0.5	45	12	0.2	10	0.2	9	0.2
	10		0.6	37	16	0.3	14	0.3	13	0.3
	11		0.8	37	18	0.3	15	0.3	15	0.3
	12		1.0	28	20	0.4	17	0.4	17	0.4
	13		1.0	27	22	0.4	19	0.4	19	0.4
	16	0.5	1.0	28	28	0.5	25	0.5	25	0.5
	17		1.0	29	30	0.5	27	0.5	27	0.5
	20		0.9	33	36	0.5	33	0.5	33	0.5
	21		0.7	44	38	0.5	35	0.5	35	0.5
	25		0.7	43	46	0.5	43	0.5	43	0.5
	32		0.5	57	60	0.5	57	0.5	57	0.5
33	0.4	74	62	0.5	59	0.5	59	0.5		
35	0.4	79	66	0.5	63	0.5	63	0.5		
LNMX06	16	0.7	3.0	13	30	0.7	22	0.7	21	0.7
	17		2.3	25	32	1.0	24	1.0	22	1.0
	18	1.0	2.1	27	34	1.0	26	1.0	24	1.0
	19		1.9	30	36	1.0	28	1.0	26	1.0
	20		1.5	37	38	1.0	30	1.0	28	1.0
	21		1.5	39	40	1.0	32	1.0	30	1.0
	25		1.4	40	48	1.0	40	1.0	38	1.0
	26		1.4	42	50	1.0	42	1.0	40	1.0
	30		1.1	51	58	1.0	50	1.0	48	1.0
	32		1.0	55	62	1.0	54	1.0	52	1.0
	33		1.0	57	64	1.0	56	1.0	54	1.0
	35		0.9	61	68	1.0	60	1.0	58	1.0
	40		0.8	71	78	1.0	70	1.0	68	1.0
	42		0.8	76	82	1.0	74	1.0	72	1.0
50	0.6	92	98	1.0	90	1.0	88	1.0		
52	0.6	96	102	1.0	94	1.0	92	1.0		
63	0.5	119	124	1.0	116	1.0	114	1.0		
66	0.5	126	130	1.0	122	1.0	120	1.0		
LNMX10	25	1.5	2.9	30	42	1.5	35	1.5	32	1.5
	26		2.7	32	44	1.5	37	1.5	34	1.5
	30		2.2	39	52	1.5	45	1.5	42	1.5
	32		2.0	43	56	1.5	49	1.5	46	1.5
	33		1.9	45	58	1.5	51	1.5	48	1.5
	35		1.8	49	62	1.5	55	1.5	52	1.5
	40		1.5	58	72	1.5	65	1.5	62	1.5
	42		1.4	62	76	1.5	69	1.5	66	1.5
	50		1.1	77	92	1.5	85	1.5	82	1.5
	52		1.1	81	96	1.5	89	1.5	86	1.5
	63		0.8	101	118	1.5	111	1.5	108	1.5
	66		0.8	107	124	1.5	117	1.5	114	1.5
80	0.6	133	152	1.5	145	1.5	142	1.5		
100	0.5	171	192	1.5	185	1.5	182	1.5		

- When ramping and helical milling, table feed, vf (mm/min) should be lower than 70% of the recommended cutting conditions.
- When helical milling, Max. pitch, DHmax should be lower than max. depth of cut, ap.
- When ramping, the depth of cut should be lower than max. depth of cut, ap.

- Lmin =  $ap / \tan(\alpha^\circ)$  (mm)
- Lmin: Min. length of ramping
- ap: Depth of cut
- $\alpha^\circ$ : Max. rake angle in ramping



# HFMD S-LN04 new



• AR: -8°~7°  
• RR: -19°~15°

(mm)

Designation		ØD	Ød	l	L	ap	
<b>HFMD S</b> 008NR-1C08-080-LN04	1	8	8	20	80	0.4	0.03
008NR-1C10-100-LN04	1	8	10	20	100	0.4	0.05
010NR-2C08-080-LN04	2	10	8	20	80	0.4	0.03
010NR-2C10-100-LN04	2	10	10	20	100	0.4	0.06
010NR-2C10-150-LN04	2	10	10	40	150	0.4	0.08
011NR-2C10-100-LN04	2	11	10	20	100	0.5	0.06
011NR-2C10-150-LN04	2	11	10	20	150	0.5	0.09
008R-1C08-080-LN04	1	8	8	20	80	0.5	0.02
008R-1C10-100-LN04	1	8	10	20	100	0.5	0.05
010R-2C08-080-LN04	2	10	8	20	80	0.4	0.03
010R-2C10-080-LN04	2	10	10	35	80	0.4	0.05
010R-2C10-100-LN04	2	10	10	20	100	0.4	0.05
010R-2C10-150-LN04	2	10	10	40	150	0.4	0.07
011R-2C10-100-LN04	2	11	10	20	100	0.5	0.05
011R-2C10-150-LN04	2	11	10	20	150	0.5	0.08
012R-3C12-100-LN04	3	12	12	50	100	0.5	0.07
012R-3C12-105-LN04	3	12	12	20	105	0.5	0.07
012R-3C12-150-LN04	3	12	12	40	150	0.5	0.11

## Available inserts

LNMX-ML LNMX-MM



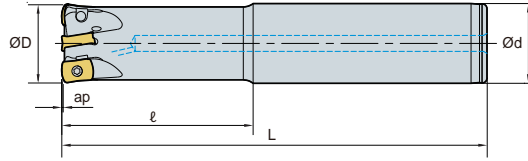
Designation	Cermet		Coated										Uncoated		page			
	CN2500	CN30	NC5330	NCM325	NCM335	NCM535	NCM545	PC2505	PC2510	PC3700	PC6510	PC9530	PC9540	PC5300		PC5400	ST30A	H01
LNMX 040205R-ML														●	●			E12
040205R-MM								●	●					●	●			

## Parts

Specification		
Ø8~Ø12	FTKA01844-A	TW06S-A

Available inserts E12

# HFMDs-LN04 new



• AR: -8°  
• RR: -14°~13°

(mm)

Designation		ØD	Ød	ℓ	L	ap	
<b>HFMDs</b> 013R-3C12-100-LN04	3	13	12	20	100	0.5	0.08
013R-3C12-120-LN04	3	13	12	20	120	0.5	0.09
013R-3C12-150-LN04	3	13	12	20	150	0.5	0.12
016R-4C16-100-LN04	4	16	16	50	100	0.5	0.13
016R-4C16-120-LN04	4	16	16	70	120	0.5	0.20
016R-4C16-150-LN04	4	16	16	80	150	0.5	0.20
016R-4C16-200-LN04	4	16	16	120	200	0.5	0.26
017R-4C16-100-LN04	4	17	16	20	100	0.5	0.14
017R-4C16-150-LN04	4	17	16	20	150	0.5	0.20
017R-4C16-200-LN04	4	17	16	20	200	0.5	0.29
020R-5C20-100-LN04	5	20	20	20	100	0.5	0.22
020R-5C20-150-LN04	5	20	20	40	150	0.5	0.30
020R-5C20-200-LN04	5	20	20	80	200	0.5	0.40
021R-5C20-100-LN04	5	21	20	20	100	0.5	0.22
021R-5C20-150-LN04	5	21	20	20	150	0.5	0.30
021R-5C20-200-LN04	5	21	20	20	200	0.5	0.46

## Available inserts

LNMX-ML LNMX-MM



Designation	Cermet		Coated										Uncoated		page		
	CN2500	CN30	NC5330	NCM325	NCM335	NCM535	NCM545	PC2505	PC2510	PC3700	PC6510	PC9530	PC9540	PC5300		PC5400	ST30A
LNMX 040205R-ML														●	●		
040205R-MM								●	●					●	●		

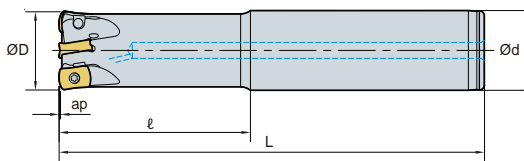
## Parts

Specification		
Ø13~Ø21	FTKA01844-A	TW06S-A

Available inserts E12



# HFMD S-LN06 new



(mm)

Designation		ØD	Ød	l	L	ap	
HFMD S 016R-2C16-100-LN06	2	16	16	30	100	0.7	0.13
016R-2C16-150-LN06	2	16	16	50	150	0.7	0.19
017R-2C16-100-LN06	2	17	16	30	100	1.0	0.13
017R-2C16-150-LN06	2	17	16	40	150	1.0	0.20
017R-2C16-200-LN06	2	17	16	40	200	1.0	0.27
018R-2C16-100-LN06	2	18	16	40	100	1.0	0.14
018R-2C16-160-LN06	2	18	16	40	160	1.0	0.18
018R-2C16-200-LN06	2	18	16	40	200	1.0	0.28
019R-2C16-100-LN06	2	19	16	40	100	1.0	0.15
019R-2C16-160-LN06	2	19	16	40	160	1.0	0.19
019R-2C16-200-LN06	2	19	16	40	200	1.0	0.29
020R-3C20-100-LN06	3	20	20	40	100	1.0	0.20
020R-3C20-130-LN06	3	20	20	50	130	1.0	0.26
020R-3C20-160-LN06	3	20	20	80	160	1.0	0.31
020R-3C20-200-LN06	3	20	20	120	200	1.0	0.40
021R-3C20-100-LN06	3	21	20	30	100	1.0	0.21
021R-3C20-130-LN06	3	21	20	40	130	1.0	0.27
021R-3C20-160-LN06	3	21	20	40	160	1.0	0.34
021R-3C20-200-LN06	3	21	20	40	200	1.0	0.42

## Available inserts

LNMX-ML LNMX-MF LNMX-MM



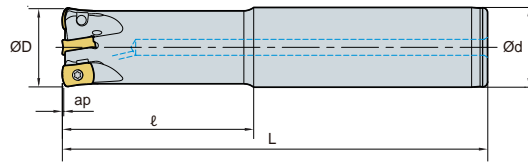
Designation	Cermet		Coated										Uncoated		page		
	CN2500	CN30	NC5330	NCM325	NCM335	NCM535	NCM545	PC2505	PC2510	PC3700	PC6510	PC9530	PC9540	PC5300		PC5400	ST30A
LNMX 060310R-ML									●	●				●	●		
060310R-MF								●	●					●	●		
060310R-MM								●	●					●	●		

## Parts

Specification		
Ø16~Ø21	FTNA0306	TW09S

Available inserts E12

# HFMD S-LN06 new



• AR: -9°  
• RR: -12°~10°

(mm)

Designation		ØD	Ød	ℓ	L	ap	
HFMD S 025R-4C25-100-LN06	4	25	25	40	100	1.0	0.33
025R-4C25-140-LN06	4	25	25	60	140	1.0	0.46
025R-4C25-180-LN06	4	25	25	100	180	1.0	0.58
025R-4C25-250-LN06	4	25	25	150	250	1.0	0.67
026R-4C25-100-LN06	4	26	25	30	100	1.0	0.34
026R-4C25-140-LN06	4	26	25	40	140	1.0	0.48
026R-4C25-180-LN06	4	26	25	40	180	1.0	0.63
026R-4C25-250-LN06	4	26	25	40	250	1.0	0.72
032R-5C32-150-LN06	5	32	32	70	150	1.0	0.82
032R-5C32-200-LN06	5	32	32	120	200	1.0	1.08
032R-5C32-250-LN06	5	32	32	150	250	1.0	1.20
033R-5C32-150-LN06	5	33	32	40	150	1.0	0.82
033R-5C32-200-LN06	5	33	32	40	200	1.0	1.08
033R-5C32-250-LN06	5	33	32	40	250	1.0	1.20
035R-5C32-150-LN06	5	35	32	40	150	1.0	0.87
035R-5C32-200-LN06	5	35	32	40	200	1.0	1.13
035R-5C32-250-LN06	5	35	32	40	250	1.0	1.25
040R-6C32-150-LN06	6	40	32	40	150	1.0	0.97
040R-6C32-200-LN06	6	40	32	40	200	1.0	1.28
040R-6C32-250-LN06	6	40	32	40	250	1.0	1.38

## Available inserts

LNX-ML LNX-MF LNX-MM



Designation	Cermet		Coated											Uncoated		page		
	CN2500	CN30	NC5330	NCM325	NCM335	NCM535	NCM545	PC2505	PC2510	PC3700	PC6510	PC9530	PC9540	PC5300	PC5400		ST30A	H01
LNX 060310R-ML															●	●		
060310R-MF								●	●						●	●		
060310R-MM								●	●						●	●		

## Parts

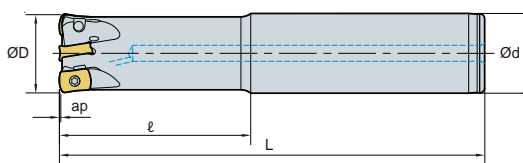
Specification		
Ø25-Ø40	FTNA0306	TW09S

Available inserts E12





# HFMDS-LN10 new



• AR: -9°  
• RR: -16°~-13°

(mm)

Designation		ØD	Ød	l	L	ap	
HFMDS 025R-2C25-150-LN10	2	25	25	70	150	1.5	0.46
025R-2C25-200-LN10	2	25	25	100	200	1.5	0.60
025R-3C25-150-LN10	3	25	25	70	150	1.5	0.45
025R-3C25-200-LN10	3	25	25	100	200	1.5	0.60
026R-3C25-150-LN10	3	26	25	40	150	1.5	0.49
026R-3C25-200-LN10	3	26	25	40	200	1.5	0.68
030R-3C32-150-LN10	3	30	32	70	150	1.5	0.71
030R-3C32-200-LN10	3	30	32	100	200	1.5	0.94
032R-4C32-150-LN10	4	32	32	70	150	1.5	0.75
032R-4C32-200-LN10	4	32	32	100	200	1.5	1.00
032R-4C32-250-LN10	4	32	32	150	250	1.5	1.20
033R-4C32-150-LN10	4	33	32	40	150	1.5	0.80
033R-4C32-200-LN10	4	33	32	40	200	1.5	1.00
033R-4C32-250-LN10	4	33	32	40	250	1.5	1.40
035R-4C32-150-LN10	4	35	32	40	150	1.5	0.85
035R-4C32-200-LN10	4	35	32	40	200	1.5	1.10
035R-4C32-250-LN10	4	35	32	40	250	1.5	1.44
040R-4C32-150-LN10	4	40	32	40	150	1.5	0.89
040R-4C32-200-LN10	4	40	32	40	200	1.5	1.20
040R-4C32-250-LN10	4	40	32	40	250	1.5	1.48
040R-5C32-150-LN10	5	40	32	40	150	1.5	0.89
040R-5C32-200-LN10	5	40	32	40	200	1.5	1.19
040R-5C32-250-LN10	5	40	32	40	250	1.5	1.48
042R-5C32-150-LN10	5	42	32	40	150	1.5	0.92
042R-5C32-200-LN10	5	42	32	40	200	1.5	1.23
042R-5C32-250-LN10	5	42	32	40	250	1.5	1.51

## Available inserts

LNMX-ML LNMX-MF LNMX-MM



Designation	Cermet		Coated										Uncoated		page			
	CN2500	CN30	NC5330	NCM325	NCM335	NCM535	NCM545	PC2505	PC2510	PC3700	PC6510	PC9530	PC9540	PC5300		PC5400	ST30A	H01
LNMX 100412R-ML													●	●	●			E12
100412R-MF								●	●				●	●	●			
100412R-MM								●	●				●	●				

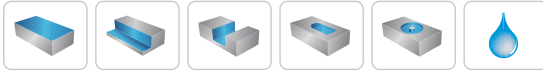
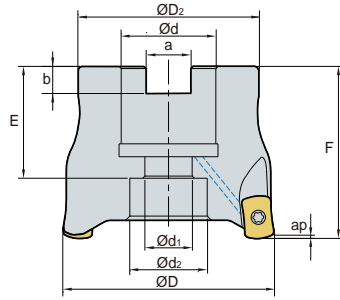
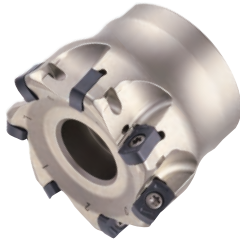
## Parts

Specification		
Ø25~Ø42	FTNA0408	TW15S

Available inserts E12



## HFMDCM-LN06 new



• AR: -9°  
• RR: -12°~-10°

(mm)

Designation		ØD	ØD <sub>2</sub>	Ød	Ød <sub>1</sub>	Ød <sub>2</sub>	a	b	E	F	ap	
HFMDCM 032R-16-5-LN06	5	32	30	16	9	13.5	8.4	5.6	19	40	1.0	0.12
040R-16-6-LN06	6	40	34	16	9	14	8.4	5.6	19	40	1.0	0.21
050R-22-6-LN06	6	50	42	22	11	18	10.4	6.3	21	40	1.0	0.32
050R-22-7-LN06	7	50	42	22	11	18	10.4	6.3	21	40	1.0	0.32
050R-22-8-LN06	8	50	42	22	11	18	10.4	6.3	21	40	1.0	0.32
052R-22-7-LN06	7	52	42	22	11	18	10.4	6.3	21	40	1.0	0.34
052R-22-8-LN06	8	52	42	22	11	18	10.4	6.3	21	40	1.0	0.34
063R-22-8-LN06	8	63	49	22	11	18	10.4	6.3	21	40	1.0	0.53
063R-22-9-LN06	9	63	49	22	11	18	10.4	6.3	21	40	1.0	0.53
066R-22-8-LN06	8	66	49	22	11	18	10.4	6.3	21	40	1.0	0.57
066R-22-9-LN06	9	66	49	22	11	18	10.4	6.3	21	40	1.0	0.57

### Available inserts

LNMX-ML      LNMX-MF      LNMX-MM



Designation	Cermet		Coated										Uncoated		page			
	CN2500	CN30	NC5330	NCM325	NCM335	NCM535	NCM545	PC2505	PC2510	PC3700	PC6510	PC9530	PC9540	PC5300		PC5400	ST30A	H01
LNMX 060310R-ML																		
060310R-MF								●	●					●	●			
060310R-MM								●	●					●	●			

### Available arbors

Designation	Ød	Available arbors
HFMDCM 032R-16-□-LN06	Ø32	BT□□-FMC16-□□
040R-16-□-LN06	Ø40	
050R-22-□-LN06	Ø50	

Designation	Ød	Available arbors
HFMDCM 052R-22-□-LN06	Ø52	BT□□-FMC22-□□
063R-22-□-LN06	Ø63	
066R-22-□-LN06	Ø66	

### Parts

Specification		
Ø32~Ø66	FTNA0306	TW09S

Available inserts E12      Available arbors and bolt E426-E428



# HFMDC(M)-LN10 new

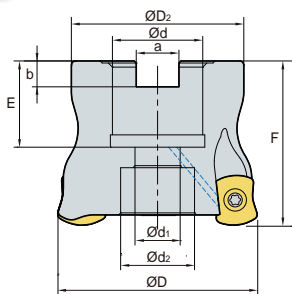
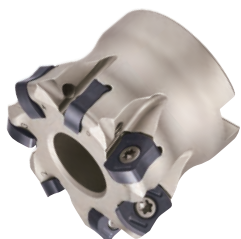


Fig. 1

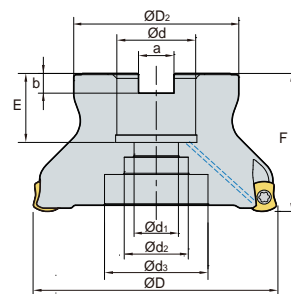


Fig. 2



- AR: -9°
- RR: -16°~13°

(mm)

Designation	ØD	ØD2	Ød	Ød1	Ød2	Ød3	a	b	E	F	ap	kg	Fig.	
<b>HFMDCM</b> 040R-16-4-LN10	4	40	38	16	9	14	-	8.4	5.6	19	40	1.5	0.19	1
040R-16-5-LN10	5	40	38	16	9	14	-	8.4	5.6	19	40	1.5	0.19	1
042R-16-4-LN10	4	42	38	16	9	14	-	8.4	5.6	19	40	1.5	0.20	1
042R-16-5-LN10	5	42	38	16	9	14	-	8.4	5.6	19	40	1.5	0.20	1
050R-22-6-LN10	6	50	42	22	11	18	-	10.4	6.3	21	40	1.5	0.26	1
050R-22-7-LN10	7	50	42	22	11	18	-	10.4	6.3	21	40	1.5	0.26	1
052R-22-6-LN10	6	52	42	22	11	18	-	10.4	6.3	21	40	1.5	0.27	1
052R-22-7-LN10	7	52	42	22	11	18	-	10.4	6.3	21	40	1.5	0.27	1
063R-22-7-LN10	7	63	49	22	11	18	-	10.4	6.3	21	40	1.5	0.47	1
063R-22-8-LN10	8	63	49	22	11	18	-	10.4	6.3	21	40	1.5	0.47	1
066R-22-7-LN10	7	66	49	22	11	18	-	10.4	6.3	21	40	1.5	0.49	1
066R-22-8-LN10	8	66	49	22	11	18	-	10.4	6.3	21	40	1.5	0.50	1
080R-27-9-LN10	9	80	60	27	14	25	35	12.4	7.0	24	50	1.5	0.84	2
080R-27-10-LN10	10	80	60	27	14	25	35	12.4	7.0	24	50	1.5	0.84	2
100R-32-10-LN10	10	100	67	32	18	26	42	14.4	8.0	28	56	1.5	1.48	2
100R-32-11-LN10	11	100	67	32	18	26	42	14.4	8.0	28	56	1.5	1.48	2
100R-32-12-LN10	12	100	67	32	18	26	42	14.4	8.0	28	56	1.5	1.48	2
<b>HFMDC</b> 080R-25.4-9-LN10	9	80	60	25.4	14	25	35	9.5	6	25	50	1.5	0.84	2
080R-25.4-10-LN10	10	80	60	25.4	14	25	35	9.5	6	25	50	1.5	0.84	2
100R-31.75-10-LN10	10	100	67	31.75	18	26	42	12.7	8	32	56	1.5	1.48	2
100R-31.75-11-LN10	11	100	67	31.75	18	26	42	12.7	8	32	56	1.5	1.48	2
100R-31.75-12-LN10	12	100	67	31.75	18	26	42	12.7	8	32	56	1.5	1.48	2

## Available inserts

LNMX-ML LNMX-MF LNMX-MM



Designation	Cermet		Coated										Uncoated		page			
	CN2500	CN80	NC5330	NCM325	NCM335	NCM535	NCM545	PC2505	PC2510	PC3700	PC6510	PC9530	PC9540	PC5300		PC5400	ST30A	H01
LNMX 100412R-ML													●	●	●			E12
100412R-MF									●	●			●	●	●			
100412R-MM									●	●			●	●				

## Available arbors

Designation	Ød	Available arbors
HFMDCM 040R-16-□-LN10	Ø40	BT□□-FMC16-□□
042R-16-□-LN10	Ø42	
050R-22-□-LN10	Ø50	BT□□-FMC22-□□
052R-22-□-LN10	Ø52	
063R-22-□-LN10	Ø63	

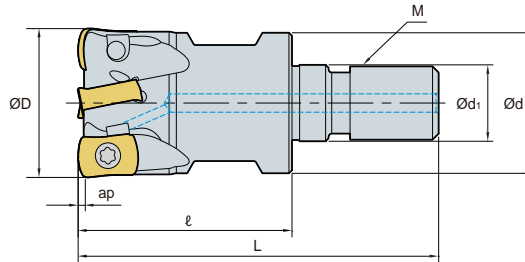
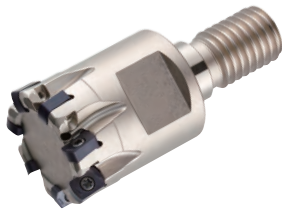
Designation	Ød	Available arbors
HFMDCM 066R-22-□-LN10	Ø66	BT□□-FMC22-□□
080R-27-□-LN10	Ø80	BT□□-FMC27-□□
100R-32-□-LN10	Ø100	BT□□-FMC32-□□
HFMDC 080R-25.4-□-LN10	Ø80	BT□□-FMA25.4-□□
100R-31.75-□-LN10	Ø100	BT□□-FMA31.75-□□

## Parts

Specification	Screw	Wrench
Ø40~Ø100	FTNA0408	TW15S

Available inserts E12 Available arbors and bolt E426-E428

# HFMDM-LN04 new



• AR: -8°  
• RR: -16°~-10°

(mm)

Designation		ØD	Ød	Ød1	ℓ	L	M	ap	
HFMDM 010R-2-M06-LN04	2	10	9.5	6.5	22	37	M6	0.4	0.01
011R-2-M06-LN04	2	11	11	6.5	22	37	M6	0.5	0.01
012R-3-M06-LN04	3	12	11	6.5	22	37	M6	0.5	0.01
013R-3-M06-LN04	3	13	11	6.5	22	37	M6	0.5	0.02
016R-4-M08-LN04	4	16	14.5	8.5	22	39	M8	0.5	0.03
017R-4-M08-LN04	4	17	14.5	8.5	22	39	M8	0.5	0.03
020R-5-M10-LN04	5	20	18	10.5	30	51	M10	0.5	0.06
025R-7-M12-LN04	7	25	23	12.5	30	54	M12	0.5	0.1
032R-8-M16-LN04	8	32	29	17	35	62	M16	0.5	0.2
033R-8-M16-LN04	8	33	29	17	35	62	M16	0.5	0.2
035R-9-M16-LN04	9	35	29	17	35	62	M16	0.5	0.21

## Available inserts

LNX-ML LNX-MM



Designation	Cermet		Coated										Uncoated		page			
	CN2500	CN30	NC5330	NCM325	NCM335	NCM535	NCM545	PC2505	PC2510	PC3700	PC6510	PC9530	PC9540	PC5300		PC5400	ST30A	H01
LNX 040205R-ML														●	●			E12
040205R-MM								●	●					●	●			

## Available adaptor

Designation	Available adaptor
HFMDM 010R-2-M06-LN04	MAT-M06
011R-2-M06-LN04	
012R-3-M06-LN04	
013R-3-M06-LN04	
016R-4-M08-LN04	MAT-M08
017R-4-M08-LN04	

Designation	Available adaptor
HFMDM 020R-5-M10-LN04	MAT-M10
025R-7-M12-LN04	MAT-M12
032R-8-M16-LN04	MAT-M16
033R-8-M16-LN04	
035R-8-M16-LN04	

Designation : HFMDM016R-4-M08-LN04  
Modular head threading measure size (M08)

||

Adaptor spec.: MAT-M08-040-S16T  
Adaptor threading measure (M08)

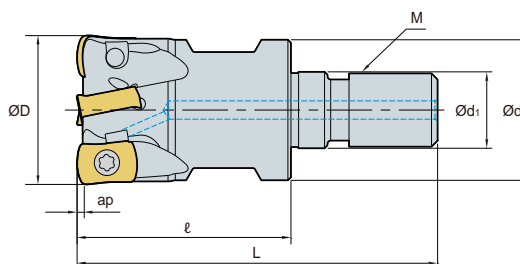
## Parts

Specification		
Ø10~Ø35	FTKA01844-A	TW06S-A

Available inserts E12 Available adaptor E401-E402



# HFMDM-LN06 new



• AR: -9°  
• RR: -15°~10°

(mm)

Designation		ØD	Ød	Ød1	ℓ	L	M	ap	
HFMDM 016R-2-M08-LN06	2	16	14.5	8.5	25	42	M08	0.7	0.03
017R-2-M08-LN06	2	17	14.5	8.5	25	42	M08	1.0	0.03
018R-2-M08-LN06	2	18	14.5	8.5	25	42	M08	1.0	0.04
019R-2-M08-LN06	2	19	14.5	8.5	25	42	M08	1.0	0.05
020R-3-M10-LN06	3	20	18	10.5	30	51	M10	1.0	0.06
021R-3-M10-LN06	3	21	18	10.5	30	51	M10	1.0	0.07
025R-4-M12-LN06	4	25	23	12.5	35	59	M12	1.0	0.10
026R-4-M12-LN06	4	26	23	12.5	35	59	M12	1.0	0.10
032R-5-M16-LN06	5	32	29	17	40	67	M16	1.0	0.20
033R-5-M16-LN06	5	33	29	17	40	67	M16	1.0	0.20
035R-5-M16-LN06	5	35	29	17	40	67	M16	1.0	0.21
040R-6-M16-LN06	6	40	29	17	40	67	M16	1.0	0.24
042R-6-M16-LN06	6	42	29	17	40	67	M16	1.0	0.25

## Available inserts

LNX-ML LNX-MF LNX-MM



Designation	Cermet		Coated										Uncoated		page			
	CN2500	CN30	NC5330	NCM325	NCM335	NCM635	NCM545	PC2505	PC2510	PC3700	PC6510	PC9530	PC9540	PC5300		PC5400	ST30A	H01
LNX 060310R-ML														●	●			E12
060310R-MF									●	●				●	●			
060310R-MM									●	●				●	●			

## Available adaptor

Designation	Available adaptor
HFMDM 016R-□-M08-LN06	MAT-M08
017R-□-M08-LN06	
018R-□-M08-LN06	
019R-□-M08-LN06	
020R-□-M10-LN06	MAT-M10
021R-□-M10-LN06	
025R-□-M12-LN06	MAT-M12

Designation	Available adaptor
HFMDM 026R-□-M12-LN06	MAT-M12
030R-□-M16-LN06	MAT-M16
032R-□-M16-LN06	
033R-□-M16-LN06	
040R-□-M16-LN06	
042R-□-M16-LN06	

Designation : HFMDM025R-□-M12-LN06  
Modular head threading measure size (M12)

||

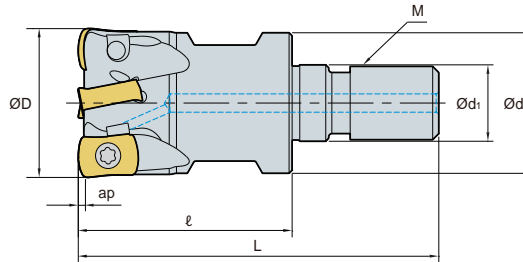
Adaptor spec.: MAT-M12-050-S25T  
Adaptor threading measure (M06)

## Parts

Specification		
Ø16~Ø42	FTNA0306	TW09S

Available inserts E12 Available adaptor E401-E402

# HFMDM-LN10 new



• AR: -9°  
• RR: -16°~-13°

(mm)

Designation		ØD	Ød	Ød1	ℓ	L	M	ap	
HFMDM 025R-2-M12-LN10	2	25	23	12.5	35	59	M12	1.5	0.10
025R-3-M12-LN10	3	25	23	12.5	35	59	M12	1.5	0.10
026R-3-M12-LN10	3	26	23	12.5	35	59	M12	1.5	0.10
030R-4-M16-LN10	4	30	29	17.0	40	67	M16	1.5	0.17
032R-3-M16-LN10	3	32	29	17.0	40	67	M16	1.5	0.19
032R-4-M16-LN10	4	32	29	17.0	40	67	M16	1.5	0.19
033R-4-M16-LN10	4	33	29	17.0	40	67	M16	1.5	0.19
035R-3-M16-LN10	3	35	29	17.0	40	67	M16	1.5	0.20
035R-4-M16-LN10	4	35	29	17.0	40	67	M16	1.5	0.20
040R-4-M16-LN10	4	40	29	17.0	40	67	M16	1.5	0.22
040R-5-M16-LN10	5	40	29	17.0	40	67	M16	1.5	0.22
042R-4-M16-LN10	4	42	29	17.0	40	67	M16	1.5	0.25
042R-5-M16-LN10	5	42	29	17.0	40	67	M16	1.5	0.25

## Available inserts

LNX-ML LNX-MF LNX-MM



Designation	Cermet		Coated										Uncoated		page			
	CN2500	CN30	NC5330	NCM325	NCM335	NCM635	NCM645	PC2505	PC2510	PC3700	PC6510	PC9530	PC9540	PC5300		PC5400	ST30A	H01
LNX 100412R-ML																		E12
100412R-MF								●	●			●	●	●				
100412R-MM								●	●			●	●	●				

## Available adaptor

Designation	Available adaptor
HFMDM 025R-□-M12-LN10	MAT-M12
026R-□-M12-LN10	
030R-□-M16-LN10	MAT-M16
032R-□-M16-LN10	

Designation	Available adaptor
HFMDM 033R-□-M16-LN10	MAT-M16
035R-□-M16-LN10	
040R-□-M16-LN10	
042R-□-M16-LN10	

Designation : HFMDM035R-□-M16-LN10  
Modular head threading measure size (M16)

||

Adaptor spec.: MAT-M16-035-S32S  
Adaptor threading measure (M16)

## Parts

Specification		
Ø25-Ø42	FTNA0408	TW15S

Available inserts E12 Available adaptor E401-E402



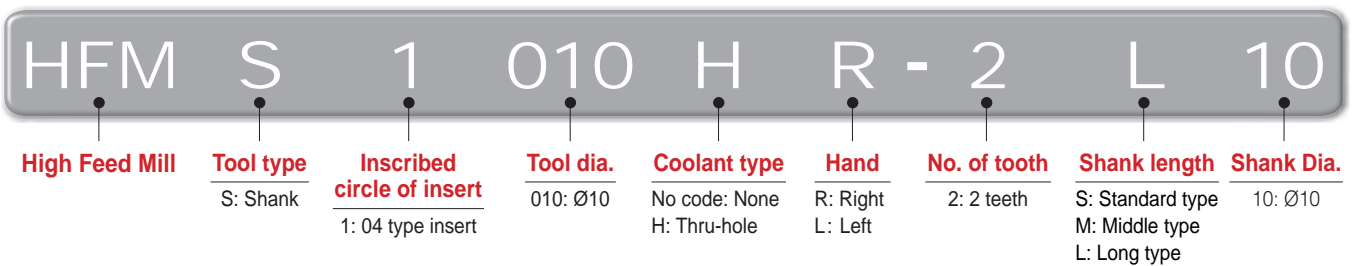
Stable machining, high efficiency milling tools for small diameter machining

**HFM** **new**

- Increase productivity through improved insert shape and size, high feed per tooth, and many cutting-edges, for small diameter machining
- Stable tool life through the combination of the reinforced toughness on corner and suitable grades of high hardness in the area of high speed and high hardness

**Code system**

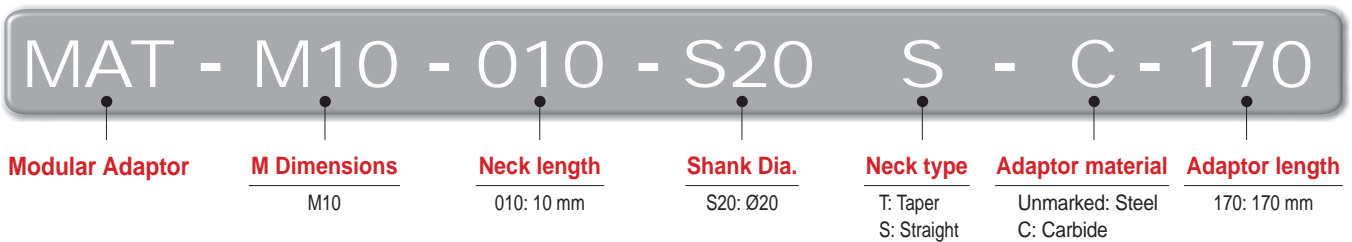
• **Shank**



• **Modular**



• **Modular adaptor**



**Features**

- Apply helix cutting-edge on insert, low cutting load and reinforce toughness on corner
- Increased rigidity with double relief angle (11, 13), prevent interference with high feed
- To apply the negative axial rake angle when set up the holder, increased chipping resistance
- Tool life is increased with suitable C/B and grade for every material



- **Holder setup**  
- To set up the negative axial rake angle, increased chipping resistance
- **No. of tooth**  
- Increased tool life with increased flutes  
- HRM(D) Ø20 (2 flutes) → HFM Ø20 (5 flutes)





- **Relief angle**  
- 11, 13 double relief angle increase rigidity and prevent interference
- **Major cutting-edge**  
- Improved sharpness of principle edge  
- Improved toughness of corner edge



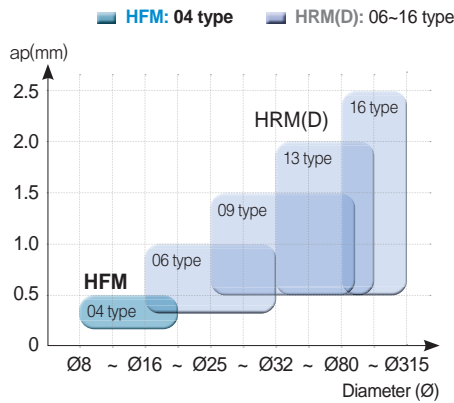
# E Technical Information for HFM

## Features of chip breaker

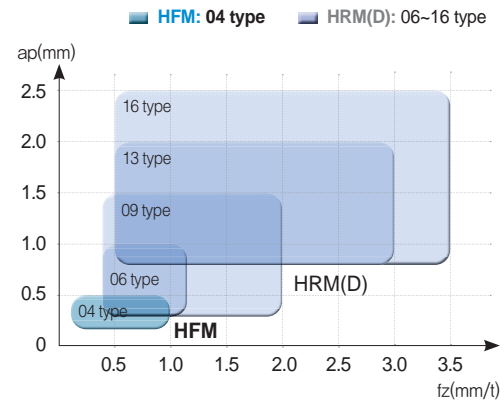
Insert	Cutting-edge	Uses	Features
MF		Light cutting Titanium & Inconel machining	Low cutting resistance C/B, suitable for light cutting
None C/B		Super hard material machining	High toughness shape, suitable for hard die steel cutting

## Application area

Application area (ap & Diameter)



Application area (ap & fz)



## Recommended cutting condition

※ Recommended chip breaker: ● 1st ○ 2nd



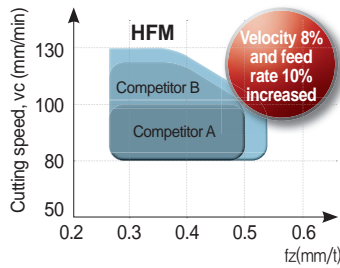
Workpiece		Workpiece			HB (HRC)	Grades	Cutting conditions				Chip breaker	
		KOR (KS)	USA (AISI)	GER (DIN)			vc (m/min)	fz (mm/t)	ap (mm)	ae	MF	None C/B
P	Mild steel	SM20C	1020	C22	120~180	PC5400 (PC5300)	100~220	0.5~1.0	~0.5	0.7D~0.1D	●	-
	Carbon steel	SM45C	1045	C45	200	PC5400 (PC5300)	100~200	0.5~1.0	~0.5	0.7D~0.1D	●	-
	Alloy steel	SCM440	4140	41CrMo4	270(28)	PC5300	100~200	0.5~1.0	~0.5	0.7D~0.1D	●	-
	Pre-hardened steel	KP4M	P20 (Improved)	1.2738 (Improved)	300(32)	PC5300 (PC2510)	100~180	0.5~0.9	~0.4	0.7D~0.1D	●	○
		NIMAX	P21 (Improved)	-	370(40)	PC5300 (PC2510)	100~180	0.5~0.9	~0.4	0.7D~0.1D	●	○
		CENA1	P21 (Improved)	-	370(40)	PC5300 (PC2510)	100~180	0.5~0.9	~0.4	0.7D~0.1D	●	○
		NAK80	P21 (Improved)	-	400(43)	PC5300	100~160 100~180	0.5~0.7 0.5~0.9	~0.4	0.7D~0.1D	○ -	- ●
	STAVAX	420	X30Cr13	510(52)	PC2510 (PC5300)	80~150	0.3~0.6	~0.4	0.7D~0.1D	●	-	
	Alloy tool steel	STD11 STD61	D2 H13	X155CrVMo12-1 X40CrMoV5-1	- (40~50)	PC2510 (PC2505)	80~130	0.3~0.55	~0.3	0.7D~0.1D	-	●
STD11 (Cold forging)		D2	X155CrVMo12-1	630(60)	PC2505	30~75	0.3~0.5	~0.2	0.7D~0.1D	-	●	
M	Stainless steel	STS316	316	X5CrNiMo17-12-2	Under 270	PC5400 (PC5300)	70~150	0.5~0.7	~0.5	0.7D~0.1D	●	-
K	Gray cast iron, Ductile cast iron	GCD450	65-45-12	GGG40.3	Tensile Strength Over 450Mpa	PC5300	130~220	0.6~0.8	~0.5	0.7D~0.1D	●	-
S	HRSA Fe series Ni or Co series	Incoloy901	N09901	- (WS 2.4662)	- (25~35)	PC5300 (PC5400)	30~100	0.3~0.5	~0.3	0.4D~0.7D	●	○
		Inconel718	N07718	NiCr19FeNbMo (WS 2.4668)	- (35~45)	PC5300 (PC5400)	20~50	0.3~0.6	~0.3	0.4D~0.7D	●	○
	Titanium	Ti-6Al-4V	R56400	TiAl6V4	- (40~45)	PC5300	30~50	0.4~1.0	~0.3	0.7D~0.1D	●	-



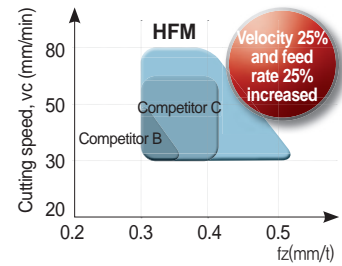
## Performance evaluation

### High speed machining

- **Workpiece**  
STD11 (HRC40~45)
- **Insert**  
LPM(E)W0402□□R
- **Recommended grade**  
PC2505 (1<sup>st</sup>), PC2510 (2<sup>nd</sup>)

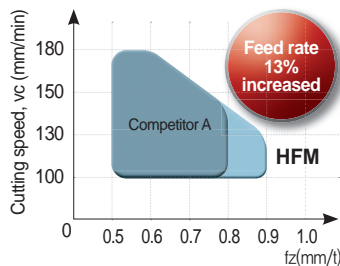


- **Workpiece**  
STD11 (Over HRC60)
- **Insert**  
LPM(E)W0402□□R
- **Recommended grade**  
PC2505 (1<sup>st</sup>), PC2510 (2<sup>nd</sup>)

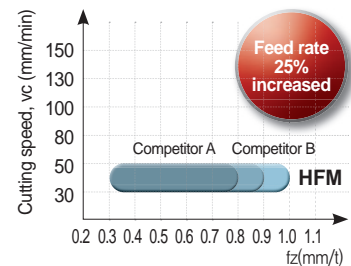


### High feed machining

- **Workpiece**  
KP4M (HRC32),  
NAK80 (HRC43)
- **Insert**  
LPMT0402□□R-MF
- **Recommended grade**  
PC5300 (1<sup>st</sup>), PC2510 (2<sup>nd</sup>)



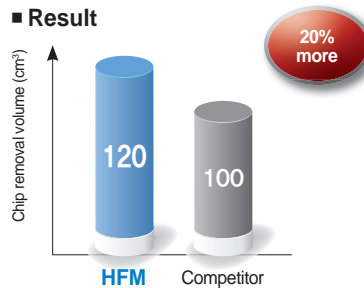
- **Workpiece**  
Ti-6AL-4V (HRC40~45)
- **Insert**  
LPMT0402□□R-MF
- **Recommended grade**  
PC5300 (1<sup>st</sup>), PC5400 (2<sup>nd</sup>)



## Machining example

### Alloy tool steel [X155CrVMo12-1 (DIN)/D2 (AISI)/STD11 (KS), HRC40~45]

- **Workpiece** Mold
- **Cutting conditions**  
vc (m/min) = 80, fz (mm/t) = 0.5  
ap (mm) = 0.3, ae (mm) = 10  
dry
- **Tools**  
Insert LPMW040210R (PC2510)  
Holder HFMS1016HR-4S16



HFM

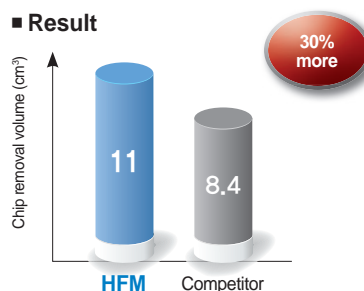


Competitor

- Chip removal rate Q (cm<sup>3</sup>/min): 4.8
- Cutting time (min): 25

### Alloy tool steel [X155CrVMo12-1 (DIN)/D2 (AISI)/STD11 (KS), HRC60]

- **Workpiece** Mold
- **Cutting conditions**  
vc (m/min) = 75, fz (mm/t) = 0.4  
ap (mm) = 0.15, ae (mm) = 5  
dry
- **Tools**  
Insert LPMW040210R (PC2505)  
Holder HFMS1010HR-2S10



HFM

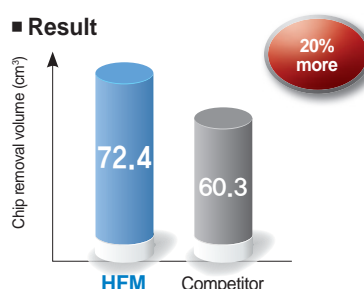


Competitor

- Chip removal rate Q (cm<sup>3</sup>/min): 1.4
- Cutting time (min): 7.85

### HRSA [TiAl6V4 (DIN)/R56400 (AISI)/Ti-6Al-4V (KS), HRC48]

- **Workpiece** Aviation parts
- **Cutting conditions**  
vc (m/min) = 50, fz (mm/t) = 1.2  
ap (mm) = 0.3, ae (mm) = 10  
wet
- **Tools**  
Insert LPMT040210R-MF (PC5300)  
Holder HFMS1016HR-4S16



HFM

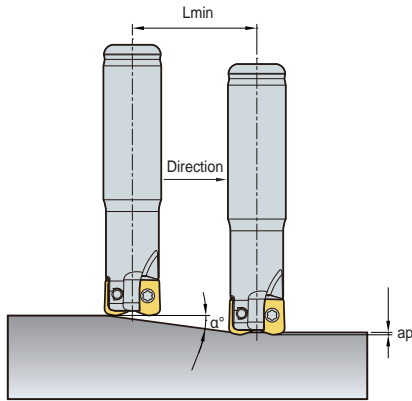


Competitor

- Chip removal rate Q (cm<sup>3</sup>/min): 7.2
- Cutting time (min): 10.05

## Ramping and helical cutting

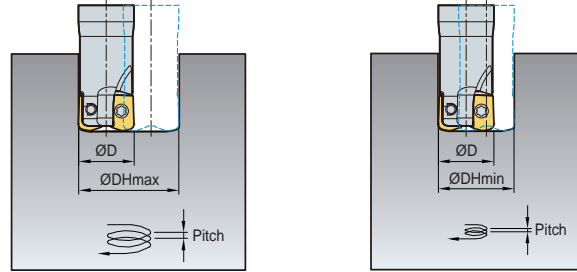
### Ramping



$$L_{min} = \frac{ap}{\tan \alpha^\circ} \text{ (mm)}$$

※ Lmin: Min. inclination cutting length  
 α°: Max. ramping angle  
 ap: Depth of cut

### Helical cutting



- ØD = Tool dia. (mm)
- Ød = Tool path (mm) = ØDHmin, Max - ØD
- ØDHmin (Min diameter, mm) = ØD × 2 - 5.4
- ØDHmax (Max diameter, mm) = ØD × 2 - 2

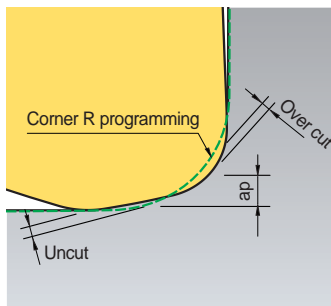
(mm)

Designation	Tool dia. ØD	Depth of cut ap	Ramping		Helical cutting		
			Max ramping angle α (°)	Lmin	Max diameter ØDHMax	Min diameter ØDHMin	Max pitch dmax
HFMS1010HR	10	0.4~0.5	3.5	7	18	15	0.4
HFMS1011HR	11	0.4~0.5	3.1	8	20	17	0.4
HFMS1012HR	12	0.4~0.5	2.7	9	22	19	0.4
HFMS1013HR	13	0.4~0.5	2.4	10	24	21	0.4
HFMS1014HR	14	0.4~0.5	2.2	11	26	23	0.4
HFMS1015HR	15	0.4~0.5	2.0	12	28	25	0.4
HFMS1016HR	16	0.4~0.5	1.8	13	30	27	0.4
HFMS1017HR	17	0.4~0.5	1.7	14	32	29	0.4
HFMS1018HR	18	0.4~0.5	1.6	15	34	31	0.4
HFMS1019HR	19	0.4~0.5	1.5	16	36	33	0.4
HFMS1020HR	20	0.4~0.5	1.4	17	38	35	0.4
HFMS1021HR	21	0.4~0.5	1.3	18	40	37	0.4
HFMM1025HR	25	0.4~0.5	1.1	22	48	45	0.4
HFMM1026HR	26	0.4~0.5	1.0	23	50	47	0.4
HFMM1030HR	30	0.4~0.5	0.9	27	58	55	0.4
HFMM1032HR	32	0.4~0.5	0.8	29	62	59	0.4
HFMM1033HR	33	0.4~0.5	0.8	30	64	61	0.4

- Adjust feed to under 70% of recommended cutting condition when ramping & helical cutting
- In helical ramping, max. cutting depth per 1 helical revolution of cutter should not exceed max. cutting depth as per insert size
- In ramping, max. cutting depth per 1 ramping process of cutter should not exceed max. depth of cut as per used insert size

## Corner R programming

(mm)

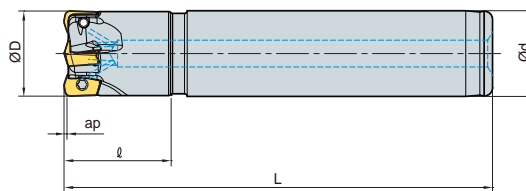


Insert	Corner R programming	Cutting conditions		Over Cut	Uncut
		Nose R	Max. ap		
LPMT040210R-MF	R1.0 (Standard)	1.0	0.4	0	0.17
LPMW040210R	R1.5			0.10	0.08
LPEW040210R	R2.0			0.31	0
LPMT040220R-MF	R1.0	2.0	0.5	0	0.41
LPMW040220R	R1.5			0	0.2
LPEW040220R	R2.0 (Standard)			0	0

- When using CNC program, overcut & uncut occurs on the corner processing site if entering the correct program corner R value for each insert
- To prevent overcut, you will need to complete a CNC program considering the above overcut



# HFMS1000 new



AA  
13°  
• AR: -4°  
• RR: -14°~-7°

(mm)

Designation		ØD	Ød	l	L	ap	
HFMS 1008HR-1S10	1	8	10	20	80	0.4~0.5	0.03
1008HR-1M10	1	8	10	25	100	0.4~0.5	0.03
1008HR-1L10	1	8	10	35	120	0.4~0.5	0.03
1010HR-2S08	2	10	8	20	80	0.4~0.5	0.03
1010HR-2M08	2	10	8	25	100	0.4~0.5	0.04
1010HR-2L08	2	10	8	35	120	0.4~0.5	0.04
1010HR-2S10	2	10	10	20	80	0.4~0.5	0.04
1010HR-2M10	2	10	10	25	105	0.4~0.5	0.05
1010HR-2L10	2	10	10	35	120	0.4~0.5	0.06
1011HR-2S10	2	11	10	20	80	0.4~0.5	0.04
1011HR-2M10	2	11	10	25	105	0.4~0.5	0.06
1011HR-2L10	2	11	10	35	120	0.4~0.5	0.07
1012HR-3S10	3	12	10	20	80	0.4~0.5	0.05
1012HR-3M10	3	12	10	25	105	0.4~0.5	0.06
1012HR-3L10	3	12	10	35	120	0.4~0.5	0.07
1012HR-3S12	3	12	12	20	80	0.4~0.5	0.06
1012HR-3M12	3	12	12	25	105	0.4~0.5	0.08
1012HR-3L12	3	12	12	35	120	0.4~0.5	0.09
1013HR-3S12	3	13	12	20	80	0.4~0.5	0.06
1013HR-3M12	3	13	12	25	105	0.4~0.5	0.09
1013HR-3L12	3	13	12	40	120	0.4~0.5	0.10
1014HR-3S12	3	14	12	20	80	0.4~0.5	0.07
1014HR-3M12	3	14	12	25	105	0.4~0.5	0.09
1014HR-3L12	3	14	12	40	120	0.4~0.5	0.10

## Available inserts



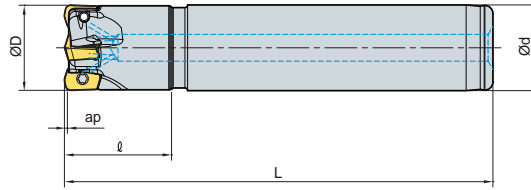
Designation	Cermet		Coated										Uncoated			page			
	CN2500	CN30	NC5330	NCM325	NCM335	NCM535	NCM545	PC2505	PC2510	PC3700	PC6510	PC9530	PC9540	PC5300	PC5400		ST30A	G10	H01
LPMT 040210R-MF								●	●					●	●				E12
040220R-MF								●	●					●	●				
LPMW 040210R								●	●					●	●				E13
040220R								●	●					●	●				
LPEW 040210R								●	●					●	●				E13
040220R								●	●					●	●				

## Parts

Specification		
Ø8~Ø10	FTKA01840	TW06S-A
Ø11~Ø14	FTKA01842	

Available inserts E12, E13

## HFMS1000 new



AA  
13°  
• AR: -4°  
• RR: -6°~3°

(mm)

Designation		ØD	Ød	ℓ	L	ap	
HFMS 1015HR-4S12	4	15	12	20	80	0.4~0.5	0.07
1015HR-4M12	4	15	12	25	105	0.4~0.5	0.09
1015HR-4L12	4	15	12	40	120	0.4~0.5	0.11
1016HR-4S16	4	16	16	20	80	0.4~0.5	0.11
1016HR-4M16	4	16	16	25	105	0.4~0.5	0.14
1016HR-4L16	4	16	16	40	120	0.4~0.5	0.16
1017HR-4S16	4	17	16	20	80	0.4~0.5	0.11
1017HR-4M16	4	17	16	25	105	0.4~0.5	0.15
1017HR-4L16	4	17	16	40	120	0.4~0.5	0.17
1018HR-4S16	4	18	16	20	80	0.4~0.5	0.11
1018HR-4M16	4	18	16	25	105	0.4~0.5	0.15
1018HR-4L16	4	18	16	40	120	0.4~0.5	0.17
1019HR-4S16	4	19	16	20	80	0.4~0.5	0.12
1019HR-4M16	4	19	16	25	105	0.4~0.5	0.16
1019HR-4L16	4	19	16	40	120	0.4~0.5	0.18
1020HR-4S20	4	20	20	20	80	0.4~0.5	0.17
1020HR-4M20	4	20	20	25	105	0.4~0.5	0.22
1020HR-4L20	4	20	20	40	120	0.4~0.5	0.26
1020HR-5S20	5	20	20	20	80	0.4~0.5	0.17
1020HR-5M20	5	20	20	25	105	0.4~0.5	0.23
1020HR-5L20	5	20	20	40	120	0.4~0.5	0.27
1021HR-5S20	5	21	20	20	80	0.4~0.5	0.17
1021HR-5M20	5	21	20	25	105	0.4~0.5	0.23
1021HR-5L20	5	21	20	40	120	0.4~0.5	0.27

### Available inserts



Designation	Cermet		Coated										Uncoated			page			
	CN2500	CN30	NC5330	NCM325	NCM335	NCM535	NCM545	PC2505	PC2510	PC3700	PC6510	PC9530	PC9540	PC5300	PC5400		ST30A	G10	H01
LPMT 040210R-MF								●	●					●	●				E12
040220R-MF								●	●					●	●				
LPMW 040210R								●	●					●	●				E13
040220R								●	●					●	●				
LPEW 040210R								●	●					●	●				E13
040220R								●	●					●	●				

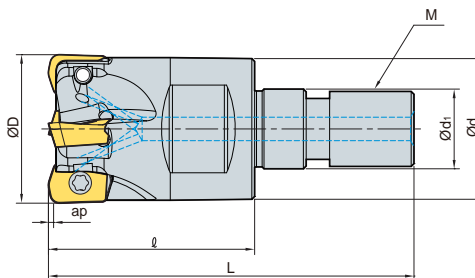
### Parts

Specification		
Ø15~Ø21	FTKA01842	TW06S-A

Available inserts E12, E13



# HFMM new



• AR: -4°  
• RR: -14°~-3°

(mm)

Designation										
Designation		ØD	Ød	Ød <sub>1</sub>	l	L	M	ap		
HFMM 1008HR-M06	1	8	9.5	6.5	17	32	M06	0.4~0.5	0.01	
1010HR-M06	2	10	9.5	6.5	17	32	M06	0.4~0.5	0.01	
1011HR-M06	2	11	9.5	6.5	17	32	M06	0.4~0.5	0.01	
1012HR-M06	3	12	11	6.5	19	34	M6B	0.4~0.5	0.01	
1013HR-M06	3	13	11	6.5	19	34	M6B	0.4~0.5	0.01	
1016HR-M08	4	16	14.5	8.5	22	39	M08	0.4~0.5	0.03	
1017HR-M08	4	17	14.5	8.5	22	39	M08	0.4~0.5	0.03	
1020HR-M10	5	20	18	10.5	25	46	M10	0.4~0.5	0.06	
1021HR-M10	5	21	18	10.5	25	46	M10	0.4~0.5	0.06	
1025HR-M12	6	25	23	12.5	27	51	M12	0.4~0.5	0.11	
1026HR-M12	6	26	23	12.5	27	51	M12	0.4~0.5	0.11	
1030HR-M16	7	30	29	17	30	60	M16	0.4~0.5	0.17	
1032HR-M16	8	32	29	17	30	60	M16	0.4~0.5	0.18	
1033HR-M16	8	33	29	17	30	60	M16	0.4~0.5	0.18	

## Available inserts



Designation	Cermet		Coated										Uncoated			page		
	CN2500	CN30	NC5330	NCM325	NCM335	NCM535	NCM545	PC2505	PC2510	PC3700	PC6510	PC9530	PC9540	PC5300	PC5400		ST30A	G10
LPMT 040210R-MF								●	●					●	●			
040220R-MF								●	●					●	●			
LPMW 040210R								●	●					●	●			
040220R								●	●					●	●			
LPEW 040210R								●	●					●	●			
040220R								●	●					●	●			

## Available adaptor

Designation	Available adaptor	Designation	Available adaptor
HFMM 1008HR-M06	MAT-M06	HFMM 1020HR-M10	MAT-M10
1010HR-M06		1021HR-M10	
1011HR-M06		MAT-M12	
1012HR-M06			1025HR-M12
1013HR-M06			1026HR-M12
1016HR-M08	MAT-M08	1030HR-M16	MAT-M16
1017HR-M08		1032HR-M16	
		1033HR-M16	

Designation : HFMM1008HR-M06  
Modular head threading measure size (M06)

II

Adaptor spec.: MAT-M06-020-S10S  
Adaptor threading measure (M06)

## Parts

Specification		
Ø8~Ø10	FTKA01840	TW06S-A
Ø11~Ø33	FTKA01842	

Available inserts E12, E13

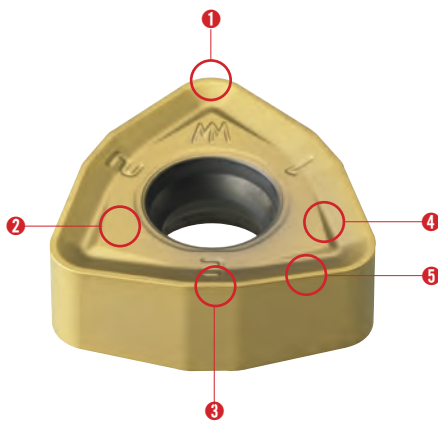
Available adaptor E401-E402

HRMD is more economical due to the use of 6 cutting-edges compared to HRM tool with a 3-edge positive insert

## HRMDouble

- HRMD is more economical due to the use of 6 cutting-edges compared to HRM tool with a 3-edge positive insert
- High-rake angle cutting-edge and chip breaker reduces cutting load
- Negative geometry has been designed for rigidity of cutting-edge and double-sided function
- Screw on system and stable support achieves strong clamping force
- Unique insert design for high feed and multifunctional machining
- HRMD insert with symmetrical cutting-edge is applicable for both R and L type machining

### Features of insert



#### 1 Nose-R

- Security of rigid edge in ramping pocket machining
- Round edge suitable for high feed rates insert geometry
- Possible to use R/L type machining

#### 2 Clamping surface

- Design for stable clamping
- Prevention of friction by chip

#### 3 Minor cutting-edge

- Improvement of surface roughness in high feed machining
- Special design for decreasing thrust force
- Symmetrical insert design for R/L type tool

#### 4 Chip breaker

- Reduction of cutting load due to High-rake angle
- Improvement of chip flow and evacuation in various applications
- Prevention of damage on clamping face of insert

#### 5 Major cutting-edge

- Symmetrical design insert for R/L type tool
- Superior cutting performance due to high rake angle cutting-edge
- Low cutting resistance in high feed
- Special design for decreasing thrust force

### Features of cutter



#### Inner coolant system

- Improvement of chip control and evacuation
- Longer tool life due to reduced cutting temperature

#### 3-surface constrained system

- Strong clamping system
- Stable clamping system against different cutting resistances in various machining applications

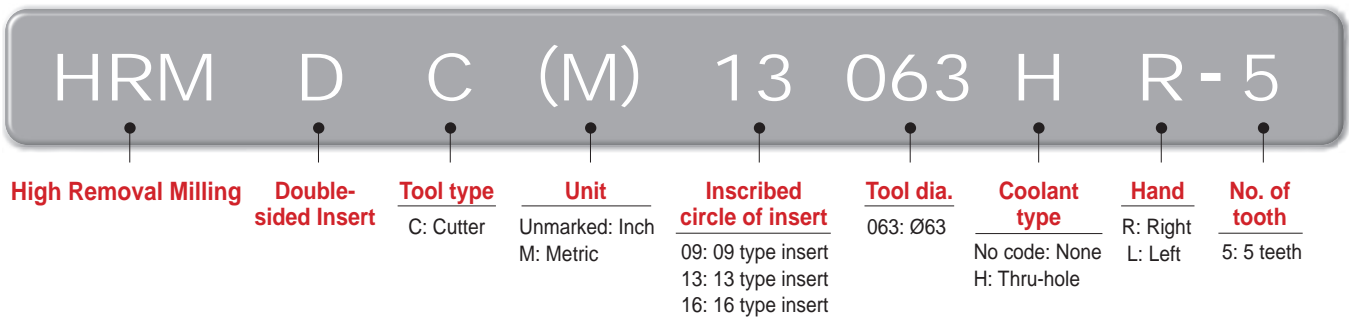
#### Simple screw on system

- Strong clamping of screw on system
- Convenient clamping system
- Wide chip pocket for better chip evacuation

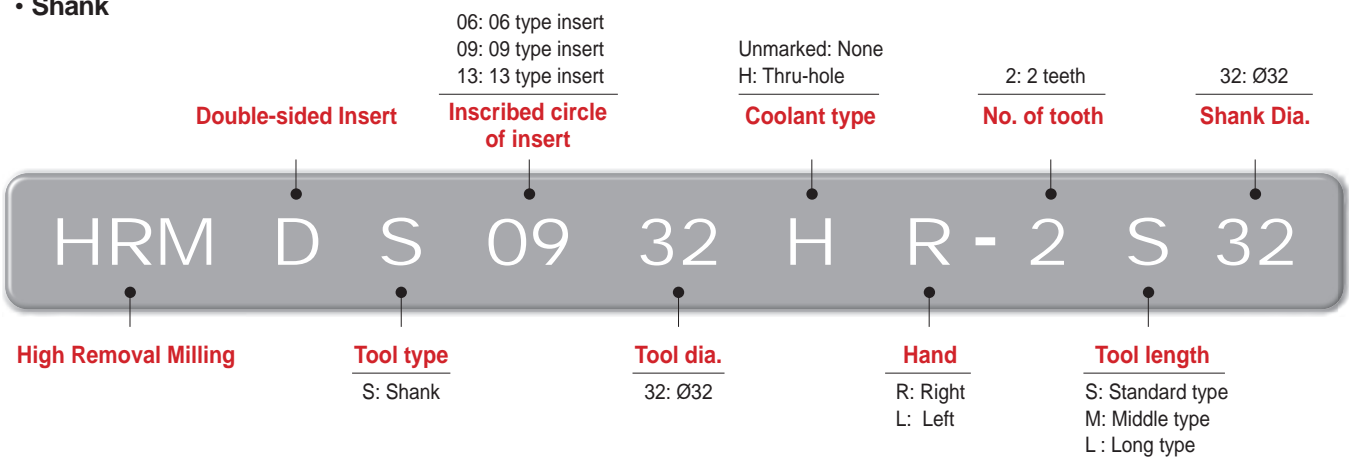


## Code system

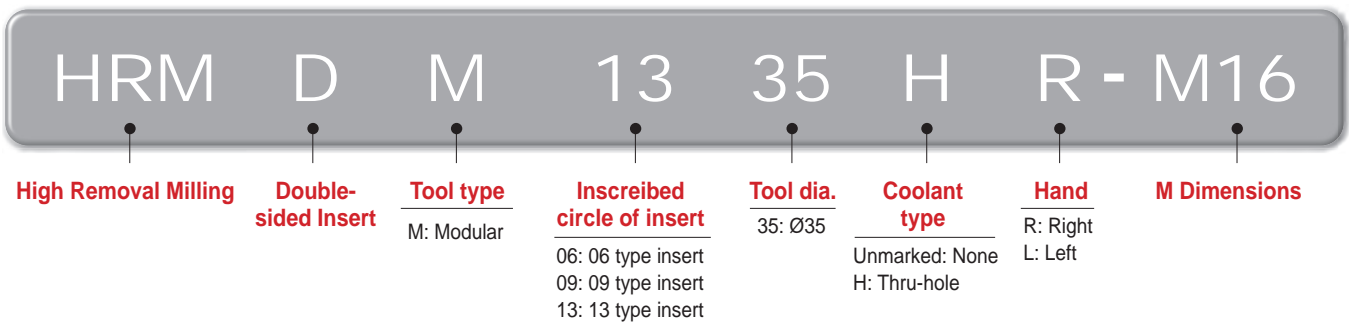
### • Cutter



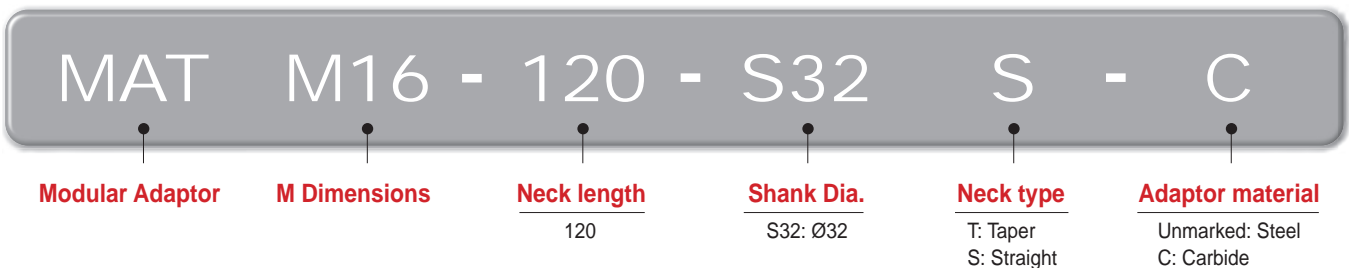
### • Shank



### • Modular head



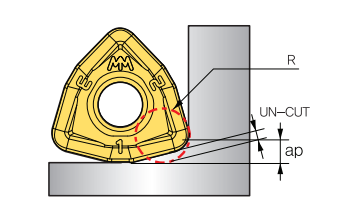
### • Modular adaptor



## Corner R programming

Designation	Cutting condition		Approx. R (mm)	
	Max.ap (mm)	Max.fz (mm/t)	Input. R	Uncut
WNMX060312ZNN-□□	1.0	1.2	1.8	0.4
WNMX09T316ZNN-□□	1.5	2.0	2.5	0.6
WNMX130520ZNN-□□	2.0	3.0	3.0	0.8
WNMX160720ZNN-□□	2.5	3.5	3.5	1.2

Information for uncut part by using "Input.R" for CAM program

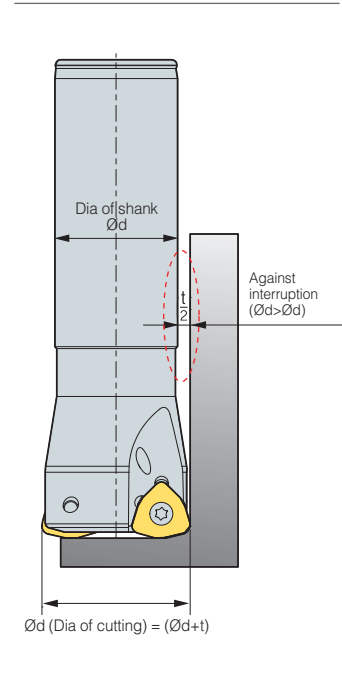


Uncut part can be changed by poor machine condition or weak clamp of workpiece, etc

## Interference prevent system

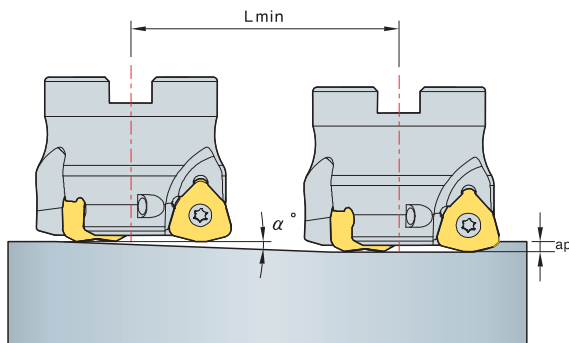
Designation	ØD (mm)	Ød (mm)	t (mm)
HRMDS0617HR-2□16	17	16	1
HRMDS0618HR-2□16	18	16	2
HRMDS0621HR-2□20	21	20	1
HRMDS0626HR-3□25	26	25	1
HRMDS0633HR-4□32	33	32	1
HRMDS0926HR-2□25	26	25	1
HRMDS0933HR-3□32	33	32	1
HRMDS0935HR-4□32	35	32	3
HRMDS0940HR-4□32	40	32	8
HRMDS0950HR-5□32	50	32	18
HRMDS0950HR-5□40	50	40	10
HRMDS0950HR-5□42	50	42	8
HRMDS1333HR-3□32	33	32	1
HRMDS1335HR-4□32	35	32	3
HRMDS1340HR-4□30	40	30	8
HRMDS1350HR-4□32	50	32	18
HRMDS1350HR-4□40	50	40	10
HRMDS1350HR-4□42	50	42	8
HRMDS1363HR-5□32	63	32	31
HRMDS1363HR-5□40	63	40	23
HRMDS1363HR-5□42	63	42	21

The side clearance prevents to interference between tool and workpiece even in deep hole machining

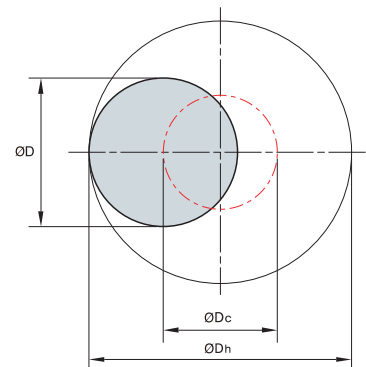


## Ramping & helical cutting technical data

### Ramping



### Helical cutting



$$L_{min} = \frac{ap}{\tan \alpha^\circ} \text{ (mm)}$$

$$\varnothing D_c = \varnothing D_h - \varnothing D$$

$\varnothing D_c$  = Tool pass of tool center

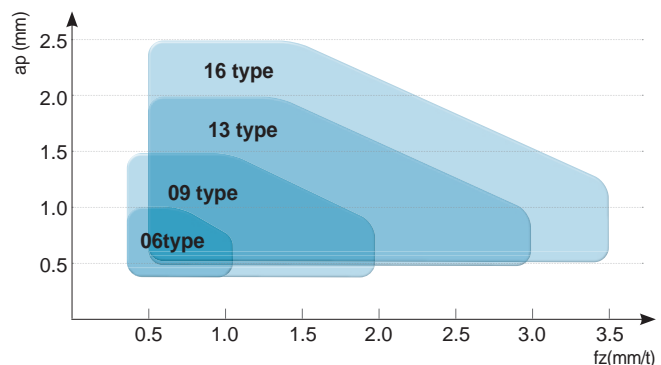
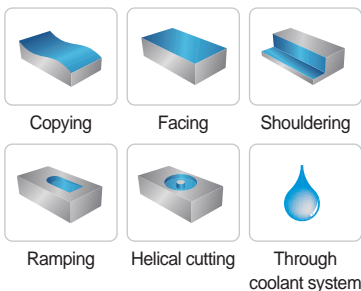
$\varnothing D_h$  = Desirable hole diameter on workpiece

$\varnothing D$  = Tool dia.

- Adjust feed to under 70% of Recommended cutting condition when ramping & helical cutting
- In helical ramping, max. cutting depth per 1 helical revolution of cutter should not exceed max. cutting depth as per insert size
- in ramping, max. cutting depth for 1 ramping process should not exceed max. depth of cut as per used insert size

Designation	Tool dia. $\varnothing D$ (mm)	Efficient cutting diameter $\varnothing D_e$ (mm)	Ramping			Helical ramping	
			Max. ap (mm)	Max. angle $\alpha^\circ$	Cutting Length Lmin (mm)	Dh Min. Cutting diameter (mm)	Dh Max. Cutting diameter (mm)
HRMDS0616HR	16	9.5	1	4.8	11	23.8	29.6
HRMDS0617HR	17	10.5	1	4.1	13	25.8	31.6
HRMDS0618HR	18	11.5	1	3.5	16	27.8	33.6
HRMDS0620HR	20	13.5	1	2.5	22	31.8	37.6
HRMDS0621HR	21	14.5	1	2.2	26	33.8	39.6
HRMDS0625HR	25	18.5	1	1.3	44	41.8	47.6
HRMDS0626HR	26	19.5	1	1.2	47	43.8	49.6
HRMDS0632HR	32	25.5	1	0.6	95	55.8	61.6
HRMDS0633HR	33	26.5	1	0.5	114	57.8	63.6
HRMDS0925HR	25	15.4	1.5	5.4	15.8	37.6	46.8
HRMDS0926HR	26	16.4	1.5	5.0	17.0	39.6	48.8
HRMDS0930HR	30	20.4	1.5	3.9	22.0	47.6	56.8
HRMDS0932HR	32	22.3	1.5	3.5	24.5	51.6	60.8
HRMDS0933HR	33	23.3	1.5	3.3	25.8	53.6	62.8
HRMDS0935HR	35	25.4	1.5	3.0	28.3	57.6	66.8
HRMDS0940HR	40	30.2	1.5	2.5	34.5	67.6	76.8
HRMDS0950HR	50	40.2	1.5	1.8	47.0	87.6	96.8
HRMDS1332HR	32	19.3	2	5.7	20.0	47	60
HRMDS1333HR	33	20.3	2	5.4	21.3	49	62
HRMDS1335HR	35	22.3	2	4.8	24.0	53	66
HRMDS1340HR	40	27.2	2	3.7	30.7	63	76
HRMDS1350HR	50	37	2	2.6	44.0	83	96
HRMDS1363HR	63	50	2	1.9	61.3	109	122
HRMDCM09040HR	40	30.2	1.5	2.5	34.5	67.6	76.8
HRMDCM09050HR	50	40.2	1.5	1.8	47.0	87.6	96.8
HRMDCM09063HR	63	53.1	1.5	1.4	63.3	113.6	122.8
HRMDC(M)09080HR	80	70.1	1.5	1.0	84.5	147.6	156.8
HRMDC(M)09100HR	100	90	1.5	0.8	109.5	187.6	196.8
HRMDCM13050HR	50	37	2	2.6	44.0	83	96
HRMDCM13063HR	63	50	2	1.9	61.3	109	122
HRMDC(M)13080HR	80	66.9	2	1.4	84.0	143	156
HRMDC(M)13100HR	100	86.9	2	1.0	110.7	183	196
HRMDC(M)13125HR	125	111.9	2	0.8	144.0	233	246
HRMDC(M)16080HR	80	63.3	2.5	1.4	102	138	156
HRMDC(M)16100HR	100	83.3	2.5	1	143	178	196
HRMDC(M)16125HR	125	108.3	2.5	0.7	204	228	246
HRMDC(M)16160R	160	143.3	2.5	0.5	286	298	316
HRMDC(M)16200R	200	183.3	2.5	0.3	477	378	396
HRMDC(M)16250R	250	233.3	2.5	0.2	716	478	496
HRMDC(M)16315R	315	298.3	2.5	0.1	1432	608	626

## Uses



## Recommended cutting condition

ISO	Workpiece	Material	Grades	Cutting speed, vc (m/min)		
P	Carbon steel	Low carbon steel	SUM22, C = 0.1~25	PC5300 280 PC5400 245		
		General carbon steel	C = 0.30~55	PC5300 255 PC5400 220		
		High carbon steel	C = 0.55~80	PC5300 240 PC5400 205		
		Low alloy steel (Alloy constituent < 5%)	-	SCM415(H), SCM420, SCM440	PC5300 195 PC5400 170	
			Hardened		PC5300 115 PC5400 100	
		High alloy steel (Alloy constituent > 5%)	Annealed	SKD61	PC5300 150 PC5400 130	
	Hardened		SKH51, SKH55	PC5300 120 PC5400 105		
	M	Stainless steel	Ferritic / Martensitic	SUS410, SUS420, SUS430	PC5300 160 PC5400 135	
			Austenitic	SUS303, SUS304, SUS316	PC5300 130 PC5400 110	
			Duplex (Austenitic / Ferritic)	F51	PC5300 100 PC5400 85	
K			Gray cast iron	Low tensile	GC200, GC250	PC5300 170 PC5400 150
				High tensile	GC300, GC350	PC5300 150 PC5400 130
	Ductile cast iron	Ferritic		GCD400, GCD500	PC5300 170 PC5400 150	
		Pearlitic	GCD600, GCD700	PC5300 150 PC5400 130		
	S	Fe Base	-	Incoloy	PC5300 60 PC5400 50	
Ni Base		-	Inconel, Nimonic, Hastelloy	PC5300 55 PC5400 45		
Co Base		-	Stellite	PC5300 25 PC5400 20		
Titanium alloys		-	Pure Ti	PC5300 130 PC5400 105		
			Alloy(TiAl6V4)	PC5300 65 PC5400 55		

## Machining example



### SM45C (HRC22)

**■ Cutting conditions** vc = 283 m/min (1,803<sup>-1</sup>)  
 fz = 1.4 mm/tooth  
 vf = 10,097 mm/min  
 ap = 0.8 mm  
 ae = 35 mm  
 Coolant: Dry, Machining: Copying  
 Machine: Horizontal MCT  
 Overhang of tool: 250 mm

**■ Tools** Insert WNMX130520ZNN-MM (PC3500)  
 Holder HRMDCM13050HR-4

40% Increased productivity  
80% Reduced tool cost

→ In comparing HRMD with our competitor using the same cutting conditions, the cutting speed of HRMD was higher with the same depth of cut (apxae), the cycle time was reduced by 40% and the tool life was increased to over 60%. HRMD is economically more efficient due to the use of 6 cutting-edges compared to EDNW type with positive insert



### STS304

**■ Cutting conditions** vc = 130 m/min (414<sup>-1</sup>)  
 fz = 1.2 mm/tooth  
 vf = 2,981 mm/min  
 ap = 1.0 mm, ae = 80 mm  
 Coolant: Wet, Machining:  
 Facing and Slotting  
 Machine: Vertical MCT  
 Overhang of tool: 250 mm

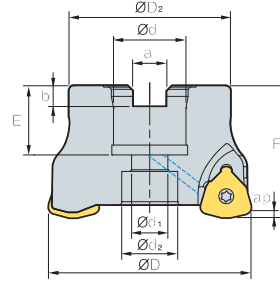
**■ Tools** Insert WNMX130520ZNN-MM (PC3545)  
 Holder HRMDCM13100HR-6

80% Increased productivity  
25% Reduced tool cost

→ In comparing HRMD with our competitor using the same cutting conditions, the cutting speed of HRMD was higher with the same depth of cut (apxae), the cycle time was reduced by 80% and the tool life was same, but HRMD is economically more efficient due to the use of 6 cutting-edges compared to SDKN type with positive insert



# HRMDC(M)09



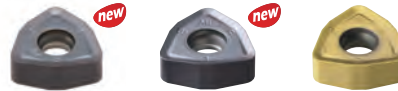
AA  
14°  
• AR: -7°  
• RR: -12°~18°

(mm)

Designation	⚙️	ØD	ØD2	Ød	Ød1	Ød2	a	b	E	F	ap	kg	Bolt	
HRMDCM	09040HR-3	3	40	34	16	9	14	8.4	5.6	19	40	1.5	0.2	SB0825
	09040HR-4	4	40	34	16	9	14	8.4	5.6	19	40	1.5	0.2	
	09050HR-4	4	50	42	22	11	18	10.4	6.3	21	40	1.5	0.3	SB1025
	09050HR-5	5	50	42	22	11	18	10.4	6.3	21	40	1.5	0.3	
	09063HR-5	5	63	49	22	11	18	10.4	6.3	21	40	1.5	0.5	SB1025
	09063HR-6	6	63	49	22	11	18	10.4	6.3	21	40	1.5	0.5	
	09080HR-6	6	80	57	27	14	20	12.4	7	23	50	1.5	1.1	SB1230
	09080HR-7	7	80	57	27	14	20	12.4	7	23	50	1.5	1.1	
09100HR-7	7	100	67	32	18	26	14.4	8	25	50	1.5	1.7	SB1630	
09100HR-8	8	100	67	32	18	26	14.4	8	25	50	1.5	1.7		
HRMDC	09080HR-6	6	80	57	25.4	14	20	9.5	6	24	50	1.5	1.1	SB1230
	09080HR-7	7	80	57	25.4	14	20	9.5	6	24	50	1.5	1.1	
	09080HR-31.75-6	6	80	67	31.75	18	26	12.7	8	32	63	1.5	1.5	SB1630
	09080HR-31.75-7	7	80	67	31.75	18	26	12.7	8	32	63	1.5	1.5	
	09100HR-7	7	100	67	31.75	18	26	12.7	8	32	63	1.5	2.1	SB1630
	09100HR-8	8	100	67	31.75	18	26	12.7	8	32	63	1.5	2.1	

## Available inserts

WNMX-MF      WNMX-ML      WNMX-MM

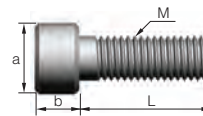


Designation	Cermet		Coated								Uncoated			page				
	CN2500	CN30	NC5330	NCM325	NCM535	NCM545	PC2505	PC2510	PC3700	PC6510	PC9530	PC9540	PC5300		PC5400	ST30A	G10	H01
WNMX 09T316ZNN-MF									●				●	●				E30
09T316ZNN-ML													●	●				
09T316ZNN-MM							●	●	●		●		●	●				

## Available arbors

Designation	NC arbors	
HRMDCM	09040HR-□	BT□□-FMC16-□□ SK□□-FMC16-□□
	09050HR-□	BT□□-FMC22-□□
	09063HR-□	SK□□-FMC22-□□
	09080HR-□	BT□□-FMC27-□□ SK□□-FMC27-□□
	09100HR-□	BT□□-FMC32-□□ SK□□-FMC32-□□
	HRMDC	09080HR-□
09080HR-31.75-□		BT□□-FMA31.75-□□
09100HR-□		SK□□-FMA31.75-□□

## Bolt



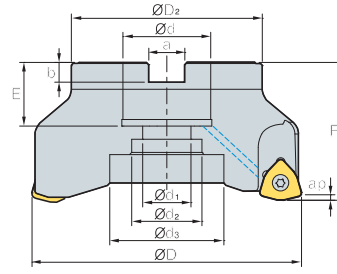
Designation	Dimensions (mm)				
	M	a	b	L	pitch
SB0825	M08	13	8	25	1.25
SB1025	M10	16	10	25	1.5
SB1230	M12	18	12	30	1.75
SB1630	M16	24	16	30	2.0

## Parts

Specification	Screw	Wrench
Ø40-Ø100	FTKA0307	TW09S

Available inserts E30      Available arbors and bolt E426-E428

# HRMDC(M)13



AA  
14°

• AR: -7°  
• RR: -12°~4°

(mm)

Designation	ØD	ØD <sub>2</sub>	Ød	Ød <sub>1</sub>	Ød <sub>2</sub>	Ød <sub>3</sub>	a	b	E	F	ap	$\frac{\rho}{kg}$	Bolt		
HRMDCM	13050HR-3	3	50	42	22	11	17	-	10.4	6.3	21	40	2	0.3	SB1025
	13050HR-4	4	50	42	22	11	17	-	10.4	6.3	21	40	2	0.3	
	13063HR-4	4	63	49	22	11	18	-	10.4	6.3	21	40	2	0.5	SB1025
	13063HR-5	5	63	49	22	11	18	-	10.4	6.3	21	40	2	0.5	
	13080HR-5	5	80	57	27	14	20	-	12.4	7	23	50	2	1	SB1230
	13080HR-6	6	80	57	27	14	20	-	12.4	7	23	50	2	1	
	13100HR-6	6	100	67	32	18	26	-	14.4	8	25	50	2	1.6	SB1630
	13100HR-7	7	100	67	32	18	26	-	14.4	8	25	50	2	1.6	
13125HR-7	7	125	87	40	22	32	52	16.4	9	29	63	2	3.2	SB2040 MBA-M20	
13125HR-8	8	125	87	40	22	32	52	16.4	9	29	63	2	3.2		
HRMDC	13080HR-5	5	80	57	25.4	14	20	-	9.5	6	24	50	2	1	SB1230
	13080HR-6	6	80	57	25.4	14	20	-	9.5	6	24	50	2	1	
	13080HR-31.75-5	5	80	67	31.75	18	26	-	12.7	8	32	63	2	1.4	SB1630
	13080HR-31.75-6	6	80	67	31.75	18	26	-	12.7	8	32	63	2	1.4	
	13100HR-6	6	100	67	31.75	18	26	-	12.7	8	32	63	2	2.1	SB1630
	13100HR-7	7	100	67	31.75	18	26	-	12.7	8	32	63	2	2.1	
	13125HR-7	7	125	87	38.1	22	32	52	15.9	10	35	63	2	3.3	SB2040 MBA-M20
	13125HR-8	8	125	87	38.1	22	32	52	15.9	10	35	63	2	3.3	

## Available inserts

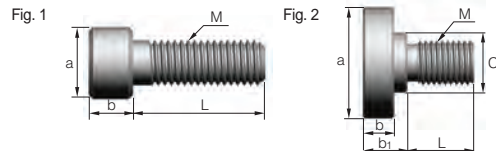


Designation	Cermet		Coated										Uncoated			page		
	CN2500	CN30	NC5330	NCM325	NCM535	NCM545	PC2505	PC2510	PC3700	PC6510	PC9530	PC9540	PC5300	PC5400	ST30A		G10	H01
WNMX 130520ZNN-MF													●	●				E30
130520ZNN-ML													●	●				
130520ZNN-MM													●	●				

## Available arbors

Designation	NC arbors	
HRMDCM	13050HR-□	BT□□-FMC22-□□
		SK□□-FMC22-□□
	13063HR-□	BT□□-FMC22-□□
	13080HR-□	SK□□-FMC27-□□
	13100HR-□	BT□□-FMC32-□□
		SK□□-FMC32-□□
HRMDC	13125HR-□	BT□□-FMC40-□□
		SK□□-FMC40-□□
	13080HR-□	BT□□-FMA25.4-□□
	13080HR-31.75-□	SK□□-FMA25.4-□□
	13100HR-□	BT□□-FMA31.75-□□
		SK□□-FMA31.75-□□
13125HR-□	BT□□-FMA38.1-□□	
	SK□□-FMA38.1-□□	

## Bolt



Designation	Dimensions (mm)							Fig.
	M	a	b	b <sub>1</sub>	C	L	pitch	
SB1025	M10	16	10	-	-	25	1.5	1
SB1230	M12	18	12	-	-	30	1.75	1
SB1630	M16	24	16	-	-	30	2.0	1
SB2040	M20	30	20	-	-	40	2.5	1
MBA-M20	M20	50	14	20	27	30	2.5	2

## Parts

Specification	Screw	Wrench
Ø50~Ø125	FTKA0412B	TW15S

Available inserts E30 Available arbors and bolt E426-E428





# HRMDC(M)16 new

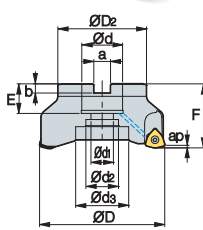


Fig. 1

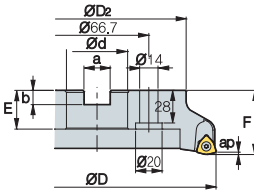


Fig. 2

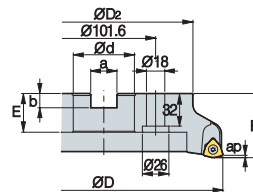


Fig. 3

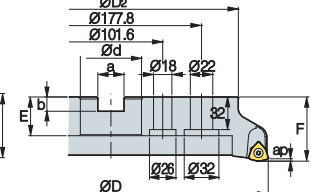


Fig. 4

AA **14°**  
 • AR: -7°  
 • RR: -12°~4°

(mm)

Designation	ØD	ØD2	Ød	Ød1	Ød2	Ød3	a	b	E	F	ap	$\frac{kg}{kg}$	Bolt	Fig.		
HRMDC (HRMDCM)	16080HR-4	4	80	65	25.4 (27)	14	20	-	9.5 (12.4)	6 (7)	25 (23)	50	2.5	0.99	SB1230	1
	16080HR-5	5	80	65	25.4 (27)	14	20	-	9.5 (12.4)	6 (7)	25 (23)	50	2.5	0.91		
	16100HR-5	5	100	85	31.75 (32)	18	26	-	12.7 (14.4)	8	33 (25)	63 (50)	2.5	1.68	SB1630	1
	16100HR-6	6	100	85	31.75 (32)	18	26	-	12.7 (14.4)	8	33 (25)	63 (50)	2.5	1.64		
	16125HR-6	6	125	100	38.1 (40)	22	32	52	15.9 (16.4)	10 (9)	36 (29)	63	2.5	3.23	SB2040 MBA-M20	1
	16125HR-7	7	125	100	38.1 (40)	22	32	52	15.9 (16.4)	10 (9)	36 (29)	63	2.5	3.24		
	16160R-7	7	160	107	50.8 (40)	-	90	-	19 (16.4)	11 (9)	38 (32)	63	2.5	3.73	MBA-M24	2
	16160R-8	8	160	107	50.8 (40)	-	90	-	19 (16.4)	11 (9)	38 (32)	63	2.5	3.77		
	16200R-8	8	200	145	47.625 (60)	-	132	-	25.4 (25.7)	14	38	63	2.5	6.48	-	3
	16200R-10	10	200	145	47.625 (60)	-	132	-	25.4 (25.7)	14	38	63	2.5	6.61	-	3
	16250R-10	10	250	190	47.625 (60)	-	190	-	25.4 (25.7)	14	38	63	2.5	11.01	-	3
	16250R-12	12	250	190	47.625 (60)	-	190	-	25.4 (25.7)	14	38	63	2.5	11.04	-	4
	16315R-12	12	315	250	47.625 (60)	-	238	-	25.4 (25.7)	14	38	63	2.5	18.34	-	4
	16315R-14	14	315	250	47.625 (60)	-	238	-	25.4 (25.7)	14	38	63	2.5	18.35	-	4

( ) Metric size

## Available inserts

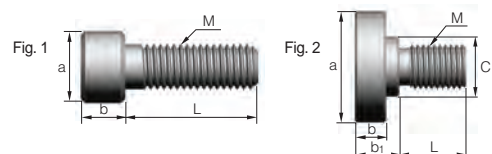


Designation	Cermet		Coated										Uncoated			page		
	CN2500	CN30	NC5330	NCM325	NCM535	NCM545	PC2505	PC2510	PC3700	PC6510	PC9530	PC9540	PC5300	PC5400	ST30A		G10	H01
WNMX 160720ZNN-MF																		E30
160720ZNN-ML																		
160720ZNN-MM																		

## Available arbors

Designation	HRMDC	HRMDCM
HRMDC (HRMDCM) 16080HR-4	BT□□-FMA25.4-□□	BT□□-FMC27-□□
16080HR-5		
16100HR-5	BT□□-FMA31.75-□□	BT□□-FMC32-□□
16100HR-6		
16125HR-6	BT□□-FMA38.1-□□	BT□□-FMB40-□□
16125HR-7		
16160R-7	BT□□-FMA50.8-□□	BT□□-FMC40-□□
16160R-8		
16200R-8		
16200R-10		
16250R-10	BT□□-FMA47.625-□□	BT□□-FMB60-□□
16250R-12		
16315R-12		
16315R-14		

## Bolt



Designation	Dimensions (mm)							Fig.
	M	a	b	b1	C	L	pitch	
SB1025	M10	16	10	-	-	25	1.5	1
SB1230	M12	18	12	-	-	30	1.75	1
SB1630	M16	24	16	-	-	30	2.0	1
SB2040	M20	30	20	-	-	40	2.5	1
MBA-M20	M20	50	14	20	27	30	2.5	2
MBA-M24	M24	65	14	24	37	36	3.0	2

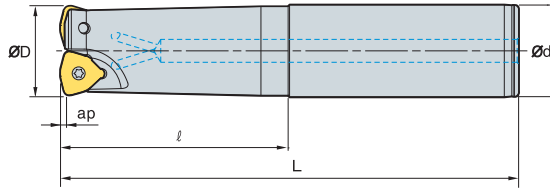
## Parts

Specification		
Ø80-Ø315	FTGA0513-P	TW20-100

Available inserts E30 Available arbors and bolt E426-E428



## HRMDS06 new



AA  
14°

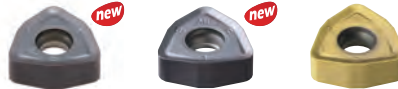
• AR: -7°  
• RR: -17°~25°

(mm)

Designation		ØD	Ød	l	L	ap	
HRMDS 0616HR-2S16	2	16	16	30	110	1.0	0.15
0616HR-2M16	2	16	16	70	150	1.0	0.20
0616HR-2L16	2	16	16	100	200	1.0	0.26
0617HR-2S16	2	17	16	20	110	1.0	0.15
0617HR-2M16	2	17	16	20	150	1.0	0.21
0617HR-2L16	2	17	16	20	200	1.0	0.28
0618HR-2S16	2	18	16	20	110	1.0	0.15
0618HR-2M16	2	18	16	20	150	1.0	0.21
0618HR-2L16	2	18	16	20	200	1.0	0.28
0620HR-2S20	2	20	20	50	130	1.0	0.28
0620HR-2M20	2	20	20	100	180	1.0	0.38
0620HR-2L20	2	20	20	130	250	1.0	0.53
0621HR-2S20	2	21	20	20	130	1.0	0.29
0621HR-2M20	2	21	20	20	180	1.0	0.40
0621HR-2L20	2	21	20	20	250	1.0	0.57
0625HR-3S25	3	25	25	60	140	1.0	0.44
0625HR-3M25	3	25	25	80	180	1.0	0.57
0625HR-3L25	3	25	25	120	250	1.0	0.80
0626HR-3S25	3	26	25	30	140	1.0	0.46
0626HR-3M25	3	26	25	30	180	1.0	0.60
0626HR-3L25	3	26	25	30	250	1.0	0.84
0632HR-4S32	4	32	32	70	150	1.0	0.82
0632HR-4M32	4	32	32	100	200	1.0	1.10
0632HR-4L32	4	32	32	180	300	1.0	1.66
0633HR-4S32	4	33	32	40	200	1.0	1.14
0633HR-4M32	4	33	32	40	250	1.0	1.43
0633HR-4L32	4	33	32	40	300	1.0	1.73

### Available inserts

WNMX-MF      WNMX-ML      WNMX-MM



Designation	Cermet		Coated										Uncoated			page		
	CN2500	CN30	NC5330	NCM325	NCM535	NCM545	PC2505	PC2510	PC3700	PC6510	PC9530	PC9540	PC5300	PC5400	ST30A		G10	H01
WNMX 060312ZNN-MF													●	●				E30
060312ZNN-ML							●	●	●				●	●				
060312ZNN-MM													●	●				

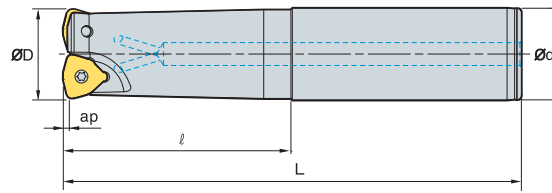
### Parts

Specification		
Ø16~Ø33	ETNA02506	TW07S

Available inserts E30



# HRMDS09



AA  
14°

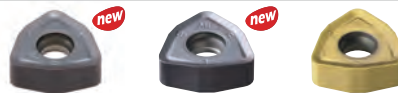
• AR: -7°  
• RR: -17°~25°

(mm)

Designation		ØD	Ød	l	L	ap	
HRMDS	0925HR-2S25	2	25	25	60	140	0.5
	0925HR-2M25	2	25	25	120	200	0.6
	0925HR-2L25	2	25	25	180	300	1
	0926HR-2S25	2	26	25	60	140	0.5
	0926HR-2M25	2	26	25	60	200	0.7
	0926HR-2L25	2	26	25	60	300	1
	0930HR-3S32	3	30	32	70	150	0.8
	0930HR-3M32	3	30	32	120	200	1
	0930HR-3L32	3	30	32	180	300	1.5
	0932HR-3S32	3	32	32	70	150	0.8
	0932HR-3M32	3	32	32	120	200	1.1
	0932HR-3L32	3	32	32	180	300	1.7
	0933HR-3S32	3	33	32	70	150	0.8
	0933HR-3M32	3	33	32	70	200	1.1
	0933HR-3L32	3	33	32	70	300	1.7
	0935HR-4S32	4	35	32	50	150	0.9
	0935HR-4M32	4	35	32	50	200	1.1
	0935HR-4L32	4	35	32	50	300	1.7
	0940HR-4S32	4	40	32	50	150	0.9
	0940HR-4M32	4	40	32	50	250	1.5
0940HR-4L32	4	40	32	50	300	1.8	
0940HR-4S40	4	40	40	60	150	1.3	

## Available inserts

WNMX-MF      WNMX-ML      WNMX-MM



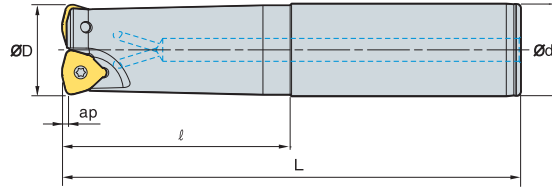
Designation	Cermet		Coated										Uncoated			page		
	CN2500	CN30	NC5330	NCM325	NCM635	NCM645	PC2505	PC2510	PC3700	PC6510	PC9530	PC9540	PC5300	PC5400	ST30A		G10	H01
WNMX 09T316ZNN-MF																		E30
09T316ZNN-ML								●					●	●				
09T316ZNN-MM							●	●	●		●		●	●				

## Parts

Specification		
Ø25~Ø40	FTKA0307	TW09S

Available inserts E30

## HRMDS09



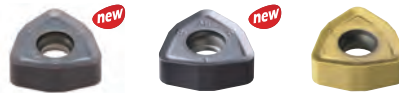
AA  
14°  
• AR: -7°  
• RR: -17°~25°

(mm)

Designation		ØD	Ød	ℓ	L	ap	
HRMDS	0940HR-4M40	4	40	40	130	250	2.2
	0940HR-4L40	4	40	40	180	300	2.7
	0940HR-4S42	4	40	42	60	150	1.4
	0940HR-4M42	4	40	42	130	250	2.3
	0940HR-4L42	4	40	42	180	300	2.8
	0950HR-4S32	4	50	32	40	150	1.1
	0950HR-4M32	4	50	32	40	250	1.6
	0950HR-4L32	4	50	32	40	300	2
	0950HR-4S40	4	50	40	40	150	1.4
	0950HR-4M40	4	50	40	40	250	2.4
	0950HR-4L40	4	50	40	40	300	2.9
	0950HR-4S42	4	50	42	40	150	1.6
	0950HR-4M42	4	50	42	40	250	2.6
	0950HR-4L42	4	50	42	40	300	3.1
	0950HR-5S32	5	50	32	40	150	1.1
	0950HR-5M32	5	50	32	40	250	1.6
	0950HR-5L32	5	50	32	40	300	2
	0950HR-5S40	5	50	40	40	150	1.4
	0950HR-5M40	5	50	40	40	250	2.4
	0950HR-5L40	5	50	40	40	300	2.9
0950HR-5S42	5	50	42	40	150	1.6	
0950HR-5M42	5	50	42	40	250	2.6	
0950HR-5L42	5	50	42	40	300	3.1	

### Available inserts

WNMX-MF      WNMX-ML      WNMX-MM



Designation	Cermet		Coated										Uncoated			page		
	CN2500	CN30	NC5330	NCM325	NCM535	NCM545	PC2505	PC2510	PC3700	PC6510	PC9530	PC9540	PC5300	PC5400	ST30A		G10	H01
WNMX 09T316ZNN-MF																		E30
09T316ZNN-ML																		
09T316ZNN-MM																		

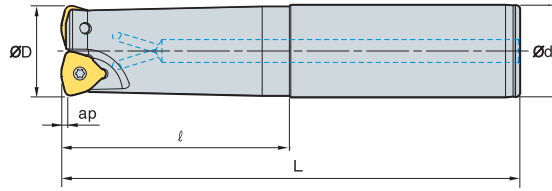
### Parts

Specification		
Ø40~Ø50	FTKA0307	TW09S

Available inserts E30



# HRMDS13



AA  
**14°**

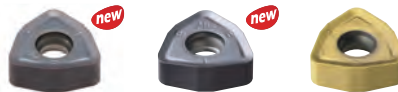
• AR: -7°  
• RR: -14°~16°

(mm)

Designation		ØD	Ød	l	L	ap	
<b>HRMDS</b> 1332HR-2S32	2	32	32	70	150	2	0.8
1332HR-2M32	2	32	32	120	200	2	1
1332HR-2L32	2	32	32	180	300	2	1.6
1333HR-2S32	2	33	32	70	150	2	0.8
1333HR-2M32	2	33	32	70	200	2	1.1
1333HR-2L32	2	33	32	70	300	2	1.7
1335HR-2S32	2	35	32	50	150	2	0.8
1335HR-2M32	2	35	32	50	200	2	1.1
1335HR-2L32	2	35	32	50	300	2	1.7
1340HR-3S32	3	40	32	50	150	2	0.8
1340HR-3M32	3	40	32	50	250	2	1.4
1340HR-3L32	3	40	32	50	300	2	1.7
1340HR-3S40	3	40	40	60	150	2	1.2
1340HR-3M40	3	40	40	130	250	2	2.1
1340HR-3L40	3	40	40	180	300	2	2.6
1340HR-3S42	3	40	42	60	150	2	1.4
1340HR-3M42	3	40	42	130	250	2	2.3
1340HR-3L42	3	40	42	180	300	2	2.7
1350HR-3S32	3	50	32	50	150	2	1.1
1350HR-3M32	3	50	32	50	250	2	1.7
1350HR-3L32	3	50	32	50	300	2	2
1350HR-3S40	3	50	40	50	150	2	1.5
1350HR-3M40	3	50	40	50	250	2	2.4
1350HR-3L40	3	50	40	50	300	2	2.9
1350HR-3S42	3	50	42	50	150	2	1.6
1350HR-3M42	3	50	42	50	250	2	2.6
1350HR-3L42	3	50	42	50	300	2	3.1

## Available inserts

WNMX-MF      WNMX-ML      WNMX-MM



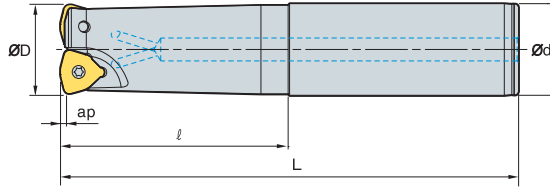
Designation	Cermet		Coated										Uncoated			page		
	CN2500	CN30	NC5330	NCM325	NCM535	NCM545	PC2505	PC2510	PC3700	PC6510	PC9530	PC9540	PC5300	PC5400	ST30A		G10	H01
WNMX 130520ZNN-MF													●	●				E30
130520ZNN-ML													●	●				
130520ZNN-MM							●	●	●		●	●	●	●				

## Parts

Specification		
Ø32~Ø50	FTKA0412B	TW15S

Available inserts E30

## HRMDS13



AA  
14°

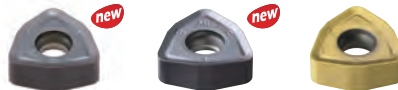
• AR: -7°  
• RR: -14°~16°

(mm)

Designation		ØD	Ød	l	L	ap	
HRMDS	1350HR-4S32	4	50	32	50	150	1.1
	1350HR-4M32	4	50	32	50	250	1.7
	1350HR-4L32	4	50	32	50	300	2
	1350HR-4S40	4	50	40	50	150	1.5
	1350HR-4M40	4	50	40	50	250	2.4
	1350HR-4L40	4	50	40	50	300	2.9
	1350HR-4S42	4	50	42	50	150	1.6
	1350HR-4M42	4	50	42	50	250	2.6
	1350HR-4L42	4	50	42	50	300	3.1
	1363HR-4S32	4	63	32	50	150	1.4
	1363HR-4M32	4	63	32	50	250	2.1
	1363HR-4L32	4	63	32	50	300	2.4
	1363HR-4S40	4	63	40	50	150	1.8
	1363HR-4M40	4	63	40	50	250	2.8
	1363HR-4L40	4	63	40	50	300	3.2
	1363HR-4S42	4	63	42	50	150	1.9
	1363HR-4M42	4	63	42	50	250	3
	1363HR-4L42	4	63	42	50	300	3.5
	1363HR-5S32	5	63	32	50	150	1.5
	1363HR-5M32	5	63	32	50	250	2
1363HR-5L32	5	63	32	50	300	2.3	
1363HR-5S40	5	63	40	50	150	1.8	
1363HR-5M40	5	63	40	50	250	2.8	
1363HR-5L40	5	63	40	50	300	3.2	
1363HR-5S42	5	63	42	50	150	1.9	
1363HR-5M42	5	63	42	50	250	3	
1363HR-5L42	5	63	42	50	300	3.5	

### Available inserts

WNMX-MF      WNMX-ML      WNMX-MM



Designation	Cermet		Coated										Uncoated			page		
	CN2500	CN30	NC5330	NCM325	NCM635	NCM645	PC2505	PC2510	PC3700	PC6510	PC9530	PC9540	PC5300	PC5400	ST30A		G10	H01
WNMX 130520ZNN-MF													●	●				E30
130520ZNN-ML													●	●				
130520ZNN-MM							●	●	●		●	●	●	●				

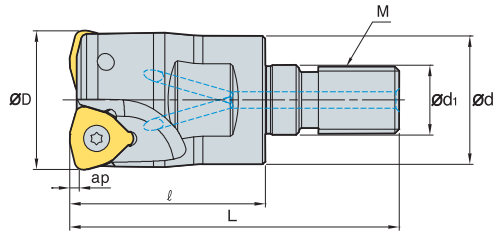
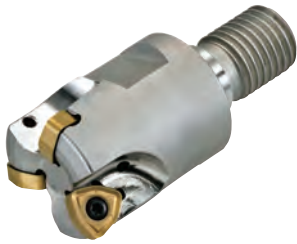
### Parts

Specification		
Ø50~Ø63	FTKA0412B	TW15S

Available inserts E30



# HRMDM06 new

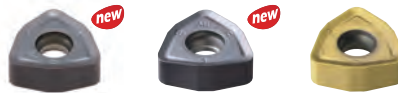


(mm)

Designation		ØD	Ød	Ød <sub>1</sub>	ℓ	L	M	ap	
HRMDM	0616HR-M08	2	16	14.5	8.5	25	M08	1.0	0.03
	0617HR-M08	2	17	14.5	8.5	25	M08	1.0	0.03
	0618HR-M08	2	18	14.5	8.5	25	M08	1.0	0.03
	0620HR-M10	2	20	18	10.5	30	M10	1.0	0.06
	0621HR-M10	2	21	18	10.5	30	M10	1.0	0.07
	0625HR-M12	3	25	23	12.5	35	M12	1.0	0.10
	0626HR-M12	3	26	23	12.5	35	M12	1.0	0.11
	0632HR-M16	4	32	29	17	40	M16	1.0	0.21
	0633HR-M16	4	33	29	17	40	M16	1.0	0.22

## Available inserts

WNMX-MF      WNMX-ML      WNMX-MM



Designation	Cermet		Coated										Uncoated			page		
	CN2500	CN30	NC5330	NCM325	NCM535	NCM545	PC2505	PC2510	PC3700	PC6510	PC9530	PC9540	PC5300	PC5400	ST30A		G10	H01
WNMX 060312ZNN-MF																		E30
060312ZNN-ML																		
060312ZNN-MM							●	●	●		●	●	●	●				

## Available adaptor

Designation	Available adaptor	Designation	Available adaptor
HRMDM	0616HR-M08	HRMDM	0625HR-M12
	0617HR-M08		0626HR-M12
	0618HR-M08		
	0620HR-M10		0632HR-M16
	0621HR-M10		0633HR-M16

Designation : HRMDM0625HR-M12  
 Modular head threading measure size (M12)

II

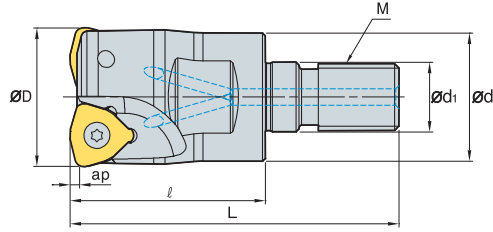
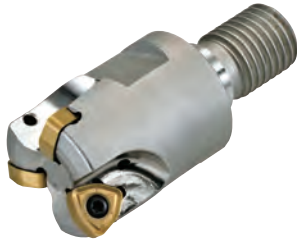
Adaptor spec.: MAT-M12-030-S25S  
 Adaptor threading measure (M12)

## Parts

Specification		
Ø16~Ø33	ETNA02506	TW07S

Available inserts E30      Available adaptor E401-E402

## HRMDM09



AA  
14°

• AR: -7°  
• RR: -18°~25°

(mm)

Designation		ØD	Ød	Ød1	l	L	M	ap	
HRMDM	0925HR-M12	2	25	23	12.5	35	59	M12	0.10
	0926HR-M12	2	26	23	12.5	35	59	M12	0.11
	0930HR-M16	3	30	29	17	40	67	M16	0.19
	0932HR-M16	3	32	29	17	40	67	M16	0.20
	0933HR-M16	3	33	29	17	40	67	M16	0.21
	0935HR-M16	4	35	29	17	40	67	M16	0.22
	0940HR-M16	4	40	29	17	40	67	M16	0.25

### Available inserts



Designation	Cermet		Coated										Uncoated			page		
	CN2500	CN30	NC5330	NCM325	NCM535	NCM545	PC2505	PC2510	PC3700	PC6510	PC9530	PC9540	PC5300	PC5400	ST30A		G10	H01
WNMX	09T316ZNN-MF																	E30
	09T316ZNN-ML																	
	09T316ZNN-MM																	

### Available adaptor

Designation	Available adaptor	
HRMDM	0925HR-M12	MAT- M12
	0926HR-M12	
	0930HR-M16	
	0932HR-M16	MAT- M16
	0933HR-M16	
	0935HR-M16	
	0940HR-M16	

Designation : HRMDM0932HR-M16  
Modular head threading measure size (M16)

II

Adaptor spec.: MAT-M16-035-S32S  
Adaptor threading measure (M16)

### Parts

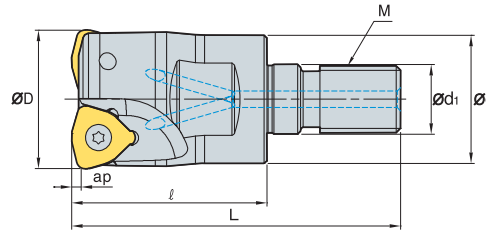
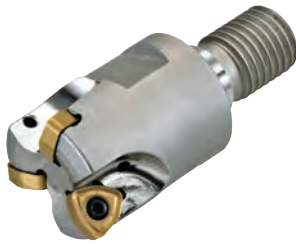
Specification		
Ø25~Ø40	FTKA0307	TW09S

Available inserts E30 Available adaptor E401-E402





# HRMDM13



• AR: -7°  
• RR: -18°~-25°

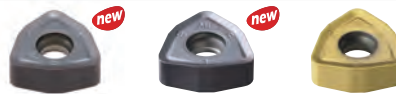
AA  
14°

(mm)

Designation		ØD	Ød	ød1	l	L	M	ap	
HRMDM	1332HR-M16	2	32	29	17	40	M16	2	0.20
	1333HR-M16	2	33	29	17	40	M16	2	0.20
	1335HR-M16	2	35	29	17	40	M16	2	0.22
	1340HR-M16	3	40	29	17	45	M16	2	0.26

## Available inserts

WNMX-MF      WNMX-ML      WNMX-MM



Designation	Cermet		Coated										Uncoated			page		
	CN2500	CN30	NC5330	NCM325	NCM635	NCM645	PC2505	PC2510	PC3700	PC6510	PC9530	PC9540	PC5300	PC5400	ST30A		G10	H01
WNMX	130520ZNN-MF																	E30
	130520ZNN-ML																	
	130520ZNN-MM						●	●	●		●	●	●	●				

## Available adaptor

Designation	Available adaptor
HRMDM 1332HR-M16	MAT-M16
1333HR-M16	
1335HR-M16	
1340HR-M16	

Designation : HRMDM1332HR-M16  
Modular head threading measure size (M16)

II

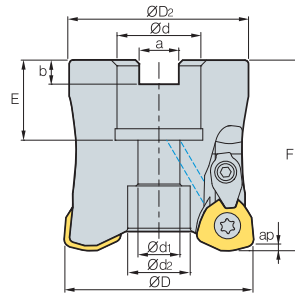
Adaptor spec.: MAT-M16-120-S32T  
Adaptor threading measure (M16)

## Parts

Specification		
Ø32~Ø40	FTKA0412B	TW15S

Available inserts E30      Available adaptor E401-E402

# HRMC(M)13



(mm)

Designation	ØD	ØD <sub>2</sub>	Ød	Ød <sub>1</sub>	Ød <sub>2</sub>	a	b	E	F	ap	kg	Bolt	
HRMC 13050HR-3	3	50	47	22.225 (22)	11	16.4	8.0 (10.4)	5 (6.3)	20 (21)	50	2.0	0.4	SB1035
(HRMCM) 13050HR-4	4	50	47	22.225 (22)	11	16.4	8.0 (10.4)	5 (6.3)	20 (21)	50	2.0	0.4	SB1035
13063HR-4	4	63	60	22.225 (22)	11	17	8.0 (10.4)	5 (6.3)	20 (21)	50	2.0	0.7	SB1035
13080HR-5	5	80	76	31.75 (27)	18 (13)	26 (20)	12.7 (12.4)	8 (7)	32 (23)	70	2.0	1.6	SB16(12)45

( )Metric size

## Available inserts

WDKT-MH

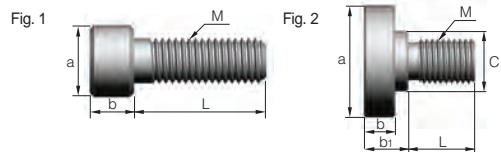


Designation	Cermet		Coated								Uncoated			page				
	CN2500	CN30	NC5330	NCM325	NCM535	NCM545	PC2505	PC2510	PC3700	PC6510	PC9530	PC9540	PC5300		PC5400	ST30A	G10	H01
WDKT 130520ZDSR-MH							●	●	●	●	●		●	●				E29

## Available arbors

Designation	HRMDC	HRMDCM
HRMC 13050HR-3		
(HRMCM) 13050HR-4	BT□□-FMA22.225-□□	BT□□-FMC22-□□
13063HR-4		SK□□-FMC22-□□
13080HR-5	BT□□-FMA31.75-□□	BT□□-FMC27-□□
	SK□□-FMA31.75-□□	SK□□-FMC27-□□

## Bolt



Designation	Dimensions (mm)							Fig.
	M	a	b	b <sub>1</sub>	C	L	pitch	
SB1035	M10	16	10	-	-	35	1.5	1
SB1245	M12	18	12	-	-	45	1.75	1
SB1645	M16	24	16	-	-	45	2.0	1
SB2040	M20	30	20	-	-	40	2.5	1
MBA-M20	M20	50	14	20	27	30	2.5	2
MBA-M24	M24	65	14	24	37	36	3.0	2

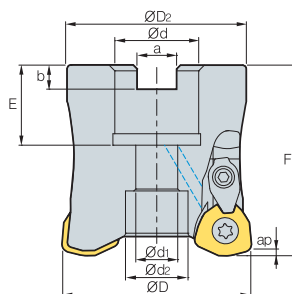
## Parts

Specification	Screw	Clamp	Clamp screw	C-ring	Wrench
Ø50-Ø80	FTGA0513-P	CHH4.5R1	CTX04513H	CR03	TW20-100

Available inserts E29 Available arbors and bolt E426-E428



# HRMC(M)15



(mm)

Designation		ØD	ØD	Ød	Ød1	Ød2	a	b	E	F	ap		Bolt	
<b>HRMC</b>	<b>15063HR-3</b>	3	63	60	22.225 (22)	11	17	8.0 (10.4)	5 (6.3)	20 (21)	50	2.5	0.7	SB1035
<b>(HRMCM)</b>	<b>15080HR-4</b>	4	80	76	31.75 (27)	18 (13)	26 (20)	12.7 (12.4)	8 (7)	32 (23)	70	2.5	1.7	SB16(12)45
	<b>15100HR-5</b>	5	100	96	31.75 (32)	18	26	12.7 (14.4)	8 (8)	32 (26)	70	2.5	2.8	SB1645
	<b>15100HR-6</b>	6	100	96	31.75 (32)	18	26	12.7 (14.4)	8 (8)	32 (26)	70	2.5	3.2	SB1645
	<b>15125HR-6</b>	6	125	98	38.1 (40)	22	32	15.9 (16.4)	10 (9)	35 (29)	63	2.5	3.3	SB2040
	<b>15160R-7</b>	7	160	100	50.8 (40)	-	72	19.0 (16.4)	11 (9)	38 (35)	63	2.5	4.3	MBA-M24(M20)

( ) Metric size

## Available inserts

WDKT-MH

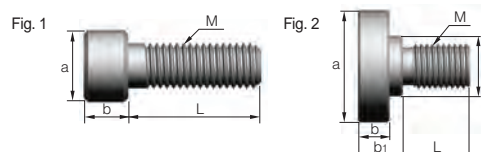


Designation	Cermet		Coated										Uncoated			page		
	CN2500	CN30	NC5330	NCM325	NCM535	NCM545	PC2505	PC2510	PC3700	PC6510	PC9530	PC9540	PC5300	PC5400	ST30A		G10	H01
WDKT 150625ZDSR-MH									●	●	●		●	●				E29

## Available arbors

Designation	HRMDC	HRMDCM
<b>HRMC</b>		
<b>(HRMCM)</b>		
<b>15063HR-3</b>	BT□□-FMA22.225-□□	BT□□-FMC22-□□ SK□□-FMC22-□□
<b>15080HR-4</b>	BT□□-FMA31.75-□□ SK□□-FMA31.75-□□	BT□□-FMC27-□□ SK□□-FMC27-□□
<b>15100HR-5</b>		BT□□-FMC32-□□ SK□□-FMC32-□□
<b>15100HR-6</b>		
<b>15125HR-6</b>	BT□□-FMA38.1-□□ SK□□-FMA38.1-□□	BT□□-FMB40-□□ BT□□-FMC40-□□
<b>15160R-7</b>	BT□□-FMA50.8-□□	SK□□-FMC40-□□

## Bolt



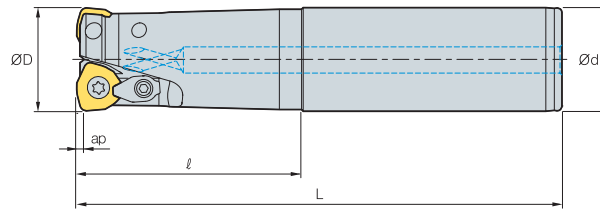
Designation	Dimensions (mm)							Fig.
	M	a	b	b <sub>1</sub>	C	L	pitch	
<b>SB1035</b>	M10	16	10	-	-	35	1.5	1
<b>SB1245</b>	M12	18	12	-	-	45	1.75	1
<b>SB1645</b>	M16	24	16	-	-	45	2.0	1
<b>SB2040</b>	M20	30	20	-	-	40	2.5	1
<b>MBA-M20</b>	M20	50	14	20	27	30	2.5	2
<b>MBA-M24</b>	M24	65	14	24	37	36	3.0	2

## Parts

Specification					
Ø63-Ø160	FTGA0513-P	CHH5.5R1	CTX0515	CR04	TW20-100

Available inserts E29 Available arbors and bolt E426-E428

## HRMS08/10



AA  
15°  
• AR: 7°  
• RR: -11°~5°

(mm)

Designation		ØD	Ød	ℓ	L	ap	
HRMS	0820HR-2S20	2	20	20	50	130	0.3
	0820HR-2M20	2	20	20	100	180	0.4
	0820HR-2L20	2	20	20	130	250	0.5
	0821HR-2S20	2	21	20	50	130	0.3
	0821HR-2M20	2	21	20	50	180	0.4
	0821HR-2L20	2	21	20	50	250	0.5
HRMS	1025HR-2S25	2	25	25	60	140	0.4
	1025HR-2M25	2	25	25	120	200	0.6
	1025HR-2L25	2	25	25	180	300	0.9
	1026HR-2S25	2	26	25	60	140	0.4
	1026HR-2M25	2	26	25	60	200	0.6
	1026HR-2L25	2	26	25	60	300	1.0
	1030HR-2S32	2	30	32	70	150	0.8
	1030HR-2M32	2	30	32	120	200	1.0
	1030HR-2L32	2	30	32	180	300	1.5

### Available inserts

WDKT-MH



Type	Designation	Cermet		Coated										Uncoated			page		
		CN2500	CN30	NC5330	NCM325	NCM535	NCM545	PC2505	PC2510	PC3700	PC6510	PC9530	PC9540	PC5300	PC5400	ST30A		G10	H01
08 type	WDKT 080316ZDSR-MH							●	●	●	●	●	●	●	●				E29
10 type	WDKT 10T320ZDSR-MH							●	●	●	●	●	●	●	●				

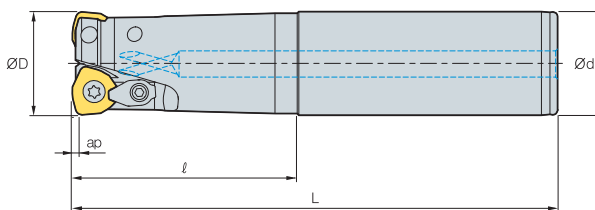
### Parts

Specification					
Ø20~Ø21 (08 type)	FTNA0306	-	-	-	TW09P
Ø25~Ø30 (10 type)	FTKA0408	CHH3.5R1	CTX03510	CR03	TW15S

Available inserts E29



# HRMS13



(mm)

Designation		ØD	Ød	l	L	ap	
HRMS	1332HR-2S32	2	32	32	70	150	0.8
	1332HR-2M32	2	32	32	120	200	1.0
	1332HR-2L32	2	32	32	180	300	1.6
	1333HR-2S32	2	33	32	70	150	0.8
	1333HR-2M32	2	33	32	70	200	1.1
	1333HR-2L32	2	33	32	70	300	1.7
	1335HR-2S32	2	35	32	50	150	0.8
	1335HR-2M32	2	35	32	50	200	1.1
	1335HR-2L32	2	35	32	50	300	1.7
	1340HR-3S32	3	40	32	50	150	0.8
	1340HR-3M32	3	40	32	50	250	1.4
	1340HR-3L32	3	40	32	50	300	1.7
	1340HR-3S40	3	40	40	60	150	1.2
	1340HR-3M40	3	40	40	130	250	2.1
	1340HR-3L40	3	40	40	180	300	2.6
	1340HR-3S42	3	40	42	60	150	1.4
	1340HR-3M42	3	40	42	130	250	2.3
	1340HR-3L42	3	40	42	180	300	2.7

## Available inserts

WDKT-MH



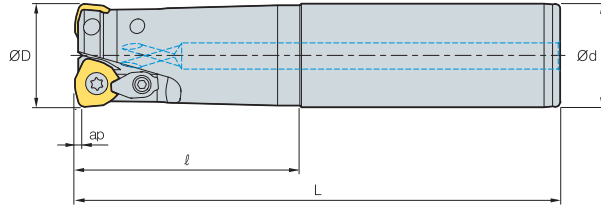
Designation	Cermet		Coated										Uncoated			page		
	CN2500	CN30	NC5330	NCM325	NCM535	NCM545	PC2505	PC2510	PC3700	PC6510	PC9530	PC9540	PC5300	PC5400	ST30A		G10	H01
WDKT 130520ZDSR-MH							●	●		●	●		●	●				E29

## Parts

Specification					
Ø32,33,35	FTGA0510-P	CHH4.5R1	CTX04513H	CR03	TW20
Ø40	FTGA0512-P	CHH4.5R1	CTX04513H	CR03	TW20

Available inserts E29

# HRMS15



AA  
15°  
• AR: 7°  
• RR: -8°~6°

(mm)

Designation		ØD	Ød	l	L	ap	
HRMS	1550HR-3S32	3	50	32	50	150	1.0
	1550HR-3M32	3	50	32	50	250	1.6
	1550HR-3L32	3	50	32	50	300	1.9
	1550HR-3S40	3	50	40	50	150	1.4
	1550HR-3M40	3	50	40	50	250	2.3
	1550HR-3L40	3	50	40	50	300	2.8
	1550HR-3S42	3	50	42	50	150	1.5
	1550HR-3M42	3	50	42	50	250	2.5
	1550HR-3L42	3	50	42	50	300	3.0
	1563HR-4S32	4	63	32	50	150	1.3
	1563HR-4M32	4	63	32	50	250	1.9
	1563HR-4L32	4	63	32	50	300	2.2
	1563HR-4S40	4	63	40	50	150	1.7
	1563HR-4M40	4	63	40	50	250	2.6
	1563HR-4L40	4	63	40	50	300	3.1
	1563HR-4S42	4	63	42	50	150	1.8
	1563HR-4M42	4	63	42	50	250	2.8
	1563HR-4L42	4	63	42	50	300	3.3

## Available inserts

WDKT-MH



Designation	Cermet		Coated										Uncoated			page		
	CN2500	CN30	NC5330	NCM325	NCM635	NCM545	PC2505	PC2510	PC3700	PC6510	PC9530	PC9540	PC5300	PC5400	ST30A		G10	H01
WDKT 150625ZDSR-MH									●	●	●		●	●				E29

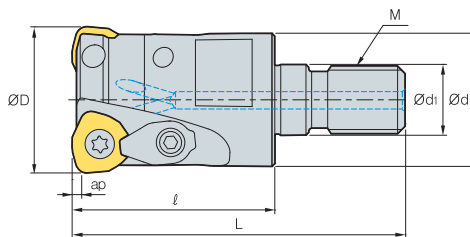
## Parts

Specification					
Ø50-Ø63	FTGA0513-P	CHH5.5R1	CTX0515	CR04	TW20

Available inserts E29



# HRMM08



AA  
15°  
• AR: 7°  
• RR: -11°~5°

(mm)

Designation		ØD	Ød	Ød1	l	L	M	ap	
HRMM	0820HR-M10	2	20	18	10.5	30	M10	1	0.06
	0821HR-M10	2	21	18	10.5	30	M10	1	0.06
	0825HR-M12	3	25	23	12.5	35	M12	1	0.11
	0826HR-M12	3	26	23	12.5	35	M12	1	0.11
	0828HR-M12	3	28	23	12.5	35	M12	1	0.12
	0832HR-M16	4	32	29	17	40	M16	1	0.21
	0833HR-M16	4	33	29	17	40	M16	1	0.21
	0835HR-M16	4	35	29	17	40	M16	1	0.23
	0840HR-M16	5	40	29	17	40	M16	1	0.25

## Available inserts

WDKT-MH



Designation	Cermet		Coated										Uncoated			page		
	CN2500	CN30	NC5330	NCM325	NCM535	NCM545	PC2505	PC2510	PC3700	PC6510	PC9530	PC9540	PC5300	PC5400	ST30A		G10	H01
WDKT 080316ZDSR-MH							●	●	●	●	●		●	●				E29

## Available adaptor

Designation	Available adaptor	
HRMM	0820HR-M10	MAT-M10
	0821HR-M10	
	0825HR-M12	
	0826HR-M12	MAT-M12
	0828HR-M12	
	0832HR-M16	MAT-M16
	0833HR-M16	
	0835HR-M16	
0840HR-M16		

Designation : HRMM0820HR-M10  
Modular head threading measure size (M10)

||

Adaptor spec.: MAT-M10-030-S20S  
Adaptor threading measure (M10)

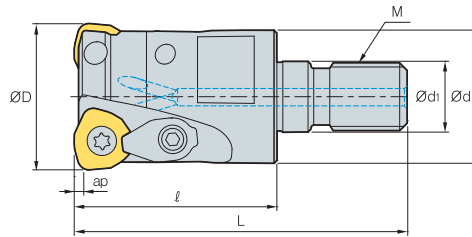
## Parts

Specification						
Ø20~Ø40	FTNA0306	-	-	-	-	-

Available inserts E29 Available adaptor E401-E402



# HRMM10/13



AA **15°** • AR: 7°  
 • RR: -11°~5°

(mm)

Designation		ØD	Ød	Ød1	ℓ	L	M	ap	
HRMM	1025HR-M12	2	25	23	12.5	35	M12	1.5	0.1
	1026HR-M12	2	26	23	12.5	35	M12	1.5	0.1
	1030HR-M16	2	30	29	17	40	M16	1.5	0.2
	1032HR-M16	3	32	29	17	45	M16	1.5	0.26
	1035HR-M16	3	35	29	17	45	M16	1.5	0.23
	1040HR-M16	4	40	29	17	45	M16	1.5	0.27
HRMM	1332HR-M16	2	32	29	17	40	M16	2	0.17
	1333HR-M16	2	33	29	17	40	M16	2	0.17
	1335HR-M16	2	35	29	17	40	M16	2	0.19
	1340HR-M16	3	40	29	17	45	M16	2	0.24

## Available inserts

WDKT-MH



Type	Designation	Cermet		Coated										Uncoated			page		
		CN2500	CN30	NC5330	NCM325	NCM535	NCM545	PC2505	PC2510	PC3700	PC6510	PC9530	PC9540	PC5300	PC5400	ST30A		G10	H01
10 type	WDKT 10T320ZDSR-MH								●	●	●	●		●	●				E29
13 type	WDKT 130520ZDSR-MH							●	●	●	●	●		●	●				

## Available adaptor

Designation	Available adaptor
HRMM 1025HR-M12	MAT-M12
1026HR-M12	
1030HR-M16	MAT-M16
1032HR-M16	
1035HR-M16	
1040HR-M16	
1332HR-M16	MAT-M16
1333HR-M16	
1335HR-M16	
1340HR-M16	

Designation : HRMM1030HR-M16  
Modular head threading measure size (M16)

II

Adaptor spec.: MAT-M16-035-S32S  
Adaptor threading measure (M10)

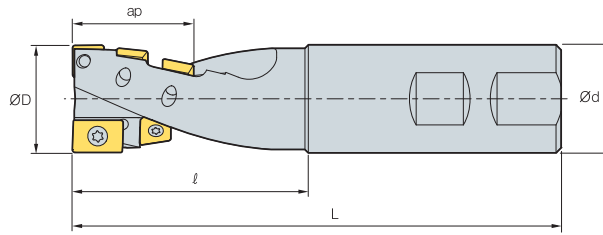
## Parts

Specification						
Ø25~Ø40 (10 type)	FTKA0408	CHH3.5R1	CTX03510	CR03	TW15S	-
Ø32, 33, 35 (13 type)	FTGA0510-P	CHH4.5R1	CTX04513H	CR03	-	TW20
Ø40 (13 type)	FTGA0512-P	CHH5.5R1	CTX04513H	CR03	-	TW20

Available inserts E29 Available adaptor E401-E402



# THE

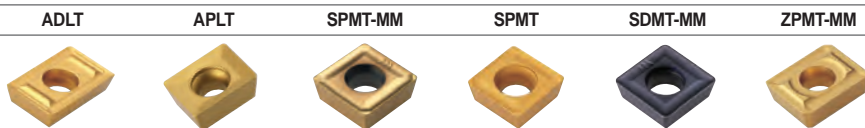


AA  
90°  
• AR: 5°, 10°  
• RR: -5°

(mm)

Designation	ØD	Ød	ℓ	L	ap	No. of flute	kg	Available inserts		
								Lower cutting-edge	External cutting-edge	
THE	25R	25	25	55	120	25	2	0.4	APLT070304R 1z	SPMT060304 4z
	32R	32	32	70	145	40	2	0.5	ADLT150308R 1z	SDMT090308-MM 5z
	40R	40	42	88	175	54	2	1.3	ZPMT1504PPSR-MM 1z	SPMT120408-MM 5z
	50R	50	42	85	175	54	4	1.4	ZPMT1504PPSR-MM 2z	SPMT120408-MM 10z

## Available inserts



Designation	Cermet		Coated										Uncoated			page			
	CN2500	CN30	NCM325	NCM335	NC5330	NCM535	NCM545	PC2505	PC2510	PC3700	PC6510	PC9530	PC9540	PC5300	PC5400		ST30A	G10	H01
SPMT 060304			●																
SDMT 090308-MM										●				●					E04
SPMT 120408-MM										●				●					E05
APLT 070304R														●					E20
ADLT 150308R			●											●					E27
ZPMT 1504PPSR-MM										●				●					E33

## Recommended cutting condition

### • Grooving

Workpiece	Cutting Condition		Grades
	vc (m/min)	fz (mm/t)	
P	90~140	0.05~0.2	PC5300
M	50~90	0.05~0.2	PC5300
K	70~120	0.05~0.25	PC5300

### • Side cutting

Workpiece	Cutting Condition		Grades
	vc (m/min)	fz (mm/t)	
P	150~240	0.05~0.2	PC5300
M	90~150	0.05~0.2	PC5300
K	120~200	0.10~0.25	PC5300

## Parts

Specification	Screw	Wrench	Wrench
Ø25	ETNA02506	TW07P	-
Ø32	ETNA0408	-	TW15S
Ø40	ETNA0511	-	TW20S
Ø50	ETNA0511	-	TW20S

Available inserts E04, E05, E20, E27, E33

# E Technical Information for TP2P

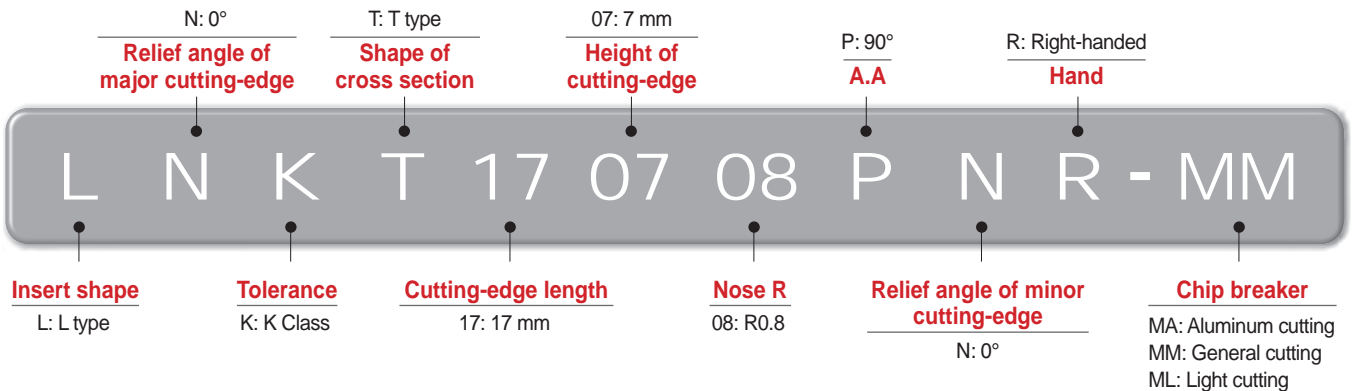
This milling tool series with its tangential clamping system increases stable machining and productivity, while improving perpendicularity

## Tangen-Pro TP2P new

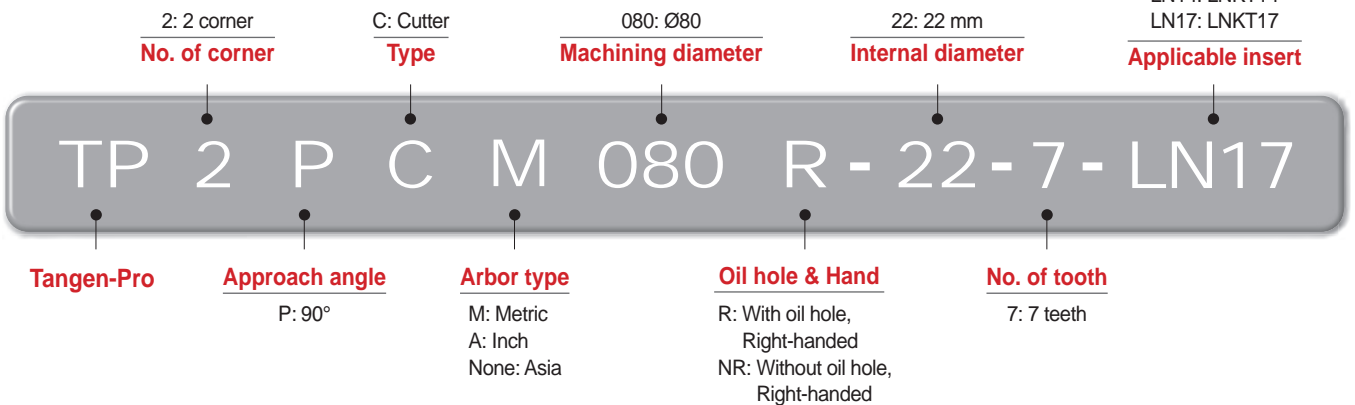
- Clamping stability gained through tangential clamping system and wedge-shaped inserts
- Excellent surface finish nearly perfect perpendicularity, and highly even flank surface compared to competitors' designs
- Improved productivity due to High-rake angles and sharp cutting-edges which lead to lower cutting resistance  
→ Ideally suited for high speed and high feed machining

### Code system

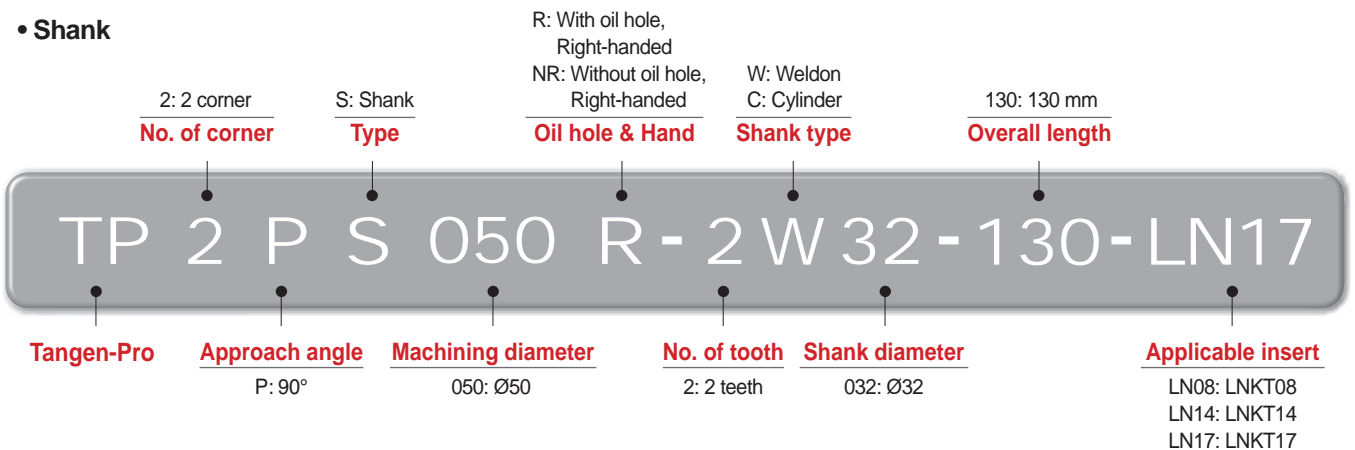
#### • Insert



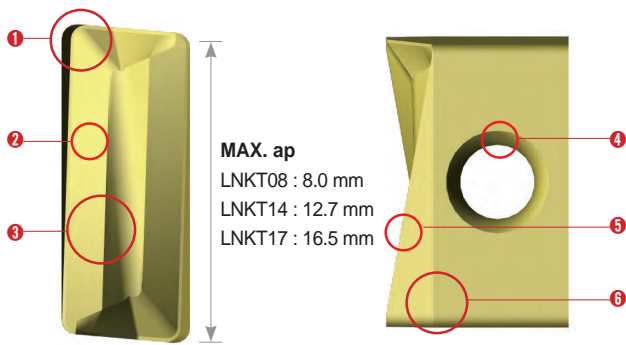
#### • Cutter



#### • Shank



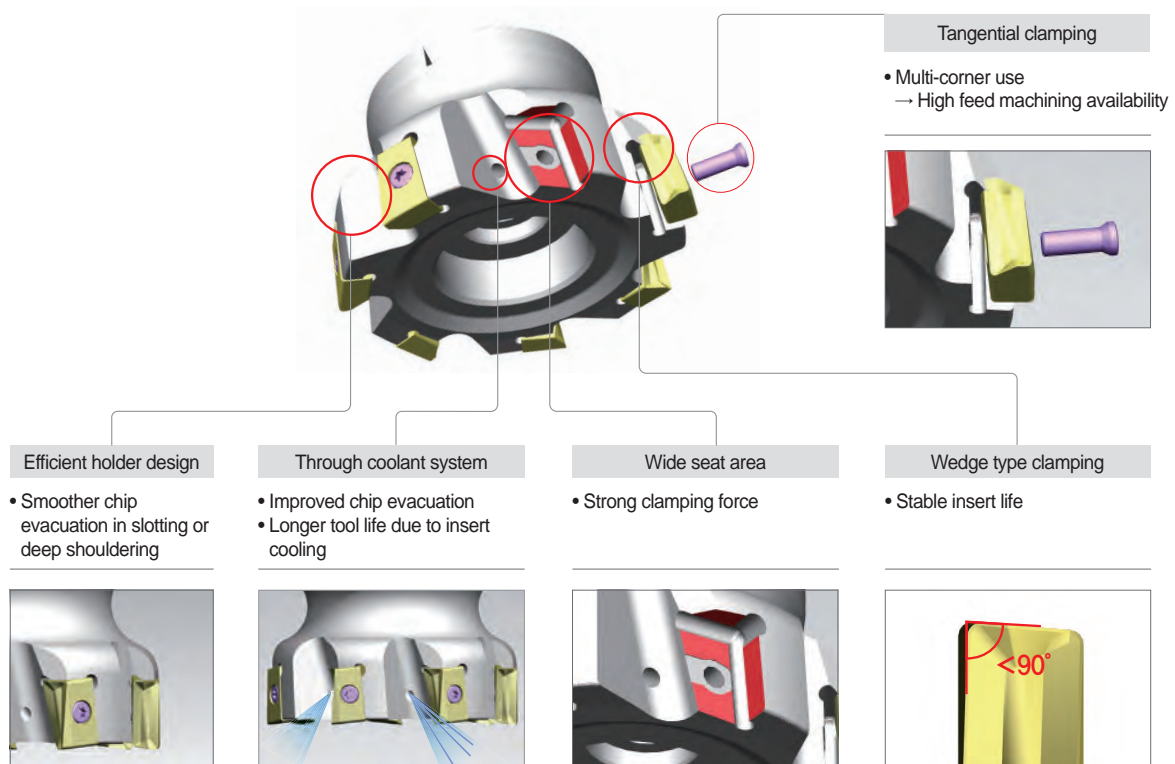
## Features of insert



- 1** Wedge type clamping area
  - Clamping in wedge form on seats  
→ Creates strong clamping force
- 2** High-rake angle chip breaker
  - High-rake angle applied
  - Produces smooth chip flow  
→ Extended insert life
- 3** Convex projection
  - Improved chip evacuation
  - Enhances rigidity
- 4** Side hole (tangential type)
  - Higher clamping stability
- 5** High-rake angle cutting-edges
  - Improves cutting performance while reducing cutting load
- 6** 2-level flank relief surface
  - 1st reverse positive relief surface enhances rigidity
  - 2nd negative relief surface enables stable clamping  
→ Improved chipping resistance and surface finish

## Features of cutter







- Tangential clamping system, wedge-shaped inserts and wide seat area  
→ Higher clamping stability  
→ Lower vibrations and cutting resistance during machining
- Optimized H/D design with curved surface for smooth chip flow  
→ Excellent chip evacuation in ramping or deep shouldering



## Application guideline for grade

Workpiece		P		K	N
		Carbon steel	Alloy steel	Cast iron	Aluminum
Grades	High speed cutting	PC5300	PC5300	PC6510	H01
	General cutting	PC5400	PC5300	PC6510	H01
	Interrupted cutting	PC5400	PC5400	PC5300	H01

## Features of chip breaker

Insert	Cutting-edge	Uses	Features
MA 		Aluminum	Exclusive sharp cutting edge for aluminum machining ensures good chip flow due to surface buffing treatment and high welding resistance.
ML 		Light cutting	Chip breaker design for low cutting resistance that provides excellent tool life and quality surface finishes in light cutting and hard-to-cut materials
MM 		General cutting	Universal design for general shoulder milling operations, highly suitable in most applications

## Recommended cutting condition

### • LNKT08

Workpiece	Grades	vc (m/min)	fz (mm/t)	Max. ap (mm)	Applicable insert
P Steel	PC5300	150~240	0.25~0.05	8.0	LNKT0804□□PNR-MM
	PC5400	130~210	0.25~0.05	8.0	
K Cast iron	PC6510	100~250	0.25~0.05	8.0	LNKT0804□□PNR-ML
	PC5300	100~200	0.25~0.05	8.0	
N Aluminum	H01	500~1000	0.25~0.05	8.0	LNKT0804□□PNR-MA

\* The above data refer to general cutting conditions and can be adjustable to the speed of 300m/min and the feed per tooth of 0.5 mm/t depending on user environment.

### • LNKT14

Workpiece	Grades	vc (m/min)	fz (mm/t)	Max. ap (mm)	Applicable insert
P Steel	PC5300	150~240	0.25~0.05	12.7	LNKT1406□□PNR-MM
	PC5400	130~210	0.25~0.05	12.7	
K Cast iron	PC6510	100~250	0.25~0.05	12.7	LNKT1406□□PNR-ML
	PC5300	100~200	0.25~0.05	12.7	
N Aluminum	H01	500~1000	0.25~0.05	12.7	LNKT1406□□PNR-MA

\* The above data refer to general cutting conditions and can be adjustable to the speed of 300m/min and the feed per tooth of 0.5 mm/t depending on user environment.

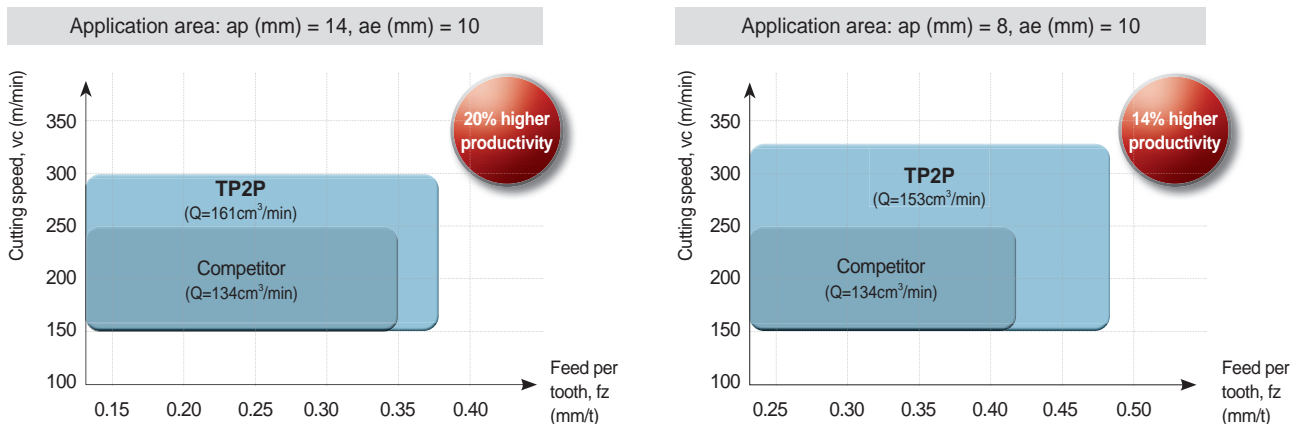
### • LNKT17

Workpiece	Grades	vc (m/min)	fz (mm/t)	Max. ap (mm)	Applicable insert
P Steel	PC5300	150~240	0.25~0.05	16.5	LNKT1707□□PNR-MM
	PC5400	130~210	0.25~0.05	16.5	
K Cast iron	PC6510	100~250	0.25~0.05	16.5	LNKT1707□□PNR-ML
	PC5300	100~200	0.25~0.05	8.0	
N Aluminum	H01	500~1000	0.25~0.05	16.5	LNKT1707□□PNR-MA

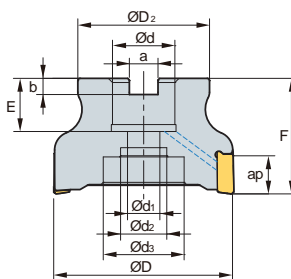
\* The above data refer to general cutting conditions and can be adjustable to the speed of 300m/min and the feed per tooth of 0.5 mm/t depending on user environment.

## Application area

► Higher speed and feed machining than competitor's increases machinability.



# TP2PC(M)-LN08 new



Designation		ØD	ØD2	Ød	Ød1	Ød2	Ød3	a	b	E	F	ap		
TP2PCM	040R-16-6-LN08	6	40	35	16	9	14	-	8.4	5.6	16	40	8.0	0.19
	040R-16-7-LN08	7	40	35	16	9	14	-	8.4	5.6	16	40	8.0	0.19
	050R-22-7-LN08	7	50	41	22	11	18	-	10.4	6.3	20	40	8.0	0.31
	050R-22-10-LN08	10	50	41	22	11	18	-	10.4	6.3	20	40	8.0	0.31
	063R-22-10-LN08	10	63	49	22	11	18	-	10.4	6.3	20	40	8.0	0.49
	063R-22-11-LN08	11	63	49	22	11	18	-	10.4	6.3	20	40	8.0	0.49

## Available inserts

LNKT-MA LNKT-ML LNKT-MM



Designation	Cermet		Coated										Uncoated			page			
	CN2500	CN30	NC5330	NCM325	NCM335	NCM535	NCM545	PC2505	PC2510	PC3700	PC6510	PC9530	PC9540	PC5300	PC5400		ST30A	G10	H01
LNKT	080404PNR-MA																		E11
	080408PNR-MA																		
	080412PNR-MA																		
	080416PNR-MA																		
	080404PNR-ML																		
	080408PNR-ML																		
	080412PNR-ML																		
	080416PNR-ML																		
	080404PNR-MM																		
	080408PNR-MM																		
	080412PNR-MM																		
	080416PNR-MM																		

## Available arbors

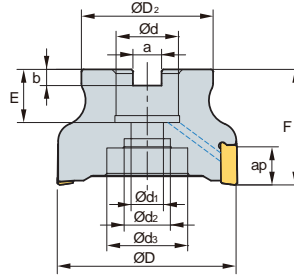
Designation	Available arbors
TP2PCM	
040R-16-6-LN08	
040R-16-7-LN08	BT□□-FMC16-□□
050R-22-7-LN08	
050R-22-10-LN08	
063R-22-10-LN08	BT□□-FMC22-□□
063R-22-11-LN08	

## Parts

Specification		
Ø40~Ø63	FTKA02565S	TW07S

Available inserts E11 Available arbors and bolt E426-E428

# TP2PC(M)-LN14 new



AA **90°**  
 • AR: -6°  
 • RR: -22°~ -12°

(mm)

Designation	ØD	ØD2	Ød	Ød1	Ød2	Ød3	a	b	E	F	ap	kg		
TP2PCM	040R-16-4-LN14	4	40	35	16	9	14	-	8.4	5.6	19	40	12.7	0.19
	040R-16-5-LN14	5	40	35	16	9	14	-	8.4	5.6	19	40	12.7	0.19
	050R-22-5-LN14	5	50	42	22	11	18	-	10.4	6.3	20	40	12.7	0.29
	050R-22-6-LN14	6	50	42	22	11	18	-	10.4	6.3	20	40	12.7	0.29
	063R-22-6-LN14	6	63	49	22	11	18	-	10.4	6.3	20	40	12.7	0.49
	063R-22-8-LN14	8	63	49	22	11	18	-	10.4	6.3	20	40	12.7	0.49
	080R-27-7-LN14	7	80	57	27	14	20	35	12.4	7	23	50	12.7	0.94
	080R-27-10-LN14	10	80	57	27	14	20	35	12.4	7	23	50	12.7	0.94
	100R-32-8-LN14	8	100	70	32	18	28	45	14.4	8	28	63	12.7	1.73
	100R-32-13-LN14	13	100	70	32	18	28	45	14.4	8	28	63	12.7	1.73
	125R-40-9-LN14	9	125	90	40	22	32	54	16.4	9	30	63	12.7	2.98
	125R-40-17-LN14	17	125	90	40	22	32	54	16.4	9	30	63	12.7	3.04
TP2PC	080R-25.4-7-LN14	7	80	57	25.4	14	25	38	9.5	6	25	50	12.7	0.95
	080R-25.4-10-LN14	10	80	57	25.4	14	25	38	9.5	6	25	50	12.7	0.96
	100R-31.75-8-LN14	8	100	70	31.75	18	28	45	12.7	8	32	63	12.7	1.76
	100R-31.75-13-LN14	13	100	70	31.75	18	28	45	12.7	8	32	63	12.7	1.81
	125R-38.1-9-LN14	9	125	90	38.1	22	32	54	15.9	10	35	63	12.7	2.99
	125R-38.1-17-LN14	17	125	90	38.1	22	32	54	15.9	10	35	63	12.7	3.07

## Available inserts

LNKT-MA LNKT-ML LNKT-MM



Designation	Cermets										page	Designation	Cermets										page												
	CN2500	CN30	NC5330	NCM325	NCM335	NCM535	NCM545	PC2505	PC2510	PC3700			PC6510	PC9530	PC9540	PC5300	PC5400	ST30A	H01	CN2500	CN30	NC5330		NCM325	NCM335	NCM535	NCM545	PC2505	PC2510	PC3700	PC6510	PC9530	PC9540	PC5300	PC5400
LNKT 140604PNR-MA																		LNKT 140612PNR-ML																	
LNKT 140608PNR-MA																		LNKT 140616PNR-ML																	
LNKT 140612PNR-MA																		LNKT 140604PNR-MM																	
LNKT 140616PNR-MA																		LNKT 140608PNR-MM																	
LNKT 140604PNR-ML																		LNKT 140612PNR-MM																	
LNKT 140608PNR-ML																		LNKT 140616PNR-MM																	

## Available arbors

Designation	Available arbors
TP2PCM 040R-16-4-LN14	BT□□-FMC16-□□
040R-16-5-LN14	
050R-22-5-LN14	
TP2PCM 050R-22-6-LN14	BT□□-FMC22-□□
063R-22-6-LN14	
063R-22-8-LN14	
TP2PCM 080R-27-7-LN14	BT□□-FMC27-□□
080R-27-10-LN14	

Designation	Available arbors
TP2PCM 100R-32-8-LN14	BT□□-FMC32-□□
100R-32-13-LN14	
125R-40-9-LN14	
TP2PCM 125R-40-17-LN14	BT□□-FMC40-□□
TP2PC 080R-25.4-7-LN14	
TP2PC 080R-25.4-10-LN14	BT□□-FMA25.4-□□
TP2PC 100R-31.75-8-LN14	
TP2PC 100R-31.75-13-LN14	
TP2PC 125R-38.1-9-LN14	BT□□-FMA31.75-□□
TP2PC 125R-38.1-17-LN14	

## Parts

Specification	Screw	Wrench
Ø40 ~ Ø125	FTKA03510	TW15S

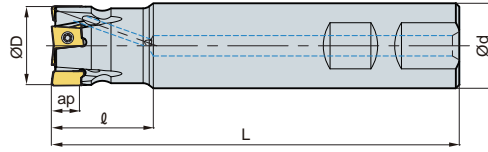
Available inserts E11 Available arbors and bolt E426-E428







# TP2PS-LN08 new



AA  
90°  
• AR: -6°  
• RR: -35°~26°

(mm)

Designation		ØD	Ød	ℓ	L	ap		
TP2PS	020R-2W20-120-LN08	2	20	20	30	120	8.0	0.25
	020R-3W20-120-LN08	3	20	20	30	120	8.0	0.25
	025R-3W25-120-LN08	3	25	25	30	120	8.0	0.39
	025R-4W25-120-LN08	4	25	25	30	120	8.0	0.39

## Available inserts



Designation	Cermet		Coated										Uncoated			page			
	CN2500	CN30	NC5330	NCM325	NCM335	NCM535	NCM545	PC2505	PC2510	PC3700	PC6510	PC9530	PC9540	PC5300	PC5400		ST30A	G10	H01
LNKT	080404PNR-MA																		E11
	080408PNR-MA																		
	080404PNR-ML																		
	080408PNR-ML																		
	080404PNR-MM																		
	080408PNR-MM																		

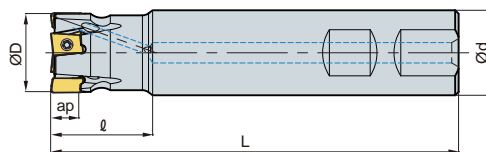
## Parts

Specification		
Ø16-Ø25	FTKA02565S	TW07S

Available inserts E11



# TP2PS-LN14 new



AA  
**90°**  
• AR: -6°  
• RR: -21°~18°

(mm)

Designation		ØD	Ød	l	L	ap	
TP2PS	025R-2W25-130-LN14	2	25	25	40	130	0.41
	032R-3W32-130-LN14	3	32	32	40	130	0.69
	040R-3W32-130-LN14	3	40	32	40	130	0.75
	040R-4W32-130-LN14	4	40	32	40	130	0.76
	050R-4W32-130-LN14	4	50	32	40	130	0.85
	050R-5W32-130-LN14	5	50	32	40	130	0.84

## Available inserts

LNKT-MA LNKT-ML LNKT-MM



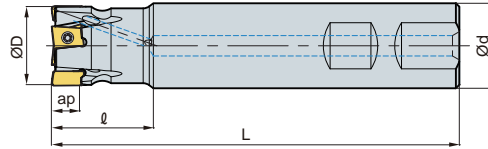
Designation	Cermet		Coated											Uncoated			page		
	CN2500	CN30	NC5330	NCM325	NCM335	NCM535	NCM545	PC2505	PC2510	PC3700	PC6510	PC9530	PC9540	PC5300	PC5400	ST30A		G10	H01
LNKT	140608PNR-MA																		E11
	140608PNR-ML																		
	140608PNR-MM																		

## Parts

Specification		
Ø25 ~ Ø50	FTKA03510	TW15S

Available inserts E11

# TP2PS-LN17 new



AA  
90°  
• AR: -6°  
• RR: -26°~18°

(mm)

Designation		ØD	Ød	ℓ	L	ap	
TP2PS	032R-2W32-130-LN17	2	32	32	40	130	0.68
	032R-3W32-130-LN17	3	32	32	40	130	0.67
	040R-3W32-130-LN17	3	40	32	40	130	0.73
	040R-4W32-130-LN17	4	40	32	40	130	0.73
	050R-4W32-130-LN17	4	50	32	40	130	0.83
	050R-5W32-130-LN17	5	50	32	40	130	0.83

## Available inserts



Designation	Cermet		Coated												Uncoated			page	
	CN2500	CN30	NC5330	NCM325	NCM335	NCM535	NCM545	PC2505	PC2510	PC3700	PC6510	PC9530	PC9540	PC5300	PC5400	ST30A	G10		H01
LNKT 170704PNR-MA																			E11
170708PNR-MA																			
170712PNR-MA																			
170716PNR-MA																			
170720PNR-MA																			
170704PNR-ML																			
170708PNR-ML											●			●	●				
170712PNR-ML																			
170716PNR-ML																			
170720PNR-ML																			
170704PNR-MM																			
170708PNR-MM														●	●				
170712PNR-MM																			
170716PNR-MM																			
170720PNR-MM																			

## Parts

Specification		
Ø32-Ø50	FTKA0412B	TW15S

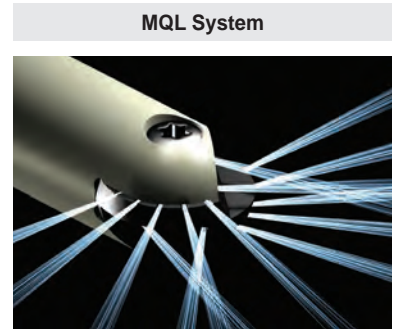
Available inserts E11



Longer tool life guaranteed thanks to the excellent cutting performance of our grades

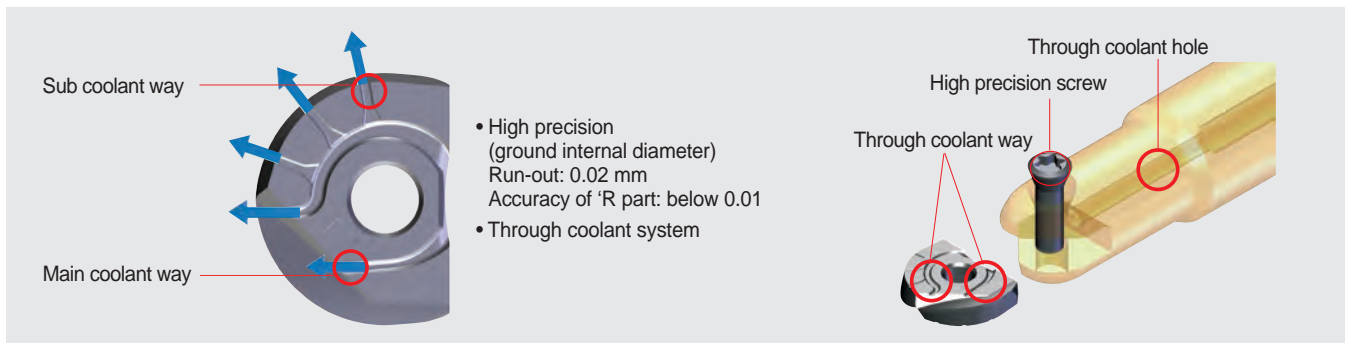
# Laser Mill

- Long tool life has been achieved due to the excellent cutting performance of the insert grade
- Optimum machining of molds has been achieved with the MQL available system
- Easy clamping with simple screw on system
- Various holder line up: steel shank, carbide shank, modular type
- High accuracy indexable endmills for mold finishing



- MQL System**
- Environmental friendly system
  - Decreased coolant cost
  - Lubrication of cutting-edge
  - Improved chip control property
  - Increased tool life & improved surface quality

## Clamping system



## Features



- Six types of inserts are available with one holder
- Single screw for clamping of insert: Easy clamping system
- Various types of holders (Steel shank, Carbide shank, Modular type)
- MQL applicable- environmentally responsible with longer tool life & improved surface quality.

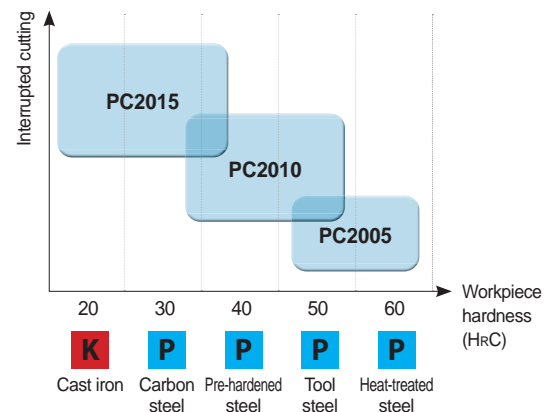
### LBS, LR Order-made items

LBH-Ball	LRH-Corner radius	LFH-High feed	LCF-Chamfer	LBS-Ball type	LR-Corner R type
<ul style="list-style-type: none"> <li>• Helical cutting-edge</li> <li>• Suitable for harder material with high feed</li> </ul>	<ul style="list-style-type: none"> <li>• Helical cutting-edge</li> <li>• Variety of nose-R</li> </ul>	<ul style="list-style-type: none"> <li>• Helical cutting-edge</li> <li>• Suitable for high feed</li> </ul>	<ul style="list-style-type: none"> <li>• Straight cutting-edge</li> <li>• Center drilling and chamfering</li> </ul>	<ul style="list-style-type: none"> <li>• Straight cutting-edge</li> <li>• Suitable for precise</li> </ul>	<ul style="list-style-type: none"> <li>• Straight cutting-edge</li> <li>• Variety of nose-R</li> </ul>

## Features of Laser Mill grades

<b>PC2005</b>	<ul style="list-style-type: none"> <li>• Extremely high hardness grade</li> <li>• The harmony between improved blade design and strong chip breaker</li> <li>• Optimized for machining heat-treated steel and high hardness steel</li> </ul>
<b>PC2010</b>	<ul style="list-style-type: none"> <li>• High wear resistance and excellent toughness</li> <li>• The harmony between excellent thermal shock resistance and strong cutting-edges.</li> <li>• Optimized for machining tool steel and pre-hardened steel</li> </ul>
<b>PC2015</b>	<ul style="list-style-type: none"> <li>• High welding resistance and excellent toughness</li> <li>• The harmony between tough grade and excellent cutting-edge design</li> <li>• Optimized for machining carbon steel</li> </ul>

## Application guideline per workpiece



## Features of KF/KH chip breaker

- KF: Exclusive chip breaker for stable machining of carbon steel with its characteristics of high wear resistance at center part and improved blade design
- KH: Stronger insert with the combination of rake angle and relief angle that are ideal for machining high hardness workpiece

Type	Shape comparison			
<b>Standard</b> (For general cutting)				 SECTION A-A
<ul style="list-style-type: none"> <li>• Proper to general cutting</li> <li>• Insert shape for uniform performance</li> </ul>				
<b>KH</b> (For high hardness steel)				 SECTION A-A
<ul style="list-style-type: none"> <li>• Center shaper proper for machining high hardness workpiece and uniformed tool life at center part</li> <li>• Improved cutting-edge design by higher rake angle (<math>\alpha^\circ</math>)</li> <li>• Lower relief angle (<math>\beta^\circ</math>) increases strength of cutting-edges than universal inserts.</li> </ul>				
<b>KF</b> (For carbon steel)				 SECTION A-A
<ul style="list-style-type: none"> <li>• Smaller chisel improves wear resistance at center for machining carbon steel.</li> <li>• Improved cutting-edge design by higher rake angle (<math>\alpha^\circ</math>)</li> <li>• Longer tool life and better cutting performance with the use of excellent blade design</li> </ul>				

## Recommended cutting condition

Workpiece				Grades	Chip breaker	Recommended cutting conditions				
ISO	Material	HB (HRC)	vc (m/min)			fz (mm/t)	ap (mm)	ae (mm)		
<b>K</b>	Gray cast iron	GC250	180 (8)	PC2015	KF	130~210	0.2~0.5	0.07D	0.07D	
	Ductile cast iron	GCD600	250 (24)	PC2010						
<b>P</b>	Carbon steel	S20C~S50C	150	PC2005	KH	170~250	0.2~0.5	0.07D	0.07D	
	Alloy steel	SCM21~SCM5H	270 (28)							
	Pre-hardened steel		KP4M	300 (32)	PC2010	KH	130~210	0.1~0.3	0.7D	0.7D
			NIMAX	370 (40)	PC2015					
			CENA1	370 (40)	PC210F					
			NAK80	400 (43)						
		STAVAX	510 (52)							
High speed tool steel	SKH51~SKH59	550 (55)			KH	80~130	0.1~0.2	0.3D	0.3D	
Alloy tool steel	STD61 (Hot forging)	630 (60)	PC2005							
	STD11 (Cold forging)		PC2010		70~120	0.1~0.2	0.3D	0.3D		

Overhang	vc (m/min)	fz (mm/t)
Under 3D	100%	100%
3D~5D	70%	70%
5D~8D	60%	60%
8D~10D	50%	50%



## Cutting speed calculation formulas

Practical cutting speed	RPM
-------------------------	-----

$$v_{ce} = \frac{\pi \times D_e \times n}{1000} \text{ (m/min)}$$

$$n = \frac{v_{ce} \times 1000}{\pi \times D_e} \text{ (min}^{-1}\text{)}$$

Feed per tooth	Feed per minute
----------------	-----------------

$$fz = \frac{vf}{z \times n} \text{ (mm/t)}$$

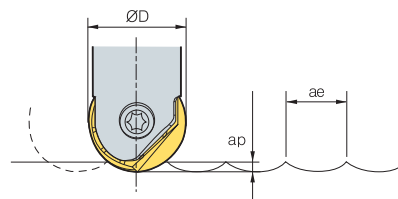
$$vf = fz \times z \times n \text{ (mm/min)}$$

Chip removal amount	Power requirement
---------------------	-------------------

$$Q = \frac{ap \times ae \times vf}{1000} \text{ (cm}^3\text{/min)}$$

$$P_{kw} = \frac{Q \times kc}{60 \times 102 \times \eta} \text{ (kW)}$$

$$P_{hp} = \frac{P_{kw}}{0.75} \text{ (hp)}$$



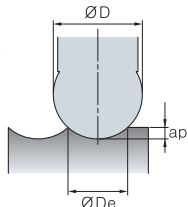
<b>vc</b> = Cutting speed (m/min)	<b>Pkw</b> = Power requirement (kW)
<b>vce</b> = Practical cutting speed (m/min)	<b>Php</b> = Horsepower requirement (hp)
<b>n</b> = Revolution per minute (min <sup>-1</sup> )	<b>Q</b> = Chip removal amount (cm <sup>3</sup> /min)
<b>D</b> = Cutting diameter (mm)	<b>ap</b> = Depth of cut (mm)
<b>De</b> = Actual diameter (mm)	<b>ae</b> = Width of cut (mm)
<b>vf</b> = Feed per minute (mm/min)	<b>kc</b> = Specific cutting resistance (kg/mm <sup>2</sup> )
<b>fz</b> = Feed per tooth (mm/t)	<b>η</b> = Mechanical efficiency (%)
<b>z</b> = Number of tooth	

## Practical cutting speed calculation formulas

1. Formula of actual diameter

• Formula  
: Actual diameter

$$D_e = 2 \sqrt{ap(D - ap)}$$



2. θ°Using: Calculating cutting speed at P point  
(Cutting speed according to depth of cut when ramping)

• Formula  
: Practical cutting speed

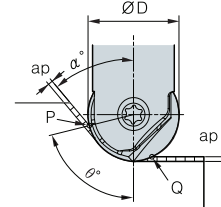
$$v_{ce} = \frac{\pi D \sin \theta \times n}{1000} \text{ (m/min)}$$

$$\theta = \cos^{-1} \left( \frac{D - 2ap}{D} \right) + (90 - \alpha^\circ)$$

3. In case of using ap: Calculating cutting speed at Q point

• Formula  
: Practical cutting speed

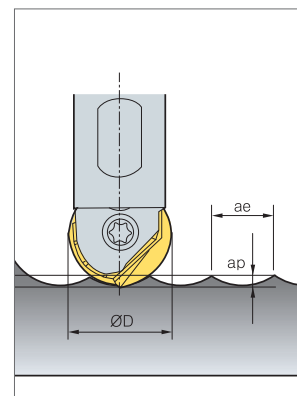
$$v_{ce} = \frac{2\pi n \sqrt{ap(D - ap)}}{1000}$$



## Theoretical surface roughness

		h (surface roughness) (μm)									
ae (mm)	R (mm)	0.1	0.2	0.3	0.4	0.5	0.6	0.7	0.8	0.9	1.0
5	5	0.3	1.0	2.3	4.0	6.3	9.0	12.3	16.0	20.3	25.0
6	6	0.2	0.8	1.9	3.3	5.2	7.5	10.2	13.3	16.9	20.8
8	8	0.2	0.6	1.4	2.5	3.9	5.6	7.7	10.0	12.7	15.6
10	10	0.1	0.5	1.1	2.0	3.1	4.5	6.1	8.0	10.1	12.5
12.5	12.5	0.1	0.4	0.9	1.6	2.5	3.6	4.9	6.4	8.1	10.0
15	15	0.1	0.3	0.8	1.3	2.1	3.0	4.1	5.3	6.8	8.3
16	16	0.1	0.3	0.7	1.3	2.0	2.8	3.8	5.0	6.3	7.8

$$\text{Formula of surface roughness: } h \text{ (surface finish)} = \frac{(ae)^2}{8R} \times 1000 \text{ (}\mu\text{m)}$$



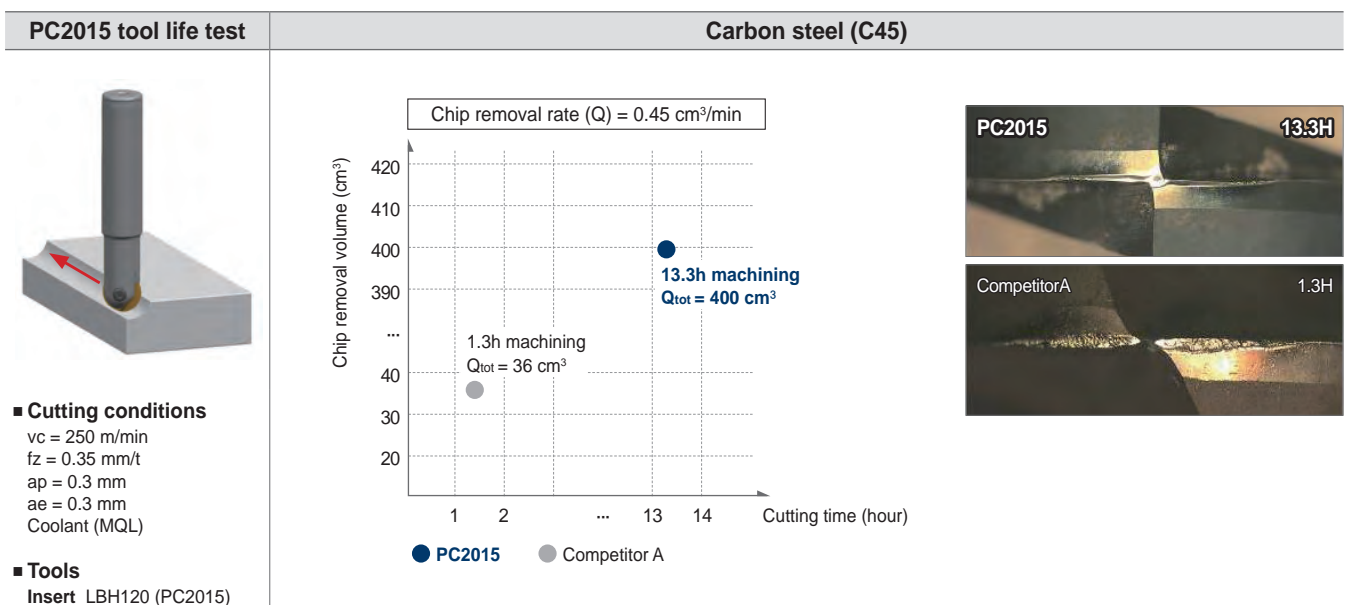
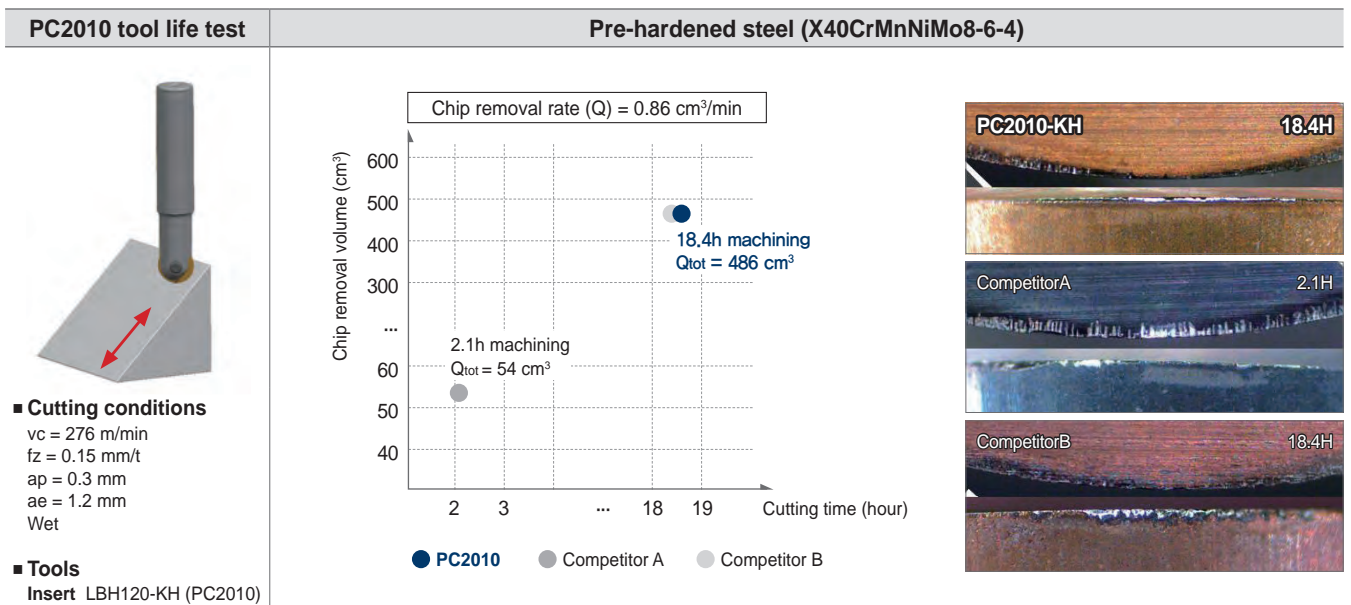
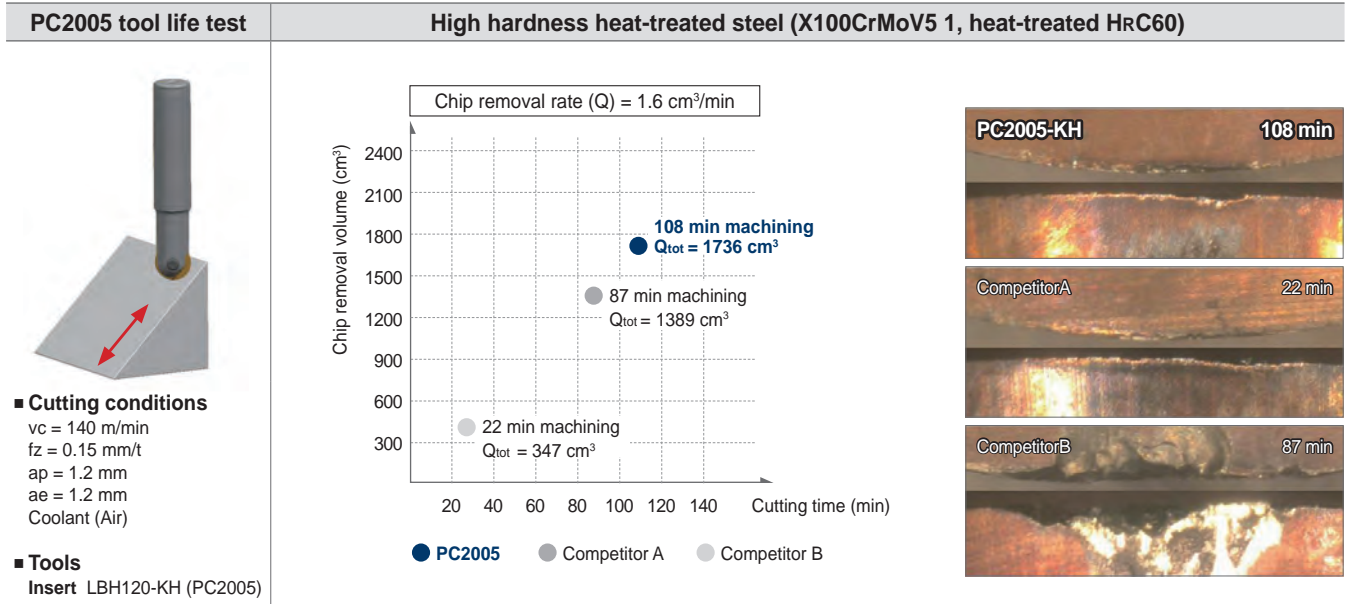
## Actual diameter data

ap	ØD	Ø08	Ø10	Ø12	Ø16	Ø20	Ø25	Ø30	Ø32
0.1		1.8	2.0	2.2	2.5	2.8	3.2	3.5	3.6
0.2		2.5	2.8	3.1	3.6	4.0	4.5	4.9	5.0
0.3		3.0	3.4	3.7	4.3	4.9	5.4	6.0	6.2
0.5		3.9	4.4	4.8	5.6	6.2	7.0	7.7	7.9
1.0		5.3	6.0	6.6	7.7	8.7	9.8	10.8	11.1
1.5		6.2	7.1	7.9	9.3	10.5	11.9	13.1	13.5
2.0		6.9	8.0	8.9	10.6	12.0	13.6	15.0	15.5
2.5		7.4	8.7	9.7	11.6	13.2	15.0	16.6	17.2
3.0		7.7	9.2	10.4	12.5	14.3	16.2	18.0	18.7
3.5		7.9	9.5	10.9	13.2	15.2	17.3	19.3	20.0
4.0		8.0	9.8	11.3	13.9	16.0	18.3	20.4	21.2
5.0				11.8	14.8	17.3	20.0	22.4	23.2
6.0				12.0	15.5	18.3	21.4	24.0	25.0
7.0					15.9	19.1	22.4	25.4	26.5
8.0					16.0	19.6	23.3	26.5	27.7
10.0						20.0	24.5	28.3	29.7





## Performance evaluation



Available inserts

	LBH (Ball type)	LRH (Corner radius type)	LFH (High feed type)	LCF (Chamfer type)	LBS (Ball type)	LR (Corner radius type)
<b>Holders</b>	 R accuracy $\pm 0.005$	 Corner R $\pm 0.015$	 R accuracy $\pm 0.005$	 Corner R $\pm 0.015$		
<b>LBE080</b>	LBH080 LBH090 LBH080-KF LBH090-KF LBH080-KH LBH090-KH				LBS080 LBS090	
<b>LBE100 LRE100</b>	LBH100 LBH110 LBH100-KF LBH110-KF LBH100-KH LBH110-KH	LRH100-R05 LRH100-R10 LRH110-R05 LRH100-R20	LFH100		LBS100 LBS110	LR100-R05 LR100-R20 LR100-R10 LR110-R05
<b>LBE120 LRE120</b>	LBH120 LBH130 LBH120-KF LBH130-KF LBH120-KH LBH130-KH	LRH120-R05 LRH120-R10 LRH130-R05 LRH120-R20	LFH120		LBS120 LBS130	LR120-R05 LR120-R20 LR120-R10 LR130-R05
<b>LBE160 LRE160</b>	LBH160 LBH170 LBH160-KF LBH170-KF LBH160-KH LBH170-KH	LRH160-R05 LRH160-R10 LRH170-R05 LRH160-R20 LRH160-R30	LFH160	LCF160-D90	LBS160 LBS170	LR160-R05 LR160-R30 LR160-R10 LR170-R05 LR160-R20
<b>LBE200 LRE200</b>	LBH200 LBH210 LBH200-KF LBH210-KF LBH200-KH LBH210-KH	LRH200-R05 LRH200-R10 LRH210-R05 LRH200-R20 LRH200-R30	LFH200	LCF200-D90	LBS200 LBS210	LR200-R05 LR200-R30 LR200-R10 LR210-R05 LR200-R20
<b>LBE250 LRE250</b>	LBH250 LBH260 LBH250-KF LBH260-KF LBH250-KH LBH260-KH	LRH250-R05 LRH250-R10 LRH260-R05 LRH250-R20 LRH250-R30	LFH250	LCF250-D90	LBS250 LBS260	LR250-R05 LR250-R30 LR250-R10 LR260-R05 LR250-R20
<b>LBE300 LRE300</b>	LBH300 LBH310 LBH300-KF LBH310-KF LBH300-KH LBH310-KH	LRH300-R10 LRH300-R20 LRH310-R05 LRH300-R30	LFH300		LBS300 LBS310	LR300-R10 LR300-R30 LR300-R20 LR310-R05
<b>LBE320 LRE320</b>	LBH320 LBH330 LBH320-KF LBH330-KF LBH320-KH LBH330-KH	LRH320-R10 LRH330-R10 LRH320-R20 LRH330-R20 LRH320-R30 LRH330-R30	LFH320		LBS320	LR320-R10 LR320-R30 LR320-R20

Available inserts **E08-E10**

\* LBH for general cutting, LBH-KF for carbon steel, and LBH-KH for high hardened steel.



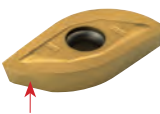

Long tool life due to high hardness grade




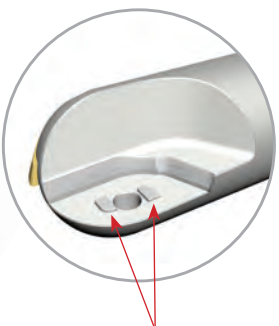
## GBE

- Indexable ball nose endmill for molds in medium & roughing applications
- Long tool life with high hardness grade
- Helical high accuracy cutting-edge
- Optimized mold machining process with our internal coolant system
- Able to adjust to medium processing in middle & big roughing mold process
- Wide variety of holders in normal & long style holders

### Code system

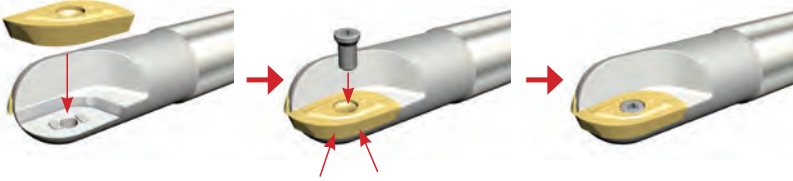


Internal	External	
		<ul style="list-style-type: none"> <li>• High accuracy machining &amp; large depth of cut applications                             <ul style="list-style-type: none"> <li>- Run-out: within 0.05 mm</li> <li>- R accuracy: within 0.05 mm</li> </ul> </li> <li>• Various diameters (Ø16, Ø18, Ø20, Ø22, Ø25, Ø26, Ø28, Ø30, Ø32, Ø40, Ø50)</li> <li>• Minimal cutting resistance due to Helical cutting-edge</li> <li>• Anti-rotation of insert due to concave bottom &amp; stable setting by flank support</li> <li>• Long tool life &amp; better processing due to 2 cutting inserts</li> <li>• Better tool life with new grade</li> </ul>
		
Flank support	Concave bottom	

				<ul style="list-style-type: none"> <li>• Various diameters (Ø16, Ø18, Ø20, Ø22, Ø25, Ø26, Ø28, Ø30, Ø32, Ø40, Ø50)</li> <li>• Improved chip treatment with internal coolant (cutting-edge portion)</li> <li>• Long tool life &amp; better processing</li> <li>• Easy insert setting with projection part to prevent vibration during processing</li> </ul>
Multi-edge type	Single-edge type	Modular type	Projection	

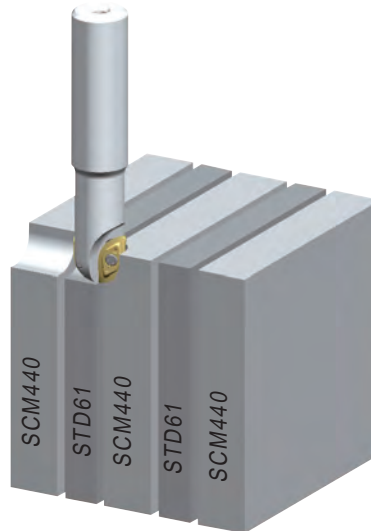
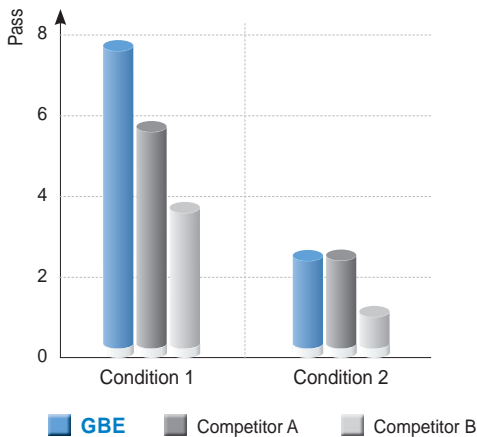


**How to set insert**



1. Set the insert onto the holder projection seat
2. Push the insert into the pocket as shown by red arrows and screw down with wrench

**Performance evaluation**



**Cutting condition**

Class.	Cutting speed (vc)	Feed (fz)	Depth of cut (ap)	Depth of cut (ae)	Workpiece	Etc.
Condition 1	150 m/min	0.15 mm/t	5 mm	8 mm	STD61 (HRC50) + SCM440 (HRC20)	Dry
Condition 2	100 m/min	0.1 mm/t	8 mm	8 mm		

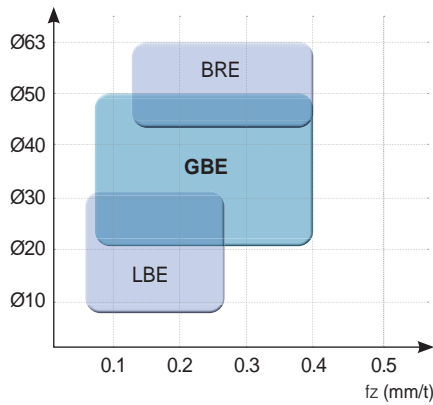
**Inserts/parts**

Type	Insert			Parts			
	Internal I/S	External I/S	External main I/S	Screw		Wrench	
Dia.	Internal I/S	External I/S	External main I/S	Int./Ext. type	Ext. main type	Int./Ext. type	Ext. main type
Ø16	ZPET080M-MM	ZPET080S-MM	-	FTKA02555S	-	TW08S	-
Ø18	ZPET090M-MM	ZPET090S-MM	-	FTKA0307	-	TW09S	-
Ø20	ZPET100M-MM	ZPET100S-MM	SPMT060304	FTKA0307	ETNA02506	TW09S	TW07P
Ø22	ZPET110M-MM	ZPET110S-MM	SPMT060304	FTKA0408	ETNA02506	TW15S	TW07P
Ø25	ZPET125M-MM	ZPET125S-MM	SPMT060304	FTKA0409	ETNA02506	TW15S	TW07P
Ø26	ZPET130M-MM	ZPET130S-MM	SDMT090308-MM	FTKA0409	ETNA0408	TW15S	TW15S
Ø28	ZPET140M-MM	ZPET140S-MM	SDMT090308-MM	FTGA0511-P	ETNA0408	TW20	TW15S
Ø30	ZPET150M-MM	ZPET150S-MM	SDMT090308-MM	FTGA0511-P	ETNA0408	TW20-100	TW15S
Ø32	ZPET160M-MM	ZPET160S-MM	SDMT090308-MM	FTGA0511-P	ETNA0408	TW20-100	TW15S
Ø40	ZPET200M-MM	ZPET200S-MM	SPMT120408-MM	FTGA0614	ETNA0511	TW20-100	TW20S
Ø50	ZPET250M-MM	ZPET250S-MM	SPMT120408-MM	FTGA0818	ETNA0511	TW25S	TW20S

## Recommended cutting condition

Workpiece	Machining type	Hardness (HRC)	vc (m/min)	fz (mm/t)	ap (mm)	ae (mm)
Carbon, Alloy steel	Flank	Under 25	160~250	0.1~0.5	0.3~0.5D	0.2~0.3D
	Groove		120~200	0.1~0.5	0.3~0.5D	-
	Deep flank		160~250	0.1~0.5	1.0~1.5D	0.1~0.2D
Carbon, Alloy steel	Flank	Under 45	120~200	0.1~0.5	0.3~0.5D	0.2~0.3D
	Groove		120~160	0.1~0.5	0.3~0.5D	-
	Deep flank		120~200	0.1~0.5	1.0~1.5D	0.1~0.2D
Mold Alloy steel	Flank	30~40	120~200	0.1~0.3	0.3~0.5D	0.2~0.3D
	Groove		120~160	0.1~0.3	0.3~0.5D	-
	Deep flank		120~200	0.1~0.3	1.0~1.5D	0.1~0.2D
Cast iron (GC, GCD)	Flank	20~30	150~300	0.2~0.7	0.3~0.5D	0.2~0.3D
	Groove		150~300	0.2~0.7	0.3~0.5D	-
	Deep flank		150~300	0.2~0.7	1.0~1.5D	0.1~0.2D
Heat-treated steel	Flank	50~60	40~100	0.1~0.3	0.3~0.5D	0.2~0.3D
	Groove		40~100	0.1~0.3	0.3~0.5D	-
	Deep flank		40~100	0.1~0.3	1.0~1.5D	0.1~0.2D



## Line-up for indexable ball endmill



Type	Application				
	Quality	Machining Efficiency	Machining Dia. Equivalence	Economical	Flank Machining with Long Edge
Laser Mill	●	○	◐	○	○
GBE	◐	●	◐	◐	●
BRE	○	●	●	●	●

●: Very Good ◐: Good ○: Normal

## Test result for wear resistance

Cutting condition		Wear resistance photos			
		GBE	Com.A	Com.B	
 <p><b>Workpiece</b> KP4M (HRC33), Dry</p> <p><b>Condition</b> vc = 280 m/min fz = 0.25 mm/t ap = 5~10 mm ae = 5~10 mm vf = 1,486 mm/min n = 2,971 rpm</p> <p><b>Tool</b> Holder GBE300-S32 Insert ZPET150M-MM (PC3700) ZPET150S-MM (PC3700)</p> <p>Cutting time : 4 Pass</p>	Top	Internal			
		External			
	Flank	Internal			
		External			
 <p><b>Workpiece</b> STD11 (HRC20), Dry</p> <p><b>Condition</b> vc = 250 m/min fz = 0.2 mm/t ap = 5 mm ae = 5 mm vf = 1,062 mm/min n = 2,653 rpm</p> <p><b>Tool</b> Holder GBE300-S32 Insert ZPET150M-MM (PC3700) ZPET150S-MM (PC3700)</p> <p>Cutting time : 4 Pass</p>	Top	Internal			
		External			
	Flank	Internal			
		External			





Better tool life with its anti-breakage special surface treatment

# BRE

- Cutting performance: Good chip control & Superior cutting performance with optimal cutting-edge line
- High rigidity body: Better tool life and special surface treatment to strengthen the holder
  - Easy to set and good durability with TCRX screw
  - Good chip control with our 3D flute design & improved external quality
- Insert: Grade available for high speed & feed applications due to its high wear and breakage resistance providing a stable cutting performance with high cutting-edge toughness and a chip breaker featuring a high rake angle

Multi-edge holder ISO View



- Good chip flow
- Good heat emission

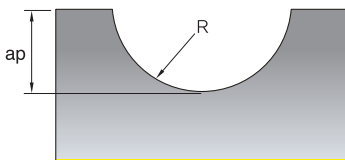


- Wider insert ensures cutting-edge strength
- Better setting force by recess



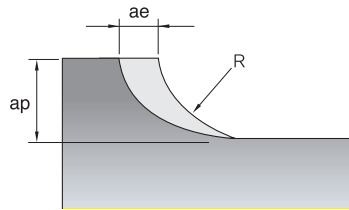
➤ BRE machining type for roughing & Recommended cutting condition

Machining type 1



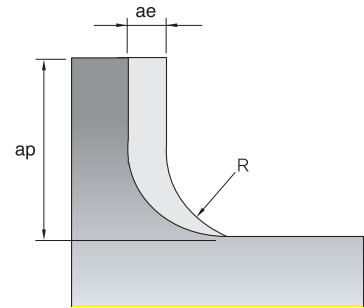
$ap = 0.3D-0.5D$

Machining type 2



$ae = 0.2D-0.3D$     $ap = 0.3D-0.5D$

Machining type 3



$ae = 0.1D-0.5D$     $ap = 1.2D-1.5D$

Workpiece	Machining type	Cutting speed (m/min)	Feed (mm/t)	Grades
Carbon/alloy steel	1	120~220	0.1~0.4	NCM325
	2	120~220	0.2~0.4	NCM325
	3	100~180	0.1~0.3	NCM325
Alloy steel	1	100~200	0.1~0.4	NCM325
	2	100~200	0.2~0.4	NCM325
	3	80~160	0.1~0.3	NCM325
Tool steel	1	80~150	0.1~0.3	NCM325
	2	80~150	0.15~0.35	NCM325
	3	60~120	0.1~0.3	NCM325
High hardness material (HrC35~45)	1	60~120	0.1~0.3	NCM325
	2	60~120	0.1~0.3	NCM325
	3	50~80	0.1~0.2	NCM325
Cast iron	1	100~180	0.2~0.5	NCM325
	2	100~180	0.2~0.5	NCM325
	3	80~160	0.15~0.4	NCM325

# LBE08/10/12/16/20/25/30/32

## Carbide Shank (Ball type)

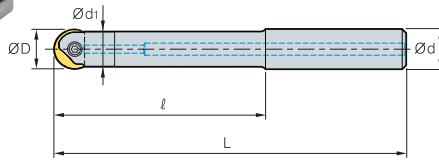


Fig. 1

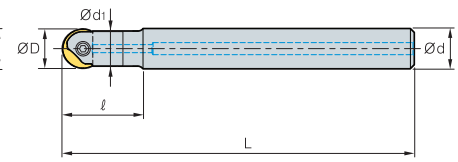


Fig. 2



(mm)

Designation	Dimensions					Parts		Available inserts (Ø)	Fig.
	ØD	Ød	Ød1	ℓ	L	Clamp screw	Wrench		
LBE 080080S-S08C	8, 9	8	7.5	80	136	ETND02506F	TWP07S	8, 9	1
	080100S-S08C	8, 9	8	7.5	100				
080020S-S08C-130	8, 9	8	7.5	20	130	ETND02506F	TWP07S	8, 9	2
080020S-S08C-150	8, 9	8	7.5	20	150				
100080S-S10C	10, 11	10	9.5	80	136	ETND0307F	TWP08S	10, 11	1
100120S-S10C	10, 11	10	9.5	120	176				
100023S-S10C-130	10, 11	10	9.5	23	130	ETND0307F	TWP08S	10, 11	2
100023S-S10C-170	10, 11	10	9.5	23	170				
120100S-S12C	12, 13	12	11.5	100	156	ETND03509	TWP10S	12, 13	1
120150S-S12C	12, 13	12	11.5	150	206				
120025S-S12C-150	12, 13	12	11.5	25	150	ETND03509	TWP10S	12, 13	2
120025S-S12C-200	12, 13	12	11.5	25	200				
160100S-S16C	16, 17	16	15.5	100	160	ETND0413	TWP15S	16, 17	1
160150S-S16C	16, 17	16	15.5	150	210				
160030S-S16C-160	16, 17	16	15.5	30	160	ETND0413	TWP15S	16, 17	2
160030S-S16C-210	16, 17	16	15.5	30	210				
200120S-S20C	20, 21	20	19.5	120	190	ETKD0516	TWP20	20, 21	1
200170S-S20C	20, 21	20	19.5	170	240				
200035S-S20C-190	20, 21	20	19.5	35	190	ETKD0516	TWP20	20, 21	2
200035S-S20C-240	20, 21	20	19.5	35	240				
250140S-S25C	25, 26	25	24.5	140	220	ETKD0620	TWP25	25, 26	1
250170S-S25C	25, 26	25	24.5	170	250				
250040S-S25C-220	25, 26	25	24.5	40	220	ETKD0620	TWP25	25, 26	2
250040S-S25C-250	25, 26	25	24.5	40	250				
300140S-S32C	30, 31	32	29.5	140	230	ETGD0825	TWP40	30, 31	1
300170S-S32C	30, 31	32	29.5	170	260				
300050S-S32C-230	30, 31	32	29.5	50	230	ETGD0825	TWP40	30, 31	2
300050S-S32C-260	30, 31	32	29.5	50	260				
320140S-S32C	32	32	31.5	140	230	ETGD0825	TWP40	32, 33	1
320170S-S32C	32	32	31.5	170	260				
320050S-S32C-230	32	32	31.5	50	230	ETGD0825	TWP40	32, 33	2
320050S-S32C-260	32	32	31.5	50	260				

Available inserts E08-E10

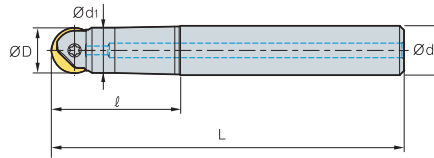




# LBE08/10/12/16/20/25/30/32

## Steel Shank (Ball type)

Taper type



(mm)

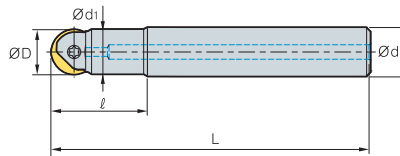
Designation	Dimensions					Parts		Available inserts (Ø)
	ØD	Ød	Ød1	ℓ	L	Clamp screw	Wrench	
LBE 080035T-S12	8, 9	12	7.5	35	91	ETND02506F	TWP07S	8, 9
080055T-S12	8, 9	12	7.5	55	111			
080075T-S12	8, 9	12	7.5	75	131			
100035T-S12	10, 11	12	9.5	35	91	ETND0307F	TWP08S	10, 11
100055T-S12	10, 11	12	9.5	55	111			
100075T-S12	10, 11	12	9.5	75	131			
120055T-S12	12, 13	12	10.4	55	111	ETND03509	TWP10S	12, 13
120085T-S16	12, 13	16	11.5	85	145			
160065T-S16	16, 17	16	14	65	125	ETND0413	TWP15S	16, 17
160100T-S20	16, 17	20	15.5	100	170			
200075T-S20	20, 21	20	17.5	75	145	ETKD0516	TWP20	20, 21
200115T-S25	20, 21	25	19.5	115	195			
250090T-S25	25, 26	25	22	90	170	ETKD0620	TWP25	25, 26
250135T-S32	25, 26	32	24.5	135	225			
300105T-S32	30, 31	32	29.5	105	195	ETGD0825	TWP40	30, 31
300160T-S32	30, 31	32	29.5	160	250			
320105T-S32	32	32	29	105	195	ETGD0825	TWP40	32, 33
320160T-S32	32	32	29	160	250			

Available inserts E08-E10

# LBE12/16/20/25/30/32

## Steel Shank (Ball type)

Straight type



(mm)

Designation	Dimensions					Parts		Available inserts (Ø)
	ØD	Ød	Ød1	ℓ	L	Clamp screw	Wrench	
LBE 120035S-S12	12, 13	12	11.5	35	91	ETND03509	TWP10S	12, 13
160035S-S16	16, 17	16	15.5	35	95	ETND0413	TWP15S	16, 17
200040S-S20	20, 21	20	19.5	40	110	ETKD0516	TWP20	20, 21
250045S-S25	25, 26	25	24.5	40	125	ETKD0620	TWP25	25, 26
300055S-S32	30, 31	32	29.5	55	145	ETGD0825	TWP40	30, 31
320055S-S32	32	32	31.5	55	145	ETGD0825	TWP40	32, 33

Available inserts E08-E10

# LRE10/12/16/20/25/30/32

## Carbide Shank (Corner R type)

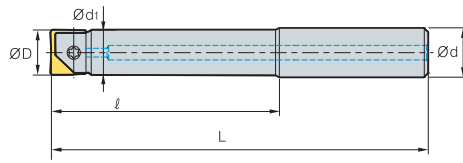


Fig. 1

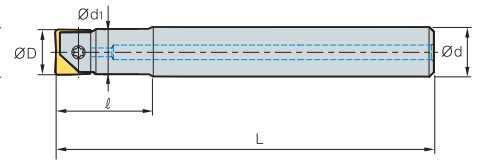


Fig. 2



(mm)

Designation	Dimensions					Parts		Available inserts (Ø)	Fig.
	ØD	Ød	Ød1	ℓ	L	Clamp screw	Wrench		
LRE 100080S-S10C	10, 11	10	9.5	80	136	ETND0307F	TWP08S	10, 11	1
100120S-S10C	10, 11	10	9.5	120	176				
100023S-S10C-130	10, 11	10	9.5	23	130				
100023S-S10C-170	10, 11	10	9.5	23	170	ETND0307F	TWP08S	10, 11	2
120100S-S12C	12, 13	12	11.5	100	156				
120150S-S12C	12, 13	12	11.5	150	206	ETND03509	TWP10S	12, 13	1
120025S-S12C-150	12, 13	12	11.5	25	150				
120025S-S12C-200	12, 13	12	11.5	25	200	ETND03509	TWP10S	12, 13	2
160100S-S16C	16, 17	16	15.5	100	160				
160150S-S16C	16, 17	16	15.5	150	210	ETND0413	TWP15S	16, 17	1
160030S-S16C-160	16, 17	16	15.5	30	160				
160030S-S16C-210	16, 17	16	15.5	30	210	ETND0413	TWP15S	16, 17	2
200120S-S20C	20, 21	20	19.5	120	190				
200170S-S20C	20, 21	20	19.5	170	240	ETKD0516	TWP20	20, 21	1
200035S-S20C-190	20, 21	20	19.5	35	190				
200035S-S20C-240	20, 21	20	19.5	35	240	ETKD0516	TWP20	20, 21	2
250140S-S25C	25, 26	25	24.5	140	220				
250170S-S25C	25, 26	25	24.5	170	250	ETKD0620	TWP25	25, 26	1
250040S-S25C-220	25, 26	25	24.5	40	220				
250040S-S25C-250	25, 26	25	24.5	40	250	ETKD0620	TWP25	25, 26	2
300140S-S32C	30, 31	32	29.5	140	230				
300170S-S32C	30, 31	32	29.5	170	260	ETGD0825	TWP40	30, 31	1
300050S-S32C-230	30, 31	32	29.5	50	230				
300050S-S32C-260	30, 31	32	29.5	50	260	ETGD0825	TWP40	30, 31	2
320140S-S32C	32	32	31.5	140	230				
320170S-S32C	32	32	31.5	170	260	ETGD0825	TWP40	32, 33	1
320050S-S32C-230	32	32	31.5	50	230				
320050S-S32C-260	32	32	31.5	50	260	ETGD0825	TWP40	32, 33	2

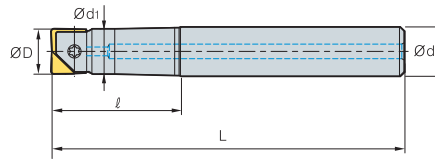
Available inserts E08-E10



# LRE10/12

## Steel Shank (Corner R type)

Taper type



(mm)

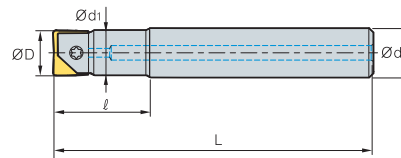
Designation	Dimensions					Parts		Available inserts (Ø)	
	ØD	Ød	Ød1	ℓ	L	Clamp screw	Wrench		
LRE	100025T-S12	10, 11	12	9.5	25	111	ETND0307F	TWP08S	10,11
	100050T-S12	10, 11	12	9.5	50	150			
	120060T-S16	12, 13	16	11.5	60	160	ETND03509	TWP10S	12,13

➔ Available inserts E08-E10

# LRE12/16/25/30/32

## Steel Shank (Corner R type)

Straight type



(mm)

Designation	Dimensions					Parts		Available inserts (Ø)	
	ØD	Ød	Ød1	ℓ	L	Clamp screw	Wrench		
LRE	120030S-S12	12, 13	12	11.5	30	111	ETND03509	TWP10S	12, 13
	160050S-S16	16, 17	16	15.5	50	131			
	160060S-S16	16, 17	16	15.5	60	160	ETND0413	TWP15S	16, 17
	200060S-S20	20, 21	20	19.5	60	145			
	200080S-S20	20, 21	20	19.5	80	180	ETKD0516	TWP20	20, 21
	250070S-S25	25, 26	25	24.5	70	145			
	250100S-S25	25, 26	25	24.5	100	225	ETKD0620	TWP25	25, 26
	300070S-S32	30, 31	32	29.5	70	160			
	300100S-S32	30, 31	32	29.5	100	225	ETGD0825	TWP40	30, 31
	320080S-S32	32	32	31.5	80	160			
320100S-S32	32	32	31.5	100	225	ETGD0825	TWP40	32, 33	

➔ Available inserts E08-E10

## LBE-MHD

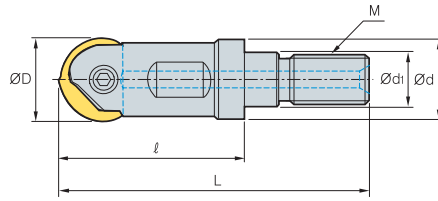


Fig. 1

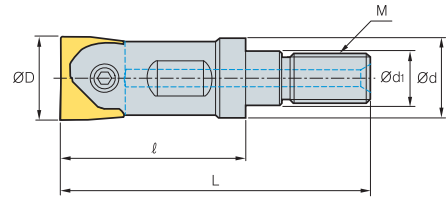


Fig. 2



(mm)

Designation	Dimensions						Parts		Available inserts (Ø)
	M	ØD	L	ℓ	Ød	Ød <sub>1</sub>	Clamp screw	Wrench	
<b>LBE 100-MHD-M06</b>	M06	10, 11	40	25	9.5	6.5	ETND0307F	TWP08S	10, 11
<b>120-MHD-M06</b>	M06	12, 13	40	25	11	6.5	ETND03509	TWP10S	12, 13
<b>160-MHD-M08</b>	M08	16, 17	47	30	14.5	8.5	ETND0413	TWP15S	16, 17
<b>200-MHD-M10</b>	M10	20, 21	56	35	18	10.5	ETKD0516	TWP20	20, 21
<b>250-MHD-M12</b>	M12	25, 26	69	45	22.5	12.5	ETKD0620	TWP25	25, 26
<b>300-MHD-M16</b>	M16	30, 31	77	50	28	17	ETGD0825	TWP40	30, 31
<b>320-MHD-M16</b>	M16	32	77	50	29	17	ETGD0825	TWP40	32, 33

↻ Available inserts **E08-E10** ↻ Available adaptors **E401-E402**

Designation: LBE320-MHD-M16 = Adaptor spec.: MAT-M16-035-S32S  
 Modular head threading measure size (M16) Adaptor threading measure (M16)



# BFE

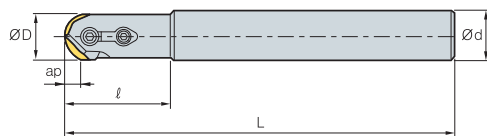


Fig. 1

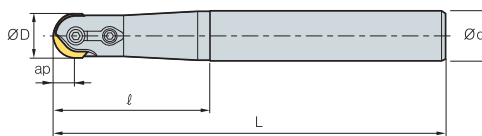


Fig. 2



Designation		ØD	Ød	ℓ	L	ap	/kg	Fig.	Available inserts
BFE	16-S	16	16	36	140	8.0	0.2	1	RC16
	16-M	16	20	65	170	8.0	0.3	2	
	16-L	16	25	65	200	8.0	0.5	2	
	20-S	20	20	45	160	10.0	0.4	1	RC20
	20-M	20	25	80	200	10.0	0.6	2	
	20-L	20	25	80	250	10.0	0.8	2	
	25-S	25	25	45	160	12.5	0.7	1	RC25
	25-M	25	32	90	210	12.5	1.1	2	
	25-L	25	32	90	300	12.5	1.7	2	
	30-S	30	32	65	175	15.0	0.9	2	RC30
	30-M	30	32	100	250	15.0	1.4	2	
	30-L	30	32	100	350	15.0	2.0	2	
32-S	32	32	56	175	16.0	0.9	1	RC32	
32-M	32	32	100	250	16.0	1.4	1		
32-L	32	32	100	350	16.0	2.0	1		

(mm)

## Available inserts

RC		Coated	page
		PC210F	
RC	16	●	E16
	20	●	
	25	●	
	30	●	
	32	●	

## Recommended cutting condition

	Workpiece	Cutting condition	
		vc (m/min)	fz (mm/t)
P	General steel (SS41, SM25C) Over HB180	150 ~ 250	0.10 ~ 0.30
	Alloy steel (SM55C, SCM) Under HB300	100 ~ 200	0.10 ~ 0.20
K	Cast iron Under HB300	100 ~ 200	0.10 ~ 0.30

## Parts

Specification	Screw	Clamp	Clamp screw	Stopper Ring	Wrench
Ø16	FTGA0513	CBH4.5R1	CTX04513	ER03	TW20
Ø20	FTGA0517	CBH4.5R2	CTX04513	ER03	TW20
Ø25	FTGA0621	CBH5R1	CTX0517	ER04	TW20
Ø30, 32	FTGA0826	CBH6R1	CTX0621	ER05	TW25

Available inserts E15



## GBE (Single-edge)

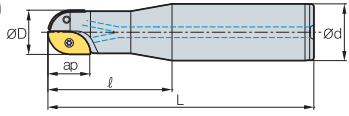


Fig. 1

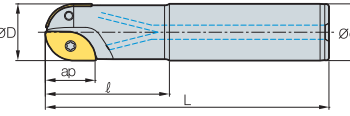


Fig. 2

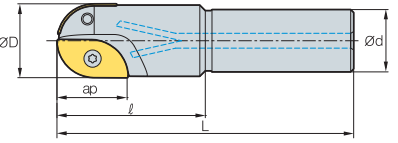


Fig. 3



(mm)

Designation	Dimensions					Available inserts		Parts		Fig.	
	ØD	Ød	ℓ	L	ap	Internal	External	Screw Int./Ext. type	Wrench Ext. main type		
GBE 160-S20	16	20	50	130	15	ZPET080M-MM	ZPET080S-MM	FTKA02555S	TW08S	1	
	160-L20	16	20	90	200	15	ZPET080M-MM	ZPET080S-MM	FTKA02555S		TW08S
	180-S20	18	20	60	130	17	ZPET090M-MM	ZPET090S-MM	FTKA0307		TW09S
	180-L20	18	20	80	200	17	ZPET090M-MM	ZPET090S-MM	FTKA0307		TW09S
	200-S25	20	25	60	140	18	ZPET100M-MM	ZPET100S-MM	FTKA0307		TW09S
	200-L25	20	25	80	250	18	ZPET100M-MM	ZPET100S-MM	FTKA0307		TW09S
	220-S25	22	25	70	140	21	ZPET110M-MM	ZPET110S-MM	FTKA0408		TW15S
	220-L25	22	25	100	250	21	ZPET110M-MM	ZPET110S-MM	FTKA0408		TW15S
	250-S32	25	32	70	150	23	ZPET125M-MM	ZPET125S-MM	FTKA0409		TW15S
	250-L32	25	32	100	300	23	ZPET125M-MM	ZPET125S-MM	FTKA0409		TW15S
	260-S32	26	32	70	150	24.5	ZPET130M-MM	ZPET130S-MM	FTKA0409		TW15S
	260-L32	26	32	100	300	24.5	ZPET130M-MM	ZPET130S-MM	FTKA0409		TW15S
280-S32	28	32	70	150	26	ZPET140M-MM	ZPET140S-MM	FTGA0511-P	TW20	2	
280-L32	28	32	120	300	26	ZPET140M-MM	ZPET140S-MM	FTGA0511-P	TW20		
300-S32	30	32	70	160	27	ZPET150M-MM	ZPET150S-MM	FTGA0511-P	TW20-100		
300-L32	30	32	120	350	27	ZPET150M-MM	ZPET150S-MM	FTGA0511-P	TW20-100		
320-S32	32	32	70	160	28	ZPET160M-MM	ZPET160S-MM	FTGA0511-P	TW20-100		
320-L32	32	32	120	350	28	ZPET160M-MM	ZPET160S-MM	FTGA0511-P	TW20-100		
400-S42	40	42	100	200	37	ZPET200M-MM	ZPET200S-MM	FTGA0614	TW20-100		
400-L42	40	42	150	350	37	ZPET200M-MM	ZPET200S-MM	FTGA0614	TW20-100		
500-S42	50	42	100	200	47	ZPET250M-MM	ZPET250S-MM	FTGA0818	TW25-100		
500-L42	50	42	100	350	47	ZPET250M-MM	ZPET250S-MM	FTGA0818	TW25-100		

Available inserts E33

# GBE-M (Multi-edge)

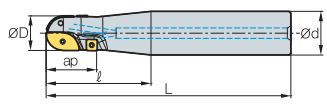


Fig. 1

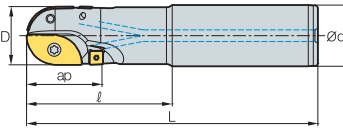


Fig. 2

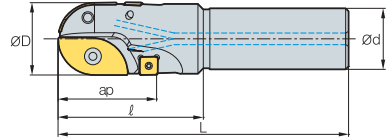


Fig. 3



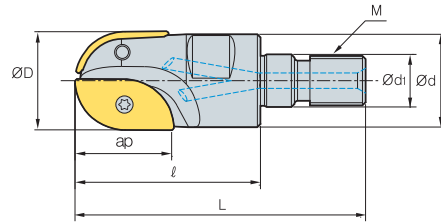
(mm)

Designation	Dimensions					Available inserts			Parts				Fig.	
	ØD	Ød	l	L	ap	Internal	External	Ext. main	Screw		Wrench			
									Int./Ext. type	Ext. main type	Int./Ext. type	Ext. main type		
GBE 200M-S25 200M-L25 220M-S25 220M-L25 250M-S32 250M-L32 260M-S32 260M-L32 280M-S32 280M-L32 300M-S32 300M-L32 320M-S32 320M-L32 400M-S42 400M-L42 500M-S42 500M-L42	20	25	70	150	28	ZPET100M-MM	ZPET100S-MM	SPMT060304	FTKA0307	ETNA02506	TW09S	TW07P	1	
	20	25	70	250	28	ZPET100M-MM	ZPET100S-MM	SPMT060304	FTKA0307	ETNA02506	TW09S	TW07P		
	22	25	80	150	31	ZPET110M-MM	ZPET110S-MM	SPMT060304	FTKA0408	ETNA02506	TW15S	TW07P		
	22	25	80	250	31	ZPET110M-MM	ZPET110S-MM	SPMT060304	FTKA0408	ETNA02506	TW15S	TW07P		
	25	32	80	180	33	ZPET125M-MM	ZPET125S-MM	SPMT060304	FTKA0409	ETNA02506	TW15S	TW07P		
	25	32	80	300	33	ZPET125M-MM	ZPET125S-MM	SPMT060304	FTKA0409	ETNA02506	TW15S	TW07P		
	26	32	80	180	39	ZPET130M-MM	ZPET130S-MM	SDMT090308-MM	FTKA0409	ETNA0408	TW15S	TW15S		
	26	32	80	300	39	ZPET130M-MM	ZPET130S-MM	SDMT090308-MM	FTKA0409	ETNA0408	TW15S	TW15S		
	28	32	80	180	41	ZPET140M-MM	ZPET140S-MM	SDMT090308-MM	FTGA0511-P	ETNA0408	TW20	TW15S		
	28	32	80	300	41	ZPET140M-MM	ZPET140S-MM	SDMT090308-MM	FTGA0511-P	ETNA0408	TW20	TW15S		
	30	32	100	200	41	ZPET150M-MM	ZPET150S-MM	SDMT090308-MM	FTGA0511-P	ETNA0408	TW20-100	TW15S		
	30	32	100	350	41	ZPET150M-MM	ZPET150S-MM	SDMT090308-MM	FTGA0511-P	ETNA0408	TW20-100	TW15S		
	32	32	100	200	42	ZPET160M-MM	ZPET160S-MM	SDMT090308-MM	FTGA0511-P	ETNA0408	TW20-100	TW15S		
	32	32	100	350	42	ZPET160M-MM	ZPET160S-MM	SDMT090308-MM	FTGA0511-P	ETNA0408	TW20-100	TW15S		
	40	42	100	200	56	ZPET200M-MM	ZPET200S-MM	SPMT120408-MM	FTGA0614	ETNA0511	TW20-100	TW20S		2
	40	42	100	350	56	ZPET200M-MM	ZPET200S-MM	SPMT120408-MM	FTGA0614	ETNA0511	TW20-100	TW20S		
50	42	100	200	67	ZPET250M-MM	ZPET250S-MM	SPMT120408-MM	FTGA0818	ETNA0511	TW25-100	TW20S	3		
50	42	100	350	67	ZPET250M-MM	ZPET250S-MM	SPMT120408-MM	FTGA0818	ETNA0511	TW25-100	TW20S			

➔ Available inserts E20, E27, E33



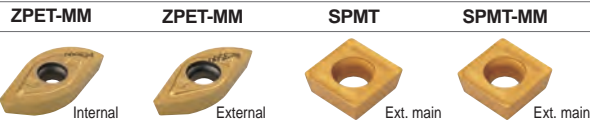
## GBEM



(mm)

Designation	Dimensions							Available inserts		
	ØD	Ød	Ød <sub>1</sub>	l	L	M	ap	Internal	External	
GBEM	160-M08	16	15	8.5	30	47	M08	15	ZPET080M-MM	ZPET080S-MM
	200-M10	20	18.6	10.5	35	56	M10	18	ZPET100M-MM	ZPET100S-MM
	250-M12	25	23.2	12.5	45	69	M12	23	ZPET125M-MM	ZPET125S-MM
	300-M16	30	27.8	17	50	77	M16	27	ZPET150M-MM	ZPET150S-MM
	320-M16	32	29.8	17	50	77	M16	28	ZPET160M-MM	ZPET160S-MM

### Available inserts



Designation	Coated				page	Designation	Coated				page	
	NCM325	PC2510	PC3700	PC5300			NCM325	PC2510	PC3700	PC5300		
SPMT	060304	●			E27	ZPET	080S-MM				E33	
	120408-MM		●	●			090S-MM					
SDMT	090308-MM			●	E20	100S-MM		●	●	●		
ZPET	080M-MM				E33	110S-MM						
	090M-MM					125S-MM		●	●	●		
	100M-MM		●	●		●	130S-MM					
	110M-MM						140S-MM					
	125M-MM		●	●		●	150S-MM			●		●
	130M-MM						160S-MM		●	●		●
	140M-MM						200S-MM			●		
	150M-MM						250S-MM					
	160M-MM		●	●		●						
	200M-MM			●								
250M-MM												

### Parts

Specification	Screw		Wrench	
	Int./Ext. type	Ext. main type	Int./Ext. type	Ext. main type
Ø16	FTKA02555S	-	TW08S	-
Ø18, Ø20	FTKA0307	ETNA02506	TW09S	TW07P
Ø22				
Ø25	FTKA0409	ETNA02506	TW15S	TW07P
Ø30	FTGA0511-P	ETNA0408	TW20-100	TW15S
Ø32	FTGA0511-P	ETNA0408	TW20-100	TW15S

Designation: GBEM320-M16  
Modular head threading measure size (M16)

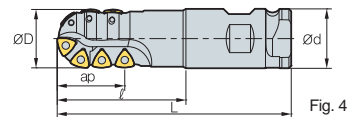
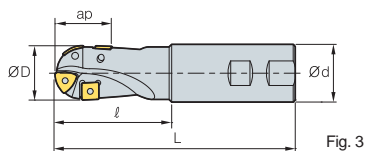
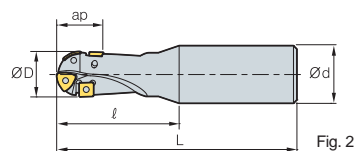
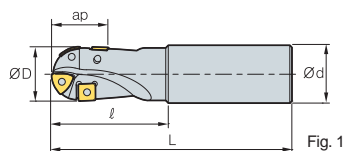
II

Adaptor spec.: MAT-M16-035-S32S  
Adaptor threading measure (M16)

Available inserts E20, E27, E33 Available adaptors E401-E402



# BRE



- AR: 0°-10°
- RR: -3°-0°

Designation	Dimensions					Available inserts		Parts		Fig.		
	ØD	Ød	l	L	ap	Internal	External	Screw	Wrench			
BRE 20R-S	20	20	50	125	20	ZDMT080310R-MM	SPMT060304	ETNA02506	TW07P	0.25	1	
	20R-M	20	20	75	150					0.31		
	20R-L	20	25	100	200					0.57		2
	20R-SL	20	25	65	125					0.33		
25R-S	25	25	70	150	23	ZDMT110312.5R-MM	SPMT060304	ETNA02506	TW07P	0.47	1	
	25R-M	25	25	95	175					0.56		
	25R-L	25	32	100	200					0.92		2
	25R-SL	25	25	75	135					0.41		
32R-S	32	32	85	175	31	ZDMT130416R-MM	SDMT090308-MM	ETNA0408	TW15S	0.87	1	
	32R-M	32	32	100	200					1.02		
	32R-L	32	32	150	250					1.3		3
	32R-SL	32	32	75	150					0.71		




## Available inserts

SPMT ZDMT-R-MM



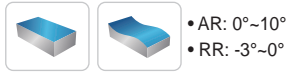
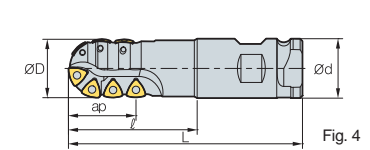
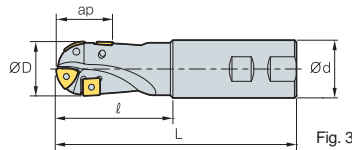
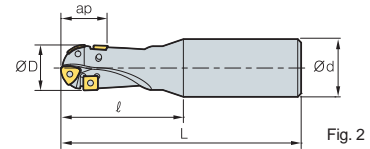
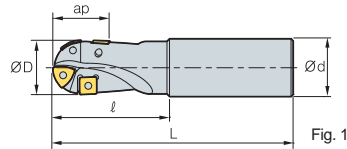
Designation	Coated					page
	NCM325	PC3700	PC5300	PC5400	PC6510	
SPMT 060304	●					E27
ZDMT 080310R-MM		●	●			E33
110312.5R-MM			●			
130416R-MM		●	●			

## Parts

Specification	 Screw	 Wrench	 Wrench
Ø20-Ø25	ETNA02506	-	TW07P
Ø32	ETNA0408	TW15S	-

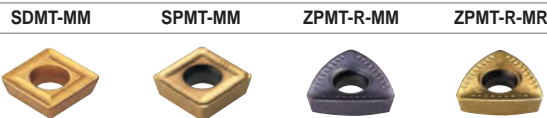
Available inserts E27, E33

## BRE



Designation	Dimensions					Available inserts		Parts		kg	Fig.										
	ØD	Ød	ℓ	L	ap	Main	Ext. main	Screw	Wrench												
BRE	40R-S	40	42	85	175	ZPMT160520R-MM	SPMT120408-MM SPMT120508-MMN	ETNA0511	TW20-100	1.37	1										
	40R-S-40	40	40	85	175							1.35									
	40R-M	40	42	100	200							1.62									
	40R-M-40	40	40	100	200							1.6									
	40R-L	40	42	150	250							2.1									
	40R-L-40	40	40	150	250							2									
	40R-SL	40	42	80	160							1.21									
	40R-SL-40	40	40	80	160							1.2									
	50R-S	50	42	100	200							2.02									
	50R-S-40	50	40	100	200							1.93									
	50R-L	50	42	100	300							3.1									
	50R-L-40	50	40	100	300							2.92									
	50R-SL	50	42	100	250							2.56									
	50R-SL-40	50	40	100	250							2.5									
	63R-S	63	42	100	200	ZPMT160531.5R-MM	SPMT120408-MM SPMT120508-MMN	ETNA0511	TW20-100	2.41	1										
	63R-S-40	63	40	100	200							2.4									
	63R-L	63	42	100	300							3.5									
	63R-L-40	63	40	100	300							3.3									
	63R-SL	63	42	100	250							2.95									
	63R-SL-40	63	40	100	250							2.9									
		40XR-SC40	40	40	110							200	ZPMT160520R-MM	ETNA0511	TW20-100	1.43	4				
		40XR-LC40	40	40	150							250	1.89								
		50XR-SC50.8	50	50.8	110							200	ZPMT160525R-MM ZPMT160525R-MR					ETNA0511	TW20-100	2.34	4
		50XR-LC50.8	50	50.8	150							250	3.06								

### Available inserts



Designation	Coated					page
	NCM325	PC3700	PC5300	PC5400	PC6510	
SDMT 090308-MM		●	●			E20
SPMT 120408-MM		●	●			E27
SPMT 120508-MMN						
ZPMT 160520R-MM		●	●			E33
ZPMT 160525R-MM		●	●			
ZPMT 160525R-MR			●			
ZPMT 160531.5R-MM			●			

### Parts

Specification	Screw	Wrench
Ø40~Ø63	ETNA0511	TW20-100

Available inserts E20, E27, E33



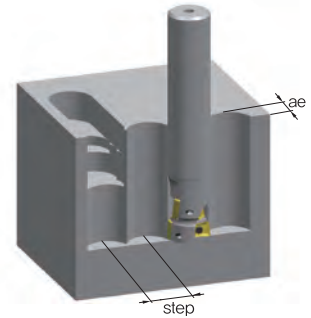
Multifunctional milling tool for mold making

# HAVE

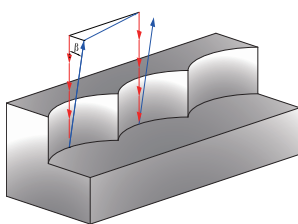
- Tools for Z-axis feed plunge machining to cut faster and more effectively in vertical machining
- Able to utilize the full diameter of the tools, thanks to the position and design of the inserts

## Maximum step in vertical machining

ae	Diameter										
	16	17	20	21	25	26	32	33	35	40	50
	max step (mm)										
1	7.7	8	8.7	8.9	9.7	10	11.1	11.3	11.6	12.4	14
2	10.5	10.9	12	12.3	13.5	13.8	15.4	15.7	16.2	17.4	19.5
3	12.4	12.9	14.2	14.6	16.2	16.6	18.6	18.9	19.5	21	23.7
4	13.8	14.4	16	16.4	18.3	18.7	21.1	21.5	22.2	24	27.1
5	14.8	15.4	17.3	17.8	20	20.4	23.2	23.6	24.4	26.4	30
6	15.4	16.2	18.3	18.9	21.3	21.9	24.9	25.4	26.3	28.5	32.4
7	15.8	16.7	19	19.7	22.4	23	26.4	26.9	28	30.3	34.6
8	16	16.9	19.5	20.3	23.3	24	27.7	28.2	29.3	32	36.6
9	15.8	16.9	19.9	20.7	24	24.7	28.7	29.3	30.5	33.4	38.4
10	15.4	16.7	20	20.9	24.4	25.2	29.6	30.3	31.6	34.6	40
11	14.8	16.2	19.9	20.9	24.8	25.6	30.3	31.1	32.4	35.7	41.4
12	13.8	15.4	19.5	20.7	24.9	25.9	30.9	31.7	33.2	36.6	42.7
13	12.4	14.4	19	20.3	24.9	26	31.4	32.2	33.8	37.4	43.8
14	10.5	12.9	18.3	19.7	24.8	25.9	31.7	32.6	34.2	38.1	44.9
15	7.7	10.9	17.3	18.9	24.4	25.6	31.9	32.8	34.6	38.7	45.8
16	-	8	16	17.8	24	25.2	32	32.9	34.8	39.1	46.6
17	-	-	14.2	16.4	23.3	24.7	31.9	32.9	34.9	39.5	47.3
18	-	-	12	14.6	22.4	24	31.7	32.8	34.9	39.7	48
19	-	-	8.7	12.3	21.3	23	31.4	32.6	34.8	39.9	48.5
20	-	-	-	8.9	20	21.9	30.9	32.2	34.6	40	48.9
21	-	-	-	-	18.3	20.4	30.3	31.7	34.2	39.9	49.3
22	-	-	-	-	16.2	18.7	29.6	31.1	33.8	39.7	49.6
23	-	-	-	-	13.5	16.6	28.7	30.3	33.2	39.5	49.8
24	-	-	-	-	9.7	13.8	27.7	29.3	32.4	39.1	49.9
25	-	-	-	-	-	10	26.4	28.2	31.6	38.7	50



## Programming in vertical cutting



- Vertical machining route
- Rapid feed
- $\beta$  Angle between tool and workpiece ( $\beta \geq 1^\circ$ )

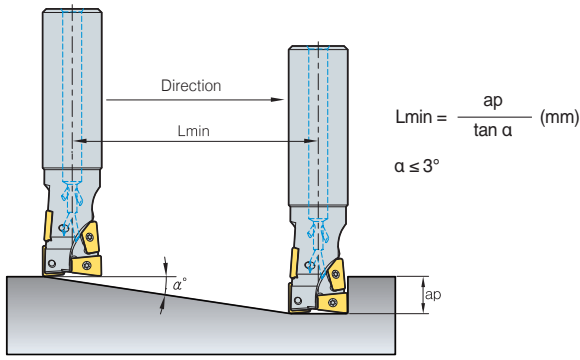
- Reduce 30% of feed till 3 mm machining
- Have the tool be away from the workpiece more than  $1^\circ$  (b) after finishing the machining or when moving the tool to the next step.

## Cutting condition

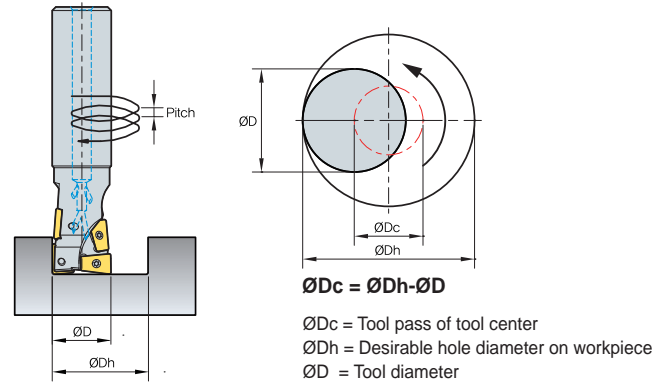
Designation	Hardness	Grades	Cutting condition vc (m/min)	Ø16, 17		Ø20, 21		Ø25, 26		Ø32, 33		Ø35		Ø40		Ø50	
				Feed	Step	Feed	Step	Feed	Step	Feed	Step	Feed	Step	Feed	Step	Feed	Step
<b>P</b>	Mild steel, Low Carbon steel (SS400)	Under 200HB	PC3700	200 (150~250)	0.03 0.20	0.04 0.30	0.05 0.30	0.05 0.30	0.06 0.30	0.06 0.30	0.07 0.30	0.07 0.30	0.07 0.30	0.07 0.30	0.07 0.30	0.07 0.30	0.07 0.30
	Carbon steel, Alloy steel (SM50C, SCM440)	Under 100HrC	PC3700	180 (120~220)	0.03 0.20	0.04 0.30	0.05 0.30	0.05 0.30	0.05 0.30	0.06 0.30	0.06 0.30	0.06 0.30	0.06 0.30	0.06 0.30	0.06 0.30	0.06 0.30	0.06 0.30
<b>M</b>	Stainless steel (STS)	Under 270HB	PC5300	160 (120~200)	0.03 0.15	0.04 0.25	0.05 0.25	0.05 0.25	0.05 0.25	0.06 0.25	0.06 0.25	0.06 0.25	0.06 0.25	0.06 0.25	0.06 0.25	0.06 0.25	0.06 0.25
<b>K</b>	Cast iron (GC, GCD)	350N/mm <sup>2</sup>	PC5300	200 (150~250)	0.04 0.40	0.05 0.50	0.06 0.50	0.06 0.50	0.06 0.50	0.07 0.50	0.07 0.50	0.07 0.50	0.07 0.50	0.07 0.50	0.07 0.50	0.07 0.50	0.07 0.50
<b>H</b>	Hardened steel	40~55HrC	PC5300	80 (50~120)	0.03 0.15	0.03 0.25	0.04 0.25	0.04 0.25	0.04 0.25	0.04 0.25	0.04 0.25	0.04 0.25	0.04 0.25	0.04 0.25	0.04 0.25	0.05 0.25	0.05 0.25

\* Please note - Step machining is required for aspect ratio under 0.5D or initial drilling

## 1. Ramping



## 2. Helical cutting



### ➤ Cutting condition for ramping and helical operation

Designation	Hardness	Grades	Cutting Speed vc (m/min)	Ø16, 17				Ø20, 21				Ø25, 26				Ø32, 33				Ø35				Ø40				Ø50			
				ØDh (mm)	ap (mm/t)	fz (mm/t)	max pitch (mm)	ØDh (mm)	ap (mm/t)	fz (mm/t)	max pitch (mm)	ØDh (mm)	ap (mm/t)	fz (mm/t)	max pitch (mm)	ØDh (mm)	ap (mm/t)	fz (mm/t)	max pitch (mm)	ØDh (mm)	ap (mm/t)	fz (mm/t)	max pitch (mm)	ØDh (mm)	ap (mm/t)	fz (mm/t)	max pitch (mm)	ØDh (mm)	ap (mm/t)	fz (mm/t)	max pitch (mm)
<b>P</b> Mild steel, Low Carbon steel (SS400)	≤ 200HB	PC3700	200 (150-250)	19	0.5D	0.15	0.35	23	0.5D	0.18	0.35	29	0.5D	0.2	0.46	37	0.5D	0.25	0.58	41	0.5D	0.28	0.69	47	0.5D	0.3	0.81	58	0.5D	0.35	0.92
				-30	-1D	-0.12	-1.61	-28	-1D	-0.12	-2.07	-47	-1D	-0.15	-2.53	-60	-1D	-0.2	-3.23	-65	-1D	-0.2	-3.46	-75	-1D	-0.2	-4.03	-95	-1D	-0.25	-5.18
<b>P</b> Carbon steel, Alloy Steel (SM50C, SCM440)	≤ 100HB	PC3700	180 (120-220)	19	0.5D	0.15	0.26	23	0.5D	0.16	0.26	29	0.5D	0.18	0.35	37	0.5D	0.2	0.44	41	0.5D	0.22	0.53	47	0.5D	0.25	0.61	58	0.5D	0.28	0.70
				-30	-1D	-0.1	-1.23	-28	-1D	-0.12	-1.58	-47	-1D	-0.12	-1.93	-60	-1D	-0.15	-2.46	-65	-1D	-0.17	-2.63	-75	-1D	-0.2	-3.07	-95	-1D	-0.25	-3.95
<b>M</b> Stainless steel (STS)	≤ 270HB	PC5300	160 (120-200)	19	0.2D	0.13	0.18	23	0.2D	0.15	0.18	29	0.2D	0.18	0.24	37	0.2D	0.2	0.24	41	0.2D	0.22	0.36	47	0.2D	0.25	0.42	58	0.2D	0.28	0.48
				-30	-0.5D	-0.1	-0.84	-28	-0.5D	-0.12	-1.09	-47	-0.5D	-0.12	-1.33	-60	-0.5D	-0.15	-1.33	-65	-0.5D	-0.17	-1.81	-75	-0.5D	-0.2	-2.11	-95	-0.5D	-0.25	-2.71
<b>K</b> Cast iron (GC, GCD)	≤ 350N/mm <sup>2</sup>	PC5300	200 (150-250)	19	0.7D	0.17	0.43	23	0.7D	0.2	0.42	29	0.7D	0.2	0.57	37	0.7D	0.25	0.71	41	0.7D	0.28	0.86	47	0.7D	0.3	1.0	58	0.7D	0.35	1.14
				-30	-1D	-0.12	-2.0	-28	-1D	-0.12	-2.57	-47	-1D	-0.15	-3.14	-60	-1D	-0.2	-3.99	-65	-1D	-0.2	-4.28	-75	-1D	-0.2	-4.99	-95	-1D	-0.25	-6.42
<b>H</b> Hardened steel	40-55HRC	PC5300	80 (50-120)	19	0.2D	0.1	0.18	23	0.2D	0.12	0.18	29	0.2D	0.13	0.24	37	0.2D	0.15	0.30	41	0.2D	0.17	0.36	47	0.2D	0.18	0.42	58	0.2D	0.2	0.48
				-30	-0.5D	-0.05	-0.84	-28	-0.5D	-0.07	-1.09	-47	-0.5D	-0.1	-1.33	-60	-0.5D	-0.12	-1.69	-65	-0.5D	-0.13	-1.81	-75	-0.5D	-0.15	-2.11	-95	-0.5D	-0.15	-2.71

### ➤ Recommended cutting condition in shouldering

Designation	Hardness	Grades	Cutting Speed vc (m/min)	Ø16, 17			Ø20, 21			Ø25, 26			Ø32, 33			Ø35			Ø40			Ø50		
				max ap (mm)	max ae (mm)	max fz (mm/t)	max ap (mm)	max ae (mm)	max fz (mm/t)	max ap (mm)	max ae (mm)	max fz (mm/t)	max ap (mm)	max ae (mm)	max fz (mm/t)	max ap (mm)	max ae (mm)	max fz (mm/t)	max ap (mm)	max ae (mm)	max fz (mm/t)	max ap (mm)	max ae (mm)	max fz (mm/t)
<b>P</b> Mild steel, Low Carbon steel (SS400)	≤ 200HB	PC3700	200 (150-250)	17	8	0.25	22	10	0.3	27	13	0.35	35	16	0.4	40	18	0.45	44	20	0.5	55	25	0.6
				17	8	0.2	22	10	0.25	27	13	0.3	35	16	0.35	40	18	0.4	44	20	0.4	55	25	0.5
<b>M</b> Carbon steel, Alloy Steel (SM50C, SCM440)	≤ 100HB	PC3700	180 (120-220)	17	8	0.2	22	10	0.25	27	13	0.3	35	16	0.35	40	18	0.4	44	20	0.4	55	25	0.5
				17	8	0.2	22	10	0.25	27	13	0.3	35	16	0.35	40	18	0.4	44	20	0.4	55	25	0.5
<b>M</b> Stainless steel (STS)	≤ 270HB	PC5300	160 (120-200)	17	8	0.2	22	10	0.25	27	13	0.3	35	16	0.35	40	18	0.4	44	20	0.4	55	25	0.5
				17	8	0.2	22	10	0.25	27	13	0.3	35	16	0.35	40	18	0.4	44	20	0.4	55	25	0.5
<b>K</b> Cast iron (GC, GCD)	≤ 350N/mm <sup>2</sup>	PC5300	200 (150-250)	17	8	0.25	22	10	0.3	27	13	0.35	35	16	0.4	40	18	0.45	44	20	0.5	55	25	0.6
				17	8	0.25	22	10	0.3	27	13	0.35	35	16	0.4	40	18	0.45	44	20	0.5	55	25	0.6
<b>H</b> Hardened steel	40-55HRC	PC5300	80 (50-120)	17	5	0.15	22	6	0.2	27	7	0.22	35	8	0.25	40	9	0.3	44	10	0.3	55	14	0.35
				17	5	0.15	22	6	0.2	27	7	0.22	35	8	0.25	40	9	0.3	44	10	0.3	55	14	0.35

### ➤ Recommended cutting condition in grooving

Designation	Hardness	Grades	Cutting Speed vc (m/min)	Ø16, 17		Ø20, 21		Ø25, 26		Ø32, 33		Ø35		Ø40		Ø50	
				max ap (mm)	max fz (mm/t)	max ap (mm)	max fz (mm/t)	max ap (mm)	max fz (mm/t)	max ap (mm)	max fz (mm/t)	max ap (mm)	max fz (mm/t)	max ap (mm)	max fz (mm/t)	max ap (mm)	max fz (mm/t)
<b>P</b> Mild steel, Low Carbon steel (SS400)	≤ 200HB	PC3700	200 (150-250)	17	0.15	22	0.18	27	0.2	35	0.25	40	0.27	44	0.3	55	0.35
				17	0.15	22	0.15	27	0.18	35	0.2	40	0.22	44	0.25	55	0.3
<b>M</b> Carbon steel, Alloy Steel (SM50C, SCM440)	≤ 100HB	PC3700	180 (120-220)	17	0.15	22	0.15	27	0.18	35	0.2	40	0.22	44	0.25	55	0.3
				17	0.15	22	0.15	27	0.18	35	0.2	40	0.22	44	0.25	55	0.3
<b>M</b> Stainless steel (STS)	≤ 270HB	PC5300	160 (120-200)	17	0.15	22	0.15	27	0.18	35	0.2	40	0.22	44	0.25	55	0.3
				17	0.15	22	0.15	27	0.18	35	0.2	40	0.22	44	0.25	55	0.3
<b>K</b> Cast iron (GC, GCD)	≤ 350N/mm <sup>2</sup>	PC5300	200 (150-250)	17	0.15	22	0.18	27	0.2	35	0.25	40	0.27	44	0.3	55	0.35
				17	0.15	22	0.18	27	0.2	35	0.25	40	0.27	44	0.3	55	0.35
<b>H</b> Hardened steel	40-55HRC	PC5300	80 (50-120)	12	0.1	14	0.12	17	0.15	22	0.15	25	0.18	28	0.18	35	0.22
				12	0.1	14	0.12	17	0.15	22	0.15	25	0.18	28	0.18	35	0.22



# HAVE (Multi-edge)

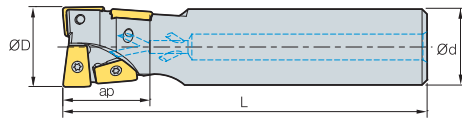


Fig. 1

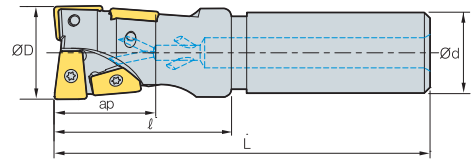


Fig. 2



- AR: 7°~12°
- RR: -12°~-4°

(mm)

Designation		ØD	Ød	ℓ	L	ap	Available inserts		Fig.
<b>HAVE</b> 0816HR-S16M	4	16	16	30	120	17.6	XPMT0802ER-MM	0.15	1
0816HR-L16M	4	16	16	30	200	17.6		0.26	
0817HR-S16M	4	17	16	30	120	17.6		0.18	2
0817HR-L16M	4	17	16	30	200	17.6		0.27	
1020HR-S20M	4	20	20	35	130	22	XPMT1003ER-MM	0.26	1
1020HR-L20M	4	20	20	35	210	22		0.44	
1021HR-S20M	4	21	20	35	130	22		0.26	2
1021HR-L20M	4	21	20	35	210	22		0.45	
1325HR-S25M	4	25	25	45	140	27	XPMT13T3ER-MM	0.41	1
1325HR-L25M	4	25	25	45	220	27		0.71	
1326HR-S25M	4	26	25	45	140	27		0.45	2
1326HR-L25M	4	26	25	45	220	27		0.68	
1632HR-S32M	4	32	32	50	150	35.2	XPMT1604ER-MM	0.72	1
1632HR-L32M	4	32	32	50	250	35.2		1.32	
1633HR-S32M	4	33	32	50	150	35.2		0.76	2
1633HR-L32M	4	33	32	50	250	35.2		1.27	
1835HR-S32M	4	35	32	50	150	40	XPMT1805ER-MM	0.75	1
1835HR-L32M	4	35	32	50	230	40		1.23	
2040HR-S32M	4	40	32	55	160	44	XPMT2006ER-MM	0.74	2
2040HR-L32M	4	40	32	55	240	44		1.35	
2550HR-S42M	4	50	42	70	170	55	XPMT2507ER-MM	1.53	2
2550HR-L42M	4	50	42	70	250	55		2.60	

## Available inserts

XPMT-MM



Designation	Cermet		Coated										Uncoated			page			
	CN2500	CN30	NC5330	NCM325	NCM335	NCM535	NCM545	PC2505	PC2510	PC3700	PC6510	PC9530	PC9540	PC5300	PC5400		ST30A	G10	H01
XPMT 0802ER-MM														●					E32
1003ER-MM									●					●					
13T3ER-MM														●					
1604ER-MM														●					
1805ER-MM														●					
2006ER-MM														●					
2507ER-MM														●					

## Parts

Specification		
Ø16~Ø17	FTNA0204	TW06S
Ø20~Ø21	FTNA02205	TW09S
Ø25~Ø26	FTKA0307	TW15S
Ø32~Ø33	FTKA0408	TW20S
Ø35		
Ø40	FTGA0511-P	
Ø50	FTNA0615	

Available inserts E32

## HAVE (Single-edge)

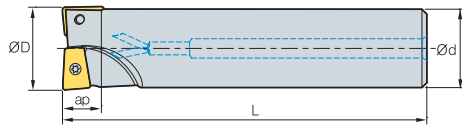


Fig. 1

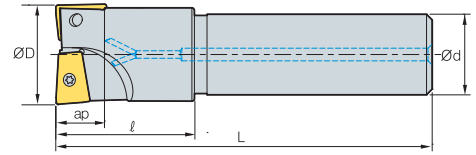


Fig. 2



AA 90°  
 • AR: 7°~12°  
 • RR: -12°~-4°

(mm)

Designation		ØD	Ød	ℓ	L	ap	Available inserts		Fig.
HAVE	0816HR-S16	2	16	16	30	120	XPMT0802ER-MM	0.16	1
	0816HR-L16	2	16	16	30	200		0.27	
	0817HR-S16	2	17	16	30	120	XPMT0802ER-MM	0.16	2
	0817HR-L16	2	17	16	30	200		0.27	
	1020HR-S20	2	20	20	35	130	XPMT1003ER-MM	0.28	1
	1020HR-L20	2	20	20	35	210		0.46	
	1021HR-S20	2	21	20	35	130	XPMT1003ER-MM	0.28	2
	1021HR-L20	2	21	20	35	210		0.46	
	1325HR-S25	2	25	25	45	140	XPMT13T3ER-MM	0.44	1
	1325HR-L25	2	25	25	45	220		0.76	
	1326HR-S25	2	26	25	45	140	XPMT13T3ER-MM	0.47	2
	1326HR-L25	2	26	25	45	220		0.76	
	1632HR-S32	2	32	32	50	150	XPMT1604ER-MM	0.77	1
	1632HR-L32	2	32	32	50	250		1.36	
	1633HR-S32	2	33	32	50	150	XPMT1604ER-MM	0.81	2
	1633HR-L32	2	33	32	50	250		1.41	
	1835HR-S32	2	35	32	50	150	XPMT1805ER-MM	0.81	1
	1835HR-L32	2	35	32	50	230		1.28	
	2040HR-S32	2	40	32	55	160	XPMT2006ER-MM	0.95	2
	2040HR-L32	2	40	32	55	240		1.45	
	2550HR-S42	2	50	42	70	170	XPMT2507ER-MM	1.68	2
	2550HR-L42	2	50	42	70	250		2.54	

### Available inserts

XPMT-MM



Designation	Cermet		Coated										Uncoated			page			
	CN2500	CN30	NC6330	NCM325	NCM335	NCM535	NCM545	PC2505	PC2510	PC3700	PC6510	PC9530	PC9540	PC5300	PC5400		ST30A	G10	H01
XPMT														●					E32
										●				●					
														●					
														●					
														●					
														●					
														●					

### Parts

Specification		
Ø16~Ø17	FTNA0204	TW06S
Ø20~Ø21	FTNA02205	TW09S
Ø25~Ø26	FTKA0307	TW15S
Ø32~Ø33	FTKA0408	TW15S
Ø35		
Ø40	FTGA0511-P	TW20S
Ø50	FTNA0615	

Available inserts E32





Guarantee strong constrain force by 2-side constraint

# BT/HSK Tooling System

## Code system

### • Single, Multi-edge

BT50	HAT	4	063	114	-	4	F
<b>Arbor type</b>	<b>Item Name</b>	<b>Type</b>	<b>Diameter</b>	<b>Length (ap)</b>		<b>No. of flute</b>	<b>Front piece or total length</b>
BT30/40/50 HSK40/50/63/100	AM HAT RM	1000 type 1500 type 2000 type 3000 type 4000 type	063: Ø63	Length: 114 HS: Coolant + Single		No. of flute: 4 No. of tooth: 4	Front Piece (Y/N) Y: F No code: No L: Long type

### • Modular

BT50	MAT	M16	092
<b>Arbor type</b>	<b>Item category</b>	<b>M Dimensions</b>	<b>Total length (L)</b>
BT30/40/50 HSK40/50/63/100	MAT	M16	092: 92

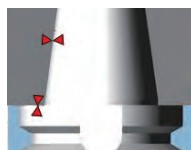
## DBT system

### Feature of (D)BT arbor

- Guaranteed strong force by 2-side constraint
- Guarantee strengthen cutting at high speed
- Guaranteed superior surface roughness

#### DBT (Constrain, increased surface roughness)

2-side constraint  
(Taper, 1-side)



DBT Workpiece  
Ra = 0.3µm

#### BT

1-side constraint  
(Taper)



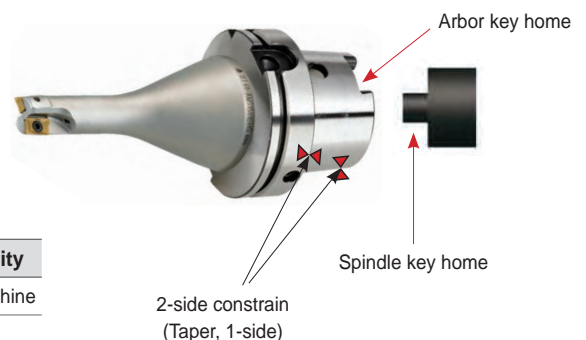
BT Workpiece  
Ra = 0.5µm

## HSK system

### Feature of HSK arbor

- Guaranteed strong constrain force by 2-side constraint
- Guaranteed strengthened cutting at high speeds
- Guaranteed superior surface roughness
- Guaranteed repeatability at axle direction and repeated direction

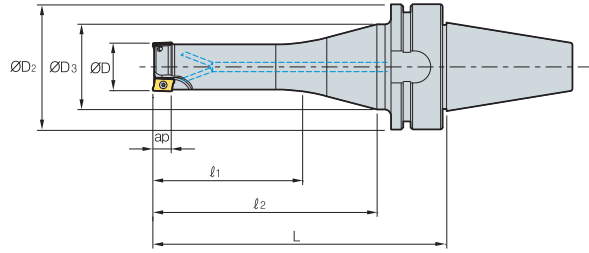
#### HSK A: HSK T key tolerance comparison



### HSK tolerance comparison

Arbor type	Max. tolerance	Min. tolerance	Available facility
HSK-T	0.075	0.035	Multi-tasking machine
HSK-A	0.33	0.08 (General)	MCT

## BT30 AM1000HS



AA 90°  
 • AR: 7.5°~13°  
 • RR: -28°~-7°

(mm)

Designation		ØD	ØD2	ØD3	l1	l2	L	ap	
BT30	AM1010HS-2	2	10	46	41	35	83	112	5.6
	AM1012HS-2	2	12	46	41	35	83	112	5.6
	AM1012HS-3	3	12	46	41	35	83	112	5.6
	AM1016HS-3	3	16	46	41	35	83	112	5.6
	AM1016HS-4	4	16	46	41	35	83	112	5.6
	AM1020HS-4	4	20	46	41	45	98	127	5.6
	AM1020HS-5	5	20	46	41	45	98	127	5.6

### Available inserts

APMT-MA APMT-MM



Designation	Cermet		Coated												Uncoated		page		
	CN2500	CN30	NC5330	NCM325	NCM335	NCM535	NCM545	PC2505	PC2510	PC3700	PC6510	PC9530	PC9540	PC5300	PC5400	G10		H01	
APMT 0602PDFR-MA																		●	E06
060208PDFR-MA																			
060202PDSR-MM			●							●				●	●				
0602PDSR-MM			●					●	●	●	●	●		●	●				
060208PDSR-MM			●							●				●	●				
060212R-MM			●											●	●				
060216R-MM														●	●				

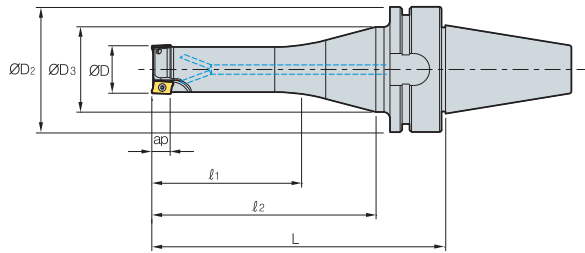
### Parts

Specification			
Ø10~Ø20	FTKA01842	-	TW06S-A

Available inserts E06



# BT40 AM1500HS



AA  
90°  
• AR: 7.5°~13°  
• RR: -28°~-7°

(mm)

Designation		ØD	ØD <sub>2</sub>	ØD <sub>3</sub>	l <sub>1</sub>	l <sub>2</sub>	L	ap	
BT40	AM15016HS-2	2	16	63	50	45	83	117	9
	AM15016HS-2L	2	16	63	50	35	118	152	9
	AM15020HS-2	2	20	63	50	60	98	132	9
	AM15020HS-3	3	20	63	50	60	98	132	9
	AM15020HS-2L	2	20	63	50	50	118	152	9
	AM15025HS-3	3	25	63	50	75	113	147	9
	AM15025HS-4	4	25	63	50	75	113	147	9
	AM15025HS-3L	3	25	63	50	65	133	167	9
	AM15032HS-4	4	32	63	50	80	113	147	9
	AM15032HS-5	5	32	63	50	80	113	147	9
	AM15032HS-4L	4	32	63	50	70	133	167	9
	AM15040HS-5	5	40	63	50	60	98	132	9
	AM15040HS-6	6	40	63	50	60	98	132	9
	AM15040HS-5L	5	40	63	50	50	118	152	9

## Available inserts

APMT-MA APMT-ML APMT-MM



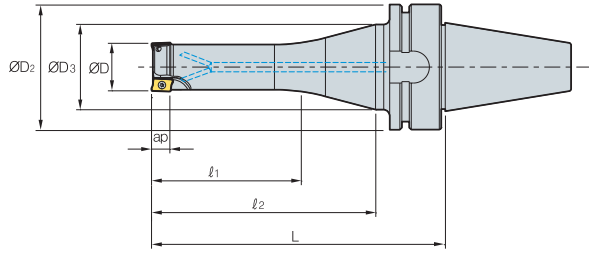
Designation	Cermet		Coated											Uncoated		page		
	CN2500	CN30	NC5330	NCM325	NCM335	NCM535	NCM545	PC2505	PC2510	PC3700	PC6510	PC9530	PC9540	PC5300	PC5400		G10	H01
APMT 0903PDFR-MA																		●
090308PDFR-MA																		
0903PDER-ML														●	●			
090308PDER-ML														●	●			
0903PDSR-MM			●					●	●	●	●			●	●			
090308PDSR-MM			●							●				●	●			
090312R-MM										●				●	●			
090316R-MM			●							●				●	●			
090320R-MM										●				●	●			

## Parts

Specification	Screw	Wrench	Wrench
Ø16~Ø40	FTKA02565S	TW08S	-

Available inserts E06

## BT40 AM2000HS



AA  
90°  
•AR: 7°~10°  
•RR: -20°~-7°

(mm)

Designation		ØD	ØD <sub>2</sub>	ØD <sub>3</sub>	l <sub>1</sub>	l <sub>2</sub>	L	ap	
BT40	AM2016HS-2	2	16	63	50	45	83	117	11
	AM2016HS-2L	2	16	63	50	35	118	152	11
	AM2020HS-2	2	20	63	50	60	98	132	11
	AM2020HS-2L	2	20	63	50	50	118	152	11
	AM2025HS-3	3	25	63	50	75	113	147	11
	AM2025HS-3L	3	25	63	50	65	133	167	11
	AM2032HS-4	4	32	63	50	80	113	147	11
	AM2032HS-4L	4	32	63	50	70	133	167	11
	AM2040HS-5	5	40	63	50	60	98	132	11
	AM2040HS-5L	5	40	63	50	50	118	152	11
	AM2050HS-6	6	50	63	50	60	98	132	11
	AM2050HS-6L	6	50	63	50	50	118	152	11

### Available inserts



Designation	Cermet		Coated										Uncoated		page			
	CN2500	CN30	NC5330	NCM325	NCM335	NCM635	NCM645	PC2505	PC2510	PC3700	PC6510	PC9530	PC9540	PC5300		PC5400	G10	H01
APMT																		
11T3PDFR-MA																		●
11T308PDFR-MA																		
11T3PDER-ML														●	●			
11T308PDER-ML														●	●			
11T3PDSR-MM			●	●		●		●	●	●	●	●		●	●			
11T3PDSR-MF			●						●	●				●	●			
11T308PDSR-MM			●							●		●	●	●	●			
11T312PDSR-MM			●									●		●	●			
11T316R-MM			●							●				●	●			
11T318R-MM														●	●			
11T324R-MM			●							●				●	●			
11T3PDSR-MN2														●	●			
11T3PDSR-MN3														●	●			

\* Please purchase 2 types of APMT-MN (nick type) inserts with different chip breakers. \* Please use the cutters with even teeth.

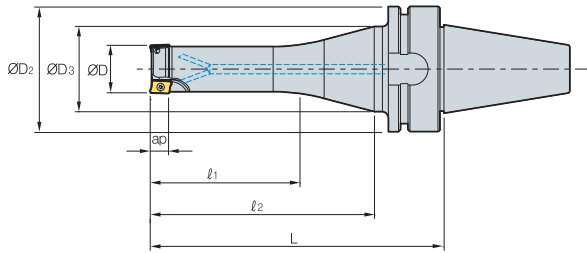
### Parts

Specification		
Ø16-Ø50	FTKA02565S	TW08S

Available inserts E06



# BT50 AM3000HS



AA  
90°  
• AR: 7°~10°  
• RR: -20°~-7°

(mm)

Designation		ØD	ØD2	ØD3	l1	l2	L	ap	
BT50	AM3025HS-2	2	25	100	80	65	113	158	16
	AM3025HS-2L	2	25	100	80	55	123	168	16
	AM3032HS-3	3	32	100	80	70	113	158	16
	AM3032HS-3L	3	32	100	80	60	123	168	16
	AM3040HS-4	4	40	100	80	50	98	143	16
	AM3040HS-4L	4	40	100	80	40	108	153	16
	AM3050HS-5	5	50	100	80	50	98	143	16
	AM3050HS-5L	5	50	100	80	40	108	153	16

## Available inserts



Designation	Cermet		Coated											Uncoated		page		
	CN2500	CN30	NC5330	NCM325	NCM335	NCM535	NCM545	PC2505	PC2510	PC3700	PC6510	PC9530	PC9540	PC5300	PC5400		G10	H01
APMT 1604PDFR-MA																		●
160404PDFR-MA																		
1604PDER-ML																		
160404PDER-ML																		
1604PDSR-MM			●	●		●		●	●	●	●	●	●	●	●	●		
1604PDSR-MF			●						●	●				●	●			
160410PDSR-MM										●				●	●			
160416PDSR-MM			●							●				●	●			
160424R-MM			●							●				●	●			
160430R-MM										●				●	●			
160432R-MM			●							●				●	●			
1604PDSR-MN3														●				
1604PDSR-MN4														●				

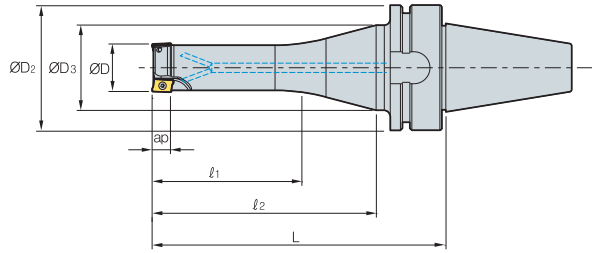
※ Please purchase 2 types of APMT-MN (nick type) inserts with different chip breakers. ※ Please use the cutters with even teeth.

## Parts

Specification		
Ø25 Ø32-Ø50	FTKA0408 FTKA0410	TW15S

Available inserts E06

## BT50 AM4000HS



AA  
90°  
• AR: 7°~10°  
• RR: -20°~-7°

(mm)

Designation		ØD	ØD2	ØD3	ℓ1	ℓ2	L	ap
BT50 AM4020HS-1	1	20	100	80	50	98	143	17
AM4025HS-2	2	25	100	80	65	113	158	17
AM4032HS-3	3	32	100	80	70	113	158	17
AM4032HS-3L	3	32	100	80	60	123	168	17
AM4040HS-4	4	40	100	80	50	98	143	17
AM4040HS-4L	4	40	100	80	40	108	153	17
AM4050HS-5	5	50	100	80	50	98	143	17
AM4050HS-5L	5	50	100	80	40	108	153	17

### Available inserts



Designation	Cermet		Coated										Uncoated		page			
	CN2500	CN30	NC5330	NCM325	NCM335	NCM535	NCM545	PC2505	PC2510	PC3700	PC6510	PC9530	PC9540	PC5300		PC5400	G10	H01
APMT 1806PDFR-MA																	●	
180604PDFR-MA																	●	
180612PDFR-MA																	●	
180616PDFR-MA																	●	
180620PDFR-MA																	●	
180624PDFR-MA																	●	
180630R-MA																	●	
1806PDER-ML														●	●			
180604PDER-ML														●	●			
180612PDER-ML														●	●			
180616PDER-ML														●	●			
180620PDER-ML														●	●			
180624PDER-ML														●	●			
180630R-ML														●	●			
1806PDSR-MM			●					●	●	●	●	●	●	●	●			
1806PDSR-MF			●							●				●	●			
180612PDSR-MM			●						●					●	●			
180616PDSR-MM			●											●	●			
180620PDSR-MM														●	●			
180624PDSR-MM			●											●	●			
180630R-MM														●	●			
180632R-MM			●											●	●			
1806PDSR-MN3														●	●			
1806PDSR-MN4														●	●			

E06

\* Please purchase 2 types of APMT-MN (nick type) inserts with different chip breakers. \* Please use the cutters with even teeth.

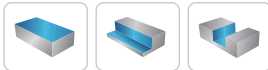
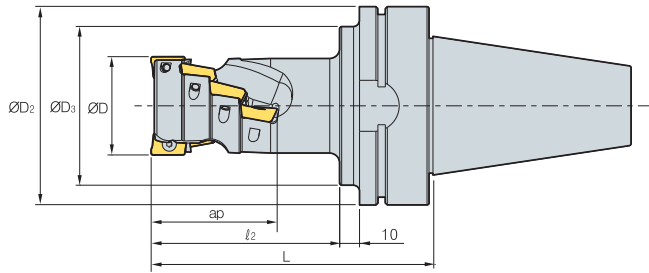
### Parts

Specification		
Ø20~Ø25	FTKA0408	TW15S
Ø32~Ø50	FTKA0410	

Available inserts E06



# BT30/40 AM1000



AA  
**90°**  
• AR: -12.5°~13°  
• RR: -17°~-6°

(mm)

Designation		ØD	ØD2	ØD3	l2	L	No. of flute	ap	
<b>BT30</b>	AM1016015-2	6	16	46	41	30	62	2	15.5
	AM1020020-3	12	20	46	41	32	64	3	20.5
	AM1025025-4	20	25	46	41	39	71	4	25.5
<b>BT40</b>	AM1016015-2	6	16	63	50	30	67	2	15.5
	AM1020020-3	12	20	63	50	32	69	3	20.5
	AM1025025-4	20	25	63	50	39	76	4	25.5

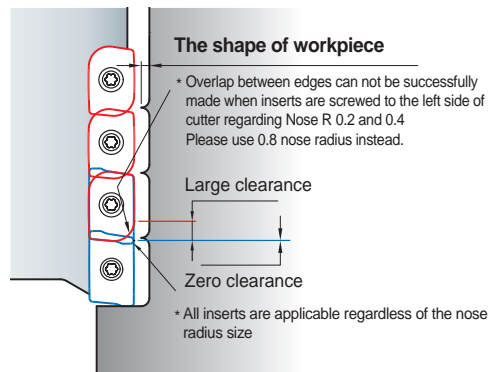
## Available inserts

APMT-MA APMT-MM



Designation	Cermet		Coated										Uncoated		page			
	CN2500	CN30	NC5330	NCM325	NCM335	NCM535	NCM545	PC2505	PC2510	PC3700	PC6510	PC9530	PC9540	PC5300		PC5400	G10	H01
APMT 0602PDFR-MA																	●	E06
060208PDFR-MA																		
060202PDSR-MM			●											●	●			
0602PDSR-MM			●					●	●	●	●	●		●	●			
060208PDSR-MM			●											●	●			
060212R-MM			●											●	●			
060216R-MM														●	●			

## Caution when clamping the inserts



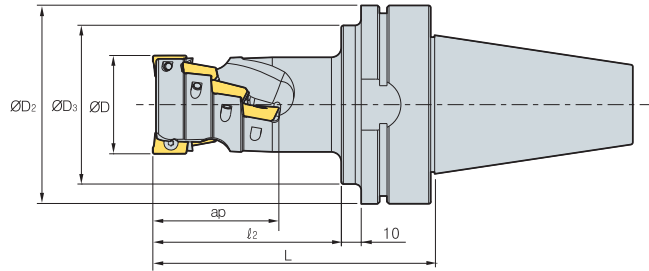
## Parts

Specification			
Ø16~Ø25	FTKA01842	-	TW06S-A

Available inserts E06



## BT30/40 AM1500



(mm)

Designation		ØD	ØD2	ØD3	l2	L	No. of flute	ap
BT30	AM15020026-1	3	20	46	41	42	1	26.5
	AM15025035-2	8	25	46	41	50	2	35
	AM15032044-2	10	32	46	41	60	2	44
BT40	AM15020026-1	3	20	63	50	42	1	26.5
	AM15025035-2	8	25	63	50	50	2	35
	AM15032044-2	10	32	63	50	60	2	44

### Available inserts

APMT-MA APMT-ML APMT-MM

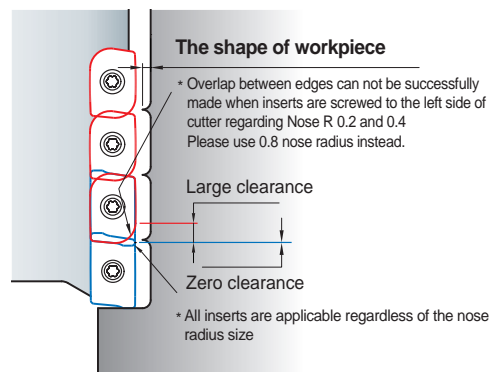


Designation	Cermet		Coated										Uncoated		page			
	CN2500	CN30	NC5330	NCM325	NCM335	NCM535	NCM645	PC2505	PC2510	PC3700	PC6510	PC9530	PC9540	PC5300		PC5400	G10	H01
APMT 0903PDFR-MA																		●
090308PDFR-MA																		
0903PDER-ML														●	●			
090308PDER-ML														●	●			
0903PDSR-MM			●					●	●	●	●			●	●			
090308PDSR-MM			●							●				●	●			
090312R-MM										●				●	●			
090316R-MM			●							●				●	●			
090320R-MM										●				●	●			

### Parts

Specification			
Ø20-Ø32	FTKA02565S	TW08S	-

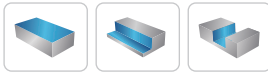
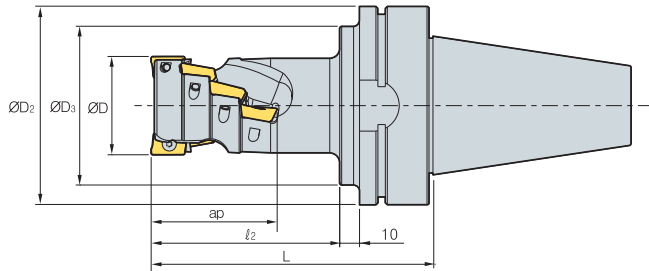
### Caution when clamping the inserts



Available inserts E06



# BT30/40 AM2000



AA  
90°  
• AR: -9°  
• RR: -13°~-8°

(mm)

Designation		ØD	ØD <sub>2</sub>	ØD <sub>3</sub>	l <sub>2</sub>	L	No. of flute	ap	
BT30	AM2020029-1	3	20	46	41	45	77	1	29.4
	AM2025038-2	8	25	46	45	55	87	2	38.9
	AM2032048-2	10	32	46	45	65	97	2	48.5
	AM2040058-2	14	40	46	45	75	107	2	58
	AM2050039-4	16	50	46	45	58	90	4	39
	AM2063039-4	16	63	46	45	58	90	4	39
	AM2080039-5	20	80	46	45	63	95	5	39
	AM2100039-6	24	100	46	45	63	95	6	39
BT40	AM2020029-1	3	20	63	50	45	82	1	29.4
	AM2025038-2	8	25	63	50	55	92	2	38.9
	AM2032048-2	10	32	63	50	65	102	2	48.5
	AM2040058-2	14	40	63	50	75	112	2	58
	AM2050039-4	16	50	63	50	58	95	4	39
	AM2063039-4	16	63	63	50	58	95	4	39
	AM2080039-5	20	80	63	50	63	100	5	39
	AM2100039-6	24	100	63	50	63	100	6	39

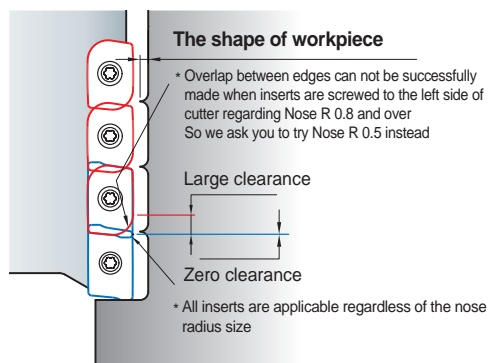
## Available inserts



Designation	Cermet		Coated										Uncoated		page			
	CN2500	CN30	NC5330	NCM325	NCM335	NCM535	NCM545	PC2505	PC2510	PC3700	PC6510	PC9530	PC9540	PC5300		PC5400	G10	H01
APMT 11T3PDFR-MA																		●
11T308PDFR-MA																		
11T3PDER-ML														●	●			
11T308PDER-ML														●	●			
11T3PDSR-MM			●	●		●	●	●	●	●	●	●		●	●			
11T3PDSR-MF			●						●	●				●	●			
11T308PDSR-MM			●						●	●			●	●				
11T312PDSR-MM			●						●	●			●	●				
11T316R-MM			●						●	●			●	●				
11T318R-MM			●						●	●			●	●				
11T324R-MM			●						●	●			●	●				
11T3PDSR-MN3													●	●				
11T3PDSR-MN4													●	●				

※ Please purchase 2 types of APMT-MN (nick type) inserts with different chip breakers.  
 ※ Please use the cutters with even teeth.

## Caution when clamping the inserts

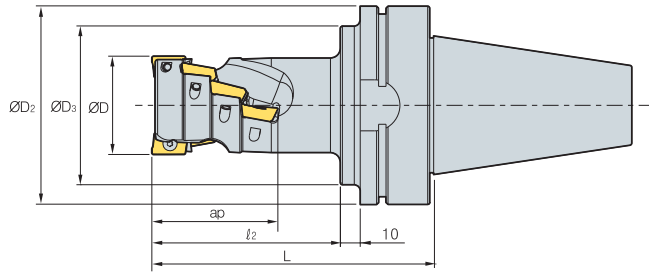


## Parts

Specification	Screw	Wrench
Ø20-Ø100	FTKA02565S	TW08S

Available inserts E06

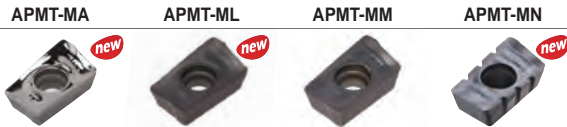
## BT50 AM3000



(mm)

Designation		ØD	ØD <sub>2</sub>	ØD <sub>3</sub>	l <sub>2</sub>	L	No. of flute	ap
BT50	AM3050043-2	6	50	100	80	72	2	43
	AM3063057-4	16	63	100	80	86	4	57
	AM3080071-4	20	80	100	80	100	4	71
	AM3100071-6	30	100	100	80	100	6	71

### Available inserts



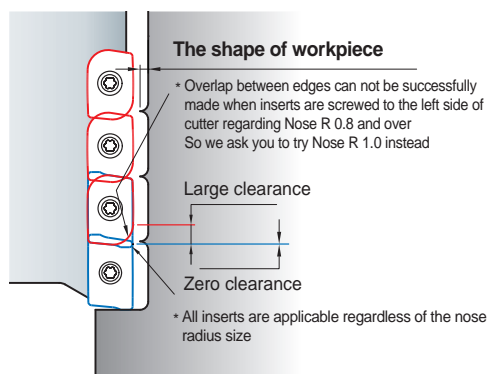
Designation	Cermet		Coated										Uncoated		page			
	CN2500	CN30	NC5330	NCM325	NCM335	NCM535	NCM545	PC2505	PC2510	PC3700	PC6510	PC9530	PC9540	PC5300		PC5400	G10	H01
APMT 1604PDFR-MA																		●
160404PDFR-MA																		
1604PDER-ML														●	●			
160404PDER-ML														●	●			
1604PDSR-MM			●	●		●		●	●	●	●	●	●	●	●			
1604PDSR-MF			●											●	●			
160410PDSR-MM														●	●			
160416PDSR-MM			●											●	●			
160424R-MM			●											●	●			
160430R-MM														●	●			
160432R-MM			●											●	●			
1604PDSR-MN3														●				
1604PDSR-MN4														●				

※ Please purchase 2 types of APMT-MN (nick type) inserts with different chip breakers.  
 ※ Please use the cutters with even teeth.

### Parts

Specification	Screw	Wrench
Ø50~Ø100	FTKA0410	TW15S

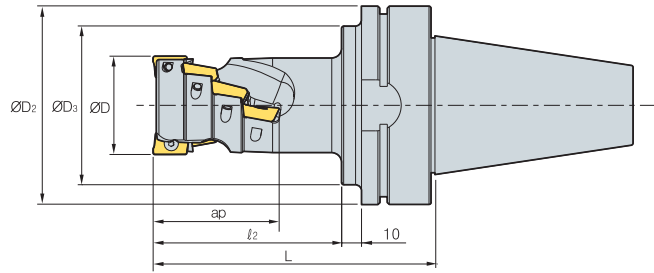
### Caution when clamping the inserts



Available inserts E06



# BT50 AM4000



(mm)

Designation	ØD	ØD <sub>2</sub>	ØD <sub>3</sub>	l <sub>2</sub>	L	No. of flute	ap
<b>BT50</b>							
AM4040046-2	6	40	100	80	75	2	46
AM4050061-2	8	50	100	80	95	2	61
AM4063061-4	16	63	100	80	90	4	61
AM4080076-4	20	80	100	90	105	4	76
AM4100076-6	30	100	100	80	105	6	76

## Available inserts

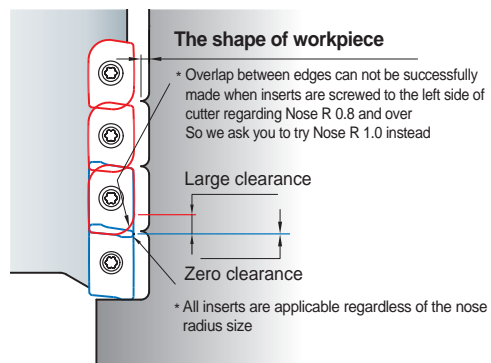


Designation	Cermet		Coated											Uncoated		page		
	CN2500	CN30	NC5330	NCM325	NCM335	NCM535	NCM545	PC2505	PC2510	PC3700	PC6510	PC9530	PC9540	PC5300	PC5400		G10	H01
<b>APMT</b>																		
1806PDFR-MA																		●
180604PDFR-MA																		●
180612PDFR-MA																		●
180616PDFR-MA																		●
180620PDFR-MA																		●
180624PDFR-MA																		●
180630R-MA																		●
1806PDER-ML														●	●			
180604PDER-ML														●	●			
180612PDER-ML														●	●			
180616PDER-ML														●	●			
180620PDER-ML														●	●			
180624PDER-ML														●	●			
180630R-ML														●	●			
1806PDSR-MM			●					●	●	●	●	●	●	●	●			
1806PDSR-MF			●							●				●	●			
180612PDSR-MM			●						●					●	●			
180616PDSR-MM			●											●	●			
180620PDSR-MM			●											●	●			
180624PDSR-MM			●											●	●			
180630R-MM			●											●	●			
180632R-MM			●											●	●			
1806PDSR-MN3														●				
1806PDSR-MN4														●				

E06

※ Please purchase 2 types of APMT-MN (nick type) inserts with different chip breakers.  
 ※ Please use the cutters with even teeth.

## Caution when clamping the inserts

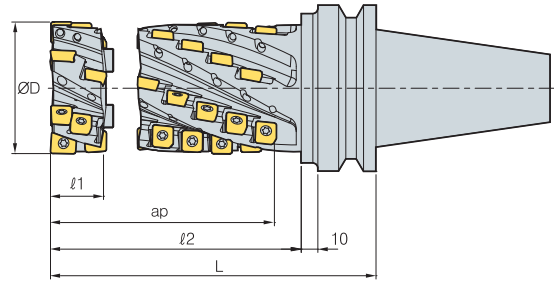
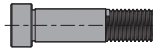


## Parts

Specification	Screw	Wrench
Ø40~Ø100	FTKA0410	TW15S

Available inserts E06

## BT50 HAT4000



(mm)

Designation	SPMT		ØD	l <sub>1</sub>	l <sub>2</sub>	L	No. of flute	ap	Application	
	SPMT	ZPMT								
BT50- (Set)	HAT4050094-2F	10	1	50	32	119	160	2	94	HAT4050032-2F
	HAT4050104-2F	11	1	50	32	129	170	2	104	
	HAT4050114-2F	12	1	50	32	139	180	2	114	
	HAT4063094-4F	20	2	63	32	119	160	4	94	HAT4063032-4F
	HAT4063104-4F	22	2	63	32	129	170	4	104	
	HAT4063114-4F	24	2	63	32	139	180	4	114	
	HAT4080094-4F	20	2	80	33	119	160	4	94	HAT4080033-4F
	HAT4080104-4F	22	2	80	33	129	170	4	104	
HAT4080114-4F	24	2	80	33	139	180	4	114		
HAT4080114-4F	24	2	80	33	139	180	4	114		
(Front Piece)	HAT4050032-2F	3	1	50	32	-	-	2	-	-
	HAT4063032-4F	6	2	63	32	-	-	4	-	
	HAT4080033-4F	6	2	80	33	-	-	4	-	

### Available inserts

SPMT-MMN      ZPMT-MMN



Designation	Cermet		Coated										Uncoated		page			
	CN2500	CN30	NC5330	NCM325	NCM335	NCM535	NCM545	PC2505	PC2510	PC3700	PC6510	PC9530	PC9540	PC5300		PC5400	G10	H01
SPMT 120508-MMN																		E27
ZPMT 1505PPSR-MMN																		E33

### Set specification

Set Designation	Designation	Front Piece	Clamping Bolt
HAT4050094-2F HAT4050104-2F HAT4050114-2F	HAT4050062-2F HAT4050072-2F HAT4050082-2F	HAT4050032-2F	HSB1255
HAT4063094-4F HAT4063104-4F HAT4063114-4F	HAT4063062-4F HAT4063072-4F HAT4063082-4F	HAT4063032-4F	HSB1670
HAT4080094-4F HAT4080104-4F HAT4080114-4F	HAT4080061-4F HAT4080071-4F HAT4080081-4F	HAT4080033-4F	HSB1682

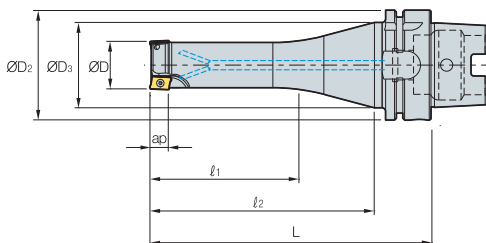
### Parts

Specification	Screw	Wrench
Ø50~Ø80	ETNA0511	TW20

Available inserts E27, E33



# HSK63A AM1000HS



•AR: 7.5°~13°  
•RR: -28°~-7°

(mm)

Designation		ØD	ØD <sub>2</sub>	ØD <sub>3</sub>	l <sub>1</sub>	l <sub>2</sub>	L	ap	
HSK63A	AM1010HS-2	2	10	63	53	35	83	116	5.6
	AM1012HS-2	2	12	63	53	35	83	116	5.6
	AM1012HS-3	3	12	63	53	35	83	116	5.6
	AM1016HS-3	3	16	63	53	35	83	116	5.6
	AM1016HS-4	4	16	63	53	35	83	116	5.6
	AM1020HS-4	4	20	63	53	45	98	131	5.6
	AM1020HS-5	5	20	63	53	45	98	131	5.6

## Available inserts

APMT-MA APMT-MM



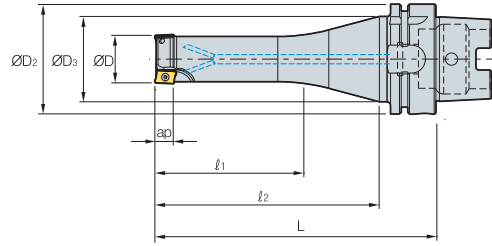
Designation	Cermet		Coated										Uncoated		page			
	CN2500	CN30	NC5330	NCM325	NCM335	NCM535	NCM545	PC2505	PC2510	PC3700	PC6510	PC9530	PC9540	PC5300		PC5400	G10	H01
APMT 0602PDFR-MA																	●	E06
060208PDFR-MA																		
060202PDSR-MM			●							●				●	●			
0602PDSR-MM			●					●	●	●	●	●		●	●			
060208PDSR-MM			●							●				●	●			
060212R-MM			●											●	●			
060216R-MM														●	●			

## Parts

Specification			
Ø10~Ø20	FTKA01842	-	TW06S-A

Available inserts E06

## HSK63A AM1500HS



AA  
90°  
• AR: 7.5°~13°  
• RR: -28°~7°

(mm)

Designation		ØD	ØD2	ØD3	l1	l2	L	ap	
HSK63A	AM15016HS-2	2	16	63	53	45	83	116	9
	AM15016HS-2L	2	16	63	53	35	118	151	9
	AM15020HS-2	2	20	63	53	60	98	131	9
	AM15020HS-3	3	20	63	53	60	98	131	9
	AM15020HS-2L	2	20	63	53	50	118	151	9
	AM15025HS-3	3	25	63	53	75	113	146	9
	AM15025HS-4	4	25	63	53	75	113	146	9
	AM15025HS-3L	3	25	63	53	65	133	166	9
	AM15032HS-4	4	32	63	53	80	113	146	9
	AM15032HS-5	5	32	63	53	80	113	146	9
	AM15032HS-4L	4	32	63	53	70	133	166	9
	AM15040HS-5	5	40	63	53	60	98	131	9
	AM15040HS-6	6	40	63	53	60	98	131	9
	AM15040HS-5L	5	40	63	53	50	118	151	9

### Available inserts

APMT-MA APMT-ML APMT-MM



Designation	Cermet		Coated										Uncoated		page			
	CN2500	CN30	NC5330	NCM325	NCM335	NCM535	NCM545	PC2505	PC2510	PC3700	PC6510	PC9530	PC9540	PC5300		PC5400	G10	H01
APMT 0903PDFR-MA																		●
090308PDFR-MA																		
0903PDER-ML														●	●			
090308PDER-ML														●	●			
0903PDSR-MM			●					●	●	●	●			●	●			
090308PDSR-MM			●							●				●	●			
090312R-MM										●				●	●			
090316R-MM			●							●				●	●			
090320R-MM										●				●	●			

### Parts

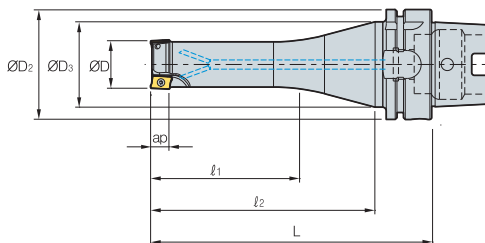
Specification			
Ø16~Ø40	FTKA02565S	TW08S	-

Available inserts E06





# HSK63A AM2000HS



•AR: 7°~10°  
•RR: -20°~7°

(mm)

Designation		ØD	ØD <sub>2</sub>	ØD <sub>3</sub>	l <sub>1</sub>	l <sub>2</sub>	L	ap
HSK63A AM2016HS-2	2	16	63	53	45	83	116	11
AM2016HS-2L	2	16	63	53	35	118	151	11
AM2020HS-2	2	20	63	53	60	98	131	11
AM2020HS-2L	2	20	63	53	50	118	151	11
AM2025HS-3	3	25	63	53	75	113	146	11
AM2025HS-3L	3	25	63	53	65	133	166	11
AM2032HS-4	4	32	63	53	80	113	146	11
AM2032HS-4L	4	32	63	53	70	133	166	11
AM2040HS-5	5	40	63	53	60	98	131	11
AM2040HS-5L	5	40	63	53	50	118	151	11
AM2050HS-6	6	50	63	53	60	98	131	11
AM2050HS-6L	6	50	63	53	50	118	151	11

## Available inserts



Designation	Cermet		Coated											Uncoated		page	
	CN2500	CN30	NC5330	NCM325	NCM335	NCM535	NCM545	PC2505	PC2510	PC3700	PC6510	PC9530	PC9540	PC5300	PC5400		G10
APMT 11T3PDFR-MA																	●
11T308PDFR-MA																	
11T3PDER-ML														●	●		
11T308PDER-ML														●	●		
11T3PDSR-MM			●	●		●		●	●	●	●	●		●	●		
11T3PDSR-MF			●						●	●				●	●		
11T308PDSR-MM			●						●		●	●		●	●		
11T312PDSR-MM			●						●		●			●	●		
11T316R-MM			●						●					●	●		
11T318R-MM																	
11T324R-MM			●						●					●	●		
11T3PDSR-MN2														●			
11T3PDSR-MN3														●			

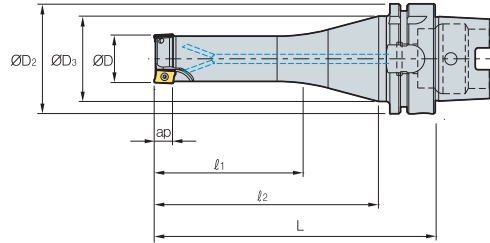
※ Please purchase 2 types of APMT-MN (nick type) inserts with different chip breakers. ※ Please use the cutters with even teeth.

## Parts

Specification		
Ø16~Ø50	FTKA02565S	TW08S

Available inserts E06

## HSK63A AM3000HS



AA  
90°  
•AR: 7°~10°  
•RR: -20°~-7°

(mm)

Designation		ØD	ØD2	ØD3	l1	l2	L	ap	
HSK63A	AM3025HS-2	2	25	63	53	65	113	146	16
	AM3025HS-2L	2	25	63	53	55	123	156	16
	AM3032HS-3	3	32	63	53	70	113	146	16
	AM3032HS-3L	3	32	63	53	60	123	156	16
	AM3040HS-4	4	40	63	53	50	98	131	16
	AM3040HS-4L	4	40	63	53	40	108	141	16
	AM3050HS-5	5	50	63	53	50	98	131	16
	AM3050HS-5L	5	50	63	53	40	108	141	16

### Available inserts



Designation	Cermet		Coated												Uncoated		page	
	CN2500	CN30	NC5330	NCM325	NCM335	NCM635	NCM645	PC2505	PC2510	PC3700	PC6510	PC9530	PC9540	PC5300	PC5400	G10		H01
APMT																		
1604PDFR-MA																		
160404PDFR-MA																		
1604PDER-ML														●	●			
160404PDER-ML														●	●			
1604PDSR-MM			●	●		●		●	●	●	●	●	●	●	●			
1604PDSR-MF			●							●	●			●	●			
160410PDSR-MM														●	●			
160416PDSR-MM			●							●				●	●			
160424R-MM			●							●				●	●			
160430R-MM										●				●	●			
160432R-MM			●							●				●	●			
1604PDSR-MN3														●				
1604PDSR-MN4														●				

\* Please purchase 2 types of APMT-MN (nick type) inserts with different chip breakers. \* Please use the cutters with even teeth.

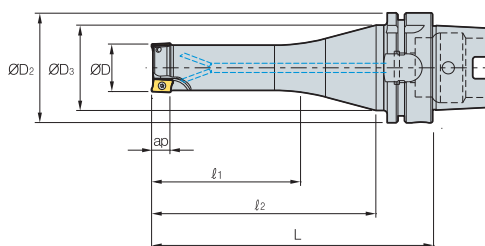
### Parts

Specification		
Ø25 Ø32~Ø50	FTKA0408 FTKA0410	TW15S

Available inserts E06



# HSK63A AM4000HS



• AR: 7°~10°  
• RR: -20°~-7°

(mm)

Designation		ØD	ØD2	ØD3	l1	l2	L	ap	
HSK63A	AM4020HS-1	1	20	63	53	50	98	131	17
	AM4025HS-2	2	25	63	53	65	113	146	17
	AM4032HS-3	3	32	63	53	70	113	146	17
	AM4032HS-3L	3	32	63	53	60	123	156	17
	AM4040HS-4	4	40	63	53	50	98	131	17
	AM4040HS-4L	4	40	63	53	40	108	141	17
	AM4050HS-5	5	50	63	53	50	98	131	17
	AM4050HS-5L	5	50	63	53	40	108	141	17

## Available inserts



Designation	Cermet		Coated										Uncoated		page			
	CN2500	CN30	NC5330	NCM325	NCM335	NCM535	NCM545	PC2505	PC2510	PC3700	PC6510	PC9530	PC9540	PC5300		PC5400	G10	H01
APMT																		
1806PDR-MA																		●
180604PDR-MA																		●
180612PDR-MA																		●
180616PDR-MA																		●
180620PDR-MA																		●
180624PDR-MA																		●
180630R-MA																		●
1806PDER-ML														●	●			
180604PDER-ML														●	●			
180612PDER-ML														●	●			
180616PDER-ML														●	●			
180620PDER-ML														●	●			
180624PDER-ML														●	●			
180630R-ML														●	●			
1806PDSR-MM			●					●	●	●	●	●	●	●	●			
1806PDSR-MF			●							●				●	●			
180612PDSR-MM			●						●					●	●			
180616PDSR-MM			●											●	●			
180620PDSR-MM			●											●	●			
180624PDSR-MM			●											●	●			
180630R-MM			●											●	●			
180632R-MM			●											●	●			
1806PDSR-MN3														●	●			
1806PDSR-MN4														●	●			

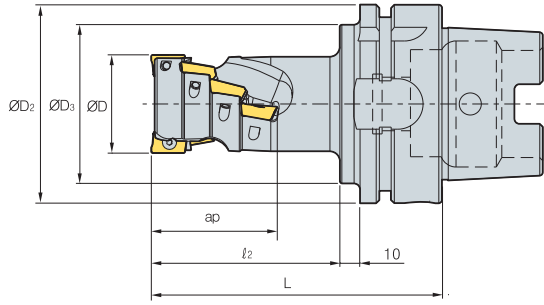
※ Please purchase 2 types of APMT-MN (nick type) inserts with different chip breakers. ※ Please use the cutters with even teeth.

## Parts

Specification		
Ø20~Ø25	FTKA0408	TW15S
Ø32~Ø50	FTKA0410	TW15S

Available inserts E06

## HSK63A AM1000



AA  
90°  
• AR: -12.5°~13°  
• RR: -17°~-6°

(mm)

Designation		ØD	ØD2	ØD3	l2	L	No. of flute	ap
HSK63A AM1016015-2	6	16	63	53	30	66	2	15.5
AM1020020-3	12	20	63	53	32	68	3	20.5
AM1025025-4	20	25	63	53	39	75	4	25.5

### Available inserts

APMT-MA APMT-MM

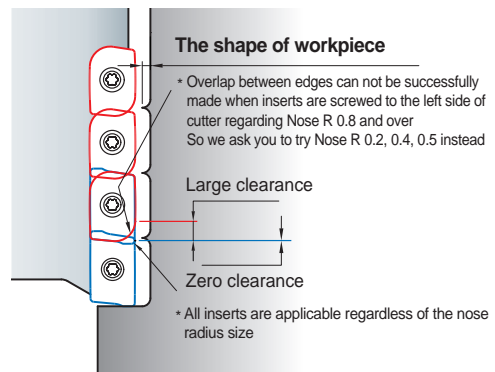


Designation	Cermet		Coated										Uncoated		page			
	CN2500	CN30	NC5330	NCM325	NCM335	NCM535	NCM545	PC2505	PC2510	PC3700	PC6510	PC9530	PC9540	PC5300		PC5400	G10	H01
APMT 0602PDFR-MA																		●
060208PDFR-MA																		
060202PDSR-MM			●							●				●	●			
0602PDSR-MM			●					●	●	●	●	●		●	●			
060208PDSR-MM			●							●				●	●			
060212R-MM			●											●	●			
060216R-MM														●	●			

### Parts

Specification			
Ø16~Ø25	FTKA01842	-	TW06S-A

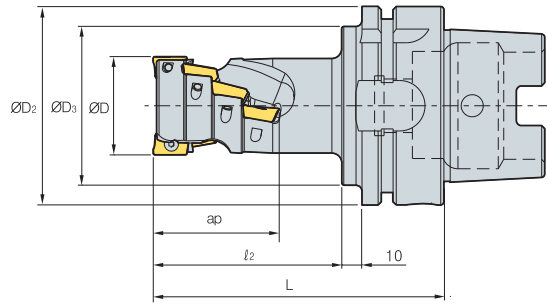
### Caution when clamping the inserts



Available inserts E06



# HSK63A AM1500



AA  
90°  
• AR: -12.5°~13°  
• RR: -17°~-6°

(mm)

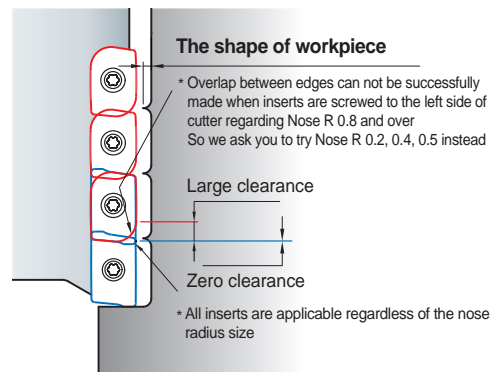
Designation		ØD	ØD <sub>2</sub>	ØD <sub>3</sub>	l <sub>2</sub>	L	No. of flute	ap
HSK63A AM15020026-1	3	20	63	53	42	78	1	26.5
AM15025035-2	8	25	63	53	50	86	2	35
AM15032044-2	10	32	63	53	60	96	2	44

## Available inserts



Designation	Cermet		Coated												Uncoated		page	
	CN2500	CN30	NC5330	NCM325	NCM335	NCM535	NCM545	PC2505	PC2510	PC3700	PC6510	PC9530	PC9540	PC5300	PC5400	G10		H01
APMT 0903PDFR-MA																		●
090308PDFR-MA																		
0903PDER-ML																		● ●
090308PDER-ML																		● ●
0903PDSR-MM			●					● ●	● ●									● ●
090308PDSR-MM			●							● ●								● ●
090312R-MM										● ●								● ●
090316R-MM			●							● ●								● ●
090320R-MM										● ●								● ●

## Caution when clamping the inserts

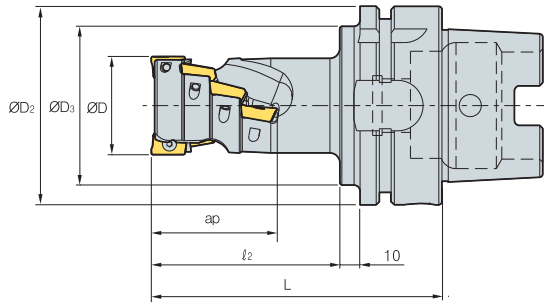


## Parts

Specification			
Ø20~Ø32	FTKA02565S	TW08S	-

Available inserts E06

## HSK63A AM2000



AA  
90°

- AR: -12.5°~13°
- RR: -17°~-6°

(mm)

Designation		ØD	ØD2	ØD3	l2	L	No. of flute	ap
HSK63A	AM2020029-1	3	20	63	53	45	81	29.4
	AM2025038-2	8	25	63	53	55	91	38.9
	AM2032048-2	10	32	63	53	65	101	48.5
	AM2040058-2	14	40	63	53	75	111	58
	AM2050039-4	16	50	63	53	58	94	39
	AM2063039-4	16	63	63	53	58	94	39
	AM2080039-5	20	80	63	53	63	99	39
	AM2100039-6	24	100	63	53	63	99	39

### Available inserts

APMT-MA

APMT-ML

APMT-MM

APMT-MF

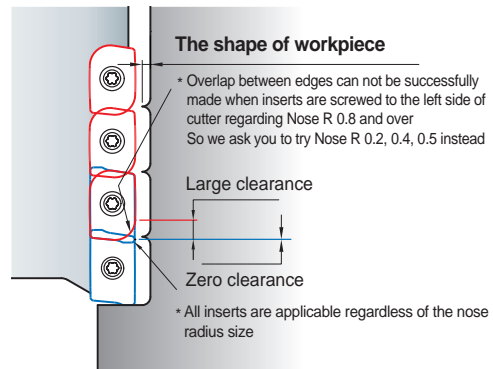
APMT-MN



Designation	Cermet		Coated											Uncoated		page		
	CN2500	CN30	NC5330	NCM325	NCM335	NCM535	NCM545	PC2505	PC2510	PC3700	PC6510	PC9530	PC9540	PC5300	PC5400		G10	H01
APMT																		
11T3PDFR-MA																		●
11T308PDFR-MA																		
11T3PDER-ML														●	●			
11T308PDER-ML														●	●			
11T3PDSR-MM			●			●		●	●	●	●	●		●	●			
11T3PDSR-MF			●						●	●				●	●			
11T308PDSR-MM			●									●		●	●			
11T312PDSR-MM			●									●		●	●			
11T316R-MM			●											●	●			
11T318R-MM			●											●	●			
11T324R-MM			●							●				●	●			
11T3PDSR-MN3														●	●			
11T3PDSR-MN4														●	●			

- ※ Please purchase 2 types of APMT-MN (nick type) inserts with different chip breakers.
- ※ Please use the cutters with even teeth.

### Caution when clamping the inserts



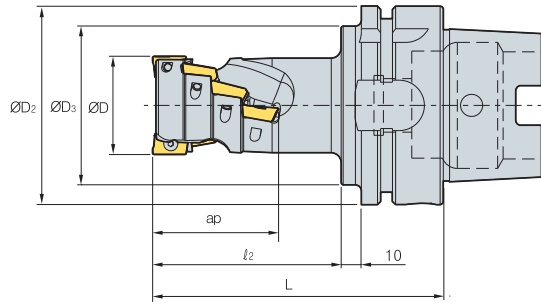
### Parts

Specification		
Ø20~Ø100	FTKA02565S	TW08S

Available inserts E06



# HSK100A AM3000



AA  
90°  
•AR: -13°~15°  
•RR: -11°~4°

(mm)

Designation		ØD	ØD <sub>2</sub>	ØD <sub>3</sub>	l <sub>2</sub>	L	No. of flute	ap
HSK100A AM3050043-2	6	50	100	88	72	111	2	43
AM3063057-4	16	63	100	88	86	125	4	57
AM3080071-4	20	80	100	88	100	139	4	71
AM3100071-6	30	100	100	88	100	139	6	71

## Available inserts



Designation	Cermet		Coated										Uncoated		page			
	CN2500	CN30	NC5330	NCM325	NCM335	NCM535	NCM545	PC2505	PC2510	PC3700	PC6510	PC9530	PC9540	PC5300		PC5400	G10	H01
APMT 1604PDFR-MA																		●
160404PDFR-MA																		
1604PDER-ML														●	●			
160404PDER-ML														●	●			
1604PDSR-MM			●	●		●		●	●	●	●	●	●	●	●			
1604PDSR-MF			●							●	●			●	●			
160410PDSR-MM														●	●			
160416PDSR-MM			●							●				●	●			
160424R-MM			●							●				●	●			
160430R-MM										●				●	●			
160432R-MM			●							●				●	●			
1604PDSR-MN3														●				
1604PDSR-MN4														●				

E06

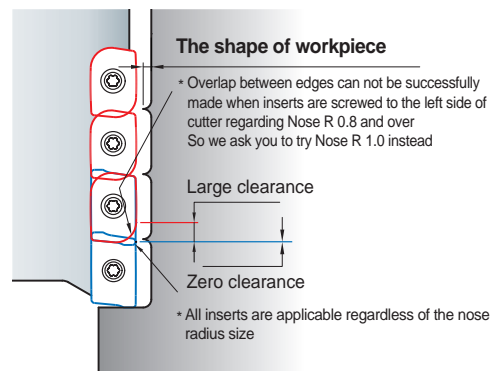
※ Please purchase 2 types of APMT-MN (nick type) inserts with different chip breakers.  
 ※ Please use the cutters with even teeth.

## Parts

Specification		
Ø50~Ø100	FTKA0410	TW15S

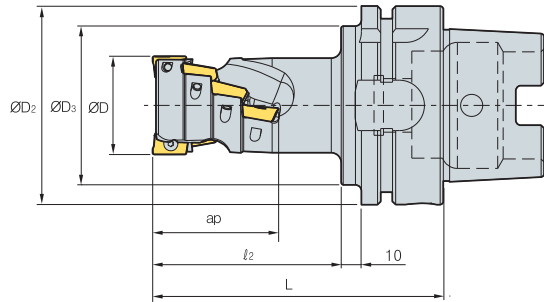
Available inserts E06

## Caution when clamping the inserts





## HSK100A AM4000



(mm)

Designation		$\varnothing D$	$\varnothing D_2$	$\varnothing D_3$	$l_2$	L	No. of flute	ap
HSK100A AM4040046-2	6	40	100	88	75	114	2	46
AM4050061-2	8	50	100	88	95	134	2	61
AM4063061-4	16	63	100	88	90	129	4	61
AM4080076-4	20	80	100	88	105	144	4	76
AM4100076-6	30	100	100	88	105	144	6	76

### Available inserts



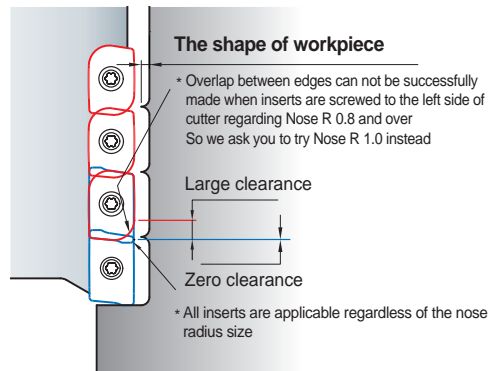
Designation	Material										page	Designation	Material										page													
	Cermet	Coated					Uncoated	Cermet	Coated					Uncoated																						
	CN2500	CN30	NC5330	NCM325	NCM335	NCM535	NCM545	PC2505	PC2010	PC3700	PC6510	PC9530	PC9540	PC5300	PC5400	G10	H01		CN2500	CN30	NC5330	NCM325	NCM335	NCM535	NCM545	PC2505	PC2010	PC3700	PC6510	PC9530	PC9540	PC5300	PC5400	G10	H01	
APMT 1806PDFR-MA																	●	APMT 180624PDER-ML																●		
180604PDFR-MA																	●	180630R-ML																●		
180612PDFR-MA																	●	1806PDSR-MM			●					●	●	●	●	●	●	●	●	●		
180616PDFR-MA																	●	1806PDSR-MF			●					●								●		
180620PDFR-MA																	●	180612PDSR-MM			●					●								●		
180624PDFR-MA																	●	180616PDSR-MM			●					●								●		
180630R-MA																	●	180620PDSR-MM			●					●								●		
1806PDER-ML																	●	180624PDSR-MM			●					●								●		
180604PDER-ML																	●	180630R-MM			●					●								●		
180612PDER-ML																	●	180632R-MM			●					●								●		
180616PDER-ML																	●	1806PDSR-MN3			●					●								●		
180620PDER-ML																	●	1806PDSR-MN4			●					●								●		

※ Please purchase 2 types of APMT-MN (nick type) inserts with different chip breakers.  
 ※ Please use the cutters with even teeth.

### Parts

Specification		
$\varnothing 40 \sim \varnothing 100$	FTKA0410	TW15S

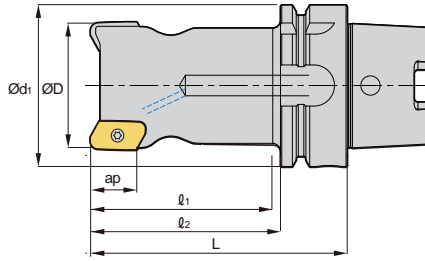
### Caution when clamping the inserts



Available inserts E06



# HSK-XD19 new



AA  
90°  
• AR: 9°~13°  
• RR: -11°~-13°

(mm)

Designation		$\varnothing D$	$\varnothing d_1$	$l_1$	$l_2$	L	ap	
HSK63A- PAV032R-3-100-XD19-A,B	3	32	63	60	74	100	17	0.97
PAV050R-3-100-XD19-A,B	3	50	63	72	74	100	17	1.37

※ Type A uses Insert Nose R 0.4~3.2, and Type B uses Nose R 4.0~5.0  
 ※ When using a spindle at high speed, please check the balance of tool and use it after replacing with the new screw.

## Available inserts

### XDET-MA



Designation	Cermet		Coated							Uncoated		page	Designation	Cermet		Coated							Uncoated		page								
	CN2500	CN30	NC5330	NCM325	NCM335	NCM535	NCM545	PC3700	PC6510	PC9530	PC9540			PC5300	PC5400	PD1005	PD1010	H01	H05	CN2500	CN30	NC5330	NCM325	NCM335		NCM535	NCM545	PC3700	PC6510	PC9530	PC9540	PC5300	PC5400
XDET 190504PEFR-MA													●●	XDET 190524PEFR-MA																		●●	
190508PEFR-MA													●●	190530PEFR-MA																		●●	
190512PEFR-MA													●●	190532PEFR-MA																		●●	
190516PEFR-MA													●●	190540PEFR-MA																		●●	
190520PEFR-MA													●●	190550PEFR-MA																		●●	

## Parts

Specification		
$\varnothing 32\sim\varnothing 50$	PTKA0408-A	TW15S

↻ Available inserts E31    ↻ Available arbors and bolt E426~E428

# E Technical Information for O-ring Cutter

High productivity with optimized grade for high speed machining

## O-ring Cutter

- Optimized for grooving the seat of an O-ring in a plastic mold
- Guarantees superior surface roughness compared to HSS and brazed tool
- High productivity with optimized grade for high speed machining
- Reduced time for regrinding and tool alignment
- Special types are available for quotation

### Code system

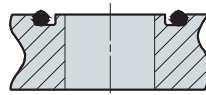
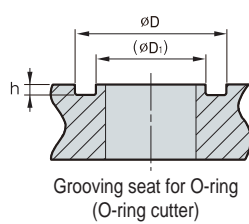
#### • Insert



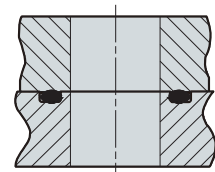
#### • Holder



### Grooving and assembly of O-ring



O-ring on the seat



Engaging the upper punch and lower punch of a plastic mold

(mm)

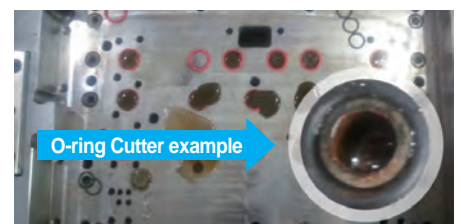
O-ring size	$\phi D$	$(\phi D_1)$	$h \pm 0.05$
P08	11.0	5.8	1.40
P09	12.0	6.8	
P10	13.0	7.8	
P11	15.0	8.5	
P12	16.0	9.5	
P14	18.0	11.5	1.80
P15	19.0	12.5	
P16	20.0	13.5	
P18	22.0	15.5	
P20	24.0	17.5	
P21	25.0	18.5	2.70
P22	26.0	19.5	
P24	30.0	20.6	
P25	31.0	21.6	

O-ring size	$\phi D$	$(\phi D_1)$	$h \pm 0.05$
P26	32.0	22.6	2.70
P28	34.0	24.6	
P29	35.0	25.6	
P30	36.0	26.6	
P31	37.0	27.6	
P32	38.0	28.6	
P34	40.0	30.6	
P35	41.0	31.6	
P38	44.0	34.6	
G40	46.0	36.6	
G25	30.0	21.8	2.40
G30	35.0	26.8	
G35	40.0	31.8	
G40	45.0	36.8	

### Recommended cutting condition

Workpiece	fz (mm/t)	vc (m/min)
		Coating PC3500
Stainless Steel (STS304)	0.03~0.12	60~130
Carbon Steel (SM□□C)	0.05~0.15	80~150
Alloy Steel (SCM)	0.05~0.15	80~150
Hardened Steel (STD, NAK)	0.03~0.12	60~130

### Machining Example



# ORC



(mm)

Designation		ØD	Ød1	Ød	l	L	Available inserts	O-Ring size	
ORC -	P08	1	11.0	5.7	16	30	150	ORG265	P08
	P09	1	12.0	6.7	16	30	150	ORG265	P09
	P10	1	13.0	7.7	16	30	150	ORG265	P10
	P11	1	15.0	8.5	16	30	150	ORG325	P11
	P12	2	16.0	9.5	16	30	200	ORG325	P12
	P14	2	18.0	11.5	20	30	200	ORG325	P14
	P15	2	19.0	12.5	20	30	200	ORG325	P15
	P16	2	20.0	13.5	20	30	200	ORG325	P16
	P18	2	22.0	15.5	20	30	200	ORG325	P18
	P20	2	24.0	17.5	25	30	200	ORG325	P20
	P21	2	25.0	18.5	25	30	200	ORG325	P21
	P22	2	26.0	19.5	25	30	200	ORG325	P22
	P24	2	30.0	20.6	32	40	250	ORG470	P24
	P25	2	31.0	21.6	32	40	250	ORG470	P25
	P26	2	32.0	22.6	32	40	250	ORG470	P26
	P28	2	34.0	24.6	32	40	250	ORG470	P28
	P29	2	35.0	25.6	32	40	250	ORG470	P29
	P30	2	36.0	26.6	32	40	250	ORG470	P30
	P31	2	37.0	27.6	32	40	250	ORG470	P31
	P32	2	38.0	28.6	32	40	250	ORG470	P32
P34	2	40.0	30.6	42	40	250	ORG470	P34	
P35	2	41.0	31.6	42	40	250	ORG470	P35	
P38	2	44.0	34.6	42	40	250	ORG470	P38	
P40	2	46.0	36.6	42	40	250	ORG470	P40	
ORC -	G25	2	30.0	21.9	32	40	250	ORG405	G25
	G30	2	35.0	26.9	32	40	250	ORG405	G30
	G35	2	40.0	31.9	42	40	250	ORG405	G35
	G40	2	45.0	36.9	42	40	250	ORG405	G40

## Available inserts

ORG



Cutter Designation	Designation	Cermet		Coated										Uncoated			page			
		CN2500	CN30	NC5330	NCM325	NCM335	NCM535	NCM545	PC2505	PC2510	PC3700	PC6510	PC9530	PC9540	PC5300	PC5400		ST30A	G10	H01
ORC-P08~P10	ORG 265																			E15
ORC-P11~P22	325																			
ORC-P24~P40	470																			
ORC-G25~G40	405																			

## Parts

Specification		
Ø11~Ø26	FTKA0307	TW09S
Ø30~Ø46	FTGA03508	TW15S
Ø30~Ø45		

Available inserts E15

# E Technical Information for Chamfer Tool

All applications for chamfers

## Chamfer Tool

- All chamfer applications
- Chamfer angles 15°, 30°, 45°, 60° for a variety of customer's needs
- The long cutting-edge provides a wide chamfering range



Back & Front Chamfer Tools



Long Chamfer Tools

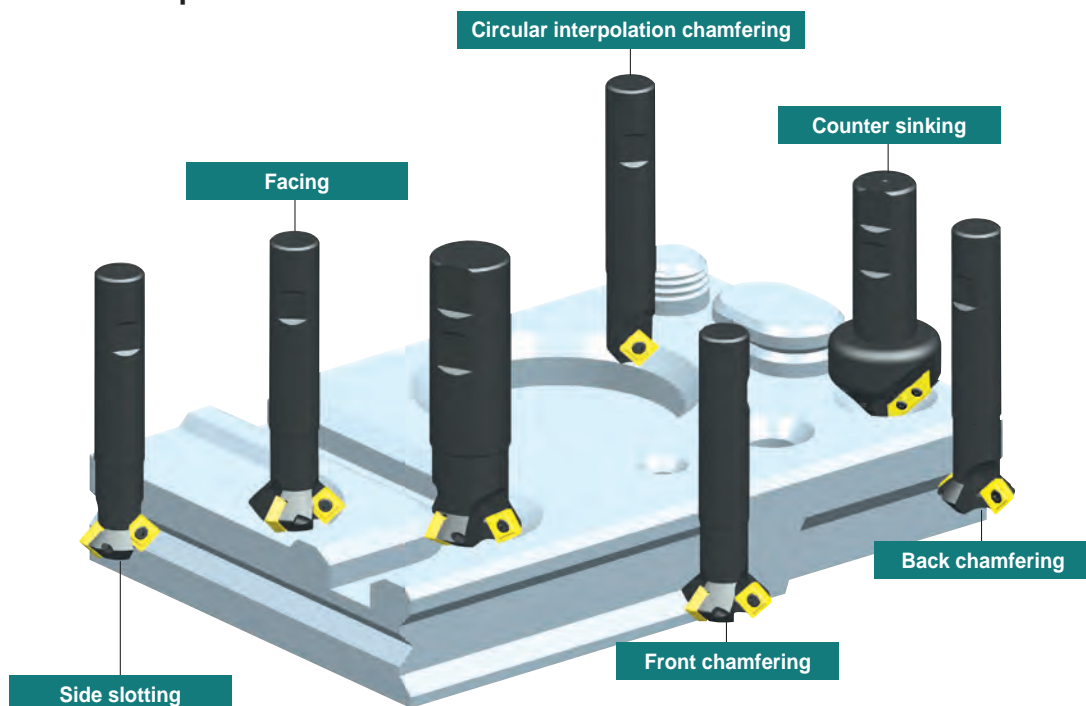
### Code system

CE	45	-	11	25	R	-	S	20
<b>Chamfer Endmill</b>	<b>Chamfer angle</b>		<b>Inscribed circle of insert</b>	<b>Min. Cutting Dia.</b>	<b>Hand</b>		<b>Overall length</b>	<b>Shank Dia.</b>
	45°		11: SPMT110408-KC 12: SPMN120308 31: XCET310404ER-KC	Ø25	R: Right L: Left		S: Standard M: Middle L: Long	Ø20

### Recommended cutting condition

Workpiece	Grades	ØD (Ø5-Ø20)		ØD (Ø25-Ø35)	
		vc (m/min)	fz (mm/t)	vc (m/min)	fz (mm/t)
P	PC3700	160~270	0.05~0.25	160~270	0.05~0.25
	PC5300	190~310		190~310	
	ST30A	60~100		60~100	
M	PC5300	100~160	0.05~0.20	100~160	0.10~0.30
	PC5400	70~120		70~120	
K	PC5300	110~180	0.10~0.30	110~180	0.30~0.50
	G10	50~90		50~90	

### Application example

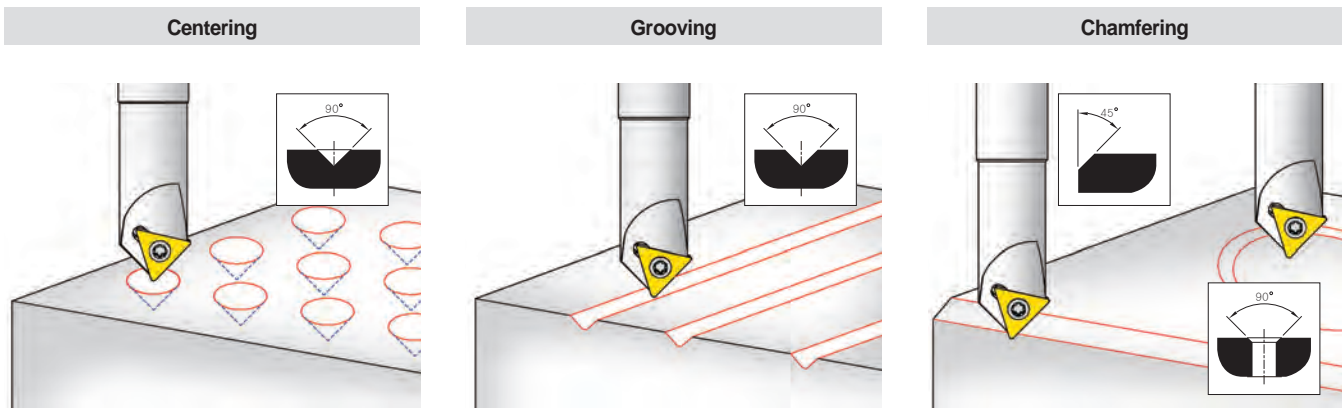


# Multi-functional Chamfer Tool

## Code system

CE	45	- 16	00	R	- S	20
<b>Chamfer Endmill</b>	<b>Chamfer angle</b> 45°	<b>Inscribed circle of insert</b> 16: TWX16R-KC 22: TWX22R-KC	<b>Min. Cutting Dia.</b> Ø0	<b>Hand</b> R: Right L: Left	<b>Overall length</b> S: 90,110 L: 200	<b>Shank Dia.</b> Ø12 Ø20 Ø25

## Application area and recommended cutting condition



Workpiece	Hardness (HRC)	Centering, Grooving		Chamfering	
		vc (m/min)	fz (mm/t)	vc (m/min)	fz (mm/t)
Mild steel, Carbon steel, Alloy steel	Under HRC 30	80~200	0.01~0.04	100~250	0.04~0.06
High Carbon steel, Alloy steel	HRC 30, 40	150~250	0.02~0.06	150~300	0.05~0.10
Aluminum, Copper	-	150~300	0.04~0.08	150~350	0.05~0.10
Cast iron	-	80~150	0.02~0.06	100~250	0.05~0.10
Stainless steel	-	60~120	0.01~0.03	60~150	0.03~0.06
HRSA	-	60~80	0.01~0.03	60~100	0.03~0.06

Note) Please keep fz. backtouch & chipping one caused by wrong fz

## Machining example

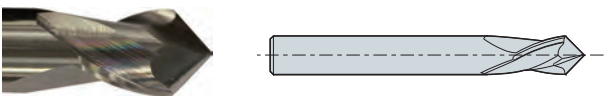
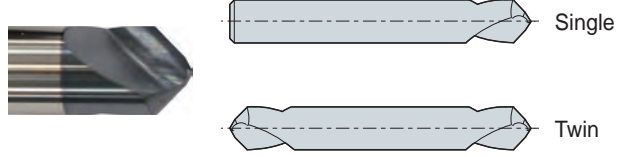


## Solid Chamfer Tool

### Code system

CCT	090	T	-	080	L
<b>Type</b>	<b>Chamfer angle</b>	<b>Cutting-edge</b>		<b>Diameter</b>	<b>Tool length</b>
CCT: Centering & Chamfering Tool CET: Centering & Chamfering Endmill Tool	060: 60° 090: 90° 120: 120°	None: Single T: Twin		080: Ø8.0	None: Standard L: Long

### Features

CET (Centering & Chamfering Endmill Tool)	CCT (Centering & Chamfering Tool)
	
<ul style="list-style-type: none"> <li>• For internal chamfering up to 0.5 mm</li> <li>• Can be applied to side milling and easy to regrinding</li> </ul>	<ul style="list-style-type: none"> <li>• Chipping resistance realizes machining in high speed due to double point angle</li> <li>• Lowers cutting load due to web thinning</li> </ul>

### CET/CCT Application example

Type	Centering	Hole Chamfering	Chamfering (External)	Chamfering (Internal)	Side milling	Slot milling
Applications (CET)						
60°	×	●	●	●~▲	●	×
90°	▲	●	●	●	●	●~▲
120°	●	●	●	●	●	●
Applications (CCT)						
60°	●	●	●~▲	▲~×	×	×
90°	●	●	●~▲	▲~×	×	×
120°	●	●	●	●	×	●





# CE (Back & Front)

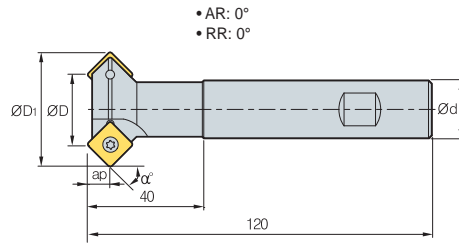


Fig. 1

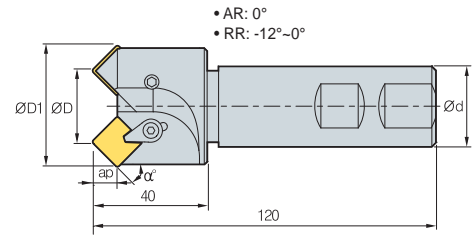


Fig. 2



(mm)

Designation	ØD	ØD1	Ød	ap	Fig.	Available inserts	α° (Chamfer angle)		Machining range (Min-Max)	Uses
							Front	Back		
CE	15-1125R-S20	25	30.5	20	9.5	SPMT110408-KC	15°	-	Ø25-Ø30	Front chamfering
	30-1125R-S20	25	35.5	20	8.5		30°	60°	Ø25-Ø35	Front, Back chamfering
	45-1107R-S20	7	21.9	20	7.0		45°	-	Ø7-Ø21	Front chamfering
	45-1119R-S20	19	33.9	20	7.0		45°	45°	Ø19-Ø33	Front, Back chamfering
	45-1125R-S20	25	39.9	20	7.0		45°	45°	Ø25-Ø39	Front, Back chamfering
	60-1125R-S32	25	43.3	32	5.0		60°	30°	Ø25-Ø42	Front, Back chamfering
	45-1207R-S32	7	23.3	32	7.8	SPMN120308	45°	-	Ø7-Ø22	Front chamfering
	45-1220R-S32	20	37.3	32	7.8		45°	-	Ø21-Ø36	Front chamfering
	45-1225R-S32	25	42.3	32	7.8		45°	-	Ø26-Ø41	Front chamfering
	45-1235R-S32	35	52.3	32	7.8		45°	-	Ø36-Ø51	Front chamfering

## Available inserts

SPMT-KC      SPMN



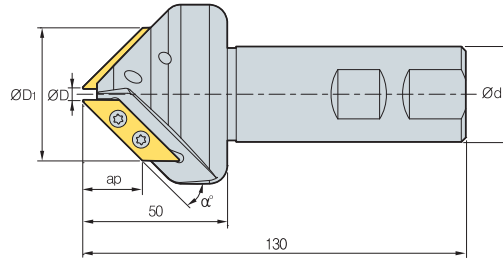
Designation	Cermet		Coated											Uncoated			page	
	CN2500	CN30	NC5330	NCM325	NCM335	NCM535	NCM545	PC2505	PC2510	PC3700	PC6510	PC9530	PC9540	PC5300	PC5400	ST30A		G10
SPMT 110408-KC										●						●	●	
SPMN 120308																●		

## Parts

Specification	Screw	Clamp	C-Ring	Wrench	Wrench
Ø7-Ø25 (1100 type)	FTKA0408	-	-	TW15S	-
Ø7-Ø35 (1200 type)	CHX0617L	CH6R2	CR05	-	HW30L

Available inserts E27

## CE (Long chamfer)



- AR: -5°~1°
- RR: 0°

(mm)

Designation		ØD	ØD <sub>1</sub>	Ød	ap	α° (Chamfer angle)	Machining range (Min-Max)	Uses
<b>CE</b> 30-3105R-S32	1	5	35	32	26	30°	Ø5~Ø35	Front Chamfering
45-3105R-S32	2	5	48	32	21	45°	Ø5~Ø48	Front Chamfering
60-3105R-S32	2	5	57	32	15	60°	Ø5~Ø57	Front Chamfering

### Available inserts

XCET-KC



Designation	Cermet		Coated										Uncoated			page			
	CN2500	CN30	NC5330	NCM325	NCM335	NCM535	NCM545	PC2505	PC2510	PC3700	PC6510	PC9530	PC9540	PC5300	PC5400		ST30A	G10	H01
XCET 310404ER-KC										●						●	●		E31

### Parts

Specification		
Ø5	FTKA03510	TW15S

Available inserts E31



# CE (Multi-functional)

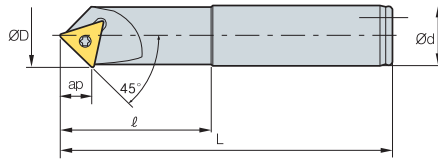


Fig. 1

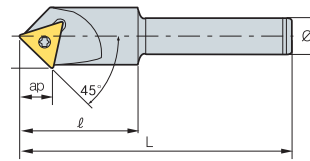


Fig. 2



- AR: -12°~15°
- RR: 0°

(mm)

Designation	ØD	Ød	ℓ	L	ap	Fig.	Available Inserts	Machining range (Min-Max)	Uses	
CE	45-1600R-S12	21.2	12	40	90	10	2	TWX16R-KC	Ø0 ~ Ø20	Centering Grooving Chamfering
	45-1600R-S20	21.2	20	50	110	10	1	TWX16R-KC	Ø0 ~ Ø20	
	45-1600R-L20	21.2	20	60	200	10	1	TWX16R-KC	Ø0 ~ Ø20	
	45-2200R-S12	28.8	12	40	90	14	2	TWX22R-KC	Ø0 ~ Ø27	
	45-2200R-S25	28.8	25	50	110	14	1	TWX22R-KC	Ø0 ~ Ø27	
	45-2200R-L25	28.8	25	60	200	14	1	TWX22R-KC	Ø0 ~ Ø27	


## Available inserts

TWX-KC



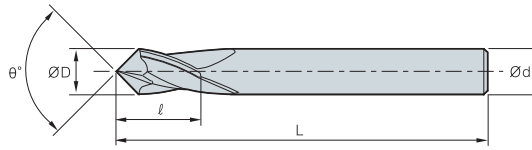
Designation	Cermet		Coated										Uncoated			page			
	CN2500	CN30	NC5330	NCM325	NCM335	NCM535	NCM545	PC2505	PC2510	PC3700	PC6510	PC9530	PC9540	PC5300	PC5400		ST30A	G10	H01
TWX 16R-KC										●				●					E29
TWX 22R-KC									●										

## Parts

Specification	 Screw	 Wrench
Ø22~Ø29	FTNA0408	TW15L

Available inserts E29

## CET

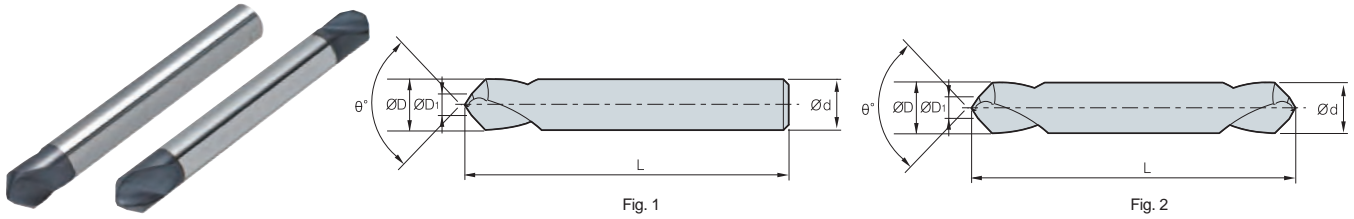


(mm)

Designation	ØD	Ød	ℓ	L	θ°
CET060 -	030	3	3	5.5	60°
	040	4	4	7	
	060	6	6	10	
	080	8	8	13	
	100	10	10	16	
	120	12	12	18	
	160	16	16	24	
CET090 -	030	3	3	5.5	90°
	040	4	4	7	
	060	6	6	10	
	080	8	8	13	
	100	10	10	16	
	120	12	12	18	
	160	16	16	24	
CET120 -	030	3	3	5.5	120°
	040	4	4	7	
	060	6	6	10	
	080	8	8	13	
	100	10	10	16	
	120	12	12	18	
	160	16	16	24	

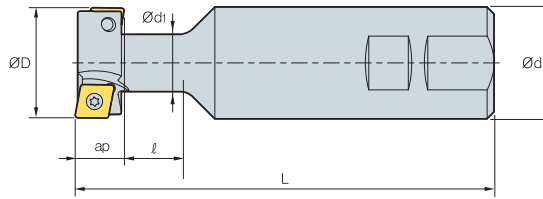
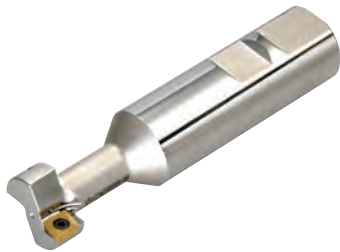


# CCT



(mm)						
Designation	$\text{ØD} = \text{Ød}$	$\text{ØD}_1$	L	$\theta^\circ$	Fig.	
CCT060 -	030	3	1.0	60°	1	
	040	4	1.5			
	060	6	2.0			
	080	8	2.5			
	100	10	3.0			
	120	12	4.0			
	160	16	5.0			
CCT060T -	030	3	1.0		2	
	040	4	1.5			
	060	6	2.0			
	080	8	2.5			
	100	10	3.0			
	120	12	4.0			
	160	16	5.0			
CCT060T -	030L	3	1.0	100	2	
	040L	4	1.5			
	060L	6	2.0			
	080L	8	2.5			
	100L	10	3.0			
	120L	12	4.0			
	150L	15	4.0			
CCT090 -	030	3	1.0	90°	1	
	040	4	1.5			
	060	6	2.0			
	080	8	2.5			
	100	10	3.0			
	120	12	4.0			
	160	16	5.0			
CCT090T -	030	3	1.0		40	2
	040	4	1.5			
	060	6	2.0			
	080	8	2.5			
	100	10	3.0			
	120	12	4.0			
	160	16	5.0			
CCT090T -	030L	3	1.0	100	2	
	040L	4	1.5			
	060L	6	2.0			
	080L	8	2.5			
	100L	10	3.0			
	120L	12	4.0			
	150L	15	4.0			
CCT120 -	030	3	1.0	120°	1	
	040	4	1.5			
	060	6	2.0			
	080	8	2.5			
	100	10	3.0			
	120	12	4.0			
	160	16	5.0			
CCT120T -	030	3	1.0		40	2
	040	4	1.5			
	060	6	2.0			
	080	8	2.5			
	100	10	3.0			
	120	12	4.0			
	160	16	5.0			
CCT120T -	030L	3	1.0	100	2	
	040L	4	1.5			
	060L	6	2.0			
	080L	8	2.5			
	100L	10	3.0			
	120L	12	4.0			
	150L	15	4.0			

## TFE



AA  
90°  
•AR: 5°  
•RR: -5°

(mm)

Designation		ØD	Ød	Ød1	ℓ	L	ap	Available inserts	
TFE	2125R/L	2	21	25	10.5	20	109	9	CPMT06
	2525R/L	2	25	25	12.5	21	112	11	CPMT08
	3232R/L	2	32	32	16.5	26	120	14	CPMT09
	4032R/L	2	40	32	20.5	32	130	18	CPMH12
	5032R/L	4	50	32	26.5	38	140	22	CPMH12

### Available inserts

CPMT CPMH

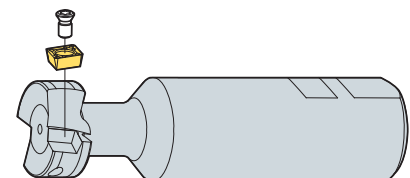


Designation	Cermet		Coated										Uncoated			page			
	CN2500	CN30	NC6330	NCM325	NCM335	NCM535	NCM545	PC2505	PC2510	PC3700	PC6510	PC9530	PC9540	PC5300	PC5400		ST30A	G10	H01
CPMT	060204-MM									●									E08
	080308-MM									●									
	09T308-MM									●									
CPMH	120408-MM									●									

### Parts

Specification	Screw	Wrench
Ø21	FTNA02555	TW08S
Ø25	FTNA0306	TW09S
Ø32	FTNA0407	TW15S
Ø40	PTMA0511A	TW15S
Ø50		

Assembling



Available inserts E08

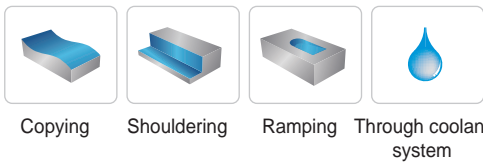


Inserts feature a buffed top surface ensuring better chip control and reducing built-up edge

# Pro-A Mill

- Buffed top face of insert ensures good chip control and reduces built-up edge
- Small size modular type for aluminum machining
- Various line up of modular system for aluminum machining
- For shouldering, curved surface and ramping
- High rake angle chip breaker ensures excellent surface roughness, improved cooling effects, and chip control by through coolant system, even in deep pocket machining

## Uses



## Pro-A Mill series

Type	Available inserts and tool holders	Through coolant system
Application of small-sized Aluminum machining <b>Pro-A 2000</b>	<ul style="list-style-type: none"> <li>• Modular: Ø12~Ø42</li> <li>• Shank: Ø12~Ø42</li> <li>• Insert: VDKT11T210N-MA VDKT11T220N-MA</li> </ul>	○
General application of Aluminum machining <b>Pro-A 4000</b>	<ul style="list-style-type: none"> <li>• cutter: Ø40~Ø100</li> <li>• Shank: Ø32~Ø40</li> <li>• Insert: VCKT220530N-MA</li> </ul>	○

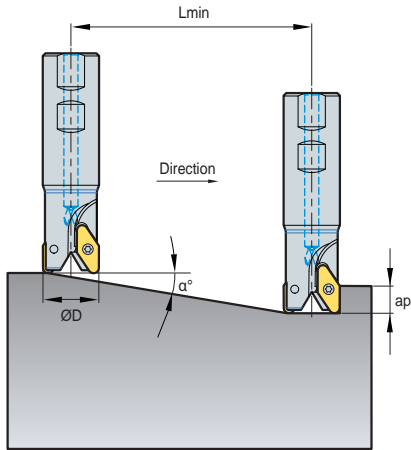
## Recommended cutting condition

Workpiece		Cutting speed $v_c$ (m/min)
Aluminum alloy	Rm < 280 MPa	1000
	Rm > 280 MPa	800
Copper alloy	Long chip	250
Thermo plastic	-	300
Aluminum alloy	Si < 12%	800
Copper alloy	Short chip	400
Magnesium alloy	-	400
Duroplastics	-	150

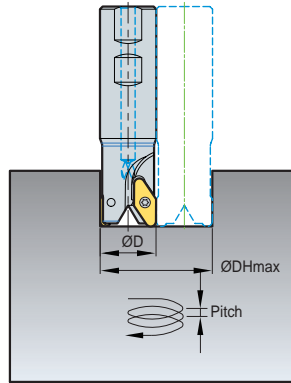


## Pro-A Mill ramping & helical cutting technical data

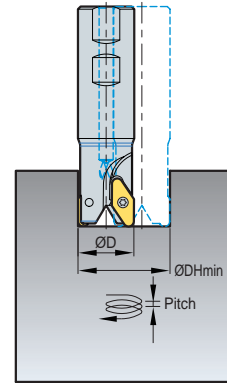
1. Ramping



2. Blind hole helical cutting



3. Thru hole helical cutting



(mm)

Designation	ØD	Ramping		Blind hole helical cutting				Thru hole helical cutting	
		α°	Lmin	ØDHmin	dmax	ØDHmax	dmax	ØDHmin	dmax
PAS2012HR	12	11.9	38	21	4.4	23	4.8	19	4.0
PAS2016HR	16	12.5	36	29	6.4	31	6.9	27	6.0
PAS2020HR	20	9.7	47	37	6.3	39	6.7	35	6.0
PAS2025HR	25	7.6	60	47	6.3	49	6.5	45	6.0
PAS2032HR	32	5.8	79	61	6.2	63	6.4	59	6.0
PAS2042HR	42	4.3	105	81	6.2	83	6.3	79	6.0
PAS4032HR	32	24.4	22	54	15.0	59	26.8	40	15.0
PAS4040HR	40	18.4	30	70	15.0	75	25.0	56	15.0
PAS4050HR	50	14.0	40	90	15.0	95	23.8	76	15.0
PAS4063HR	63	10.7	53	116	15.0	121	22.8	102	15.0
PAC(M)4080HR	80	8.1	70	150	15.0	155	22.1	136	15.0
PAC(M)4100HR	100	6.3	90	190	15.0	195	21.7	176	15.0

- Lmin: When ap = 8 mm
- Lmin: Minimum inclination cutting length

$$Lmin = \frac{ap}{\tan \alpha^\circ} \text{ (mm)}$$

α°: Max. rampig angle  
ap: Depth of cut

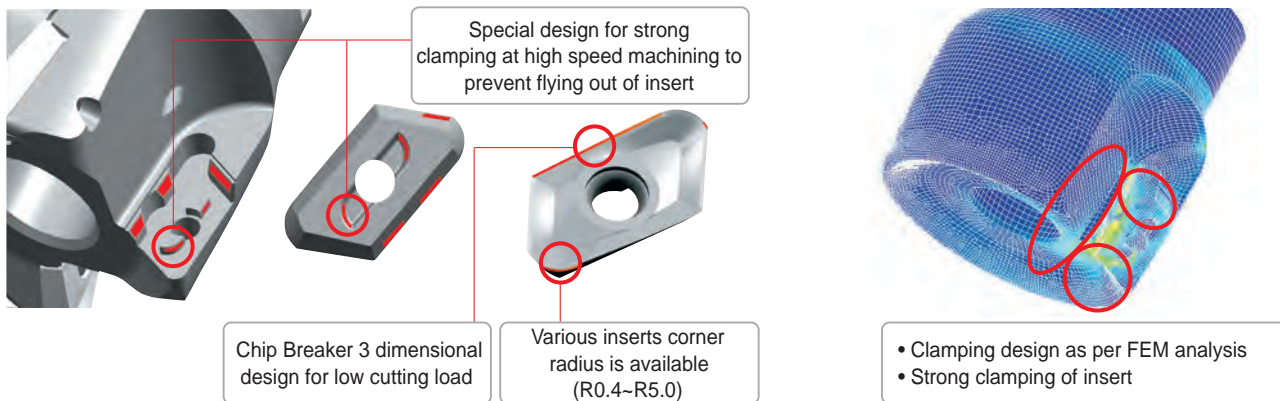


Features a strong clamping provided by the concave grooves on the back surface of the inserts

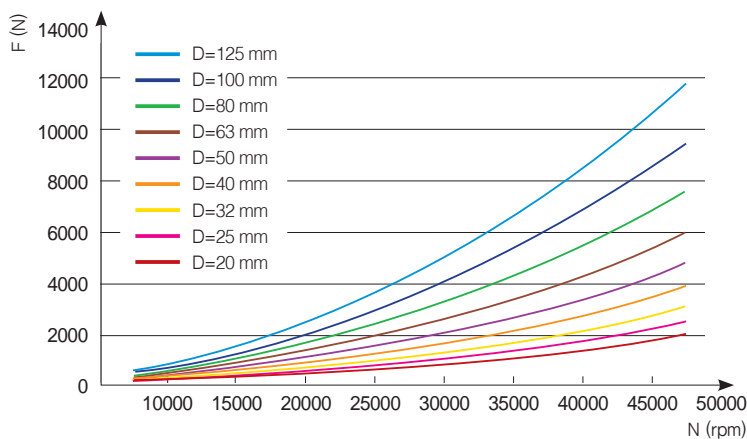
# Pro-X Mill

- Inserts feature a buffed top surface ensuring a smoother chip evacuation and reducing built-up edge
- High rake angle of insert provides good surface finish and low cutting load
- Specially designed for high speed machining of aluminum
- Suitable for square shouldering and curved surface machining

## Clamping system for high speed



## Centrifugal force as per RPM



※ Screw Torque = 4 N·m  
※ Indexable insert: 6.8g

Marking [• Designation • Max. RPM]



## Max. RPM as per cutting diameter

Cutting diameter ØD (mm)	5000 type		6000 type	
	n (min <sup>-1</sup> )	vc (m/min)	n (min <sup>-1</sup> )	vc (m/min)
20	14,000	879	-	-
25	28,000	2,199	15,000	1,178
32	25,000	2,513	23,000	2,312
40	22,000	2,764	20,000	2,513
50	20,000	3,141	18,000	2,827
63	18,000	3,562	16,000	3,166
80	16,000	4,021	14,000	3,518
100	14,000	4,398	13,000	4,084
125	13,000	5,105	11,000	4,319

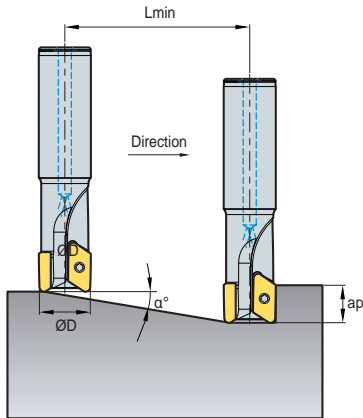
※ In case of actual machining accidental breakage of insert or tool could happen even under the written RPM special cover or door is necessary to prevent damage from broken insert or broken tool

## Recommended cutting condition

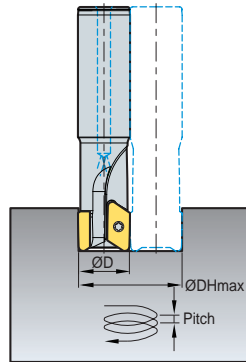
Workpiece		Cutting Speed vc (m/min)	Feed fz (mm/t)
Aluminum alloy	Rm280 < MPa	1200	0.30
	Rm280 > MPa	1000	0.25
Copper alloy	Long chipping	400	0.20
	Thermo plastic	350	0.15
Aluminum alloy	Si < 12%	1000	0.25
	Si ≥ 12%	300	0.23
Copper alloy	Short chipping	500	0.20
Magnesium alloy	-	450	0.20
Duroplastics	-	200	0.15

## Pro-X Mill ramping & helical cutting technical data

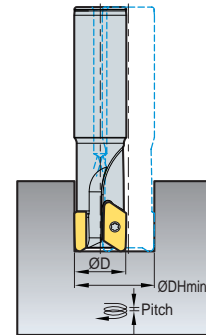
1. Ramping



2. Blind hole helical cutting



3. Thru hole helical cutting



(mm)

Designation	ØD	Ramping		Blind hole Helical cutting				Thru hole Helical cutting	
		α°	Lmin	ØDHmin	dmax	ØDHmax	dmax	ØDHmin	dmax
PAXS5020HR	20	8.4	68	32	4.7	34	5.0	27	4.0
PAXS5025HR	25	13.2	43	42	9.9	44	10.4	34	8.0
PAXS5032HR	32	9.5	60	56	9.3	58	9.7	48	8.0
PAXS5040HR	40	7.1	80	72	9.0	74	9.3	64	8.0
PAXCM5050HR	50	5.4	105	92	8.8	94	9.0	84	8.0
PAXCM5063HR	63	4.2	138	118	8.6	120	8.7	110	8.0
PAXC(M)5080HR	80	3.2	180	152	8.4	154	8.6	144	8.0
PAXC(M)5100HR	100	2.5	230	192	8.3	194	8.4	184	8.0
PAXC(M)5125HR	125	2.0	293	242	8.3	244	8.3	234	8.0
PAXS6025HR	25	9.0	63	42	6.6	44	6.9	38	6.0
PAXS6032HR	32	6.6	87	56	6.5	58	6.7	52	6.0
PAXS6040HR	40	12.1	47	72	15.4	74	15.9	56	12.0
PAXCM6050HR	50	9.0	63	92	14.5	94	14.8	76	12.0
PAXCM6063HR	63	6.7	85	118	13.9	120	14.1	102	12.0
PAXC(M)6080HR	80	5.0	113	152	13.4	154	13.6	136	12.0
PAXC(M)6100HR	100	3.9	147	192	13.1	194	13.2	176	12.0
PAXC(M)6125HR	125	3.0	188	242	12.8	244	13.0	226	12.0

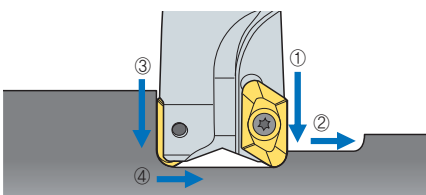
• Lmin: When ap = 10mm

• Lmin: Minimum inclination cutting length  $Lmin = \frac{ap}{\tan \alpha^\circ}$  (mm)

α°: Max. ramping angle

ap: Depth of cut

## Plunging, slotting, drilling technical data



1. When drilling, grooving machining sequence is

① → ② → ③ → ④

2. When drilling, grooving, decrease the feed and cutting speed 30%~50% from the recommended data

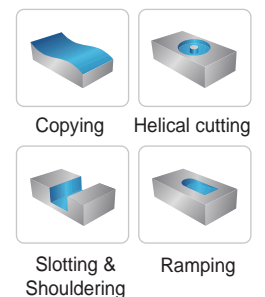
### • Cutting condition for drilling

Holder	ap (mm)	
	5000 type	6000 type
Ø20	8	-
Ø25	4	11
Ø32	4	6
Ø40~125	4	6

Insert	ap (mm)
XETK19	4
XETK25	6

### • Uses

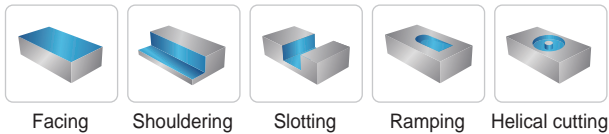


New indexable milling tool for the machining of high quality workpieces

# Pro-L Mill

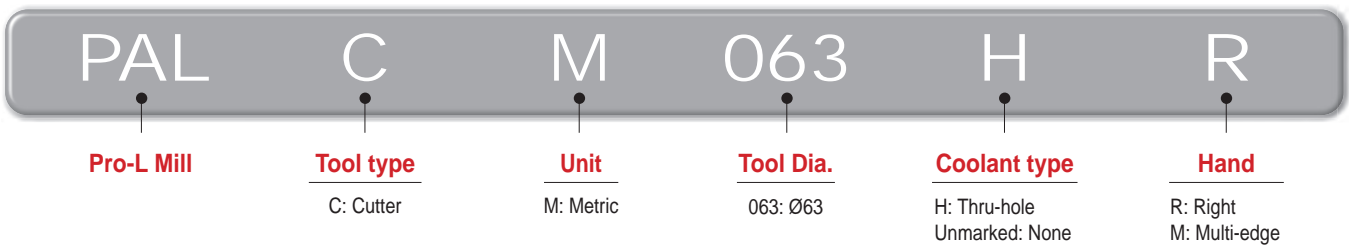
- Improved perpendicularity and lower cutting resistance due to the combined design of the clearance face and high helix edge of these inserts
- Productivity increase due to more than half as much of depth of cut comparing to existing product
- Strong clamping design by adaption of double screw on system
- Improved chip flow due to helical type design of chip pocket and application of coolant system

**Uses**

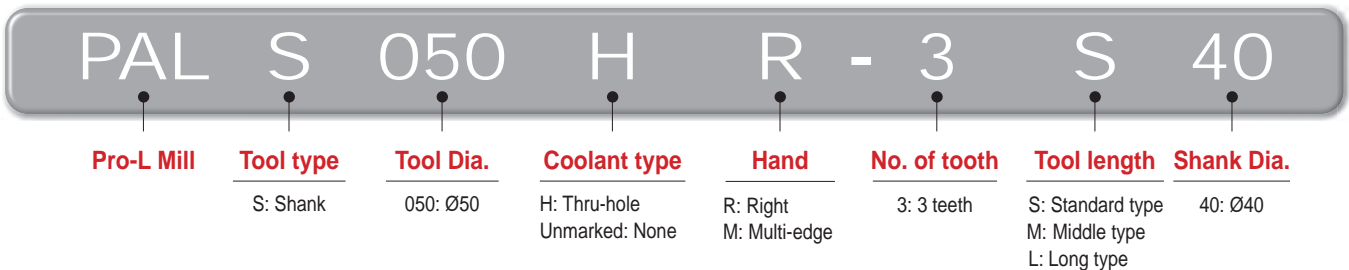


**Code system**

• **Cutter**



• **Shank**



**Features**



**Features of chip breakers**

Insert	Cutting-edge	Uses	Features
MA		Al	Edge optimized for aluminum machining and buffed finish ensuring an excellent machining quality
ML		Hard-to-cut material	Design of low cutting resistance chip breaker ensures excellent machining quality for light cutting and hard-to-cut material

## Selection of grades and chip breaker

Category	M (Stainless steel)	N (Aluminum alloy)	S (HRSA)
Grades	PC5300/PC5400	H01	PC5300/PC5400
MA	-	○	-
ML	○	-	○

## Application examples

Al6061 (HRC30)

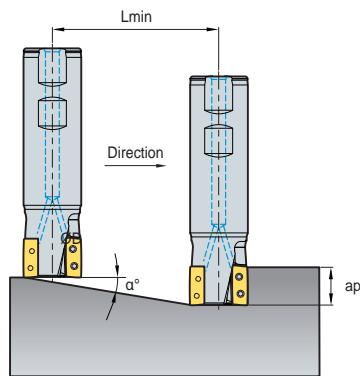
### Cutting condition

vc = 500 m/min, fz = 0.2 mm/t, ap = 30~60 mm,  
ae = 1~5 mm (finishing: 1 mm, roughing: 5 mm), z = 3

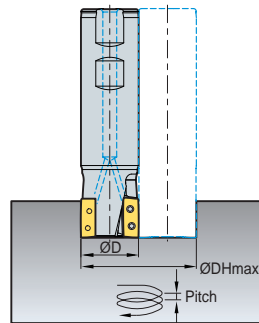


## Pro-L Mill ramping & helical cutting technical data

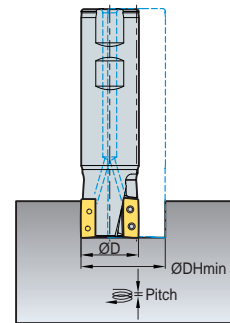
1. Ramping



2. Blind hole helical cutting



3. Thru hole helical cutting



(mm)

Designation	ØD	Ramping		Blind hole helical cutting				Thru hole helical cutting	
		α°	Lmin	ØDHmin	dmax	ØDHmax	dmax	ØDHmin	dmax
PALS032HR-2S20	32	3.37	170	60	3.5	62	3.6	55	3.2
PALS032HR-2S25	32	3.37	170	60	3.5	62	3.6	55	3.2
PALS032HR-2S32	32	3.37	170	60	3.5	62	3.6	55	3.2
PALS040HR-2S32	40	2.12	270	76	2.8	78	2.9	71	2.6
PALS040HR-2S40	40	2.12	270	76	2.8	78	2.9	71	2.6
PALS040HR-2S42	40	2.12	270	76	2.8	78	2.9	71	2.6
PALS040HR-3S32	40	2.12	270	76	2.8	78	2.9	71	2.6
PALS040HR-3S40	40	2.12	270	76	2.8	78	2.9	71	2.6
PALS040HR-3S42	40	2.12	270	76	2.8	78	2.9	71	2.6
PALS050HR-3S32	50	2.08	275	96	3.5	98	3.6	91	3.3
PALS050HR-3S40	50	2.08	275	96	3.5	98	3.6	91	3.3
PALS050HR-3S42	50	2.08	275	96	3.5	98	3.6	91	3.3
PALS063HR-4S32	63	1.76	325	122	3.8	124	3.8	117	3.6
PALS063HR-4S40	63	1.76	325	122	3.8	124	3.8	117	3.6
PALS063HR-4S42	63	1.76	325	122	3.8	124	3.8	117	3.6
PALS063HM-4S32	63	1.76	325	122	3.8	124	3.8	117	3.6
PALS063HM-4S40	63	1.76	325	122	3.8	124	3.8	117	3.6
PALS063HM-4S42	63	1.76	325	122	3.8	124	3.8	117	3.6
PALCM063HR	63	1.76	325	122	3.8	124	3.8	117	3.6

• Lmin: When ap = 10 mm

• Lmin: Minimum inclination cutting length

$$Lmin = \frac{ap}{\tan \alpha^\circ} \text{ (mm)}$$

α° : Max. ramping angle

ap : Depth of cut

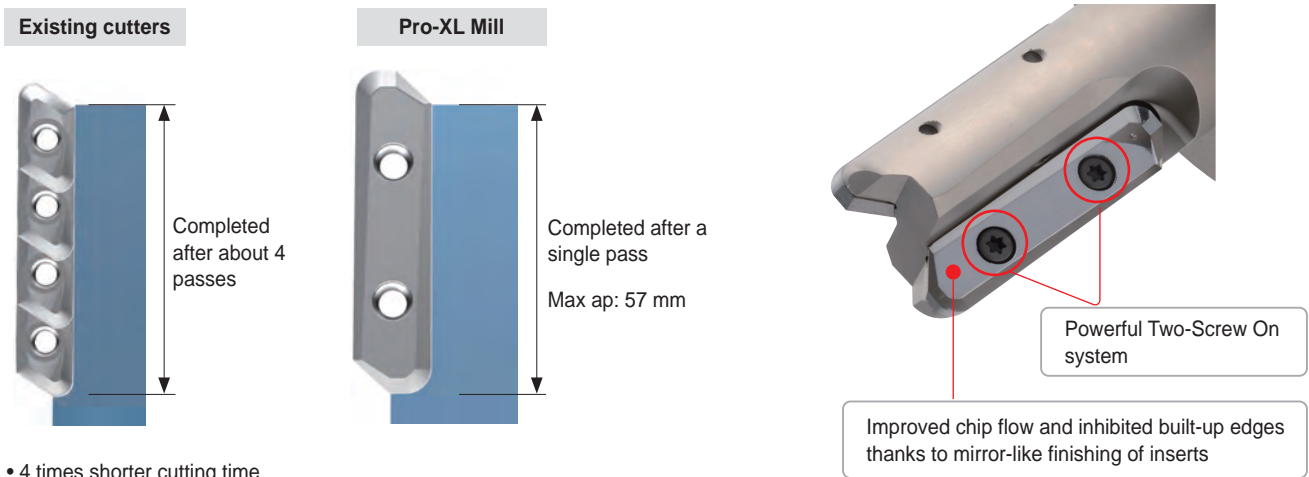


Deep cutting milling tools to maximize productivity in aluminum machining

Pro-XL Mill **new**

- **Productivity** - Cutting time is shortened by finishing the process with a single pass of deep shouldering in aluminum machining
- **High quality** - Shouldering within a single pass enables walls with perfect perpendicularity
- **Clamping stability** - Two-Screw On system secures clamping stability

➤ Features of Pro-XL Mill



- 4 times shorter cutting time
- Satisfactory surface finish of side faces with no need for further processing

➤ Application examples

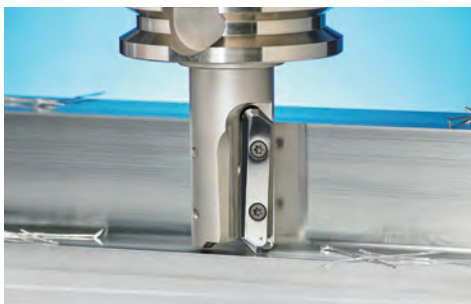
Al7075

■ Cutting condition

vc = 500 m/min, fz = 0.25 mm/t  
 ap = 56 mm, ae = 1 mm  
 z = 2

■ Tools

**Insert** LDET650550PPFR-MA  
**Grades** H01  
**Holder** BT50-PXL04090HR-2F (ØD = 40 mm)



# E Technical Information for Pro-V Mill

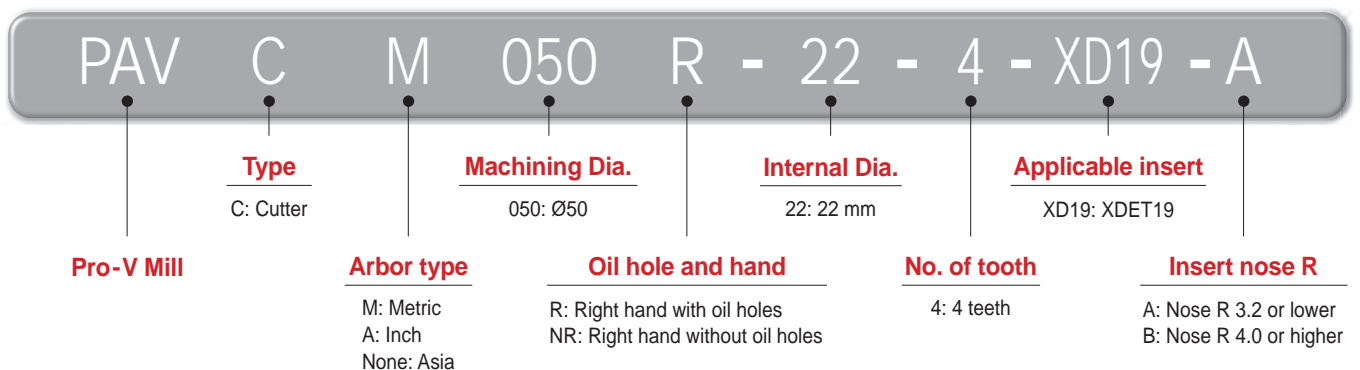
The Premium High-Speed Milling Tool for Aluminum

## Pro-V Mill new

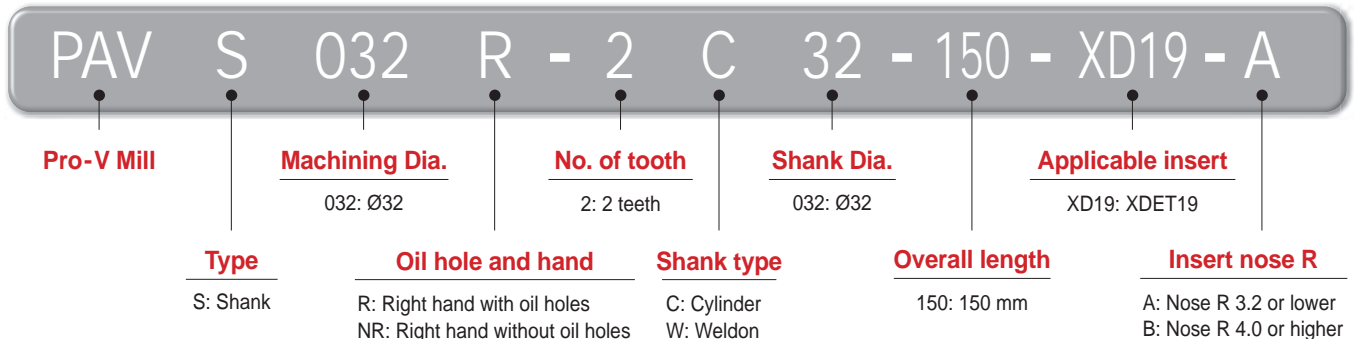
- **Enhanced productivity**- Increased productivity due to high speed capability
- **Improved surface finish**- Excellent surface finish and perpendicularity with high-precision products
- **Excellent clamping stability**- Satisfactory clamping force of inserts by the use of the key shape

### Code system

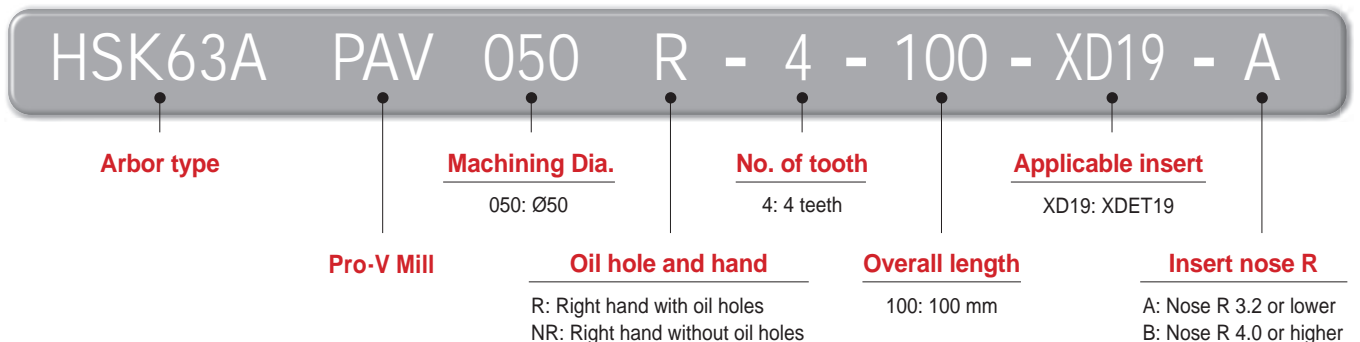
#### • Cutter



#### • Shank



#### • Tooling System



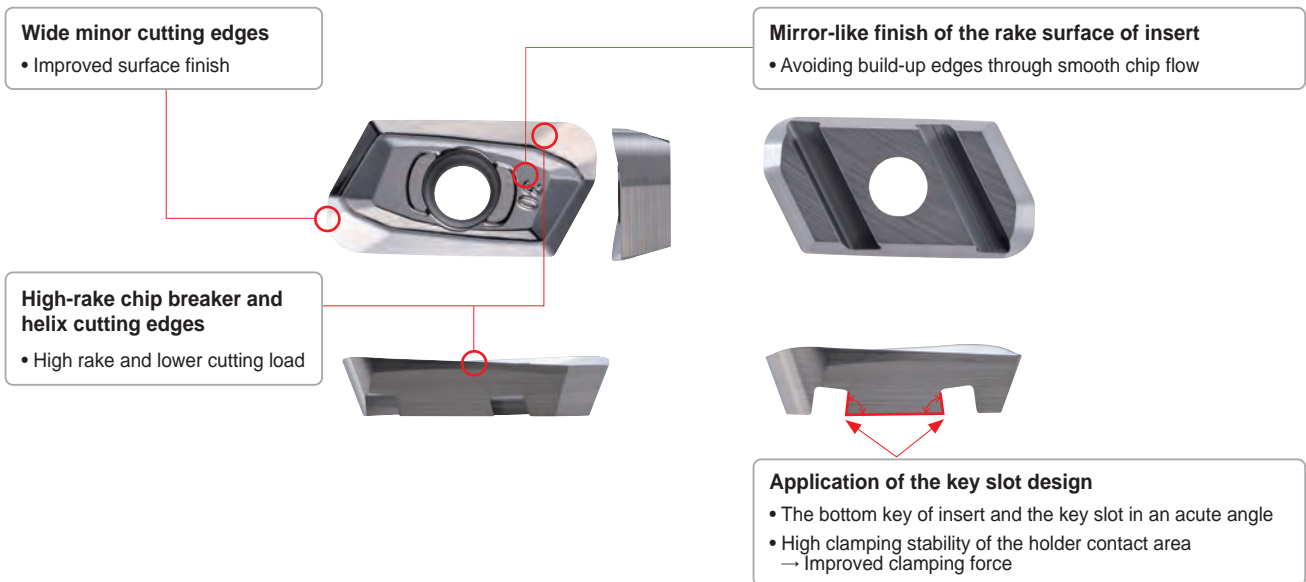


## ➤ Cutter Features


- The combined clamping system of the key to key slot structure and simple screw-on type ensures strong clamping force
  - Stable machining / prevention of insert breakage
- Avoiding uplifting problems of insert due to axial acute-angle clamping of cutters
  - Reduced vibrations and excellent surface finish



## ➤ Insert Features



## ➤ Features of chip breaker

Insert	Cutting-edge	Uses	Features
MA		For non-ferrous metals	Ensuring satisfactory machining quality with the application of mirror-like cutting edges optimized for aluminum machining

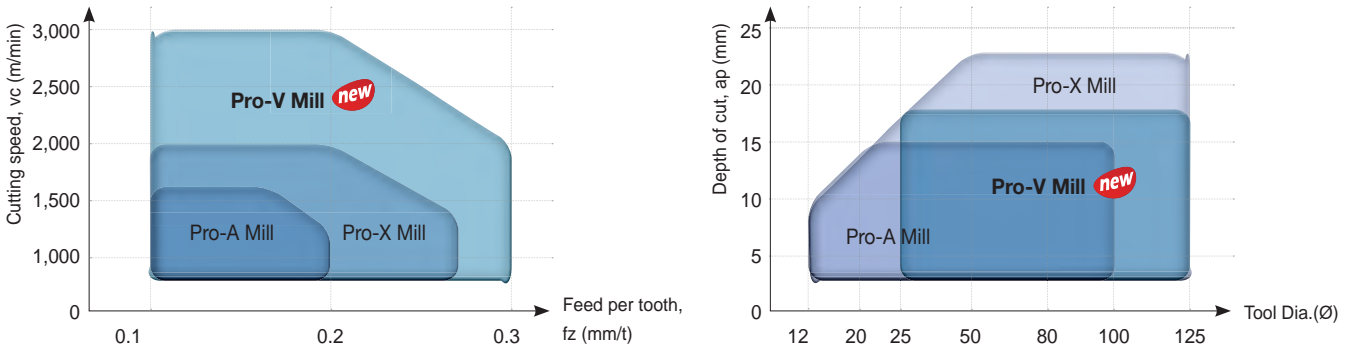
# E Technical Information for Pro-V Mill

## Recommended cutting condition

Workpiece		Grade	vc (m/min)	Max. ap (mm)
N	Aluminum	Si ≤ 5% (Si Lower than 5%)	H01	1,300 (500 - 2,200)
			H05	1,000 (300 - 1,700)
			PD1005	1,500 (500 - 3,000)
		Si ≤ 10% (Si Lower than 10%)	PD1010	1,200 (300 - 2,200)
				17

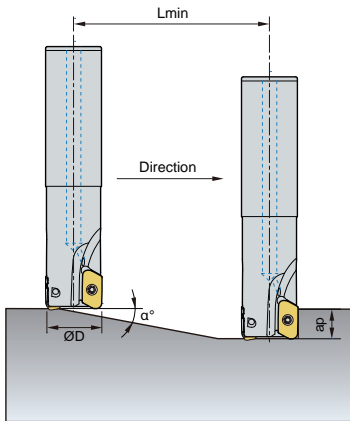
\* The recommended cutting conditions above are a general guideline. Their details may vary depending on the machining method of users and other conditions.

## Application area

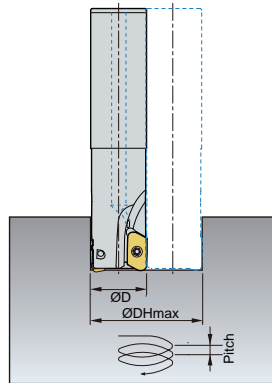


## Pro-V Mill ramping & helical cutting technical data

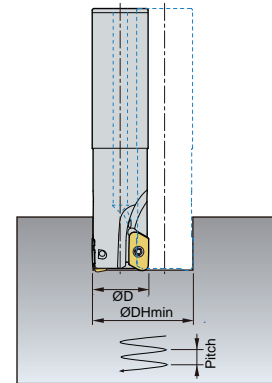
### 1. Ramping



### 2. Blind hole helical cutting



### 3. Thru hole helical cutting



(mm)

ØD	Ramping		Blind hole helical cutting				Thru hole helical cutting	
	α°	Lmin	ØDHmin	dmax	ØDHmax	dmax	ØDHmin	dmax
25	15.0	59	41	13.0	44	15.5	27	2.0
32	10.0	99	55	11.0	58	12.5	41	4.5
40	7.0	142.5	71	10.5	74	11.5	57	6.0
50	5.0	200	91	10.0	94	10.5	77	6.5
63	3.5	286	117	9.2	120	9.5	103	7.0
80	2.6	385	151	9.0	154	9.5	137	7.3
100	2.0	501	191	9.0	194	9.0	177	7.6
125	1.5	668	241	8.5	244	8.5	227	7.5

• When ramping and helical milling, table feed, vf (mm/min) should be lower than 70% of the recommended cutting conditions.

• When helical milling, Max. pitch, DHmax should be lower than max. depth of cut, ap.

• When ramping, the depth of cut should be lower than max. depth of cut, ap.

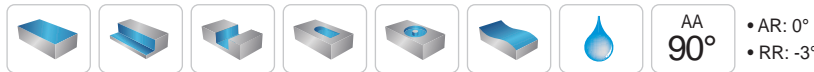
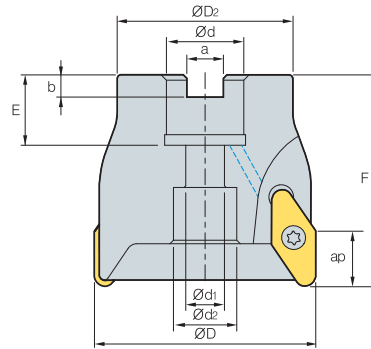
• Lmin:  $ap/\tan(\alpha^\circ)$  (mm)

• Lmin: Minimum inclination cutting length  
α° : Max. ramping angle

ap : Depth of cut



# PAC(M)2000/4000



Designation		ØD	ØD2	Ød	Ød1	Ød2	a	b	E	F	ap		
PACM	2040HR	3	40	34	16	9	14	8.4	5.6	18	40	8.7	0.2
	2050HR	4	50	42	22	11	18	10.4	6.3	22	50	8.7	0.4
	2063HR	5	63	49	22	11	18	10.4	6.3	22	50	8.7	0.6
	2080HR	5	80	57	27	14	20	12.4	7.0	25	50	8.7	0.9
	2100HR	6	100	67	32	18	26	14.4	8.0	30	63	8.7	1.9
	4040HR	3	40	32	16	9	11.5	8.4	5.6	20	55	15	0.2
	4050HR	3	50	40	22	11	18	10.4	6.3	20	55	15	0.3
	4063HR	4	63	50	22	11	18	10.4	6.3	20	60	15	0.6
	4080HR	4	80	60	27	14	20	12.4	7.0	25	60	15	1.0
	4100HR	5	100	80	32	18	26	14.4	8.0	26	60	15	1.6
PAC	2080HR	5	80	57	25.4	14	20	9.5	6.0	25	50	8.7	0.9
	2100HR	6	100	67	31.75	-	44	12.7	8.0	37	63	8.7	1.9
	4080HR	4	80	60	25.4	14	20	9.5	6.0	25	60	15	1.0
	4100HR	5	100	80	31.75	-	44	12.7	8.0	37	60	15	1.6

## Available inserts

### VCKT-MA



Type	Designation	Cermet		Coated										Uncoated			page			
		CN2500	CN30	NC5330	NCM325	NCM335	NCM535	NCM545	PC2505	PC2510	PC3700	PC6510	PC9530	PC9540	PC5300	PC5400		ST30A	G10	H01
2000 type	VDKT 11T210N-MA																		●	E29
4000 type	VCKT 220530N-MA																		●	

## Available arbors

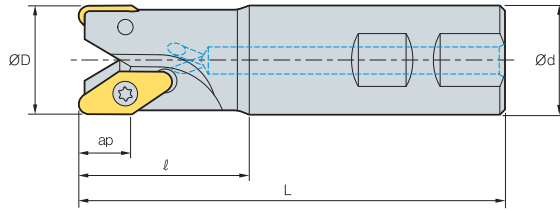
Designation	Ød	NC arbors	Designation	Ød	NC arbors
PAC 2040HR	16	BT□□-FMC16-□□	PAC 4040HR	16	BT□□-FMC16-□□
(PACM) 2050HR	22	BT□□-FMC22-□□	(PACM) 4050HR	22	BT□□-FMC22-□□
2063HR	22	BT□□-FMC22-□□	4063HR	22	BT□□-FMC22-□□
2080HR	25.4	BT□□-FMC25.4-□□	4080HR	25.4	BT□□-FMC25.4-□□
	27	BT□□-FMC27-□□		27	BT□□-FMC27-□□
2100HR	31.75	BT□□-FMC31.75-□□	4100HR	31.75	BT□□-FMC31.75-□□
	32	BT□□-FMC32-□□		32	BT□□-FMC32-□□

## Parts

Specification			Arbor Bolt
Ø40~Ø100 (2000 type)	ETNA02506	TW07S	
Ø40~Ø100 (4000 type)	FTNC04509(Ø40)	TW20S	PHMA0834(Ø40)
	FTNC04511		

Available inserts E29 Available arbors and bolt E426-E428

## PAS2000/4000



AA  
90°  
• AR: 0°~7°  
• RR: -21°~-3°

(mm)

Designation		ØD	Ød	l	L	ap	
PAS	2012HR	1	12	16	25	85	0.1
	2016HR	2	16	16	25	90	0.11
	* 2016HR-R2.0	2	16	16	25	90	0.11
	2020HR	2	20	20	30	100	0.2
	* 2020HR-R2.0	2	20	20	30	100	0.2
	2025HR	3	25	25	35	115	0.36
	2032HR	4	32	32	40	125	0.66
	2042HR	5	42	32	42	130	0.84
PAS	4032HR	2	32	32	50	125	0.6
	4040HR	3	40	32	50	140	0.8
	4040HR-S40	3	40	40	60	150	1.2
	4040HR-S42	3	40	42	60	150	1.2

Holders marked with an asterisk (\*) are only for VDKT11T220N-MA.

### Available inserts

VDKT-MA

VCKT-MA



Type	Designation	Cermet		Coated											Uncoated			page		
		CN2500	CN30	NC5330	NCM325	NCM335	NCM535	NCM545	PC2505	PC2510	PC3700	PC6510	PC9530	PC9540	PC5300	PC5400	ST30A		G10	H01
2000 type	VDKT 11T210N-MA																			●
	VDKT 11T220N-MA																			●
4000 type	VCKT 220530N-MA																			●

### Parts

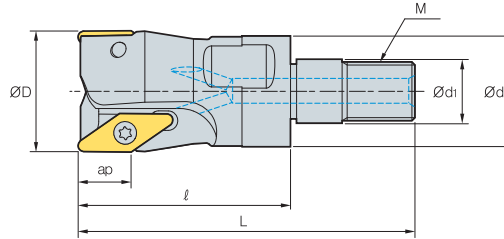
Specification		
Ø12~Ø42 (2000 type)	ETNA02505* ETNA02506	TW07S
Ø32~Ø40 (4000 type)	FTNC04509	TW20S

\* For PAS2012-2016

Available inserts E29



# PAM2000



Designation		ØD	Ød	Ød1	ℓ	L	M	ap	
PAM	2012HR-M06	1	12	11.0	6.5	33	M06	8	0.02
	2016HR-M08	2	16	14.5	8.5	36	M08	8	0.04
	2020HR-M10	2	20	18.0	10.5	36	M10	8	0.06
	2025HR-M12	3	25	22.5	12.5	41	M12	8	0.1
	2032HR-M16	4	32	28.5	17.0	45	M16	8	0.18
	2042HR-M16	5	42	28.5	17.0	45	M16	8	0.27

(mm)

## Available inserts

VDKT-MA



Designation	Cermet		Coated										Uncoated			page			
	CN2500	CN30	NC5330	NCM325	NCM335	NCM635	NCM545	PC2505	PC2510	PC3700	PC6510	PC9530	PC9540	PC5300	PC5400		ST30A	G10	H01
VDKT 11T210N-MA																		●	E29

## Available adaptors

Designation	Available adaptors
PAM 2012HR-M06	MAT-M06
2016HR-M08	MAT-M08
2020HR-M10	MAT-M10
2025HR-M12	MAT-M12
2032HR-M16	MAT-M16
2042HR-M16	MAT-M16

Designation: PAM2012HR-M06  
Modular head threading measure size (M06)

||

Adaptor spec.: MAT-M06-030-S20S  
Adaptor threading measure (M06)

## Parts

Specification		
Ø12~Ø42	ETNA02505* ETNA02506	TW07S

Available inserts E29 Available adaptors E401-E402 \* For PAS2012-2016





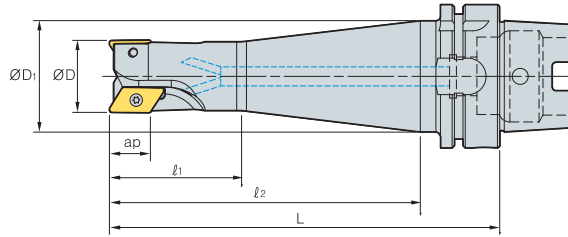








# HSK63A/100A PAX5000



AA  
90°  
• AR: 5°~17.5°  
• RR: -14°~-5°

(mm)

Designation		ØD	ØD1	l1	l2	L	ap	
HSK63A PAX5032HR-A, B	2	32	53	58	137	163	17	1.14
HSK100A PAXCM5080HR-A, B	5	80	-	-	66	95	17	4
PAXCM5100HR-A, B	6	100	-	-	66	95	17	4.6

- A type: Insert NoseR 0.4~3.2, B type: Insert NoseR 4.0~5.0
- For the maximum rake angle and the rpm limit, please refer to technical information on pp. E377~E378.

## Available inserts

XEKT-MA XEKT-ML



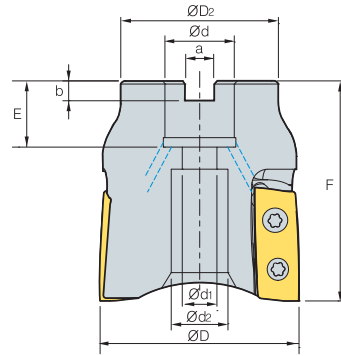
Designation	Material										page	Designation	Material										page															
	Cermet	Coated					Uncoated						Cermet	Coated					Uncoated																			
	CN2500	CN30	NC5330	NCM535	NCM545	PC2505	PC3700	PC6510	PC9530	PC9540	PC5300	PC5400	PD2000	PD1010	ST30A	G10	H01	H05		CN2500	CN30	NC5330	NCM535	NCM545	PC2505	PC3700	PC6510	PC9530	PC9540	PC5300	PC5400	PD2000	PD1010	ST30A	G10	H01	H05	
XEKT 19M504FR-MA														●	●	●	●		XEKT 19M504ER-ML																			
19M508FR-MA														●	●	●	●		19M508ER-ML																			
19M512FR-MA														●	●	●	●		19M512ER-ML																			
19M516FR-MA														●	●	●	●		19M516ER-ML																			
19M518FR-MA																			19M518ER-ML																			
19M520FR-MA														●	●	●	●		19M520ER-ML																			
19M530FR-MA														●	●	●	●		19M530ER-ML																			
19M532FR-MA														●	●	●	●		19M532ER-ML																			
19M540FR-MA														●	●	●	●		19M540ER-ML																			
19M550FR-MA														●	●	●	●		19M550ER-ML																			

## Parts

Specification		
Ø32~Ø100	PTKA0407 PTKA0408	TW15S

Available inserts E31

## PALCM

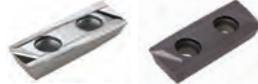


(mm)

Designation		ØD	ØD <sub>2</sub>	Ød	Ød <sub>1</sub>	Ød <sub>2</sub>	a	b	E	F	ap	
PALCM 063HR	4	63	50	22	11	21	10	6.3	20	70	34	0.57

### Available inserts

LXET-MA LXET-ML



Designation	Cermet		Coated											Uncoated			page		
	CN2500	CN30	NC5330	NCM325	NCM335	NCM535	NCM545	PC2505	PC2510	PC3700	PC6510	PC9530	PC9540	PC5300	PC5400	ST30A		G10	H01
LXET 340504PEFR-63-MA																			
LXET 3405PEFR-63-MA																			●
LXET 340512PEFR-63-MA																			
LXET 340516PEFR-63-MA																			
LXET 340504PEER-63-ML																			
LXET 3405PEER-63-ML																			
LXET 340512PEER-63-ML																			
LXET 340516PEER-63-ML																			

### Available arbors

Designation	Ød	Available arbors
PALCM 063HR	22	BT□□-FMC22-□□

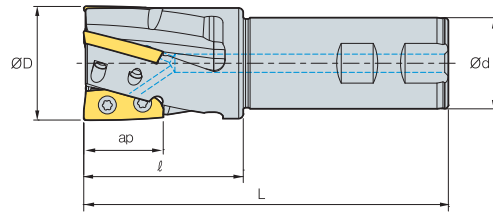
### Parts

Specification		
Ø63	FTGA0511-P	TW20-100

Available inserts E13 Available arbors and bolt E426-E428



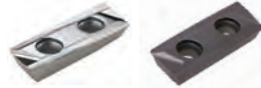
# PALS (Single-edge)



Designation		ØD	Ød	l	L	ap	
<b>PALS</b> 032HR-2S20	2	32	20	50	140	25	0.36
032HR-2S25	2	32	25	50	140	25	0.48
032HR-2S32	2	32	32	50	140	25	0.71
040HR-2S32	2	40	32	50	140	25	0.85
040HR-2S40	2	40	40	50	140	25	1.16
040HR-2S42	2	40	42	50	140	25	1.26
040HR-3S32	3	40	32	50	140	25	0.80
040HR-3S40	3	40	40	50	140	25	1.10
040HR-3S42	3	40	42	50	140	25	1.20

## Available inserts

LXET-MA LXET-ML



Type	Designation	Cermet		Coated												Uncoated			page			
		CN2500	CN30	NC5330	NCM325	NCM335	NCM535	NCM545	PC2505	PC2510	PC3700	PC6510	PC9530	PC9540	PC5300	PC5400	ST30A	G10		H01		
Ø32	LXET 250404PEFR-32-MA																					
	2504PEFR-32-MA																				●	
	250412PEFR-32-MA																					
	250416PEFR-32-MA																					
	250404PEER-32-ML																					
	2504PEER-32-ML																					
	250412PEER-32-ML																					
Ø40	LXET 250404PEFR-40-MA																					
	2504PEFR-40-MA																					
	250412PEFR-40-MA																					
	250416PEFR-40-MA																					
	250404PEER-40-ML																					
	2504PEER-40-ML																					
	250412PEER-40-ML																					

## Parts

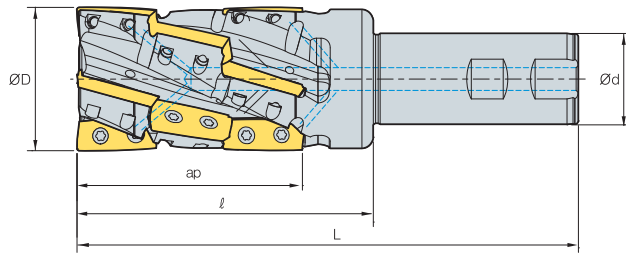
Specification		
Ø32	FTKA0408	TW15S
Ø40	FTKA0410	TW15S

Available inserts E13





# PALS (Multi-edge)



Designation			Ød	Ød <sub>1</sub>	l	L	ap	
PALS	063HM-4S32	12	63	32	130	220	96	1.60
	063HM-4S40	12	63	40	130	220	96	1.92
	063HM-4S42	12	63	42	130	220	96	2.00

(mm)

## Available inserts

LXET-MA      LXET-ML



Designation	Cermet		Coated											Uncoated			page	
	CN2500	CN30	NC5330	NCM325	NCM335	NCM635	NCM645	PC2505	PC2510	PC3700	PC6510	PC9530	PC9540	PC5300	PC5400	ST30A		G10
LXET 340504PEFR-63-MA																		
3405PEFR-63-MA																		●
340512PEFR-63-MA																		
340516PEFR-63-MA																		
340504PEER-63-ML																		
3405PEER-63-ML																		
340512PEER-63-ML																		
340516PEER-63-ML																		

E13

## Parts

Specification		
Ø63	FTGA0511-P	TW20-100

Available inserts E13

## PXL new

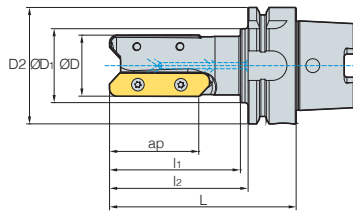


Fig. 1

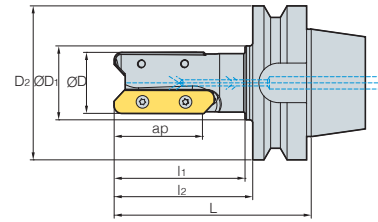


Fig. 2



AA  
90°

•AR: 5°~17.5°  
•RR: -14°~-5°

(mm)

Designation	⊙	ØD	ØD <sub>1</sub>	ØD <sub>2</sub>	l <sub>1</sub>	l <sub>2</sub>	L	ap	kg	Fig.
HSK63A PXL04090HR-2F	2	40	48	63	85	90	116	57	1.13	1
HSK100A PXL04090HR-3F	3	40	70	100	90	100	129	57	2.74	1
	5	80	77	100	-	90	119	57	4.29	1
BT50 PXL04090HR-2F	2	40	48	100	85	90	128	57	4.13	2

### Available inserts

LDET-MA



Designation	Cermet		Coated										Uncoated			page			
	CN2500	CN30	NC5330	NCM325	NCM335	NCM535	NCM545	PC2505	PC2510	PC3700	PC6510	PC9530	PC9540	PC5300	PC5400		ST30A	G10	H01
LDET 650540PPFR-MA																			E10
LDET 650550PPFR-MA																			

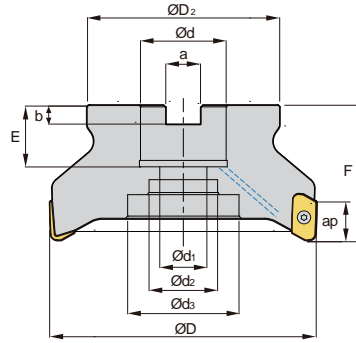
### Parts

Specification	Screw	Wrench
Ø40~80	FTGA0511-P	TW20-100

Available inserts E10



# PAVCM-XD19 new



AA  
90°  
• AR: 11°~14°  
• RR: -11°~-9°

(mm)

Designation	ØD	ØD <sub>2</sub>	Ød	Ød <sub>1</sub>	Ød <sub>2</sub>	Ød <sub>3</sub>	a	b	E	F	ap		
PAVCM 040R-16-3-XD19-A,B	3	40	34	16	9	13.5	-	8.4	5.6	16	45	17	0.17
050R-22-4-XD19-A,B	4	50	42	22	11	18	-	10.4	6.3	21	50	17	0.35
063R-22-5-XD19-A,B	5	63	42	22	11	18	-	10.4	6.3	21	50	17	0.53
080R-27-5-XD19-A,B	5	80	60	27	14	20	-	12.4	7.0	24	50	17	0.88
100R-32-6-XD19-A,B	6	100	70	32	18	26	42	14.4	8.0	25	63	17	1.72
125R-40-7-XD19-A,B	7	125	90	40	22	32	52	16.4	9.0	29	63	17	2.82

- Type A uses Insert Nose R 0.4~3.2, and Type B uses Nose R 4.0~5.0
- When using a spindle at high speed, please check the balance of tool and use it after replacing with the new screw.

## Available inserts

### XDET-MA



Designation	Cermet		Coated							Uncoated		page	Designation	Cermet		Coated							Uncoated		page								
	CN2500	CN30	NC5330	NCM325	NCM335	NCM635	NCM645	PC3700	PC6510	PC9530	PC9940			PC5300	PC5400	PD1005	PD1010	H01	H05	CN2500	CN30	NC5330	NCM325	NCM335		NCM635	NCM645	PC3700	PC6510	PC9530	PC9940	PC5300	PC5400
XDET 190504PEFR-MA															●●		XDET 190524PEFR-MA															●●	
190508PEFR-MA															●●		190530PEFR-MA															●●	
190512PEFR-MA															●●	E31	190532PEFR-MA															●●	E31
190516PEFR-MA															●●		190540PEFR-MA															●●	
190520PEFR-MA															●●		190550PEFR-MA															●●	

## Available arbors

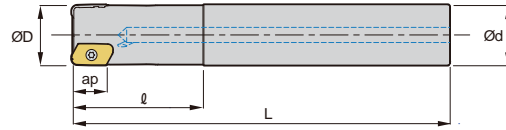
Designation	Available arbors
PAVCM 040R-16-3-XD19	BT□□-FMC16-□□
050R-22-4-XD19	BT□□-FMC22-□□
063R-22-5-XD19	BT□□-FMC22-□□
080R-27-5-XD19	BT□□-FMC27-□□
100R-32-6-XD19	BT□□-FMC32-□□
125R-40-7-XD19	BT□□-FMC40-□□

## Parts

Specification		
Ø40~Ø125	PTKA0408-A	TW15S

Available inserts E31 Available arbors and bolt E426~E428

## PAVS-XD19 new



AA  
90°  
• AR: 8°~11°  
• RR: -14°~-11°

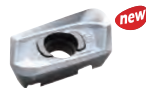
(mm)

Designation			ØD	Ød	l	L	ap	
PAVS	025R-2C25-140-XD19-A,B	2	25	25	60	140	17	0.40
	032R-2C32-150-XD19-A,B	2	32	32	70	150	17	0.76
	032R-2C32-200-XD19-A,B	2	32	32	70	200	17	1.06
	040R-3C40-200-XD19-A,B	3	40	40	70	200	17	1.71

- Type A uses Insert Nose R 0.4~3.2, and Type B uses Nose R 4.0~5.0
- When using a spindle at high speed, please check the balance of tool and use it after replacing with the new screw.

### Available inserts

#### XDET-MA



Designation	Coated										page	Designation	Coated										page													
	Cermet	Coated								Uncoated			Cermet	Coated								Uncoated														
	CN2500	CN30	NC5330	NCM325	NCM335	NCM635	NCM645	PC3700	PC6510	PC9530	PC9540	PC5300	PC5400	PD1005	PD1010	H01	H05		CN2500	CN30	NC5330	NCM325	NCM335	NCM635	NCM645	PC3700	PC6510	PC9530	PC9540	PC5300	PC5400	PD1005	PD1010	H01	H05	
XDET 190504PEFR-MA															●	●	E31	XDET 190524PEFR-MA														●	●	E31		
190508PEFR-MA															●	●		190530PEFR-MA														●	●			
190512PEFR-MA															●	●		190532PEFR-MA														●	●			
190516PEFR-MA															●	●		190540PEFR-MA														●	●			
190520PEFR-MA															●	●		190550PEFR-MA														●	●			

### Parts

Specification		
Ø25~Ø40	PTKA0408-A	TW15S

Available inserts E31



# MAT (Steel shank type)

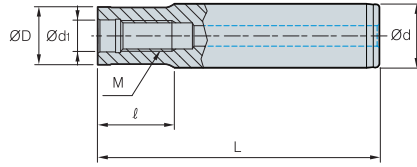


Fig. 1

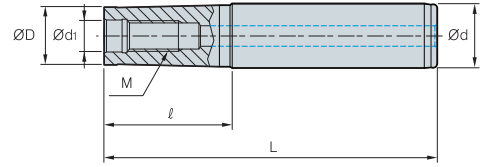


Fig. 2

(mm)

Designation	ØD	Ød	Ød <sub>1</sub>	ℓ	L	M	Fig.
MAT- M06-020-S10S	9.5	10	6.5	20	70	M06	1
M6B-020-S12S	11.0	12	6.5	20	76	M06	1
M6B-040-S12S	11.0	12	6.5	40	96	M06	1
M08-020-S16S	14.5	16	8.5	20	80	M08	1
M10-030-S20S	18.0	20	10.5	30	100	M10	1
M12-030-S25S	22.5	25	12.5	29	110	M12	1
M16-035-S32S	28.5	32	17.0	35	125	M16	1
M06-040-S12T	9.5	12	6.5	40	96	M06	2
M06-065-S16T	9.5	16	6.5	65	125	M06	2
M6B-065-S16T	11.0	16	6.5	65	125	M06	2
M6B-080-S16T	11.0	16	6.5	80	140	M06	2
M08-040-S16T	14.5	16	8.5	40	100	M08	2
M08-065-S16T	14.5	16	8.5	65	125	M08	2
M08-080-S20T	14.5	20	8.5	80	150	M08	2
M08-110-S25T	14.5	25	8.5	110	190	M08	2
M10-050-S20T	18.0	20	10.5	50	120	M10	2
M10-070-S20T	18.0	20	10.5	70	140	M10	2
M10-090-S25T	18.0	25	10.5	90	170	M10	2
M10-110-S25T	18.0	25	10.5	110	190	M10	2
M10-130-S32T	18.0	32	10.5	130	220	M10	2
M12-050-S25T	22.5	25	12.5	50	130	M12	2
M12-070-S25T	22.5	25	12.5	70	150	M12	2
M12-090-S25T	22.5	25	12.5	90	170	M12	2
M12-110-S32T	22.5	32	12.5	110	200	M12	2
M12-175-S40T	22.5	40	12.5	175	300	M12	2
M16-055-S32T	28.5	32	17.0	55	145	M16	2
M16-080-S32T	28.5	32	17.0	80	170	M16	2
M16-120-S32T	28.5	32	17.0	120	210	M16	2
M16-175-S40T	28.5	40	17.0	175	300	M16	2

• S: straight neck adaptor • T: taper neck adaptor

<b>FMRM type</b>  ↻ E238-241, E250-253	<b>LBE-MHD type</b>  ↻ E330	<b>PAM/PAXM type</b>  ↻ E387, 392	<b>AMM type</b>  ↻ E190-192	<b>RM3PM type</b>  ↻ E104	<b>RM4PM/RM4ZM type</b>  ↻ E117, 119
<b>RM6PM type</b>  ↻ E124, 125	<b>HFMDM type</b>  ↻ E275	<b>HFMM type</b>  ↻ E283	<b>HRMM type</b>  ↻ E305, 306	<b>HRMDM type</b>  ↻ E297-299	<b>GBEM type</b>  ↻ E334

↻ Applicable modular E45, E46 (FMRM, LBE, PAM, AMM, RM4PM, HFMM, RM4ZM, HRMM, PAXM)

## MAT-C (Carbide shank type)

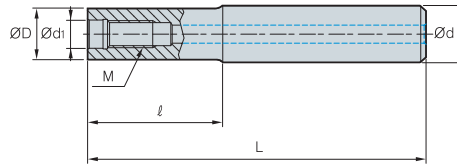


Fig. 1

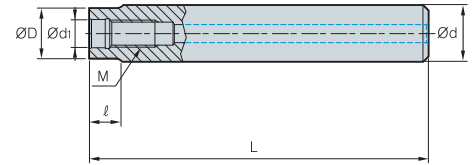


Fig. 2

(mm)

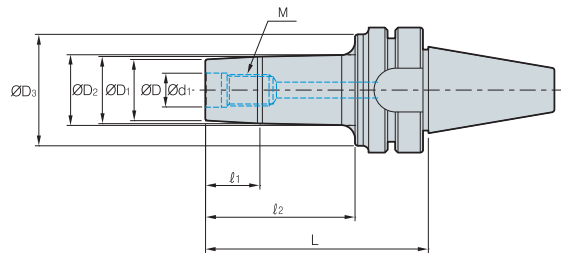
Designation	ØD	Ød	Ød <sub>1</sub>	ℓ	L	M	Fig.
MAT- M06-030-S10S-C-80	9.5	10	6.5	30	80	M06	1
MAT- M06-050-S10S-C-100	9.5	10	6.5	50	100	M06	1
MAT- M06-080-S10S-C-130	9.5	10	6.5	80	130	M06	1
MAT- M6B-030-S12S-C-80	11.0	12	6.5	30	80	M06	1
MAT- M6B-050-S12S-C-100	11.0	12	6.5	50	100	M06	1
MAT- M6B-080-S12S-C-130	11.0	12	6.5	80	130	M06	1
MAT- M08-080-S16S-C	14.5	16	8.5	80	150	M08	1
MAT- M08-110-S16S-C	14.5	16	8.5	110	180	M08	1
MAT- M08-150-S16S-C	14.5	16	8.5	150	250	M08	1
MAT- M08-010-S16S-C-150	14.5	16	8.5	10	150	M08	2
MAT- M08-010-S16S-C-180	14.5	16	8.5	10	180	M08	2
MAT- M08-010-S16S-C-250	14.5	16	8.5	10	250	M08	2
MAT- M10-090-S20S-C	18.0	20	10.5	90	170	M10	1
MAT- M10-110-S20S-C	18.0	20	10.5	110	200	M10	1
MAT- M10-175-S20S-C	18.0	20	10.5	175	300	M10	1
MAT- M10-010-S20S-C-170	18.0	20	10.5	10	170	M10	2
MAT- M10-010-S20S-C-200	18.0	20	10.5	10	200	M10	2
MAT- M10-010-S20S-C-300	18.0	20	10.5	10	300	M10	2
MAT- M12-090-S25S-C	22.5	25	12.5	90	170	M12	1
MAT- M12-110-S25S-C	22.5	25	12.5	110	200	M12	1
MAT- M12-175-S25S-C	22.5	25	12.5	175	300	M12	1
MAT- M12-015-S25S-C-170	22.5	25	12.5	15	170	M12	2
MAT- M12-015-S25S-C-200	22.5	25	12.5	15	200	M12	2
MAT- M12-015-S25S-C-300	22.5	25	12.5	15	300	M12	2
MAT- M16-090-S32S-C	28.5	32	17.0	90	180	M16	1
MAT- M16-120-S32S-C	28.5	32	17.0	120	210	M16	1
MAT- M16-175-S32S-C	28.5	32	17.0	175	300	M16	1
MAT- M16-020-S32S-C-180	28.5	32	17.0	20	180	M16	2
MAT- M16-020-S32S-C-210	28.5	32	17.0	20	210	M16	2
MAT- M16-020-S32S-C-300	28.5	32	17.0	20	300	M16	2



↻ Applicable modular E45, E46 (FMRM, LBE, PAM, AMM, RM4PM, HFMM, RM4ZM, HRMM, PAXM)



# BT30/BT40/BT50



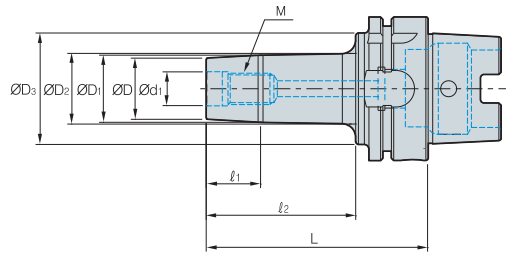
(mm)

Designation	ØD	ØD1	ØD2	ØD3	Ød1	ℓ1	ℓ2	L	M	
<b>BT30-</b>	<b>MAT-M06-053</b>	11.0	11.7	13.0	30	6.5	5	21	53	M06*1.0
	<b>MAT-M08-057</b>	14.5	15.7	17.5	35	8.5	7	25	57	M08*1.25
	<b>MAT-M10-062</b>	18.0	19.7	24.0	38	10.5	7	30	62	M10*1.5
	<b>MAT-M12-067</b>	23.0	24.7	27.5	41	12.5	10	35	67	M12*1.75
	<b>MAT-M16-067</b>	29.0	31.7	33.5	41	17.0	10	35	67	M16*2.0
<b>BT40-</b>	<b>MAT-M06-062</b>	11.0	11.7	14.0	40	6.5	5	25	62	M06*1.0
	<b>MAT-M06-077</b>	11.0	11.7	14.0	40	6.5	5	40	77	M06*1.0
	<b>MAT-M06-092</b>	11.0	11.7	14.0	40	6.5	5	55	92	M06*1.0
	<b>MAT-M08-067</b>	14.5	15.7	19.0	44	8.5	7	30	67	M08*1.25
	<b>MAT-M08-082</b>	14.5	15.7	19.0	44	8.5	7	45	82	M08*1.25
	<b>MAT-M08-097</b>	14.5	15.7	19.0	44	8.5	7	60	97	M08*1.25
	<b>MAT-M10-072</b>	18.0	19.7	23.0	50	10.5	10	35	72	M10*1.5
	<b>MAT-M10-087</b>	18.0	19.7	23.0	50	10.5	10	50	87	M10*1.5
	<b>MAT-M10-102</b>	18.0	19.7	23.0	50	10.5	10	65	102	M10*1.5
	<b>MAT-M12-077</b>	23.0	24.7	30.0	55	12.5	10	40	77	M12*1.75
	<b>MAT-M12-092</b>	23.0	24.7	30.0	55	12.5	13	55	92	M12*1.75
	<b>MAT-M12-107</b>	23.0	24.7	30.0	55	12.5	13	70	107	M12*1.75
	<b>MAT-M16-077</b>	29.0	31.7	37.0	55	17.0	13	40	77	M16*2.0
	<b>MAT-M16-092</b>	29.0	31.7	37.0	55	17.0	13	55	92	M16*2.0
	<b>MAT-M16-107</b>	29.0	31.7	37.0	55	17.0	13	70	107	M16*2.0
<b>BT50-</b>	<b>MAT-M06-083</b>	11.0	11.7	15.0	40	6.5	5	35	83	M06*1.0
	<b>MAT-M06-098</b>	11.0	11.7	15.0	40	6.5	5	50	98	M06*1.0
	<b>MAT-M06-113</b>	11.0	11.7	15.0	40	6.5	5	65	113	M06*1.0
	<b>MAT-M08-088</b>	14.5	15.7	20.0	45	8.5	7	40	88	M08*1.25
	<b>MAT-M08-103</b>	14.5	15.7	20.0	45	8.5	7	55	103	M08*1.25
	<b>MAT-M08-118</b>	14.5	15.7	20.0	45	8.5	7	70	118	M08*1.25
	<b>MAT-M10-093</b>	18.0	19.7	25.0	55	10.5	10	45	93	M10*1.5
	<b>MAT-M10-113</b>	18.0	19.7	25.0	55	10.5	10	65	113	M10*1.5
	<b>MAT-M10-128</b>	18.0	19.7	25.0	55	10.5	10	80	128	M10*1.5
	<b>MAT-M12-103</b>	23.0	24.7	33.0	65	12.5	10	55	103	M12*1.75
	<b>MAT-M12-118</b>	23.0	24.7	33.0	65	12.5	13	70	118	M12*1.75
	<b>MAT-M12-133</b>	23.0	24.7	33.0	65	12.5	13	85	133	M12*1.75
	<b>MAT-M16-103</b>	29.0	31.7	41.0	85	17.0	13	55	103	M16*2.0
	<b>MAT-M16-118</b>	29.0	31.7	41.0	85	17.0	13	70	118	M16*2.0
	<b>MAT-M16-133</b>	29.0	31.7	41.0	85	17.0	13	85	133	M16*2.0

↻ Applicable modular E45, E46



## HSK63A/HSK100A



(mm)

Designation	ØD	ØD1	ØD2	ØD3	Ød1	l1	l2	L	M	
HSK63A-	MAT-M06-061	11.0	11.7	27.0	40	6.5	5	25	61	M06*1.0
	MAT-M06-076	11.0	11.7	27.0	40	6.5	5	40	76	M06*1.0
	MAT-M06-091	11.0	11.7	27.0	40	6.5	5	55	91	M06*1.0
	MAT-M08-066	14.5	15.7	30.5	44	8.5	7	30	66	M08*1.25
	MAT-M08-081	14.5	15.7	30.5	44	8.5	7	45	81	M08*1.25
	MAT-M08-096	14.5	15.7	30.5	44	8.5	7	60	96	M08*1.25
	MAT-M10-071	18.0	19.7	34.0	50	10.5	10	35	71	M10*1.5
	MAT-M10-086	18.0	19.7	34.0	50	10.5	10	50	86	M10*1.5
	MAT-M10-101	18.0	19.7	34.0	50	10.5	10	65	101	M10*1.5
	MAT-M12-076	23.0	24.7	36.5	55	12.5	10	40	76	M12*1.75
	MAT-M12-091	23.0	24.7	36.5	55	12.5	13	55	91	M12*1.75
	MAT-M12-106	23.0	24.7	36.5	55	12.5	13	70	106	M12*1.75
	MAT-M16-076	29.0	31.7	38.5	55	17.0	13	40	76	M16*2.0
MAT-M16-091	29.0	31.7	38.5	55	17.0	13	55	91	M16*2.0	
MAT-M16-106	29.0	31.7	38.5	55	17.0	13	70	106	M16*2.0	
HSK100A-	MAT-M06-074	11.0	11.7	15.0	40	6.5	5	35	74	M06*1.0
	MAT-M06-089	11.0	11.7	15.0	40	6.5	5	50	89	M06*1.0
	MAT-M06-104	11.0	11.7	15.0	40	6.5	5	65	104	M06*1.0
	MAT-M08-079	14.5	15.7	20.0	45	8.5	7	40	79	M08*1.25
	MAT-M08-094	14.5	15.7	20.0	45	8.5	7	55	94	M08*1.25
	MAT-M08-109	14.5	15.7	20.0	45	8.5	7	70	109	M08*1.25
	MAT-M10-084	18.0	19.7	25.0	55	10.5	10	45	84	M10*1.5
	MAT-M10-104	18.0	19.7	25.0	55	10.5	10	65	104	M10*1.5
	MAT-M10-119	18.0	19.7	25.0	55	10.5	10	80	119	M10*1.5
	MAT-M12-094	23.0	24.7	33.0	65	12.5	10	55	94	M12*1.75
	MAT-M12-109	23.0	24.7	33.0	65	12.5	13	70	109	M12*1.75
	MAT-M12-124	23.0	24.7	33.0	65	12.5	13	85	124	M12*1.75
	MAT-M16-094	29.0	31.7	41.0	85	17.0	13	55	94	M16*2.0
	MAT-M16-109	29.0	31.7	41.0	85	17.0	13	70	109	M16*2.0
	MAT-M16-124	29.0	31.7	41.0	85	17.0	13	85	124	M16*2.0

↻ Applicable modular E45, E46



## Adjusting side cutter

### Code system

P: Plane type  
B: Boss type

A: Adjusting side cutter

For half side cutter, minimum width of the cutter will be written only

**Adjusting**      **Cutter type**      **Max. width of cutter**

**R**   **A**   **FC**   **B**   **125**   **14**   **18** - **R**

**Insert clamping way**      **Insert configuration**      **Cutter Dia.**      **Min. width of cutter**      **Hand**

**R:** Radial type (Using SDXT)

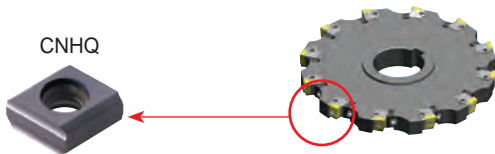
**T:** Tangential type (Using CNHQ)

**FC**  
Full side cutter

**HC**  
Half side cutter

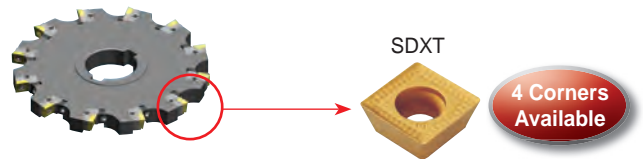
Hand		
Unmarked	R	L
Neutral	Right	Left
Full side cutter (Plane type)	Half side cutter (Boss type)	

### Tangential type (High rigidity)



- Medium/Roughing
- Excellent performance at medium to roughing range (14~30 mm) table operation due to the strong rigidity of the cutter
- Good performance in heavy interruption and deep depth of cut application

### Radial type (Low cutting load)

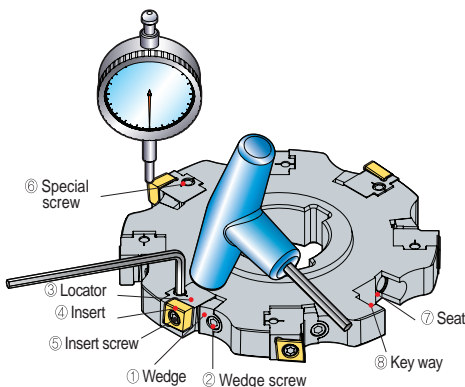


- Medium/Finishing
- Suitable for small width cutting operation (12~24 mm)
- 3 dimensional chip breaker provides smooth cutting operation
- Several chip breakers as per applications are available (MF, MM, FA)
- Economical insert using 4 cutting-edges per insert

### Insert features

- Precise adjustable side cutter can control the width of the cutter by 5 μm unit
- Since the width of the cutter is adjustable up to ±1.5 mm, single cutter can cover various cutting width
- Specially designed clamping system of the locator provides excellent rigidity by using elastic deformation of the locator
- Tangential type clamping system of insert provides enough strength can withstand large width cutting operations
- 3-dimensional chip breaker of insert provides smooth cutting with low cutting load at medium to finishing range

### Operating manual



#### How to assemble the adjusting side cutter

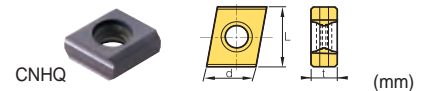
1. Clamp ① wedge slightly on ⑦ locator-wedge pocket by using ② wedge screw
2. Put ③ locator on ⑦ locator-wedge pocket along with the ⑧ key-way
3. Tighten the ⑥ taper screw little bit to set proper position of locator
4. Tighten the ② wedge screw tightly by using 70~80N.m torque
5. After, put the ④ insert on insert pocket of ③ locator, clamp it with ⑤ insert screw by using 40~50N.m torque

#### How to adjust Run-out & cutting width

1. Settle the adjusting side cutter after cleaning to the jig for measurement
2. Un-screw the ② Wedge screw first, then tighten ① wedge slightly again by using 8N.m torque
3. Adjusting the height of cutting-edge by using a dial gauge to set the width of the cutter
4. Tighten the ② wedge screw tightly by using 70~80N.m torque
5. To finish the setting, tighten the ⑥ taper screw for strong clamp

## Tangential type

### Cutting width per insert & type of cutter



Designation	Coated		Cutting width for half side cutter (ap)	Cutting width for full side cutter (ap)	L	d	t
	NCM535	PC6510					
CNHQ1005	- C0.5		9.0	14~18	10	10	5.4
	- R0.5						
	- C1.0		8.5	14~17			
	- R1.0						
CNHQ1305	- C0.5		12	18~21/21~24	12.7	10	5.4
	- R0.5						
	- C1.0		11.5	18~21/21~23			
	- R1.0						
	- C1.5		11	18~21/21~22			
	- R1.5						
CNHQ1606	- C0.5		15	24~27/27~30	16	12	6.4
	- R0.5						
	- C1.0		14.5	24~27/27~29			
	- R1.0						
	- C1.5		14	24~27/27~28			
	- R1.5						
	- C2.0		13.5	24~27			
	- R2.0						

Applicable cutter E407, E408 Available arbors and bolt E426~E428

● : Stock item

### Recommended cutting condition

ISO	Grades	vc (m/min)	fz (mm/t)
P	NCM535	190~310	0.10~0.30
	PC3700	160~270	
M	PC5300	90~150	0.10~0.30
	NCM335	180~290	
K	PC6510	140~230	0.10~0.30

## Radial type

### Cutting width per insert & type of cutter



Designation	Coated											Uncoated		Cutting width for half side cutter (ap)	Cutting width for full side cutter (ap)	d	t		
	NC5330	NCM325	NCM335	NCM535	NCM545	PC2505	PC2510	PC3700	PC6510	PC9530	PC9540	PC5300	PC5400					H01	H05
SDXT	09M405R-MA													●	●	8	12~14 14~16	9.525	4
	09M405L-MA																		
	09M405R-MF	●							●	●		●	●						
	09M405L-MF																		
	09M405R-MM	●							●	●		●	●						
	09M405L-MM								●										
SDXT	130508R-MA													●	●	10.5	16~18 18~20 20~22 22~24	13.5	5.56
	130508L-MA																		
	130508R-MF	●							●	●		●	●						
	130508L-MF																		
	130508R-MM	●							●	●		●	●						
	130508L-MM																		

Applicable cutter E409, E4108 Available arbors and bolt E426~E428

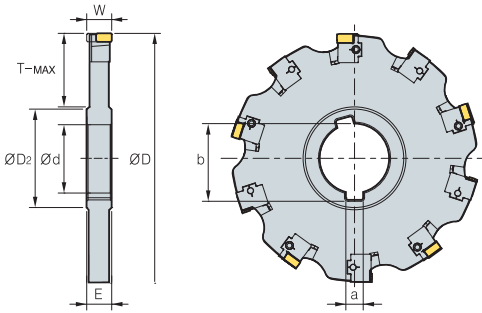
● : Stock item

### Recommended cutting condition

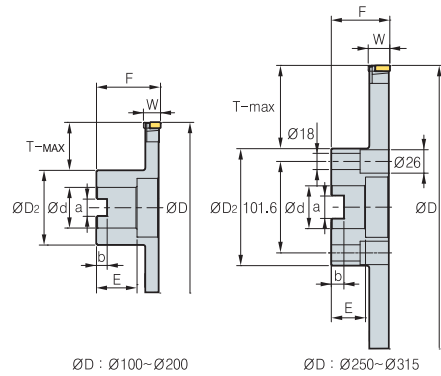
ISO	Grades	vc (m/min)	fz (mm/t)
P	NCM325	190~310	0.08~0.30
	NCM335	180~290	0.08~0.25
	PC3700	160~270	0.10~0.25
M	PC9530	90~150	0.10~0.25
	PC5300	90~150	
K	PC8110	140~230	0.10~0.25
	PC6510	140~230	



**Tangential type (Full side cutter)**



• TAFCP(M)



• TAFCB(M)

Designation	Ød	E	ØD2	a	b	T-MAX	Designation	Ød	F	ØD2	a	b	E	T-MAX	Dimensions			
															ØD	W	No. of tooth	
<b>TAFCP (M)</b>	<b>1001418</b>	31.75 (32)	14	48	7.92 (8)	35.2	<b>TAFCB (M)</b>	<b>1001418R/L</b>	31.75 (32)	50	54	12.7 (14.4)	8	28	21	100	14-18	6
	<b>1251418</b>	38.1 (40)	14	56	9.52 (10)	42.3		<b>1251418R/L</b>	38.1 (40)	60	70	15.9 (16.4)	10	30	25	125	14-18	8
	<b>1601418</b>	38.1 (40)	14	56	9.52 (10)	42.3		<b>1601418R/L</b>	38.1 (40)	60	70	15.9 (16.4)	10	30	43	160	14-18	10
	<b>2001418</b>	50.8 (50)	14	72	12.7 (12)	55.8		<b>2001418R/L</b>	50.8 (40)	65	90	19.0 (16.4)	11	30	53	200	14-18	12
	<b>2501418</b>	50.8 (50)	14	72	12.7 (12)	55.8		<b>2501418R/L</b>	47.625 (60)	65	130	25.4 (25.7)	14	38	58	250	14-18	16
	<b>3151418</b>	50.8 (50)	14	72	12.7 (12)	55.8		<b>3151418R/L</b>	47.625 (60)	65	130	25.4 (25.7)	14	38	90	315	14-18	20
<b>TAFCP (M)</b>	<b>1001821</b>	31.75 (32)	18	48	7.92 (8)	35.2	<b>TAFCB (M)</b>	<b>1001821R/L</b>	31.75 (32)	50	50	12.7 (14.4)	8	28	21	100	18-21	6
	<b>1251821</b>	38.1 (40)	18	56	9.52 (10)	42.3		<b>1251821R/L</b>	38.1 (40)	60	70	15.9 (16.4)	10	30	25	125	18-21	8
	<b>1601821</b>	38.1 (40)	18	56	9.52 (10)	42.3		<b>1601821R/L</b>	38.1 (40)	60	70	15.9 (16.4)	10	30	43	160	18-21	10
	<b>2001821</b>	50.8 (50)	18	72	12.7 (12)	55.8		<b>2001821R/L</b>	50.8 (40)	65	90	19.0 (16.4)	11	30	53	200	18-21	12
	<b>2501821</b>	50.8 (50)	18	72	12.7 (12)	55.8		<b>2501821R/L</b>	47.625 (60)	65	130	25.4 (25.7)	14	38	58	250	18-21	16
	<b>3151821</b>	50.8 (50)	18	72	12.7 (12)	55.8		<b>3151821R/L</b>	47.625 (60)	65	130	25.4 (25.7)	14	38	90	315	18-21	20
<b>TAFCP (M)</b>	<b>1002124</b>	31.75 (32)	21	48	7.92 (8)	35.2	<b>TAFCB (M)</b>	<b>1002124R/L</b>	31.75 (32)	50	54	12.7 (14.4)	8	28	21	100	21-24	6
	<b>1252124</b>	38.1 (40)	21	56	9.52 (10)	42.3		<b>1252124R/L</b>	38.1 (40)	60	70	15.9 (16.4)	10	30	25	125	21-24	8
	<b>1602124</b>	38.1 (40)	21	56	9.52 (10)	42.3		<b>1602124R/L</b>	38.1 (40)	60	70	15.9 (16.4)	10	30	43	160	21-24	10
	<b>2002124</b>	50.8 (50)	21	72	12.7 (12)	55.8		<b>2002124R/L</b>	50.8 (40)	65	90	19.0 (16.4)	11	30	53	200	21-24	12
	<b>2502124</b>	50.8 (50)	21	72	12.7 (12)	55.8		<b>2502124R/L</b>	47.625 (60)	65	130	25.4 (25.7)	14	38	58	250	21-24	16
	<b>3152124</b>	50.8 (50)	21	72	12.7 (12)	55.8		<b>3152124R/L</b>	47.625 (60)	65	130	25.4 (25.7)	14	38	90	315	21-24	20
<b>TAFCP (M)</b>	<b>1252427</b>	38.1 (40)	24	56	9.52 (10)	42.3	<b>TAFCB (M)</b>	<b>1252427R/L</b>	38.1 (40)	60	70	15.9 (16.4)	10	30	25	125	24-27	8
	<b>1602427</b>	38.1 (40)	24	56	9.52 (10)	42.3		<b>1602427R/L</b>	38.1 (40)	60	70	15.9 (16.4)	10	30	43	160	24-27	10
	<b>2002427</b>	50.8 (50)	24	72	12.7 (12)	55.8		<b>2002427R/L</b>	50.8 (40)	65	90	19.0 (16.4)	11	30	53	200	24-27	12
	<b>2502427</b>	50.8 (50)	24	72	12.7 (12)	55.8		<b>2502427R/L</b>	47.625 (60)	65	130	25.4 (25.7)	14	38	58	250	24-27	16
	<b>3152427</b>	50.8 (50)	24	72	12.7 (12)	55.8		<b>3152427R/L</b>	47.625 (60)	65	130	25.4 (25.7)	14	38	90	315	24-27	20
	<b>TAFCP (M)</b>	<b>1252730</b>	38.1 (40)	27	56	9.52 (10)		42.3	<b>TAFCB (M)</b>	<b>1252730R/L</b>	38.1 (40)	60	70	15.9 (16.4)	10	30	25	125
<b>1602730</b>		38.1 (40)	27	56	9.52 (10)	42.3	<b>1602730R/L</b>	38.1 (40)		60	70	15.9 (16.4)	10	30	43	160	27-30	10
<b>2002730</b>		50.8 (50)	27	72	12.7 (12)	55.8	<b>2002730R/L</b>	50.8 (40)		65	90	19.0 (16.4)	11	30	53	200	27-30	12
<b>2502730</b>		50.8 (50)	27	72	12.7 (12)	55.8	<b>2502730R/L</b>	47.625 (60)		65	130	25.4 (25.7)	14	38	58	250	27-30	16
<b>3152730</b>		50.8 (50)	27	72	12.7 (12)	55.8	<b>3152730R/L</b>	47.625 (60)		65	130	25.4 (25.7)	14	38	90	315	27-30	20

Available inserts and Recommended cutting condition **E406** • The ap (Maximum width of cutter) size written above is the number when using insert having corner size C0.5 or R0.5 ( ) Metric size

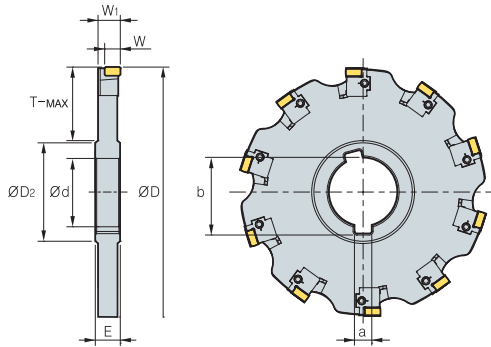
**Parts**

Specification	Insert	Locator	Wedge	Insert screw	Wedge screw	Locator screw	Insert wrench	Wedge Wrench	Locator Wrench
□□□1418R/L	CNHQ1005-□□□	LSA-CH10R/L	WSA10N	FTKA0410	DHA0617	SHGA0411	TW15S	HW30	-
□□□1821R/L	CNHQ1305-□□□	LSA-CH13R/L	WSA13N	FTKA0410	DHA0821F	SHGA0411	TW15S	HW40	HW30L
□□□2124R/L	CNHQ1305-□□□	LSA-CH13R/L	WSA13N	FTKA0410	DHA0821F	SHGA0411	TW15S	HW40	HW30L
□□□2427R/L	CNHQ1606-□□□	LSA-CH16R/L	WSA13N	FTGA0513-P	DHA0821F	SHGA0411	TW20S	HW40	HW30L
□□□2730R/L	CNHQ1606-□□□	LSA-CH16R/L	WSA13N	FTGA0513-P	DHA0821F	SHGA0411	TW20S	HW40	HW30L

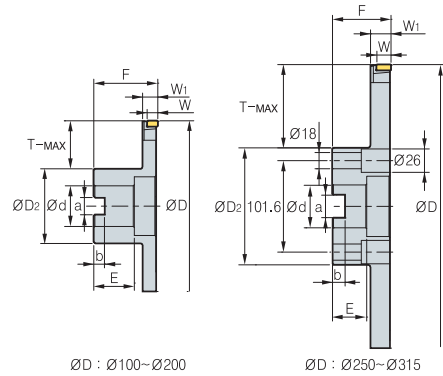
• Note) The Wedge screw for 1001821, 1002124 cutter is DHA0818F



## Tangential type (Half side cutter)



• TAHCP(M)



ØD : Ø100~Ø200

ØD : Ø250~Ø315

• TAHCB(M)

(mm)

Designation	Ød	E	ØD2	a	b	T-MAX	Designation	Ød	F	ØD2	a	b	E	T-MAX	Dimensions				
															ØD	W	W1	No. of tooth	
TAHCP (M)	10014R/L	31.75 (32)	14	48	7.92 (8)	35.2	24	TAHCB 10014R/L	31.75 (32)	50	54	12.7 (14.4)	8	28	21	100	9	13.25	6
	12514R/L	38.1 (40)	14	56	9.52 (10)	42.3	32	12514R/L	38.1 (40)	60	70	15.9 (16.4)	10	30	25	125	9	13.25	8
	16014R/L	38.1 (40)	14	56	9.52 (10)	42.3	50	16014R/L	38.1 (40)	60	70	15.9 (16.4)	10	30	43	160	9	13.25	10
	20014R/L	50.8 (50)	14	72	12.7 (12)	55.8	61	20014R/L	50.8 (40)	65	90	19.0 (16.4)	11	30	53	200	9	13.25	12
	25014R/L	50.8 (50)	14	72	12.7 (12)	55.8	86	25014R/L	47.625 (60)	65	130	25.4 (25.7)	14	38	58	250	9	13.25	16
31514R/L	50.8 (50)	14	72	12.7 (12)	55.8	118	31514R/L	47.625 (60)	65	130	25.4 (25.7)	14	38	90	315	9	13.25	20	
TAHCP (M)	10018R/L	31.75 (32)	18	48	7.92 (8)	35.2	24	TAHCB 10018R/L	31.75 (32)	50	50	12.7 (14.4)	8	28	21	100	12	16.75	6
	12518R/L	38.1 (40)	18	56	9.52 (10)	42.3	32	12518R/L	38.1 (40)	60	70	15.9 (16.4)	10	30	25	125	12	16.75	8
	16018R/L	38.1 (40)	18	56	9.52 (10)	42.3	50	16018R/L	38.1 (40)	60	70	15.9 (16.4)	10	30	43	160	12	16.75	10
	20018R/L	50.8 (50)	18	72	12.7 (12)	55.8	61	20018R/L	50.8 (40)	65	90	19.0 (16.4)	11	30	53	200	12	16.75	12
	25018R/L	50.8 (50)	18	72	12.7 (12)	55.8	86	25018R/L	47.625 (60)	65	130	25.4 (25.7)	14	38	58	250	12	16.75	16
31518R/L	50.8 (50)	18	72	12.7 (12)	55.8	118	31518R/L	47.625 (60)	65	130	25.4 (25.7)	14	38	90	315	12	16.75	20	
TAHCP (M)	10021R/L	31.75 (32)	21	48	7.92 (8)	35.2	24	TAHCB 10021R/L	31.75 (32)	50	54	12.7 (14.4)	8	28	21	100	12	19.75	6
	12521R/L	38.1 (40)	21	56	9.52 (10)	42.3	32	12521R/L	38.1 (40)	60	70	15.9 (16.4)	10	30	25	125	12	19.75	8
	16021R/L	38.1 (40)	21	56	9.52 (10)	42.3	50	16021R/L	38.1 (40)	60	70	15.9 (16.4)	10	30	43	160	12	19.75	10
	20021R/L	50.8 (50)	21	72	12.7 (12)	55.8	61	20021R/L	50.8 (40)	65	90	19.0 (16.4)	11	30	53	200	12	19.75	12
	25021R/L	50.8 (50)	21	72	12.7 (12)	55.8	86	25021R/L	47.625 (60)	65	130	25.4 (25.7)	14	38	58	250	12	19.75	16
31521R/L	50.8 (50)	21	72	12.7 (12)	55.8	118	31521R/L	47.625 (60)	65	130	25.4 (25.7)	14	38	90	315	12	19.75	20	
TAHCP (M)	12524R/L	38.1 (40)	24	56	9.52 (10)	42.3	32	TAHCB 12524R/L	38.1 (40)	60	70	15.9 (16.4)	10	30	25	125	15	22.75	8
	16024R/L	38.1 (40)	24	56	9.52 (10)	42.3	50	16024R/L	38.1 (40)	60	70	15.9 (16.4)	10	30	43	160	15	22.75	10
	20024R/L	50.8 (50)	24	72	12.7 (12)	55.8	61	20024R/L	50.8 (40)	65	90	19.0 (16.4)	11	30	53	200	15	22.75	12
	25024R/L	50.8 (50)	24	72	12.7 (12)	55.8	86	25024R/L	47.625 (60)	65	130	25.4 (25.7)	14	38	58	250	15	22.75	16
	31524R/L	50.8 (50)	24	72	12.7 (12)	55.8	118	31524R/L	47.625 (60)	65	130	25.4 (25.7)	14	38	90	315	15	22.75	20
TAHCP (M)	12527R/L	38.1 (40)	27	56	9.52 (10)	42.3	32	TAHCB 12527R/L	38.1 (40)	60	70	15.9 (16.4)	10	30	25	125	15	25.75	8
	16027R/L	38.1 (40)	27	56	9.52 (10)	42.3	50	16027R/L	38.1 (40)	60	70	15.9 (16.4)	10	30	43	160	15	25.75	10
	20027R/L	50.8 (50)	27	72	12.7 (12)	55.8	61	20027R/L	50.8 (40)	65	90	19.0 (16.4)	11	30	53	200	15	25.75	12
	25027R/L	50.8 (50)	27	72	12.7 (12)	55.8	86	25027R/L	47.625 (60)	65	130	25.4 (25.7)	14	38	58	250	15	25.75	16
	31527R/L	50.8 (50)	27	72	12.7 (12)	55.8	118	31527R/L	47.625 (60)	65	130	25.4 (25.7)	14	38	90	315	15	25.75	20

Available inserts and Recommended cutting condition **E406** • The ap (Maximum width of cutter) size written above is the number when using insert having corner size C0.5 or R0.5 ( )Metric size

### Parts

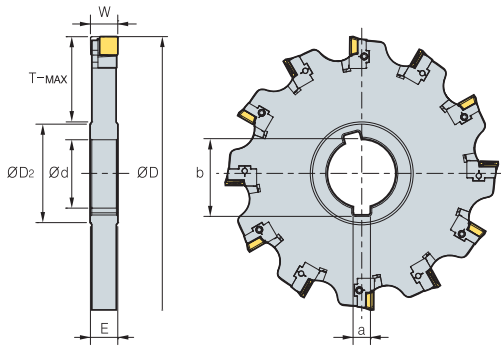
Specification	Insert	Locator	Wedge	Insert screw	Wedge screw	Locator screw	Insert wrench	Wedge Wrench	Locator Wrench
Edge width TAHCP(B)									
□□□1418R/L	CNHQ1005-□□□	LSA-CH10R/L	WSA10N	FTKA0410	DHA0617	SHGA0411	TW15S	HW30	-
□□□1821R/L	CNHQ1305-□□□	LSA-CH13R/L	WSA13N	FTKA0410	DHA0821F	SHGA0411	TW15S	HW40	HW30L
□□□2124R/L	CNHQ1305-□□□	LSA-CH13R/L	WSA13N	FTKA0410	DHA0821F	SHGA0411	TW15S	HW40	HW30L
□□□2427R/L	CNHQ1606-□□□	LSA-CH16R/L	WSA13N	FTGA0513-P	DHA0821F	SHGA0411	TW20S	HW40	HW30L
□□□2730R/L	CNHQ1606-□□□	LSA-CH16R/L	WSA13N	FTGA0513-P	DHA0821F	SHGA0411	TW20S	HW40	HW30L

• Note) The Wedge screw for 10018, 10021 cutter is DHA0818F

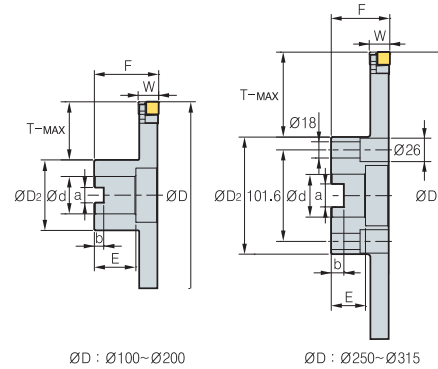




**Radial type (Full side cutter)**



• RAFCP(M)



• RAFCB(M)

(mm)

Designation	Ød	E	ØD2	a	b	T-MAX	Designation	Ød	F	ØD2	a	b	E	T-MAX	Dimensions		
															ØD	W	No. of tooth
<b>RAFCP (M)</b> 1001214 1251214 1601214 2001214 2501214 3151214	31.75 (32)	12	48	7.92 (8)	35.2	24	<b>RAFCB (M)</b> 1001214R/L 1251214R/L 1601214R/L 2001214R/L 2501214R/L 3151214R/L	31.75 (32)	50	54	12.7 (14.4)	8	28	21	100	12-14	6
	38.1 (40)	12	56	9.52 (10)	42.3	32		38.1 (40)	60	70	15.9 (16.4)	10	30	25	125	12-14	8
	38.1 (40)	12	56	9.52 (10)	42.3	50		38.1 (40)	60	70	15.9 (16.4)	10	30	43	160	12-14	10
	50.8 (50)	12	72	12.7 (12)	55.8	61		50.8 (40)	65	90	19.0 (16.4)	11	30	53	200	12-14	12
	50.8 (50)	12	72	12.7 (12)	55.8	86		47.625 (60)	65	130	25.4 (25.7)	14	38	58	250	12-14	16
	50.8 (50)	12	72	12.7 (12)	55.8	118		47.625 (60)	65	130	25.4 (25.7)	14	38	90	315	12-14	20
<b>RAFCP (M)</b> 1001416 1251416 1601416 2001416 2501416 3151416	31.75 (32)	14	48	7.92 (8)	35.2	24	<b>RAFCB (M)</b> 1001416R/L 1251416R/L 1601416R/L 2001416R/L 2501416R/L 3151416R/L	31.75 (32)	50	50	12.7 (14.4)	8	28	21	100	14-16	6
	38.1 (40)	14	56	9.52 (10)	42.3	32		38.1 (40)	60	70	15.9 (16.4)	10	30	25	125	14-16	8
	38.1 (40)	14	56	9.52 (10)	42.3	50		38.1 (40)	60	70	15.9 (16.4)	10	30	43	160	14-16	10
	50.8 (50)	14	72	12.7 (12)	55.8	61		50.8 (40)	65	90	19.0 (16.4)	11	30	53	200	14-16	12
	50.8 (50)	14	72	12.7 (12)	55.8	86		47.625 (60)	65	130	25.4 (25.7)	14	38	58	250	14-16	16
	50.8 (50)	14	72	12.7 (12)	55.8	118		47.625 (60)	65	130	25.4 (25.7)	14	38	90	315	14-16	20
<b>RAFCP (M)</b> 1251618 1601618 2001618 2501618 3151618	38.1 (40)	16	56	9.52 (10)	42.3	32	<b>RAFCB (M)</b> 1251618R/L 1601618R/L 2001618R/L 2501618R/L 3151618R/L	38.1 (40)	60	70	15.9 (16.4)	10	30	25	125	16-18	8
	38.1 (40)	16	56	9.52 (10)	42.3	50		38.1 (40)	60	70	15.9 (16.4)	10	30	43	160	16-18	10
	50.8 (50)	16	72	12.7 (12)	55.8	61		50.8 (40)	65	90	19.0 (16.4)	11	30	53	200	16-18	12
	50.8 (50)	16	72	12.7 (12)	55.8	86		47.625 (60)	65	130	25.4 (25.7)	14	38	58	250	16-18	16
	50.8 (50)	16	72	12.7 (12)	55.8	118		47.625 (60)	65	130	25.4 (25.7)	14	38	90	315	16-18	20
	<b>RAFCP (M)</b> 1251820 1601820 2001820 2501820 3151820	38.1 (40)	18	56	9.52 (10)	42.3		32	<b>RAFCB (M)</b> 1251820R/L 1601820R/L 2001820R/L 2501820R/L 3151820R/L	38.1 (40)	60	70	15.9 (16.4)	10	30	25	125
38.1 (40)		18	56	9.52 (10)	42.3	50	38.1 (40)	60		70	15.9 (16.4)	10	30	43	160	18-20	10
50.8 (50)		18	72	12.7 (12)	55.8	61	50.8 (40)	65		90	19.0 (16.4)	11	30	53	200	18-20	12
50.8 (50)		18	72	12.7 (12)	55.8	86	47.625 (60)	65		130	25.4 (25.7)	14	38	58	250	18-20	16
50.8 (50)		18	72	12.7 (12)	55.8	118	47.625 (60)	65		130	25.4 (25.7)	14	38	90	315	18-20	20
<b>RAFCP (M)</b> 1252022 1602022 2002022 2502022 3152022		38.1 (40)	20	56	9.52 (10)	42.3	32	<b>RAFCB (M)</b> 1252022R/L 1602022R/L 2002022R/L 2502022R/L 3152022R/L		38.1 (40)	60	70	15.9 (16.4)	10	30	25	125
	38.1 (40)	20	56	9.52 (10)	42.3	50	38.1 (40)		60	70	15.9 (16.4)	10	30	43	160	20-22	10
	50.8 (50)	20	72	12.7 (12)	55.8	61	50.8 (40)		65	90	19.0 (16.4)	11	30	53	200	20-22	12
	50.8 (50)	20	72	12.7 (12)	55.8	86	47.625 (60)		65	130	25.4 (25.7)	14	38	58	250	20-22	16
	50.8 (50)	20	72	12.7 (12)	55.8	118	47.625 (60)		65	130	25.4 (25.7)	14	38	90	315	20-22	20
	<b>RAFCP (M)</b> 1252224 1602224 2002224 2502224 3152224	38.1 (40)	22	56	9.52 (10)	42.3	32		<b>RAFCB (M)</b> 1252224R/L 1602224R/L 2002224R/L 2502224R/L 3152224R/L	38.1 (40)	60	70	15.9 (16.4)	10	30	25	125
38.1 (40)		22	56	9.52 (10)	42.3	50	38.1 (40)	60		70	15.9 (16.4)	10	30	43	160	22-24	10
50.8 (50)		22	72	12.7 (12)	55.8	61	50.8 (40)	65		90	19.0 (16.4)	11	30	53	200	22-24	12
50.8 (50)		22	72	12.7 (12)	55.8	86	47.625 (60)	65		130	25.4 (25.7)	14	38	58	250	22-24	16
50.8 (50)		22	72	12.7 (12)	55.8	118	47.625 (60)	65		130	25.4 (25.7)	14	38	90	315	22-24	20

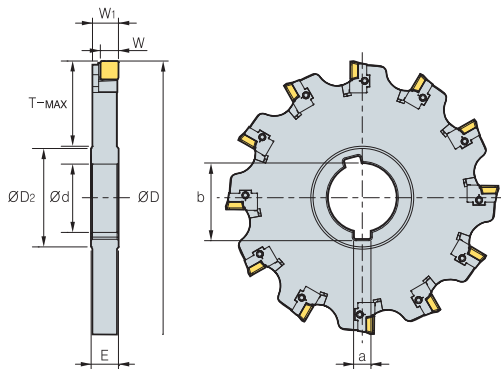
Available inserts and Recommended cutting condition **E406** • The ap (Maximum width of cutter) size written above is the number when using insert having corner size C0.5 or R0.5

( ) Metric size

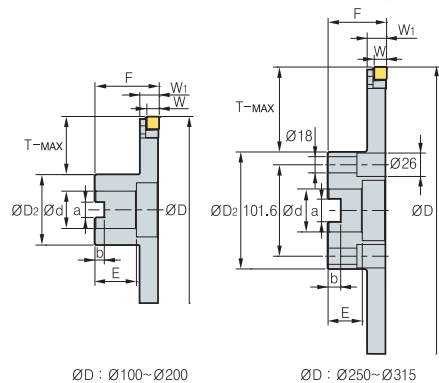
**Parts**

Specification	Insert	Locator	WSD09N Wedge	WSA10N Wedge	Insert screw	Wedge screw	Locator screw	Insert wrench	Wedge, locator wrench
□□□1214R/L	SDXT09M40□R/L	LSD09R/L	WSD09N	WSA10N	FTGA03508	DHA0617	SHGA0409	TW15S	HW30
□□□1416R/L	SDXT09M40□R/L	LSD09R/L	WSD09N	WSA10N	FTGA03508	DHA0617	SHGA0409	TW15S	HW30
□□□1618R/L	SDXT13050□R/L	LSD13R/L	WSD09N	WSA10N	FTNC04509	DHA0617	SHGA0411	TW20S	HW30
□□□1820R/L	SDXT13050□R/L	LSD13R/L	WSD09N	WSA10N	FTNC04509	DHA0617	SHGA0411	TW20S	HW30
□□□2022R/L	SDXT13050□R/L	LSD13R/L	WSD09N	WSA10N	FTNC04509	DHA0617	SHGA0411	TW20S	HW30
□□□2224R/L	SDXT13050□R/L	LSD13R/L	WSD09N	WSA10N	FTNC04509	DHA0617	SHGA0411	TW20S	HW30

## Radial type (Half side cutter)



• RAHCP(M)



• RAHCB(M)

(mm)

Designation	Ød	E	ØD2	a	b	T-MAX	Designation	Ød	F	ØD2	a	b	E	T-MAX	Dimensions			
															ØD	W	W1	No. of tooth
<b>RAHCP 10012R/L (M)</b>	31.75 (32)	12	48	7.92 (8)	35.2	24	<b>RAHCB 10012R/L (M)</b>	31.75 (32)	50	54	12.7 (14.4)	8	28	21	100	8	11.1	6
<b>12512R/L</b>	38.1 (40)	12	56	9.52 (10)	42.3	32	<b>12512R/L</b>	38.1 (40)	60	70	15.9 (16.4)	10	30	25	125	8	11.1	8
<b>16012R/L</b>	38.1 (40)	12	56	9.52 (10)	42.3	50	<b>16012R/L</b>	38.1 (40)	60	70	15.9 (16.4)	10	30	43	160	8	11.1	10
<b>20012R/L</b>	50.8 (50)	12	72	12.7 (12)	55.8	61	<b>20012R/L</b>	50.8 (40)	65	90	19.0 (16.4)	11	30	53	200	8	11.1	12
<b>25012R/L</b>	50.8 (50)	12	72	12.7 (12)	55.8	86	<b>25012R/L</b>	47.625 (60)	65	130	25.4 (25.7)	14	38	58	250	8	11.1	16
<b>31512R/L</b>	50.8 (50)	12	72	12.7 (12)	55.8	118	<b>31512R/L</b>	47.625 (60)	65	130	25.4 (25.7)	14	38	90	315	8	11.1	20
<b>RAHCP 10014R/L (M)</b>	31.75 (32)	14	48	7.92 (8)	35.2	24	<b>RAHCB 10014R/L (M)</b>	31.75 (32)	50	50	12.7 (14.4)	8	28	21	100	8	13.1	6
<b>12514R/L</b>	38.1 (40)	14	56	9.52 (10)	42.3	32	<b>12514R/L</b>	38.1 (40)	60	70	15.9 (16.4)	10	30	25	125	8	13.1	8
<b>16014R/L</b>	38.1 (40)	14	56	9.52 (10)	42.3	50	<b>16014R/L</b>	38.1 (40)	60	70	15.9 (16.4)	10	30	43	160	8	13.1	10
<b>20014R/L</b>	50.8 (50)	14	72	12.7 (12)	55.8	61	<b>20014R/L</b>	50.8 (40)	65	90	19.0 (16.4)	11	30	53	200	8	13.1	12
<b>25014R/L</b>	50.8 (50)	14	72	12.7 (12)	55.8	86	<b>25014R/L</b>	47.625 (60)	65	130	25.4 (25.7)	14	38	58	250	8	13.1	16
<b>31514R/L</b>	50.8 (50)	14	72	12.7 (12)	55.8	118	<b>31514R/L</b>	47.625 (60)	65	130	25.4 (25.7)	14	38	90	315	8	13.1	20
<b>RAHCP 12516R/L (M)</b>	38.1 (40)	16	56	9.52 (10)	42.3	32	<b>RAHCB 12516R/L (M)</b>	38.1 (40)	60	70	15.9 (16.4)	10	30	25	125	10.5	15	8
<b>16016R/L</b>	38.1 (40)	16	56	9.52 (10)	42.3	50	<b>16016R/L</b>	38.1 (40)	60	70	15.9 (16.4)	10	30	43	160	10.5	15	10
<b>20016R/L</b>	50.8 (50)	16	72	12.7 (12)	55.8	61	<b>20016R/L</b>	50.8 (40)	65	90	19.0 (16.4)	11	30	53	200	10.5	15	12
<b>25016R/L</b>	50.8 (50)	16	72	12.7 (12)	55.8	86	<b>25016R/L</b>	47.625 (60)	65	130	25.4 (25.7)	14	38	58	250	10.5	15	16
<b>31516R/L</b>	50.8 (50)	16	72	12.7 (12)	55.8	118	<b>31516R/L</b>	47.625 (60)	65	130	25.4 (25.7)	14	38	90	315	10.5	15	20
<b>RAHCP 12518R/L (M)</b>	38.1 (40)	18	56	9.52 (10)	42.3	32	<b>RAHCB 12518R/L (M)</b>	38.1 (40)	60	70	15.9 (16.4)	10	30	25	125	10.5	17	8
<b>16018R/L</b>	38.1 (40)	18	56	9.52 (10)	42.3	50	<b>16018R/L</b>	38.1 (40)	60	70	15.9 (16.4)	10	30	43	160	10.5	17	10
<b>20018R/L</b>	50.8 (50)	18	72	12.7 (12)	55.8	61	<b>20018R/L</b>	50.8 (40)	65	90	19.0 (16.4)	11	30	53	200	10.5	17	12
<b>25018R/L</b>	50.8 (50)	18	72	12.7 (12)	55.8	86	<b>25018R/L</b>	47.625 (60)	65	130	25.4 (25.7)	14	38	58	250	10.5	17	16
<b>31518R/L</b>	50.8 (50)	18	72	12.7 (12)	55.8	118	<b>31518R/L</b>	47.625 (60)	65	130	25.4 (25.7)	14	38	90	315	10.5	17	20
<b>RAHCP 12520R/L (M)</b>	38.1 (40)	20	56	9.52 (10)	42.3	32	<b>RAHCB 12520R/L (M)</b>	38.1 (40)	60	70	15.9 (16.4)	10	30	25	125	10.5	19	8
<b>16020R/L</b>	38.1 (40)	20	56	9.52 (10)	42.3	50	<b>16020R/L</b>	38.1 (40)	60	70	15.9 (16.4)	10	30	43	160	10.5	19	10
<b>20020R/L</b>	50.8 (50)	20	72	12.7 (12)	55.8	61	<b>20020R/L</b>	50.8 (40)	65	90	19.0 (16.4)	11	30	53	200	10.5	19	12
<b>25020R/L</b>	50.8 (50)	20	72	12.7 (12)	55.8	86	<b>25020R/L</b>	47.625 (60)	65	130	25.4 (25.7)	14	38	58	250	10.5	19	16
<b>31520R/L</b>	50.8 (50)	20	72	12.7 (12)	55.8	118	<b>31520R/L</b>	47.625 (60)	65	130	25.4 (25.7)	14	38	90	315	10.5	19	20
<b>RAHCP 12522R/L (M)</b>	38.1 (40)	22	56	9.52 (10)	42.3	32	<b>RAHCB 12522R/L (M)</b>	38.1 (40)	60	70	15.9 (16.4)	10	30	25	125	10.5	21	8
<b>16022R/L</b>	38.1 (40)	22	56	9.52 (10)	42.3	50	<b>16022R/L</b>	38.1 (40)	60	70	15.9 (16.4)	10	30	43	160	10.5	21	10
<b>20022R/L</b>	50.8 (50)	22	72	12.7 (12)	55.8	61	<b>20022R/L</b>	50.8 (40)	65	90	19.0 (16.4)	11	30	53	200	10.5	21	12
<b>25022R/L</b>	50.8 (50)	22	72	12.7 (12)	55.8	86	<b>25022R/L</b>	47.625 (60)	65	130	25.4 (25.7)	14	38	58	250	10.5	21	16
<b>31522R/L</b>	50.8 (50)	22	72	12.7 (12)	55.8	118	<b>31522R/L</b>	47.625 (60)	65	130	25.4 (25.7)	14	38	90	315	10.5	21	20

Available inserts and Recommended cutting condition **E406**

- The ap (Maximum width of cutter) size written above is the number when using insert having corner size R0.5. The ap is subject to change as per insert corner size
- The ap (Maximum width of cutter) size written above is the number when using SDXT09M405R-MM. The ap is subject to change as per insert corner size ( )Metric size

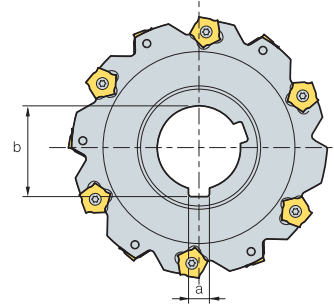
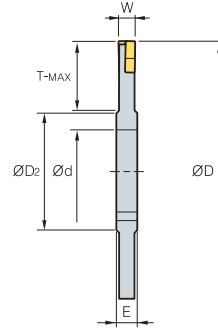
### Parts

Specification	Insert	Locator	Wedge	Wedge	Insert screw	Wedge screw	Locator screw	Insert wrench	Wedge, locator wrench
□□□1214R/L	SDXT09M40□R/L	LSD09R/L	WSD09N	WSA10N	FTGA03508	DHA0617	SHGA0409	TW15S	HW30
□□□1416R/L	SDXT09M40□R/L	LSD09R/L	WSD09N	WSA10N	FTGA03508	DHA0617	SHGA0409	TW15S	HW30
□□□1618R/L	SDXT13050□R/L	LSD13R/L	WSD09N	WSA10N	FTNC04509	DHA0617	SHGA0411	TW20S	HW30
□□□1820R/L	SDXT13050□R/L	LSD13R/L	WSD09N	WSA10N	FTNC04509	DHA0617	SHGA0411	TW20S	HW30
□□□2022R/L	SDXT13050□R/L	LSD13R/L	WSD09N	WSA10N	FTNC04509	DHA0617	SHGA0411	TW20S	HW30
□□□2224R/L	SDXT13050□R/L	LSD13R/L	WSD09N	WSA10N	FTNC04509	DHA0617	SHGA0411	TW20S	HW30





# SPP(M)



(mm)

Designation	ØD	W	T-MAX	Ød	a	b	E	ØD2	Insert	Screw	Wrench	
<b>SPP</b> 080-04	8	80	4	20	25.4 (27)	6.35 (7)	28.04 (29.8)	8	40	PNEJ1223N	PTMA0403F	TW15S
<b>(SPPM)</b> 080-05	8	80	5	20	25.4 (27)	6.35 (7)	28.04 (29.8)	8	40	PNEJ1230N	PTMA0404F	TW15S
080-06	8	80	6	20	25.4 (27)	6.35 (7)	28.04 (29.8)	8	40	PNEJ1235N	PTMA0405F	TW15S
100-04	10	100	4	24	31.75 (32)	7.94 (8)	35.18 (34.8)	8	47	PNEJ1223N	PTMA0403F	TW15S
100-05	10	100	5	24	31.75 (32)	7.94 (8)	35.18 (34.8)	8	47	PNEJ1230N	PTMA0404F	TW15S
100-06	10	100	6	25	31.75 (32)	7.94 (8)	35.18 (34.8)	8	47	PNEJ1235N	PTMA0405F	TW15S
100-07	10	100	7	25	31.75 (32)	7.94 (8)	35.18 (34.8)	10	47	PNEJ1240N	PTMA0406F	TW15S
100-08	10	100	8	25	31.75 (32)	7.94 (8)	35.18 (34.8)	10	47	PNEJ1245N	PTKA0407F	TW15S
100-09	10	100	9	25	31.75 (32)	7.94 (8)	35.18 (34.8)	12	47	PNEJ1250N	PTKA0408F	TW15S
100-10	10	100	10	25	31.75 (32)	7.94 (8)	35.18 (34.8)	12	47	PNEJ1255N	PTKA0409F	TW15S
125-04	12	125	4	30	38.1 (40)	9.53 (10)	42.32 (43.5)	8	56	PNEJ1223N	PTMA0403F	TW15S
125-05	12	125	5	32	38.1 (40)	9.53 (10)	42.32 (43.5)	8	56	PNEJ1230N	PTMA0404F	TW15S
125-06	12	125	6	32	38.1 (40)	9.53 (10)	42.32 (43.5)	8	56	PNEJ1235N	PTMA0405F	TW15S
125-07	12	125	7	32	38.1 (40)	9.53 (10)	42.32 (43.5)	10	56	PNEJ1240N	PTMA0406F	TW15S
125-08	12	125	8	32	38.1 (40)	9.53 (10)	42.32 (43.5)	10	56	PNEJ1245N	PTKA0407F	TW15S
125-09	12	125	9	32	38.1 (40)	9.53 (10)	42.32 (43.5)	12	56	PNEJ1250N	PTKA0408F	TW15S
125-10	12	125	10	32	38.1 (40)	9.53 (10)	42.32 (43.5)	12	56	PNEJ1255N	PTKA0409F	TW15S
160-04	16	160	4	45	38.1 (40)	9.53 (10)	42.32 (43.5)	8	66	PNEJ1223N	PTMA0403F	TW15S
160-05	16	160	5	45	38.1 (40)	9.53 (10)	42.32 (43.5)	8	66	PNEJ1230N	PTMA0404F	TW15S
160-06	16	160	6	45	38.1 (40)	9.53 (10)	42.32 (43.5)	8	66	PNEJ1235N	PTMA0405F	TW15S
160-07	16	160	7	45	38.1 (40)	9.53 (10)	42.32 (43.5)	10	66	PNEJ1240N	PTMA0406F	TW15S
160-08	16	160	8	45	38.1 (40)	9.53 (10)	42.32 (43.5)	10	66	PNEJ1245N	PTKA0407F	TW15S
160-09	16	160	9	45	38.1 (40)	9.53 (10)	42.32 (43.5)	12	66	PNEJ1250N	PTKA0408F	TW15S
160-10	16	160	10	45	38.1 (40)	9.53 (10)	42.32 (43.5)	12	66	PNEJ1255N	PTKA0409F	TW15S
160-11	16	160	11	45	38.1 (40)	9.53 (10)	42.32 (43.5)	14	66	PNEJ1260N	PTKA0410F	TW15S
160-12	16	160	12	45	38.1 (40)	9.53 (10)	42.32 (43.5)	14	66	PNEJ1265N	PTKA0411F	TW15S
160-13	16	160	13	45	38.1 (40)	9.53 (10)	42.32 (43.5)	16	66	PNEJ1270N	PTKA0412F	TW15S
160-14	16	160	14	45	38.1 (40)	9.53 (10)	42.32 (43.5)	16	66	PNEJ1275N	PTKA0413F	TW15S
200-06	18	200	6	60	50.8 (50)	12.7 (12)	55.83 (53.5)	8	70	PNEJ1235N	PTMA0405F	TW15S
200-07	18	200	7	60	50.8 (50)	12.7 (12)	55.83 (53.5)	10	70	PNEJ1240N	PTMA0406F	TW15S
200-08	18	200	8	60	50.8 (50)	12.7 (12)	55.83 (53.5)	10	70	PNEJ1245N	PTKA0407F	TW15S
200-09	18	200	9	60	50.8 (50)	12.7 (12)	55.83 (53.5)	12	70	PNEJ1250N	PTKA0408F	TW15S
200-10	18	200	10	60	50.8 (50)	12.7 (12)	55.83 (53.5)	12	70	PNEJ1255N	PTKA0409F	TW15S
200-11	18	200	11	60	50.8 (50)	12.7 (12)	55.83 (53.5)	14	70	PNEJ1260N	PTKA0410F	TW15S
200-12	18	200	12	60	50.8 (50)	12.7 (12)	55.83 (53.5)	14	70	PNEJ1265N	PTKA0411F	TW15S
200-13	18	200	13	60	50.8 (50)	12.7 (12)	55.83 (53.5)	16	70	PNEJ1270N	PTKA0412F	TW15S
200-14	18	200	14	60	50.8 (50)	12.7 (12)	55.83 (53.5)	16	70	PNEJ1275N	PTKA0413F	TW15S

## Available arbors

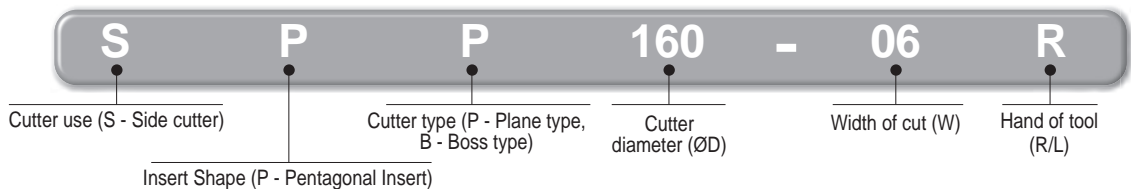
Designation	NC arbors		
	BT30	BT40	BT50
<b>SPP</b> 080-04-06	BT30-SCA25.4-60	BT40-SCA25.4-75/120	BT50-SCA25.4-90/135
100-04-10	-	BT40-SCA31.75-105	BT50-SCA31.75-90/135
125-04-09	-	-	BT50-SCA38.1-90/135
160-04-14	-	-	BT50-SCA38.1-90/135
200-06-14	-	-	-
<b>SPPM</b> 080-04-06	-	BT40-SCA27-75/120	BT50-SCA27-90/135
100-04-10	-	BT40-SCA32-105	BT50-SCA32-90/135
125-04-09	-	-	BT50-SCA40-90/135
160-04-14	-	-	BT50-SCA40-90/135
200-06-14	-	-	-

## Recommended cutting condition

( ) Metric size

Workpiece	Cutting condition		Grades
	vc (m/min)	fz (mm/t)	
<b>P</b>	190-310	0.10-0.25	<b>NCM325</b> <b>PC3700</b> <b>ST30A</b>
	160-270	0.10-0.30	
	60-100	0.10-0.25	
<b>M</b>	90-150	0.10-0.25	<b>PC9530</b> <b>ST30A</b>
	80-150	0.10-0.30	
<b>K</b>	140-230	0.10-0.35	<b>PC6510</b> <b>G10</b>
	50-90	0.10-0.40	

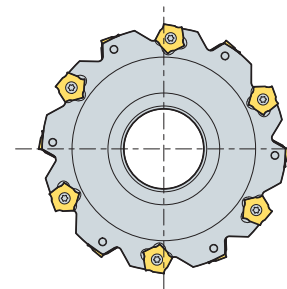
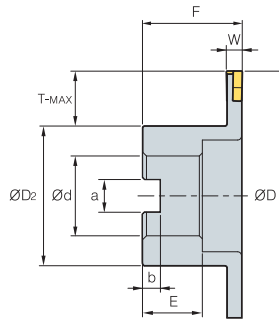
## Code system



Available inserts **E16** Available arbors and bolt **E426-E428**



## SPB(M)



- AR: -2°
- RR: 28°

(mm)

Designation	ØD	W	T-MAX	ØD2	Ød	a	b	F	E	Insert	Screw	Wrench	
<b>SPB (SPBM)</b> 080-04R/L	8	80	4	18	40	25.4 (27)	9.5 (12.4)	6 (7)	50	25 (22)	PNEJ1223N	PTMA0403F	TW15S
080-05R/L	8	80	5	18	40	25.4 (27)	9.5 (12.4)	6 (7)	50	25 (22)	PNEJ1230N	PTMA0404F	TW15S
080-06R/L	8	80	6	18	40	25.4 (27)	9.5 (12.4)	6 (7)	50	25 (22)	PNEJ1235N	PTMA0405F	TW15S
100-04R/L	10	100	4	21	54	31.75 (32)	12.7 (14.4)	8 (8)	50	32 (28)	PNEJ1223N	PTMA0403F	TW15S
100-05R/L	10	100	5	21	54	31.75 (32)	12.7 (14.4)	8 (8)	50	32 (28)	PNEJ1230N	PTMA0404F	TW15S
100-06R/L	10	100	6	21	54	31.75 (32)	12.7 (14.4)	8 (8)	50	32 (28)	PNEJ1235N	PTMA0405F	TW15S
100-07R/L	10	100	7	21	54	31.75 (32)	12.7 (14.4)	8 (8)	50	32 (28)	PNEJ1240N	PTMA0406F	TW15S
100-08R/L	10	100	8	21	54	31.75 (32)	12.7 (14.4)	8 (8)	50	32 (28)	PNEJ1245N	PTMA0407F	TW15S
100-09R/L	10	100	9	21	54	31.75 (32)	12.7 (14.4)	8 (8)	50	32 (28)	PNEJ1250N	PTMA0408F	TW15S
100-10R/L	10	100	10	21	54	31.75 (32)	12.7 (14.4)	8 (8)	50	32 (28)	PNEJ1255N	PTMA0409F	TW15S
125-04R/L	12	125	4	25	70	38.1 (40)	15.9 (16.4)	10 (9)	60 (50)	38 (30)	PNEJ1223N	PTMA0403F	TW15S
125-05R/L	12	125	5	25	70	38.1 (40)	15.9 (16.4)	10 (9)	60 (50)	38 (30)	PNEJ1230N	PTMA0404F	TW15S
125-06R/L	12	125	6	25	70	38.1 (40)	15.9 (16.4)	10 (9)	60 (50)	38 (30)	PNEJ1235N	PTMA0405F	TW15S
125-07R/L	12	125	7	25	70	38.1 (40)	15.9 (16.4)	10 (9)	60 (50)	38 (30)	PNEJ1240N	PTMA0406F	TW15S
125-08R/L	12	125	8	25	70	38.1 (40)	15.9 (16.4)	10 (9)	60 (50)	38 (30)	PNEJ1245N	PTKA0407F	TW15S
125-09R/L	12	125	9	25	70	38.1 (40)	15.9 (16.4)	10 (9)	60 (50)	38 (30)	PNEJ1250N	PTKA0408F	TW15S
125-10R/L	12	125	10	25	70	38.1 (40)	15.9 (16.4)	10 (9)	60 (50)	38 (30)	PNEJ1255N	PTKA0409F	TW15S
160-04R/L	16	160	4	43	70	38.1 (40)	15.9 (16.4)	10 (9)	60 (50)	38 (30)	PNEJ1223N	PTMA0403F	TW15S
160-05R/L	16	160	5	43	70	38.1 (40)	15.9 (16.4)	10 (9)	60 (50)	38 (30)	PNEJ1230N	PTMA0404F	TW15S
160-06R/L	16	160	6	43	70	38.1 (40)	15.9 (16.4)	10 (9)	60 (50)	38 (30)	PNEJ1235N	PTMA0405F	TW15S
160-07R/L	16	160	7	43	70	38.1 (40)	15.9 (16.4)	10 (9)	60 (50)	38 (30)	PNEJ1240N	PTMA0406F	TW15S
160-08R/L	16	160	8	43	70	38.1 (40)	15.9 (16.4)	10 (9)	60 (50)	38 (30)	PNEJ1245N	PTKA0407F	TW15S
160-09R/L	16	160	9	43	70	38.1 (40)	15.9 (16.4)	10 (9)	60 (50)	38 (30)	PNEJ1250N	PTKA0408F	TW15S
160-10R/L	16	160	10	43	70	38.1 (40)	15.9 (16.4)	10 (9)	60 (50)	38 (30)	PNEJ1255N	PTKA0409F	TW15S
160-11R/L	16	160	11	43	70	38.1 (40)	15.9 (16.4)	10 (9)	60 (50)	38 (30)	PNEJ1260N	PTKA0410F	TW15S
160-12R/L	16	160	12	43	70	38.1 (40)	15.9 (16.4)	10 (9)	60 (50)	38 (30)	PNEJ1265N	PTKA0411F	TW15S
160-13R/L	16	160	13	43	70	38.1 (40)	15.9 (16.4)	10 (9)	60 (50)	38 (30)	PNEJ1270N	PTKA0412F	TW15S
160-14R/L	16	160	14	43	70	38.1 (40)	15.9 (16.4)	10 (9)	60 (50)	38 (30)	PNEJ1275N	PTKA0413F	TW15S
200-06R/L	18	200	6	53	90	50.8 (40)	19 (16.4)	11 (9)	65	38 (30)	PNEJ1235N	PTMA0405F	TW15S
200-07R/L	18	200	7	53	90	50.8 (40)	19 (16.4)	11 (9)	65	38 (30)	PNEJ1240N	PTMA0406F	TW15S
200-08R/L	18	200	8	53	90	50.8 (40)	19 (16.4)	11 (9)	65	38 (30)	PNEJ1245N	PTKA0407F	TW15S
200-09R/L	18	200	9	53	90	50.8 (40)	19 (16.4)	11 (9)	65	38 (30)	PNEJ1250N	PTKA0408F	TW15S
200-10R/L	18	200	10	53	90	50.8 (40)	19 (16.4)	11 (9)	65	38 (30)	PNEJ1255N	PTKA0409F	TW15S
200-11R/L	18	200	11	53	90	50.8 (40)	19 (16.4)	11 (9)	65	38 (30)	PNEJ1260N	PTKA0410F	TW15S
200-12R/L	18	200	12	53	90	50.8 (40)	19 (16.4)	11 (9)	65	38 (30)	PNEJ1265N	PTKA0411F	TW15S
200-13R/L	18	200	13	53	90	50.8 (40)	19 (16.4)	11 (9)	65	38 (30)	PNEJ1270N	PTKA0412F	TW15S
200-14R/L	18	200	14	53	90	50.8 (40)	19 (16.4)	11 (9)	65	38 (30)	PNEJ1275N	PTKA0413F	TW15S

( )Metric size

### Notice (When mounting inserts)

- ▶ Insert chip breaker should face chip pocket of the cutter
- ▶ Fasten screw after insert contacts securely on its seat
- ▶ If there is a gap between insert and its seat after mounting it may cause tool troubles

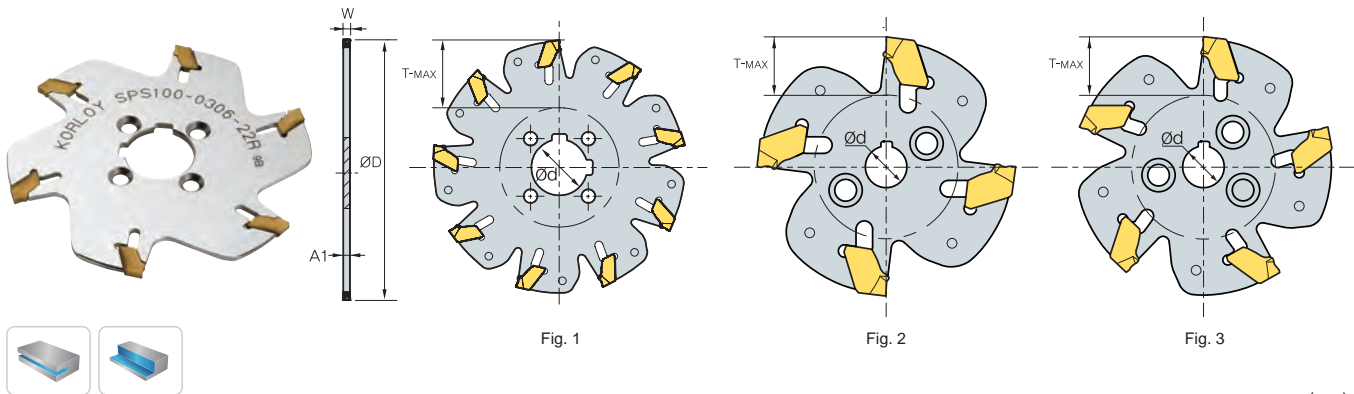
### Recommended cutting condition

Workpiece	Cutting condition		Grades
	vc (m/min)	fz (mm/t)	
P	190~310	0.10~0.25	NCM325 PC3700 ST30A
	160~270	0.10~0.30	
	60~100	0.10~0.25	
M	90~150	0.10~0.25	PC9530 ST30A
	80~150	0.10~0.30	
K	140~230	0.10~0.35 0.10~0.40	PC6510 G10

Available inserts E16 Available arbors and bolt E426-E428



# SPS

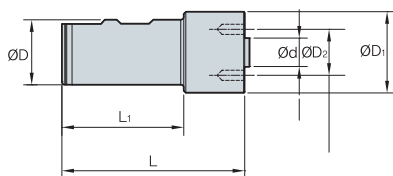


(mm)

Designation	⊙	ØD	W	T-MAX	Ød	A1	Fig.	Insert	Adaptor		Wrench	
									WS	DF		
SPS	050-0204-08R	4	50	2.2	11	8	1.8	SPFN 200 - ( )	WS2528-M4	-	SW17P (separately ordered)	
	063-0205-10R	5	63	2.2	15.5	10	1.8		3	WS2532-M5		-
	080-0207-22R/F	7	80	2.2	20 (17)	22	1.8		1	WS3240-M5		DF22-46
	100-0209-22R/F	9	100	2.2	30 (27)	22	1.8		1	WS3240-M5		DF22-46
	125-0211-32F	11	125	2.2	35	32	1.8		1	-		DF32-55
	160-0214-32F	14	160	2.2	52.5	32	1.8	3	-	DF32-55		
	063-0305-10R	5	63	3	15.5	10	2.55	1	SPFN 300 - ( )	WS2532-M5		-
	080-0307-22R/F	7	80	3	20 (17)	22	2.55	1		WS3240-M5		DF22-46
	100-0309-22R/F	9	100	3	30 (27)	22	2.55	1		WS3240-M5		DF22-46
	125-0311-32F	11	125	3	35	32	2.55	1		-		DF32-55
	160-0314-32F	14	160	3	52.5	32	2.55	1		-		DF32-55
	200-0318-40F	18	200	3	60	40	2.55	1	-	DF40-80		
	080-0406-22R/F	6	80	4	20 (17)	22	3.4	1	SPFN 400 - ( )	WS3240-M5		DF22-46
	100-0408-22R/F	8	100	4	30 (27)	22	3.4	1		WS3240-M5		DF22-46
	125-0410-32F	10	125	4	35	32	3.4	1		-		DF32-55
	160-0413-32F	13	160	4	52.5	32	3.4	1		-		DF32-55
	200-0417-40F	17	200	4	60	40	3.4	1		-		DF40-80

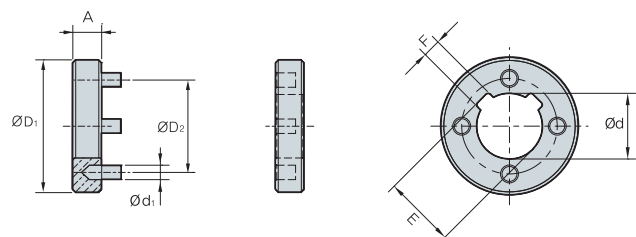
( ) Metric size

## WS( )-( ) (Weldon Shank)



Designation	L	L1	D	D1	D2	d	Screw
WS2528-M4	110	85	25	28	18	8	PTKA0408
WS2532-M5	110	85	25	32	22	10	PTKA0515
WS3240-M5	120	90	32	40	32	22	PTKA0515

## DF( )-( ) (Drive Flange set)



Designation	D1	D2	d	d1	A	E	F
DF22-46	46	32	22	5	10	24.1	6
DF32-55	55	45	32	6	10	34.8	8
DF40-80	80	63	40	11	12	43.5	10
DF50-110	110	80	50	14	14	53.6	12

## Recommended cutting condition

Workpiece	Cutting condition		Grades
	vc (m/min)	fz (mm/t)	
P	160~270	0.13~0.25	PC3700
M	90~150	0.10~0.22	PC5300
K	110~180	0.10~0.25	PC6510

Available inserts **E26** Available arbors and bolt **E426-E428**

# E Technical Information for Wind Mill

For slotting workpieces with corner radii of varying sizes and widths

## Wind Mill

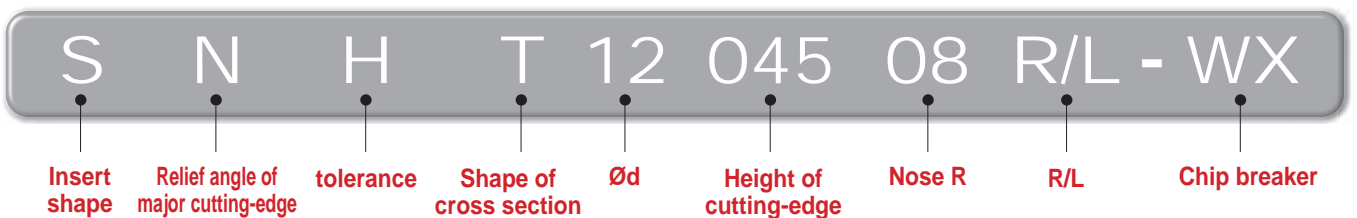
- Optimal machining for slotting applications
- A unique recess design on the minor cutting-edge reduces cutting load and improves tool life
- Special clamping system prevents incorrect clamping and fracture

### Item description

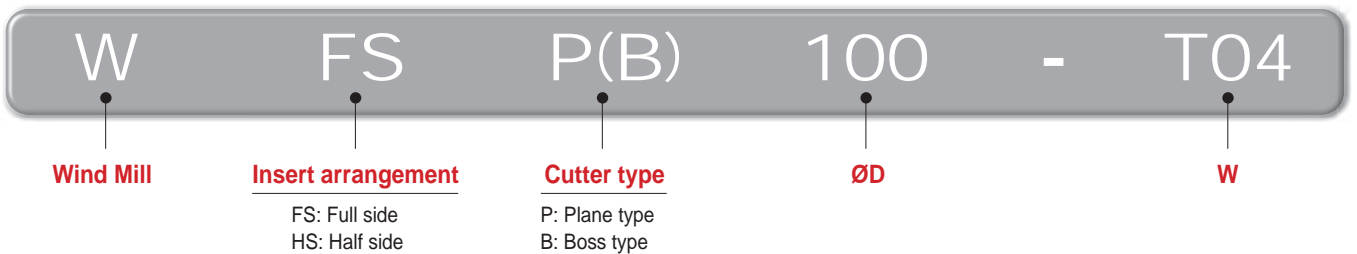


### Code system

#### • Insert

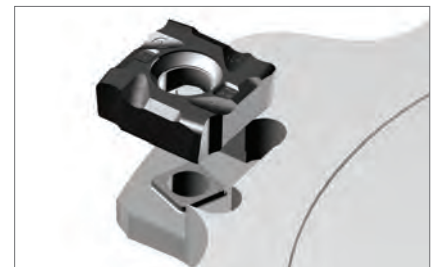
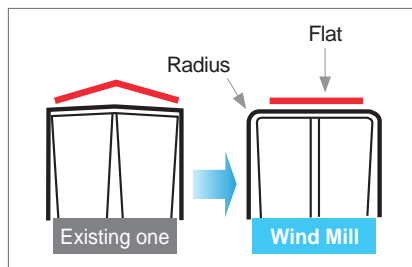


#### • Cutter

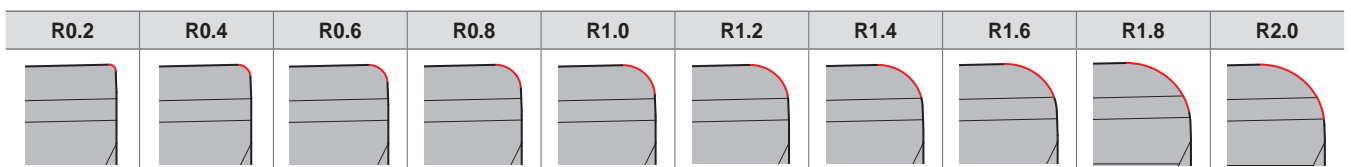


### Features

- Ideal geometry for superior surface roughness and extended tool life
- Perpendicular slot
- Protruded part on tip seat prevents wrong clamping and fracture



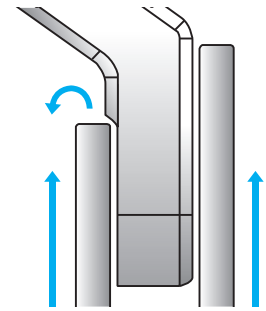
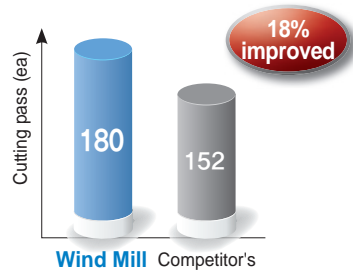
- Workpieces with corner radii of varying size and width (R0.2~R2.0)



## Application example

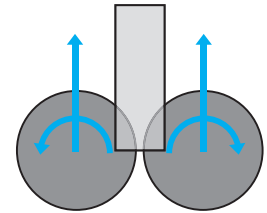
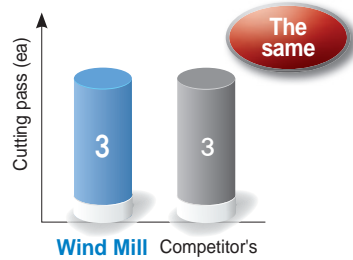
- **Use** Carriers for Motor Vehicles
- **Workpiece** FCD500K
- **Cutting conditions**
  - vc (m/min) = 200
  - fz (mm/t) = 0.2
  - vf (mm/min) = 600
  - ap (mm) = 2~3
- **Tool**
  - KSF140R-T14-HM-2
  - SNHT1205408R/L-WX (PC5300)

### Test result



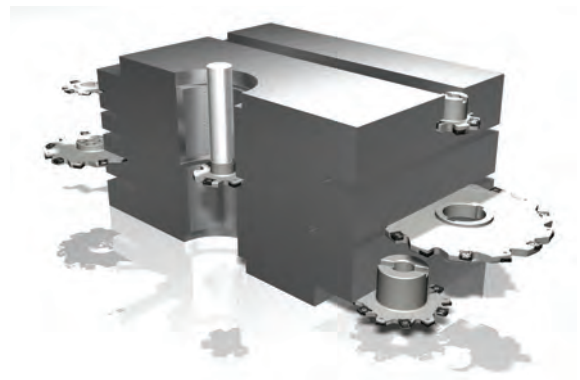
- **Use** Lug for Vessel
- **Workpiece** Mild steel
- **Cutting conditions**
  - vc (m/min) = 560
  - fz (mm/t) = 0.09
  - vf (mm/min) = 750
  - ap (mm) = 6
- **Tool**
  - WFSP178R/L-T06
  - SNHT1203508R/L-WX (PC5300)

### Test result



## Recommended cutting condition

Workpiece	Cutting conditions		Grades
	vc (m/min)	fz (mm/t)	
P	150~250	0.10~0.25	PC5300
M	120~200	0.10~0.30	PC5300
K	100~150	0.10~0.30	PC5300



## Available inserts

Designation	Coated PC5300	Dimensions (mm)				Nose R	Configuration
		Ød	Ød <sub>1</sub>	t	W		
SNHT 1102308R/L-WX	●	11.0	4	2.30	4.0	0.2, 0.4, 0.6, 0.8, 1.0, 1.2, 1.4, 1.6	
110308R/L-WX	●	11.0	4	3.00	5.0	0.2, 0.4, 0.6, 0.8, 1.0, 1.2, 1.4, 1.6	
1203508R/L-WX	●	12.7	5	3.54	6.0	0.2, 0.4, 0.6, 0.8, 1.0, 1.2, 1.4, 1.6, 2.0	
120408R/L-WX		12.7	5	4.00	7.0	0.2, 0.4, 0.6, 0.8, 1.0, 1.2, 1.4, 1.6, 2.0	
1204508R/L-WX	●	12.7	5	4.54	8.0	0.2, 0.4, 0.6, 0.8, 1.0, 1.2, 1.4, 1.6, 2.0	
120508R/L-WX	●	12.7	5	5.00	9.0	0.2, 0.4, 0.6, 0.8, 1.0, 1.2, 1.4, 1.6, 2.0	
1205408R/L-WX	●	12.7	5	5.47	10.0	0.2, 0.4, 0.6, 0.8, 1.0, 1.2, 1.4, 1.6, 2.0	
120608R/L-WX		12.7	5	6.00	11.0	0.2, 0.4, 0.6, 0.8, 1.0, 1.2, 1.4, 1.6, 2.0	
1206508R/L-WX		12.7	5	6.50	12.0	0.2, 0.4, 0.6, 0.8, 1.0, 1.2, 1.4, 1.6, 2.0	
120708R/L-WX		12.7	5	7.00	13.0	0.2, 0.4, 0.6, 0.8, 1.0, 1.2, 1.4, 1.6, 2.0	
1207508R/L-WX		12.7	5	7.50	14.0	0.2, 0.4, 0.6, 0.8, 1.0, 1.2, 1.4, 1.6, 2.0	

• Available cutter stock requires to be asked separately



## WFSB(M) (Boss type)

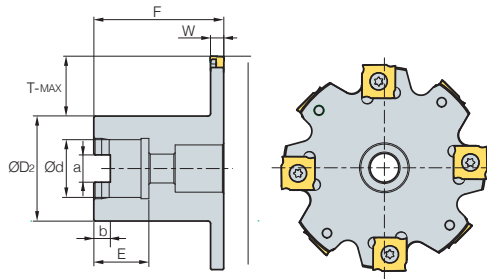


Fig. 1

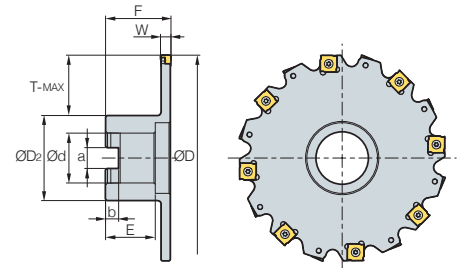


Fig. 2



- AR: -2°
- RR: -12°

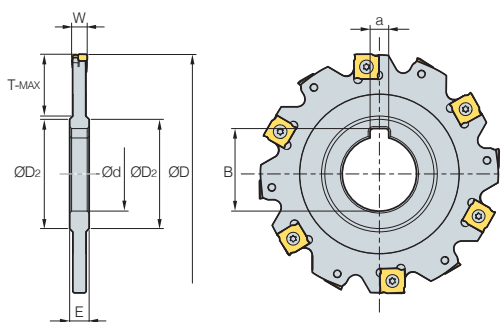
(mm)

Designation	ØD	W	T-MAX	ØD <sub>2</sub>	Ød	a	b	F	E	Insert	Screw	Wrench
<b>WFSBM</b> 080R/L-T04	8	80	4	17	40	22	10.4	6.3	50	21	SNHT11023R/L-WX	PTMA03503 TW09S
080R/L-T05	8	80	5	17	40	22	10.4	6.3	50	21	SNHT1103R/L-WX	PTMA03504 TW09S
080R/L-T06	8	80	6	17	40	22	10.4	6.3	50	21	SNHT12035R/L-WX	PTMA04045F TW15S
<b>WFSB (WFSBM)</b> 100R/L-T04	10	100	4	21	50 (48)	25.4 (27)	9.5 (12.4)	6 (7)	50	25	SNHT11023R/L-WX	PTMA03503 TW09S
100R/L-T05	10	100	5	21	50 (48)	25.4 (27)	9.5 (12.4)	6 (7)	50	25	SNHT1103R/L-WX	PTMA03504 TW09S
100R/L-T06	10	100	6	21	50 (48)	25.4 (27)	9.5 (12.4)	6 (7)	50	25	SNHT12035R/L-WX	PTMA04045F TW15S
100R/L-T07	10	100	7	21	50 (48)	25.4 (27)	9.5 (12.4)	6 (7)	50	25	SNHT1204R/L-WX	PTMA0405F TW15S
100R/L-T08	10	100	8	21	50 (48)	25.4 (27)	9.5 (12.4)	6 (7)	50	25	SNHT12045R/L-WX	PTMA0406F TW15S
100R/L-T09	10	100	9	21	50 (48)	25.4 (27)	9.5 (12.4)	6 (7)	50	25	SNHT1205R/L-WX	PTMA0407F TW15S
100R/L-T10	10	100	10	21	50 (48)	25.4 (27)	9.5 (12.4)	6 (7)	50	25	SNHT12054R/L-WX	PTMA0408F TW15S
125R/L-T04	12	125	4	30	60 (58)	31.75 (32)	12.7 (14.4)	8	50	32 (30)	SNHT11023R/L-WX	PTMA03503 TW09S
125R/L-T05	12	125	5	30	60 (58)	31.75 (32)	12.7 (14.4)	8	50	32 (30)	SNHT1103R/L-WX	PTMA03504 TW09S
125R/L-T06	12	125	6	30	60 (58)	31.75 (32)	12.7 (14.4)	8	50	32 (30)	SNHT12035R/L-WX	PTMA04045F TW15S
125R/L-T07	12	125	7	30	60 (58)	31.75 (32)	12.7 (14.4)	8	50	32 (30)	SNHT1204R/L-WX	PTMA0405F TW15S
125R/L-T08	12	125	8	30	60 (58)	31.75 (32)	12.7 (14.4)	8	50	32 (30)	SNHT12045R/L-WX	PTMA0406F TW15S
125R/L-T09	12	125	9	30	60 (58)	31.75 (32)	12.7 (14.4)	8	50	32 (30)	SNHT1205R/L-WX	PTMA0407F TW15S
125R/L-T10	12	125	10	30	60 (58)	31.75 (32)	12.7 (14.4)	8	50	32 (30)	SNHT12054R/L-WX	PTMA0408F TW15S
160R/L-T04	16	160	4	43	70	38.1 (40)	15.9 (16.4)	10 (9)	60	38 (32)	SNHT11023R/L-WX	PTMA03503 TW09S
160R/L-T05	16	160	5	43	70	38.1 (40)	15.9 (16.4)	10 (9)	60	38 (32)	SNHT1103R/L-WX	PTMA03504 TW09S
160R/L-T06	16	160	6	43	70	38.1 (40)	15.9 (16.4)	10 (9)	60	38 (32)	SNHT12035R/L-WX	PTMA04045F TW15S
160R/L-T07	16	160	7	43	70	38.1 (40)	15.9 (16.4)	10 (9)	60	38 (32)	SNHT1204R/L-WX	PTMA0405F TW15S
160R/L-T08	16	160	8	43	70	38.1 (40)	15.9 (16.4)	10 (9)	60	38 (32)	SNHT12045R/L-WX	PTMA0406F TW15S
160R/L-T09	16	160	9	43	70	38.1 (40)	15.9 (16.4)	10 (9)	60	38 (32)	SNHT1205R/L-WX	PTMA0407F TW15S
160R/L-T10	16	160	10	43	70	38.1 (40)	15.9 (16.4)	10 (9)	60	38 (32)	SNHT12054R/L-WX	PTMA0408F TW15S
160R/L-T11	16	160	11	43	70	38.1 (40)	15.9 (16.4)	10 (9)	60	38 (32)	SNHT1206R/L-WX	PTKA0409F TW15S
160R/L-T12	16	160	12	43	70	38.1 (40)	15.9 (16.4)	10 (9)	60	38 (32)	SNHT12065R/L-WX	PTKA0410F TW15S
160R/L-T13	16	160	13	43	70	38.1 (40)	15.9 (16.4)	10 (9)	60	38 (32)	SNHT1207R/L-WX	PTKA0411F TW15S
160R/L-T14	16	160	14	43	70	38.1 (40)	15.9 (16.4)	10 (9)	60	38 (32)	SNHT12075R/L-WX	PTKA0412F TW15S
200R/L-T06	18	200	6	53	90	50.8 (40)	19.1 (16.4)	11 (9)	65	38 (32)	SNHT12035R/L-WX	PTMA04045F TW15S
200R/L-T07	18	200	7	53	90	50.8 (40)	19.1 (16.4)	11 (9)	65	38 (32)	SNHT1204R/L-WX	PTMA0405F TW15S
200R/L-T08	18	200	8	53	90	50.8 (40)	19.1 (16.4)	11 (9)	65	38 (32)	SNHT12045R/L-WX	PTMA0406F TW15S
200R/L-T09	18	200	9	53	90	50.8 (40)	19.1 (16.4)	11 (9)	65	38 (32)	SNHT1205R/L-WX	PTMA0407F TW15S
200R/L-T10	18	200	10	53	90	50.8 (40)	19.1 (16.4)	11 (9)	65	38 (32)	SNHT12054R/L-WX	PTMA0408F TW15S
200R/L-T11	18	200	11	53	90	50.8 (40)	19.1 (16.4)	11 (9)	65	38 (32)	SNHT1206R/L-WX	PTKA0409F TW15S
200R/L-T12	18	200	12	53	90	50.8 (40)	19.1 (16.4)	11 (9)	65	38 (32)	SNHT12065R/L-WX	PTKA0410F TW15S
200R/L-T13	18	200	13	53	90	50.8 (40)	19.1 (16.4)	11 (9)	65	38 (32)	SNHT1207R/L-WX	PTKA0411F TW15S
200R/L-T14	18	200	14	53	90	50.8 (40)	19.1 (16.4)	11 (9)	65	38 (32)	SNHT12075R/L-WX	PTKA0412F TW15S
250R/L-T06	20	250	6	73 (78)	100 (90)	50.8 (40)	19.1 (16.4)	11 (9)	65	38 (32)	SNHT12035R/L-WX	PTMA04045F TW15S
250R/L-T07	20	250	7	73 (78)	100 (90)	50.8 (40)	19.1 (16.4)	11 (9)	65	38 (32)	SNHT1204R/L-WX	PTMA0405F TW15S
250R/L-T08	20	250	8	73 (78)	100 (90)	50.8 (40)	19.1 (16.4)	11 (9)	65	38 (32)	SNHT12045R/L-WX	PTMA0406F TW15S
250R/L-T09	20	250	9	73 (78)	100 (90)	50.8 (40)	19.1 (16.4)	11 (9)	65	38 (32)	SNHT1205R/L-WX	PTMA0407F TW15S
250R/L-T10	20	250	10	73 (78)	100 (90)	50.8 (40)	19.1 (16.4)	11 (9)	65	38 (32)	SNHT12054R/L-WX	PTMA0408F TW15S
250R/L-T11	20	250	11	73 (78)	100 (90)	50.8 (40)	19.1 (16.4)	11 (9)	65	38 (32)	SNHT1206R/L-WX	PTKA0409F TW15S
250R/L-T12	20	250	12	73 (78)	100 (90)	50.8 (40)	19.1 (16.4)	11 (9)	65	38 (32)	SNHT12065R/L-WX	PTKA0410F TW15S
250R/L-T13	20	250	13	73 (78)	100 (90)	50.8 (40)	19.1 (16.4)	11 (9)	65	38 (32)	SNHT1207R/L-WX	PTKA0411F TW15S
250R/L-T14	20	250	14	73 (78)	100 (90)	50.8 (40)	19.1 (16.4)	11 (9)	65	38 (32)	SNHT12075R/L-WX	PTKA0412F TW15S

• Ø80: Fig.1 , Ø100-Ø250: Fig.2 ( )Metric size Available inserts E25



# WFSP(M) (Plane type)



- AR: -2°
- RR: -12°

(mm)

Designation		ØD	W	T-MAX	ØD <sub>2</sub>	Ød	a	b	E	Insert	Screw	Wrench	
<b>WFSP (WFSBM)</b>	<b>080-T04</b>	8	80	4	20	40	25.4 (27)	6.35 (7)	28 (29.8)	8	SNHT11023R/L-WX	PTMA03503	TW09S
	<b>080-T05</b>	8	80	5	20	40	25.4 (27)	6.35 (7)	28 (29.8)	8	SNHT1103R/L-WX	PTMA03504	TW09S
	<b>080-T06</b>	8	80	6	20	40	25.4 (27)	6.35 (7)	28 (29.8)	8	SNHT12035R/L-WX	PTMA04045F	TW15S
	<b>100-T04</b>	10	100	4	24	47	31.75 (32)	7.92 (8)	35.2 (34.8)	8	SNHT11023R/L-WX	PTMA03503	TW09S
	<b>100-T05</b>	10	100	5	24	47	31.75 (32)	7.92 (8)	35.2 (34.8)	8	SNHT1103R/L-WX	PTMA03504	TW09S
	<b>100-T06</b>	10	100	6	24	47	31.75 (32)	7.92 (8)	35.2 (34.8)	8	SNHT12035R/L-WX	PTMA04045F	TW15S
	<b>100-T07</b>	10	100	7	24	47	31.75 (32)	7.92 (8)	35.2 (34.8)	10	SNHT1204R/L-WX	PTMA0405F	TW15S
	<b>100-T08</b>	10	100	8	24	47	31.75 (32)	7.92 (8)	35.2 (34.8)	10	SNHT12045R/L-WX	PTMA0406F	TW15S
	<b>100-T09</b>	10	100	9	24	47	31.75 (32)	7.92 (8)	35.2 (34.8)	12	SNHT1205R/L-WX	PTMA0407F	TW15S
	<b>100-T10</b>	10	100	10	24	47	31.75 (32)	7.92 (8)	35.2 (34.8)	12	SNHT12054R/L-WX	PTMA0408F	TW15S
	<b>125-T04</b>	12	125	4	32	56	38.1 (40)	9.52 (10)	42.3 (43.5)	8	SNHT11023R/L-WX	PTMA03503	TW09S
	<b>125-T05</b>	12	125	5	32	56	38.1 (40)	9.52 (10)	42.3 (43.5)	8	SNHT1103R/L-WX	PTMA03504	TW09S
	<b>125-T06</b>	12	125	6	32	56	38.1 (40)	9.52 (10)	42.3 (43.5)	8	SNHT12035R/L-WX	PTMA04045F	TW15S
	<b>125-T07</b>	12	125	7	32	56	38.1 (40)	9.52 (10)	42.3 (43.5)	10	SNHT1204R/L-WX	PTMA0405F	TW15S
	<b>125-T08</b>	12	125	8	32	56	38.1 (40)	9.52 (10)	42.3 (43.5)	10	SNHT12045R/L-WX	PTMA0406F	TW15S
	<b>125-T09</b>	12	125	9	32	56	38.1 (40)	9.52 (10)	42.3 (43.5)	12	SNHT1205R/L-WX	PTMA0407F	TW15S
	<b>125-T10</b>	12	125	10	32	56	38.1 (40)	9.52 (10)	42.3 (43.5)	12	SNHT12054R/L-WX	PTMA0408F	TW15S
	<b>160-T04</b>	16	160	4	45	66	38.1 (40)	9.52 (10)	42.3 (43.5)	8	SNHT11023R/L-WX	PTMA03503	TW09S
	<b>160-T05</b>	16	160	5	45	66	38.1 (40)	9.52 (10)	42.3 (43.5)	8	SNHT1103R/L-WX	PTMA03504	TW09S
	<b>160-T06</b>	16	160	6	45	66	38.1 (40)	9.52 (10)	42.3 (43.5)	8	SNHT12035R/L-WX	PTMA04045F	TW15S
	<b>160-T07</b>	16	160	7	45	66	38.1 (40)	9.52 (10)	42.3 (43.5)	10	SNHT1204R/L-WX	PTMA0405F	TW15S
	<b>160-T08</b>	16	160	8	45	66	38.1 (40)	9.52 (10)	42.3 (43.5)	10	SNHT12045R/L-WX	PTMA0406F	TW15S
	<b>160-T09</b>	16	160	9	45	66	38.1 (40)	9.52 (10)	42.3 (43.5)	12	SNHT1205R/L-WX	PTMA0407F	TW15S
	<b>160-T10</b>	16	160	10	45	66	38.1 (40)	9.52 (10)	42.3 (43.5)	12	SNHT12054R/L-WX	PTMA0408F	TW15S
	<b>160-T11</b>	16	160	11	45	66	38.1 (40)	9.52 (10)	42.3 (43.5)	14	SNHT1206R/L-WX	PTKA0409F	TW15S
	<b>160-T12</b>	16	160	12	45	66	38.1 (40)	9.52 (10)	42.3 (43.5)	14	SNHT12065R/L-WX	PTKA0410F	TW15S
	<b>160-T13</b>	16	160	13	45	66	38.1 (40)	9.52 (10)	42.3 (43.5)	16	SNHT1207R/L-WX	PTKA0411F	TW15S
	<b>160-T14</b>	16	160	14	45	66	38.1 (40)	9.52 (10)	42.3 (43.5)	16	SNHT12075R/L-WX	PTKA0412F	TW15S
	<b>200-T06</b>	18	200	6	60	70	50.8 (50)	12.7 (12)	55.8 (53.5)	8	SNHT12035R/L-WX	PTMA04045F	TW15S
	<b>200-T07</b>	18	200	7	60	70	50.8 (50)	12.7 (12)	55.8 (53.5)	10	SNHT1204R/L-WX	PTMA0405F	TW15S
	<b>200-T08</b>	18	200	8	60	70	50.8 (50)	12.7 (12)	55.8 (53.5)	10	SNHT12045R/L-WX	PTMA0406F	TW15S
	<b>200-T09</b>	18	200	9	60	70	50.8 (50)	12.7 (12)	55.8 (53.5)	12	SNHT1205R/L-WX	PTMA0407F	TW15S
	<b>200-T10</b>	18	200	10	60	70	50.8 (50)	12.7 (12)	55.8 (53.5)	12	SNHT12054R/L-WX	PTMA0408F	TW15S
	<b>200-T11</b>	18	200	11	60	70	50.8 (50)	12.7 (12)	55.8 (53.5)	14	SNHT1206R/L-WX	PTKA0409F	TW15S
	<b>200-T12</b>	18	200	12	60	70	50.8 (50)	12.7 (12)	55.8 (53.5)	14	SNHT12065R/L-WX	PTKA0410F	TW15S
	<b>200-T13</b>	18	200	13	60	70	50.8 (50)	12.7 (12)	55.8 (53.5)	16	SNHT1207R/L-WX	PTKA0411F	TW15S
	<b>200-T14</b>	18	200	14	60	70	50.8 (50)	12.7 (12)	55.8 (53.5)	16	SNHT12075R/L-WX	PTKA0412F	TW15S
	<b>250-T06</b>	20	250	6	88	70	50.8 (50)	12.7 (12)	55.8 (53.5)	8	SNHT12035R/L-WX	PTMA04045F	TW15S
	<b>250-T07</b>	20	250	7	88	70	50.8 (50)	12.7 (12)	55.8 (53.5)	10	SNHT1204R/L-WX	PTMA0405F	TW15S
	<b>250-T08</b>	20	250	8	88	70	50.8 (50)	12.7 (12)	55.8 (53.5)	10	SNHT12045R/L-WX	PTMA0406F	TW15S
	<b>250-T09</b>	20	250	9	88	70	50.8 (50)	12.7 (12)	55.8 (53.5)	12	SNHT1205R/L-WX	PTMA0407F	TW15S
	<b>250-T10</b>	20	250	10	88	70	50.8 (50)	12.7 (12)	55.8 (53.5)	12	SNHT12054R/L-WX	PTMA0408F	TW15S
	<b>250-T11</b>	20	250	11	88	70	50.8 (50)	12.7 (12)	55.8 (53.5)	14	SNHT1206R/L-WX	PTKA0409F	TW15S
	<b>250-T12</b>	20	250	12	88	70	50.8 (50)	12.7 (12)	55.8 (53.5)	14	SNHT12065R/L-WX	PTKA0410F	TW15S
	<b>250-T13</b>	20	250	13	88	70	50.8 (50)	12.7 (12)	55.8 (53.5)	16	SNHT1207R/L-WX	PTKA0411F	TW15S
	<b>250-T14</b>	20	250	14	88	70	50.8 (50)	12.7 (12)	55.8 (53.5)	16	SNHT12075R/L-WX	PTKA0412F	TW15S

Available inserts E25

• Ø80: Fig.1, Ø100-Ø250: Fig.2 ( )Metric size





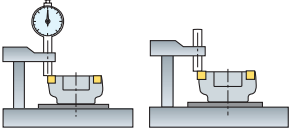
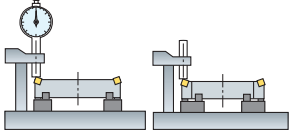
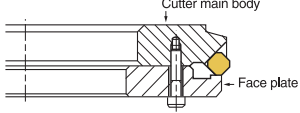
## High feed cutter with extra pitch for cast iron and light alloy steels

# High feed Cutter

- High feed cutter employs extra pitch for cast iron and light alloy steels
- Quick change type for reduction of cutter change time
- Cutting-edge chatter is controlled
- Quick change type for cutter size under  $\varnothing 160$ , 2 piece types for cutter size over  $\varnothing 200$

### Guide of insert setting

- Special equipment has to be used to get precise run out with high feed cutter.

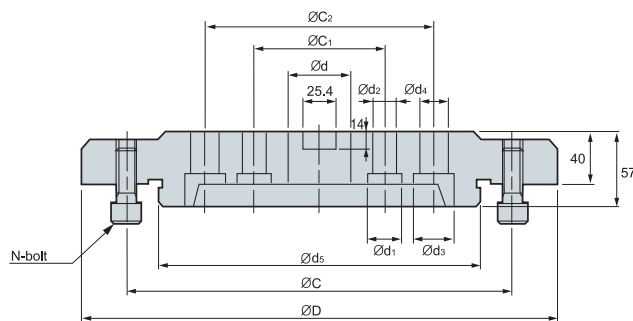
Adaptor type	Roller type	Plate type
		
<ul style="list-style-type: none"> <li>- Mainly under <math>\varnothing 160</math> diameter is used in 1 piece type</li> <li>- Available for fixed size of cutter and assembling &amp; checking can be done at the same time</li> </ul>	<ul style="list-style-type: none"> <li>- Mainly over <math>\varnothing 200</math> diameter is used in 2 piece type</li> <li>- Due to 3 adjustable guide rollers, variety size of cutter can be assembled</li> </ul>	<ul style="list-style-type: none"> <li>- Suitable for small size cutter due to the simple structure</li> <li>- It is unnecessary to unclamp the cutter from the machine, it's possible to reassemble the cutter as it mounted on the machine</li> <li>- You should make plate by yourself</li> </ul>

### Guide of insert setting in adaptor/roller type

1. Clean the cutter and equipment
2. Pointer should be assembled with same height with cutter
3. Move to each insert on tip seat to end of pointer and tighten (torque 2 N.m) wedge
4. Exchange pointer to dial gauge
5. Measure the run-out totally
6. When a insert over run-out, loosen wedge and adjust run-out. (for roughing 10~20  $\mu$ , for finishing 5~10  $\mu$ )
7. Tighten (torque 7-8 N.m) wedge
8. Measure the final run-out by dial gauge

**Note:** When you clamp wedge too tightly, run-out will get worse due to cutter distortion.  
When you clamp the wedge, use torque wrench to set precisely.

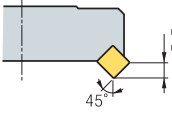
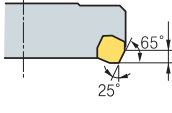
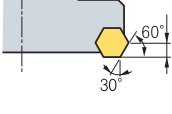
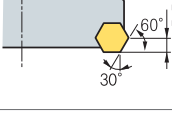


### Adaptor ( $\varnothing 200 \sim \varnothing 450$ )



Designation	$\varnothing D$	$\varnothing d$	$\varnothing d_1$	$\varnothing d_2$	$\varnothing d_3$	$\varnothing d_4$	$\varnothing d_5$	$\varnothing C$	$\varnothing C_1$	$\varnothing C_2$	N	Cutter
APR 200	180	47.625	26	18	-	-	80	120	101.6	-	4	$\varnothing 200$
250	230	47.625	26	18	-	-	120	170	101.6	-	4	$\varnothing 250$
315	295	47.625	26	18	32	22	180	230	101.6	177.8	6	$\varnothing 315$
355	335	63.50	26	18	32	22	220	270	101.6	177.8	6	$\varnothing 355$
400	370	63.50	26	18	32	22	250	300	101.6	177.8	8	$\varnothing 400$
450	420	63.50	26	18	32	22	300	350	101.6	177.8	8	$\varnothing 450$



## High feed cutters type and features

Designation	Cutter diameter	Workpiece, Application range	Min. surface roughness	Approach angle and Max. cutting depth is for 5000 type	Axial rake angle	Radial rake angle	Available insert
ANH4000 ANH5000	Ø100~Ø450	Cast iron Roughing	25Z		-5°	-6°	SNCN1204ENN SNCN1504ENN
CDH4000 CDH5000	Ø100~Ø450	Cast iron Roughing Finishing	18Z		+10°	+5°	SDCN42R SDCN53R
DEH5000	Ø100~Ø450	Al alloy Roughing	20Z		+14°	+6°	HECN090408FN
DPH5000	Ø100~Ø450	Cast iron Roughing Finishing	12Z		+5°	-3°	HPEN090408 HPEN090408-WC
PNH4000 PNH5000	Ø125~Ø450	Cast iron Finishing	12Z		-5°	-6°	SNEF435 SNEF535
PPH4000	Ø125~Ø450	Cast iron Finishing	12Z		+5°	-5°	SPEN120416-WC

## Recommended cutting condition

Workpiece	Cutting condition		Grades	Remark
	vc (m/min)	fz (mm/t)		
Cast iron	100~230	0.05~0.20	PC6510	PVD Coated
	80~150	0.05~0.20	H01, G10	Uncoated
Al alloy	400	0.10~0.30	PC6510	PVD Coated
	400	0.05~0.20	H01, G10	Uncoated

# E Technical Information for Cube Mill

## Special Korloy cutter for cast iron roughing

# Cube Mill

- Special Korloy cutter for cast iron roughing
- 8-corner using insert (maximum 16-corner available with 2 cutter, R/L cutter)
- Excellent cutting performance with positive rake angle made by 3-dimensional chip breaker
- Excellent tool life by a wide combination of grade varieties and chip breakers to match most working conditions
- 2 different type of inserts (chamfer/nose R) are available with 1 type cutter



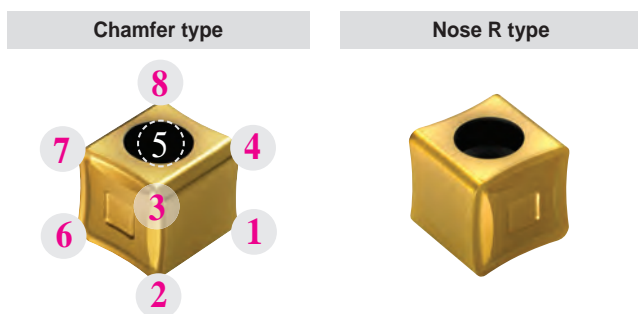
Roughing for cast iron

### Code system

CBM	E	3	250	R	(2)	- 28Z
<b>Cutter</b>	<b>AA</b>	<b>Inscribed circle of Insert</b>	<b>Cutter Dia</b>	<b>Hand</b>	<b>Cutter shape</b>	<b>No. of tooth (Z)</b>
CBM: CUBE MILL	Q: 88° C: 65° F: 85° A: 45° E: 75°	3: 9.525 4: 12.7	Ø250	R: Right L: Left	Unmarked: Normal type 2: Quick change type (2 pieces type)	

※ Cube Mill and Cube Mill Couple are available by order made.

### Insert (R/L type)



### Cutter body

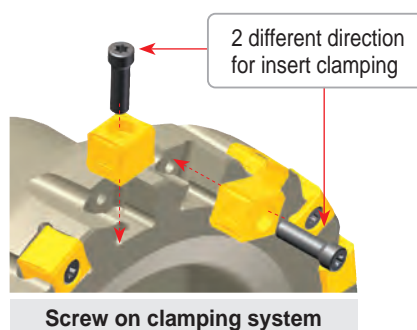
Cutter diameter (Ø)	Normal	Quick change
	Ø80~315 mm	Ø200~450 mm
	3 1/4~12 1/2 Inch	8~18 Inch
AA: 88°, 85°, 75°, 65°, 45°		

### Cutter



Special design to make actual positive rake angle

Simple screw on system



### Parts

<p>Cube Mill 3000</p>	<p>Screw</p>	<p>Wrench</p>
	FTGA0417CBM	TW15-100
	ETGA0520CBM	TW20-100



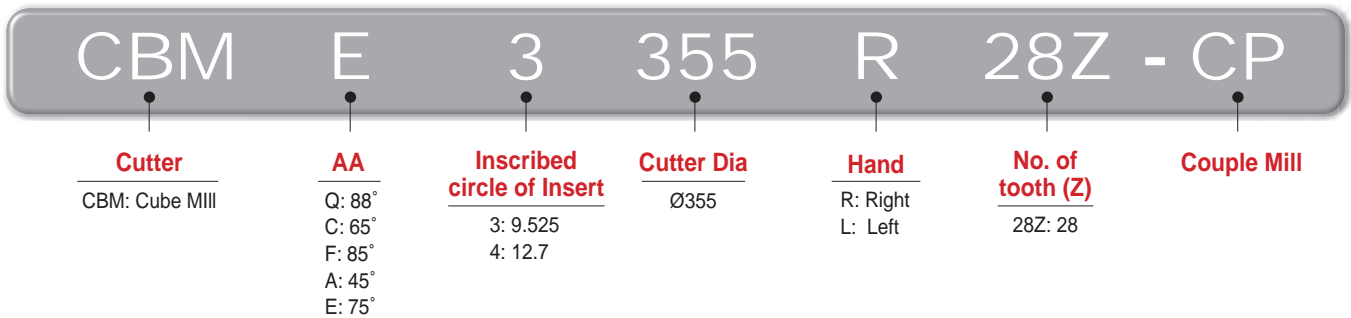
Ideal combination of aluminum body with cast iron high feed cutter

# Couple Mill

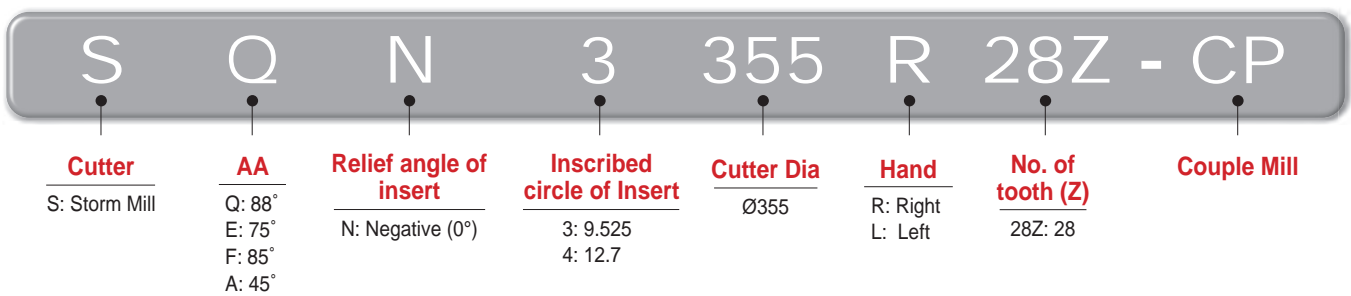
- Ideal combination of Aluminum body with cast iron high feed cutter
- Since the weight of the cutter has been reduced 50% vs. a steel cutter, it is very easy to handle and very effective in preventing loading accidents
- Applicable for Cube Mill, Storm Mill

## Code system

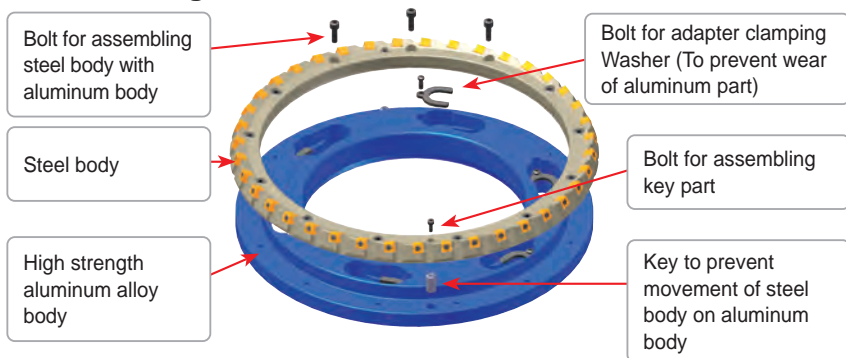
### • Cube-couple



### • Storm-couple



## Assembling structure



## Cutter body

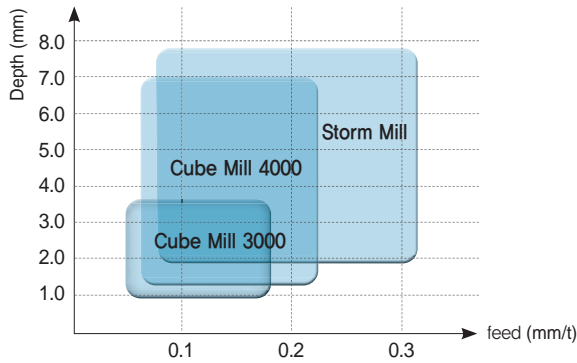
Cutter diameter (Ø)	Quick change	
	Metric	Ø355~450 mm
Inch	14 1/4~18 Inch	

## Parts

Cube-Couple	3000 type	FTGA0417CBM	TW15-100	-	BHA0616	MHBO410	PN1019-DRV
	4000 type	ETGA0520CBM	TW20-100	-	BHA0620	-	-
Storm-Couple	3000 type	FTNA0513	-	TW15S	-	-	-

# E Technical Information for Couple Mill

## Application range of high feed cutters for cast iron



## Recommended cutting condition

Cube Mill		Gray cast iron		Ductile cast iron	
		vc (m/min)	fz (mm/t)	vc (m/min)	fz (mm/t)
PVD	PC6510	150~300	0.08~0.18	100~200	0.08~0.18
Uncoated	G10	90~120	0.05~0.18	60~130	0.05~0.18

## Available arbors and adaptors

Designation	Available arbors and adaptors		
	Arbors	General arbor	Adaptor
CBMQ 3080R/L-00Z	BT□□-FMA25.4-□□	NT*□□(M/U)-FMA25.4-25	
(CBMF) 3100R/L-00Z	BT□□-FMA31.75-□□	NT*□□(M/U)-FMA31.75-□□	
(CBME) 3125R/L-00Z	BT□□-FMA38.1-□□	NT*□□(M/U)-FMA38.1-□□	
(CBMC) 3160R/L-00Z	BT□□-FMA50.8-□□	NT*□□(M/U)-FMA50.8-□□	
(CBMA) 3200R/L-00Z	BT□□-FMA47.625-□□	NT*□□(M/U)-FMA47.625-25, KCP-8***	
3250R/L-00Z	BT□□-FMA47.625-□□	KNT*□□(M/U)-FMA47.625-25, KCP-8***	
3315R/L-00Z		KCP-8*** (Centering Plug)	
3200R/L2-00Z			APR200
3250R/L2-00Z			APR250
3315R/L2-00Z			APR315
3355R/L2-00Z			APR355
3400R/L2-00Z			APR400
3450R/L2-00Z			APR450
SQN 3080R/L-00Z	BT□□-FMA25.4-□□	NT*□□(M/U)-FMA25.4-25	
(SFN) 3100R/L-00Z	BT□□-FMA31.75-□□	NT*□□(M/U)-FMA31.75-□□	
(SEN) 3125R/L-00Z	BT□□-FMA38.1-□□	NT*□□(M/U)-FMA38.1-□□	
(SAN) 3160R/L-00Z	BT□□-FMA50.8-□□	NT*□□(M/U)-FMA50.8-□□	
3200R/L-00Z	BT□□-FMA47.625-□□	NT*□□(M/U)-FMA47.625-25, KCP-8***	
3250R/L-00Z	BT□□-FMA47.625-□□	NT*□□(M/U)-FMA47.625-25, KCP-8***	
3315R/L-00Z		KCP-8*** (Centering Plug)	
3200R/L2-00Z			APR200
3250R/L2-00Z			APR250
3315R/L2-00Z			APR315
3355R/L2-00Z			APR355
3400R/L2-00Z			APR400
3450R/L2-00Z			APR450

\*□□-NT number / \*\*□□-BT number / \*\*\*Milling over 5  
 <Arbors \*\*add>  
 ex) BT\*\*□□



Optimal cutter for steel and cast iron machining with easily adjustable run-out

# Shave Mill

- Adjustable Range (Adjustable range: 0.1 mm, Adjustable allowance: within 2 μm)
- Wiper crown type 8-cornered insert reduces machining cost and realizes excellent surface roughness
- Grades with high toughness and wear resistance ensures long tool life
- The cBN grade achieves superior surface finish

## Code system

### Insert

#### Carbide

Nose R type	SNEU120420-MF
Chamfer type	SNEU1204ANN-MF
Low cutting type	SNEU1204-WMF

#### cBN

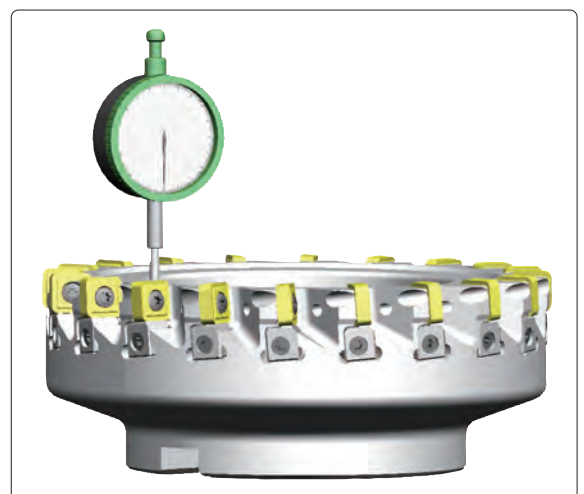
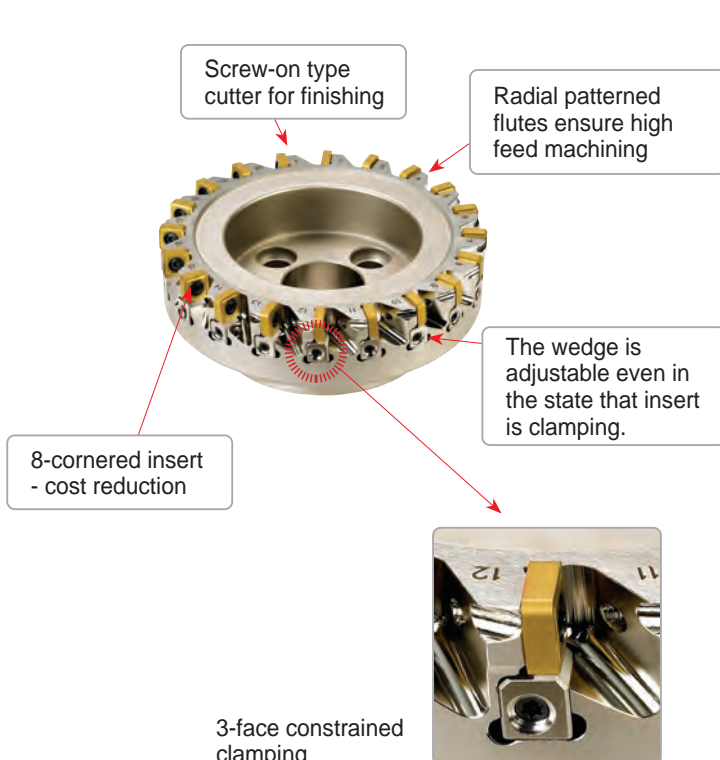
SNEU1204-TBW
--------------

T: Nagaland  
B: cBN  
W: Wiper

### Cutter

SVM	M	4	250	R	Z6
Shave Mill	Metric type M: Metric A: Inch	Inscribed Circle 4: 12.7 mm	Cutter Dia. (Ø) Ø250	Hand of tool R: Right handed L: Left handed	No. of tooth (Z)

## Features

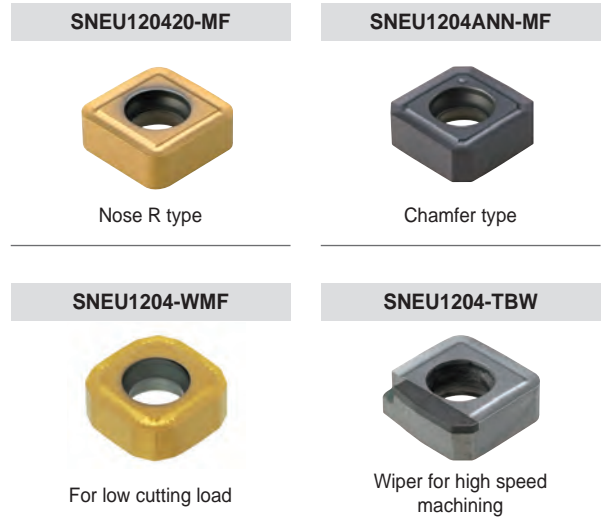
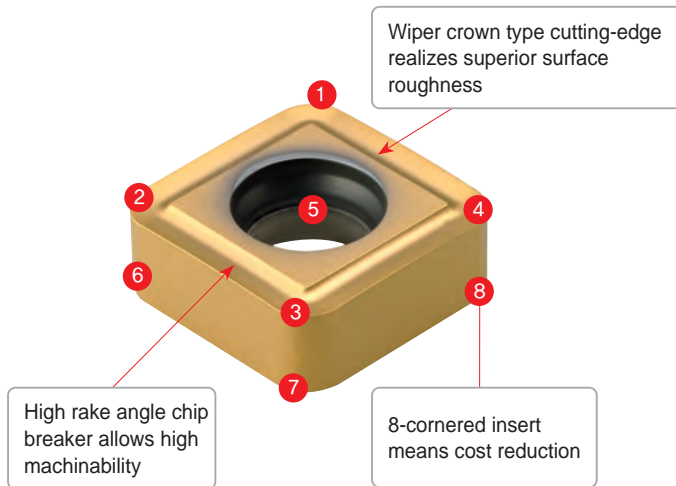


## Adjustment

- Adjustable range: 0.1 mm
- Adjustability: below 2 μ
- Operation: easy and simple

# E Technical Information for Shave Mill

## Features of insert



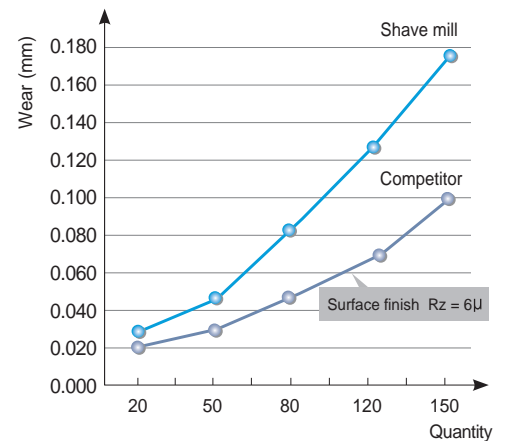
## Recommended cutting condition

Workpiece	Cutting condition			Grades
	vc (m/min)	fz (mm/t)	ap (mm)	
P	160~270	0.05~0.2	~0.5	PC3700
K	140~230 600~1000	0.05~0.3 0.05~0.2	~0.5 ~0.5	PC6510 DBN920

## Application example

- Workpiece: Cylinder head (facing)
- Cutting conditions: vc = 200, fz = 0.15, ap = 0.5, dry
- Tools: Cutter SVMM4250R  
Insert PC6510 SNEU120420-MF

- Workpiece: FC25 (HB250) Cylinder head (facing)
- Cutting conditions: vc = 700, fz = 0.1, ap = 0.5, dry
- Tools: Cutter SVMM4160R  
Insert DBN920 SNEU1204-cBN



## Results

	Tool life	Surface finish	Machinability
Shave Mill	250 pcs	Rz = 3μ	High
Competitor	180 pcs	Rz = 3.5μ	Normal

- KORLOY's Shave Mills ensure twice the machinability, adjustability, and surface roughness than competitor's, along with twice the tool life.





Better tool life with special grade which has both toughness and wear resistance

# Shave Mill-Ultra

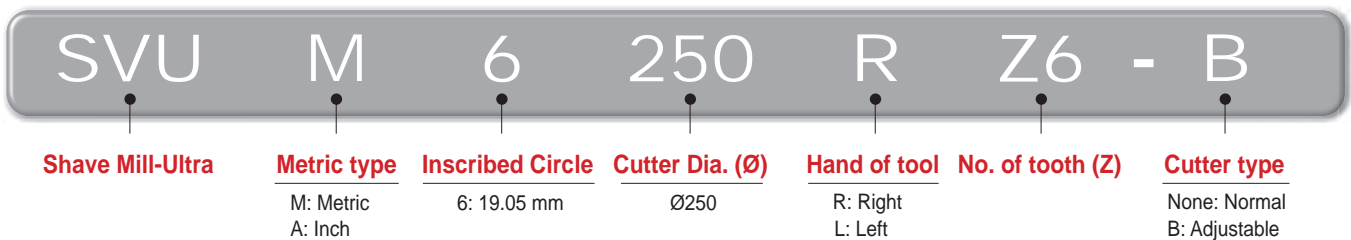
- Superior surface roughness for this Finishing cutter when applied to heavy work pieces
- Easy to handle and good rigidity with simple screw on system
- Superior surface finishes due to the wiper crown cutting-edge
- Better tool life with special grade which has both toughness and wear resistance
- Two different types: economical normal type and adjustable run-out type 'B'

## Code system

### • Insert



### • Cutter



## Features

**Normal type**

- Good rigidity and economical due to simple screw on type
- Better surface roughness when you use only 1 insert but adjust the 'ap' under 0.03 mm

- Good cutting performance & chip flow due to positive rake angle chip breaker
- Economical 4 corner insert
- Good surface roughness by wiper crown cutting-edge design

**Adjustable cutting-edge (Type B)**

- Easy to handle the run-out due to Korloy exclusive high toughness cutting-edge special parts

**Adjustable Range**

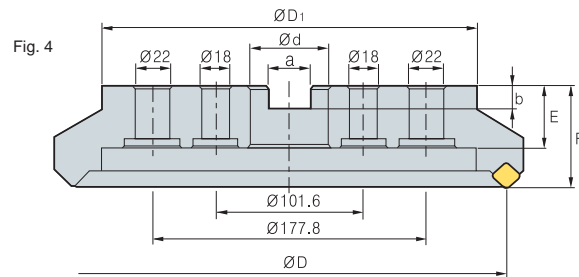
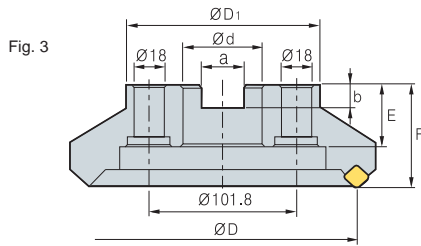
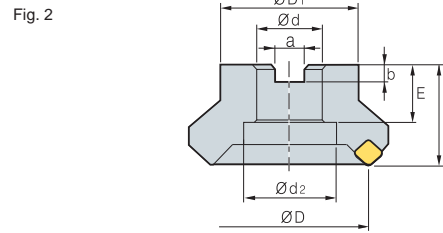
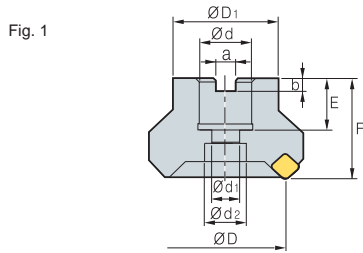
- Range: 1.0 mm
- Allowance: Within 2 μ

## Recommended cutting condition

Workpiece	Cutting condition			Tooth	Grades
	vc (m/min)	fz (mm/t)	ap (mm)		
<b>P</b>	160~270	0.05~0.20	~0.50	Full use	<b>PC3700</b>
	160~270	2~5	~0.03	1 use	
<b>k</b>	140~230	0.05~0.20	~0.50	Full use	<b>PC6510</b>
	140~230	2~5	~0.03	1 use	

## Inch

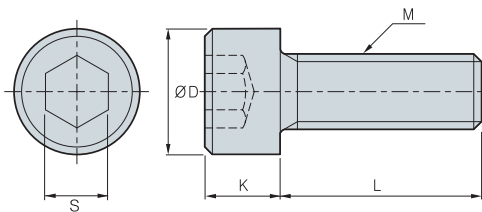
### Actual designations of milling cutter



### Inch type

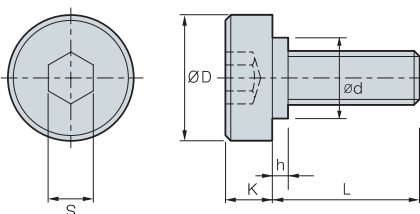
ØD	Ød	Dimensions (mm)				Fig.	Available arbors			
		a	b	E	F					
40	16	8.4	5.6	18	40	34	9	14	1	FMC16, SMA16
50	22	10.4	6.3	20	40	42	11	18	1	FMC22
63	22	10.4	6.3	20	40	49	11	18	1	FMC22
80	25.4	9.5	6	25	50	57	14	20	1	FMA25.4
100	31.75	12.7	8	32	50	67	-	45	2	FMA31.75, SMB31.75
125	38.1	15.9	10	38	63	87	-	56	2	FMA38.1
160	50.8	19	11	38	63	107	-	-	2	FMA50.8
200	47.625	25.4	14	38	63	130	-	-	3	FMA47.625
250	47.625	25.4	14	38	63	180	-	-	3	FMA47.625
315	47.625	25.4	14	38	63	240	-	-	4	-

### Wrench bolt



Designation	ØD	S	K	L	M	Cutter size
SB0825	13	6	8	25	M08x1.25	Ø40
SB1025	16	8	10	25	M10x1.50	Ø50, Ø63
SB1035	16	8	10	35	M10x1.50	Ø50, Ø63 (HRM)
SB1230	18	10	12	30	M12x1.75	Ø80
SB1630	24	14	16	30	M16x2.0	Ø100
SB1645	24	14	16	45	M16x2.0	Ø80, Ø100 (HRM)
SB2040	30	17	20	40	M20x2.5	Ø125

### Clamp bolt

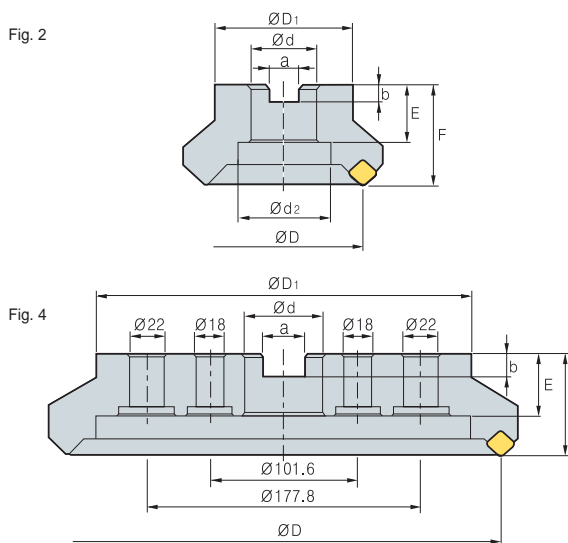
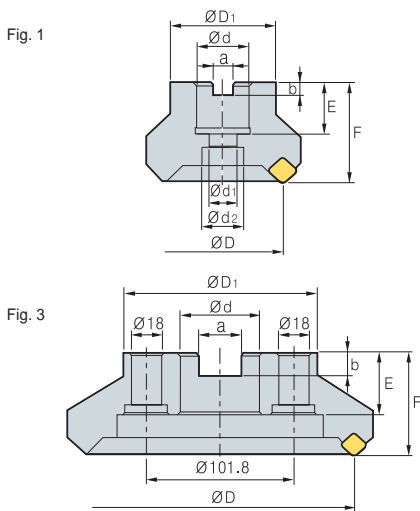


Designation	Dimensions (mm)						Cutter size
	D	L	K	S	h	d	
M8x1.25	20	20	7	6	-	-	Ø40
M10x1.5	28	24	9	8	-	-	Ø50, Ø63
M12x1.75	33	28	10	10	2	23	Ø80
M16x2	40	32	10	14	5	23	Ø100
M20x2.5	50	40	14	17	5	27	Ø125
M24x3	64	46	14	19	9	37	Ø160



**Metric - ISO6462, DIN138**

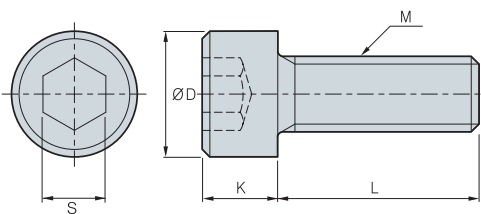
**Clamping part of milling cutter**



**Metric type**

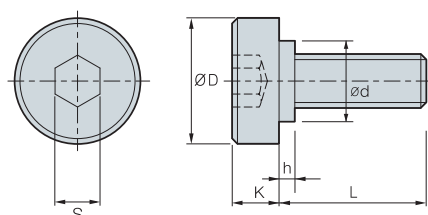
ØD	Dimensions (mm)					Fig.	Available arbors
	Ød	a	b	E	F		
40	16	8.4	5.6	18	40	1	FMC16, SMA16
50	22	10.4	6.3	20	40	1	FMC22
63	22	10.4	6.3	20	40	1	FMC22
80	27	12.4	7	22	50	1	FMC27
100	32	14.4	8	28	50	2	FMC32
125	40	16.4	9	32	63	2	FMB40
160	40	16.4	9	32	63	2	FMB40
200	60	25.7	14	38	63	3	FMB60
250	60	25.7	14	38	63	3	FMB60
315	60	25.7	14	38	63	4	-

**Wrench bolt**



Designation	ØD	S	K	L	M	Cutter size
SB0825	13	6	8	25	M08 x 1.25	Ø40
SB1025	16	8	10	25	M10 x 1.50	Ø50, Ø63
SB1035	16	8	10	35	M10 x 1.50	Ø50, Ø63 (HRM)
SB1230	18	10	12	30	M12 x 1.75	Ø80
SB1245	18	10	12	45	M12 x 1.75	Ø80 (HRM)
SB1630	24	14	16	30	M16 x 2.0	Ø100
SB1645	24	14	16	45	M16 x 2.0	Ø100 (HRM)
SB2040	30	17	20	40	M20 x 2.5	Ø125

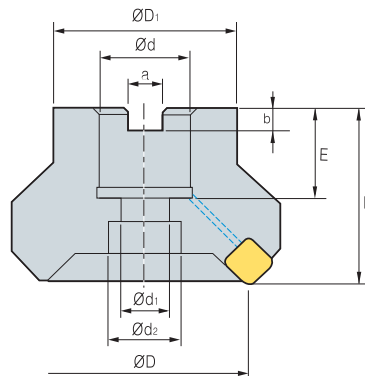
**Clamp bolt**



Designation	Dimensions (mm)						Cutter size
	D	L	K	S	h	d	
M12 x 1.75	33	28	10	10	2	23	Ø80
M16 x 2	40	32	10	14	5	23	Ø100
M20 x 2.5	50	40	14	17	5	27	Ø125, Ø160

## Clamping part of milling cutter (Oil-hole)

### Clamping part of milling cutter



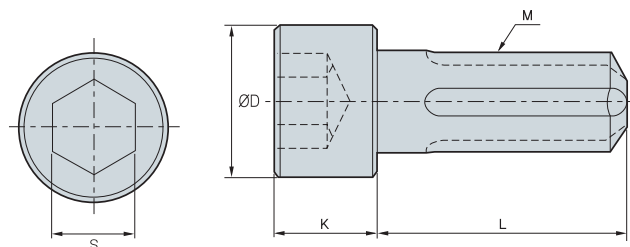
### Inch type

Dimensions (mm)									Available arbors
ØD	Ød	a	b	E	F	ØD1	Ød1	Ød2	
40	16	8.4	5.6	19	40	34	9	14	FMC16, SMA16
50	22	10.4	6.3	21	40	42	11	18	FMC22
63	22	10.4	6.3	21	40	49	11	18	FMC22
80	25.4	9.5	6	24	50	57	14	20	FMA25.4, FMB25.4
100	31.75	12.7	8	32	63	67	18	26	FMA31.75, SMB31.75
125	38.1	15.9	10	35	63	87	22	32	FMA38.1, FMB38.1, FMC38.1

### Metric type

Dimensions (mm)									Available arbors
ØD	Ød	a	b	E	F	ØD1	Ød1	Ød2	
40	16	8.4	5.6	19	40	34	9	14	FMC16, SMA16
50	22	10.4	6.3	21	40	42	11	18	FMC22
63	22	10.4	6.3	21	40	49	11	18	FMC22
80	27	12.4	7.0	23	50	57	14	20	FMC27
100	32	14.4	8.0	25	50	67	18	26	FMC32
125	40	16.4	9.0	29	63	87	22	32	FMB40/FMC40

### Wrench bolt






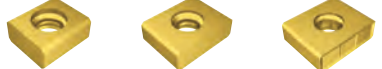


Designation	ØD	S	K	L	M	Cutter size
CB0825	13	6	8	25	M08x1.25	Ø40
CB1025	16	8	10	25	M10x1.50	Ø50, Ø63
CB1035	16	8	10	35	M10x1.50	Ø50, Ø63 (HRM)
CB1230	18	10	12	30	M12x1.75	Ø80
CB1245	18	10	12	45	M12x1.75	Ø80 (HRM)
CB1630	24	14	16	30	M16x2.0	Ø100
CB1645	24	14	16	45	M16x2.0	Ø100 (HRM)
CB2040	30	17	20	40	M20x2.5	Ø125









## Gear cutter applicable example

### ➤ Applicable example-external tooth gear

Finishing: M20	Semi-finishing	Roughing
 <ul style="list-style-type: none"> <li>■ <b>Cutter Dia:</b> Ø400</li> <li>■ <b>Tooth No:</b> 20 tooth</li> <li>■ <b>External tooth gear:</b> Formal cutter for gear processing which can be expected to KS 4 level accuracy</li> <li>■ Cutter can simultaneously chamfer while milling</li> </ul>  <p>M20XZ130-EX</p>	 <ul style="list-style-type: none"> <li>■ <b>Cutter Dia:</b> Ø280</li> <li>■ <b>Tooth No:</b> 48 tooth</li> <li>■ Designed for processing of external gear involute curve line shape</li> <li>■ Possible to work for gear root portion R with optimal insert R design</li> </ul>  <p>M20-M22-ROU</p>	 <ul style="list-style-type: none"> <li>■ <b>Cutter Dia:</b> Ø560</li> <li>■ <b>Tooth No:</b> 140 tooth</li> <li>■ High feed rate with low cutting resistance due to V shape insert setting design</li> </ul>  <p>LNE333-02-1   LNE434-02-1   KEL1906-C0.6-MF</p>

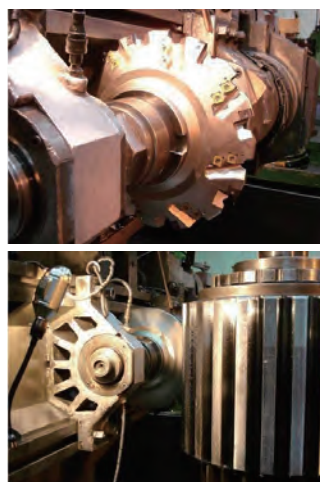
### ➤ Applicable example-internal tooth gear

Finishing: M16	Semi-finishing	Roughing
 <ul style="list-style-type: none"> <li>■ <b>Cutter Dia:</b> Ø400</li> <li>■ <b>Tooth No:</b> 20 tooth</li> <li>■ <b>Internal tooth gear:</b> Formal cutter for gear processing which can be expected to KS 4 level accuracy</li> <li>■ Cutter can simultaneously chamfer while milling</li> </ul>  <p>M16XZ130</p>	 <ul style="list-style-type: none"> <li>■ <b>Cutter Dia:</b> Ø280</li> <li>■ <b>Tooth No:</b> 48 tooth</li> <li>■ The semi-finishing cutter was designed for processing of external gear involute curb line shape</li> </ul>  <p>M16-M18-ROU   LNE433-R60</p>	 <ul style="list-style-type: none"> <li>■ <b>Cutter Dia:</b> Ø560</li> <li>■ <b>Tooth No:</b> 40 tooth</li> <li>■ Possible to use for gear processing of all module due to step type of insert setting design</li> </ul>  <p>KEL1906-C0.6-MF   LNE434-02-1</p>

### ➤ Gear cutter machining example


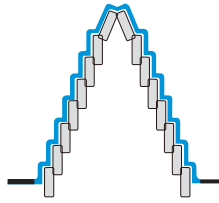

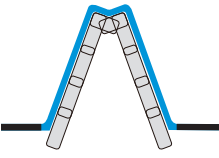

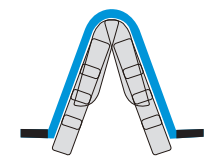

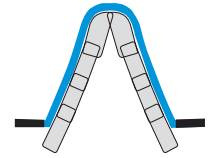

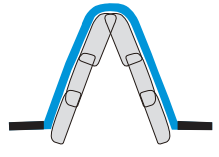

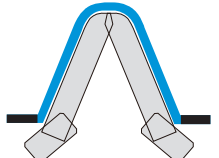

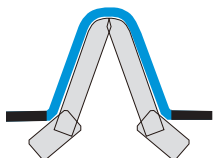

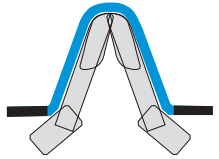


- **Machine**  
Gleason-PFAUTER CNC Hobbing Machine  
(Power: 52kW)
- **Cutting condition**  
vc = 119.98 m/min (n = 86.8 rpm)  
fz = 0.518 mm/t (vf = 450 mm/min)  
ae = 36 mm  
Dry
- **Tools**  
M16-PT-RACK-KOR03 (Ø440xW90)
- **Semi-finishing cutter (low cut, low resistance)**



- **Machine**  
KARATS (30kw)
- **Cutting condition**  
vc = 150 m/min, n = 119 rpm  
fz = 0.09 mm/t, vf = 81.6 mm/min  
ae = 45 mm  
Dry
- **Tools**  
M24 Semi-finishing External type  
Applicable Insert  
M40-ROU (Main),  
KEL150708-MX (Flank)

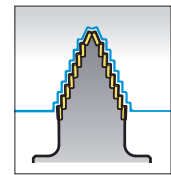
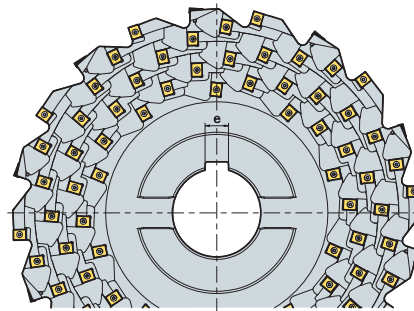
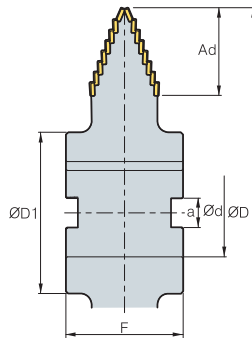
# E Gear Cutter Table

Type	Cutter shape	Cutting-edge shape	Type	Feature
Roughing			Step type	<ul style="list-style-type: none"> <li>• Working for big sized gear tooth</li> <li>• Low cutting resistance with step type insert setting</li> </ul>
			V shape type	<ul style="list-style-type: none"> <li>• Low cutting resistance with V shape cutting insert setting</li> <li>• Optimal cutting-edge line setting according to Rach type &amp; cutting-edge shape</li> </ul>
Semi-finishing			Low cutting resistance type	<ul style="list-style-type: none"> <li>• 4-Corner insert on Root portion</li> <li>• 3D chip breaker shape on flank</li> <li>• Optimal cutting-edge line setting for low cutting resistance</li> </ul>
			External gear high rigidity type	<ul style="list-style-type: none"> <li>• Optimal R type insert setting on Root portion</li> <li>• Superior Semi-finishing cutting with high rigidity shape of cutter &amp; insert</li> </ul>
			Internal gear high rigidity type	<ul style="list-style-type: none"> <li>• Exclusive semi-finishing Internal Gear insert</li> <li>• Optimal cutting-edge line setting with Internal tooth shape</li> </ul>
Finishing			External gear	<ul style="list-style-type: none"> <li>• Concave shape of cutting-edge line according to external gear type</li> <li>• Optimal cutting insert setting design according to a customer conditions</li> </ul>
			Internal gear	<ul style="list-style-type: none"> <li>• 2-corner insert setting on right &amp; left side and chamfering insert setting</li> <li>• Adjustable chamfering cartridge use for chamfering control</li> </ul>
			2 STEP type	<ul style="list-style-type: none"> <li>• Exclusive insert for machining the root part</li> <li>• 4-cornered insert</li> </ul>

• Optimal cutting insert setting design according to customer condition



# Gear Roughing Cutter (Step type)



(mm)

m		ØD	Ad	Ød	ØD <sub>1</sub>	a	e	F
30	96	450	90	100	180	25	14	140
	108	500	90	100	180	25	14	140
	120	560	90	120	220	40	32	160
40	112	450	105	100	180	25	14	140
	126	500	105	100	180	25	14	140
	140	560	105	120	220	40	32	160
50	160	560	119	120	220	40	32	160

## Available inserts

(mm)

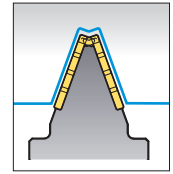
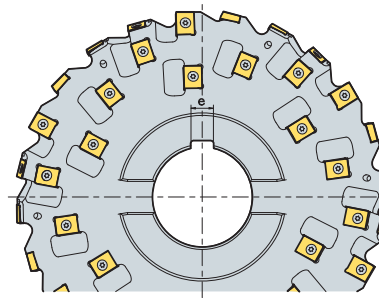
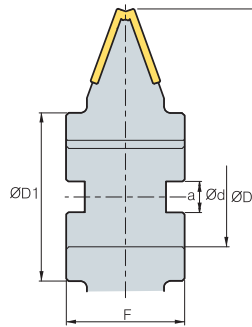
Picture	Designation	Coated				Uncoated		Dimensions					Configuration
		NC5330	PC9530	PC3500	PC5300	H01	G10	l	d	t	d <sub>1</sub>	c	
 Reinforced cutting-edge	LNE 434-02-1			○	◎			19.05	14.29	6.35	5.4	0.6	
	KEL 1906-C0.6-MF 190610-MR			○	◎			19.05	14.29	6.35	5.4	0.6	
 Low cutting resistance				○	◎			19.05	14.29	6.35	5.4	-	

※ The above specification is subject to change according to customer related condition & Korloy technical condition

©: 1<sup>st</sup> Rec ○: 2<sup>nd</sup> Rec



## Gear Roughing Cutter (V shape type)



(mm)

m	Type		ØD	Ød	ØD <sub>1</sub>	a	e	F
20	rack	48	280	80	135	25	18	95
22	rack	48	280	80	135	25	18	95
24	rack	48	320	80	145	25	18	105
26	rack	60	320	80	145	25	18	105
28	rack	96	400	100	180	25	24	130
30	rack	96	400	100	180	25	24	130
32	rack	96	400	100	180	25	24	130
34	rack	112	400	100	180	25	24	130
36	rack	112	450	100	180	25	24	130
38	rack	112	450	100	180	25	24	130
40	rack	128	450	100	180	25	24	160
42	rack	128	450	100	180	25	24	160
44	rack	128	560	120	220	32	32	160
46	rack	144	560	120	220	32	32	160
48	rack	144	560	120	220	32	32	160
50	rack	144	560	120	220	32	32	160

### Available inserts

(mm)

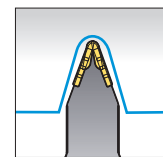
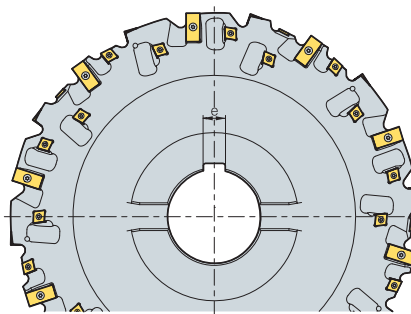
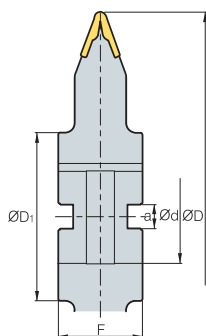
Picture	Designation	Coated				Uncoated		Dimensions					Configuration
		NC5330	PC9530	PC3500	PC5300	H01	G10	l	d	t	d <sub>t</sub>	c	
 Reinforced cutting-edge	LNE 434-02-1			○	◎			19.05	14.29	6.35	5.4	0.6	
 Low cutting resistance	LNE 1906-C0.6-MF 190610-MR			○	◎			19.05	14.29	6.35	5.4	0.6	
 Reinforced cutting-edge	KEL 333-02-1			○	◎			14.3	12.7	6.35	5.8	0.8	
 CNHQ	1005-C0.5							10	10	5.4	-	-	

\* The above specification is subject to change according to customer related condition & Korloy technical condition

◎: 1<sup>st</sup> Rec ○: 2<sup>nd</sup> Rec



# Gear Semi-finishing Cutter (Low cutting resistance type)



(mm)

m	No. of teeth		ØD	Ød	ØD <sub>1</sub>	a	e	F
6	30, 60, 120	18	250	60	100	25	18	70
8	30, 60, 120	18	250	60	100	25	18	80
10	30, 60, 120	24	250	60	100	25	18	80
12	30, 60, 120	24	250	60	100	25	18	90
14	30, 60, 120	24	280	80	135	25	24	95
16	30, 60, 120	32	280	80	135	25	24	100
18	30, 60, 120	32	320	80	145	25	24	105
20	30, 60, 120	64	400	100	180	25	24	110
22	30, 60, 120	64	400	100	180	25	24	110
24	30, 60, 120	64	400	100	180	25	24	120

## Available inserts

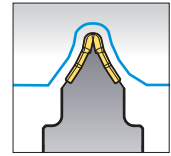
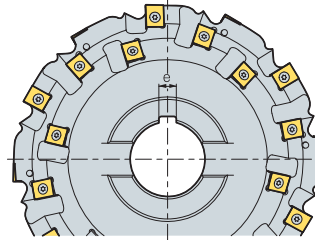
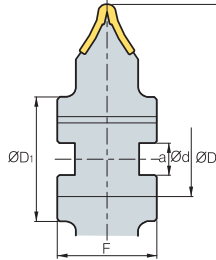
(mm)

Picture	Designation	Coated				Uncoated		Dimensions					Configuration
		NC5330	PC9530	PC3500	PC5300	H01	G10	l	d	t	d <sub>t</sub>	c	
	M6-2ST			○	◎			19.05	11.6	3.8	4.4	2.25	
	M8-2ST			○	◎			19.05	11.6	4	4.4	3	
	M10-2ST			○	◎			19.05	11.6	4.76	4.4	3.75	
	M12-2ST			○	◎			19.05	14.3	6.35	5.5	4.5	
	M14-2ST			○	◎			25.4	14.3	6.35	5.5	5.25	
	M16-2ST			○	◎			31.8	14.3	7.14	5.5	6	
	M18-2ST			○	◎			31.8	14.3	7.14	5.5	6.75	
	M20-2ST			○	◎			31.8	14.3	9.52	5.5	7.5	
	M22-2ST			○	◎			31.8	14.3	9.52	5.5	8.25	
M24-2ST			○	◎			31.8	14.3	9.52	5.5	9		
	KEC 120606-MX			○	◎			12	12.7	6.35	4.5	-	
	150708-MX			○	◎			15.15	15	7.6	5.8	-	

※ The above specification is subject to change according to customer related condition & Korloy technical condition

◎: 1<sup>st</sup> Rec ○: 2<sup>nd</sup> Rec

## Gear Semi-finishing Cutter (High rigid edge type, External gear)



(mm)

m	No. of teeth		$\varnothing D$	$\varnothing d$	$\varnothing D_1$	a	e	F
12	30, 60, 120	24	250	60	100	25	14	70
14	30, 60, 120	36	250	60	100	25	14	80
16	30, 60, 120	36	250	60	100	25	14	80
18	30, 60, 120	36	250	60	100	25	14	90
20	30, 60, 120	48	280	80	135	25	18	95
22	30, 60, 120	48	280	80	135	25	18	100
24	30, 60, 120	48	320	80	145	25	18	105
26	30, 60, 120	72	400	100	180	25	24	110
28	30, 60, 120	72	400	100	180	25	24	110
30	30, 60, 120	72	400	100	180	25	24	120
32	30, 60, 120	84	400	100	180	25	24	130
34	30, 60, 120	84	400	100	180	25	24	130

### Available inserts

(mm)

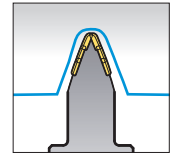
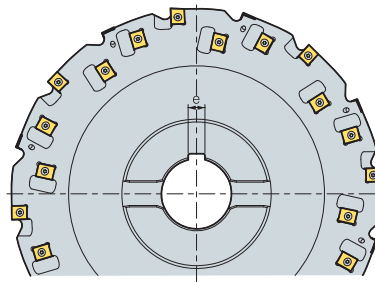
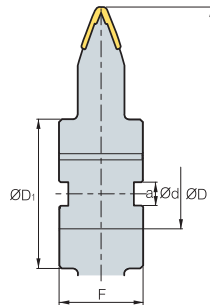
Picture	Designation	Coated				Uncoated		Dimensions						Configuration
		NC5330	PC9530	PC3500	PC5300	H01	G10	l	d	t	$d_1$	R	c	
	M8-ROU			○	◎			15.875	11	4.76	4.6	4.6	-	
	M12-M14-ROU			○	◎			19.05	14.29	6.35	5.4	5.4	-	
	M16-M18-ROU			○	◎			19.05	14.29	7	5.4	5.4	-	
	M20-M22-ROU			○	◎			19.05	14.29	7.94	5.4	5.4	-	
	M40-ROU			○	◎			25.4	14.29	9.52	5.4	5.4	-	
	LNE 434-02-1			○	◎			19.05	14.29	6.35	5.4	-	0.6	
	KEL 1906-C0.6-MF			○	◎			19.05	14.29	6.35	5.4	-	0.6	
	190610-MR			○	◎			19.05	14.29	6.35	5.4	-	-	

※ The above specification is subject to change according to customer related condition & Korloy technical condition

©: 1<sup>st</sup> Rec ○: 2<sup>nd</sup> Rec



# Gear Semi-finishing Cutter (High rigid edge type, Internal gear)



(mm)

m	No. of teeth		ØD	Ød	ØD <sub>1</sub>	a	e	F
12	30, 60, 120	24	250	60	100	25	14	70
14	30, 60, 120	36	250	60	100	25	14	80
16	30, 60, 120	36	250	60	100	25	14	80
18	30, 60, 120	36	250	60	100	25	14	90
20	30, 60, 120	48	280	80	135	25	18	95
22	30, 60, 120	48	280	80	135	25	18	100
24	30, 60, 120	48	320	80	145	25	18	105
26	30, 60, 120	72	400	100	180	25	24	110
28	30, 60, 120	72	400	100	180	25	24	110
30	30, 60, 120	72	400	100	180	25	24	120
32	30, 60, 120	84	400	100	180	25	24	130
34	30, 60, 120	84	400	100	180	25	24	130

## Available inserts

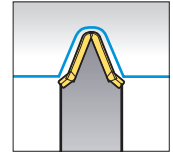
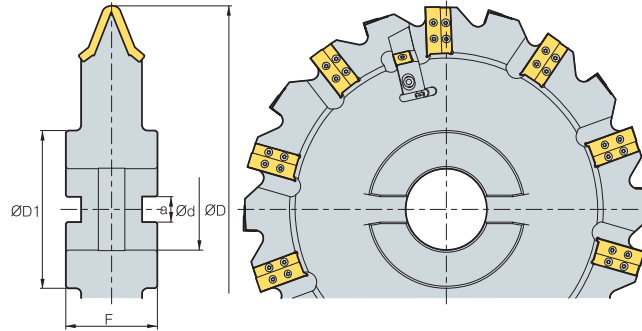
(mm)

Picture	Designation	Coated				Uncoated		Dimensions					Configuration
		NC5330	PC9530	PC3500	PC5300	H01	G10	l	d	t	d <sub>1</sub>	c	
	M8-ROU			○	◎			15.875	11	4.76	4.6	2	
	M12-M14-ROU			○	◎			19.05	14.29	6.35	5.4	3	
	M16-M18-ROU			○	◎			19.05	14.29	7	5.4	5	
	M20-M22-ROU			○	◎			19.05	14.29	7.94	5.4	7	
	M40-ROU			○	◎			25.4	14.29	9.52	5.4	10	
	LNE 433-R80			○	◎			19.05	14.29	5.56	5.4	2.5	


\* The above specification is subject to change according to customer related condition & Korloy technical condition

○: 1<sup>st</sup> Rec ○: 2<sup>nd</sup> Rec

## Gear Finishing Cutter (1 Step type, External gear)


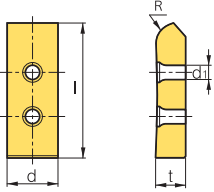
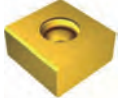
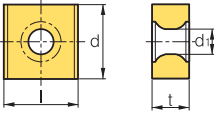


(mm)

m		$\varnothing D$	$\varnothing d$	$\varnothing D_1$	a	F
6	20	400	80	155	25	90
8	20	400	80	155	25	90
10	20	400	80	155	25	90
12	20	400	80	155	25	90
14	20	400	80	155	25	90
16	20	400	80	155	25	90
18	20	400	80	155	25	90
20	20	400	80	155	25	90
22	20	400	80	155	25	90
24	20	400	80	155	25	90

### Available inserts

(mm)

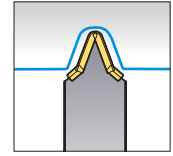
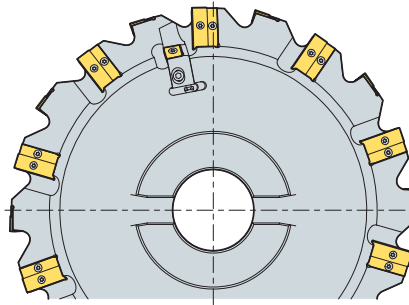
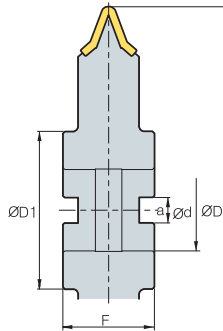
Picture	Designation	Coated				Uncoated		Dimensions					Configuration
		NC5330	PC9530	PC3500	PC5300	H01	G10	l	d	t	d <sub>1</sub>	R	
	M6			○	◎			19	14.3	5	5.5	2.25	
	M8			○	◎			27	14.3	5.4	5.5	3	
	M10			○	◎			29	14.3	6.35	5.5	3.75	
	M12			○	◎			33	14.3	6.35	5.5	4.5	
	M14			○	◎			39	14.3	6.35	5.5	5.25	
	M16			○	◎			43	14.3	7.94	5.5	6	
	M18			○	◎			50	14.3	7.94	5.5	6.75	
	M20			○	◎			54	14.3	9.53	5.5	7.5	
	M22			○	◎			57	14.3	9.53	5.5	8.25	
M24			○	◎			64	14.3	9.53	5.5	9		
	SNEQ 1507-C0.8			○	◎			15.875	15.875	7.94	-	-	

※ The above specification is subject to change according to customer related condition & Korloy technical condition

◎: 1<sup>st</sup> Rec ○: 2<sup>nd</sup> Rec



# Gear Finishing Cutter (1 Step type, Internal gear)



(mm)

m		ØD	Ød	ØD <sub>1</sub>	a	F
6	20	400	80	155	25	90
8	20	400	80	155	25	90
10	20	400	80	155	25	90
12	20	400	80	155	25	90
14	20	400	80	155	25	90
16	20	400	80	155	25	90
18	20	400	80	155	25	90
20	20	400	80	155	25	90
22	20	400	80	155	25	90
24	20	400	80	155	25	90

## Available inserts

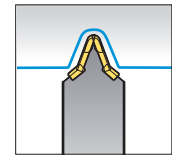
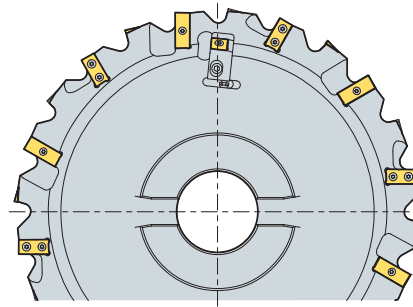
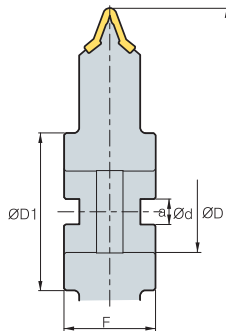
(mm)

Picture	Designation	Coated				Uncoated		Dimensions					Configuration
		NC5330	PC9530	PC3500	PC5300	H01	G10	l	d	t	d <sub>1</sub>	R	
	M6			○	◎			19	14.3	5	5.5	2.25	
	M8			○	◎			27	14.3	5.4	5.5	3	
	M10			○	◎			29	14.3	6.35	5.5	3.75	
	M12			○	◎			33	14.3	6.35	5.5	4.5	
	M14			○	◎			39	14.3	6.35	5.5	5.25	
	M16			○	◎			43	14.3	7.94	5.5	6	
	M18			○	◎			50	14.3	7.94	5.5	6.75	
	M20			○	◎			54	14.3	9.53	5.5	7.5	
	M22			○	◎			57	14.3	9.53	5.5	8.25	
	M24			○	◎			64	14.3	9.53	5.5	9	
	SNEQ 1507-C0.8			○	◎			15.875	15.875	7.94	-	-	

\* The above specification is subject to change according to customer related condition & Korloy technical condition

◎: 1<sup>st</sup> Rec ○: 2<sup>nd</sup> Rec

## Gear Finishing Cutter (2 Step type, Internal/External gear)



(mm)

m		ØD	Ød	ØD <sub>1</sub>	a	F
6	24	400	80	155	25	90
8	24	400	80	155	25	90
10	24	400	80	155	25	90
12	24	400	80	155	25	90
14	24	400	80	155	25	90
16	24	400	80	155	25	90
18	24	400	80	155	25	90
20	24	400	80	155	25	90
22	24	400	80	155	25	90
24	24	400	80	155	25	90

### Available inserts

(mm)

Picture	Designation	Coated				Uncoated		Dimensions					Configuration
		NC5330	PC9530	PC3500	PC5300	H01	G10	l	d	t	d <sub>1</sub>	R	
	M6		○		◎			19	14.3	5	5.5	2.25	
	M8		○		◎			27	14.3	5.4	5.5	3	
	M10		○		◎			29	14.3	6.35	5.5	3.75	
	M12		○		◎			33	14.3	6.35	5.5	4.5	
	M14		○		◎			39	14.3	6.35	5.5	5.25	
	M16		○		◎			43	14.3	7.94	5.5	6	
	M18		○		◎			50	14.3	7.94	5.5	6.75	
	M20		○		◎			54	14.3	9.53	5.5	7.5	
	M22		○		◎			57	14.3	9.53	5.5	8.25	
	SNEQ 1507-C0.8		○		◎			15.875	15.875	7.94	-	-	
	M6-2ST							19.05	11.6	3.8	4.4	2.25	
	M8-2ST							19.05	11.6	4	4.4	3	
	M10-2ST							19.05	11.6	4.76	4.4	3.75	
	M12-2ST							19.05	14.3	6.35	5.5	4.5	
	M14-2ST							25.4	14.3	6.35	5.5	5.25	
	M16-2ST							31.8	14.3	7.14	5.5	6	
	M18-2ST							31.8	14.3	7.14	5.5	6.75	
	M20-2ST							31.8	14.3	9.52	5.5	7.5	
	M22-2ST							31.8	14.3	9.52	5.5	8.25	
M24-2ST							31.8	14.3	9.52	5.5	9		

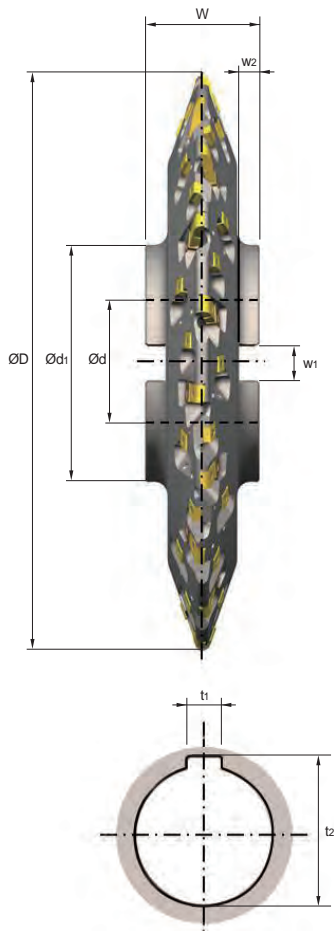
※ The above specification is subject to change according to customer related condition & Korloy technical condition

◎: 1<sup>st</sup> Rec ○: 2<sup>nd</sup> Rec





**➤ Gear cutter order form**



**Cutter type**

- |  |   |   |
|--|---|---|
| <input type="checkbox"/> <b>Roughing</b> | <input type="checkbox"/> <b>Semi-finishing</b>  | <input type="checkbox"/> <b>Finishing</b> |
| <input type="checkbox"/> Step            | <input type="checkbox"/> Low cutting resistance | <input type="checkbox"/> 1 Step           |
| <input type="checkbox"/> V shape         | <input type="checkbox"/> High rigid edge        | <input type="checkbox"/> 2 Step           |

■ Stock for finishing (one side) (mm):

■ Outside diameter  $\varnothing D$  (mm):

■ Bore diameter  $\varnothing d$  (mm):

■ Hub diameter  $\varnothing d_1$  (mm):

■ Cutter width  $W$  (mm):

■ Radial keyway  $w_1$  (mm):

■ Radial keyway  $w_2$  (mm):

■ Axial keyway  $t_1$  (mm):

■ Axial keyway  $t_2$  (mm):

**➤ Involute gear data**

- |   |   |   |
|---|---|---|
| <input type="checkbox"/> <b>External gear</b> | <input type="checkbox"/> <b>Internal gear</b> | <input type="checkbox"/> <b>Rack gear</b> |
|---|---|---|

■ Module  $M$ :

■ No. of teeth  $Z$  (mm):

■ Pressure angle  $\alpha$  (°):

■ Helix angle  $\beta$  (°):

■ Addendum modification coefficient  $x$ :

■ Tip diameter  $d_a$  (mm):

■ Root diameter  $d_f$  (mm):

■ Root radius  $\rho_p$  (mm)

■ Base tangent length  $W_k$  (mm)

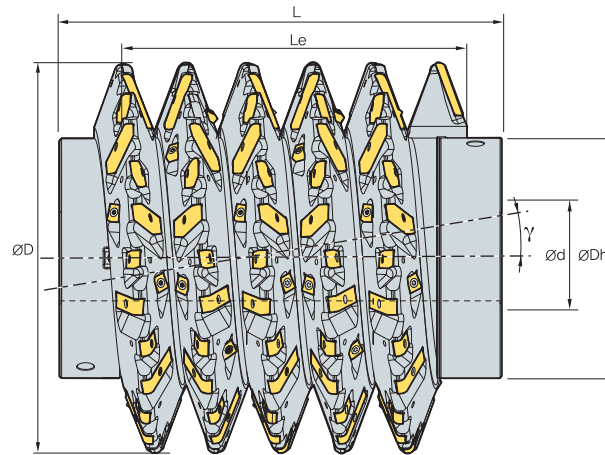
■ No. of measuring teeth  $K$ :

■ Dimensions/Dimension over balls  $M_d$  (mm):

■ Ball diameter  $D_M$  (mm):

■ Gear quality (DIN, JIS):

# Indexable HOB

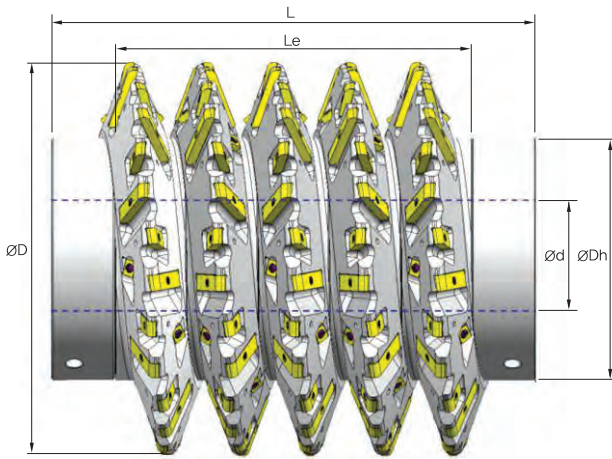


(mm)

Gear module	$\varnothing D$	$\varnothing D_h$	$\varnothing d$	No.Segm. (Pitch)	$L_e$	Segment insert	Total insert	$\gamma$ (Lead Ang.)
6	180	125	40	6	(113)	15	90	2.084
	210	125	50	6	(113)	17	102	1.763
	240	160	60	6	(113)	19	114	1.528
7	180	125	40	6	(132)	15	90	2.469
	210	125	50	6	(132)	17	102	2.084
	240	160	60	6	(132)	19	114	1.803
8	210	125	50	6	(151)	17	102	2.413
	240	160	60	6	(151)	19	114	2.084
	270	180	80	6	(151)	21	126	1.834
9	210	125	50	6	(169)	17	102	2.751
	240	160	60	6	(169)	19	114	2.372
	270	180	80	6	(169)	21	126	2.084
10	210	125	50	6	(189)	17	102	3.099
	240	160	60	6	(189)	19	114	2.666
	270	180	80	6	(189)	21	126	2.339
12	240	140	60	6	(226)	18	108	3.276
	270	180	80	6	(226)	22	132	2.866
	350	215	80	6	(226)	26	156	2.149
14	270	180	80	6	(264)	22	132	3.415
	350	215	80	6	(264)	26	156	2.547
16	270	160	80	6	(302)	22	132	3.989
	350	215	80	6	(302)	26	156	2.959
18	270	145	80	5	(283)	22	110	4.589
	350	215	80	5	(283)	26	130	3.383
20	350	215	80	5	(314)	26	130	3.823
	450	265	100	5	(314)	34	170	2.866



## Indexable HOB



### Tool SPEC.

■ Outside diameter  $\text{ØD}$  (mm):

■ Bore diameter  $\text{Ød}$  (mm):

■ Hub diameter  $\text{ØDh}$  (mm):

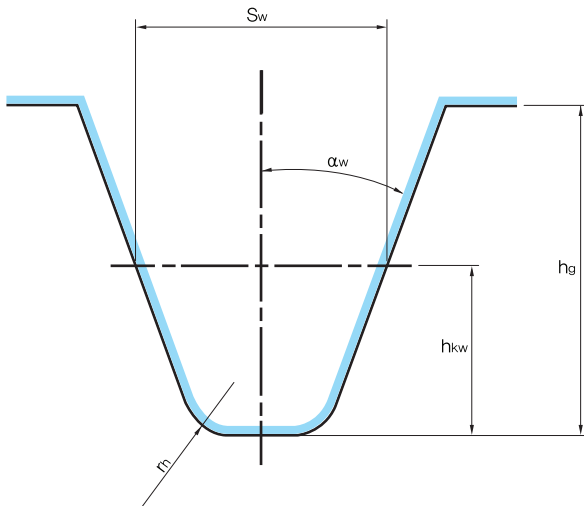
■ Hob length  $L$  (mm):

■ Cutting length  $L_e$  (mm):

■ Spiral direction RH/LH:

■ Quality class acc. to DIN 3968:

### Profile of hob [Module m6~]



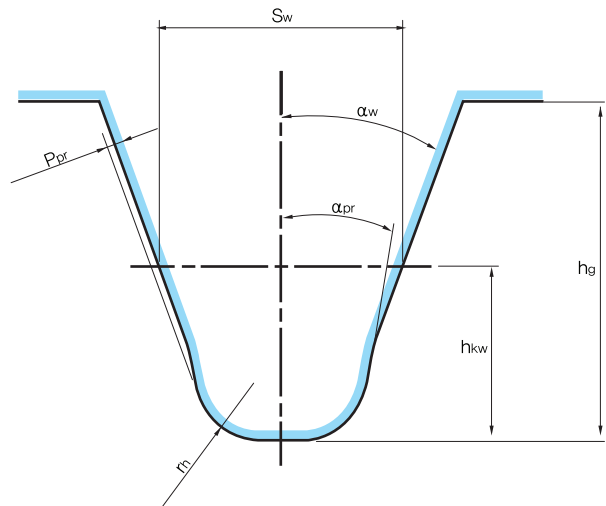
■ Module  $M$ :

■ Addendum  $h_{kw}$  (mm):

■ Tooth thickness  $S_w$  (mm):

■ Tooth depth  $h_g$  (mm):

### Profile of roughing hob [Module m8~]



■ Pressure angle  $\alpha_w$  (mm):

■ Protuberance amount  $P_{pr}$  (mm):

■ Protuberance angle  $\alpha_{pr}$  (mm):

■ Tip radius  $r_h$  (mm):



# DRILL

Korloy drills provide a total solution for hole making, based on tooling know-how as well as extensive research and development for our tools.



# F



**Technical Information for Drills**

- F02** KORLOY Drills
- F03** Available Insert

**Indexable Drills**

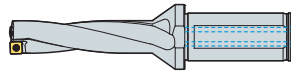
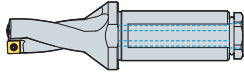
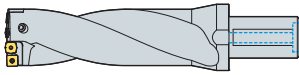
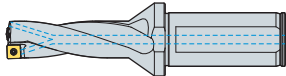
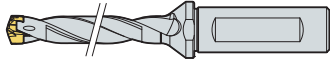
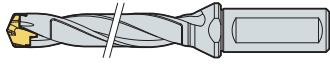
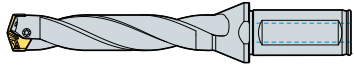
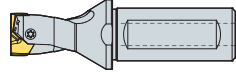
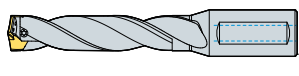
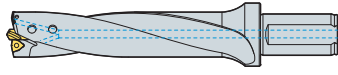


- F05** Technical Information for King Drill
- F11** King Drill
- F20** Technical information of King Drill (for through coolant system with a lathe)
- F21** King Drill (for through coolant system with a lathe)
- F24** Technical Information for King Drill (for large diameter drilling)
- F25** King Drill (for large diameter drilling)
- F26** Technical Information for KED Plus Drill
- F29** KED Plus Drill
- F37** Technical Information for TPDC Plus Drill
- F47** TPDC Plus Drill
- F54** Technical Information for TPDB Plus Drill
- F57** TPDB Plus Drill
- F63** Technical Information for TPDB-F
- F66** TPDB-F
- F68** Technical Information for TPDB-H
- F71** TPDB-H

**Indexable Drills**

- F75** Technical Information for WPDC
- F78** Center Drill
- F79** WPDC


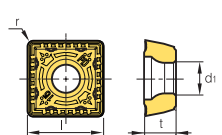

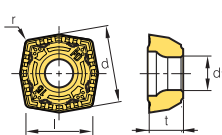

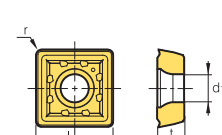

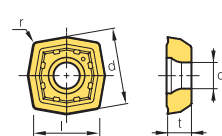

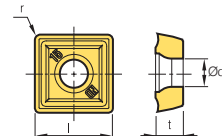
**Reamer**

- F82** Technical Information for Indexable Reamer
- F86** Indexable Reamer

Type	Designation		Shape	Drills dia.	Aspect ratio	Page
Indexable Drills	King Drill	K□D	 Available insert: SP□T, XO□T	Ø12.0~Ø60.5	2D~5D	F11~F19
	King Drill HP	K□D..HP	 Available insert: SP□T, XO□T	Ø12.0~Ø60.5	2D~4D	F21~F23
	King Drill (for large diameter drilling)	K□D	 Available insert: SP□T, XO□T	Ø61.0~Ø100.0	2D~4D	F25
	KED Plus Drill <small>new</small>	E□D	 Available insert: SP□T, XO□T	Ø12.0~Ø60.5	2D~5D	F29~F36
	TPDC Plus Drill <small>new</small>	TPDX	 Available insert: TP□□□□XP	Ø8.0~Ø11.9	3D~8D	F50
		TPDC	 Available insert: TP□□□□C□	Ø12.0~Ø30.9	1.5D~12D	F5~F53
	TPDB Plus Drill <small>new</small>	TPDB-P	 Available insert: TP□□□□B	Ø10.0~Ø32.9	3D~12D	F58~F62
		TPDB-F	 Available insert: TP□□□□B-F	Ø14.0~Ø30.9	1.5D	F67
		TPDB-H	 Available insert: TP□□□□B-H	Ø14.0~Ø30.9	3D~8D	F72~F74
	Indexable Drills & Drill with center	WPDC	 Available insert: WC□T	Ø25.0~Ø80.0	5D~8D	F79~F81
Reamer	Indexable Reamer	IRT	 Available Insert: RI	Ø10.0~Ø31.0	3D~5D	F86
		IRB	 Available Insert: RI	Ø10.0~Ø31.0	3D~5D	F87



**Available insert**


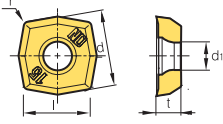

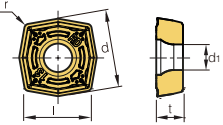

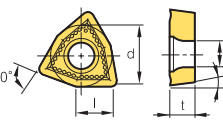
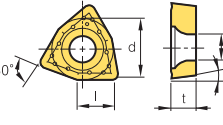
Picture	Designation	Coated								Uncoated	Dimensions (mm)					Configuration	Page
		NC5330	NCM535	PC3700	PC6510	PC9530	PC9540	PC5335	PC5300	H01	l	d	t	r	d <sub>t</sub>		
 [ Peripheral ] SPMT-PD Universal	040204-PD	●	●	●	●		●	●		4.7	-	2.4	0.4	2.3		F11~ F36	
	050204-PD	●	●	●	●		●	●		5.1	-	2.4	0.4	2.3			
	060205-PD	●	●	●	●		●	●		6.2	-	2.5	0.5	2.5			
	07T208-PD	●	●	●	●		●	●		7.5	-	2.8	0.7	2.8			
	090308-PD	●	●	●	●		●	●		9.2	-	3.3	0.8	3.4			
	11T308-PD	●	●	●	●		●	●		11.0	-	4.0	0.8	4.0			
	130410-PD	●	●	●	●		●	●		13.0	-	4.5	1.0	4.5			
	15M510-PD	●	●	●	●		●	●		15.2	-	5.0	1.0	5.5			
	180510-PD	●	●	●	●		●	●		18.2	-	5.5	1.0	6.0			
 [ Central ] XOMT-PD Universal	040204-PD						●	●		4.3	4.9	2.4	0.4	2.3		F11~ F36	
	050204-PD						●	●		4.8	5.4	2.4	0.4	2.3			
	060204-PD						●	●		5.8	6.6	2.5	0.4	2.5			
	07T205-PD						●	●		6.9	7.8	2.8	0.5	2.8			
	090305-PD						●	●		8.4	9.6	3.3	0.5	3.4			
	11T306-PD						●	●		10.0	11.4	4.0	0.6	4.0			
	130406-PD						●	●		11.9	13.6	4.5	0.6	4.5			
	15M508-PD						●	●		13.9	15.9	5.0	0.8	5.5			
	180508-PD						●	●		16.5	18.9	5.5	0.8	6.0			
 [ Peripheral ] SPMT-LD Mild steel	060205-LD							●		6.2	-	2.5	0.5	2.5		F11~ F36	
	07T208-LD							●		7.5	-	2.8	0.7	2.8			
	090308-LD							●		9.2	-	3.3	0.8	3.4			
	11T308-LD							●		11.0	-	4.0	0.8	4.0			
	130410-LD							●		13.0	-	4.5	1.0	4.5			
	15M510-LD							●		15.2	-	5.0	1.0	5.5			
	180510-LD							●		18.2	-	5.5	1.0	6.0			
 [ Central ] XOMT-LD Mild steel	060204-LD							●		5.8	6.6	2.5	0.4	2.5		F11~ F36	
	07T205-LD							●		6.9	7.8	2.8	0.5	2.8			
	090305-LD							●		8.4	9.6	3.3	0.5	3.4			
	11T306-LD							●		10.0	11.4	4.0	0.6	4.0			
	130406-LD							●		11.9	13.6	4.5	0.6	4.5			
	15M508-LD							●		13.9	15.9	5.0	0.8	5.5			
	180508-LD							●		16.5	18.9	5.5	0.8	6.0			
 [ Peripheral ] SPET-ND Al	040204-ND								●	4.7	-	2.4	0.4	2.3		F11~ F36	
	050204-ND								●	5.1	-	2.4	0.4	2.3			
	060205-ND								●	6.2	-	2.5	0.5	2.5			
	07T208-ND								●	7.5	-	2.8	0.7	2.8			
	090308-ND								●	9.2	-	3.3	0.8	3.4			
	11T308-ND								●	11.0	-	4.0	0.8	4.0			
	130410-ND								●	13.0	-	4.5	1.0	4.5			
	15M510-ND								●	15.2	-	5.0	1.0	5.5			
	180510-ND								●	18.2	-	5.5	1.0	6.0			

● : Stock Item



# F Available Insert

## Available insert

Picture	Designation	Coated							Uncoated	Dimensions (mm)					Configuration	Page
		NC5330	NCM535	PC3700	PC6510	PC9530	PC9540	PC5335		PC5300	H01	l	d	t		
 AI	[ Central ]								●	4.3	4.9	2.4	0.4	2.3		F11~ F36
									●	4.8	5.4	2.4	0.4	2.3		
									●	5.8	6.6	2.5	0.4	2.5		
									●	6.9	7.8	2.8	0.5	2.8		
									●	8.4	9.6	3.3	0.5	3.4		
									●	10.0	11.4	4.0	0.6	4.0		
									●	11.9	13.6	4.5	0.6	4.5		
									●	13.9	15.9	5.0	0.8	5.5		
									●	16.5	18.9	5.5	0.8	6.0		
 Rein forced cutting-edge	[ Central ]								●	6.9	7.8	2.8	0.7	2.8		F11~ F36
									●	8.4	9.6	3.3	0.8	3.4		
									●	10.0	11.4	4.0	0.9	4.0		
									●	11.9	13.6	4.5	1.0	4.5		
									●	13.9	15.9	5.0	1.1	5.5		
									●	16.5	18.9	5.5	1.2	6.0		
									●							
									●	3.8	5.56	2.38	0.8	2.8		-
									●	4.3	6.35	2.38	0.8	3.0		
			●						●	5.4	7.94	3.18	0.8	3.4		
			●						●	6.5	9.525	3.97	0.8	3.7		
									●	8.7	12.7	4.76	0.8	4.3		
			●						●	8.7	12.7	4.76	1.2	4.3		
									●							
									●	3.8	5.56	2.38	0.4	2.55		F79~ F81
									●	4.3	6.35	2.38	0.4	2.8		
									●	4.3	6.35	2.38	0.8	2.8		
									●	5.4	7.94	3.18	0.8	3.4		
									●	6.5	9.525	3.97	0.8	4.4		
									●	8.7	12.7	4.76	0.8	5.5		
									●							

●: Stock Item



F

Drills

Optimized insert design for maximum drilling efficiency

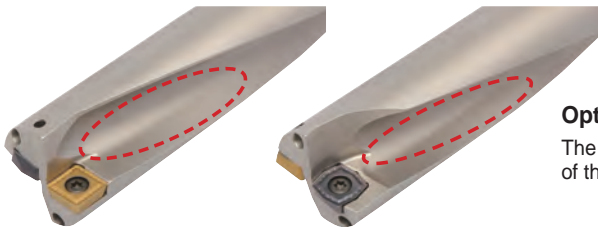
## King Drill

### Code system

K	5D	200	25	□	-	07
<b>KING/KORLOY</b>	<b>Aspect ratio (L/D)</b> 2D, 3D, 4D, 5D	<b>Drill Dia.</b> Ø20.0 mm (One decimal place marked)	<b>Shank Dia</b> Ø20 Ø25 Ø32 Ø40 mm	<b>Shank shape</b> No mark: Flange Shank, Weldone HP: Flange Shank, Weldon, PT Tap F1: Flange Shank, Whistle Notch F2: Flange Shank, Without Side Lock S: Straight Shank, Weldone S1: Straight Shank, Whistle Notch S2: Straight Shank, Without Side Lock M0, M1, M2, M3... : MT0, MT1, MT2, MT3... H63, H100: HSK63, HSK100 B30, B40, B50: BT30, BT40, BT50		<b>Inscribed circle of insert</b> 04, 05, 06, 07, 09, 11, 13, 15, 18

### Features

- Optimized design of inserts for maximum drilling efficiency
- Excellent cutting performance and chip control due to the optimized geometry and chip breaker of both inserts, central & peripheral
- Different inserts, optimized for the central and peripheral insert locations in order to maximize cutting tool life



#### Optimized flute system - 2 coolant holes applied

The optimized shape of the flute increases the rigidity of the drill body and improves chip evacuation

### Features of chip breaker

Chip breaker	PD		LD		ND		RD
<b>Features</b>	- Universal - At medium speed and medium feed		- Superior chip control for machining mild steel and stainless steel - Light cutting (at low-medium speed and low feed)		- Sharp cutting edge for aluminum machining - Insert surface buffed for high quality result - E Class tolerance		- Improved chipping resistance - Excellent performance in case of frequent fracture and chipping on the cutting edge
<b>Insert</b>	Peripheral insert	Central insert	Peripheral insert	Central insert	Peripheral insert	Central insert	Central insert
<b>Shape</b>							
<b>Grades for workpiece</b>	NC5330: P, M, K PC3700: P PC5300: P, M, K, S PC6510: K PC9540: P, M, S		PC5335: P, M		H01: N		PC5300: P, M, K, S

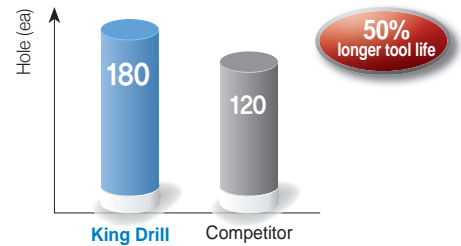
# F Technical Information for King Drill

## Application examples

- **Use** Track link bush
- **Workpiece** SM45C
- **Cutting conditions** vc (m/min) = 120, fn (mm/rev) = 0.1  
Through coolant system
- **Tools** **Inserts** SPMT07T208-PD (PC3700)  
XOMT07T205-PD (PC5300)  
**Holder** K5D20025-07
- **Machine** Drilling machine



### Test result

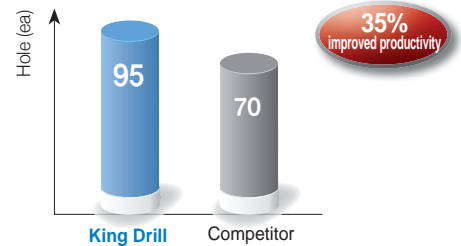


- Superior surface finish and chip evacuation

- **Use** Track link bush
- **Workpiece** SCM415H
- **Cutting conditions** Competitor: vc (m/min) = 125, fn (mm/rev) = 0.1  
King Drill: vc (m/min) = 140, fn (mm/rev) = 0.12
- **Tools** **Inserts** SPMT090308-PD (PC3700)  
XOMT090305-PD (PC5300)  
**Holder** K3D27032-09
- **Machine** MCT



### Test result



- Increased productivity due to higher capabilities for cutting conditions compared to the competitor

## Recommended cutting condition

Workpiece			Insert			vc (m/min)	Aspect ratio (L/D) = 2D, 3D, 4D						
ISO	Workpiece	Hardness (HB)	Chip breaker	Grade			Feed rate (mm/rev) per drill dia. (mm)						
				Central	Peripheral		Ø12-Ø16	Ø17-Ø23	Ø24-Ø29	Ø30-Ø42	Ø43-Ø60	Ø61-Ø100	
P	Carbon steel	80~180	LD	PC5335	PC5335	120 (60~170)							
			PD/RD	PC5300	PC3700	150 (120~180)	0.04~0.08	0.04~0.08	0.04~0.08	0.04~0.08	0.04~0.08	0.04~0.08	
					NC5330	180 (140~220)							
	High carbon steel	180~280	PD	PC5300	PC3700	120 (90~150)	0.04~0.10	0.04~0.12	0.05~0.16	0.06~0.16	0.06~0.18	0.06~0.18	
					NC5330	150 (110~190)	0.04~0.06	0.04~0.07	0.04~0.08	0.04~0.08	0.04~0.08	0.04~0.08	
						180 (140~210)	0.06~0.08	0.06~0.08	0.06~0.10	0.06~0.12	0.06~0.12	0.06~0.12	
Alloy steel	Low alloy steel	140~260	LD	PC5335	PC5335	120 (60~160)	0.06~0.10	0.06~0.10	0.06~0.12	0.06~0.14	0.06~0.14	0.06~0.14	
			PD	PC5300	PC3700	150 (120~170)	0.06~0.12	0.06~0.12	0.06~0.14	0.06~0.16	0.06~0.16	0.06~0.16	
	NC5330	180 (140~210)			0.06~0.08	0.06~0.08	0.06~0.10	0.06~0.12	0.06~0.12	0.06~0.12			
	Low alloy heat-treated steel	200~400	PD	PC5300	PC5300	100 (50~150)	0.04~0.10	0.06~0.10	0.06~0.12	0.06~0.14	0.06~0.14		
High alloy steel	260~320	PD	PC5300	PC3700	100 (50~160)	0.05~0.11	0.05~0.11	0.05~0.13	0.05~0.15	0.05~0.15			
High alloy heat-treated steel	300~450	PD	PC5300	PC5300	70 (30~120)	0.04~0.08	0.06~0.08	0.06~0.10	0.06~0.12	0.06~0.12			
M	Stainless steel	135-275	LD	PC5335	PC5335	120 (80~140)	0.04~0.07	0.04~0.07	0.04~0.07	0.04~0.08	0.04~0.08	0.04~0.08	
			PD	PC5300	PC5300	130 (100~160)	0.04~0.07	0.04~0.07	0.04~0.07	0.04~0.08	0.04~0.08	0.04~0.08	
					PC9540	PC9540	90 (60~120)	0.04~0.07	0.04~0.07	0.04~0.07	0.04~0.08	0.04~0.08	0.04~0.08
K	Cast iron	150~230	PD	PC5300	PC6510	190 (150~250)	0.04~0.12	0.05~0.14	0.06~0.18	0.10~0.22	0.10~0.26	0.10~0.26	
			PD	PC5300	PC6510	130 (100~160)	0.04~0.07	0.04~0.08	0.04~0.10	0.05~0.12	0.05~0.12	0.05~0.12	
S	Ni-heat resisting alloy	130~400	PD	PC5300	PC5300	50 (30~100)	0.04~0.10	0.04~0.10	0.04~0.10	0.04~0.10	0.04~0.10	0.04~0.10	
				PC9540	PC9540	40 (20~80)	0.04~0.10	0.04~0.10	0.04~0.10	0.04~0.10	0.04~0.10	0.04~0.10	
	Ti-heat resisting alloy	130~400	LD	PC5335	PC5335	60 (40~80)	0.04~0.08	0.04~0.10	0.06~0.12	0.06~0.14	0.06~0.16	0.06~0.16	
			PD	PC5300	PC5300	60 (40~80)	0.04~0.08	0.04~0.10	0.06~0.12	0.06~0.14	0.06~0.16	0.06~0.16	
High hardened steel	over 400	PD	PC5300	PC5300	40 (20~80)	0.04~0.05	0.04~0.06	0.04~0.08	0.04~0.08	0.04~0.08	0.04~0.08		
N	Aluminium	30~150	ND	H01	H01	300 (250~400)	0.05~0.14	0.06~0.16	0.10~0.20	0.10~0.22	0.12~0.25	0.12~0.25	
						250 (200~300)	0.05~0.14	0.06~0.16	0.10~0.20	0.10~0.22	0.12~0.25	0.12~0.25	

- The Max. feed of 5D holders is 70%~80% of the max. conditions of 2D/3D/4D holders
- In interrupted machining part, reduce 30~50% of feed from the above machining around interrupted part



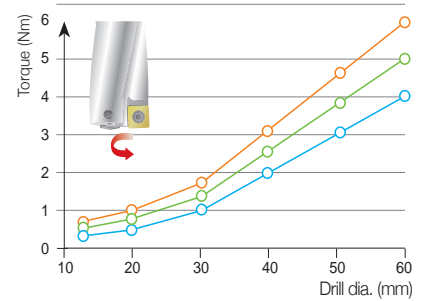
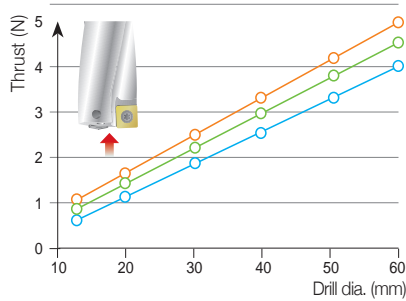
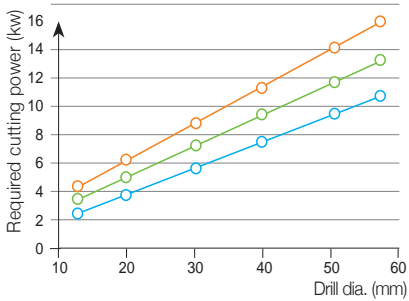
## Required cutting power

- The graphs below show the cutting force required in drilling
- Machining with the King Drill and a machine with high rigidity and power

■ **Workpiece** SCM440 (240HB)

■ **Cutting conditions**  $vc$  (m/min) = 100, Through coolant system

$fn$  (mm/rev) = 0.13     $fn$  (mm/rev) = 0.10     $fn$  (mm/rev) = 0.07

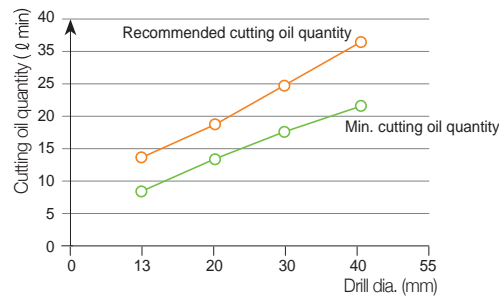


## Cutting oil quantity

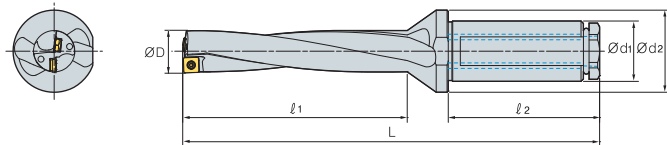
■ **Workpiece** SCM440 (240HB)

■ **Cutting conditions**  $vc$  (m/min) = 100, Through coolant system

- The data of the graph above could be changed depending on workpiece and cutting condition

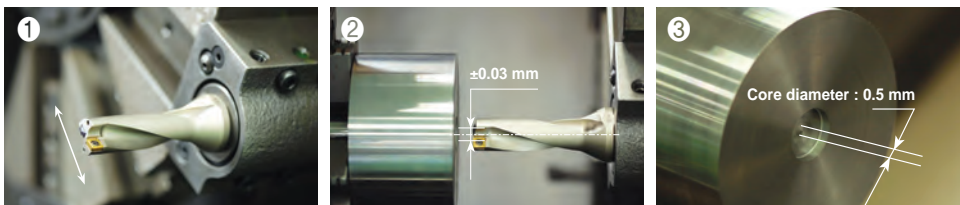


## Drill tolerance and hole tolerance



Drill dia.		Ø12~Ø29	Ø30~Ø45	Ø46~Ø60.5
2D~3D	Drill tolerance (ØD)	0~-0.15	0~-0.15	0~-0.15
	Hole tolerance	+0.2~-0.1	+0.25~-0.1	+0.28~-0.1
4D~5D	Drill tolerance (ØD)	0~-0.15	0~-0.15	0~-0.15
	Hole tolerance	+0.25~-0.05	+0.3~-0.05	+0.33~-0.05

## Notice for setting the drill in the lathe

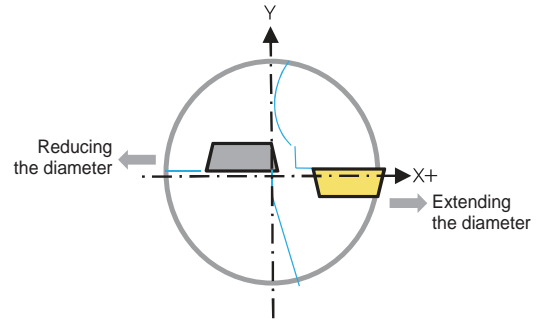


- Set the peripheral insert parallel to the X axis. (based on the side lock)
- If the machined core is 0.5 mm after machining 5 mm, that is the proper setting
- ※ Please make sure that the location of the side lock could be different depending on manufacturers of machine

# F Technical Information for King Drill

## ◉ Range of adjusting machining diameter in the lathe

- In machining in the lathe, the King Drill can extend and reduce the machining diameter by adjusting the x-axis. Please refer to the table showing the range of adjusting drilling diameter below
- The more the drilling diameter is extended or reduced, the more the drill loses drilling balance. In this case, reduce the feed or cutting speed in machining
- Reducing the machining diameter excessively could damage the holder



(mm)

Drill dia. (Ø)	Range of adjusting drilling diameter (Ø)	Drill dia. (Ø)	Range of adjusting drilling diameter (Ø)	Drill dia. (Ø)	Range of adjusting drilling diameter (Ø)	Drill dia. (Ø)	Range of adjusting drilling diameter (Ø)
12.0	11.7~12.4	24.5	23.9~25.1	37.0	36.3~37.7	49.5	48.7~50.2
12.5	12.2~12.9	25.0	24.4~25.6	37.5	36.8~38.2	50.0	49.2~50.7
13.0	12.7~13.4	25.5	24.9~26.1	38.0	37.3~38.7	50.5	49.7~51.2
13.5	13.2~13.9	26.0	25.4~26.6	38.5	37.8~39.2	51.0	50.2~51.7
14.0	13.6~14.5	26.5	25.9~27.1	39.0	38.3~39.7	51.5	50.7~52.2
14.5	14.1~15.0	27.0	26.4~27.6	39.5	38.8~40.2	52.0	51.2~52.7
15.0	14.6~15.5	27.5	26.9~28.1	40.0	39.3~40.7	52.5	51.7~53.2
15.5	15.1~16.0	27.8	27.4~28.6	40.5	39.8~41.2	53.0	52.2~53.7
16.0	15.6~16.5	28.5	27.9~29.1	41.0	40.3~41.7	53.5	52.7~54.2
16.5	16.0~17.0	29.0	28.4~29.6	41.5	40.8~42.2	54.0	53.2~54.7
17.0	16.5~17.5	29.5	28.9~30.1	42.0	41.3~42.7	54.5	53.7~55.2
17.5	17.0~18.0	30.0	29.3~30.7	42.5	41.8~43.2	55.0	54.2~55.7
18.0	17.5~18.5	30.5	29.8~31.2	43.0	42.2~43.7	55.5	54.7~56.2
18.5	18.0~19.0	31.0	30.3~31.7	43.5	42.7~44.2	56.0	55.2~56.7
19.0	18.5~19.5	31.5	30.8~32.2	44.0	43.2~44.7	56.5	55.7~57.2
19.5	19.0~20.0	32.0	31.3~32.7	44.5	43.7~45.2	57.0	56.2~57.7
20.0	19.4~20.6	32.5	31.8~33.2	45.0	44.2~45.7	57.5	56.7~58.2
20.5	19.9~21.1	33.0	32.3~33.7	45.5	44.7~46.2	58.0	57.2~58.7
21.0	20.4~21.6	33.5	32.8~34.2	46.0	45.2~46.7	58.5	57.7~59.2
21.5	20.9~22.1	34.0	33.3~34.7	46.5	45.7~47.2	59.0	58.2~59.7
22.0	21.4~22.6	34.5	33.8~35.2	47.0	46.2~47.7	59.5	58.7~60.2
22.5	21.9~23.1	35.0	34.3~35.7	47.5	46.7~48.2	60.0	59.2~60.7
23.0	22.4~23.6	35.5	34.8~36.2	48.0	47.2~48.7	60.5	59.7~61.2
23.5	22.9~24.1	36.0	35.3~36.7	48.5	47.7~49.2		
24.0	23.4~24.6	36.5	35.8~37.2	49.0	48.2~49.7		

## ◉ Insert and parts

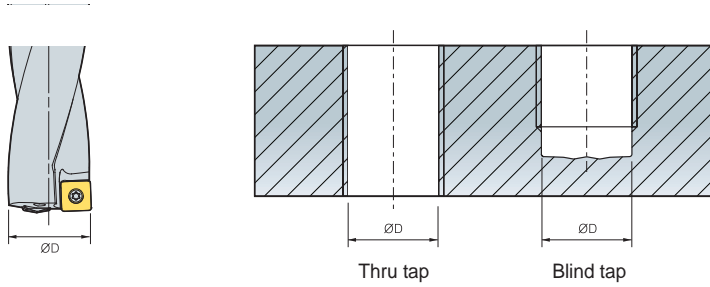
Drill dia. (mm)	Peripheral insert	Central insert	Screw	Wrench	Torque (N·m)
Ø12.0~Ø13.5	SP□T040204-□□	XO□T040204-□□	FTNA0204	TW06P	0.4
Ø13.6~Ø16.0	SP□T050204-□□	XO□T050204-□□	FTNA0204	TW06P	0.4
Ø16.1~Ø19.5	SP□T060205-□□	XO□T060204-□□	FTKA02206S	TW07P	0.8
Ø19.6~Ø23.5	SP□T07T208-□□	XO□T07T205-□□	FTKA02565	TW07S	0.8
Ø23.6~Ø29.5	SP□T090308-□□	XO□T090305-□□	FTKA0307	TW09S	1.2
Ø29.6~Ø35.5	SP□T11T308-□□	XO□T11T306-□□	FTKA03508	TW15S	3
Ø35.6~Ø42.5	SP□T130410-□□	XO□T130406-□□	FTKA0410	TW15S	3
Ø42.6~Ø50.5	SP□T15M510-□□	XO□T15M508-□□	FTNC04511	TW20S	5
Ø50.6~Ø60.5	SP□T180510-□□	XO□T180508-□□	FTNA0511	TW20-100	5

- In clamping an insert, please clean the tip seat and apply CASMOLY1000 on the screw
- Please make sure to use a Korloy-produced wrench and screw only



## King Drill - for machining a tap foundation hole

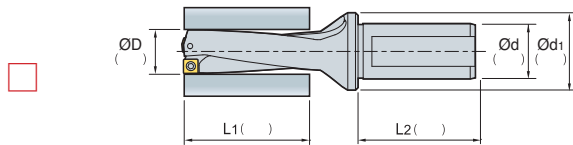
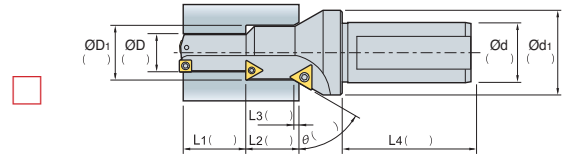
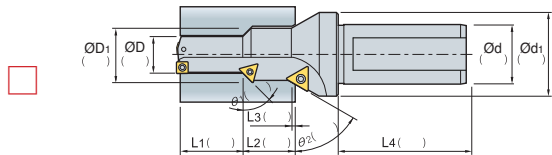
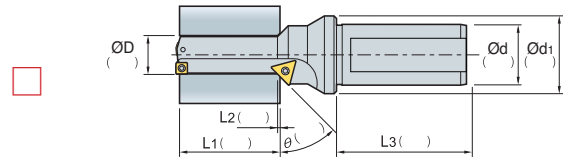
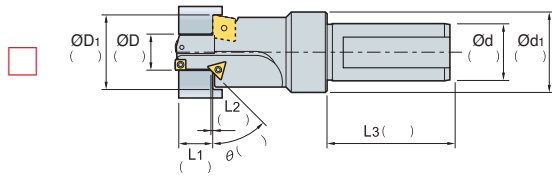
- There are two types of specifications of tap, metric and inch. The King Drill is available for machining both thru tap and blind tap



(mm)

Tap type	Thread	$\varnothing D$	Designation	Reference
Metric	M14x2.0	12.0	K3D12020-04	G14
	M16x2.0	14.0	K3D14020-05	G14
	M18x2.5	15.5	K3D15520-05	G14
	M20x2.5	17.5	K3D17525-06	G14
	M22x2.5	19.5	K3D19525-06	G14
	M24x3.0	21.0	K3D21025-07	G14
	M27x3.0	24.0	K3D24032-09	G14
	M30x3.5	26.5	K3D26532-09	G14
	M33x4.0	29.0	K3D29032-09	G14
	M36x4.0	32.0	K3D32032-11	G15
	M39x4.0	35.0	K3D35032-11	G15
	M42x4.5	37.5	K3D37540-13	G15
Inch	9/16-12 UNC	12.2	K3D12220-04	G14
	5/8-11 UNC	13.5	K3D13520-04	G14
	3/4-10 UNC	16.5	K3D16525-06	G14
	7/8-9 UNC	19.5	K3D19525-06	G14
	9/16-18 UNF	12.9	K3D12920-04	G14
	5/8-18 UNF	14.5	K3D14520-05	G14
	3/4-16 UNF	17.5	K3D17525-06	G14

## Special drill order form



**■ Coolant type**

Through coolant Plug Type (Standard)     Through coolant Non Plug Type     No coolant

**■ Hole type**

Blind hole     Thru hole

**■ Types of shank**

Flat Type

Weldon Type

Whistle Notch Type

**■ Location of side lock**

Parallel to peripheral insert (standard)

90° angle to peripheral insert (standard)

180° angle to peripheral insert (standard)

270° angle to peripheral insert (standard)

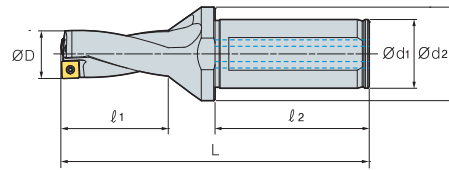
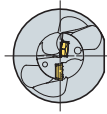
**■ Note**

- Currently using tool:
- Current cutting condition
  - RPM or vc (m/min):
  - vf (mm/min) or fn (mm/rev):
  - Depth of cut (mm):
- Standard of measuring tool life:
- Currently using machine
  - Machining center:
  - General lathe:
  - CNC lathe:





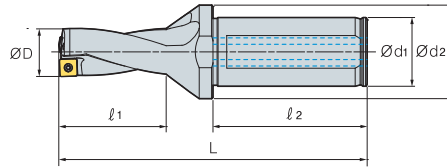
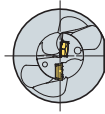
## King Drill (2D)





Designation		ØD	Ød <sub>1</sub>	Ød <sub>2</sub>	l <sub>1</sub>	l <sub>2</sub>	L	Insert	Screw	Wrench
K2D	12020-04	12.0	20	25	27	50	91	SP□T040204-□□ XO□T040204-□□	FTNA0204	TW06P
	12520-04	12.5	20	25	27	50	91			
	13020-04	13.0	20	25	29	50	93			
	13520-04	13.5	20	25	29	50	93	SP□T050204-□□ XO□T050204-□□	FTNA0204	TW06P
	14020-05	14.0	20	25	31	50	96			
	14520-05	14.5	20	25	31	50	96			
	15020-05	15.0	20	25	33	50	99	SP□T060205-□□ XO□T060204-□□	FTKA02206S	TW07P
	15520-05	15.5	20	25	33	50	99			
	16020-05	16.0	20	25	35	50	101			
	16525-06	16.5	25	34	35	56	107	SP□T07T208-□□ XO□T07T205-□□	FTKA02565	TW07S
	17025-06	17.0	25	34	37	56	109			
	17525-06	17.5	25	34	37	56	109			
	18025-06	18.0	25	34	39	56	112	SP□T090308-□□ XO□T090305-□□	FTKA0307	TW09S
	18525-06	18.5	25	34	39	56	112			
	19025-06	19.0	25	34	41	56	114			
	19525-06	19.5	25	34	41	56	114	SP□T11T308-□□ XO□T11T306-□□	FTKA03508	TW15S
	20025-07	20.0	25	34	43	56	118			
	20525-07	20.5	25	34	43	56	118			
	21025-07	21.0	25	34	45	56	120	SP□T11T308-□□ XO□T11T306-□□	FTKA03508	TW15S
	21525-07	21.5	25	34	45	56	120			
	22025-07	22.0	25	34	47	56	122			
	22525-07	22.5	25	34	47	56	122	SP□T11T308-□□ XO□T11T306-□□	FTKA03508	TW15S
	23025-07	23.0	25	34	49	56	126			
	23525-07	23.5	25	34	49	56	126			
	24032-09	24.0	32	44	51	60	133	SP□T11T308-□□ XO□T11T306-□□	FTKA03508	TW15S
	24532-09	24.5	32	44	51	60	133			
	25032-09	25.0	32	44	53	60	135			
	25532-09	25.5	32	44	53	60	135	SP□T11T308-□□ XO□T11T306-□□	FTKA03508	TW15S
	26032-09	26.0	32	44	55	60	137			
	26532-09	26.5	32	44	55	60	137			
	27032-09	27.0	32	44	57	60	140	SP□T11T308-□□ XO□T11T306-□□	FTKA03508	TW15S
	27532-09	27.5	32	44	57	60	140			
	28032-09	28.0	32	44	59	60	143			
	28532-09	28.5	32	44	59	60	143	SP□T11T308-□□ XO□T11T306-□□	FTKA03508	TW15S
	29032-09	29.0	32	44	61	60	145			
29532-09	29.5	32	44	61	60	145				
30032-11	30.0	32	44	63	60	150	SP□T11T308-□□ XO□T11T306-□□	FTKA03508	TW15S	
30532-11	30.5	32	44	63	60	150				
31032-11	31.0	32	44	65	60	152				
31532-11	31.5	32	44	65	60	152	SP□T11T308-□□ XO□T11T306-□□	FTKA03508	TW15S	
32032-11	32.0	32	44	67	60	154				
32532-11	32.5	32	44	67	60	154				
33032-11	33.0	32	44	69	60	157	SP□T11T308-□□ XO□T11T306-□□	FTKA03508	TW15S	
33532-11	33.5	32	44	69	60	157				
34032-11	34.0	32	44	71	60	159				
34532-11	34.5	32	44	71	60	159	SP□T11T308-□□ XO□T11T306-□□	FTKA03508	TW15S	
35032-11	35.0	32	44	73	60	161				
35532-11	35.5	32	44	73	60	161				

↻ Applicable inserts F03-04

## King Drill (2D)

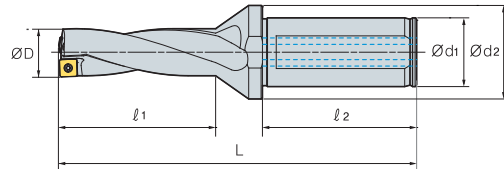
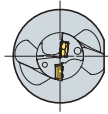


(mm)

Designation	ØD	Ød <sub>1</sub>	Ød <sub>2</sub>	l <sub>1</sub>	l <sub>2</sub>	L	Insert	Screw 	Wrench 
<b>K2D</b>									
36040-13	36.0	40	48	76	70	176	SP□T130410-□□ XO□T130406-□□	FTKA0410	TW15S
36540-13	36.5	40	48	76	70	176			
37040-13	37.0	40	48	78	70	178			
37540-13	37.5	40	48	78	70	178			
38040-13	38.0	40	48	80	70	181			
38540-13	38.5	40	48	80	70	181			
39040-13	39.0	40	48	82	70	183			
39540-13	39.5	40	48	82	70	183			
40040-13	40.0	40	48	84	70	186			
40540-13	40.5	40	48	84	70	186			
41040-13	41.0	40	48	86	70	188			
41540-13	41.5	40	48	86	70	188			
42040-13	42.0	40	48	88	70	191			
42540-13	42.5	40	48	88	70	191			
43040-15	43.0	40	58	91	70	196			
43540-15	43.5	40	58	91	70	196			
44040-15	44.0	40	58	93	70	198			
44540-15	44.5	40	58	93	70	198			
45040-15	45.0	40	58	95	70	201			
45540-15	45.5	40	58	95	70	201			
46040-15	46.0	40	58	97	70	203			
46540-15	46.5	40	58	97	70	203			
47040-15	47.0	40	58	99	70	206			
47540-15	47.5	40	58	99	70	206			
48040-15	48.0	40	58	101	70	208			
48540-15	48.5	40	58	101	70	208			
49040-15	49.0	40	58	103	70	210			
49540-15	49.5	40	58	103	70	210			
50040-15	50.0	40	58	105	70	212			
50540-15	50.5	40	58	105	70	212			
51040-18	51.0	40	68	108	70	218			
51540-18	51.5	40	68	108	70	218			
52040-18	52.0	40	68	110	70	220			
52540-18	52.5	40	68	110	70	220			
53040-18	53.0	40	68	112	70	222			
53540-18	53.5	40	68	112	70	222			
54040-18	54.0	40	68	114	70	224			
54540-18	54.5	40	68	114	70	224			
55040-18	55.0	40	68	116	70	226			
55540-18	55.5	40	68	116	70	226			
56040-18	56.0	40	68	118	70	230			
56540-18	56.5	40	68	118	70	230			
57040-18	57.0	40	68	121	70	233			
57540-18	57.5	40	68	121	70	233			
58040-18	58.0	40	68	124	70	236			
58540-18	58.5	40	68	124	70	236			
59040-18	59.0	40	68	127	70	239			
59540-18	59.5	40	68	127	70	239			
60040-18	60.0	40	68	130	70	242			
60540-18	60.5	40	68	130	70	242			
							SP□T15M510-□□ XO□T15M508-□□	FTNC04511	TW20S
							SP□T180510-□□ XO□T180508-□□	FTNA0511	TW20-100

Applicable inserts F03-04

# King Drill (3D)

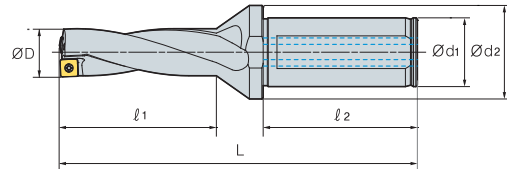
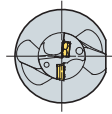


Designation		ØD	Ød <sub>1</sub>	Ød <sub>2</sub>	ℓ <sub>1</sub>	ℓ <sub>2</sub>	L	Insert	Screw	Wrench
K3D	12020-04 *	12.0	20	25	39	50	103	SP□T040204-□□ XO□T040204-□□	FTNA0204	TW06P
	12220-04	12.2	20	25	39	50	103			
	12520-04	12.5	20	25	39	50	103			
	12920-04	12.9	20	25	42	50	106			
	13020-04	13.0	20	25	42	50	106			
	13520-04	13.5	20	25	42	50	106			
	14020-05 *	14.0	20	25	45	50	110	SP□T050204-□□ XO□T050204-□□	FTNA0204	TW06P
	14520-05	14.5	20	25	45	50	110			
	15020-05	15.0	20	25	48	50	114			
	15520-05 *	15.5	20	25	48	50	114			
	16020-05	16.0	20	25	51	50	117			
	16525-06	16.5	25	34	51	56	123			
	17025-06	17.0	25	34	54	56	126			
	17525-06 *	17.5	25	34	54	56	126			
	18025-06	18.0	25	34	57	56	130			
	18525-06	18.5	25	34	57	56	130			
	19025-06	19.0	25	34	60	56	133			
	19525-06 *	19.5	25	34	60	56	133	SP□T07T208-□□ XO□T07T205-□□	FTKA02565	TW07S
	20025-07	20.0	25	34	63	56	138			
	20525-07	20.5	25	34	63	56	138			
	21025-07 *	21.0	25	34	66	56	141			
	21525-07	21.5	25	34	66	56	141			
	22025-07	22.0	25	34	69	56	144			
	22525-07	22.5	25	34	69	56	144	SP□T090308-□□ XO□T090305-□□	FTKA0307	TW09S
	23025-07	23	25	34	72	56	149			
	23525-07	23.5	25	34	72	56	149			
	24032-09 *	24.0	32	44	75	60	157			
	24532-09	24.5	32	44	75	60	157			
	25032-09	25.0	32	44	78	60	160			
	25532-09	25.5	32	44	78	60	160	SP□T090308-□□ XO□T090305-□□	FTKA0307	TW09S
	26032-09	26.0	32	44	81	60	163			
	26532-09 *	26.5	32	44	81	60	163			
27032-09	27.0	32	44	84	60	167				
27532-09	27.5	32	44	84	60	167				
28032-09	28.0	32	44	87	60	171				
28532-09	28.5	32	44	87	60	171	SP□T090308-□□ XO□T090305-□□	FTKA0307	TW09S	
29032-09 *	29.0	32	44	90	60	174				
29532-09	29.5	32	44	90	60	174				



↻ Applicable inserts **F03-04**

The items marked \* can machine a tap foundation hole (Reference F08 page)

## King Drill (3D)



(mm)

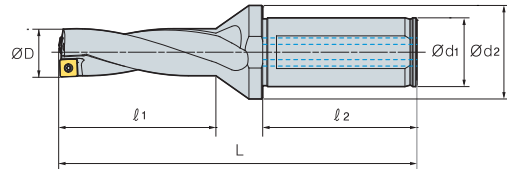
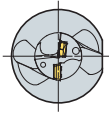
Designation	ØD	Ød <sub>1</sub>	Ød <sub>2</sub>	l <sub>1</sub>	l <sub>2</sub>	L	Insert	Screw 	Wrench 			
<b>K3D</b>												
30032-11 *	30.0	32	44	93	60	180	SP□T11T308-□□ XO□T11T306-□□	FTKA03508	TW15S			
30532-11	30.5	32	44	93	60	180						
31032-11	31.0	32	44	96	60	183						
31532-11	31.5	32	44	96	60	183						
32032-11	32.0	32	44	99	60	186						
32532-11	32.5	32	44	99	60	186						
33032-11	33.0	32	44	102	60	190						
33532-11	33.5	32	44	102	60	190						
34032-11	34.0	32	44	105	60	193						
34532-11	34.5	32	44	105	60	193						
35032-11 *	35.0	32	44	108	60	196						
35532-11	35.5	32	44	108	60	196						
36040-13	36.0	40	48	112	70	212				SP□T130410-□□ XO□T130406-□□	FTKA0410	TW15S
36540-13	36.5	40	48	112	70	212						
37040-13	37.0	40	48	115	70	215						
37540-13	37.5	40	48	115	70	215						
38040-13	38.0	40	48	118	70	219						
38540-13	38.5	40	48	118	70	219						
39040-13	39.0	40	48	121	70	222						
39540-13	39.5	40	48	121	70	222						
40040-13	40.0	40	48	124	70	226						
40540-13	40.5	40	48	124	70	226						
41040-13	41.0	40	48	127	70	229						
41540-13	41.5	40	48	127	70	229						
42040-13	42.0	40	48	130	70	233						
42540-13	42.5	40	48	130	70	233						
43040-15	43.0	40	58	134	70	239	SP□T15M510-□□ XO□T15M508-□□	FTNC04511	TW20S			
43540-15	43.5	40	58	134	70	239						
44040-15	44.0	40	58	137	70	242						
44540-15	44.5	40	58	137	70	242						
45040-15	45.0	40	58	140	70	246						
45540-15	45.5	40	58	140	70	246						
46040-15	46.0	40	58	143	70	249						
46540-15	46.5	40	58	143	70	249						
47040-15	47.0	40	58	146	70	253						
47540-15	47.5	40	58	146	70	253						
48040-15	48.0	40	58	149	70	256						
48540-15	48.5	40	58	149	70	256						
49040-15	49.0	40	58	152	70	259						
49540-15	49.5	40	58	152	70	259						
50040-15	50.0	40	58	155	70	262						
50540-15	50.5	40	58	155	70	262						

↻ Applicable inserts F03-04

The items marked \* can machine a tap foundation hole (Reference F08 page)



# King Drill (3D)

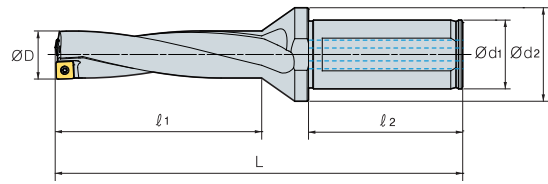
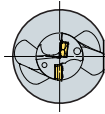


(mm)



Designation		ØD	Ød <sub>1</sub>	Ød <sub>2</sub>	l <sub>1</sub>	l <sub>2</sub>	L	Insert	Screw	Wrench
<b>K3D</b>	<b>51040-18</b>	51.0	40	68	159	70	269	SP□T180510-□□ XO□T180508-□□	FTNA0511	TW20-100
	<b>51540-18</b>	51.5	40	68	159	70	269			
	<b>52040-18</b>	52.0	40	68	162	70	272			
	<b>52540-18</b>	52.5	40	68	162	70	272			
	<b>53040-18</b>	53.0	40	68	165	70	275			
	<b>53540-18</b>	53.5	40	68	165	70	275			
	<b>54040-18</b>	54.0	40	68	168	70	278			
	<b>54540-18</b>	54.5	40	68	168	70	278			
	<b>55040-18</b>	55.0	40	68	171	70	281			
	<b>55540-18</b>	55.5	40	68	171	70	281			
	<b>56040-18</b>	56.0	40	68	174	70	286			
	<b>56540-18</b>	56.5	40	68	174	70	286			
	<b>57040-18</b>	57.0	40	68	178	70	290			
	<b>57540-18</b>	57.5	40	68	178	70	290			
	<b>58040-18</b>	58.0	40	68	182	70	294			
	<b>58540-18</b>	58.5	40	68	182	70	294			
	<b>59040-18</b>	59.0	40	68	186	70	298			
	<b>59540-18</b>	59.5	40	68	186	70	298			
	<b>60040-18</b>	60.0	40	68	190	70	302			
	<b>60540-18</b>	60.5	40	68	190	70	302			

↻ Applicable inserts **F03-04**

## King Drill (4D)



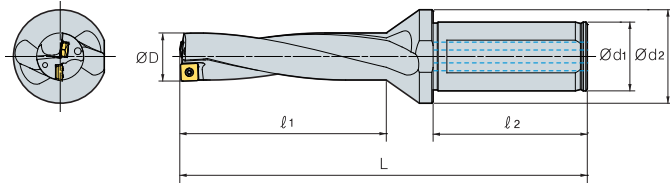
(mm)

Designation	ØD	Ød <sub>1</sub>	Ød <sub>2</sub>	l <sub>1</sub>	l <sub>2</sub>	L	Insert	Screw 	Wrench 
<b>K4D</b>									
12020-04	12.0	20	25	51	50	115	SP□T040204-□□ XO□T040204-□□	FTNA0204	TW06P
12520-04	12.5	20	25	51	50	115			
13020-04	13.0	20	25	55	50	119			
13520-04	13.5	20	25	55	50	119	SP□T050204-□□ XO□T050204-□□	FTNA0204	TW06P
14020-05	14.0	20	25	59	50	124			
14520-05	14.5	20	25	59	50	124			
15020-05	15.0	20	25	63	50	129	SP□T060205-□□ XO□T060204-□□	FTKA02206S	TW07P
15520-05	15.5	20	25	63	50	129			
16020-05	16.0	20	25	67	50	133			
16525-06	16.5	25	34	67	56	139	SP□T07T208-□□ XO□T07T205-□□	FTKA02565	TW07S
17025-06	17.0	25	34	71	56	143			
17525-06	17.5	25	34	71	56	143			
18025-06	18.0	25	34	75	56	148	SP□T090308-□□ XO□T090305-□□	FTKA0307	TW09S
18525-06	18.5	25	34	75	56	148			
19025-06	19.0	25	34	79	56	152			
19525-06	19.5	25	34	79	56	152	SP□T11T308-□□ XO□T11T306-□□	FTKA03508	TW15S
20025-07	20.0	25	34	83	56	158			
20525-07	20.5	25	34	83	56	158			
21025-07	21.0	25	34	87	56	162	SP□T11T308-□□ XO□T11T306-□□	FTKA03508	TW15S
21525-07	21.5	25	34	87	56	162			
22025-07	22.0	25	34	91	56	166			
22525-07	22.5	25	34	91	56	166	SP□T11T308-□□ XO□T11T306-□□	FTKA03508	TW15S
23025-07	23.0	25	34	95	56	172			
23525-07	23.5	25	34	95	56	172			
24032-09	24.0	32	44	99	60	181	SP□T11T308-□□ XO□T11T306-□□	FTKA03508	TW15S
24532-09	24.5	32	44	99	60	181			
25032-09	25.0	32	44	103	60	185			
25532-09	25.5	32	44	103	60	185	SP□T11T308-□□ XO□T11T306-□□	FTKA03508	TW15S
26032-09	26.0	32	44	107	60	189			
26532-09	26.5	32	44	107	60	189			
27032-09	27.0	32	44	111	60	194	SP□T11T308-□□ XO□T11T306-□□	FTKA03508	TW15S
27532-09	27.5	32	44	111	60	194			
28032-09	28.0	32	44	115	60	199			
28532-09	28.5	32	44	115	60	199	SP□T11T308-□□ XO□T11T306-□□	FTKA03508	TW15S
29032-09	29.0	32	44	119	60	203			
29532-09	29.5	32	44	119	60	203			
30032-11	30.0	32	44	123	60	210	SP□T11T308-□□ XO□T11T306-□□	FTKA03508	TW15S
30532-11	30.5	32	44	123	60	210			
31032-11	31.0	32	44	127	60	214			
31532-11	31.5	32	44	127	60	214	SP□T11T308-□□ XO□T11T306-□□	FTKA03508	TW15S
32032-11	32.0	32	44	131	60	218			
32532-11	32.5	32	44	131	60	218			
33032-11	33.0	32	44	135	60	223	SP□T11T308-□□ XO□T11T306-□□	FTKA03508	TW15S
33532-11	33.5	32	44	135	60	223			
34032-11	34.0	32	44	139	60	227			
34532-11	34.5	32	44	139	60	227	SP□T11T308-□□ XO□T11T306-□□	FTKA03508	TW15S
35032-11	35.0	32	44	143	60	231			
35532-11	35.5	32	44	143	60	231			

↻ Applicable inserts F03-04



# King Drill (4D)

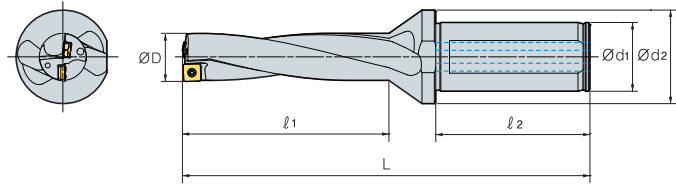


Designation		ØD	Ød <sub>1</sub>	Ød <sub>2</sub>	l <sub>1</sub>	l <sub>2</sub>	L	Insert	Screw	Wrench
K4D	36040-13	36.0	40	48	148	70	248	SP□T130410-□□ XO□T130406-□□	FTKA0410	TW15S
	36540-13	36.5	40	48	148	70	248			
	37040-13	37.0	40	48	152	70	252			
	37540-13	37.5	40	48	152	70	252			
	38040-13	38.0	40	48	156	70	257			
	38540-13	38.5	40	48	156	70	257			
	39040-13	39.0	40	48	160	70	261			
	39540-13	39.5	40	48	160	70	261			
	40040-13	40.0	40	48	164	70	266			
	40540-13	40.5	40	48	164	70	266			
	41040-13	41.0	40	48	168	70	270			
	41540-13	41.5	40	48	168	70	270			
	42040-13	42.0	40	48	172	70	275			
	42540-13	42.5	40	48	172	70	275			
	43040-15	43.0	40	58	177	70	282			
	43540-15	43.5	40	58	177	70	282			
	44040-15	44.0	40	58	181	70	286			
	44540-15	44.5	40	58	181	70	286			
	45040-15	45.0	40	58	185	70	291			
	45540-15	45.5	40	58	185	70	291			
	46040-15	46.0	40	58	189	70	295			
	46540-15	46.5	40	58	189	70	295			
	47040-15	47.0	40	58	193	70	300			
	47540-15	47.5	40	58	193	70	300			
	48040-15	48.0	40	58	197	70	304			
	48540-15	48.5	40	58	197	70	304			
	49040-15	49.0	40	58	201	70	308			
	49540-15	49.5	40	58	201	70	308			
	50040-15	50.0	40	58	205	70	312			
	50540-15	50.5	40	58	205	70	312			
	51040-18	51.0	40	68	210	70	320			
	51540-18	51.5	40	68	210	70	320			
52040-18	52.0	40	68	214	70	324				
52540-18	52.5	40	68	214	70	324				
53040-18	53.0	40	68	218	70	328				
53540-18	53.5	40	68	218	70	328				
54040-18	54.0	40	68	222	70	332				
54540-18	54.5	40	68	222	70	332				
55040-18	55.0	40	68	226	70	336				
55540-18	55.5	40	68	226	70	336				
56040-18	56.0	40	68	230	70	342				
56540-18	56.5	40	68	230	70	342				
57040-18	57.0	40	68	235	70	347				
57540-18	57.5	40	68	235	70	347				
58040-18	58.0	40	68	240	70	352				
58540-18	58.5	40	68	240	70	352				
59040-18	59.0	40	68	245	70	357				
59540-18	59.5	40	68	245	70	357				
60040-18	60.0	40	68	250	70	362				
60540-18	60.5	40	68	250	70	362				

→ Applicable inserts F03-04



## King Drill (5D)

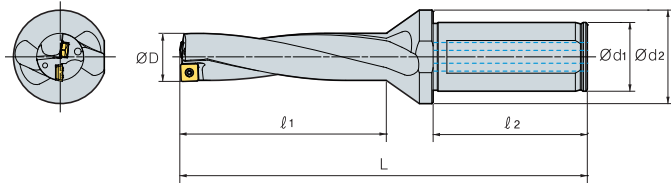


(mm)

Designation	ØD	Ød <sub>1</sub>	Ød <sub>2</sub>	l <sub>1</sub>	l <sub>2</sub>	L	Insert	Screw	Wrench	
<b>K5D</b>	<b>12020-04</b>	12.0	20	25	63	50	127	SP□T040204-□□ XO□T040204-□□	FTNA0204	TW06P
	<b>12520-04</b>	12.5	20	25	63	50	127			
	<b>13020-04</b>	13.0	20	25	68	50	132			
	<b>13520-04</b>	13.5	20	25	68	50	132			
	<b>14020-05</b>	14.0	20	25	73	50	138			
	<b>14520-05</b>	14.5	20	25	73	50	138	SP□T050204-□□ XO□T050204-□□	FTNA0204	TW06P
	<b>15020-05</b>	15.0	20	25	78	50	144			
	<b>15520-05</b>	15.5	20	25	78	50	144			
	<b>16020-05</b>	16.0	20	25	83	50	149			
	<b>16525-06</b>	16.5	25	34	83	56	155			
	<b>17025-06</b>	17.0	25	34	88	56	160	SP□T060205-□□ XO□T060204-□□	FTKA02206S	TW07P
	<b>17525-06</b>	17.5	25	34	88	56	160			
	<b>18025-06</b>	18.0	25	34	93	56	166			
	<b>18525-06</b>	18.5	25	34	93	56	166			
	<b>19025-06</b>	19.0	25	34	98	56	171			
	<b>19525-06</b>	19.5	25	34	98	56	171	SP□T07T208-□□ XO□T07T205-□□	FTKA02565	TW07S
	<b>20025-07</b>	20.0	25	34	103	56	178			
	<b>20525-07</b>	20.5	25	34	103	56	178			
	<b>21025-07</b>	21.0	25	34	108	56	183			
	<b>21525-07</b>	21.5	25	34	108	56	183			
	<b>22025-07</b>	22.0	25	34	113	56	188	SP□T090308-□□ XO□T090305-□□	FTKA0307	TW09S
	<b>22525-07</b>	22.5	25	34	113	56	188			
	<b>23025-07</b>	23.0	25	34	118	56	195			
	<b>23525-07</b>	23.5	25	34	118	56	195			
	<b>24032-09</b>	24.0	32	44	123	60	205			
	<b>24532-09</b>	24.5	32	44	123	60	205	SP□T11T308-□□ XO□T11T306-□□	FTKA03508	TW15S
	<b>25032-09</b>	25.0	32	44	128	60	210			
	<b>25532-09</b>	25.5	32	44	128	60	210			
	<b>26032-09</b>	26.0	32	44	133	60	215			
	<b>26532-09</b>	26.5	32	44	133	60	215			
	<b>27032-09</b>	27.0	32	44	138	60	221	SP□T11T308-□□ XO□T11T306-□□	FTKA03508	TW15S
	<b>27532-09</b>	27.5	32	44	138	60	221			
	<b>28032-09</b>	28.0	32	44	143	60	227			
	<b>28532-09</b>	28.5	32	44	143	60	227			
	<b>29032-09</b>	29.0	32	44	148	60	232			
<b>29532-09</b>	29.5	32	44	148	60	232	SP□T11T308-□□ XO□T11T306-□□	FTKA03508	TW15S	
<b>30032-11</b>	30.0	32	44	153	60	240				
<b>30532-11</b>	30.5	32	44	153	60	240				
<b>31032-11</b>	31.0	32	44	158	60	245				
<b>31532-11</b>	31.5	32	44	158	60	245				
<b>32032-11</b>	32.0	32	44	163	60	250	SP□T11T308-□□ XO□T11T306-□□	FTKA03508	TW15S	
<b>32532-11</b>	32.5	32	44	163	60	250				
<b>33032-11</b>	33.0	32	44	168	60	256				
<b>33532-11</b>	33.5	32	44	168	60	256				
<b>34032-11</b>	34.0	32	44	173	60	261				
<b>34532-11</b>	34.5	32	44	173	60	261	SP□T11T308-□□ XO□T11T306-□□	FTKA03508	TW15S	
<b>35032-11</b>	35.0	32	44	178	60	266				
<b>35532-11</b>	35.5	32	44	178	60	266				

↻ Applicable inserts F03-04

# King Drill (5D)



Designation		ØD	Ød <sub>1</sub>	Ød <sub>2</sub>	l <sub>1</sub>	l <sub>2</sub>	L	Insert	Screw	Wrench
K5D	36040-13	36.0	40	48	184	70	284	SP□T130410-□□ XO□T130406-□□	FTKA0410	TW15S
	36540-13	36.5	40	48	184	70	284			
	37040-13	37.0	40	48	189	70	289			
	37540-13	37.5	40	48	189	70	289			
	38040-13	38.0	40	48	194	70	295			
	38540-13	38.5	40	48	194	70	295			
	39040-13	39.0	40	48	199	70	300			
	39540-13	39.5	40	48	199	70	300			
	40040-13	40.0	40	48	204	70	306			
	40540-13	40.5	40	48	204	70	306			
	41040-13	41.0	40	48	209	70	311			
	41540-13	41.5	40	48	209	70	311			
	42040-13	42.0	40	48	214	70	317			
	42540-13	42.5	40	48	214	70	317			
	43040-15	43.0	40	58	220	70	325			
	43540-15	43.5	40	58	221	70	326			
	44040-15	44.0	40	58	225	70	330			
	44540-15	44.5	40	58	225	70	330			
	45040-15	45.0	40	58	230	70	336			
	45540-15	45.5	40	58	230	70	336			
	46040-15	46.0	40	58	235	70	341			
	46540-15	46.5	40	58	235	70	341			
	47040-15	47.0	40	58	240	70	347			
	47540-15	47.5	40	58	240	70	347			
	48040-15	48.0	40	58	245	70	352			
	48540-15	48.5	40	58	245	70	352			
	49040-15	49.0	40	58	250	70	357			
	49540-15	49.5	40	58	250	70	357			
	50040-15	50.0	40	58	255	70	362			
	50540-15	50.5	40	58	255	70	362			
	51040-18	51.0	40	68	261	70	371			
	51540-18	51.5	40	68	261	70	371			
	52040-18	52.0	40	68	266	70	376			
52540-18	52.5	40	68	266	70	376				
53040-18	53.0	40	68	271	70	381				
53540-18	53.5	40	68	271	70	381				
54040-18	54.0	40	68	276	70	386				
54540-18	54.5	40	68	276	70	386				
55040-18	55.0	40	68	281	70	391				
55540-18	55.5	40	68	281	70	391				
56040-18	56.0	40	68	286	70	398				
56540-18	56.5	40	68	286	70	398				
57040-18	57.0	40	68	292	70	404				
57540-18	57.5	40	68	292	70	404				
58040-18	58.0	40	68	298	70	410				
58540-18	58.5	40	68	298	70	410				
59040-18	59.0	40	68	304	70	416				
59540-18	59.5	40	68	304	70	416				
60040-18	60.0	40	68	310	70	422				
60540-18	60.5	40	68	310	70	422				

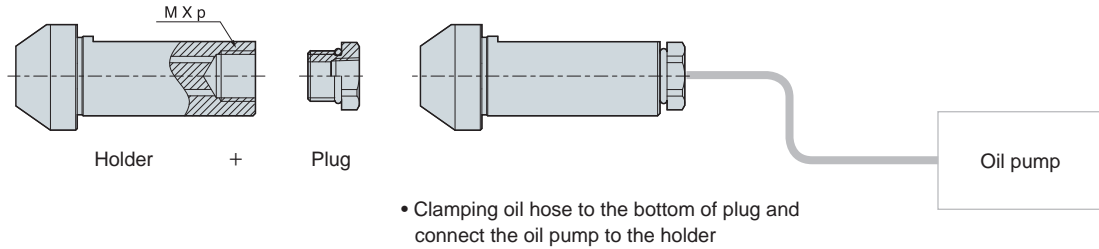
↻ Applicable inserts F03~04

# F Technical Information for King Drill (For through coolant system with a lathe)

Drill with through coolant system for general lathe and CNC lathe without through coolant system

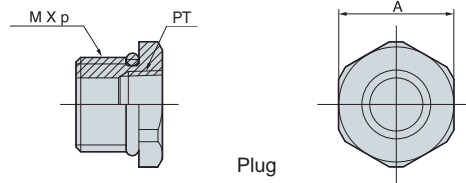
## King Drill (For through coolant system with a lathe)

- Through coolant system with drill holder, plug, oil-hole hose and oil-hole pump
- PT TAP in the plug is combined to PT TAP connected to oil hose
- Available to use the drill without a plug in milling machine



(mm)

Tap type	Diameter	Shank dia.	M x p	Plug
K□D120~16020HP-□□	Ø12.0~Ø16.0	Ø20	M12x1.5	PLG12PT18
K□D161~23525HP-□□	Ø16.1~Ø23.5	Ø25	M16x1.5	PLG16PT18
K□D236~35532HP-□□	Ø23.6~Ø35.5	Ø32	M20x2.0	PLG20PT14
K□D356~60940HP-□□	Ø35.6~Ø60.5	Ø40	M27x2.0	PLG27PT38



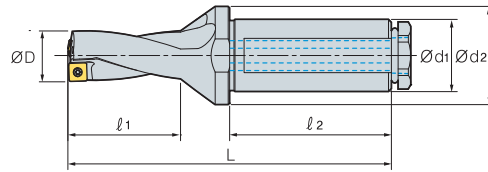
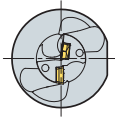
- Plug is assembled

Plug type	M x p	PT tap	A
PLG12PT18	M12x1.5	1/8	16
PLG16PT18	M16x1.5	1/8	19
PLG20PT14	M20x2.0	1/4	26
PLG27PT38	M27x2.0	3/8	35



## King Drill (2D)

For through coolant system with a lathe



(mm)

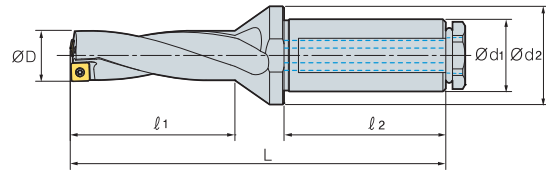
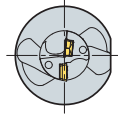
Designation	ØD	Ød <sub>1</sub>	Ød <sub>2</sub>	l <sub>1</sub>	l <sub>2</sub>	L	Insert	Screw	Wrench	
<b>K2D</b>	<b>13020HP-04</b>	13.0	20	25	29	50	93	SP□T040204-□□ XO□T040204-□□	FTNA0204	TW06P
	<b>13520HP-04</b>	13.5	20	25	29	50	93			
	<b>14020HP-05</b>	14.0	20	25	31	50	96			
	<b>15020HP-05</b>	15.0	20	25	33	50	99	SP□T050204-□□ XO□T050204-□□	FTNA0204	TW06P
	<b>16020HP-05</b>	16.0	20	25	35	50	101			
	<b>17025HP-06</b>	17.0	25	34	37	56	109			
	<b>18025HP-06</b>	18.0	25	34	39	56	112	SP□T060205-□□ XO□T060204-□□	FTKA02206S	TW07P
	<b>19025HP-06</b>	19.0	25	34	41	56	114			
	<b>20025HP-07</b>	20.0	25	34	43	56	118			
	<b>21025HP-07</b>	21.0	25	34	45	56	120	SP□T07T208-□□ XO□T07T205-□□	FTKA02565	TW07S
	<b>22025HP-07</b>	22.0	25	34	47	56	122			
	<b>23025HP-07</b>	23.0	25	34	49	56	126			
	<b>24032HP-09</b>	24.0	32	44	51	60	133			
	<b>25032HP-09</b>	25.0	32	44	53	60	135			
	<b>26032HP-09</b>	26.0	32	44	55	60	137			
	<b>27032HP-09</b>	27.0	32	44	57	60	140	SP□T090308-□□ XO□T090305-□□	FTKA0307	TW09S
	<b>28032HP-09</b>	28.0	32	44	59	60	143			
	<b>29032HP-09</b>	29.0	32	44	61	60	145			

↻ Applicable inserts **F03-04**

# F King Drill (For through coolant system with a lathe)

## King Drill (3D)

For through coolant system with a lathe



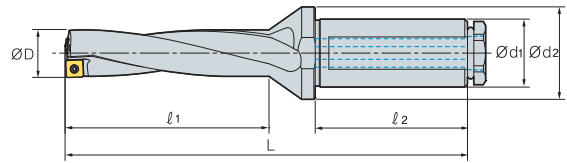
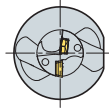
(mm)

Designation	ØD	Ød <sub>1</sub>	Ød <sub>2</sub>	l <sub>1</sub>	l <sub>2</sub>	L	Insert	Screw	Wrench	
<b>K3D</b>	<b>13020HP-04</b>	13.0	20	25	42	50	106	SP□T040204-□□ XO□T040204-□□	FTNA0204	TW06P
	<b>13520HP-04</b>	13.5	20	25	42	50	106			
	<b>14020HP-05</b>	14.0	20	25	45	50	110			
	<b>14520HP-05</b>	14.5	20	25	45	50	110			
	<b>15020HP-05</b>	15.0	20	25	48	50	114	SP□T050204-□□ XO□T050204-□□	FTNA0204	TW06P
	<b>15520HP-05</b>	15.5	20	25	48	50	114			
	<b>16020HP-05</b>	16.0	20	25	51	50	117			
	<b>16525HP-06</b>	16.5	25	34	51	56	123			
	<b>17025HP-06</b>	17.0	25	34	54	56	126			
	<b>17525HP-06</b>	17.5	25	34	54	56	126			
	<b>18025HP-06</b>	18.0	25	34	57	56	130	SP□T060205-□□ XO□T060204-□□	FTKA02206S	TW07P
	<b>18525HP-06</b>	18.5	25	34	57	56	130			
	<b>19025HP-06</b>	19.0	25	34	60	56	133			
	<b>19525HP-06</b>	19.5	25	34	60	56	133			
	<b>20025HP-07</b>	20.0	25	34	63	56	138			
	<b>20525HP-07</b>	20.5	25	34	63	56	138			
	<b>21025HP-07</b>	21.0	25	34	66	56	141			
	<b>21525HP-07</b>	21.5	25	34	66	56	141	SP□T07T208-□□ XO□T07T205-□□	FTKA02565	TW07S
	<b>22025HP-07</b>	22.0	25	34	69	56	144			
	<b>22525HP-07</b>	22.5	25	34	69	56	144			
	<b>23025HP-07</b>	23.0	25	34	72	56	149			
	<b>23525HP-07</b>	23.5	25	34	72	56	149			
	<b>24032HP-09</b>	24.0	32	44	75	60	157			
	<b>24532HP-09</b>	24.5	32	44	75	60	157			
	<b>25032HP-09</b>	25.0	32	44	78	60	160			
	<b>25532HP-09</b>	25.5	32	44	78	60	160			
	<b>26032HP-09</b>	26.0	32	44	81	60	163			
	<b>26532HP-09</b>	26.5	32	44	81	60	163	SP□T090308-□□ XO□T090305-□□	FTKA0307	TW09S
	<b>27032HP-09</b>	27.0	32	44	84	60	167			
	<b>27532HP-09</b>	27.5	32	44	84	60	167			
<b>28032HP-09</b>	28.0	32	44	87	60	171				
<b>28532HP-09</b>	28.5	32	44	87	60	171				
<b>29032HP-09</b>	29.0	32	44	90	60	174				
<b>29532HP-09</b>	29.5	32	44	90	60	174				

Applicable inserts **F03-04**

## King Drill (4D)

For through coolant system with a lathe



(mm)

Designation	ØD	Ød <sub>1</sub>	Ød <sub>2</sub>	l <sub>1</sub>	l <sub>2</sub>	L	Insert	Screw	Wrench	
<b>K4D</b>	<b>13020HP-04</b>	13.0	20	25	55	50	119	SP□T040204-□□	FTNA0204	TW06P
	<b>13520HP-04</b>	13.5	20	25	55	50	119	XO□T040204-□□		
	<b>14020HP-05</b>	14.0	20	25	59	50	124	SP□T050204-□□	FTNA0204	TW06P
	<b>15020HP-05</b>	15.0	20	25	63	50	129	XO□T050204-□□		
	<b>16020HP-05</b>	16.0	20	25	67	50	133			
	<b>17025HP-06</b>	17.0	25	34	71	56	143	SP□T060205-□□	FTKA02206S	TW07P
	<b>18025HP-06</b>	18.0	25	34	75	56	148	XO□T060204-□□		
	<b>19025HP-06</b>	19.0	25	34	79	56	152			
	<b>20025HP-07</b>	20.0	25	34	83	56	158			
	<b>21025HP-07</b>	21.0	25	34	87	56	162	SP□T07T208-□□	FTKA02565	TW07S
	<b>22025HP-07</b>	22.0	25	34	91	56	166	XO□T07T205-□□		
	<b>23025HP-07</b>	23.0	25	34	95	56	172			
	<b>24032HP-09</b>	24.0	32	44	99	60	181			
	<b>25032HP-09</b>	25.0	32	44	103	60	185			
	<b>26032HP-09</b>	26.0	32	44	107	60	189	SP□T090308-□□	FTKA0307	TW09S
	<b>27032HP-09</b>	27.0	32	44	111	60	194	XO□T090305-□□		
	<b>28032HP-09</b>	28.0	32	44	115	60	199			
	<b>29032HP-09</b>	29.0	32	44	119	60	203			

↻ Applicable inserts **F03-04**

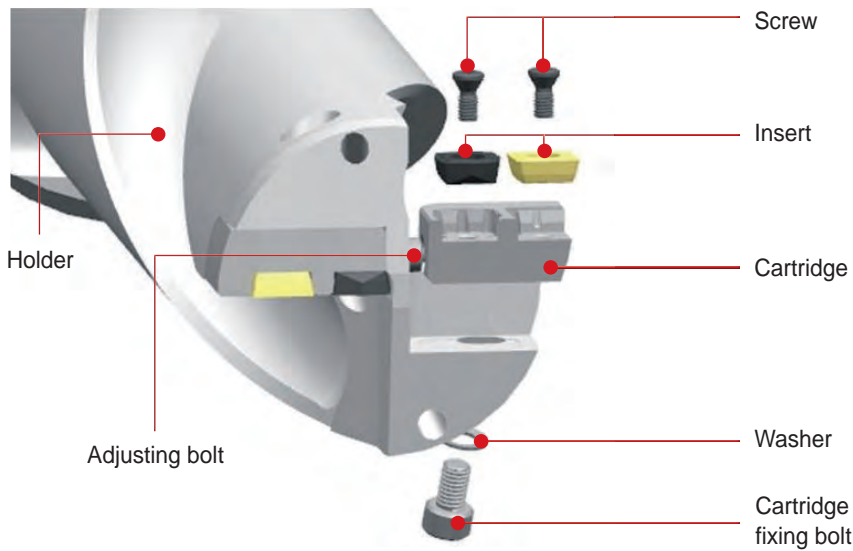
# F Technical Information for King Drill (For large diameter drilling)

High rigidity drill produces cost efficiency due to cartridge replacement

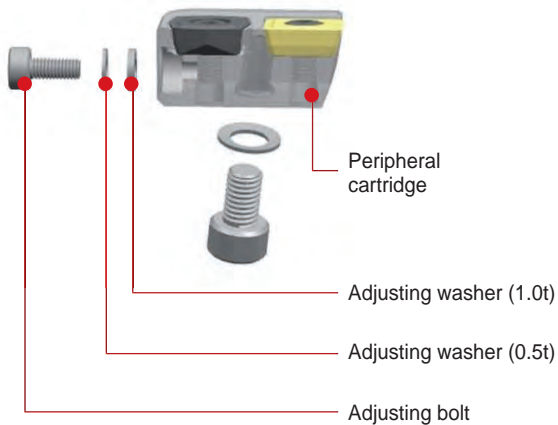
## King Drill (For large diameter drilling)

- Cartridge type for  $\text{Ø}61\sim\text{Ø}100$  drilling
- Peripheral cartridge can adjust the drilling diameter within 5 mm
- Easy to adjust drilling diameter with adjusting bolt

### Structure of King Drill (for large diameter) parts



### Adjustment of drill diameter

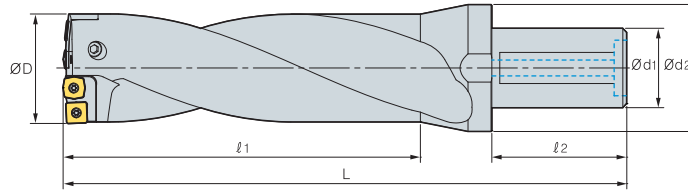


Adjustment Ø (mm)	Adjusting washer	
	Designation	Width (mm)
1	WA0305	0.5
2	WA0310	1.0
3	WA0305 + WA0310	1.5
4	WA0310 x 2	2.0
5	WA0305 + WA0310 x 2	2.5

※ Adjusting washer adjusts the drilling diameter within 5 mm



## King Drill



Designation	ØD	Ød <sub>1</sub>	Ød <sub>2</sub>	ℓ <sub>1</sub>	ℓ <sub>2</sub>	L	Cartridge		Screw	Wrench	
							Internal	External			
<b>K2D</b>	<b>616550-11</b>	61-65	50	80	130	80	255	KDC6165C	KDC6165P	FTKA03508	TW15S
	<b>657050-13</b>	65-70	50	88	140	80	265	KDC6570C	KDC6570P	FTKA0410	TW15S
	<b>707550-13</b>	70-75	50	88	150	80	275	KDC7075C	KDC7075P	FTKA0410	TW15S
	<b>758050-13</b>	75-80	50	88	160	80	285	KDC7580C	KDC7580P	FTKA0410	TW15S
	<b>808550-15</b>	80-85	50	88	170	80	295	KDC8085C	KDC8085P	FTNC04511	TW20S
	<b>859050-15</b>	85-90	50	95	180	80	305	KDC8590C	KDC8590P	FTNC04511	TW20S
	<b>909550-15</b>	90-95	50	95	190	80	315	KDC9095C	KDC9095P	FTNC04511	TW20S
	<b>9510050-18</b>	95-100	50	95	200	80	325	KDC95100C	KDC95100P	FTNA0511	TW20-100
<b>K3D</b>	<b>616550-11</b>	61-65	50	80	195	80	320	KDC6165C	KDC6165P	FTKA03508	TW15S
	<b>657050-13</b>	65-70	50	88	210	80	335	KDC6570C	KDC6570P	FTKA0410	TW15S
	<b>707550-13</b>	70-75	50	88	225	80	350	KDC7075C	KDC7075P	FTKA0410	TW15S
	<b>758050-13</b>	75-80	50	88	240	80	365	KDC7580C	KDC7580P	FTKA0410	TW15S
	<b>808550-15</b>	80-85	50	88	255	80	380	KDC8085C	KDC8085P	FTNC04511	TW20S
	<b>859050-15</b>	85-90	50	95	270	80	395	KDC8590C	KDC8590P	FTNC04511	TW20S
	<b>909550-15</b>	90-95	50	95	285	80	410	KDC9095C	KDC9095P	FTNC04511	TW20S
	<b>9510050-18</b>	95-100	50	95	300	80	425	KDC95100C	KDC95100P	FTNA0511	TW20-100
<b>K4D</b>	<b>616550-11</b>	61-65	50	80	260	80	385	KDC6165C	KDC6165P	FTKA03508	TW15S
	<b>657050-13</b>	65-70	50	88	280	80	405	KDC6570C	KDC6570P	FTKA0410	TW15S
	<b>707550-13</b>	70-75	50	88	300	80	425	KDC7075C	KDC7075P	FTKA0410	TW15S
	<b>758050-13</b>	75-80	50	88	320	80	445	KDC7580C	KDC7580P	FTKA0410	TW15S
	<b>808550-15</b>	80-85	50	88	340	80	465	KDC8085C	KDC8085P	FTNC04511	TW20S
	<b>859050-15</b>	85-90	50	95	360	80	485	KDC8590C	KDC8590P	FTNC04511	TW20S
	<b>909550-15</b>	90-95	50	95	380	80	505	KDC9095C	KDC9095P	FTNC04511	TW20S
	<b>9510050-18</b>	95-100	50	95	400	80	525	KDC95100C	KDC95100P	FTNA0511	TW20-100

↻ Applicable inserts **F03-04**

### Parts

Cartridge		Range (Ø)	Insert				Screw	Wrench
Internal	External		Designation	Quantity	Designation	Quantity		
KDC6165C	KDC6165P	61-65	XO□T11T306-□□	2	SP□T11T308-□□	2	FTKA03508	TW15S
KDC6570C	KDC6570P	65-70	XO□T130406-□□	2	SP□T130410-□□	2	FTKA0410	TW15S
KDC7075C	KDC7075P	70-75	XO□T130406-□□	2	SP□T130410-□□	2	FTKA0410	TW15S
KDC7580C	KDC7580P	75-80	XO□T130406-□□	2	SP□T130410-□□	2	FTKA0410	TW15S
KDC8085C	KDC8085P	80-85	XO□T15M508-□□	2	SP□T15M510-□□	2	FTNC04511	TW20S
KDC8590C	KDC8590P	85-90	XO□T15M508-□□	2	SP□T15M510-□□	2	FTNC04511	TW20S
KDC9095C	KDC9095P	90-95	XO□T15M508-□□	2	SP□T15M510-□□	2	FTNC04511	TW20S
KDC95100C	KDC95100P	95-100	XO□T180508-□□	2	SP□T180510-□□	2	FTNA0511	TW20-100

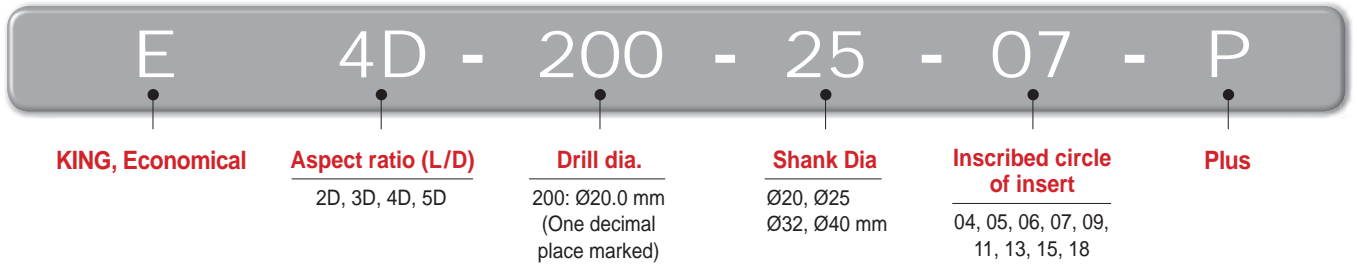
# F Technical Information for KED Plus Drill

KORLOY indexable new generation economical drill

## KED Plus Drill new

- Economical drill with good chip control due to optimal chip flute enlarging the space for chip flow
- Stable machining due to optimal shape and cutting edge arrangement of central and peripheral inserts

### Code system



### Features

- Excellent chip control for suitable cutting range with small diameters (Ø12-Ø23.5) due to the cutting fluid system and chip flute
- Excellent surface finish for suitable cutting range with medium to large diameters (Ø24-Ø60.5) due to widened chip pockets even in deep drilling
- Increased the rigidity of drill body and improved chip evacuation due to optimized shape of flute



### Features of chip breaker

- **Optimized design of inserts for maximum drilling efficiency**
  - Excellent cutting performance and chip control due to the optimized geometry and chip breaker of both inserts: central and peripheral
  - A set of differently shaped central and peripheral inserts optimizing the insert locations in order to maximize cutting tool life

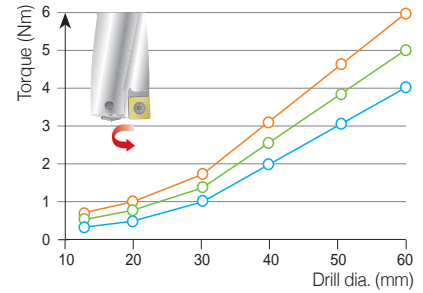
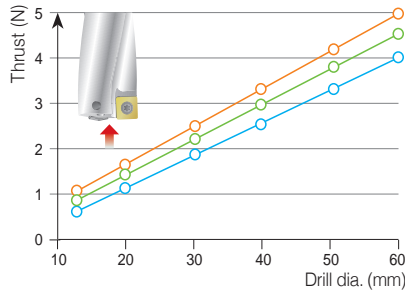
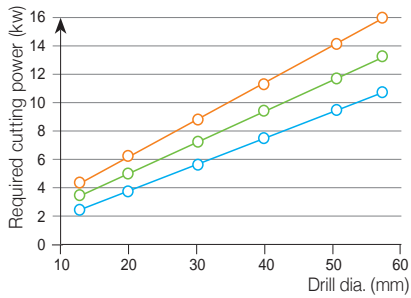
Chip breaker	PD		LD		ND		RD
<b>Features</b>	- Universal - At medium speed and medium feed		- Superior chip control for machining mild steel and stainless steel - Light cutting (at low~medium speed and low feed)		- Sharp cutting edge for aluminum machining - Insert surface buffed for high quality result - E Class Tolerance		- Improved chipping resistance - Excellent performance in case of frequent fracture and chipping on the cutting edge
<b>Insert</b>	Peripheral insert	Central insert	Peripheral insert	Central insert	Peripheral insert	Central insert	Central insert
<b>Shape</b>							
<b>Grades for workpiece</b>	NC5330: P, M, K PC3700: P PC5300: P, M, K, S PC6510: K PC9540: P, M, S		PC5335: P, M		H01: N		PC5300: P, M, K, S



## Required cutting power

- Workpiece SCM440 (240HB)
- Cutting conditions  $vc$  (m/min) = 100, Through coolant system

$f_n$  (mm/rev) = 0.13    $f_n$  (mm/rev) = 0.10    $f_n$  (mm/rev) = 0.07

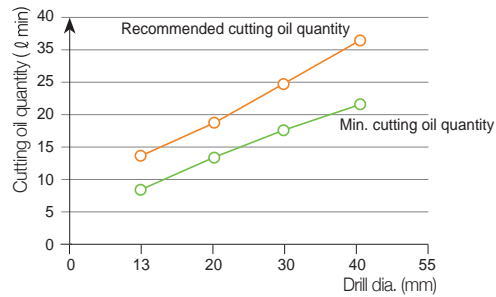


\* Cutting force shown as the above is base on drilling in facilities with enough rigidity and power

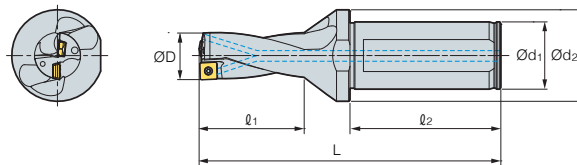
## Cutting oil quantity

- Workpiece SCM440 (240HB)
- Cutting conditions  $vc$  (m/min) = 100, Through coolant system

The data of the graph above could be changed depending on workpiece and cutting condition



## Drill tolerance and hole tolerance



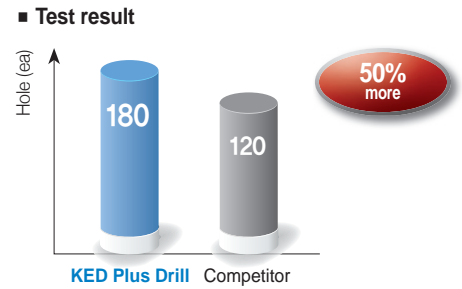
Drill dia.		Ø12~Ø29	Ø30~Ø45	Ø46~Ø60.5
2D~3D	Drill tolerance (ØD)	0~-0.15	0~-0.15	0~-0.15
	Hole tolerance	+0.2~-0.1	+0.25~-0.1	+0.28~-0.1
4D~5D	Drill tolerance (ØD)	0~-0.15	0~-0.15	0~-0.15
	Hole tolerance	+0.25~-0.05	+0.3~-0.05	+0.33~-0.05

(mm)

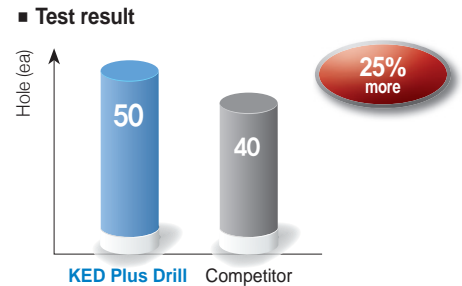
# F Technical Information for KED Plus Drill

## Application examples

- **Workpiece** Carbon steel (SM440)
- **Cutting conditions** vc (m/min) = 150, fn (mm/rev) = 0.1  
ap (mm) = 80 (through hole), wet
- **Tools** **Inserts** SPMT060205-PD (PC3700)  
XOMT060205-PD (PC5300)  
**Holder** E4D-18025-06-P  
(Drill dia. = Ø18 mm)



- **Workpiece** Stainless steel (STS316)
- **Cutting conditions** vc (m/min) = 120, fn (mm/rev) = 0.06  
ap (mm) = 42, wet
- **Tools** **Inserts** SPMT060205-PD (PC3700)  
XOMT060204-PD (PC3500)  
**Holder** E3D-18025-06-P  
(Drill dia. = Ø18 mm)



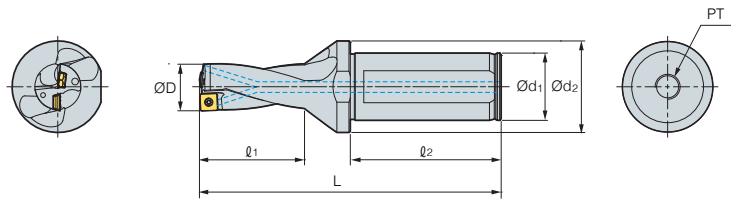
## Recommended cutting condition

Workpiece			Insert			vc (m/min)	Aspect ratio (L/D) = 2D, 3D, 4D					
ISO	Workpiece	Hardness (HB)	Chip breaker	Grade			Feed rate (mm/rev) per drill dia. (mm)					
				Central	Peripheral		Ø12~Ø16	Ø17~Ø23	Ø24~Ø29	Ø30~Ø42	Ø43~Ø60	
P	Carbon steel	80~180	LD	PC5335	PC5335	120 (60~170)	0.04~0.08	0.04~0.08	0.04~0.08	0.04~0.08	0.04~0.08	
			PD/RD	PC5300	PC3500	150 (120~180)						
					NC5330	180 (140~220)						
	High carbon steel	180~280	PD	PC5300	PC3500	120 (90~150)	0.04~0.10	0.04~0.12	0.05~0.16	0.06~0.16	0.06~0.18	
					NC5330	150 (110~190)	0.04~0.06	0.04~0.07	0.04~0.08	0.04~0.08	0.04~0.08	
						180 (140~210)	0.06~0.08	0.06~0.08	0.06~0.10	0.06~0.12	0.06~0.12	
Alloy steel	Low alloy steel	140~260	LD	PC5335	PC5335	120 (60~160)	0.06~0.10	0.06~0.10	0.06~0.12	0.06~0.14	0.06~0.14	
			PD	PC5300	PC3500	150 (120~170)	0.06~0.12	0.06~0.12	0.06~0.14	0.06~0.16	0.06~0.16	
	NC5330	180 (140~210)			0.06~0.08	0.06~0.08	0.06~0.10	0.06~0.12	0.06~0.12			
	PC5300	PC5300			100 (50~150)	0.04~0.10	0.06~0.10	0.06~0.12	0.06~0.14	0.06~0.14		
	High alloy steel	260~320	PD	PC5300	PC3500	100 (50~160)	0.05~0.11	0.05~0.11	0.05~0.13	0.05~0.15	0.05~0.15	
High alloy heat-treated steel	300~450	PD	PC5300	PC5300	70 (30~120)	0.04~0.08	0.06~0.08	0.06~0.10	0.06~0.12	0.06~0.12		
M	Stainless steel	135~275	LD	PD5335	PC5335	120 (80~140)	0.04~0.07	0.04~0.07	0.04~0.07	0.04~0.08	0.04~0.08	
			PD	PC5300	PC5300	130 (100~160)	0.04~0.07	0.04~0.07	0.04~0.07	0.04~0.08	0.04~0.08	
				PC9540	PC9540	90 (60~120)	0.04~0.07	0.04~0.07	0.04~0.07	0.04~0.08	0.04~0.08	
K	Cast iron	Gray cast iron	150~230	PD	PC5300	PC6510	190 (150~250)	0.04~0.12	0.05~0.14	0.06~0.18	0.10~0.22	0.10~0.26
		Ductile cast iron	150~230	PD	PC5300	PC6510	130 (100~160)	0.04~0.07	0.04~0.08	0.04~0.10	0.05~0.12	0.05~0.12
S	Heat resisting alloy	Ni-heat resisting alloy	130~400	PD	PC5300	PC5300	50 (30~100)	0.04~0.10	0.04~0.10	0.04~0.10	0.04~0.10	0.04~0.10
					PC9540	PC9540	40 (20~80)	0.04~0.10	0.04~0.10	0.04~0.10	0.04~0.10	0.04~0.10
		Ti-heat resisting alloy	130~400	LD	PC5335	PC5335	60 (40~80)	0.04~0.08	0.04~0.10	0.06~0.12	0.06~0.14	0.06~0.16
				PD	PC5300	PC5300	60 (40~80)	0.04~0.08	0.04~0.10	0.06~0.12	0.06~0.14	0.06~0.16
High hardened steel	over 400	PD	PC5300	PC5300	40 (20~80)	0.04~0.05	0.04~0.06	0.04~0.08	0.04~0.08	0.04~0.08		
N	Non-ferrous metal	Aluminium	30~150	ND	H01	H01	300 (250~400)	0.05~0.14	0.06~0.16	0.10~0.20	0.10~0.22	0.12~0.25
		Alloyed copper	150~160	ND	H01	H01	250 (200~300)	0.05~0.14	0.06~0.16	0.10~0.20	0.10~0.22	0.12~0.25

- The Max. feed of 5D holders is 70%~80% of the max. conditions of 2D/3D/4D holders
- In interrupted machining part, reduce 30~50% of feed from the above machining around interrupted part



# KED Plus Drill(2D)

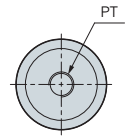
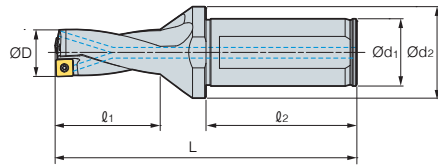
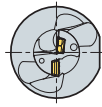


(mm)

Designation	ØD	Ød <sub>1</sub>	Ød <sub>2</sub>	l <sub>1</sub>	l <sub>2</sub>	L	PT	Insert	Screw	Wrench
<b>E2D-</b> 12020-04-P	12.0	20	25	27	50	91	1/8	SP□T040204-□□ XO□T040204-□□	FTNA0204	TW06P
12520-04-P	12.5	20	25	27	50	91				
13020-04-P	13.0	20	25	29	50	93				
13520-04-P	13.5	20	25	29	50	93				
14020-05-P	14.0	20	25	31	50	96				
14520-05-P	14.5	20	25	31	50	96				
15020-05-P	15.0	20	25	33	50	99				
15520-05-P	15.5	20	25	33	50	99				
16020-05-P	16.0	20	25	35	50	101				
16525-06-P	16.5	25	34	35	56	107				
17025-06-P	17.0	25	34	37	56	109				
17525-06-P	17.5	25	34	37	56	109				
18025-06-P	18.0	25	34	39	56	112				
18525-06-P	18.5	25	34	39	56	112				
19025-06-P	19.0	25	34	41	56	114				
19525-06-P	19.5	25	34	41	56	114				
20025-07-P	20.0	25	34	43	56	118				
20525-07-P	20.5	25	34	43	56	118				
21025-07-P	21.0	25	34	45	56	120				
21525-07-P	21.5	25	34	45	56	120				
22025-07-P	22.0	25	34	47	56	122				
22525-07-P	22.5	25	34	47	56	122				
23025-07-P	23.0	25	34	49	56	126				
23525-07-P	23.5	25	34	49	56	126				
24032-09-P	24.0	32	44	51	60	133				
24532-09-P	24.5	32	44	51	60	133				
25032-09-P	25.0	32	44	53	60	135				
25532-09-P	25.5	32	44	53	60	135				
26032-09-P	26.0	32	44	55	60	137				
26532-09-P	26.5	32	44	55	60	137				
27032-09-P	27.0	32	44	57	60	140				
27532-09-P	27.5	32	44	57	60	140				
28032-09-P	28.0	32	44	59	60	143				
28532-09-P	28.5	32	44	59	60	143				
29032-09-P	29.0	32	44	61	60	145				
29532-09-P	29.5	32	44	61	60	145				
30032-11-P	30.0	32	44	63	60	150				
30532-11-P	30.5	32	44	63	60	150				
31032-11-P	31.0	32	44	65	60	152				
31532-11-P	31.5	32	44	65	60	152				
32032-11-P	32.0	32	44	67	60	154				
32532-11-P	32.5	32	44	67	60	154				
33032-11-P	33.0	32	44	69	60	157				
33532-11-P	33.5	32	44	69	60	157				
34032-11-P	34.0	32	44	71	60	159				
34532-11-P	34.5	32	44	71	60	159				
35032-11-P	35.0	32	44	73	60	161				
35532-11-P	35.5	32	44	73	60	161				
							1/4	SP□T090308-□□ XO□T090305-□□	FTKA0307	TW09S
								SP□T11T308-□□ XO□T11T306-□□	FTKA03508	TW15S

↻ Applicable inserts F03-04

## KED Plus Drill(2D)



(mm)

Designation	ØD	Ød <sub>1</sub>	Ød <sub>2</sub>	l <sub>1</sub>	l <sub>2</sub>	L	PT	Insert	Screw	Wrench
<b>E2D-</b>										
36040-13-P	36.0	40	48	76	70	176	1/4	SP□T130410-□□ XO□T130406-□□	FTKA0410	TW15S
36540-13-P	36.5	40	48	76	70	176				
37040-13-P	37.0	40	48	78	70	178				
37540-13-P	37.5	40	48	78	70	178				
38040-13-P	38.0	40	48	80	70	181				
38540-13-P	38.5	40	48	80	70	181				
39040-13-P	39.0	40	48	82	70	183				
39540-13-P	39.5	40	48	82	70	183				
40040-13-P	40.0	40	48	84	70	186				
40540-13-P	40.5	40	48	84	70	186				
41040-13-P	41.0	40	48	86	70	188				
41540-13-P	41.5	40	48	86	70	188				
42040-13-P	42.0	40	48	88	70	191				
42540-13-P	42.5	40	48	88	70	191				
43040-15-P	43.0	40	58	91	70	196				
43540-15-P	43.5	40	58	91	70	196				
44040-15-P	44.0	40	58	93	70	198				
44540-15-P	44.5	40	58	93	70	198				
45040-15-P	45.0	40	58	95	70	201				
45540-15-P	45.5	40	58	95	70	201				
46040-15-P	46.0	40	58	97	70	203				
46540-15-P	46.5	40	58	97	70	203				
47040-15-P	47.0	40	58	99	70	206				
47540-15-P	47.5	40	58	99	70	206				
48040-15-P	48.0	40	58	101	70	208				
48540-15-P	48.5	40	58	101	70	208				
49040-15-P	49.0	40	58	103	70	210				
49540-15-P	49.5	40	58	103	70	210				
50040-15-P	50.0	40	58	105	70	212				
50540-15-P	50.5	40	58	105	70	212				
51040-18-P	51.0	40	68	108	70	218				
51540-18-P	51.5	40	68	108	70	218				
52040-18-P	52.0	40	68	110	70	220				
52540-18-P	52.5	40	68	110	70	220				
53040-18-P	53.0	40	68	112	70	222				
53540-18-P	53.5	40	68	112	70	222				
54040-18-P	54.0	40	68	114	70	224				
54540-18-P	54.5	40	68	114	70	224				
55040-18-P	55.0	40	68	116	70	226				
55540-18-P	55.5	40	68	116	70	226				
56040-18-P	56.0	40	68	118	70	230				
56540-18-P	56.5	40	68	118	70	230				
57040-18-P	57.0	40	68	121	70	233				
57540-18-P	57.5	40	68	121	70	233				
58040-18-P	58.0	40	68	124	70	236				
58540-18-P	58.5	40	68	124	70	236				
59040-18-P	59.0	40	68	127	70	239				
59540-18-P	59.5	40	68	127	70	239				
60040-18-P	60.0	40	68	130	70	242				
60540-18-P	60.5	40	68	130	70	242				
								SP□T180510-□□ XO□T180508-□□	FTNA0511	TW20-100

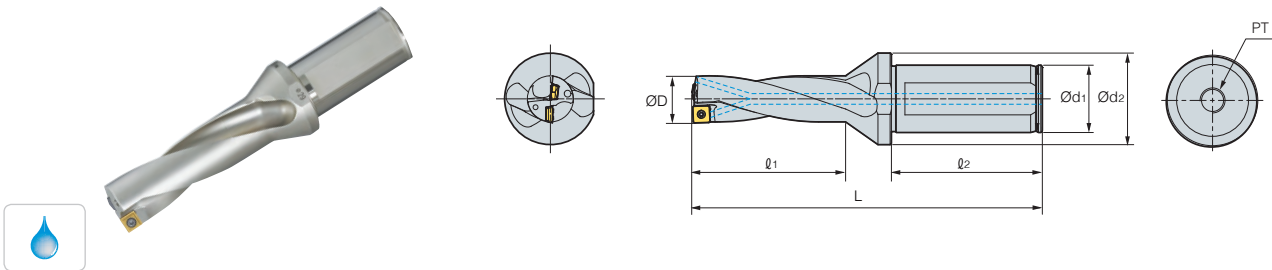
↻ Applicable inserts F03-04



F

Drills

# KED Plus Drill(3D)



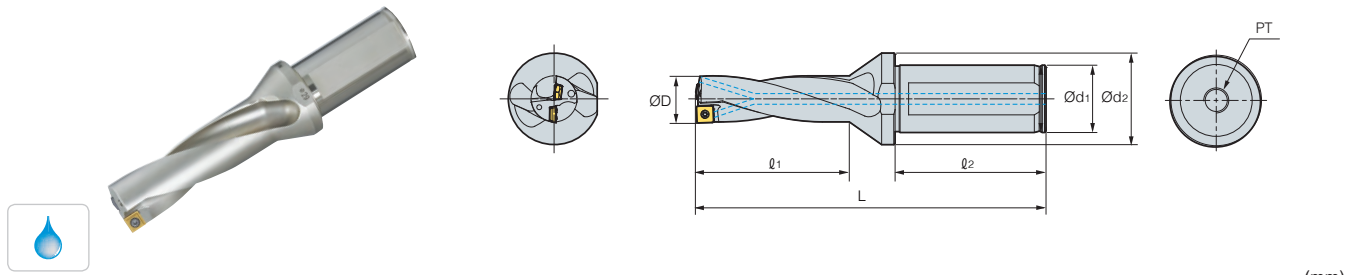
(mm)

Designation	ØD	Ød <sub>1</sub>	Ød <sub>2</sub>	l <sub>1</sub>	l <sub>2</sub>	L	PT	Insert	Screw	Wrench
<b>E3D-</b> 12020-04-P	12.0	20	25	39	50	103	1/8	SP□T040204-□□ XO□T040204-□□	FTNA0204	TW06P
12520-04-P	12.5	20	25	39	50	103				
13020-04-P	13.0	20	25	42	50	106				
13520-04-P	13.5	20	25	42	50	106				
14020-05-P	14.0	20	25	45	50	110				
14520-05-P	14.5	20	25	45	50	110		SP□T050204-□□ XO□T050204-□□	FTNA0204	TW06P
15020-05-P	15.0	20	25	48	50	114				
15520-05-P	15.5	20	25	48	50	114				
16020-05-P	16.0	20	25	51	50	117				
16525-06-P	16.5	25	34	51	56	123				
17025-06-P	17.0	25	34	54	56	126		SP□T060205-□□ XO□T060204-□□	FTKA02206S	TW07P
17525-06-P	17.5	25	34	54	56	126				
18025-06-P	18.0	25	34	57	56	130				
18525-06-P	18.5	25	34	57	56	130				
19025-06-P	19.0	25	34	60	56	133				
19525-06-P	19.5	25	34	60	56	133		SP□T07T208-□□ XO□T07T205-□□	FTKA02565	TW07S
20025-07-P	20.0	25	34	63	56	138				
20525-07-P	20.5	25	34	63	56	138				
21025-07-P	21.0	25	34	66	56	141				
21525-07-P	21.5	25	34	66	56	141				
22025-07-P	22.0	25	34	69	56	144	1/4	SP□T090308-□□ XO□T090305-□□	FTKA0307	TW09S
22525-07-P	22.5	25	34	69	56	144				
23025-07-P	23.0	25	34	72	56	149				
23525-07-P	23.5	25	34	72	56	149				
24032-09-P	24.0	32	44	75	60	157				
24532-09-P	24.5	32	44	75	60	157				
25032-09-P	25.0	32	44	78	60	160				
25532-09-P	25.5	32	44	78	60	160				
26032-09-P	26.0	32	44	81	60	163				
26532-09-P	26.5	32	44	81	60	163				
27032-09-P	27.0	32	44	84	60	167				
27532-09-P	27.5	32	44	84	60	167				
28032-09-P	28.0	32	44	87	60	171				
28532-09-P	28.5	32	44	87	60	171				
29032-09-P	29.0	32	44	90	60	174				
29532-09-P	29.5	32	44	90	60	174				
30032-11-P	30.0	32	44	93	60	180				
30532-11-P	30.5	32	44	93	60	180				
31032-11-P	31.0	32	44	96	60	183				
31532-11-P	31.5	32	44	96	60	183				
32032-11-P	32.0	32	44	99	60	186				
32532-11-P	32.5	32	44	99	60	186				
33032-11-P	33.0	32	44	102	60	190				
33532-11-P	33.5	32	44	102	60	190				
34032-11-P	34.0	32	44	105	60	193				
34532-11-P	34.5	32	44	105	60	193				
35032-11-P	35.0	32	44	108	60	196				
35532-11-P	35.5	32	44	108	60	196				
								SP□T11T308-□□ XO□T11T306-□□	FTKA03508	TW15S

↻ Applicable inserts F03-04



# KED Plus Drill(3D)

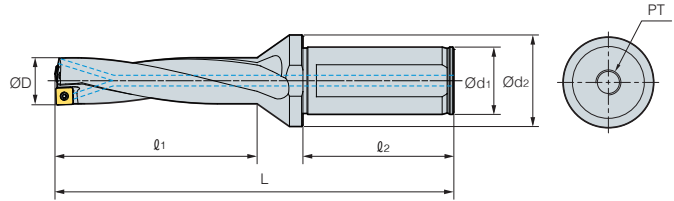
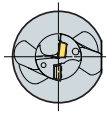


Designation		ØD	Ød <sub>1</sub>	Ød <sub>2</sub>	l <sub>1</sub>	l <sub>2</sub>	L	PT	Insert	Screw	Wrench
E3D-	36040-13-P	36.0	40	48	112	70	212	1/4	SP□T130410-□□ XO□T130406-□□	FTKA0410	TW15S
	36540-13-P	36.5	40	48	112	70	212				
	37040-13-P	37.0	40	48	115	70	215				
	37540-13-P	37.5	40	48	115	70	215				
	38040-13-P	38.0	40	48	118	70	219				
	38540-13-P	38.5	40	48	118	70	219				
	39040-13-P	39.0	40	48	121	70	222				
	39540-13-P	39.5	40	48	121	70	222				
	40040-13-P	40.0	40	48	124	70	226				
	40540-13-P	40.5	40	48	124	70	226				
	41040-13-P	41.0	40	48	127	70	229				
	41540-13-P	41.5	40	48	127	70	229				
	42040-13-P	42.0	40	48	130	70	233				
	42540-13-P	42.5	40	48	130	70	233				
	43040-15-P	43.0	40	58	134	70	239				
	43540-15-P	43.5	40	58	134	70	239				
	44040-15-P	44.0	40	58	137	70	242				
	44540-15-P	44.5	40	58	137	70	242				
	45040-15-P	45.0	40	58	140	70	246				
	45540-15-P	45.5	40	58	140	70	246				
	46040-15-P	46.0	40	58	143	70	249				
	46540-15-P	46.5	40	58	143	70	249				
	47040-15-P	47.0	40	58	146	70	253				
	47540-15-P	47.5	40	58	146	70	253				
	48040-15-P	48.0	40	58	149	70	256				
	48540-15-P	48.5	40	58	149	70	256				
	49040-15-P	49.0	40	58	152	70	259				
	49540-15-P	49.5	40	58	152	70	259				
	50040-15-P	50.0	40	58	155	70	262				
	50540-15-P	50.5	40	58	155	70	262				
	51040-18-P	51.0	40	68	159	70	269				
	51540-18-P	51.5	40	68	159	70	269				
	52040-18-P	52.0	40	68	162	70	272				
52540-18-P	52.5	40	68	162	70	272					
53040-18-P	53.0	40	68	165	70	275					
53540-18-P	53.5	40	68	165	70	275					
54040-18-P	54.0	40	68	168	70	278					
54540-18-P	54.5	40	68	168	70	278					
55040-18-P	55.0	40	68	171	70	281					
55540-18-P	55.5	40	68	171	70	281					
56040-18-P	56.0	40	68	174	70	286					
56540-18-P	56.5	40	68	174	70	286					
57040-18-P	57.0	40	68	178	70	290					
57540-18-P	57.5	40	68	178	70	290					
58040-18-P	58.0	40	68	182	70	294					
58540-18-P	58.5	40	68	182	70	294					
59040-18-P	59.0	40	68	186	70	298					
59540-18-P	59.5	40	68	186	70	298					
60040-18-P	60.0	40	68	190	70	302					
60540-18-P	60.5	40	68	190	70	302					
									SP□T180510-□□ XO□T180508-□□	FTNA0511	TW20-100



↻ Applicable inserts F03-04



# KED Plus Drill(4D)

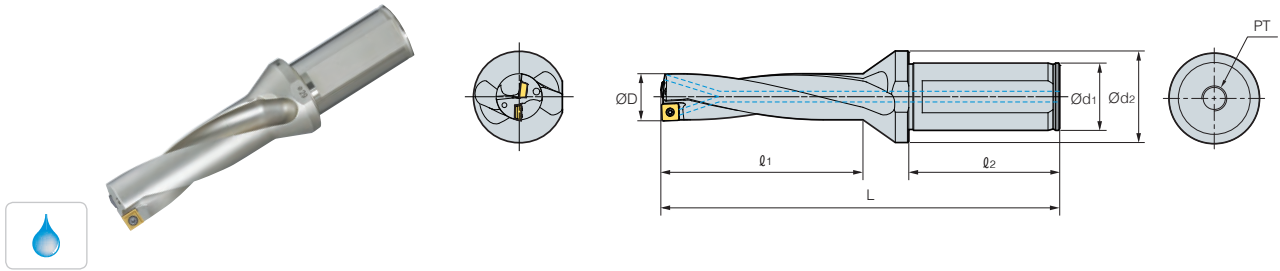


(mm)

Designation	ØD	Ød <sub>1</sub>	Ød <sub>2</sub>	l <sub>1</sub>	l <sub>2</sub>	L	PT	Insert	Screw 	Wrench 
<b>E4D-</b> 12020-04-P	12.0	20	25	51	50	115	1/8	SP□T040204-□□ XO□T040204-□□	FTNA0204	TW06P
12520-04-P	12.5	20	25	51	50	115				
13020-04-P	13.0	20	25	55	50	119				
13520-04-P	13.5	20	25	55	50	119				
14020-05-P	14.0	20	25	59	50	124				
14520-05-P	14.5	20	25	59	50	124		SP□T050204-□□ XO□T050204-□□		
15020-05-P	15.0	20	25	63	50	129				
15520-05-P	15.5	20	25	63	50	129				
16020-05-P	16.0	20	25	67	50	133				
16525-06-P	16.5	25	34	67	56	139				
17025-06-P	17.0	25	34	71	56	143		SP□T060205-□□ XO□T060204-□□		
17525-06-P	17.5	25	34	71	56	143				
18025-06-P	18.0	25	34	75	56	148				
18525-06-P	18.5	25	34	75	56	148				
19025-06-P	19.0	25	34	79	56	152				
19525-06-P	19.5	25	34	79	56	152		SP□T07T208-□□ XO□T07T205-□□		
20025-07-P	20.0	25	34	83	56	158				
20525-07-P	20.5	25	34	83	56	158				
21025-07-P	21.0	25	34	87	56	162				
21525-07-P	21.5	25	34	87	56	162				
22025-07-P	22.0	25	34	91	56	166	SP□T090308-□□ XO□T090305-□□			
22525-07-P	22.5	25	34	91	56	166				
23025-07-P	23.0	25	34	95	56	172				
23525-07-P	23.5	25	34	95	56	172				
24032-09-P	24.0	32	44	99	60	181				
24532-09-P	24.5	32	44	99	60	181				
25032-09-P	25.0	32	44	103	60	185				
25532-09-P	25.5	32	44	103	60	185				
26032-09-P	26.0	32	44	107	60	189				
26532-09-P	26.5	32	44	107	60	189				
27032-09-P	27.0	32	44	111	60	194				
27532-09-P	27.5	32	44	111	60	194				
28032-09-P	28.0	32	44	115	60	199				
28532-09-P	28.5	32	44	115	60	199				
29032-09-P	29.0	32	44	119	60	203				
29532-09-P	29.5	32	44	119	60	203	SP□T11T308-□□ XO□T11T306-□□			
30032-11-P	30.0	32	44	123	60	210				
30532-11-P	30.5	32	44	123	60	210				
31032-11-P	31.0	32	44	127	60	214				
31532-11-P	31.5	32	44	127	60	214				
32032-11-P	32.0	32	44	131	60	218				
32532-11-P	32.5	32	44	131	60	218				
33032-11-P	33.0	32	44	135	60	223				
33532-11-P	33.5	32	44	135	60	223				
34032-11-P	34.0	32	44	139	60	227				
34532-11-P	34.5	32	44	139	60	227				
35032-11-P	35.0	32	44	143	60	231				
35532-11-P	35.5	32	44	143	60	231				

↻ Applicable inserts F03-04

# KED Plus Drill(4D)



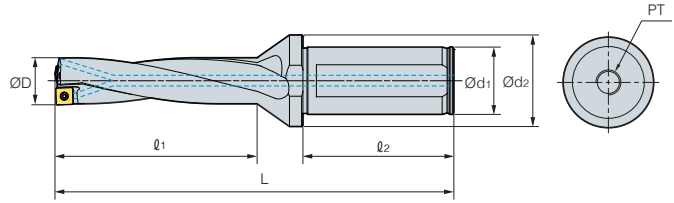
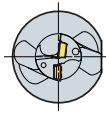
(mm)

Designation	ØD	Ød <sub>1</sub>	Ød <sub>2</sub>	l <sub>1</sub>	l <sub>2</sub>	L	PT	Insert	Screw	Wrench
<b>E4D-</b>										
36040-13-P	36.0	40	48	148	70	248	1/4	SP□T130410-□□ XO□T130406-□□	FTKA0410	TW15S
36540-13-P	36.5	40	48	148	70	248				
37040-13-P	37.0	40	48	152	70	252				
37540-13-P	37.5	40	48	152	70	252				
38040-13-P	38.0	40	48	156	70	257				
38540-13-P	38.5	40	48	156	70	257				
39040-13-P	39.0	40	48	160	70	261				
39540-13-P	39.5	40	48	160	70	261				
40040-13-P	40.0	40	48	164	70	266				
40540-13-P	40.5	40	48	164	70	266				
41040-13-P	41.0	40	48	168	70	270				
41540-13-P	41.5	40	48	168	70	270				
42040-13-P	42.0	40	48	172	70	275				
42540-13-P	42.5	40	48	172	70	275				
43040-15-P	43.0	40	58	177	70	282				
43540-15-P	43.5	40	58	177	70	282				
44040-15-P	44.0	40	58	181	70	286				
44540-15-P	44.5	40	58	181	70	286				
45040-15-P	45.0	40	58	185	70	291				
45540-15-P	45.5	40	58	185	70	291				
46040-15-P	46.0	40	58	189	70	295				
46540-15-P	46.5	40	58	189	70	295				
47040-15-P	47.0	40	58	193	70	300				
47540-15-P	47.5	40	58	193	70	300				
48040-15-P	48.0	40	58	197	70	304				
48540-15-P	48.5	40	58	197	70	304				
49040-15-P	49.0	40	58	201	70	308				
49540-15-P	49.5	40	58	201	70	308				
50040-15-P	50.0	40	58	205	70	312				
50540-15-P	50.5	40	58	205	70	312				
51040-18-P	51.0	40	68	210	70	320				
51540-18-P	51.5	40	68	210	70	320				
52040-18-P	52.0	40	68	214	70	324				
52540-18-P	52.5	40	68	214	70	324				
53040-18-P	53.0	40	68	218	70	328				
53540-18-P	53.5	40	68	218	70	328				
54040-18-P	54.0	40	68	222	70	332				
54540-18-P	54.5	40	68	222	70	332				
55040-18-P	55.0	40	68	226	70	336				
55540-18-P	55.5	40	68	226	70	336				
56040-18-P	56.0	40	68	230	70	342				
56540-18-P	56.5	40	68	230	70	342				
57040-18-P	57.0	40	68	235	70	347				
57540-18-P	57.5	40	68	235	70	347				
58040-18-P	58.0	40	68	240	70	352				
58540-18-P	58.5	40	68	240	70	352				
59040-18-P	59.0	40	68	245	70	357				
59540-18-P	59.5	40	68	245	70	357				
60040-18-P	60.0	40	68	250	70	362				
60540-18-P	60.5	40	68	250	70	362				
								SP□T180510-□□ XO□T180508-□□	FTNA0511	TW20-100

↻ Applicable inserts F03-04



# KED Plus Drill(5D)

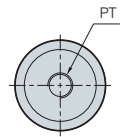
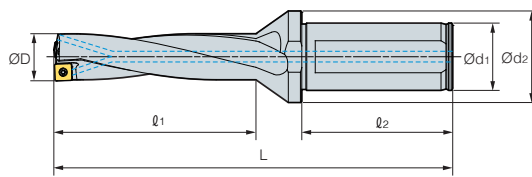
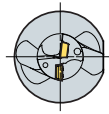


(mm)

Designation	ØD	Ød <sub>1</sub>	Ød <sub>2</sub>	l <sub>1</sub>	l <sub>2</sub>	L	PT	Insert	Screw	Wrench
<b>E5D-</b> 12020-04-P	12.0	20	25	63	50	127	1/8	SP□T040204-□□ XO□T040204-□□	FTNA0204	TW06P
12520-04-P	12.5	20	25	63	50	127				
13020-04-P	13.0	20	25	68	50	132				
13520-04-P	13.5	20	25	68	50	132				
14020-05-P	14.0	20	25	73	50	138				
14520-05-P	14.5	20	25	73	50	138		SP□T050204-□□ XO□T050204-□□	FTNA0204	TW06P
15020-05-P	15.0	20	25	78	50	144				
15520-05-P	15.5	20	25	78	50	144				
16020-05-P	16.0	20	25	83	50	149				
16525-06-P	16.5	25	34	83	56	155				
17025-06-P	17.0	25	34	88	56	160		SP□T060205-□□ XO□T060204-□□	FTKA02206S	TW07P
17525-06-P	17.5	25	34	88	56	160				
18025-06-P	18.0	25	34	93	56	166				
18525-06-P	18.5	25	34	93	56	166				
19025-06-P	19.0	25	34	98	56	171				
19525-06-P	19.5	25	34	98	56	171		SP□T07T208-□□ XO□T07T205-□□	FTKA02565	TW07S
20025-07-P	20.0	25	34	103	56	178				
20525-07-P	20.5	25	34	103	56	178				
21025-07-P	21.0	25	34	108	56	183				
21525-07-P	21.5	25	34	108	56	183				
22025-07-P	22.0	25	34	113	56	188	1/4	SP□T090308-□□ XO□T090305-□□	FTKA0307	TW09S
22525-07-P	22.5	25	34	113	56	188				
23025-07-P	23.0	25	34	118	56	195				
23525-07-P	23.5	25	34	118	56	195				
24032-09-P	24.0	32	44	123	60	205				
24532-09-P	24.5	32	44	123	60	205				
25032-09-P	25.0	32	44	128	60	210				
25532-09-P	25.5	32	44	128	60	210				
26032-09-P	26.0	32	44	133	60	215				
26532-09-P	26.5	32	44	133	60	215				
27032-09-P	27.0	32	44	138	60	221				
27532-09-P	27.5	32	44	138	60	221				
28032-09-P	28.0	32	44	143	60	227				
28532-09-P	28.5	32	44	143	60	227				
29032-09-P	29.0	32	44	148	60	232				
29532-09-P	29.5	32	44	148	60	232				
30032-11-P	30.0	32	44	153	60	240				
30532-11-P	30.5	32	44	153	60	240				
31032-11-P	31.0	32	44	158	60	245				
31532-11-P	31.5	32	44	158	60	245				
32032-11-P	32.0	32	44	163	60	250				
32532-11-P	32.5	32	44	163	60	250				
33032-11-P	33.0	32	44	168	60	256				
33532-11-P	33.5	32	44	168	60	256				
34032-11-P	34.0	32	44	173	60	261				
34532-11-P	34.5	32	44	173	60	261				
35032-11-P	35.0	32	44	178	60	266				
35532-11-P	35.5	32	44	178	60	266				
								SP□T11T308-□□ XO□T11T306-□□	FTKA03508	TW15S

↻ Applicable inserts F03-04

# KED Plus Drill(5D)



(mm)

Designation	ØD	Ød <sub>1</sub>	Ød <sub>2</sub>	l <sub>1</sub>	l <sub>2</sub>	L	PT	Insert	Screw	Wrench
<b>E5D-</b> 36040-13-P	36.0	40	48	184	70	284	1/4	SP□T130410-□□ XO□T130406-□□	FTKA0410	TW15S
36540-13-P	36.5	40	48	184	70	284				
37040-13-P	37.0	40	48	189	70	289				
37540-13-P	37.5	40	48	189	70	289				
38040-13-P	38.0	40	48	194	70	295				
38540-13-P	38.5	40	48	194	70	295				
39040-13-P	39.0	40	48	199	70	300				
39540-13-P	39.5	40	48	199	70	300				
40040-13-P	40.0	40	48	204	70	306				
40540-13-P	40.5	40	48	204	70	306				
41040-13-P	41.0	40	48	209	70	311				
41540-13-P	41.5	40	48	209	70	311				
42040-13-P	42.0	40	48	214	70	317				
42540-13-P	42.5	40	48	214	70	317				
43040-15-P	43.0	40	58	220	70	325				
43540-15-P	43.5	40	58	221	70	326				
44040-15-P	44.0	40	58	225	70	330				
44540-15-P	44.5	40	58	225	70	330				
45040-15-P	45.0	40	58	230	70	336				
45540-15-P	45.5	40	58	230	70	336				
46040-15-P	46.0	40	58	235	70	341				
46540-15-P	46.5	40	58	235	70	341				
47040-15-P	47.0	40	58	240	70	347				
47540-15-P	47.5	40	58	240	70	347				
48040-15-P	48.0	40	58	245	70	352				
48540-15-P	48.5	40	58	245	70	352				
49040-15-P	49.0	40	58	250	70	357				
49540-15-P	49.5	40	58	250	70	357				
50040-15-P	50.0	40	58	255	70	362				
50540-15-P	50.5	40	58	255	70	362				
51040-18-P	51.0	40	68	261	70	371				
51540-18-P	51.5	40	68	261	70	371				
52040-18-P	52.0	40	68	266	70	376				
52540-18-P	52.5	40	68	266	70	376				
53040-18-P	53.0	40	68	271	70	381				
53540-18-P	53.5	40	68	271	70	381				
54040-18-P	54.0	40	68	276	70	386				
54540-18-P	54.5	40	68	276	70	386				
55040-18-P	55.0	40	68	281	70	391				
55540-18-P	55.5	40	68	281	70	391				
56040-18-P	56.0	40	68	286	70	398				
56540-18-P	56.5	40	68	286	70	398				
57040-18-P	57.0	40	68	292	70	404				
57540-18-P	57.5	40	68	292	70	404				
58040-18-P	58.0	40	68	298	70	410				
58540-18-P	58.5	40	68	298	70	410				
59040-18-P	59.0	40	68	304	70	416				
59540-18-P	59.5	40	68	304	70	416				
60040-18-P	60.0	40	68	310	70	422				
60540-18-P	60.5	40	68	310	70	422				
								SP□T180510-□□ XO□T180508-□□	FTNA0511	TW20-100

↻ Applicable inserts F03-04



High quality and high feed top solid indexable drill

## TPDC Plus Drill **new**

(TPDC-XP, CP, CM, CN, CP-FC)

- The optimal tool shape for drilling realizing high precision and high feed machining as of carbide solid drill performance level
- Usable for various machining through enlarged line-up by workpieces, depth of cuts and workpiece shapes

### Code system

#### • Insert

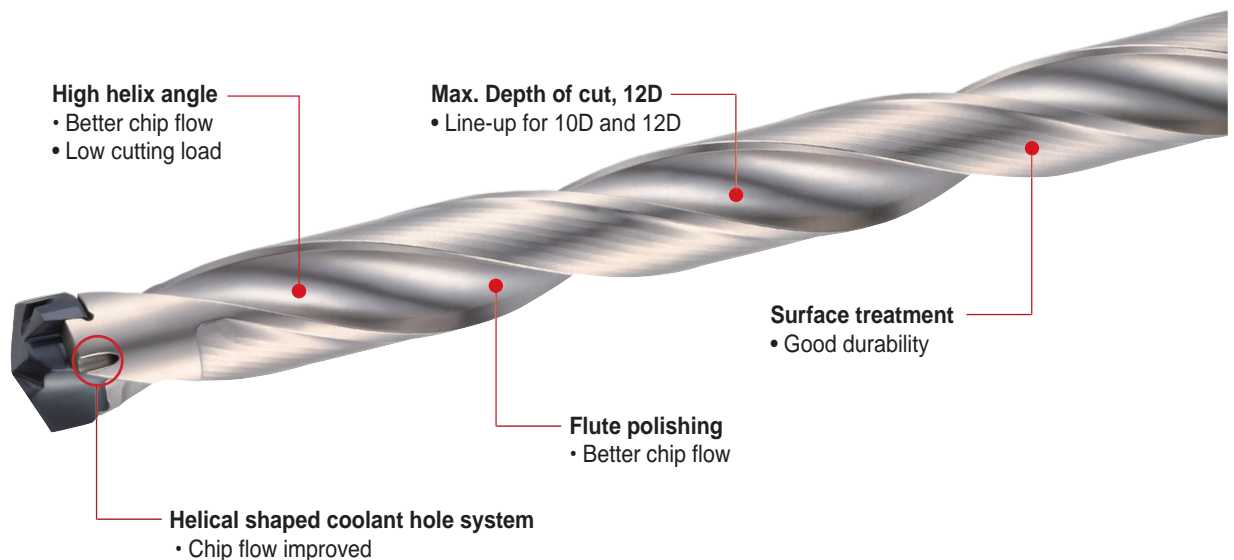
TPD	1500	C	P	-	□
<b>Top solid Piercing Drill</b>	<b>Drill dia.</b> 1500: Ø15.00 mm	<b>Insert type</b> X, C: Cone type	<b>Machining area</b> P: Steel and general M: Stainless steel K: Cast iron N: Non-ferrous metal		<b>Cutting edge</b> No code: Standard F: Flat FC: Flat Candle

#### • Holder

TPD	C	5D	-	150	20	-	75
<b>Top solid Piercing Drill</b>	<b>Insert type</b> X, C: Cone type	<b>Aspect ratio (L/D)</b> 1.5D, 3D, 5D 8D, 10D, 12D		<b>Drill dia.</b> 150: Ø15.00-Ø15.99 mm	<b>Shank dia.</b> 20: Ø20 mm		<b>Flute length</b> 75: 75 mm

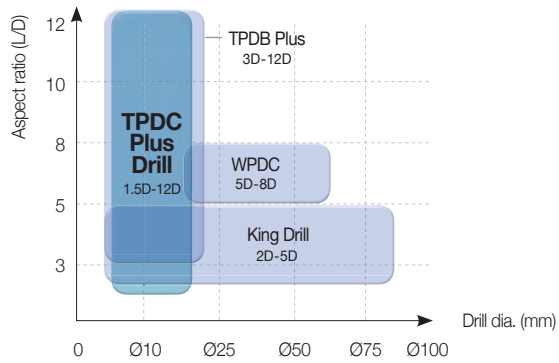
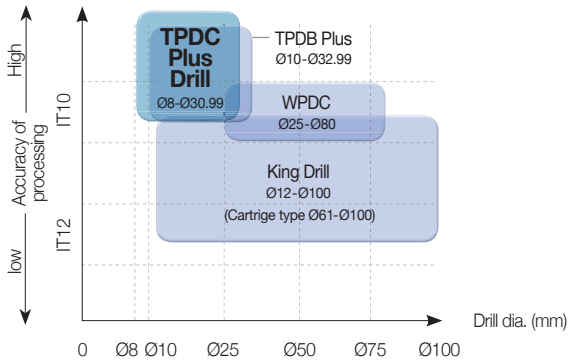
### Features

- One step clamp system - Increased stability and shortened setting time
- High helix angle and flute polishing - Reduced cutting load and enhanced chip evacuation
- Various applications from enlarged line-up by depth of cuts and shapes of workpiece



# F Technical Information for TPDC Plus Drill

## Application range



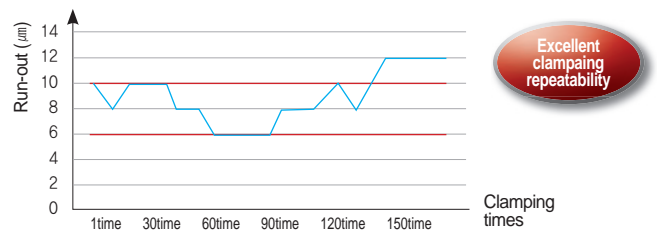
## Run-out

### Durability evaluation

- Workpiece** Alloy steel (SCM440, HRC22)
- Cutting conditions** vc (m/min) = 90, fn (mm/rev) = 0.25, ap (mm) = 60, wet (10bar)
- Tools** Insert TPD1500CP(PC5335), Holder TPDC5D-15020-75 (Drill dia. = Ø15 mm)

Long tool life with the setting run-out, lower than 15 µm after using 40 inserts

### Clamping repeatability evaluation

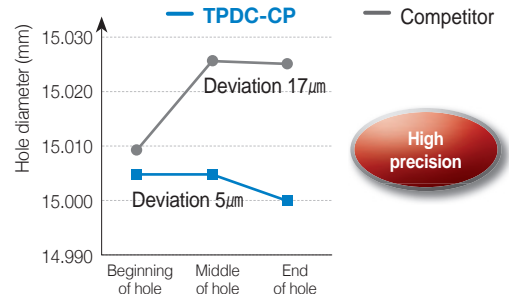
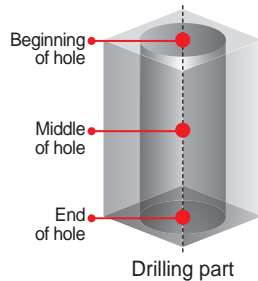


Excellent clamping system keeping the run-out, lower than 6 µm after clamping 150 times repeatedly

## Performance evaluation

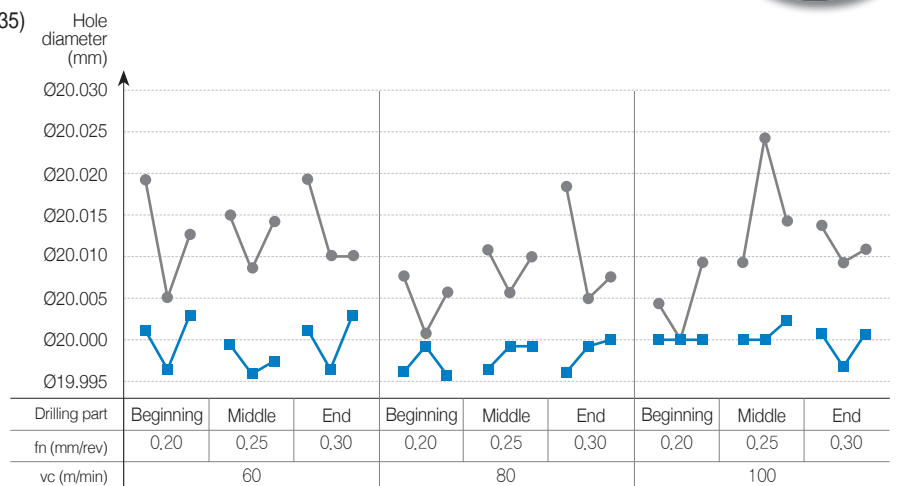
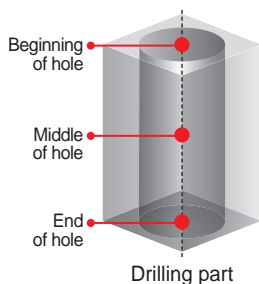
### Precision

- Workpiece** Carbon steel (SM45C, HRC19)
- Cutting conditions** vc (m/min) = 60, fn (mm/rev) = 0.2, ap (mm) = 150, wet (20bar)
- Tools** Insert TPD1500CP (PC5335), Holder TPDC12D-15020-170 (Drill dia. = Ø15 mm)



High precision in deep hole-making

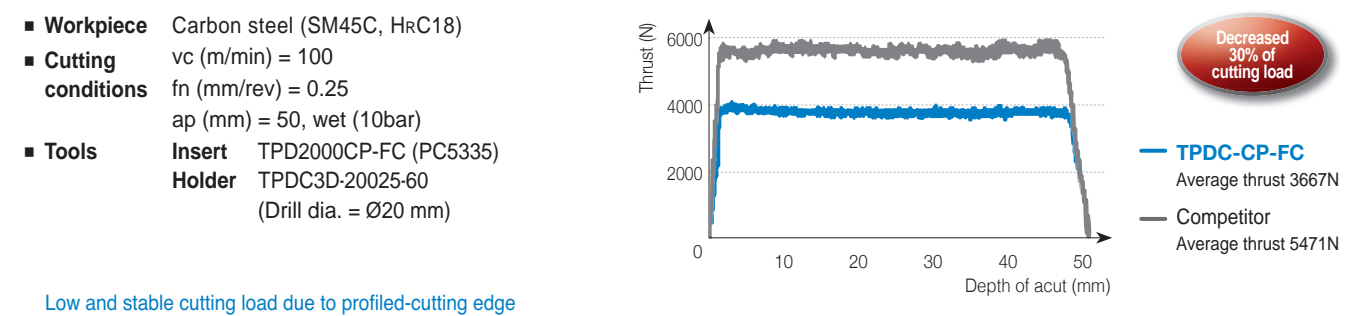
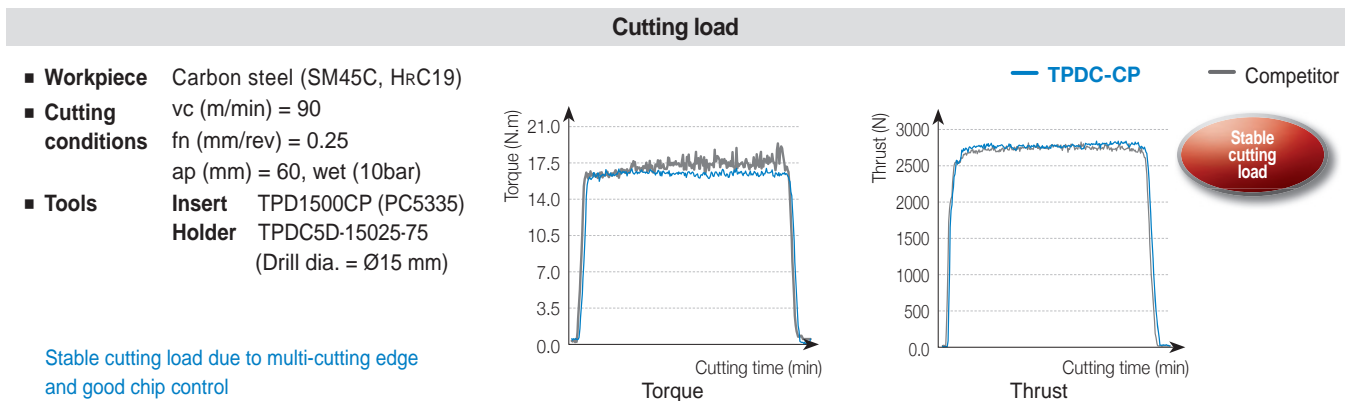
- Workpiece** Carbon steel (SM45C, HRC18)
- Cutting conditions** vc (m/min) = 60~100, fn (mm/rev) = 0.2~0.3, ap (mm) = 50, wet (20 bar)
- Tools** Insert TPD2000CP-FC (PC5335), Holder TPDC3D-20025-60 (Drill dia. = Ø20 mm)



High precision and excellent centering due to profiled cutting edge

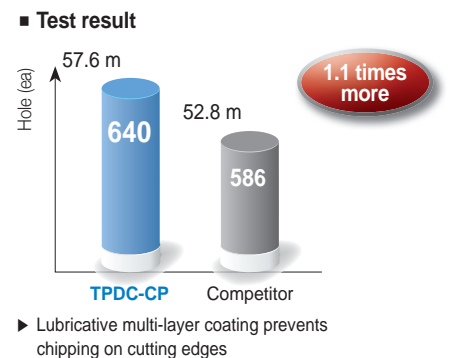
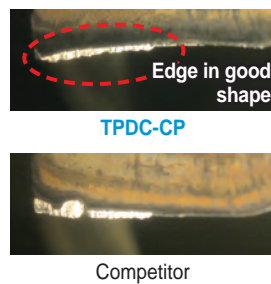


## Performance evaluation

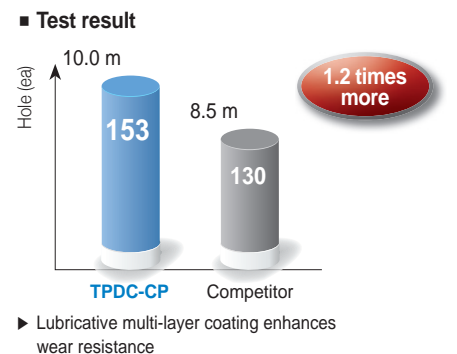
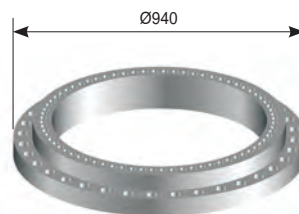


## Application examples

- Use** Part of machine
- Workpiece** Alloy steel (SCM440, HRC22)
- Cutting conditions**
  - vc (m/min) = 100
  - fn (mm/rev) = 0.3
  - ap (mm) = 90, wet
- Tools**
  - Insert** TPD1900CP (PC5335)
  - Holder** TPDC5D-19025-95 (Drill dia.(mm) = Ø19.0)



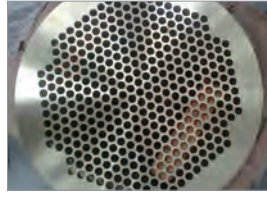
- Use** Part of machine
- Workpiece** Carbon steel (SM45C, HRC40)
- Cutting conditions**
  - vc (m/min) = 60
  - fn (mm/rev) = 0.15
  - ap (mm) = 65, wet
- Tools**
  - Insert** TPD1800CP (PC5335)
  - Holder** TPDC5D-18025-90 (Drill dia.(mm) = Ø18.0)



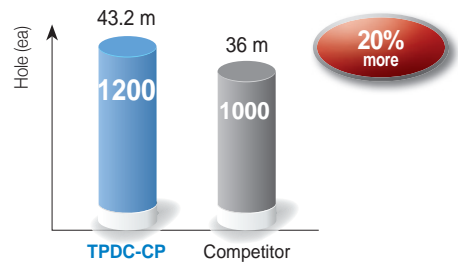
# F Technical Information for TPDC Plus Drill

## Application examples

- **Use** Tube sheet
- **Workpiece** Carbon steel (S235JR, HRC18)
- **Cutting conditions**
  - vc (m/min) = 85
  - n (rpm) = 1381
  - fn (mm/rev) = 0.27
  - ap (mm) = 12mm x 3Passes, wet
- **Tools**
  - Insert** TPD1960CP (PC330P)
  - Holder** TPDC3D-19025-57



### Test result

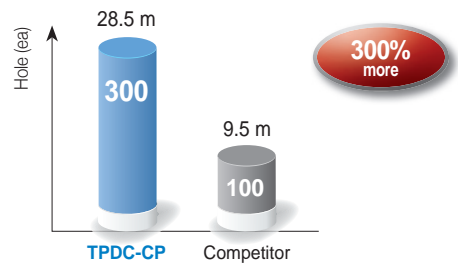


► Optimized cutting edge enhances wear resistance due to stable cutting load and lubricated multi-layer coating.

- **Use** Turret flange
- **Workpiece** Alloy steel (SCM440, HRC22)
- **Cutting conditions**
  - vc (m/min) = 82
  - n (rpm) = 2000
  - fn (mm/rev) = 0.2
  - ap (mm) = 95, wet
- **Tools**
  - Insert** TPD1300CP (PC5335)
  - Holder** TPDC8D-13016-104

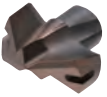
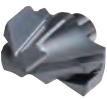
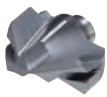
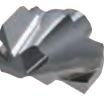
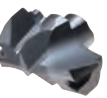


### Test result



► Lubricated multi-layer coating improving chipping resistance prevents chipping on the cutting edge.

## Insert features

Shape	Application	Drill dia. (mm)	Features
 XP <small>new</small>	<b>P</b>	Ø8.00~Ø11.99	<ul style="list-style-type: none"> <li>• High durability due to the strong clamping system</li> <li>• Excellent quality of machining and stable machining from high clamping force</li> <li>• Enhanced performance by high lubricated grade</li> </ul>
 CP	<b>P K</b>	Ø12.00~Ø30.99	<ul style="list-style-type: none"> <li>• High quality machining due to excellent centering: Good roundness and surface finish</li> <li>• Excellent chip control from exclusive edge design: Stable machining by good chip forming and chip evacuation</li> </ul>
 CM <small>new</small>	<b>M</b>	Ø12.00~Ø30.99	<ul style="list-style-type: none"> <li>• Ensuring strength of point and cutting edge: Stable machinability</li> <li>• Increased stability of machining due to low cutting load</li> <li>• Applied grade with high built up edge resistance and chipping resistance</li> </ul>
 CN <small>new</small>	<b>N</b>	Ø12.00~Ø30.99	<ul style="list-style-type: none"> <li>• Cutting edge with low cutting load: Excellent chip evacuation from increased surface finish of insert by special after treatment</li> <li>• Long tool life due to ultra-fine substrate application</li> </ul>
 CP-FC <small>new</small>	<b>P</b>	Ø12.00~Ø30.99	<ul style="list-style-type: none"> <li>• Cutting edge shape with excellent centering: Stable machinability from low cutting load</li> <li>• Available in various machining applications: Flat surface, angled surface, curved surface drilling, plunging and boring</li> <li>• Reduced cycle time by simplified tools: Endmill+drill machining → TPDC-CP-FC insert</li> </ul>



## How to clamp insert

### Using the improved wrench

- Using the insert with slot on the top (Use the improved inserts only)



1 Clean the mounting seat with air or cloth

2 Put an insert on the holder

3 Put the wrench in the slot parallel



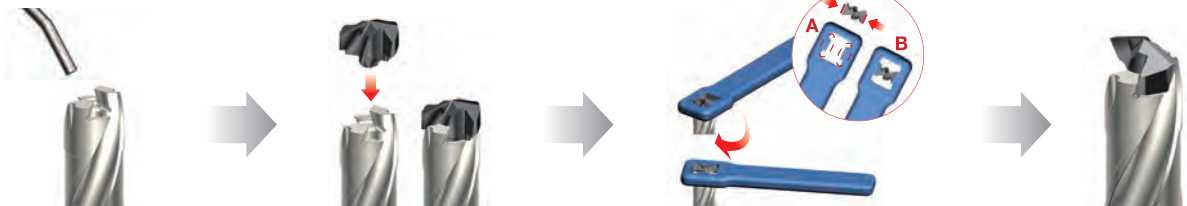
4 After fixing the wrench firmly, turn it clockwise and clamp the insert to the holder

Clamped state

### Using the existing wrench

- Using any inserts (Use both existing inserts and improved inserts)

Use only the improved wrench later



1 Clean the mounting seat with air or cloth

2 Put an insert on the holder

3 A part of wrench and B part of insert must be parallel to each other before clamp the insert  
Turn the wrench clockwise to finish clamping

Clamped state

# F Technical Information for TPDC Plus Drill

## Recommended cutting conditions (TPDC-XP)

### • 3D Drilling

Workpiece			Grade	vc (m/min)	Aspect ratio (L/D) = 3D		
ISO	Workpiece	HB			Feed rate (mm/rev) per drill dia. (mm)		
					Ø8.00~Ø9.99	Ø10.00~Ø11.99	
P	Carbon steel	Low carbon steel	80~120	PC325U	110 (80~140)	0.12~0.22	0.15~0.28
		High carbon steel	180~280	PC325U	90 (70~110)		
P	Alloy steel	Low alloy steel	140~260	PC325U	90 (70~110)	0.12~0.20	0.14~0.25
		Low alloy heat treated steel	200~400	PC325U	70 (50~90)		
		High alloy steel	260~320	PC325U	70 (50~90)	0.10~0.15	0.12~0.18
		High alloy heat treated steel	300~450	PC325U	60 (40~80)		
K	Cast iron	Gray cast iron	150~230	PC325U	125 (90~160)	0.15~0.30	0.20~0.35
		Ductile cast iron	160~260	PC325U	110 (80~140)		

※ In interrupted machining, reduce the feed to 0.1-0.15 machining around the interrupted part

### • 5D Drilling

Workpiece			Grade	vc (m/min)	Aspect ratio (L/D) = 5D		
ISO	Workpiece	HB			Feed rate (mm/rev) per drill dia. (mm)		
					Ø8.00~Ø9.99	Ø10.00~Ø11.99	
P	Carbon steel	Low carbon steel	80~120	PC325U	110 (80~140)	0.12~0.22	0.15~0.28
		High carbon steel	180~280	PC325U	90 (70~110)		
P	Alloy steel	Low alloy steel	140~260	PC325U	90 (70~110)	0.12~0.20	0.14~0.25
		Low alloy heat treated steel	200~400	PC325U	70 (50~90)		
		High alloy steel	260~320	PC325U	70 (50~90)	0.10~0.15	0.12~0.18
		High alloy heat treated steel	300~450	PC325U	60 (40~80)		
K	Cast iron	Gray cast iron	150~230	PC325U	125 (90~160)	0.15~0.30	0.20~0.35
		Ductile cast iron	160~260	PC325U	110 (80~140)		

※ In interrupted machining, reduce the feed to 0.1-0.15 machining around the interrupted part

### • 8D Drilling

Workpiece			Grade	vc (m/min)	Aspect ratio (L/D) = 8D		
ISO	Workpiece	HB			Feed rate (mm/rev) per drill dia. (mm)		
					Ø8.00~Ø9.99	Ø10.00~Ø11.99	
P	Carbon steel	Low carbon steel	80~120	PC325U	100 (70~130)	0.10~0.20	0.12~0.25
		High carbon steel	180~280	PC325U	80 (60~100)		
P	Alloy steel	Low alloy steel	140~260	PC325U	80 (60~100)	0.10~0.18	0.12~0.20
		Low alloy heat treated steel	200~400	PC325U	60 (40~80)		
		High alloy steel	260~320	PC325U	60 (40~80)	0.09~0.13	0.10~0.16
		High alloy heat treated steel	300~450	PC325U	50 (30~70)		
K	Cast iron	Gray cast iron	150~230	PC325U	115 (80~150)	0.12~0.27	0.17~0.32
		Ductile cast iron	160~260	PC325U	100 (70~130)		

※ In interrupted machining, reduce the feed to 0.1-0.15 machining around the interrupted part

※ In case of 8D drilling, please use a Pilot Drill



## Recommended cutting conditions (TPDC-CP/CM/CN)

### • 1.5D/3D Drilling

Workpiece			Insert	Grade	vc (m/min)	Aspect ratio (L/D) = 1.5D, 3D			
ISO	Workpiece	HB				Feed rate (mm/rev) per drill dia. (mm)			
						Ø12.00-Ø17.99	Ø18.00-Ø25.99	Ø26.00-Ø30.99	
P	Carbon steel	Low carbon steel	80~120	CP	PC5335 PC330P	120 (90~140)	0.25~0.35	0.30~0.40	0.35~0.45
		High carbon steel	180~280	CP	PC5335 PC330P	110 (80~130)	0.25~0.35	0.30~0.40	0.30~0.45
	Alloy steel	Low alloy steel	140~260	CP	PC5335 PC5300	120 (90~140)	0.28~0.40	0.33~0.43	0.38~0.48
		Low alloy heat treated steel	200~400	CP	PC5335 PC5300	80 (60~100)	0.28~0.40	0.33~0.43	0.30~0.48
		High alloy steel	260~320	CP	PC5335 PC5300	75 (60~90)	0.20~0.35	0.22~0.40	0.25~0.45
	High alloy heat treated steel	300~450	CP	PC5335 PC5300	65 (50~80)	0.20~0.35	0.22~0.40	0.22~0.45	
M	Stainless steel	Austenitic	135~275	CM	PC330N	65 (50~80)	0.05~0.15	0.10~0.20	0.15~0.25
		Ferritic, martensitic	135~275	CM	PC330N	75 (60~90)	0.10~0.20	0.15~0.30	0.20~0.35
K	Cast iron	Gray cast iron	150~230	CP	PC5335 PC5300	130 (90~140)	0.35~0.45	0.40~0.50	0.45~0.55
		Ductile cast iron	160~260	CP	PC5335 PC5300	120 (80~130)	0.30~0.40	0.30~0.45	0.40~0.50
N	Non-ferrous metal	Aluminum	30~150	CN	H01	200 (120~220)	0.35~0.45	0.40~0.50	0.45~0.55
		Copper alloy	150~160	CN	H01	200 (120~220)	0.35~0.45	0.40~0.50	0.45~0.55

※ In interrupted machining, reduce the feed to 0.1-0.15 machining around the interrupted part

※ In stainless steel machining, start with low feed machining then, gradually get the cutting conditions higher and set the optimal cutting conditions

### • 5D Drilling

Workpiece			Insert	Grade	vc (m/min)	Aspect ratio (L/D) = 5D			
ISO	Workpiece	HB				Feed rate (mm/rev) per drill dia. (mm)			
						Ø12.00-Ø17.99	Ø18.00-Ø25.99	Ø26.00-Ø30.99	
P	Carbon steel	Low carbon steel	80~120	CP	PC5335 PC330P	110 (80~140)	0.15~0.30	0.20~0.35	0.25~0.40
		High carbon steel	180~280	CP	PC5335 PC330P	100 (70~130)	0.15~0.30	0.20~0.35	0.25~0.40
	Alloy steel	Low alloy steel	140~260	CP	PC5335 PC5300	110 (80~140)	0.18~0.35	0.23~0.38	0.28~0.43
		Low alloy heat treated steel	200~400	CP	PC5335 PC5300	75 (50~100)	0.18~0.35	0.23~0.38	0.28~0.43
		High alloy steel	260~320	CP	PC5335 PC5300	70 (50~90)	0.18~0.30	0.20~0.35	0.25~0.40
	High alloy heat treated steel	300~450	CP	PC5335 PC5300	60 (40~80)	0.18~0.30	0.20~0.35	0.22~0.40	
M	Stainless steel	Austenitic	135~275	CM	PC330N	60 (40~80)	0.05~0.15	0.10~0.20	0.15~0.25
		Ferritic, martensitic	135~275	CM	PC330N	70 (50~90)	0.10~0.20	0.15~0.30	0.20~0.35
K	Cast iron	Gray cast iron	150~230	CP	PC5335 PC5300	120 (80~140)	0.25~0.40	0.30~0.45	0.35~0.50
		Ductile cast iron	160~260	CP	PC5335 PC5300	110 (70~130)	0.20~0.35	0.25~0.40	0.30~0.45
N	Non-ferrous metal	Aluminum	30~150	CN	H01	200 (90~220)	0.35~0.45	0.40~0.50	0.45~0.55
		Copper alloy	150~160	CN	H01	200 (90~220)	0.35~0.45	0.40~0.50	0.45~0.55

※ In interrupted machining, reduce the feed to 0.1-0.15 machining around the interrupted part

※ In stainless steel machining, start with low feed machining then, gradually get the cutting conditions higher and set the optimal cutting conditions

# F Technical Information for TPDC Plus Drill

## • 8D Drilling

Workpiece			Insert	Grade	vc (m/min)	Aspect ratio (L/D) = 8D			
ISO	Workpiece	HB				Feed rate (mm/rev) per drill dia. (mm)			
						Ø12.00-Ø17.99	Ø18.00-Ø25.99	Ø26.00-Ø30.99	
P	Carbon steel	Low carbon steel	80-120	CP	PC5335 PC330P	100 (70~130)	0.12~0.25	0.17~0.30	0.22~0.35
		High carbon steel	180-280	CP	PC5335 PC330P	90 (60~120)	0.12~0.25	0.17~0.30	0.22~0.35
	Alloy steel	Low alloy steel	140~260	CP	PC5335 PC5300	100 (70~130)	0.15~0.30	0.20~0.33	0.25~0.38
		Low alloy heat treated steel	200-400	CP	PC5335 PC5300	65 (40~90)	0.15~0.30	0.20~0.33	0.25~0.38
		High alloy steel	260-320	CP	PC5335 PC5300	60 (40~80)	0.15~0.25	0.17~0.30	0.22~0.35
		High alloy heat treated steel	300-450	CP	PC5335 PC5300	50 (30~70)	0.15~0.25	0.17~0.30	0.22~0.35
M	Stainless steel	Austenitic	135-275	CM	PC330N	50 (30~70)	0.05~0.10	0.05~0.15	0.10~0.20
		Ferritic, martensitic	135-275	CM	PC330N	60 (40~80)	0.05~0.15	0.10~0.25	0.15~0.30
K	Cast iron	Gray cast iron	150-230	CP	PC5335 PC5300	110 (70~130)	0.22~0.35	0.27~0.40	0.32~0.45
		Ductile cast iron	160-260	CP	PC5335 PC5300	100 (60~120)	0.17~0.30	0.22~0.35	0.27~0.40
N	Non-ferrous metal	Aluminum	30-150	CN	H01	190 (80~200)	0.30~0.40	0.35~0.45	0.40~0.50
		Copper alloy	150~160	CN	H01	190 (80~200)	0.30~0.40	0.35~0.45	0.40~0.50

※ In interrupted machining, reduce the feed to 0.1-0.15 machining around the interrupted part

※ In stainless steel machining, start with low feed machining then, gradually get the cutting conditions higher and set the optimal cutting conditions

## • 10D/12D Drilling

Workpiece			Insert	Grade	vc (m/min)	Aspect ratio (L/D) = 10D, 12D			
ISO	Workpiece	HB				Feed rate (mm/rev) per drill dia. (mm)			
						Ø12.00-Ø17.99	Ø18.00-Ø25.99	Ø26.00-Ø30.99	
P	Carbon steel	Low carbon steel	80~120	CP	PC5335 PC330P	90 (60~120)	0.10~0.20	0.15~0.25	0.20~0.30
		High carbon steel	180~280	CP	PC5335 PC330P	80 (50~110)	0.10~0.20	0.15~0.25	0.20~0.30
	Alloy steel	Low alloy steel	140~260	CP	PC5335 PC5300	90 (60~120)	0.13~0.25	0.18~0.28	0.23~0.33
		Low alloy heat treated steel	200~400	CP	PC5335 PC5300	55 (40~80)	0.13~0.30	0.18~0.28	0.23~0.33
		High alloy steel	260~320	CP	PC5335 PC5300	50 (40~70)	0.13~0.25	0.15~0.25	0.20~0.30
		High alloy heat treated steel	300~450	CP	PC5335 PC5300	40 (30~60)	0.13~0.25	0.15~0.25	0.20~0.30
M	Stainless steel	Austenitic	135~275	CM	PC330N	50 (30~60)	0.05~0.10	0.05~0.15	0.10~0.20
		Ferritic, martensitic	135~275	CM	PC330N	60 (40~70)	0.05~0.15	0.10~0.25	0.15~0.30
K	Cast iron	Gray cast iron	150~230	CP	PC5335 PC5300	100 (60~120)	0.20~0.30	0.25~0.35	0.30~0.40
		Ductile cast iron	160~260	CP	PC5335 PC5300	90 (50~110)	0.15~0.25	0.20~0.30	0.25~0.35
N	Non-ferrous metal	Aluminum	30~150	CN	H01	180 (70~190)	0.28~0.35	0.33~0.40	0.38~0.45
		Copper alloy	150~160	CN	H01	180 (70~190)	0.28~0.35	0.33~0.40	0.38~0.45

※ In interrupted machining, reduce the feed to 0.1-0.15 machining around the interrupted part



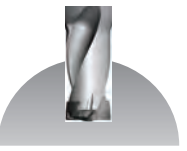


※ In case of 10D and 12D, apply the recommended cutting conditions in the other side

※ In stainless steel machining, start with low feed machining then, gradually get the cutting conditions higher and set the optimal cutting conditions



## Recommended cutting conditions (TPDC-CP-FC)

Workpiece			Grade	vc (m/min)	Aspect ratio (L/D) = 1.5D, 3D, 5D		
ISO	Workpiece	HB			Feed rate (mm/rev) per drill dia. (mm)		
					Ø12.00-Ø17.99	Ø18.00-Ø25.99	Ø26.00-Ø30.99
P	Carbon steel	Low carbon steel (SM10C, SM20C etc)	PC5335	90 (70~110)	0.18~0.28	0.2~0.3	0.23~0.33
		High carbon steel (SM45C, SM50C etc)		80 (60~100)	0.18~0.28	0.2~0.3	0.23~0.33
	Alloy steel	Low alloy steel (SCM420, SCM440 etc)		90 (70~110)	0.18~0.28	0.2~0.3	0.23~0.33
		High alloy steel (SCM435, SCM445 etc)		70 (50~90)	0.18~0.28	0.2~0.3	0.23~0.33

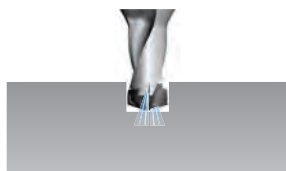
Machining	Flat surface drilling	Angled surface drilling	Curved surface drilling	Plunging	Boring
Pic.					
1.5D/3D	○	○	○	○	○
5D	○	×	×	×	×

※ Please refer to the precaution in drilling in case of angled surface drilling, curved surface drilling, plunging and boring

## How to drill a deep hole (10D/12D)

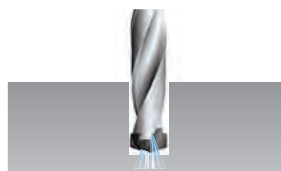
### • Using a pilot drill (recommended)

#### 1. Drilling a pilot hole (with a pilot drill)



- Drill a 0.5D pilot hole in 70% lower cutting speed with 1.5D drill or 3D drill

#### 2. Start drilling



- Start drilling in recommended cutting conditions after replacing the drill

### • Without Pilot Drill

#### 1. Drilling a pilot hole (without a pilot drill)



- After drill 0.5D with 70% lower cutting speed, stop drilling for 2-3 seconds putting the drill in the hole

#### 2. Stop drilling



- Stop supplying the coolant and take out the drill from the hole. Then, stop drilling for 2-3 seconds

#### 3. Ready to drill



- After putting the drill in the hole to 2-3 mm upper than the bottom of the pilot hole, start supplying the coolant. Then, be ready to start drilling

#### 4. Stop drilling



- Start drilling in recommended cutting conditions



# F Technical Information for TPDC Plus Drill

## Precaution in drilling

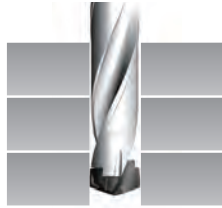
### TPDC-CP/CM/CN

#### Angled surface drilling



- The approach angle between drill and the workpiece at the beginning and the end should be less than  $6^\circ$
- Reduce the feed (fn) to 30-50% than general cutting conditions at the beginning and the end of angled surface

#### Stacked plates drilling



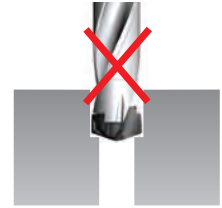
- Gap between the plates could make wrong chip evacuation causing fracture of the drill
- Place stacked plates without any gap between each

#### Plunging



- Irregular cutting resistance in plunging could cause fracture and deformation of the drill

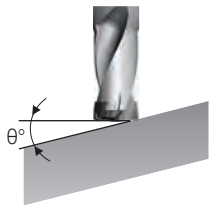
#### Boring



- Boring is not recommended due to wear and chipping in the corner of the insert

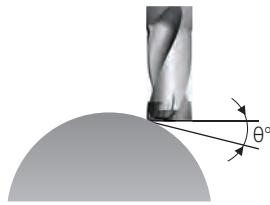
### TPDC-CP-FC

#### Angled surface drilling



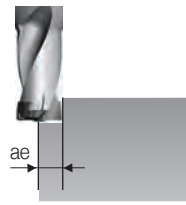
- Reduce the feed (fn) to 30% than general cutting conditions at the beginning and the end of angled surface (Recommended only in case of  $\theta$  is less than  $10^\circ$ )

#### Curved surface drilling



- Reduce the feed (fn) to 30% than general cutting conditions at the beginning of curved surface (In case,  $\theta$  is over  $3^\circ$ , reduce it to 50%)

#### Plunging



- Reduce the depth of cut (ae) to shorter than 1/2 of drill diameter
- In case, the depth of cut is longer than drill diameter, plunge with divided depth of cut

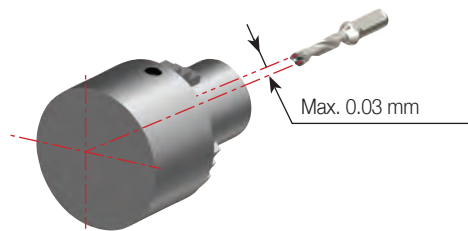
#### Boring



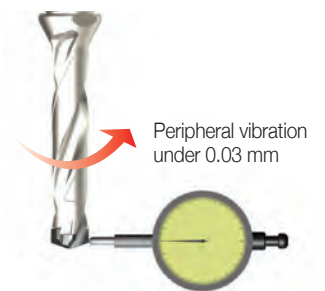
- Reduce the feed (fn) to 30% than general cutting conditions at the beginning of boring
- Start with 2 mm stepping before boring to prevent long chip

## Check point in drilling

- Condition of the clamped workpiece
- Revolution of the main axis of the machine
- Condition of the holder
- Run-out of the clamped drill (Max. 0.03 mm)
- Condition of supplying coolant (pressure, flow, concentration)
- Chip evacuation



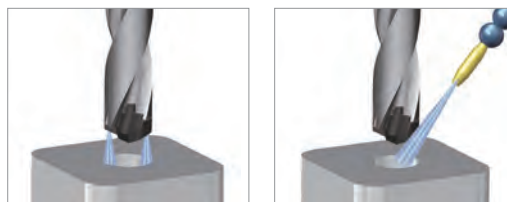
Setting of the horizontal equipment



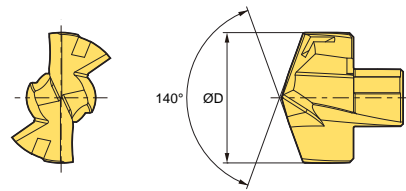
Setting of the vertical equipment

## Supply of coolant

- Supply enough coolant to the beginning of the hole
- Minimum pressure of oil coolant: 5 bar
- Minimum flow of coolant: 5 l/min



Available insert



Drill dia. ØD (mm)	P type (XP)	Coated	Holder	Wrench
	TPDC-XP	PC325U		
8.0	TPD0800XP	●	TPDX□D-08012-□	TPDC -W0811
8.1	TPD0810XP	●		
8.2	TPD0820XP	●		
8.3	TPD0830XP	●		
8.4	TPD0840XP	●	TPDX□D-08512-□	
8.5	TPD0850XP	●		
8.6	TPD0860XP	●		
8.7	TPD0870XP	●		
8.8	TPD0880XP	●		
8.9	TPD0890XP	●	TPDX□D-09012-□	
9.0	TPD0900XP	●		
9.1	TPD0910XP	●		
9.2	TPD0920XP	●		
9.3	TPD0930XP	●	TPDX□D-09512-□	
9.4	TPD0940XP	●		
9.5	TPD0950XP	●		
9.6	TPD0960XP	●		
9.7	TPD0970XP	●		
9.8	TPD0980XP	●	TPDX□D-10016-□	
9.9	TPD0990XP	●		
10.0	TPD1000XP	●		
10.1	TPD1010XP	●		
10.2	TPD1020XP	●	TPDX□D-10516-□	
10.3	TPD1030XP	●		
10.4	TPD1040XP	●		
10.5	TPD1050XP	●		
10.6	TPD1060XP	●		
10.7	TPD1070XP	●	TPDX□D-11016-□	
10.8	TPD1080XP	●		
10.9	TPD1090XP	●		
11.0	TPD1100XP	●		
11.1	TPD1110XP	●	TPDX□D-11516-□	
11.2	TPD1120XP	●		
11.3	TPD1130XP	●		
11.4	TPD1140XP	●		
11.5	TPD1150XP	●		
11.6	TPD1160XP	●	TPDX□D-11516-□	
11.7	TPD1170XP	●		
11.8	TPD1180XP	●		
11.9	TPD1190XP	●		

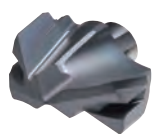
※ We can provide if you order exact machining specification

● : Stock Item

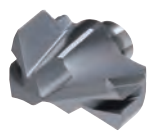
Parts (applicable wrench)

Picture	Designation	Drill diameter ØD (mm)	Torque (N•m)
	TPDC-W0811	8.00-11.99	0.7-1.5

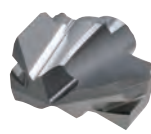
## Available insert



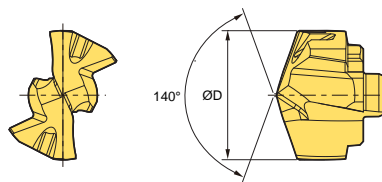
CP



CM



CN



Drill dia. ØD(mm)	P type (CP)				M type (CM)		N type (CN)		Holder	Wrench
	TPDC-CP	Coated			TPDC-CM	Coated	TPDC-CN	Uncoated		
		PC5335	PC5300	PC330P		PC330N		H01		
12.0	TPD1200CP	●			TPD1200CM	●	TPD1200CN		TPDC- W1216	
12.2	TPD1220CP	●			TPD1220CM	●	TPD1220CN			
12.5	TPD1250CP	●			TPD1250CM	●	TPD1250CN			
12.6	TPD1260CP	●			TPD1260CM	●	TPD1260CN			
13.0	TPD1300CP	●			TPD1300CM	●	TPD1300CN			
13.5	TPD1350CP	●			TPD1350CM	●	TPD1350CN			
14.0	TPD1400CP	●			TPD1400CM	●	TPD1400CN			
14.2	TPD1420CP	●			TPD1420CM	●	TPD1420CN			
14.3	TPD1430CP	●			TPD1430CM	●	TPD1430CN			
14.5	TPD1450CP	●			TPD1450CM	●	TPD1450CN			
15.0	TPD1500CP	●			TPD1500CM	●	TPD1500CN			
15.2	TPD1520CP	●			TPD1520CM	●	TPD1520CN			
15.5	TPD1550CP	●			TPD1550CM	●	TPD1550CN			
16.0	TPD1600CP	●			TPD1600CM	●	TPD1600CN			
16.3	TPD1630CP	●			TPD1630CM	●	TPD1630CN			
16.5	TPD1650CP	●			TPD1650CM	●	TPD1650CN			
16.7	TPD1670CP	●			TPD1670CM	●	TPD1670CN			
16.9	TPD1690CP	●			TPD1690CM	●	TPD1690CN			
17.0	TPD1700CP	●			TPD1700CM	●	TPD1700CN			
17.5	TPD1750CP	●			TPD1750CM	●	TPD1750CN			
17.7	TPD1770CP	●			TPD1770CM	●	TPD1770CN			
18.0	TPD1800CP	●			TPD1800CM	●	TPD1800CN			
18.1	TPD1810CP	●			TPD1810CM	●	TPD1810CN			
18.5	TPD1850CP	●			TPD1850CM	●	TPD1850CN			
18.6	TPD1860CP	●			TPD1860CM	●	TPD1860CN			
18.7	TPD1870CP	●			TPD1870CM	●	TPD1870CN			
19.0	TPD1900CP	●			TPD1900CM	●	TPD1900CN			
19.2	TPD1920CP	●			TPD1920CM	●	TPD1920CN			
19.3	TPD1930CP	●			TPD1930CM	●	TPD1930CN			
19.5	TPD1950CP	●			TPD1950CM	●	TPD1950CN			
19.7	TPD1970CP	●			TPD1970CM	●	TPD1970CN			
20.0	TPD2000CP	●			TPD2000CM	●	TPD2000CN			
20.5	TPD2050CP	●			TPD2050CM	●	TPD2050CN			
21.0	TPD2100CP	●			TPD2100CM	●	TPD2100CN			
21.5	TPD2150CP	●			TPD2150CM	●	TPD2150CN			
22.0	TPD2200CP	●			TPD2200CM	●	TPD2200CN			
22.5	TPD2250CP	●			TPD2250CM	●	TPD2250CN			
22.6	TPD2260CP	●			TPD2260CM	●	TPD2260CN			
22.7	TPD2270CP	●			TPD2270CM	●	TPD2270CN			
23.0	TPD2300CP	●			TPD2300CM	●	TPD2300CN			
23.5	TPD2350CP	●			TPD2350CM	●	TPD2350CN			
24.0	TPD2400CP	●			TPD2400CM	●	TPD2400CN			
24.5	TPD2450CP	●			TPD2450CM	●	TPD2450CN			
25.0	TPD2500CP	●			TPD2500CM	●	TPD2500CN			
25.3	TPD2530CP	●			TPD2530CM	●	TPD2530CN			
25.5	TPD2550CP	●			TPD2550CM	●	TPD2550CN			
25.8	TPD2580CP	●			TPD2580CM	●	TPD2580CN			
25.9	TPD2590CP	●			TPD2590CM	●	TPD2590CN			
26.0	TPD2600CP	●			TPD2600CM	●	TPD2600CN			
26.5	TPD2650CP	●			TPD2650CM	●	TPD2650CN			
27.0	TPD2700CP	●			TPD2700CM	●	TPD2700CN			
27.5	TPD2750CP	●			TPD2750CM	●	TPD2750CN			
28.0	TPD2800CP	●			TPD2800CM	●	TPD2800CN			
28.5	TPD2850CP	●			TPD2850CM	●	TPD2850CN			
29.0	TPD2900CP	●			TPD2900CM	●	TPD2900CN			
29.5	TPD2950CP	●			TPD2950CM	●	TPD2950CN			
30.0	TPD3000CP	●			TPD3000CM	●	TPD3000CN			
30.5	TPD3050CP	●			TPD3050CM	●	TPD3050CN			

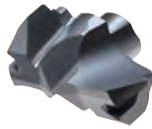
※ We can provide if you order exact machining specification Ex) Ø15.9 and carbon steel machining → TPD1590CP/PC330P

●: Stock Item

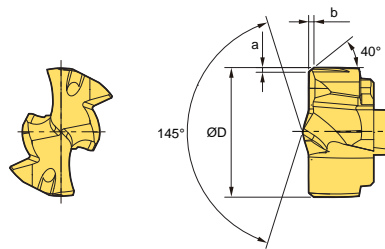
## Parts (applicable wrench)

Picture	Designation	Drill diameter ØD (mm)	Torque (N·m)
	TPDC-W1216	12.00-16.99	2.0-3.0
	TPDC-W1721	17.00-21.99	2.0-4.0
	TPDC-W2225	22.00-25.99	3.0-4.0
	TPDC-W2630	26.00-30.99	4.0-5.0

Available insert



FC



Drill dia. ØD(mm)	FC type (CP-FC)		Holder	Chamfer (mm)		Wrench
	TPDC-CP-FC	Coated PC5335		a	b	
12.0	TPD1200CP-FC		TPDC□D-12016-□	0.38	0.45	TPDC-W1216
12.2	TPD1220CP-FC					
12.5	TPD1250CP-FC		TPDC□D-12516-□			
12.6	TPD1260CP-FC					
13.0	TPD1300CP-FC		TPDC□D-13016-□			
13.5	TPD1350CP-FC		TPDC□D-13516-□			
14.0	TPD1400CP-FC					
14.2	TPD1420CP-FC		TPDC□D-14016-□			
14.3	TPD1430CP-FC					
14.5	TPD1450CP-FC		TPDC□D-14516-□			
15.0	TPD1500CP-FC		TPDC□D-15020-□			
15.5	TPD1550CP-FC					
16.0	TPD1600CP-FC					
16.3	TPD1630CP-FC		TPDC□D-16020-□			
16.5	TPD1650CP-FC					
16.7	TPD1670CP-FC					
17.0	TPD1700CP-FC					
17.5	TPD1750CP-FC		TPDC□D-17020-□			
17.7	TPD1770CP-FC					
18.0	TPD1800CP-FC					
18.1	TPD1810CP-FC					
18.5	TPD1850CP-FC		TPDC□D-18025-□			
18.6	TPD1860CP-FC					
18.7	TPD1870CP-FC					
19.0	TPD1900CP-FC					
19.2	TPD1920CP-FC		TPDC□D-19025-□			
19.5	TPD1950CP-FC					
19.7	TPD1970CP-FC					
20.0	TPD2000CP-FC		TPDC□D-20025-□			
20.5	TPD2050CP-FC					
21.0	TPD2100CP-FC		TPDC□D-21025-□			
21.5	TPD2150CP-FC					
22.0	TPD2200CP-FC					
22.5	TPD2250CP-FC		TPDC□D-22025-□			
22.6	TPD2260CP-FC					
22.7	TPD2270CP-FC					
23.0	TPD2300CP-FC		TPDC□D-23025-□			
23.5	TPD2350CP-FC					
24.0	TPD2400CP-FC		TPDC□D-24032-□			
24.5	TPD2450CP-FC					
25.0	TPD2500CP-FC					
25.3	TPD2530CP-FC		TPDC□D-25032-□			
25.5	TPD2550CP-FC					
25.8	TPD2580CP-FC					
25.9	TPD2590CP-FC					
26.0	TPD2600CP-FC		TPDC□D-26032-□			
26.5	TPD2650CP-FC					
27.0	TPD2700CP-FC		TPDC□D-27032-□			
27.5	TPD2750CP-FC					
28.0	TPD2800CP-FC		TPDC□D-28032-□			
28.5	TPD2850CP-FC					
29.0	TPD2900CP-FC		TPDC□D-29032-□			
29.5	TPD2950CP-FC					
30.0	TPD3000CP-FC					
30.5	TPD3050CP-FC		TPDC□D-30032-□			

※ We can provide if you order exact machining specification Ex) Ø15.9 and carbon steel machining → TPD1590CP-FC/PC5335

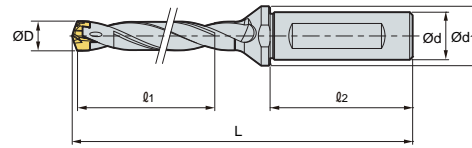
● : Stock Item

※ TPDC-CP-FC insert: impossible to be reground

Parts (applicable wrench)

Picture	Designation	Drill diameter ØD (mm)	Torque (N•m)
	TPDC- W1216	12.00-16.99	2.0-3.0
	W1721	17.00-21.99	2.0-4.0
	W2225	22.00-25.99	3.0-4.0
	W2630	26.00-30.99	4.0-5.0

## TPDX(3D/5D/8D)



(mm)

Designation		ØD	Ød	Ød <sub>1</sub>	l <sub>1</sub>	l <sub>2</sub>	L	Insert
TPDX	3D-08012-24	8.0-8.4	12	16	24	45	82.2	TPD0800XP-0849XP
	3D-08512-26	8.5-8.9	12	16	26	45	84.1	TPD0850XP-0899XP
	3D-09012-27	9.0-9.4	12	16	27	45	85.9	TPD0900XP-0949XP
	3D-09512-29	9.5-9.9	12	16	29	45	87.7	TPD0950XP-0999XP
	3D-10016-30	10.0-10.4	16	20	30	48	94.6	TPD1000XP-1049XP
	3D-10516-32	10.5-10.9	16	20	32	48	96.5	TPD1050XP-1099XP
	3D-11016-33	11.0-11.4	16	20	33	48	98.2	TPD1100XP-1149XP
	3D-11516-35	11.5-11.9	16	20	35	48	100.1	TPD1150XP-1199XP
TPDX	5D-08012-40	8.0-8.4	12	16	40	45	98.2	TPD0800XP-0849XP
	5D-08512-43	8.5-8.9	12	16	43	45	101.1	TPD0850XP-0899XP
	5D-09012-45	9.0-9.4	12	16	45	45	103.9	TPD0900XP-0949XP
	5D-09512-48	9.5-9.9	12	16	48	45	106.7	TPD0950XP-0999XP
	5D-10016-50	10.0-10.4	16	20	50	48	114.6	TPD1000XP-1049XP
	5D-10516-53	10.5-10.9	16	20	53	48	117.5	TPD1050XP-1099XP
	5D-11016-55	11.0-11.4	16	20	55	48	120.2	TPD1100XP-1149XP
	5D-11516-58	11.5-11.9	16	20	58	48	123.1	TPD1150XP-1199XP
TPDX	8D-08012-64	8.0-8.4	12	16	64	45	122.2	TPD0800XP-0849XP
	8D-08512-68	8.5-8.9	12	16	68	45	126.6	TPD0850XP-0899XP
	8D-09012-72	9.0-9.4	12	16	72	45	130.9	TPD0900XP-0949XP
	8D-09512-76	9.5-9.9	12	16	76	45	135.2	TPD0950XP-0999XP
	8D-10016-80	10.0-10.4	16	20	80	48	144.6	TPD1000XP-1049XP
	8D-10516-84	10.5-10.9	16	20	84	48	149.0	TPD1050XP-1099XP
	8D-11016-88	11.0-11.4	16	20	88	48	153.2	TPD1100XP-1149XP
	8D-11516-92	11.5-11.9	16	20	92	48	157.6	TPD1150XP-1199XP

↻ Applicable inserts **F47**

※ We can provide if you order exact machining specification. Ex) Ø10 and 60 mm depth of cut → TPDX6D-10016-60

# TPDC(1.5D/3D)

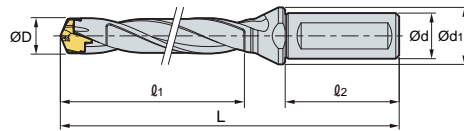


Fig.1

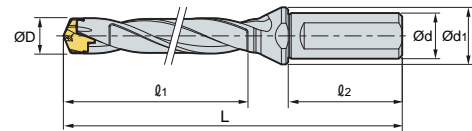


Fig.2

		(mm)							
	Designation	ØD	Ød	Ød <sub>1</sub>	l <sub>1</sub>	l <sub>2</sub>	L	Insert	Fig.
TPDC	1.5D-12016-18	12.0~12.4	16	20	18	48	85	TPD1200C□-1249C□	1
	1.5D-12516-19	12.5~12.9	16	20	19	48	86	TPD1250C□-1299C□	1
	1.5D-13016-20	13.0~13.4	16	20	20	48	87	TPD1300C□-1349C□	1
	1.5D-13516-20	13.5~13.9	16	20	20	48	88	TPD1350C□-1399C□	1
	1.5D-14016-21	14.0~14.4	16	20	21	48	93	TPD1400C□-1449C□	1
	1.5D-14516-22	14.5~14.9	16	20	22	48	94	TPD1450C□-1499C□	1
	1.5D-15020-23	15.0~15.9	20	25	23	50	95	TPD1500C□-1599C□	2
	1.5D-16020-24	16.0~16.9	20	25	24	50	98	TPD1600C□-1699C□	2
	1.5D-17020-26	17.0~17.9	20	25	26	50	100	TPD1700C□-1799C□	2
	1.5D-18025-27	18.0~18.9	25	33	27	56	110	TPD1800C□-1899C□	2
	1.5D-19025-28	19.0~19.9	25	33	28	56	112	TPD1900C□-1999C□	2
	1.5D-20025-30	20.0~20.9	25	33	30	56	114	TPD2000C□-2099C□	2
	1.5D-21025-31	21.0~21.9	25	33	31	56	116	TPD2100C□-2199C□	2
	1.5D-22025-33	22.0~22.9	25	33	33	56	119	TPD2200C□-2299C□	2
	1.5D-23025-34	23.0~23.9	25	33	34	56	121	TPD2300C□-2399C□	2
	1.5D-24032-36	24.0~24.9	32	43	36	60	130	TPD2400C□-2499C□	2
	1.5D-25032-37	25.0~25.9	32	43	37	60	132	TPD2500C□-2599C□	2
1.5D-26032-39	26.0~26.9	32	43	39	60	134	TPD2600C□-2699C□	2	
1.5D-27032-40	27.0~27.9	32	43	40	60	136	TPD2700C□-2799C□	2	
1.5D-28032-42	28.0~28.9	32	43	42	60	138	TPD2800C□-2899C□	2	
1.5D-29032-43	29.0~29.9	32	43	43	60	141	TPD2900C□-2999C□	2	
1.5D-30032-45	30.0~30.9	32	43	45	60	143	TPD3000C□-3099C□	2	
TPDC	3D-12016-36	12.0~12.4	16	20	36	48	99	TPD1200C□-1249C□	1
	3D-12516-38	12.5~12.9	16	20	38	48	101	TPD1250C□-1299C□	1
	3D-13016-39	13.0~13.4	16	20	39	48	103	TPD1300C□-1349C□	1
	3D-13516-41	13.5~13.9	16	20	41	48	105	TPD1350C□-1399C□	1
	3D-14016-42	14.0~14.4	16	20	42	48	106	TPD1400C□-1449C□	1
	3D-14516-44	14.5~14.9	16	20	44	48	107	TPD1450C□-1499C□	1
	3D-15020-45	15.0~15.9	20	25	45	50	113	TPD1500C□-1599C□	2
	3D-16020-48	16.0~16.9	20	25	48	50	117	TPD1600C□-1699C□	2
	3D-17020-51	17.0~17.9	20	25	51	50	120	TPD1700C□-1799C□	2
	3D-18025-54	18.0~18.9	25	33	54	56	132	TPD1800C□-1899C□	2
	3D-19025-57	19.0~19.9	25	33	57	56	135	TPD1900C□-1999C□	2
	3D-20025-60	20.0~20.9	25	33	60	56	138	TPD2000C□-2099C□	2
	3D-21025-63	21.0~21.9	25	33	63	56	141	TPD2100C□-2199C□	2
	3D-22025-66	22.0~22.9	25	33	66	56	145	TPD2200C□-2299C□	2
	3D-23025-69	23.0~23.9	25	33	69	56	149	TPD2300C□-2399C□	2
	3D-24032-72	24.0~24.9	32	43	72	60	159	TPD2400C□-2499C□	2
	3D-25032-75	25.0~25.9	32	43	75	60	162	TPD2500C□-2599C□	2
	3D-26032-78	26.0~26.9	32	43	78	60	173	TPD2600C□-2699C□	2
	3D-27032-81	27.0~27.9	32	43	81	60	176	TPD2700C□-2799C□	2
	3D-28032-84	28.0~28.9	32	43	84	60	180	TPD2800C□-2899C□	2
	3D-29032-87	29.0~29.9	32	43	87	60	185	TPD2900C□-2999C□	2
3D-30032-90	30.0~30.9	32	43	90	60	188	TPD3000C□-3099C□	2	

➔ Applicable inserts F48~49

※ We can provide if you order exact machining specification. Ex) Ø15 and 60 mm depth of cut → TPDC4D-15020-60

## TPDC(5D/8D)

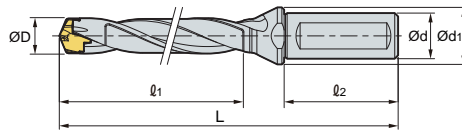


Fig.1

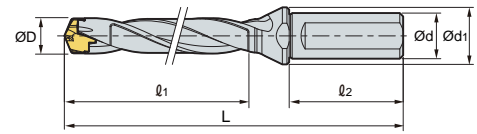


Fig.2

	Designation	ØD	Ød	Ød <sub>1</sub>	l <sub>1</sub>	l <sub>2</sub>	L	Insert	Fig.
TPDC	5D-12016-60	12.0~12.4	16	20	60	48	123	TPD1200C□-1249C□	1
	5D-12516-63	12.5~12.9	16	20	63	48	126	TPD1250C□-1299C□	1
	5D-13016-65	13.0~13.4	16	20	65	48	129	TPD1300C□-1349C□	1
	5D-13516-68	13.5~13.9	16	20	68	48	132	TPD1350C□-1399C□	1
	5D-14016-70	14.0~14.4	16	20	70	48	134	TPD1400C□-1449C□	1
	5D-14516-73	14.5~14.9	16	20	73	48	136	TPD1450C□-1499C□	1
	5D-15020-75	15.0~15.9	20	25	75	50	143	TPD1500C□-1599C□	2
	5D-16020-80	16.0~16.9	20	25	80	50	149	TPD1600C□-1699C□	2
	5D-17020-85	17.0~17.9	20	25	85	50	154	TPD1700C□-1799C□	2
	5D-18025-90	18.0~18.9	25	33	90	56	168	TPD1800C□-1899C□	2
	5D-19025-95	19.0~19.9	25	33	95	56	173	TPD1900C□-1999C□	2
	5D-20025-100	20.0~20.9	25	33	100	56	178	TPD2000C□-2099C□	2
	5D-21025-105	21.0~21.9	25	33	105	56	183	TPD2100C□-2199C□	2
	5D-22025-110	22.0~22.9	25	33	110	56	189	TPD2200C□-2299C□	2
	5D-23025-115	23.0~23.9	25	33	115	56	195	TPD2300C□-2399C□	2
	5D-24032-120	24.0~24.9	32	43	120	60	207	TPD2400C□-2499C□	2
	5D-25032-125	25.0~25.9	32	43	125	60	212	TPD2500C□-2599C□	2
	5D-26032-130	26.0~26.9	32	43	130	60	225	TPD2600C□-2699C□	2
	5D-27032-135	27.0~27.9	32	43	135	60	230	TPD2700C□-2799C□	2
	5D-28032-140	28.0~28.9	32	43	140	60	236	TPD2800C□-2899C□	2
5D-29032-145	29.0~29.9	32	43	145	60	243	TPD2900C□-2999C□	2	
5D-30032-150	30.0~30.9	32	43	150	60	248	TPD3000C□-3099C□	2	
TPDC	8D-12016-96	12.0~12.4	16	20	96	48	159	TPD1200C□-1249C□	1
	8D-12516-100	12.5~12.9	16	20	100	48	163	TPD1250C□-1299C□	1
	8D-13016-104	13.0~13.4	16	20	104	48	168	TPD1300C□-1349C□	1
	8D-13516-108	13.5~13.9	16	20	108	48	173	TPD1350C□-1399C□	1
	8D-14016-112	14.0~14.4	16	20	112	48	176	TPD1400C□-1449C□	1
	8D-14516-116	14.5~14.9	16	20	116	48	180	TPD1450C□-1499C□	1
	8D-15020-120	15.0~15.9	20	25	120	50	188	TPD1500C□-1599C□	2
	8D-16020-128	16.0~16.9	20	25	128	50	197	TPD1600C□-1699C□	2
	8D-17020-136	17.0~17.9	20	25	136	50	205	TPD1700C□-1799C□	2
	8D-18025-144	18.0~18.9	25	33	144	56	222	TPD1800C□-1899C□	2
	8D-19025-152	19.0~19.9	25	33	152	56	230	TPD1900C□-1999C□	2
	8D-20025-160	20.0~20.9	25	33	160	56	238	TPD2000C□-2099C□	2
	8D-21025-168	21.0~21.9	25	33	168	56	246	TPD2100C□-2199C□	2
	8D-22025-176	22.0~22.9	25	33	176	56	255	TPD2200C□-2299C□	2
	8D-23025-184	23.0~23.9	25	33	184	56	264	TPD2300C□-2399C□	2
	8D-24032-192	24.0~24.9	32	43	192	60	279	TPD2400C□-2499C□	2
	8D-25032-200	25.0~25.9	32	43	200	60	287	TPD2500C□-2599C□	2
	8D-26032-208	26.0~26.9	32	43	208	60	303	TPD2600C□-2699C□	2
	8D-27032-216	27.0~27.9	32	43	216	60	311	TPD2700C□-2799C□	2
	8D-28032-224	28.0~28.9	32	43	224	60	320	TPD2800C□-2899C□	2
	8D-29032-232	29.0~29.9	32	43	232	60	330	TPD2900C□-2999C□	2
	8D-30032-240	30.0~30.9	32	43	240	60	338	TPD3000C□-3099C□	2

Applicable inserts F48-49

※ We can provide if you order exact machining specification. Ex) Ø15 and 60 mm depth of cut → TPDC4D-15020-60





# TPDC(10D/12D)

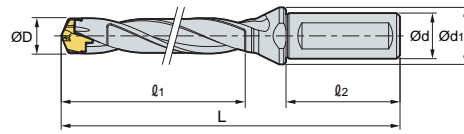


Fig.1

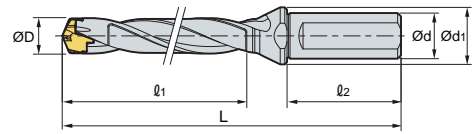


Fig.2

	Designation	ØD	Ød	Ød <sub>1</sub>	l <sub>1</sub>	l <sub>2</sub>	L	Insert	Fig.
TPDC	10D-12016-120	12.0~12.4	16	20	120	48	183	TPD1200C□-1249C□	1
	10D-12516-125	12.5~12.9	16	20	125	48	188	TPD1250C□-1299C□	1
	10D-13016-130	13.0~13.4	16	20	130	48	194	TPD1300C□-1349C□	1
	10D-13516-135	13.5~13.9	16	20	135	48	199	TPD1350C□-1399C□	1
	10D-14016-140	14.0~14.4	16	20	140	48	204	TPD1400C□-1449C□	1
	10D-14516-145	14.5~14.9	16	20	145	48	208	TPD1450C□-1499C□	1
	10D-15020-150	15.0~15.9	20	25	150	50	218	TPD1500C□-1599C□	1
	10D-16020-160	16.0~16.9	20	25	160	50	229	TPD1600C□-1699C□	1
	10D-17020-170	17.0~17.9	20	25	170	50	239	TPD1700C□-1799C□	1
	10D-18025-180	18.0~18.9	25	33	180	56	258	TPD1800C□-1899C□	1
	10D-19025-190	19.0~19.9	25	33	190	56	268	TPD1900C□-1999C□	1
	10D-20025-200	20.0~20.9	25	33	200	56	278	TPD2000C□-2099C□	1
	10D-21025-210	21.0~21.9	25	33	210	56	288	TPD2100C□-2199C□	1
	10D-22025-220	22.0~22.9	25	33	220	56	299	TPD2200C□-2299C□	1
	10D-23025-230	23.0~23.9	25	33	230	56	310	TPD2300C□-2399C□	1
	10D-24032-240	24.0~24.9	32	43	240	60	327	TPD2400C□-2499C□	2
	10D-25032-250	25.0~25.9	32	43	250	60	337	TPD2500C□-2599C□	2
	10D-26032-260	26.0~26.9	32	43	260	60	355	TPD2600C□-2699C□	2
	10D-27032-270	27.0~27.9	32	43	270	60	365	TPD2700C□-2799C□	2
10D-28032-280	28.0~28.9	32	43	280	60	376	TPD2800C□-2899C□	2	
10D-29032-290	29.0~29.9	32	43	290	60	388	TPD2900C□-2999C□	2	
10D-30032-300	30.0~30.9	32	43	300	60	398	TPD3000C□-3099C□	2	
TPDC	12D-12016-144	12.0~12.4	16	20	144	48	207	TPD1200C□-1249C□	1
	12D-12516-150	12.5~12.9	16	20	150	48	213	TPD1250C□-1299C□	1
	12D-13016-156	13.0~13.4	16	20	156	48	220	TPD1300C□-1349C□	1
	12D-13516-162	13.5~13.9	16	20	162	48	226	TPD1350C□-1399C□	1
	12D-14016-168	14.0~14.4	16	20	168	48	232	TPD1400C□-1449C□	1
	12D-14516-174	14.5~14.9	16	20	174	48	237	TPD1450C□-1499C□	1
	12D-15020-180	15.0~15.9	20	25	180	50	248	TPD1500C□-1599C□	1
	12D-16020-192	16.0~16.9	20	25	192	50	261	TPD1600C□-1699C□	1
	12D-17020-204	17.0~17.9	20	25	204	50	273	TPD1700C□-1799C□	1
	12D-18025-216	18.0~18.9	25	33	216	56	294	TPD1800C□-1899C□	1
	12D-19025-228	19.0~19.9	25	33	228	56	306	TPD1900C□-1999C□	1
	12D-20025-240	20.0~20.9	25	33	240	56	318	TPD2000C□-2099C□	1
	12D-21025-252	21.0~21.9	25	33	252	56	330	TPD2100C□-2199C□	1
	12D-22025-264	22.0~22.9	25	33	264	56	343	TPD2200C□-2299C□	1
	12D-23025-276	23.0~23.9	25	33	276	56	356	TPD2300C□-2399C□	1
	12D-24032-288	24.0~24.9	32	43	288	60	375	TPD2400C□-2499C□	2
	12D-25032-300	25.0~25.9	32	43	300	60	387	TPD2500C□-2599C□	2
	12D-26032-312	26.0~26.9	32	43	312	60	407	TPD2600C□-2699C□	2
	12D-27032-324	27.0~27.9	32	43	324	60	419	TPD2700C□-2799C□	2
	12D-28032-336	28.0~28.9	32	43	336	60	432	TPD2800C□-2899C□	2
	12D-29032-348	29.0~29.9	32	43	348	60	446	TPD2900C□-2999C□	2
12D-30032-360	30.0~30.9	32	43	360	60	458	TPD3000C□-3099C□	2	

↻ Applicable inserts F48~49

We can provide if you order exact machining specification. Ex) Ø15 and 135 mm depth of cut → TPDC9D-15020-135



# F Technical Information for TPDB Plus Drill

Highly precise and efficient top solid indexable drill

## TPDB Plus Drill

(TPDB Plus / TPDB-F <sup>new</sup> / TPDB-H <sup>new</sup>)

- Highly precise clamping system - Superior clamping precision with auto-centering system and highly precise grinding clamping parts
- Screw on clamping system - Easy to replace inserts
- Sharp cutting edge - Low cutting load and good chip control
- Holder with excellent durability - Holder with high rigidity and excellent wear resistance due to special surface treatment
- Holder with excellent chip control - Low cutting resistance and outstanding chip evaluation applying high helix angle

### Code system

#### • Insert



#### • Holder



### Features

**Special surface treatment**  
• Improved durability of a holder

**Auto-centering system**

**Screw on clamping system**

**High helix angle**  
• High productivity  
- Stable chip evacuation realizes stable machinability  
- Improved cutting conditions decrease cycle time  
• High processing grade  
- Good surface finish and regular size of the hole

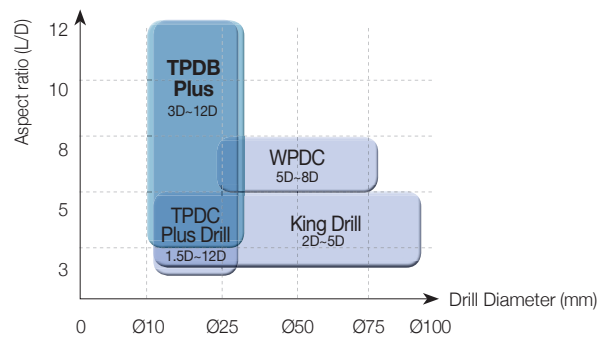
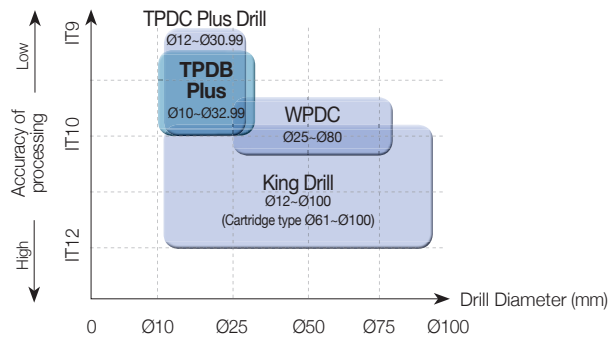
**Advanced chip control due to a chip breaker**

**Cutting edge with low cutting resistance**  
• Low cutting load and excellent chip control

**20% higher productivity**  
← Applying flute with higher helix angle than TPDB's

[ TPDB Plus ] [ TPDB ]

## Application range

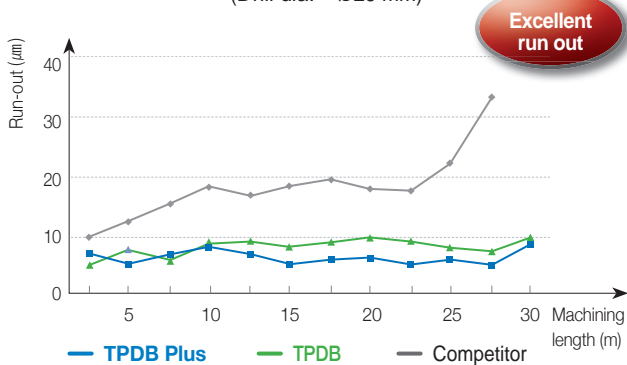


Tools	Application range					
	Application range	Aspect ratio (L/D)	Tolerance of drill dia.	Tolerance	Surface finish of hole (Ra)	Workpiece
TPDB Plus	10–32.99 mm	3, 5, 8, 10, 12	h7	IT10	≤ 2.0 μm	P, K

## Performance evaluation

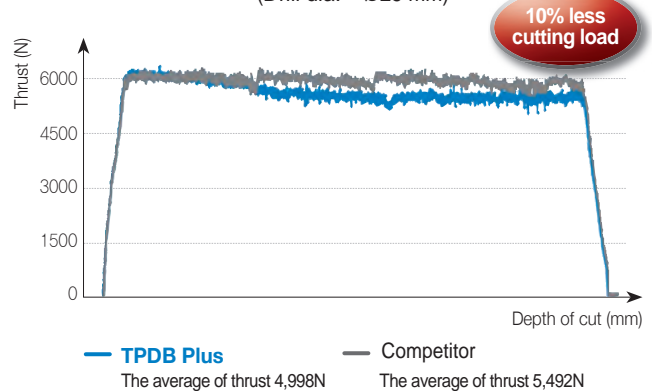
### Run-out

- Workpiece Alloy steel (SCM440)
- Cutting conditions  $vc$  (m/min) = 90,  $fn$  (mm/rev) = 0.25,  $ap$  (mm) = 120, wet (20 bar)
- Tools Insert TPD250B (PC5300)  
Holder TPDB250-32-5-P (Drill dia. = Ø25 mm)



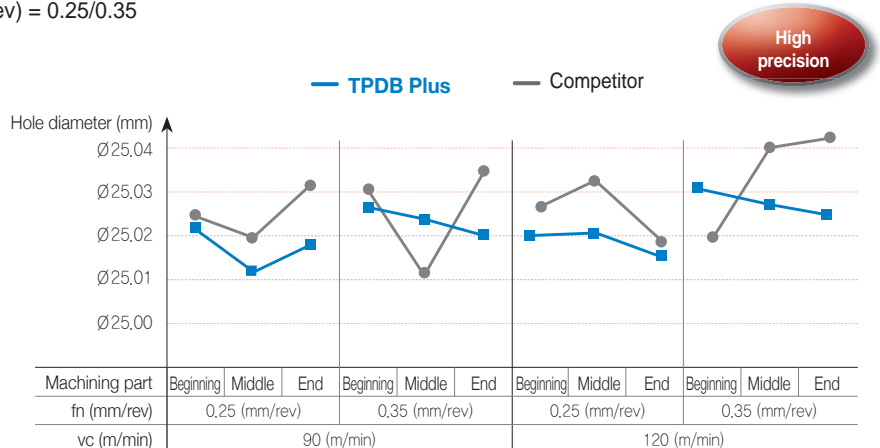
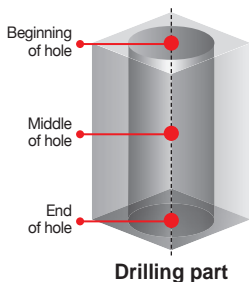
### Cutting load

- Workpiece Alloy steel (SCM440)
- Cutting conditions  $vc$  (m/min) = 120,  $fn$  (mm/rev) = 0.25,  $ap$  (mm) = 120, wet (20 bar)
- Tools Insert TPD250B (PC5300)  
Holder TPDB250-32-5-P (Drill dia. = Ø25 mm)



## Outstanding roundness of hole

- Workpiece Alloy steel (SCM440)
- Cutting conditions  $vc$  (m/min) = 90/120,  $fn$  (mm/rev) = 0.25/0.35,  $ap$  (mm) = 120, wet (20 bar)
- Tools Insert TPD250B (PC5300)  
Holder TPDB250-32-5-P (Drill dia. = Ø25 mm)



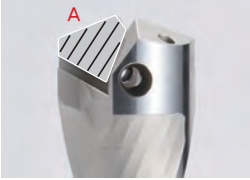
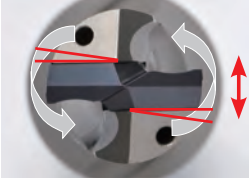
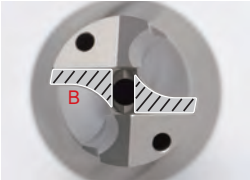



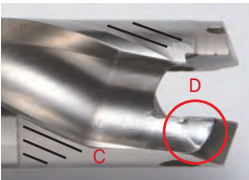
## Recommended Cutting Conditions

Workpiece			Grade	vc (m/min)	Aspect ratio (L/D) = 3D, 5D			
ISO	Workpiece	HB			Feed rate (mm/rev) per drill dia. (mm)			
					Ø10~Ø16.9	Ø17~Ø26.9	Ø27~Ø32.9	
P	Carbon steel	Low carbon steel	80~120	PC5335 PC330P	110 (80~140)	0.15~0.30	0.20~0.35	0.25~0.40
		High carbon steel	180~280	PC5335 PC330P	100 (70~130)	0.15~0.30	0.20~0.35	0.25~0.40
	Alloy steel	Low alloy steel	140~260	PC5300	110 (80~140)	0.18~0.35	0.23~0.38	0.28~0.43
		Low alloy heat treated steel	200~400	PC5300	75 (50~100)	0.18~0.35	0.23~0.38	0.28~0.43
		High alloy steel	50~260	PC5300	70 (50~90)	0.18~0.30	0.20~0.35	0.25~0.40
		High alloy heat treated steel	220~450	PC5300	60 (40~80)	0.18~0.30	0.20~0.35	0.25~0.40
K	Cast iron	Gray cast iron	150~230	PC5300	110 (80~140)	0.18~0.35	0.20~0.40	0.25~0.45
		Ductile cast iron	160~260	PC5300	100 (70~130)	0.18~0.35	0.20~0.40	0.25~0.45

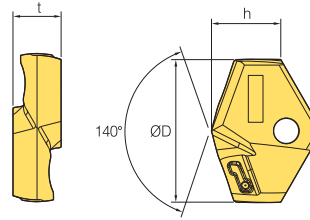
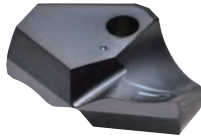
※ In case of 8D, machine in 20-30% lower cutting conditions than the mentioned above, or machine the beginning of hole (1.5D) before drilling.

※ In interrupted machining, reduce the feed to 0.1-0.15 machining around the interrupted part.

## Replacement of Holders and Screws

Worn part	How to check	Description
[Pic.1] 	[Pic.2]  Check the gap	<ul style="list-style-type: none"> <li>In case of drilling for a long time as shown in the [Pic.1] the 'A' part is torn and twisted due to torque.</li> <li>As shown in the [Pic.2] check the gap between the insert and the tip seat turning the clamped insert from side to side. If there is a gap between them, replace the used holder to a new one.</li> </ul>
[Pic.3] 	[Pic.4]  Check the moving	<ul style="list-style-type: none"> <li>The insert could move up or down due to the load on the Z-axis in drilling over an extended period of time which causes wear on the 'B' part as shown the [Pic.3].</li> <li>After clamping an insert, if the insert is moving or there is a gap between the insert and the tip seat as shown in the [Pic.4] replace the used holder to a new one.</li> </ul>
[Pic.5] 	 Check the moving	<ul style="list-style-type: none"> <li>After an extended period of use, the screw can be worn as shown in the 'E' part of [Pic.5] which could decrease the clamping force of the insert. When the screw is worn, replace the old screw to a new one among the enclosed extras.</li> <li>Spreading the grease on the screw makes it last longer.</li> </ul>
[Pic.6] <ol style="list-style-type: none"> <li>Check the 'C' and 'D' parts as shown in the [Pic.6]</li> <li>Check whether the chips are getting longer or not.</li> </ol>		<ul style="list-style-type: none"> <li>Winding or jamming of long and tiny chips in drilling causes wear or scratch on the 'C' part as shown in the [Pic.6] due to chattering from machining in improper cutting conditions. In that case, reset the cutting conditions and check the Run-out before machining.</li> <li>The excessive wear of the part 'D' as shown in the [Pic.6] relating to chip curling might cause long chips.</li> </ul>

Available insert



(mm)



Designation	Coated			ØD	h	t
	PC5300	PC5335	PC330P			
TPD 100B	●			10.0	5.5	3.5
105B	●			10.5	5.5	3.5
110B	●	●		11.0	5.8	3.5
115B	●			11.5	5.8	3.5
120B	●	●		12.0	6.3	3.5
125B	●	●		12.5	6.3	3.5
130B	●			13.0	6.5	4.0
135B	●			13.5	6.5	4.0
140B	●	●		14.0	6.8	4.0
145B	●	●		14.5	6.8	4.0
150B	●	●		15.0	7.0	4.0
155B	●	●		15.5	7.0	4.0
160B	●	●		16.0	7.7	5.5
165B	●			16.5	7.7	5.5
170B	●	●		17.0	7.9	5.5
175B	●	●		17.5	7.9	5.5
180B	●	●		18.0	8.1	6.0
185B	●	●		18.5	8.1	6.0
190B	●	●		19.0	8.3	6.0
195B	●			19.5	8.3	6.0
200B	●	●		20.0	9.7	6.5
205B	●			20.5	9.7	6.5
210B	●	●		21.0	9.4	6.5
215B	●			21.5	9.4	6.5
220B	●	●		22.0	9.6	7.0
225B	●			22.5	9.6	7.0
230B	●	●		23.0	9.8	7.0
235B	●			23.5	9.8	7.0
240B	●	●		24.0	10.7	7.5
245B	●			24.5	10.7	7.5
250B	●	●		25.0	10.9	7.5
255B	●			25.5	10.9	7.5
260B	●	●		26.0	11.0	8.5
265B	●			26.5	11.0	8.5
270B	●			27.0	11.8	8.5
275B	●			27.5	11.8	8.5
280B	●			28.0	12.6	9.5
285B	●			28.5	12.6	9.5
290B	●			29.0	12.9	9.5
295B	●			29.5	12.9	9.5
300B	●			30.0	13.0	10.0
305B	●			30.5	13.0	10.0
310B	●			31.0	13.2	10.0
315B	●			31.5	13.2	10.0
320B	●			32.0	13.4	10.0
325B	●			32.5	13.4	10.0

※ We can provide nonstock items with Ø10.00-Ø32.99

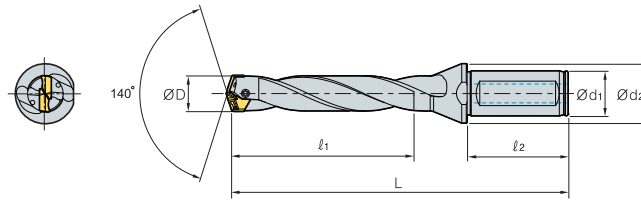
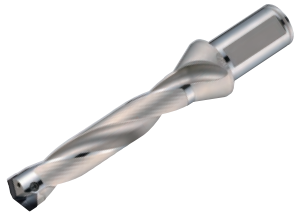
● : Stock Item

Parts

(mm)

Designation	Drill dia. (ØD)	Screw 	Wrench 	Torque (N•m)
TPD 100B~129B	10.0~12.9	FTNB0209-P	TW06P	0.4
130B~149B	13.0~14.9	FTNB02512-P	TW07S	0.8
150B~179B	15.0~17.9	FTNB02514-P	TW07S	0.8
180B~199B	18.0~19.9	FTNB0316-P	TW09S	1.2
200B~239B	20.0~23.9	FTNB0319	TW09S	1.2
240B~259B	24.0~25.9	FTNB03522	TW15S	3.0
260B~279B	26.0~27.9	FTNB03524	TW15S	3.0
280B~299B	28.0~29.9	FTNB0426	TW15S	3.0
300B~329B	30.0~32.9	FTNB0528	TW20-100	4.0

## TPDB-P(3D)



(mm)

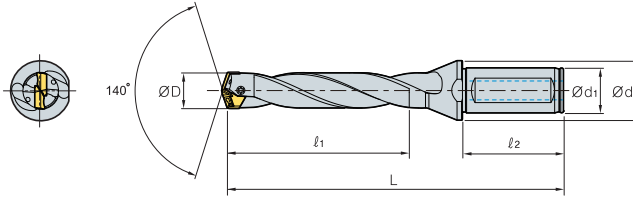
Designation	ØD	Ød <sub>1</sub>	Ød <sub>2</sub>	l <sub>1</sub>	l <sub>2</sub>	L	Insert
<b>TPDB</b> 100-16-3-P	10.0~10.4	16	20	30.0	48	96.6	TPD100B~104B
105-16-3-P	10.5~10.9	16	20	31.5	48	97.6	TPD105B~109B
110-16-3-P	11.0~11.4	16	20	33.0	48	99.7	TPD110B~114B
115-16-3-P	11.5~11.9	16	20	34.5	48	100.7	TPD115B~119B
120-16-3-P	12.0~12.4	16	20	36.0	48	104.1	TPD120B~124B
125-16-3-P	12.5~12.9	16	20	37.5	48	106.2	TPD125B~129B
130-16-3-P	13.0~13.4	16	20	39.0	48	109.3	TPD130B~134B
135-16-3-P	13.5~13.9	16	20	40.5	48	111.4	TPD135B~139B
140-16-3-P	14.0~14.4	16	20	42.0	48	113.5	TPD140B~144B
145-16-3-P	14.5~14.9	16	20	43.5	48	116.6	TPD145B~149B
150-20-3-P	15.0~15.4	20	25	45.0	50	120.7	TPD150B~154B
155-20-3-P	15.5~15.9	20	25	46.5	50	122.7	TPD155B~159B
160-20-3-P	16.0~16.4	20	25	48.0	50	124.9	TPD160B~164B
165-20-3-P	16.5~16.9	20	25	49.5	50	126.9	TPD165B~169B
170-20-3-P	17.0~17.4	20	25	51.0	50	130.1	TPD170B~174B
175-20-3-P	17.5~17.9	20	25	52.5	50	132.1	TPD175B~179B
180-25-3-P	18.0~18.4	25	33	54.0	56	140.2	TPD180B~184B
185-25-3-P	18.5~18.9	25	33	55.5	56	142.2	TPD185B~189B
190-25-3-P	19.0~19.4	25	33	57.0	56	145.3	TPD190B~194B
195-25-3-P	19.5~19.9	25	33	58.5	56	147.3	TPD195B~199B
200-25-3-P	20.0~20.4	25	33	60.0	56	149.5	TPD200B~204B
205-25-3-P	20.5~20.9	25	33	61.5	56	151.5	TPD205B~209B
210-25-3-P	21.0~21.4	25	33	63.0	60	154.7	TPD210B~214B
215-25-3-P	21.5~21.9	25	33	64.5	60	156.7	TPD215B~219B
220-25-3-P	22.0~22.4	25	33	66.0	60	158.9	TPD220B~224B
225-25-3-P	22.5~22.9	25	33	67.5	60	160.9	TPD225B~229B
230-25-3-P	23.0~23.4	25	33	69.0	60	164.1	TPD230B~234B
235-25-3-P	23.5~23.9	25	33	70.5	60	166.1	TPD235B~239B
240-32-3-P	24.0~24.4	32	43	72.0	60	172.3	TPD240B~244B
245-32-3-P	24.5~24.9	32	43	73.5	60	174.3	TPD245B~249B
250-32-3-P	25.0~25.4	32	43	75.0	60	177.5	TPD250B~254B
255-32-3-P	25.5~25.9	32	43	76.5	60	179.5	TPD255B~259B
260-32-3-P	26.0~26.9	32	43	78.0	60	181.7	TPD260B~269B
270-32-3-P	27.0~27.9	32	43	81.0	60	186.9	TPD270B~279B
280-32-3-P	28.0~28.9	32	43	84.0	60	191.0	TPD280B~289B
290-32-3-P	29.0~29.9	32	43	87.0	60	196.2	TPD290B~299B
300-32-3-P	30.0~30.9	32	43	90.0	60	199.4	TPD300B~309B
310-32-3-P	31.0~31.9	32	43	93.0	60	204.6	TPD310B~319B
320-32-3-P	32.0~32.9	32	43	96.0	60	206.8	TPD320B~329B

↻ Applicable inserts F57





# TPDB-P(5D)



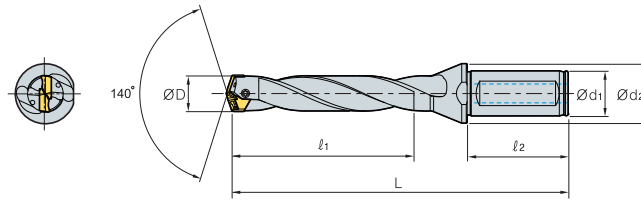
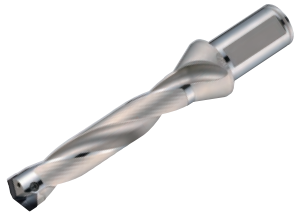
(mm)

Designation	ØD	Ød <sub>1</sub>	Ød <sub>2</sub>	ℓ <sub>1</sub>	ℓ <sub>2</sub>	L	Insert
<b>TPDB</b>							
<b>100-16-5-P</b>	10.0~10.4	16	20	50.0	48	116.1	TPD100B~104B
<b>105-16-5-P</b>	10.5~10.9	16	20	52.5	48	118.9	TPD105B~109B
<b>110-16-5-P</b>	11.0~11.4	16	20	55.0	48	121.7	TPD110B~114B
<b>115-16-5-P</b>	11.5~11.9	16	20	57.5	48	124.5	TPD115B~119B
<b>120-16-5-P</b>	12.0~12.4	16	20	60.0	48	128.1	TPD120B~124B
<b>125-16-5-P</b>	12.5~12.9	16	20	62.5	48	131.2	TPD125B~129B
<b>130-16-5-P</b>	13.0~13.4	16	20	65.0	48	135.3	TPD130B~134B
<b>135-16-5-P</b>	13.5~13.9	16	20	67.5	48	138.4	TPD135B~139B
<b>140-16-5-P</b>	14.0~14.4	16	20	70.0	48	141.5	TPD140B~144B
<b>145-16-5-P</b>	14.5~14.9	16	20	72.5	48	145.6	TPD145B~149B
<b>150-20-5-P</b>	15.0~15.4	20	25	75.0	50	150.7	TPD150B~154B
<b>155-20-5-P</b>	15.5~15.9	20	25	77.5	50	153.7	TPD155B~159B
<b>160-20-5-P</b>	16.0~16.4	20	25	80.0	50	156.9	TPD160B~164B
<b>165-20-5-P</b>	16.5~16.9	20	25	82.5	50	159.9	TPD165B~169B
<b>170-20-5-P</b>	17.0~17.4	20	25	85.0	50	164.1	TPD170B~174B
<b>175-20-5-P</b>	17.5~17.9	20	25	87.5	50	167.1	TPD175B~179B
<b>180-25-5-P</b>	18.0~18.4	25	33	90.0	56	176.2	TPD180B~184B
<b>185-25-5-P</b>	18.5~18.9	25	33	92.5	56	179.2	TPD185B~189B
<b>190-25-5-P</b>	19.0~19.4	25	33	95.0	56	183.3	TPD190B~194B
<b>195-25-5-P</b>	19.5~19.9	25	33	97.5	56	186.3	TPD195B~199B
<b>200-25-5-P</b>	20.0~20.4	25	33	100.0	56	189.5	TPD200B~204B
<b>205-25-5-P</b>	20.5~20.9	25	33	102.5	56	192.5	TPD205B~209B
<b>210-25-5-P</b>	21.0~21.4	25	33	105.0	60	196.7	TPD210B~214B
<b>215-25-5-P</b>	21.5~21.9	25	33	107.5	60	199.7	TPD215B~219B
<b>220-25-5-P</b>	22.0~22.4	25	33	110.0	60	202.9	TPD220B~224B
<b>225-25-5-P</b>	22.5~22.9	25	33	112.5	60	205.9	TPD225B~229B
<b>230-25-5-P</b>	23.0~23.4	25	33	115.0	60	210.1	TPD230B~234B
<b>235-25-5-P</b>	23.5~23.9	25	33	117.5	60	213.1	TPD235B~239B
<b>240-32-5-P</b>	24.0~24.4	32	43	120.0	60	220.3	TPD240B~244B
<b>245-32-5-P</b>	24.5~24.9	32	43	122.5	60	223.3	TPD245B~249B
<b>250-32-5-P</b>	25.0~25.4	32	43	125.0	60	227.5	TPD250B~254B
<b>255-32-5-P</b>	25.5~25.9	32	43	127.5	60	230.5	TPD255B~259B
<b>260-32-5-P</b>	26.0~26.9	32	43	130.0	60	233.7	TPD260B~269B
<b>270-32-5-P</b>	27.0~27.9	32	43	135.0	60	240.9	TPD270B~279B
<b>280-32-5-P</b>	28.0~28.9	32	43	140.0	60	247.0	TPD280B~289B
<b>290-32-5-P</b>	29.0~29.9	32	43	145.0	60	254.2	TPD290B~299B
<b>300-32-5-P</b>	30.0~30.9	32	43	150.0	60	259.4	TPD300B~309B
<b>310-32-5-P</b>	31.0~31.9	32	43	155.0	60	266.6	TPD310B~319B
<b>320-32-5-P</b>	32.0~32.9	32	43	160.0	60	270.8	TPD320B~329B

→ Applicable inserts F57



## TPDB-P(8D)



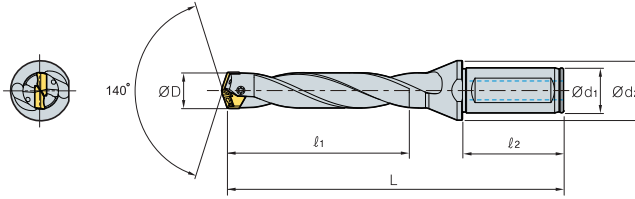
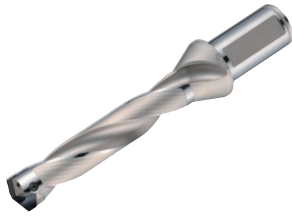
(mm)

Designation	ØD	Ød <sub>1</sub>	Ød <sub>2</sub>	ℓ <sub>1</sub>	ℓ <sub>2</sub>	L	Insert
<b>TPDB</b> 100-16-8-P	10.0~10.4	16	20	80	48	146.1	TPD100B~104B
105-16-8-P	10.5~10.9	16	20	84	48	150.4	TPD105B~109B
110-16-8-P	11.0~11.4	16	20	88	48	154.7	TPD110B~114B
115-16-8-P	11.5~11.9	16	20	92	48	159.0	TPD115B~119B
120-16-8-P	12.0~12.4	16	20	96	48	164.1	TPD120B~124B
125-16-8-P	12.5~12.9	16	20	100	48	168.7	TPD125B~129B
130-16-8-P	13.0~13.4	16	20	104	48	174.3	TPD130B~134B
135-16-8-P	13.5~13.9	16	20	108	48	178.9	TPD135B~139B
140-16-8-P	14.0~14.4	16	20	112	48	183.5	TPD140B~144B
145-16-8-P	14.5~14.9	16	20	116	48	189.1	TPD145B~149B
150-20-8-P	15.0~15.4	20	25	120	50	195.7	TPD150B~154B
155-20-8-P	15.5~15.9	20	25	124	50	200.2	TPD155B~159B
160-20-8-P	16.0~16.4	20	25	128	50	204.9	TPD160B~164B
165-20-8-P	16.5~16.9	20	25	132	50	209.4	TPD165B~169B
170-20-8-P	17.0~17.4	20	25	136	50	215.1	TPD170B~174B
175-20-8-P	17.5~17.9	20	25	140	50	219.6	TPD175B~179B
180-25-8-P	18.0~18.4	25	33	144	56	230.2	TPD180B~184B
185-25-8-P	18.5~18.9	25	33	148	56	234.7	TPD185B~189B
190-25-8-P	19.0~19.4	25	33	152	56	240.3	TPD190B~194B
195-25-8-P	19.5~19.9	25	33	156	56	244.8	TPD195B~199B
200-25-8-P	20.0~20.4	25	33	160	56	249.5	TPD200B~204B
205-25-8-P	20.5~20.9	25	33	164	56	254.0	TPD205B~209B
210-25-8-P	21.0~21.4	25	33	168	60	259.7	TPD210B~214B
215-25-8-P	21.5~21.9	25	33	172	60	264.2	TPD215B~219B
220-25-8-P	22.0~22.4	25	33	176	60	268.9	TPD220B~224B
225-25-8-P	22.5~22.9	25	33	180	60	273.4	TPD225B~229B
230-25-8-P	23.0~23.4	25	33	184	60	279.1	TPD230B~234B
235-25-8-P	23.5~23.9	25	33	188	60	283.6	TPD235B~239B
240-32-8-P	24.0~24.4	32	43	192	60	292.3	TPD240B~244B
245-32-8-P	24.5~24.9	32	43	196	60	296.8	TPD245B~249B
250-32-8-P	25.0~25.4	32	43	200	60	302.5	TPD250B~254B
255-32-8-P	25.5~25.9	32	43	204	60	307.0	TPD255B~259B
260-32-8-P	26.0~26.9	32	43	208	60	311.7	TPD260B~269B
270-32-8-P	27.0~27.9	32	43	216	60	321.9	TPD270B~279B
280-32-8-P	28.0~28.9	32	43	224	60	331.0	TPD280B~289B
290-32-8-P	29.0~29.9	32	43	232	60	341.2	TPD290B~299B
300-32-8-P	30.0~30.9	32	43	240	60	349.4	TPD300B~309B
310-32-8-P	31.0~31.9	32	43	248	60	359.6	TPD310B~319B
320-32-8-P	32.0~32.9	32	43	256	60	366.8	TPD320B~329B

↻ Applicable inserts F57



# TPDB-P(10D)

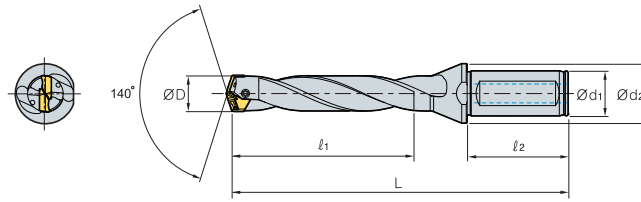
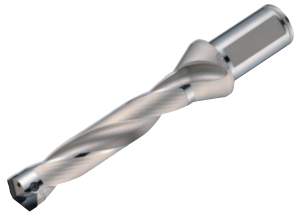


(mm)

Designation	ØD	Ød <sub>1</sub>	Ød <sub>2</sub>	l <sub>1</sub>	l <sub>2</sub>	L	Insert
<b>TPDB</b> 100-16-10-P	10.0~10.4	16	20	100	48	166.6	TPD100B~104B
105-16-10-P	10.5~10.9	16	20	105	48	171.6	TPD105B~109B
110-16-10-P	11.0~11.4	16	20	110	48	176.7	TPD110B~114B
115-16-10-P	11.5~11.9	16	20	115	48	181.7	TPD115B~119B
120-16-10-P	12.0~12.4	16	20	120	48	188.1	TPD120B~124B
125-16-10-P	12.5~12.9	16	20	125	48	193.7	TPD125B~129B
130-16-10-P	13.0~13.4	16	20	130	48	200.3	TPD130B~134B
135-16-10-P	13.5~13.9	16	20	135	48	205.9	TPD135B~139B
140-16-10-P	14.0~14.4	16	20	140	48	211.5	TPD140B~144B
145-16-10-P	14.5~14.9	16	20	145	48	218.1	TPD145B~149B
150-20-10-P	15.0~15.4	20	25	150	50	225.7	TPD150B~154B
155-20-10-P	15.5~15.9	20	25	155	50	231.2	TPD155B~159B
160-20-10-P	16.0~16.4	20	25	160	50	236.9	TPD160B~164B
165-20-10-P	16.5~16.9	20	25	165	50	242.4	TPD165B~169B
170-20-10-P	17.0~17.4	20	25	170	50	249.1	TPD170B~174B
175-20-10-P	17.5~17.9	20	25	175	50	254.6	TPD175B~179B
180-25-10-P	18.0~18.4	25	33	180	56	266.2	TPD180B~184B
185-25-10-P	18.5~18.9	25	33	185	56	271.7	TPD185B~189B
190-25-10-P	19.0~19.4	25	33	190	56	278.3	TPD190B~194B
195-25-10-P	19.5~19.9	25	33	195	56	283.8	TPD195B~199B
200-25-10-P	20.0~20.4	25	33	200	56	289.5	TPD200B~204B
205-25-10-P	20.5~20.9	25	33	205	56	295.0	TPD205B~209B
210-25-10-P	21.0~21.4	25	33	210	60	301.7	TPD210B~214B
215-25-10-P	21.5~21.9	25	33	215	60	307.2	TPD215B~219B
220-25-10-P	22.0~22.4	25	33	220	60	312.9	TPD220B~224B
225-25-10-P	22.5~22.9	25	33	225	60	318.6	TPD225B~229B
230-25-10-P	23.0~23.4	25	33	230	60	325.1	TPD230B~234B
235-25-10-P	23.5~23.9	25	33	235	60	330.6	TPD235B~239B
240-32-10-P	24.0~24.4	32	43	240	60	340.3	TPD240B~244B
245-32-10-P	24.5~24.9	32	43	245	60	345.8	TPD245B~249B
250-32-10-P	25.0~25.4	32	43	250	60	352.5	TPD250B~254B
255-32-10-P	25.5~25.9	32	43	255	60	358.0	TPD255B~259B
260-32-10-P	26.0~26.9	32	43	260	60	363.7	TPD260B~269B
270-32-10-P	27.0~27.9	32	43	270	60	375.9	TPD270B~279B
280-32-10-P	28.0~28.9	32	43	280	60	387.0	TPD280B~289B
290-32-10-P	29.0~29.9	32	43	290	60	399.2	TPD290B~299B
300-32-10-P	30.0~30.9	32	43	300	60	409.4	TPD300B~309B
310-32-10-P	31.0~31.9	32	43	310	60	421.6	TPD310B~319B
320-32-10-P	32.0~32.9	32	43	320	60	430.8	TPD320B~329B

→ Applicable inserts F57

## TPDB-P(12D)



(mm)

Designation	ØD	Ød <sub>1</sub>	Ød <sub>2</sub>	ℓ <sub>1</sub>	ℓ <sub>2</sub>	L	Insert	
TPDB	100-16-12-P	10.0~10.4	16	20	120	48	186.6	TPD100B~104B
	105-16-12-P	10.5~10.9	16	20	126	48	192.6	TPD105B~109B
	110-16-12-P	11.0~11.4	16	20	132	48	198.7	TPD110B~114B
	115-16-12-P	11.5~11.9	16	20	138	48	204.7	TPD115B~119B
	120-16-12-P	12.0~12.4	16	20	144	48	212.1	TPD120B~124B
	125-16-12-P	12.5~12.9	16	20	150	48	218.7	TPD125B~129B
	130-16-12-P	13.0~13.4	16	20	156	48	226.3	TPD130B~134B
	135-16-12-P	13.5~13.9	16	20	162	48	232.9	TPD135B~139B
	140-16-12-P	14.0~14.4	16	20	168	48	239.5	TPD140B~144B
	145-16-12-P	14.5~14.9	16	20	174	48	247.1	TPD145B~149B
	150-20-12-P	15.0~15.4	20	25	180	50	255.7	TPD150B~154B
	155-20-12-P	15.5~15.9	20	25	186	50	262.2	TPD155B~159B
	160-20-12-P	16.0~16.4	20	25	192	50	268.9	TPD160B~164B
	165-20-12-P	16.5~16.9	20	25	198	50	275.4	TPD165B~169B
	170-20-12-P	17.0~17.4	20	25	204	50	283.1	TPD170B~174B
	175-20-12-P	17.5~17.9	20	25	210	50	289.6	TPD175B~179B
	180-25-12-P	18.0~18.4	25	33	216	56	302.2	TPD180B~184B
	185-25-12-P	18.5~18.9	25	33	222	56	308.7	TPD185B~189B
	190-25-12-P	19.0~19.4	25	33	228	56	316.3	TPD190B~194B
	195-25-12-P	19.5~19.9	25	33	234	56	322.8	TPD195B~199B
	200-25-12-P	20.0~20.4	25	33	240	56	329.5	TPD200B~204B
	205-25-12-P	20.5~20.9	25	33	246	56	336.0	TPD205B~209B
	210-25-12-P	21.0~21.4	25	33	252	60	343.7	TPD210B~214B
	215-25-12-P	21.5~21.9	25	33	258	60	350.2	TPD215B~219B
	220-25-12-P	22.0~22.4	25	33	264	60	356.9	TPD220B~224B
	225-25-12-P	22.5~22.9	25	33	270	60	363.6	TPD225B~229B
	230-25-12-P	23.0~23.4	25	33	276	60	371.1	TPD230B~234B
	235-25-12-P	23.5~23.9	25	33	282	60	377.6	TPD235B~239B
	240-32-12-P	24.0~24.4	32	43	288	60	388.3	TPD240B~244B
	245-32-12-P	24.5~24.9	32	43	294	60	394.8	TPD245B~249B
	250-32-12-P	25.0~25.4	32	43	300	60	402.5	TPD250B~254B
	255-32-12-P	25.5~25.9	32	43	306	60	409.0	TPD255B~259B
260-32-12-P	26.0~26.9	32	43	312	60	415.7	TPD260B~269B	
270-32-12-P	27.0~27.9	32	43	324	60	429.9	TPD270B~279B	
280-32-12-P	28.0~28.9	32	43	336	60	443.0	TPD280B~289B	
290-32-12-P	29.0~29.9	32	43	348	60	457.2	TPD290B~299B	
300-32-12-P	30.0~30.9	32	43	360	60	469.4	TPD300B~309B	
310-32-12-P	31.0~31.9	32	43	372	60	483.6	TPD310B~319B	
320-32-12-P	32.0~32.9	32	43	384	60	494.8	TPD320B~329B	

↻ Applicable inserts F57



## Cutting edge with 180° point angle - Flat bottom machining

### TPDB-F **new**

- High precision clamping system - High precision clamping due to high precise grinding and auto-centering
- Screw on clamping system - Easy to replace insert
- Low cutting load cutting edge - Low cutting load and excellent chip control
- High durability holder - Improved wear resistance and durability with special surface treatment implementation
- Holder with good chip evacuation - Good chip evacuation and reduced cutting load with high helix angle

### Code system

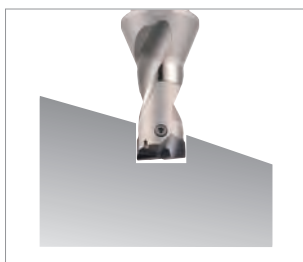
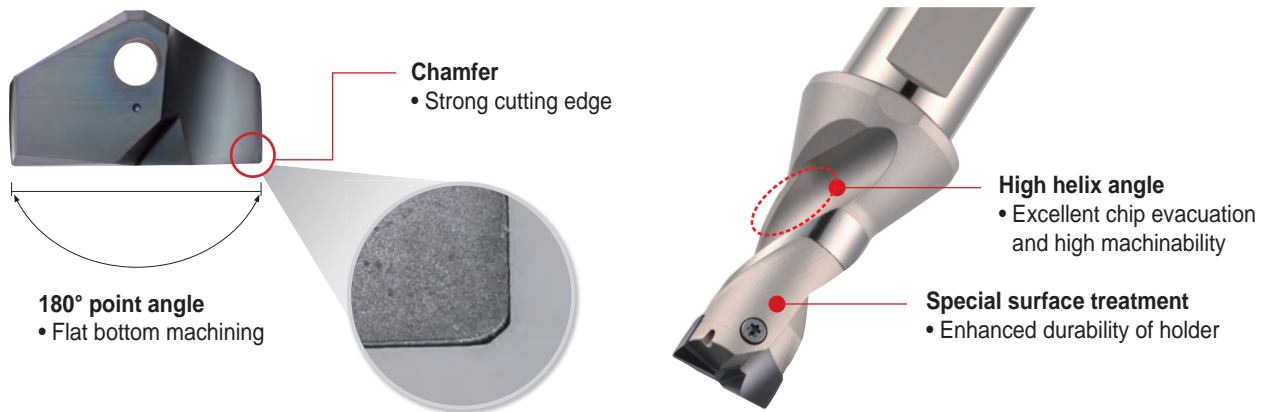
#### • Insert



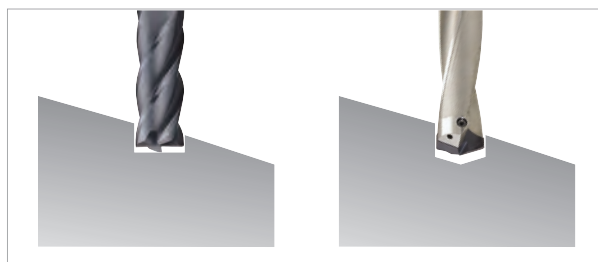
#### • Holder



### Features



[ Endmill + Drill ]

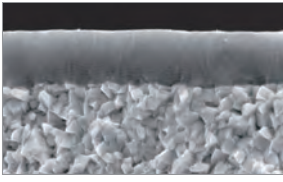


[ Endmill ]

[ Drill ]

# F Technical Information for TPDB-F

## Grade selection



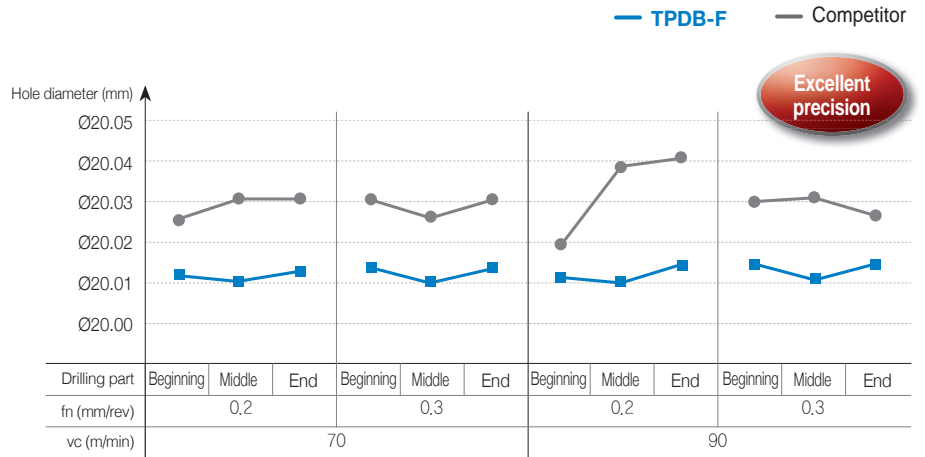
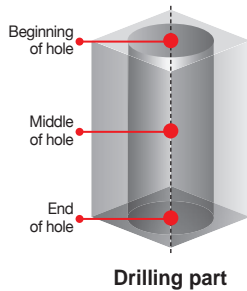
### PC5400

- PVD coating technology with high lubrication, built up edge resistance and chipping resistance
- Excellent chipping resistance due to high toughness coating with high adhesive strength
- Enhanced fracture resistance and stable machinability due to ultra-fine substrate with high toughness substrate

## Performance evaluation

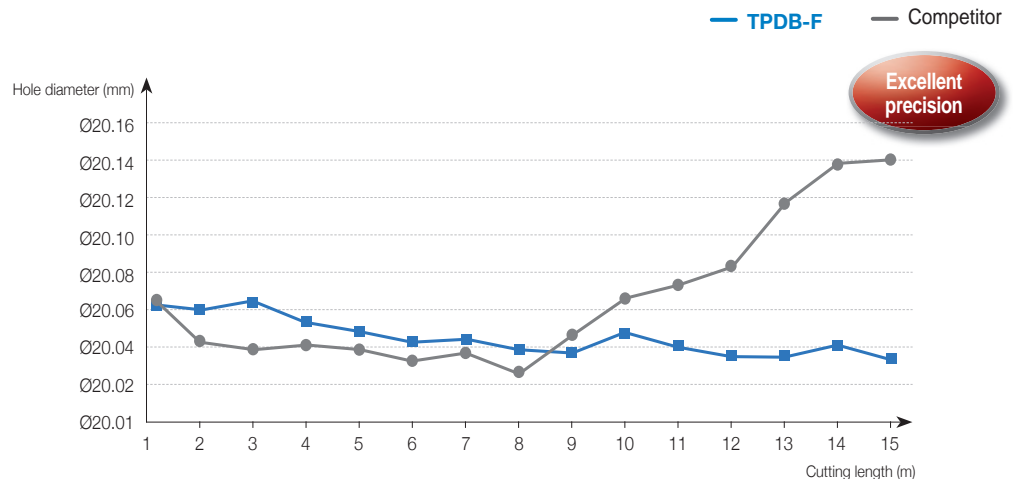
### Precision

- **Workpiece** Alloy steel (SCM440, HRC22)
- **Cutting conditions** vc (m/min) = 70/90, fn (mm/rev) = 0.2/0.3  
ap (mm) = 30, wet (20 bar)
- **Tools** Insert TPD200B-F (PC5400)     **Holder** TPDB200-25-1.5-F (Drill dia. = Ø20 mm)



Cutting edge with low cutting load enhances high precision


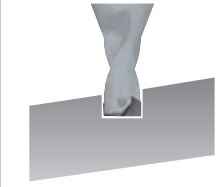
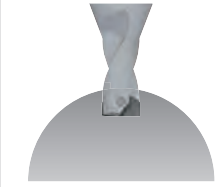


- **Workpiece** Alloy steel (SCM440, HRC22), Angled surface 15°
- **Cutting conditions** vc (m/min) = 70, fn (mm/rev) = 0.21  
ap (mm) = 20, wet (20 bar)
- **Tools** Insert TPD200B-F (PC5400)     **Holder** TPDB200-25-1.5-F (Drill dia. = Ø20 mm)



Cutting edge with low cutting load enhances high precision

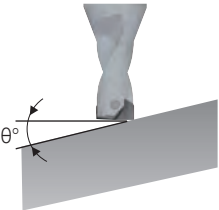
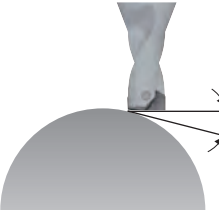
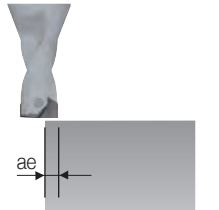
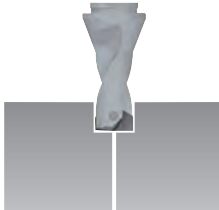
## Recommended cutting condition (TPDB-F)

Workpiece			Grade	vc (m/min)	Aspect ratio (L/D) = 1.5D	
ISO	Workpiece	HB			Feed rate (mm/rev) per drill dia. (mm)	
					Ø14.0~Ø21.9	Ø22.0~Ø30.9
P	Carbon steel	Low carbon steel (SM10C, SM20C etc)	PC5400	80 (60-100)	0.2~0.3	0.22~0.32
		High carbon steel (SM45C, SM50C etc)		70 (50-90)	0.2~0.3	0.22~0.32
	Alloy steel	Low alloy steel (SCM420, SCM440 etc)		70 (50-90)	0.2~0.3	0.22~0.32
		High alloy steel (SCM435, SCM445 etc)		60 (40-80)	0.2~0.3	0.22~0.32

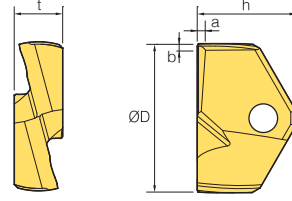
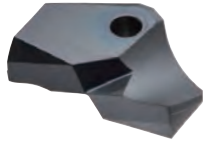
Machining	Flat surface drilling	Angled surface drilling	Curved surface drilling	Plunging	Boring
Pic.					
1.5D	○	○	○	○	○

※ Please refer to the precaution in drilling in case of angled surface, curved surface drilling, plunging and boring

## Precaution in drilling

Angled surface drilling	Curved surface drilling	Plunging	Boring
			
<ul style="list-style-type: none"> <li>Reduce the feed (fn) to 30% than general cutting conditions at the beginning and the end of angled surface (In case, <math>\theta</math> is over <math>30^\circ</math>, reduce it to 50%)</li> </ul>	<ul style="list-style-type: none"> <li>Reduce the feed (fn) to 30% than general cutting conditions at the beginning of curved surface (In case, <math>\theta</math> is over <math>30^\circ</math>, reduce it to 50%)</li> </ul>	<ul style="list-style-type: none"> <li>Reduce the depth of cut (ae) to shorter than 1/2 of drill diameter</li> <li>In case, the depth of cut is longer than drill diameter, plunge with divided depth of cut</li> </ul>	<ul style="list-style-type: none"> <li>Reduce the feed (fn) to 30% than general cutting conditions at the beginning of boring</li> <li>Start with 2 mm stepping before boring to prevent long chip</li> </ul>

## Available insert



(mm)

Designation	Coated	ØD	h	t	a	b
	PC5400					
TPD 140B-F		14.0	8.75	4.0	0.065	0.055
145B-F		14.5	8.75	4.0	0.065	0.055
150B-F		15.0	9.25	4.0	0.065	0.055
155B-F		15.5	9.25	4.0	0.065	0.055
160B-F		16.0	10.25	5.5	0.065	0.055
165B-F		16.5	10.25	5.5	0.065	0.055
170B-F		17.0	10.75	5.5	0.065	0.055
175B-F		17.5	10.75	5.5	0.065	0.055
180B-F		18.0	11.75	6.0	0.065	0.055
185B-F		18.5	11.75	6.0	0.065	0.055
190B-F		19.0	12.25	6.0	0.065	0.055
195B-F		19.5	12.25	6.0	0.065	0.055
200B-F		20.0	12.75	6.5	0.065	0.055
205B-F		20.5	12.75	6.5	0.065	0.055
210B-F		21.0	13.25	6.5	0.065	0.055
215B-F		21.5	13.25	6.5	0.065	0.055
220B-F		22.0	13.75	7.0	0.065	0.055
225B-F		22.5	13.75	7.0	0.065	0.055
230B-F		23.0	14.25	7.0	0.065	0.055
235B-F		23.5	14.25	7.0	0.065	0.055
240B-F		24.0	14.75	7.5	0.065	0.055
245B-F		24.5	14.75	7.5	0.065	0.055
250B-F		25.0	15.25	7.5	0.065	0.055
255B-F		25.5	15.25	7.5	0.065	0.055
260B-F		26.0	15.75	8.5	0.065	0.055
265B-F		26.5	15.75	8.5	0.065	0.055
270B-F		27.0	16.75	8.5	0.065	0.055
275B-F		27.5	16.75	8.5	0.065	0.055
280B-F		28.0	17.75	9.5	0.065	0.055
285B-F		28.5	17.75	9.5	0.065	0.055
290B-F		29.0	18.25	9.5	0.065	0.055
295B-F		29.5	18.25	9.5	0.065	0.055
300B-F		30.0	18.75	10.0	0.065	0.055
305B-F		30.5	18.75	10.0	0.065	0.055

※ We can provide nonstock items with Ø14.00-Ø30.99

## Parts

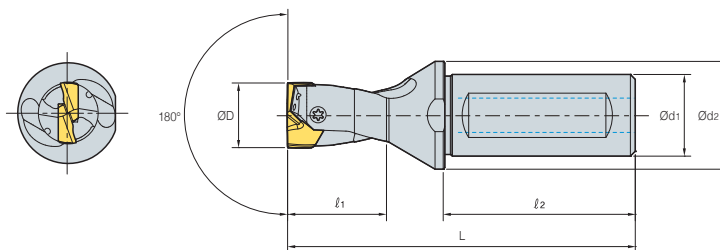
(mm)

Designation	Drill dia. (ØD)	Screw	Wrench	Torque (N•m)
TPD 140B-F~149B-F	14.0~14.9	FTNB02512-P	TW07S	0.8
150B-F~179B-F	15.0~17.9	FTNB02514-P	TW07S	0.8
180B-F~199B-F	18.0~19.9	FTNB0316-P	TW09S	1.2
200B-F~239B-F	20.0~23.9	FTNB0319	TW09S	1.2
240B-F~259B-F	24.0~25.9	FTNB03522	TW15S	3.0
260B-F~279B-F	26.0~27.9	FTNB03524	TW15S	3.0
280B-F~299B-F	28.0~29.9	FTNB0426	TW15S	3.0
300B-F~309B-F	30.0~30.9	FTNB0528	TW20-100	4.0





# TPDB-F(1.5D)



(mm)

Designation	ØD	Ød <sub>1</sub>	Ød <sub>2</sub>	l <sub>1</sub>	l <sub>2</sub>	L	Insert
<b>TPDB</b> 140-16-1.5-F	14.0~14.4	16	20	28	48	86.0	TPD140B-F~TPD144B-F
145-16-1.5-F	14.5~14.9	16	20	29	48	87.0	TPD145B-F~TPD149B-F
150-20-1.5-F	15.0~15.4	20	25	30	50	93.0	TPD150B-F~TPD154B-F
155-20-1.5-F	15.5~15.9	20	25	31	50	94.0	TPD155B-F~TPD159B-F
160-20-1.5-F	16.0~16.4	20	25	32	50	95.0	TPD160B-F~TPD164B-F
165-20-1.5-F	16.5~16.9	20	25	33	50	96.0	TPD165B-F~TPD169B-F
170-20-1.5-F	17.0~17.4	20	25	34	50	97.0	TPD170B-F~TPD174B-F
175-20-1.5-F	17.5~17.9	20	25	35	50	98.0	TPD175B-F~TPD179B-F
180-20-1.5-F	18.0~18.4	20	25	36	50	99.0	TPD180B-F~TPD184B-F
185-20-1.5-F	18.5~18.9	20	25	37	50	100.0	TPD185B-F~TPD189B-F
190-25-1.5-F	19.0~19.4	25	33	38	56	101.0	TPD190B-F~TPD194B-F
195-25-1.5-F	19.5~19.9	25	33	39	56	102.0	TPD195B-F~TPD199B-F
200-25-1.5-F	20.0~20.4	25	33	40	56	116.0	TPD200B-F~TPD204B-F
205-25-1.5-F	20.5~20.9	25	33	41	56	117.0	TPD205B-F~TPD209B-F
210-25-1.5-F	21.0~21.4	25	33	42	56	118.0	TPD210B-F~TPD214B-F
215-25-1.5-F	21.5~21.9	25	33	43	56	119.0	TPD215B-F~TPD219B-F
220-25-1.5-F	22.0~22.4	25	33	44	56	120.0	TPD220B-F~TPD224B-F
225-25-1.5-F	22.5~22.9	25	33	45	56	121.0	TPD225B-F~TPD229B-F
230-25-1.5-F	23.0~23.4	25	33	46	56	122.0	TPD230B-F~TPD234B-F
235-25-1.5-F	23.5~23.9	25	33	47	56	123.0	TPD235B-F~TPD239B-F
240-32-1.5-F	24.0~24.4	32	43	48	60	128.5	TPD240B-F~TPD244B-F
245-32-1.5-F	24.5~24.9	32	43	49	60	129.5	TPD245B-F~TPD249B-F
250-32-1.5-F	25.0~25.4	32	43	50	60	130.5	TPD250B-F~TPD254B-F
255-32-1.5-F	25.5~25.9	32	43	51	60	131.5	TPD255B-F~TPD259B-F
260-32-1.5-F	26.0~26.4	32	43	52	60	132.5	TPD260B-F~TPD264B-F
265-32-1.5-F	26.5~26.9	32	43	53	60	133.5	TPD265B-F~TPD269B-F
270-32-1.5-F	27.0~27.4	32	43	54	60	134.5	TPD270B-F~TPD274B-F
275-32-1.5-F	27.5~27.9	32	43	55	60	135.5	TPD275B-F~TPD279B-F
280-32-1.5-F	28.0~28.4	32	43	56	60	136.5	TPD280B-F~TPD284B-F
285-32-1.5-F	28.5~28.9	32	43	57	60	137.5	TPD285B-F~TPD289B-F
290-32-1.5-F	29.0~29.4	32	43	58	60	138.5	TPD290B-F~TPD294B-F
295-32-1.5-F	29.5~29.9	32	43	59	60	139.5	TPD295B-F~TPD299B-F
300-32-1.5-F	30.0~30.4	32	43	60	60	140.5	TPD300B-F~TPD304B-F
305-32-1.5-F	30.5~30.9	32	43	61	60	141.5	TPD305B-F~TPD309B-F

↻ Applicable inserts F66

# F Technical Information for TPDB-H

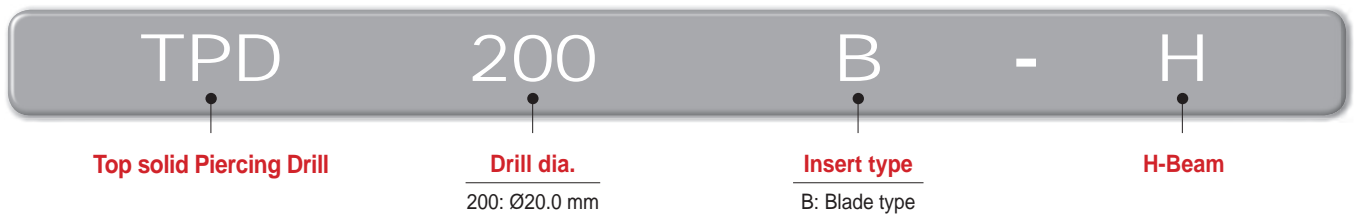
The exclusive top solid indexable drill for steel-frame structure, H-Beam

## TPDB-H new

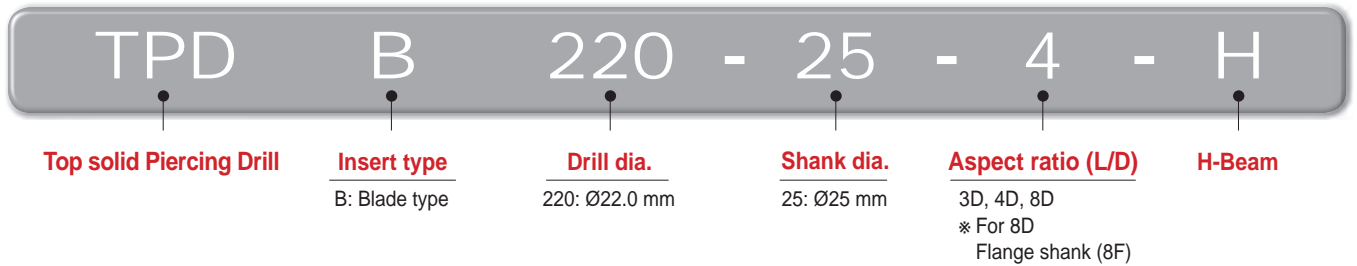
- High precision clamping system - High precision clamping due highly precise grinding and auto-centering
- Screw on clamping system - Easy to replace insert
- Edge design with excellent centering - Low cutting load and good chip control
- High durability holder - Improved wear resistance and durability with special surface treatment implementation
- Holder with good chip evacuation - Good chip evacuation and reduced cutting load with high helix angle
- Optimally designed oil hole - Long tool life

### Code system

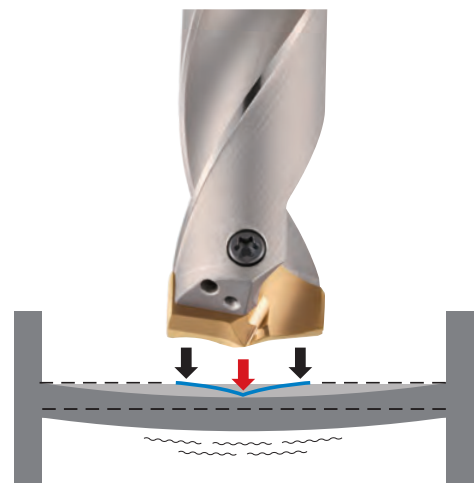
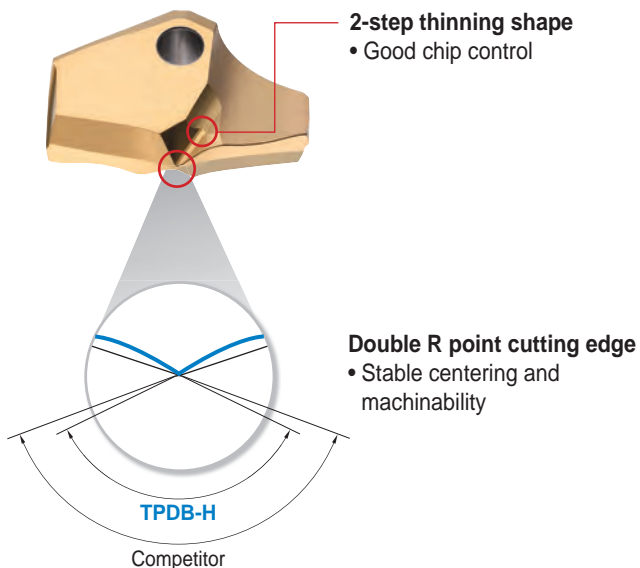
#### • Insert



#### • Holder



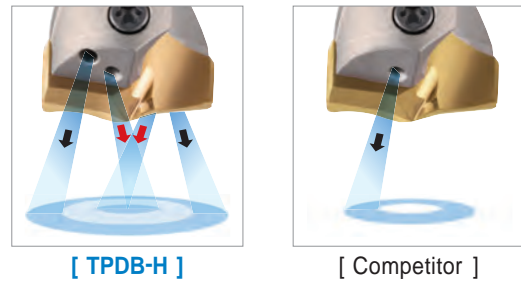
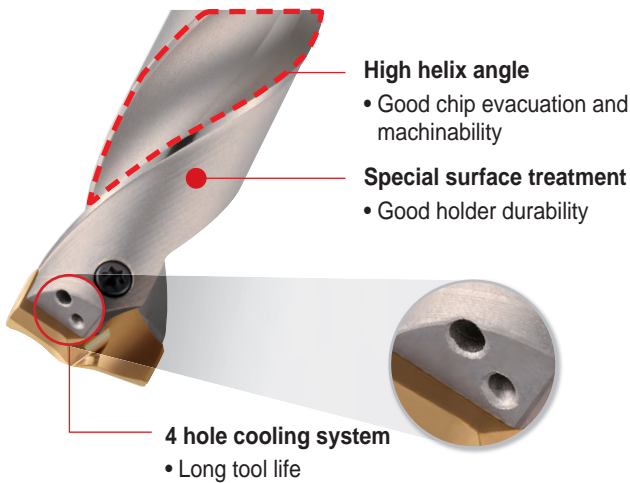
### Features



↓ Applied Double R point edge design is optimized for excellent centering and stable machinability

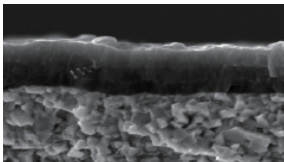
↓ Machinability and productivity are improved by minimizing both workpiece's bending and chipping at edge corner section

## Features of holder



Concentrated coolant injection on delicate cutting edge increases tool life

## Grade selection



**PC340Q** new

- Application of high hardness lubricative PVD coating technology with excellent resistance on wear, welding, and chipping
- The special surface treatment improves chip evacuation and reduces wear on the rake surface and relief face
- High hardness ultra-fine substrate ensures high rigidity of cutting edge and good chipping resistance

## Performance evaluation

### Chip control

- **Workpiece** Carbon steel (SS275, SM355A)
- **Cutting conditions** vc (m/min) = 80, fn (mm/rev) = 0.2  
ap (mm) = 30, wet
- **Tools** **Insert** TPD270B-H (PC340Q)  
**Holder** TPDB270-32-4-H  
(Drill dia. = Ø27 mm)



SS275

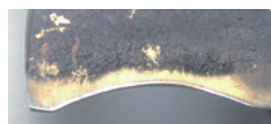


SM355A



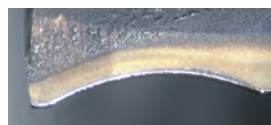
### Wear resistance

- **Workpiece** Carbon steel (SS275)
- **Cutting conditions** vc (m/min) = 65, fn (mm/rev) = 0.25  
ap (mm) = 30, wet
- **Tools** **Insert** TPD220B-H (PC340Q)  
**Holder** TPDB220-25-4-H  
(Drill dia. = Ø22 mm)



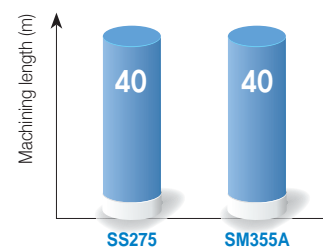
SS275

- **Workpiece** Carbon steel (SM355A)
- **Cutting conditions** vc (m/min) = 70, fn (mm/rev) = 0.25  
ap (mm) = 30, wet
- **Tools** **Insert** TPD270B-H (PC340Q)  
**Holder** TPDB270-32-4-H  
(Drill dia. = Ø27 mm)



SM355A

### Test result



Normal wear and still usable

## Workpiece and recommended cutting conditions

Workpiece			Grade	vc (m/min)	Aspect ratio (L/D) = 3D, 4D		
ISO	Workpiece	Workpiece materials			Feed rate (mm/rev) per drill dia. (mm)		
					Ø14.0~Ø21.0	Ø22.0~Ø30.0	
P	Carbon steel	H-Beam	SS275 (SS400*) SM355 (SM490*) SHN355 (SHN490*)	PC340Q	65 (60~75)	0.2~0.25	0.2~0.3
		Angle					
		Plate					
		Plate (Stacked)			60 (55~65)	0.15~0.25	0.15~0.25

## Precaution in drilling

### Angled surface drilling



- The approach angle between drill and the workpiece at the beginning and the end should be less than 6°
- Reduce the feed (fn) to 30-50% than general cutting conditions at the beginning and the end of angled surface

### Stacked plates drilling



- Gap between the plates could make wrong chip evacuation causing fracture of the drill
- Place stacked plates without any gap between each

### Plunging



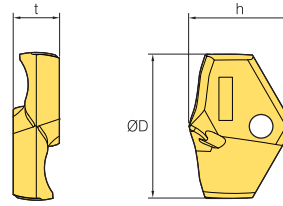
- Irregular cutting resistance in plunging could cause fracture and deformation of the drill

### Boring



- Boring is not recommended due to wear and chipping in the corner of the insert

Available insert



(mm)

Designation	Coated	ØD	h	t
	PC5300			
TPD 140B-H		14.0	10.0	4.0
145B-H		14.5	10.0	4.0
150B-H		15.0	10.5	4.0
155B-H		15.5	10.5	4.0
160B-H		16.0	11.5	5.5
165B-H		16.5	11.5	5.5
170B-H		17.0	12.0	5.5
175B-H		17.5	12.0	5.5
180B-H		18.0	13.0	6.0
185B-H		18.5	13.0	6.0
190B-H		19.0	13.5	6.0
195B-H		19.5	13.5	6.0
200B-H		20.0	14.5	6.5
205B-H		20.5	14.5	6.5
210B-H		21.0	15.0	6.5
215B-H		21.5	15.0	6.5
220B-H		22.0	15.5	7.0
225B-H		22.5	15.5	7.0
230B-H		23.0	16.0	7.0
235B-H		23.5	16.0	7.0
240B-H		24.0	16.5	7.5
245B-H		24.5	16.5	7.5
250B-H		25.0	17.0	7.5
255B-H		25.5	17.0	7.5
260B-H		26.0	17.5	8.5
265B-H		26.5	17.5	8.5
270B-H		27.0	18.5	8.5
275B-H		27.5	18.5	8.5
280B-H		28.0	19.5	9.5
285B-H		28.5	19.5	9.5
290B-H		29.0	20.0	9.5
295B-H		29.5	20.0	9.5
300B-H		30.0	20.5	10.0
305B-H		30.5	20.5	10.0

※ We can provide nonstock items with Ø14.00-Ø30.99

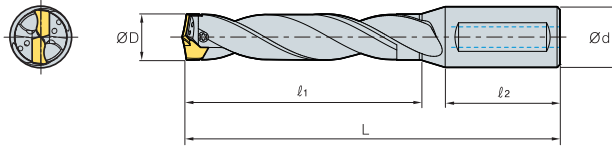
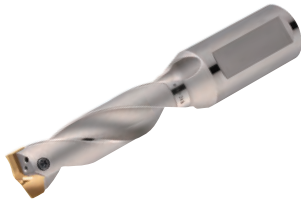
●: Stock Item

Parts

(mm)

Designation	Drill dia. (ØD)	Screw	Wrench	Torque (N•m)
TPD 140B-H~149B-H	14.0~14.9	FTNB02512-P	TW07S	0.8
150B-H~179B-H	15.0~17.9	FTNB02514-P	TW07S	0.8
180B-H~199B-H	18.0~19.9	FTNB0316-P	TW09S	1.2
200B-H~239B-H	20.0~23.9	FTNB0319	TW09S	1.2
240B-H~259B-H	24.0~25.9	FTNB03522	TW15S	3.0
260B-H~279B-H	26.0~27.9	FTNB03524	TW15S	3.0
280B-H~299B-H	28.0~29.9	FTNB0426	TW15S	3.0
300B-H~309B-H	30.0~30.9	FTNB0528	TW20-100	4.0

# TPDB-H(3D)

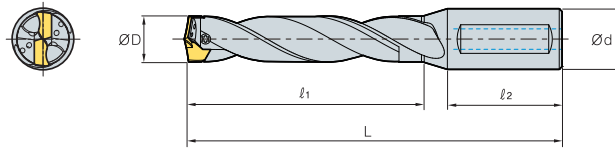
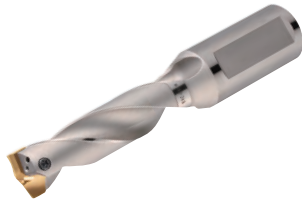


(mm)

Designation	ØD	Ød	ℓ <sub>1</sub>	ℓ <sub>2</sub>	L	Insert	
TPDB	140-16-3-H	14.0~14.4	16	42	48	98.8	TPD140B-144B-H
	145-16-3-H	14.5~14.9	16	43.5	48	100.8	TPD145B-149B-H
	150-20-3-H	15.0~15.4	20	45	50	104.4	TPD150B-154B-H
	155-20-3-H	15.5~15.9	20	46.5	50	106.4	TPD155B-159B-H
	160-20-3-H	16.0~16.4	20	48	50	108.0	TPD160B-164B-H
	165-20-3-H	16.5~16.9	20	49.5	50	110.0	TPD165B-169B-H
	170-20-3-H	17.0~17.4	20	51	50	111.5	TPD170B-174B-H
	175-20-3-H	17.5~17.9	20	52.5	50	113.5	TPD175B-179B-H
	180-20-3-H	18.0~18.4	20	54	50	115.1	TPD180B-184B-H
	185-20-3-H	18.5~18.9	20	55.5	50	117.1	TPD185B-189B-H
	190-20-3-H	19.0~19.4	20	57	50	118.7	TPD190B-194B-H
	195-20-3-H	19.5~19.9	20	58.5	50	120.7	TPD195B-199B-H
	200-25-3-H	20.0~20.4	25	60	56	128.3	TPD200B-204B-H
	205-25-3-H	20.5~20.9	25	61.5	56	130.3	TPD205B-209B-H
	210-25-3-H	21.0~21.4	25	63	56	131.9	TPD210B-214B-H
	215-25-3-H	21.5~21.9	25	64.5	56	133.9	TPD215B-219B-H
	220-25-3-H	22.0~22.4	25	66	56	135.5	TPD220B-224B-H
	225-25-3-H	22.5~22.9	25	67.5	56	137.5	TPD225B-229B-H
	230-25-3-H	23.0~23.4	25	69	56	139.1	TPD230B-234B-H
	235-25-3-H	23.5~23.9	25	70.5	56	141.1	TPD235B-239B-H
	240-32-3-H	24.0~24.4	32	72	60	146.8	TPD240B-244B-H
	245-32-3-H	24.5~24.9	32	73.5	60	148.8	TPD245B-249B-H
	250-32-3-H	25.0~25.4	32	75	60	150.3	TPD250B-254B-H
	255-32-3-H	25.5~25.9	32	76.5	60	152.3	TPD255B-259B-H
	260-32-3-H	26.0~26.4	32	78	60	153.8	TPD260B-264B-H
	265-32-3-H	26.5~26.9	32	79.5	60	155.8	TPD265B-269B-H
	270-32-3-H	27.0~27.4	32	81	60	157.5	TPD270B-274B-H
	275-32-3-H	27.5~27.9	32	82.5	60	159.5	TPD275B-279B-H
	280-32-3-H	28.0~28.4	32	84	60	161.0	TPD280B-284B-H
	285-32-3-H	28.5~28.9	32	85.5	60	163.0	TPD285B-289B-H
290-32-3-H	29.0~29.4	32	87	60	164.6	TPD290B-294B-H	
295-32-3-H	29.5~29.9	32	88.5	60	166.6	TPD295B-299B-H	
300-32-3-H	30.0~30.9	32	90	60	168.2	TPD300B-309B-H	

↻ Applicable inserts F71

# TPDB-H(4D)



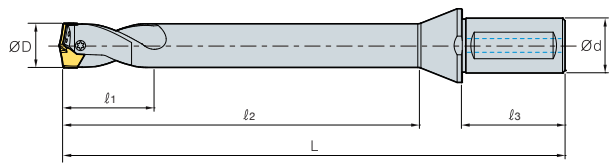
(mm)

Designation	ØD	Ød	l <sub>1</sub>	l <sub>2</sub>	L	Insert	
TPDB	140-16-4-H	14.0~14.4	16	56	48	112.8	TPD140B-144B-H
	145-16-4-H	14.5~14.9	16	58	48	115.3	TPD145B-149B-H
	150-20-4-H	15.0~15.4	20	60	50	119.4	TPD150B-154B-H
	155-20-4-H	15.5~15.9	20	62	50	121.9	TPD155B-159B-H
	160-20-4-H	16.0~16.4	20	64	50	124.0	TPD160B-164B-H
	165-20-4-H	16.5~16.9	20	66	50	126.5	TPD165B-169B-H
	170-20-4-H	17.0~17.4	20	68	50	128.5	TPD170B-174B-H
	175-20-4-H	17.5~17.9	20	70	50	131.0	TPD175B-179B-H
	180-20-4-H	18.0~18.4	20	72	50	133.1	TPD180B-184B-H
	185-20-4-H	18.5~18.9	20	74	50	135.6	TPD185B-189B-H
	190-20-4-H	19.0~19.4	20	76	50	137.7	TPD190B-194B-H
	195-20-4-H	19.5~19.9	20	78	50	140.2	TPD195B-199B-H
	200-25-4-H	20.0~20.4	25	80	56	148.3	TPD200B-204B-H
	205-25-4-H	20.5~20.9	25	82	56	150.8	TPD205B-209B-H
	210-25-4-H	21.0~21.4	25	84	56	152.9	TPD210B-214B-H
	215-25-4-H	21.5~21.9	25	86	56	155.4	TPD215B-219B-H
	220-25-4-H	22.0~22.4	25	88	56	157.5	TPD220B-224B-H
	225-25-4-H	22.5~22.9	25	90	56	160.0	TPD225B-229B-H
	230-25-4-H	23.0~23.4	25	92	56	162.1	TPD230B-234B-H
	235-25-4-H	23.5~23.9	25	94	56	164.6	TPD235B-239B-H
	240-32-4-H	24.0~24.4	32	96	60	170.8	TPD240B-244B-H
	245-32-4-H	24.5~24.9	32	98	60	173.3	TPD245B-249B-H
	250-32-4-H	25.0~25.4	32	100	60	175.3	TPD250B-254B-H
	255-32-4-H	25.5~25.9	32	102	60	177.8	TPD255B-259B-H
	260-32-4-H	26.0~26.4	32	104	60	179.8	TPD260B-264B-H
	265-32-4-H	26.5~26.9	32	106	60	182.3	TPD265B-269B-H
	270-32-4-H	27.0~27.4	32	108	60	184.5	TPD270B-274B-H
	275-32-4-H	27.5~27.9	32	110	60	187.0	TPD275B-279B-H
	280-32-4-H	28.0~28.4	32	112	60	189.0	TPD280B-284B-H
	285-32-4-H	28.5~28.9	32	114	60	191.5	TPD285B-289B-H
	290-32-4-H	29.0~29.4	32	116	60	193.6	TPD290B-294B-H
	295-32-4-H	29.5~29.9	32	118	60	196.1	TPD295B-299B-H
300-32-4-H	30.0~30.9	32	120	60	198.2	TPD300B-309B-H	

↻ Applicable inserts F71



# TPDB-H(8D)



(mm)

Designation	ØD	Ød	ℓ <sub>1</sub>	ℓ <sub>2</sub>	ℓ <sub>3</sub>	L	Insert	
<b>TPDB</b>	<b>140-16-8F-H</b>	14.0~14.4	16	50	112	48	176.3	TPD140B-144B-H
	<b>145-16-8F-H</b>	14.5~14.9	16	50	116	48	180.3	TPD145B-149B-H
	<b>150-20-8F-H</b>	15.0~15.4	20	50	120	50	187.4	TPD150B-154B-H
	<b>155-20-8F-H</b>	15.5~15.9	20	50	124	50	191.4	TPD155B-159B-H
	<b>160-20-8F-H</b>	16.0~16.4	20	50	128	50	196.5	TPD160B-164B-H
	<b>165-20-8F-H</b>	16.5~16.9	20	50	132	50	200.5	TPD165B-169B-H
	<b>170-20-8F-H</b>	17.0~17.4	20	50	136	50	205.5	TPD170B-174B-H
	<b>175-20-8F-H</b>	17.5~17.9	20	50	140	50	209.5	TPD175B-179B-H
	<b>180-20-8F-H</b>	18.0~18.4	20	50	144	50	215.6	TPD180B-184B-H
	<b>185-20-8F-H</b>	18.5~18.9	20	50	148	50	219.6	TPD185B-189B-H
	<b>190-20-8F-H</b>	19.0~19.4	20	50	152	50	223.7	TPD190B-194B-H
	<b>195-20-8F-H</b>	19.5~19.9	20	50	156	50	227.7	TPD195B-199B-H
	<b>200-25-8F-H</b>	20.0~20.4	25	50	160	56	237.8	TPD200B-204B-H
	<b>205-25-8F-H</b>	20.5~20.9	25	50	164	56	241.8	TPD205B-209B-H
	<b>210-25-8F-H</b>	21.0~21.4	25	50	168	56	245.9	TPD210B-214B-H
	<b>215-25-8F-H</b>	21.5~21.9	25	50	172	56	249.9	TPD215B-219B-H
	<b>220-25-8F-H</b>	22.0~22.4	25	50	176	56	254.0	TPD220B-224B-H
	<b>225-25-8F-H</b>	22.5~22.9	25	50	180	56	263.0	TPD225B-229B-H
	<b>230-25-8F-H</b>	23.0~23.4	25	50	184	56	267.1	TPD230B-234B-H
	<b>235-25-8F-H</b>	23.5~23.9	25	50	188	56	271.1	TPD235B-239B-H
	<b>240-32-8F-H</b>	24.0~24.4	32	50	192	60	279.3	TPD240B-244B-H
	<b>245-32-8F-H</b>	24.5~24.9	32	50	196	60	283.3	TPD245B-249B-H
	<b>250-32-8F-H</b>	25.0~25.4	32	50	200	60	287.3	TPD250B-254B-H
	<b>255-32-8F-H</b>	25.5~25.9	32	50	204	60	291.3	TPD255B-259B-H
	<b>260-32-8F-H</b>	26.0~26.4	32	50	208	60	295.3	TPD260B-264B-H
	<b>265-32-8F-H</b>	26.5~26.9	32	50	212	60	299.3	TPD265B-269B-H
	<b>270-32-8F-H</b>	27.0~27.4	32	50	216	60	303.5	TPD270B-274B-H
	<b>275-32-8F-H</b>	27.5~27.9	32	50	220	60	307.5	TPD275B-279B-H
	<b>280-32-8F-H</b>	28.0~28.4	32	50	224	60	313.5	TPD280B-284B-H
	<b>285-32-8F-H</b>	28.5~28.9	32	50	228	60	317.5	TPD285B-289B-H
<b>290-32-8F-H</b>	29.0~29.4	32	50	232	60	322.6	TPD290B-294B-H	
<b>295-32-8F-H</b>	29.5~29.9	32	50	236	60	326.6	TPD295B-299B-H	
<b>300-32-8F-H</b>	30.0~30.9	32	50	240	60	330.7	TPD300B-309B-H	

↻ Applicable inserts F71

※ The maximum length of flute could be ℓ<sub>2</sub>

Convenient and quickly adjustable drill height

# WPDC

## Indexable Drill Clamped with Center Drill

### Code system

#### • Holder

WPDC	410	40	8
<b>Type</b>	<b>Drill dia.</b>	<b>Shank dia.</b>	<b>Aspect ratio (L/D)</b>
WPDC: Using W-type I/S center drill NPDC: Using N-type I/S center drill	410: Ø41.0 6570: Ø65~70	32: Ø32 40: Ø40	5: 5D 6.5: 6.5D 8: 8D

#### • Cartridge

CWP	4145	C
<b>Type</b>	<b>Drill dia.</b>	<b>Classification</b>
CWP: Cartridge-WPDC	4145: Ø41~45 450: Ø45.0	C: Central P: Peripheral

#### • Center drill

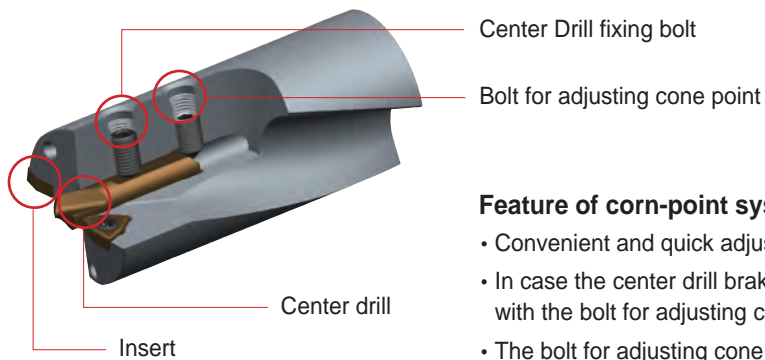
CD	H	1035
<b>Type</b>	<b>Coolant</b>	<b>Diameter × length of tool</b>
Center Drill	H: Coolant Unmarked: None	0630: Ø6X30 0835: Ø8X35 1035: Ø10X35 1238: Ø12X38 1645: Ø16X45

#### • Grade

PC	40H
<b>Product name</b>	<b>Coating layer</b>
PVD coating	40H: TiN coating

# F Technical Information for WPDC

## How to clamp the drills



### Feature of corn-point system

- Convenient and quick adjustable heights when inserting the center drill
- In case the center drill brakes while in usage, it can be replaced with the bolt for adjusting cone point
- The bolt for adjusting cone point prevents chattering on the center drill

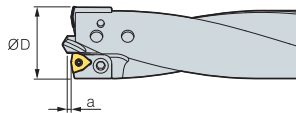
## Clamping

1	2	3	4	5
Place a center drill	Clamp insert and cartridge	Adjust the center drill with the bolt for adjusting cone point	Clamp the center drill firmly with fixing bolt	Reassure the clamp with bolt for adjusting cone point

- ※ Use safety covers for your safety when clamping the center drill and insert
- ※ When machining, be careful of the drill disk

## Length of the 'a' part of center drill

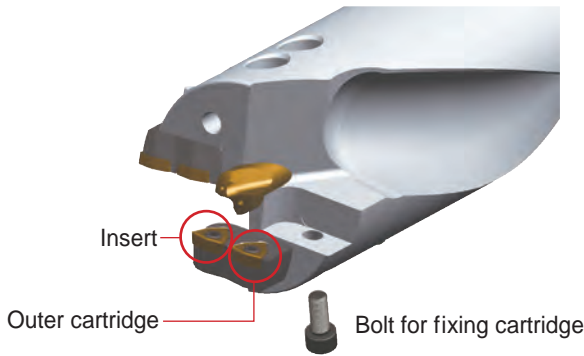
- The length of 'a' being too short can cause bad surface finish or high cutting load
- On the other hand, the length of 'a' being too long can make tool failure and chattering while drilling



Diameter (ØD)	Length of the 'a' part of center drill		
	Steel	Alloy steel	Non-ferrous metal
25~30	1.2	1.0	1.5
31~40	1.5	1.3	1.8
41~50	1.8	1.5	2.2
51~59	2.2	1.8	2.5
60~75	2.5	2.0	2.8
76~80	3.0	2.5	3.5

## Adjusting diameter of cartridge type drill

- 1) Disassemble a cartridge from the holder by loosening the bolt fixed for outer cartridge
- 2) Machine after calculating the hole size on the side of the outer cartridge
- 3) Trim the sharp part after machining
- 4) Clamp the bolt for fixing cartridge without any gap in between the holder and the machined outer cartridge



### 1) Range of adjustable drill diameter

1. Single cartridge type (Drill diameter  $\varnothing 41\sim\varnothing 59$ )  $\rightarrow$  -1.0 mm
2. Dual cartridge type (Drill diameter  $\varnothing 60\sim\varnothing 80$ )  $\rightarrow$  -5.0 mm

### 2) Diameter of the standard drills is provided with maximum size of standards

Ex) WPDC6570-40-6.5  $\rightarrow$  Drill diameter 70.0 mm

Ex) How to adjust drill diameter to  $\varnothing 66.0$  machining with WPDC6570-40-8

$\rightarrow$  To make the drill diameter of outer cartridge to  $\varnothing 66.0$ , machine 2.0 mm ( $\varnothing 70.0 - \varnothing 66.0 = 4 \rightarrow 4 \div 2 = 2$  (radius))

## Recommended cutting condition

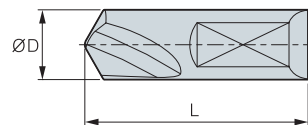
Workpiece			Chip breaker	Grade	vc (m/min)	Aspect ratio (L/D) = 5D, 6.5D, 8D						
ISO	Workpiece	HB				Feed rate (mm/rev) per drill dia. (mm)						
						$\sim\varnothing 30$	$\varnothing 31\sim\varnothing 40$	$\varnothing 41\sim\varnothing 50$	$\varnothing 51\sim\varnothing 59$	$\varnothing 60\sim\varnothing 75$	$\varnothing 76\sim\varnothing 80$	
P	Carbon steel	Low carbon steel ( $\sim 0.25\%$ )	80~180	C21N	PC5335	190 (160~220)	0.07~0.11	0.08~0.12	0.10~0.14	0.12~0.16	0.12~0.16	0.12~0.16
		High carbon steel (0.25%~)	180~280	C21N	PC5335	140 (110~170)	0.07~0.11	0.08~0.12	0.10~0.14	0.12~0.16	0.12~0.16	0.12~0.16
	Alloy steel	Low alloy steel	140~260	C21N	PC5335	130 (100~160)	0.08~0.12	0.08~0.12	0.10~0.14	0.12~0.18	0.12~0.18	0.12~0.18
		High alloy steel	50~260	C21N	PC5335	100 (70~130)	0.06~0.10	0.08~0.12	0.08~0.12	0.10~0.16	0.10~0.16	0.10~0.16
M	Stainless steel	Stainless steel	135~275	C21N	PC5335	100 (70~130)	0.06~0.10	0.08~0.12	0.10~0.12	0.12~0.14	0.12~0.14	0.12~0.14
K	Cast iron	Gray cast iron	150~220	C21N	PC5335	160 (130~190)	0.09~0.15	0.10~0.16	0.12~0.2	0.14~0.22	0.14~0.22	0.14~0.22
		Ductile cast iron	200~300	C21N	PC5335	140 (170~110)	0.09~0.15	0.10~0.16	0.12~0.2	0.14~0.22	0.14~0.22	0.14~0.22
		Malleable cast iron	130~230	C21N	PC5335	150 (180~120)	0.09~0.15	0.10~0.16	0.12~0.2	0.14~0.22	0.14~0.22	0.14~0.22
N	Non-ferrous metal	Aluminum	30~150	C21N	PC5335	300 (250~350)	0.08~0.12	0.10~0.14	0.12~0.16	0.14~0.18	0.14~0.18	0.14~0.18
		Alloyed copper	150~160	C21N	PC5335	250 (200~300)	0.08~0.12	0.10~0.14	0.12~0.16	0.14~0.18	0.14~0.18	0.14~0.18
S	Heat resistant alloy	Heat resistant alloy	130~400	C21N	PC5335	50 (70~30)	0.05~0.08	0.05~0.08	0.06~0.10	0.06~0.10	0.06~0.10	0.06~0.10

## Parts of WPDC type indexable drills

Designation	ØD	Insert			Center drill			Cartridge		
		Insert	Screw	Wrench	Center drill	fixed bolt	cone point bolt	Inner	Outer	Fixed bolt
WPDC250-32-□	25	WC□T030204-C21N	FTKA02206	TW06S	CD0630	KHA0508	KHC0510	CWP4145C	CWP410P	BHA0510
WPDC260~280-32-□	26~28	WC□T040204-C21N	FTNA02555	TW07S						
WPDC290~300-32-□	29~30					WC□T050308-C21N	FTKA0307		TW09S	CD0835
WPDC310~350-32-□	31~35	WC□T06T308-C21N	FTKA03508	TW15S	CDH1035					
WPDC360~400-32-□	36~40					WC□T06T308-C21N	FTKA03508		TW15S	CDH1035
WPDC410-40-□	41	WC□T06T308-C21N	FTKA03508	TW15S	CDH1035					
WPDC420-40-□	42					WC□T06T308-C21N	FTKA03508		TW15S	CDH1035
WPDC430-40-□	43	WC□T06T308-C21N	FTKA03508	TW15S	CDH1035					
WPDC440-40-□	44					WC□T06T308-C21N	FTKA03508		TW15S	CDH1035
WPDC450-40-□	45	WC□T06T308-C21N	FTKA03508	TW15S	CDH1035					
WPDC460-40-□	46					WC□T06T308-C21N	FTKA03508	TW15S	CDH1035	KHC0812
WPDC470-40-□	47	WC□T06T308-C21N	FTKA03508	TW15S	CDH1035					
WPDC480-40-□	48					WC□T06T308-C21N	FTKA03508	TW15S	CDH1035	KHC0812
WPDC490-40-□	49	WC□T06T308-C21N	FTKA03508	TW15S	CDH1035					
WPDC500-40-□	50					WC□T06T308-C21N	FTKA03508	TW15S	CDH1035	KHC0812
WPDC510-40-□	51	WC□T06T308-C21N	FTKA03508	TW15S	CDH1035					
WPDC520-40-□	52					WC□T06T308-C21N	FTKA03508	TW15S	CDH1035	KHC0812
WPDC530-40-□	53	WC□T06T308-C21N	FTKA03508	TW15S	CDH1035					
WPDC540-40-□	54					WC□T06T308-C21N	FTKA03508	TW15S	CDH1035	KHC0812
WPDC550-40-□	55	WC□T06T308-C21N	FTKA03508	TW15S	CDH1035					
WPDC560-40-□	56					WC□T06T308-C21N	FTKA03508	TW15S	CDH1035	KHC0812
WPDC570-40-□	57	WC□T06T308-C21N	FTKA03508	TW15S	CDH1035					
WPDC580-40-□	58					WC□T06T308-C21N	FTKA03508	TW15S	CDH1035	KHC0812
WPDC590-40-□	59	WC□T06T308-C21N	FTKA03508	TW15S	CDH1035					
WPDC6065-40-□	60~65					WC□T050308-C21N	FTKA0307	TW09S	CDH1238	KHA1015
WPDC6570-40-□	65~70	WC□T050308-C21N	FTKA0307	TW09S	CDH1238					
WPDC7075-40-□	70~75					WC□T050308-C21N	FTKA0307	TW09S	CDH1238	KHA1015
WPDC7580-40-□	75~80	WC□T050308-C21N	FTKA0307	TW09S	CDH1238					
						WC□T06T308-C21N	FTKA03508	TW15S	CDH1645	KHA1020
		WC□T06T308-C21N	FTKA03508	TW15S	CDH1645					
						WC□T06T308-C21N	FTKA03508	TW15S	CDH1645	KHA1020
		WC□T06T308-C21N	FTKA03508	TW15S	CDH1645					

↻ Applicable inserts F03-04

## Center Drill



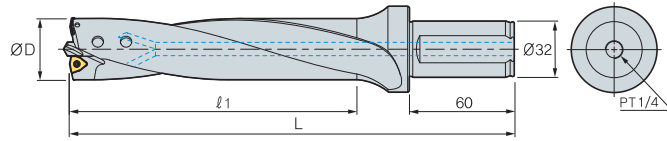
(mm)

Designation	Grade	ØD	L	Oil-hole
CD 0630	PC40H	6	30	×
CD 0835	PC40H	8	35	×
CDH 1035	PC40H	10	35	○
CDH 1238	PC40H	12	38	○
CDH 1645	PC40H	16	45	○

• This is HSS with Tin coating

# WPDC(5D/6.5D/8D)

Standard type



(mm)

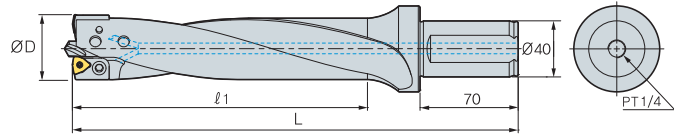
Designation	ØD	5D		6.5D		8D		Insert	Center drill	
		ℓ <sub>1</sub>	L	ℓ <sub>1</sub>	L	ℓ <sub>1</sub>	L			
WPDC	250-32-□	25	150	240	185	275	220	310	WC□T030204-C21N	CD0630
	260-32-□	26	150	240	185	275	220	310		
	270-32-□	27	150	240	185	275	220	310		
	280-32-□	28	150	240	185	275	220	310		
	290-32-□	29	150	240	185	275	220	310		
	300-32-□	30	150	240	185	275	220	310		
	310-32-□	31	175	265	218	308	260	350	WC□T050308-C21N	CD0835
	320-32-□	32	175	265	218	308	260	350		
	330-32-□	33	175	265	218	308	260	350		
	340-32-□	34	175	265	218	308	260	350		
	350-32-□	35	175	265	218	308	260	350		
	360-32-□	36	200	290	250	340	300	390		
	370-32-□	37	200	290	250	340	300	390		
	380-32-□	38	200	290	250	340	300	390		
	390-32-□	39	200	290	250	340	300	390		
	400-32-□	40	200	290	250	340	300	390		

↻ Applicable inserts **F04**

\* We can provide if you order exact diameter  
Ex) machining hole 32.5 mm • 6.5D → WPDC325-32-6.5

# WPDC(5D/6.5D/8D)

Single insert cartridge type



(mm)

Designation	ØD	5D		6.5D		8D		Insert	Center drill	Cartridge	
		l <sub>1</sub>	L	l <sub>1</sub>	L	l <sub>1</sub>	L			Inner	Outer
WPDC	410-40-□	41	225 330	283 388	340 445	WC□T06T308-C21N	CDH1035	CWP4145C	CWP410P		
	420-40-□	42	225 330	283 388	340 445				CWP420P		
	430-40-□	43	225 330	283 388	340 445				CWP430P		
	440-40-□	44	225 330	283 388	340 445				CWP440P		
	450-40-□	45	225 330	283 388	340 445				CWP450P		
	460-40-□	46	250 355	315 420	380 485			CWP4650C	CWP460P		
	470-40-□	47	250 355	315 420	380 485				CWP470P		
	480-40-□	48	250 355	315 420	380 485				CWP480P		
	490-40-□	49	250 355	315 420	380 485				CWP490P		
	500-40-□	50	250 355	315 420	380 485				CWP500P		
	510-40-□	51	275 380	348 453	420 525			WC□T080408-C21N	CDH1238	CWP5155C	CWP510P
	520-40-□	52	275 380	348 453	420 525						CWP520P
	530-40-□	53	275 380	348 453	420 525						CWP530P
	540-40-□	54	275 380	348 453	420 525					CWP540P	
	550-40-□	55	275 380	348 453	420 525					CWP550P	
	560-40-□	56	300 405	380 485	460 565			CWP5659C	CWP560P		
	570-40-□	57	300 405	380 485	460 565				CWP570P		
	580-40-□	58	300 405	380 485	460 565				CWP580P		
	590-40-□	59	300 405	380 485	460 565				CWP590P		

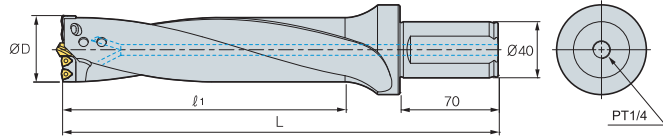
Applicable inserts F04

\* We can provide if you order exact diameter  
Ex) machining hole 47.5 mm \* 5D -> WPDC475-40-5



# WPDC(5D/6.5D/8D)

Dual insert cartridge type



(mm)

Designation	ØD	5D		6.5D		8D		Insert	Center drill	Cartridge	
		l <sub>1</sub>	L	l <sub>1</sub>	L	l <sub>1</sub>	L			Inner	Outer
WPDC	6065-40-□	60~65	325 430	423 528	520 625	WC□T050308-C21N	CDH1238	CWP6065C	CWP6065P		
	6570-40-□	65~70	350 455	455 560	560 665			CWP6570C	CWP6570P		
	7075-40-□	70~75	375 480	488 593	600 705			CWP7075C	CWP7075P		
	7580-40-□	75~80	400 505	520 625	640 745	WC□T06T308-C21N	CDH1645	CWP7580C	CWP7580P		

↻ Applicable inserts **F04**

\* We can provide if you order exact diameter  
Ex) machining hole 70.5 mm \* 6.5D -> WPDC705-40-6.5

# F Technical Information for Indexable Reamer

Mass production and High performance

## Indexable Reamer

- Suitable for mass production and high performance
- Using PCD or coated insert for high speed machining
- Excellent high accuracy and adjustable machining hole
- Using accuracy chucking system (Hydraulic, rotating type arbor)
- Using inner coolant type machine to evacuate chips
- Using suitable holder and insert
- As insert setting, using setting fixture (KIRSD-210)

### Code system

#### • Insert

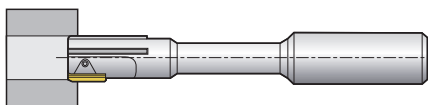
RI	16	-	B	06
<b>Type</b>	<b>Insert size</b>		<b>Insert reed type</b>	<b>Angle of C/B</b>
Reamer Insert	15: 15.0x3.0 16: 16.0x3.5 17: 17.0x4.5 22: 22.0x6.5		A: Excellent surface finish, low cutting condition B: General surface finish, high cutting condition C: Aluminum and copper alloy D: Blind hole, low feed	00: 0°, Cast iron 06: 6°, General steel 12: 12°, Stainless, Al

#### • Holder

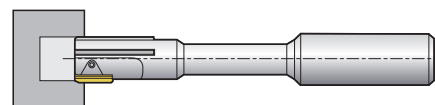
IR	T	12.000	-	16	135	-	16
<b>Type</b>	<b>Application</b>	<b>Reamer dia.</b>		<b>Shank Dia.</b>	<b>length</b>		<b>Insert size</b>
Indexable Reamer	T: Throughout hole machining B: Blind hole machining	12.000: Ø12.0 mm		16: Ø16 mm	135: 135		15: 15.0x3.0 16: 16.0x3.5 17: 17.0x4.5 22: 22.0x6.5

### Application

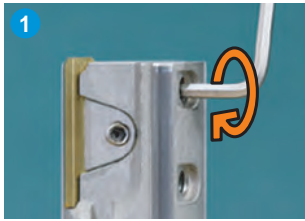
Throughout hole machining (IRT type)



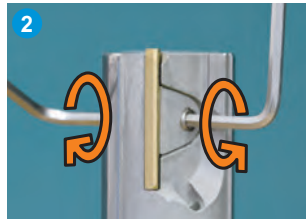
Stuffed hole machining (IRB type)



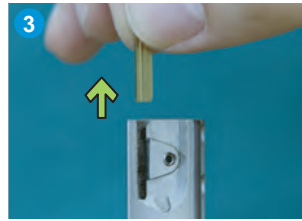
## How to set an insert



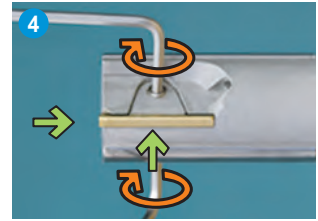
1. Screw the wedge screw counter clockwise with the exclusive wrench



2. Screw the clamp screw  
 ① Top side: counter clockwise  
 ② Lower side: clockwise



3. Remove the insert and clean the pocket



4. Put the insert up to the edge stopper and clamp the insert  
 ① Top side: clockwise  
 ② Lower side: counterclockwise

## Exclusive fixture

- Designation: KIRSD-210
- Maximum diameter of reamer:  $\varnothing 60 \times 210$  mm
- The fixture is also available for setting special reamer and mono tool
- Special reamers (out of maximum setting range) are available quotation



## How to set an insert with fixture



1. Adjust the gauge to '0'



2. Rotate the reamer for the insert to touch the gauge

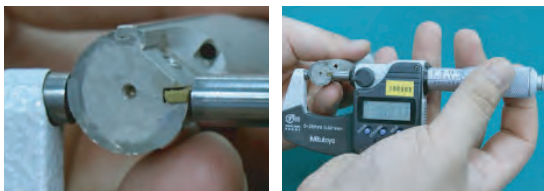


3. Set the back taper and adjust the insert height with screw the wedge screw  
 ① Top side of insert: +0.015~ +0.020 mm  
 ② Bottom side of insert: +0.005~ +0.010 mm  
 ③ Back taper: 0.010~0.015 mm

## Back taper

- Ensures low cutting load and excellent surface finish with good chip evacuation
- Inaccurate back taper could cause unstable machining with wear of insert
- The size of back taper of insert down side should be less to 0.010~0.015 mm than one of insert upper side

## Insert setting with a micrometer



- Lathe with both centers or bench center are also available

**Notice:** The setting with a micrometer is not recommended due to chipping on the cutting edge

# F Technical Information for Indexable Reamer

## Recommended cutting condition

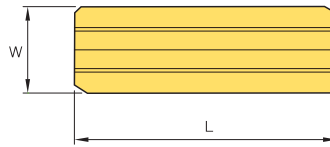
Workpiece	Insert type		Feed rate (mm/rev) per drill dia. (mm)	Cutting speed $v_c$ (m/min)		
	Rake angle	Lead type		Coated	Uncoated	Cermet
Carbon steel General steel	6	A	0.1~0.4	60~80	40~60	110~160
		B	0.1~0.3	80~120	60~80	
		D	0.05~0.2			
Mild steel Alloy steel	6	A	0.1~0.4	40~60	20~40	110~160
		B	0.1~0.3	80~120	60~80	
		D	0.05~0.2			
High alloy steel Tool steel	6	A	0.1~0.4	20~60	20~40	20~60
		B	0.1~0.3	40~80	40~60	40~80
		D	0.05~0.2			
Stainless steel	12	A	0.1~0.3	40~60	20~40	40~60
		B	0.1~0.2	60~80	40~60	60~80
		D	0.05~0.2			
Cast iron	0.6	A	0.1~0.3	60~100	40~60	
		B	0.1~0.25	80~120	60~80	
		D	0.05~0.2			
Alloyed aluminum	12	B	0.1~0.3		160~200	
		C	0.15~0.3		150~250	
		D	0.05~0.2		110~200	
Alloyed copper	0	B	0.1~0.2		80~100	
		D	0.05~0.2			
Non-ferrous alloy	0	B	0.1~0.3		10~70	

## Parts

Reamer size	Clamp	Wedge	Clamp Screw	Wedge Screw	Clamp Wrench	Wedge Wrench
10.0~11.9	CV 15	AW2430	DHA0308	HSO306 (NYLOK)	HW15L	HW15L
12.0~17.9	CV 16	AW2435				
18.0~27.9	CV 17	AW3240	DHA0409	HSO406	HW20L	HW20L
28.0~31.9	CV 22	AW3260				



## Available insert



Designation	Grade			Dimensions			Reed type	Rake angle (α°)	
	K10 (Uncoated)	BPK110 (TiAlN)	BPK210 (TiN)	L	W	S			
RI	15-A06		○	15	3.0	1.5	A	6°	
	15-A12	○		15	3.0	1.5	A	12°	
	15-B06		○	15	3.0	1.5	B	6°	
	15-B12		○	15	3.0	1.5	B	12°	
	16-A06			○	16	3.5	1.5	A	6°
	16-A12	○			16	3.5	1.5	A	12°
	16-B06		○	○	16	3.5	1.5	B	6°
	16-B12		○		16	3.5	1.5	B	12°
	17-A06			○	17	4.5	2.0	A	6°
	17-A12	○			17	4.5	2.0	A	12°
	17-B06		○	○	17	4.5	2.0	B	6°
	17-B12		○		17	4.5	2.0	B	12°
	22-A06			○	22	6.5	3.0	A	6°
	22-A12	○			22	6.5	3.0	A	12°
	22-B06		○	○	22	6.5	3.0	B	6°
	22-B12		○		22	6.5	3.0	B	12°

※ ○ This is recommended grade as for insert type

## Angle of chip breaker

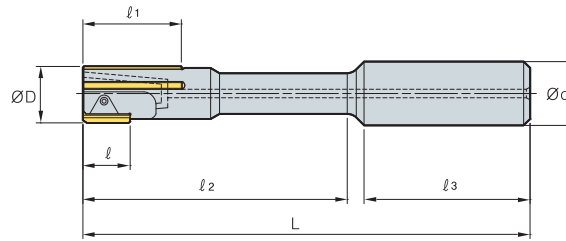
Division	00	06	12
Shape			
Application	For cast iron machining	For general machining	For stainless and aluminum machining

## Insert lead type

Type	Shape	Working condition	Type	Shape	Working condition
A		For excellent surface, low cutting condition	C		For aluminum and copper alloy machining
B		For general application, high cutting condition	D		For blind hole machining, low feed

## IRT

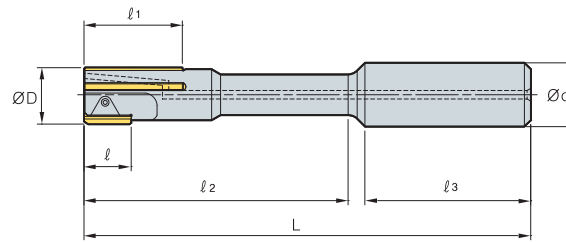
Throughout hole



(mm)

	Designation	ØD	ℓ	ℓ <sub>1</sub>	ℓ <sub>2</sub>	ℓ <sub>3</sub>	L	Ød	Insert
IRT	10.000-16125-15	10	15	30	75	45	125	16	RI 15
	11.000-16125-15	11	15	30	75	45	125	16	RI 15
	12.000-16135-16	12	16	30	85	45	135	16	RI 16
	13.000-16135-16	13	16	30	85	45	135	16	RI 16
	14.000-16135-16	14	16	30	85	45	135	16	RI 16
	15.000-16135-16	15	16	30	85	45	135	16	RI 16
	16.000-20155-16	16	16	30	100	50	155	20	RI 16
	17.000-20155-16	17	16	30	100	50	155	20	RI 16
	18.000-20155-17	18	17	30	100	50	155	20	RI 17
	19.000-20155-17	19	17	30	100	50	155	20	RI 17
	20.000-25165-17	20	17	30	110	56	165	25	RI 17
	21.000-25165-17	21	17	30	110	56	165	25	RI 17
	22.000-25165-17	22	17	30	110	56	165	25	RI 17
	23.000-25165-17	23	17	30	110	56	165	25	RI 17
	24.000-25165-17	24	17	30	110	56	165	25	RI 17
	25.000-25165-17	25	17	30	110	56	165	25	RI 17
	26.000-25165-17	26	17	30	110	56	165	25	RI 17
	27.000-25165-17	27	17	30	110	56	165	25	RI 17
	28.000-32165-22	28	22	30	110	56	165	32	RI 22
	29.000-32165-22	29	22	30	110	56	165	32	RI 22
30.000-32165-22	30	22	30	110	56	165	32	RI 22	
31.000-32165-22	31	22	30	110	56	165	32	RI 22	

➔ Applicable inserts F85

**IRB****Stuffed hole**

(mm)

	Designation	ØD	ℓ	ℓ <sub>1</sub>	ℓ <sub>2</sub>	ℓ <sub>3</sub>	L	Ød	Insert
<b>IRB</b>	<b>10.000-16125-15</b>	10	15	30	75	45	125	16	RI 15
	<b>11.000-16125-15</b>	11	15	30	75	45	125	16	RI 15
	<b>12.000-16135-16</b>	12	16	30	85	45	135	16	RI 16
	<b>13.000-16135-16</b>	13	16	30	85	45	135	16	RI 16
	<b>14.000-16135-16</b>	14	16	30	85	45	135	16	RI 16
	<b>15.000-16135-16</b>	15	16	30	85	45	135	16	RI 16
	<b>16.000-20155-16</b>	16	16	30	100	50	155	20	RI 16
	<b>17.000-20155-16</b>	17	16	30	100	50	155	20	RI 16
	<b>18.000-20155-17</b>	18	17	30	100	50	155	20	RI 17
	<b>19.000-20155-17</b>	19	17	30	100	50	155	20	RI 17
	<b>20.000-25165-17</b>	20	17	30	110	56	165	25	RI 17
	<b>21.000-25165-17</b>	21	17	30	110	56	165	25	RI 17
	<b>22.000-25165-17</b>	22	17	30	110	56	165	25	RI 17
	<b>23.000-25165-17</b>	23	17	30	110	56	165	25	RI 17
	<b>24.000-25165-17</b>	24	17	30	110	56	165	25	RI 17
	<b>25.000-25165-17</b>	25	17	30	110	56	165	25	RI 17
	<b>26.000-25165-17</b>	26	17	30	110	56	165	25	RI 17
	<b>27.000-25165-17</b>	27	17	30	110	56	165	25	RI 17
	<b>28.000-32165-22</b>	28	22	30	110	56	165	32	RI 22
	<b>29.000-32165-22</b>	29	22	30	110	56	165	32	RI 22
<b>30.000-32165-22</b>	30	22	30	110	56	165	32	RI 22	
<b>31.000-32165-22</b>	31	22	30	110	56	165	32	RI 22	

 Applicable inserts **F85**





**Tooling System**

<b>G02</b>	Tooling System Index
<b>G04</b>	DHE/S
<b>G07</b>	DHE
<b>G11</b>	DHC/DHJ Collet
<b>G12</b>	DSC
<b>G20</b>	NPM
<b>G23</b>	DCS/DC/TC
<b>G24</b>	Collet Chuck Series
<b>G25</b>	SDC/P
<b>G30</b>	DSK
<b>G32</b>	GSK
<b>G34</b>	GERC
<b>G36</b>	ER
<b>G37</b>	ER/L
<b>G38</b>	RTJW
<b>G40</b>	NPU
<b>G41</b>	DST
<b>G43</b>	TER Tap Collet
<b>G44</b>	DTN
<b>G46</b>	TCA Tap Adaptor
<b>G47</b>	SLA

**Tooling System**

<b>G49</b>	FMA
<b>G50</b>	FMC
<b>G52</b>	MD
<b>G54</b>	EXT Bar
<b>G54</b>	RDC Bar
<b>G55</b>	FBH/B
<b>G62</b>	DBCA
<b>G66</b>	DBC
<b>G68</b>	SMB
<b>G70</b>	KMB
<b>G72</b>	SMH
<b>G74</b>	TBCA
<b>G79</b>	TBC
<b>G82</b>	FBC
<b>G85</b>	SAH
<b>G86</b>	Angular Head
<b>G94</b>	DZC
<b>G95</b>	DCJ
<b>G96</b>	DCL
<b>G97</b>	DAMPNG PRO
<b>G104</b>	Others



# H Tooling System Index

## DHE/S

Slim hydraulic expansion chuck



G5

## DHE

Hydraulic expansion chuck



G8

## DSC

Shrinking chuck



G14

## NPM

New power milling chuck



G21

## SDC/P

Precision collet chuck for multi purpose machining



G25

## DSK

Slim type collet chuck



G30

## GSK

Great speed slim type collet chuck



G32

## HC Collet

HC slim collet



G33

## GERC

GERC collet



G35

## ER Collet

ER collet



G36

## ER/L

Lock collet for ER collet chuck



G37

## RTJW

Jet coolant disk



G39

## NPU

Drill chuck



G40

## DST

High speed synchro tapping chuck



G42

## TER

TER collet ER tap collet



G43

## DTN

Tapping holder



G45

## TCA

Tap adapter



G46

## SLA

Side lock arbor



G47

## FMA

Face mill arbor



G49

## FMC

Face mill arbor



G50

## MD

Modular arbor



G52

## EXT

Extension bar



G54

## RDC

Reducer bar



G54

## FBH/B

FBH Back boring & balanced type



G55



**DBCA**

New balance cut tool



**G63**

**DBC**

Balance cut tool (Rough boring)



**G66**

**SMB**

Small micro boring bar



**G68**

**KMB**

Micro boring



**G70**

**SMH**

Small micro boring bar (precision type)



**G72**

**TBCA**

Wide diameter boring system



**G75**

**TBC**

Balance cut tool for Rough boring



**G80**

**FBC**

Balance cut tool for Fine boring



**G83**

**SAH**

Slim angular head



**G85**

**MAH**

MAH for mold (0°-90°)  
Rigidity-reinforced angular head



**G88**

**KHU**

Collet type angular head (0° - 90°)



**G89**

**HARG**

HRAG (90° fixed)  
Rigidity-reinforced angular head



**G90**

**KAG**

Attachment type KAG



**G91**

**KAH**

Modular type KAH (90° type)  
Fixed angle-type angular head



**G92**

**KAC**

Modular type KAC (45° type)  
Fixed angle-type angular head



**G93**

**DZC**

Zero fit collet



**G94**

**DCJ**

DINE Jetcoolant collet



**G95**

**DCL**

Lock collet for milling chuck



**G96**

**FMA**

DAMPING PRO



**G99, 101**

**FMC**

DAMPING PRO



**H100, 102, 103**

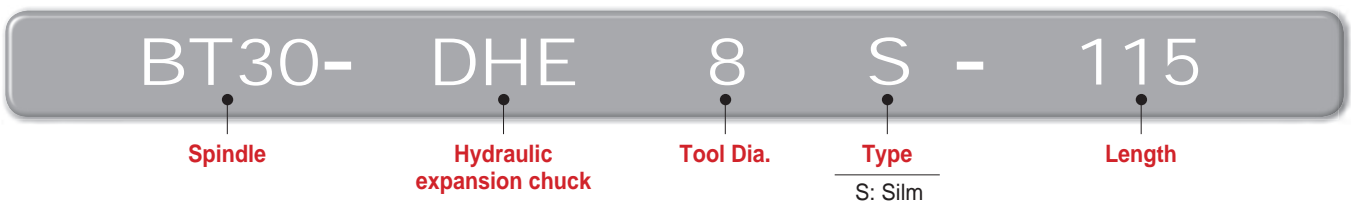
## Slim hydraulic expansion chuck

# DHE/S

- Optimized chuck for machining that requires high-quality surface roughness and accuracy
- Suitable for challenging mold and automotive parts machining that involves complicated shapes and a lot of interferences
- Ideal for metal impeller machining, which requires deep penetration
- Enables easy tool connection without any additional connecting device
- Easy to perform fine boring operations (0.02-0.2 mm)
- Application scope: milling, drilling, reaming



### Code system

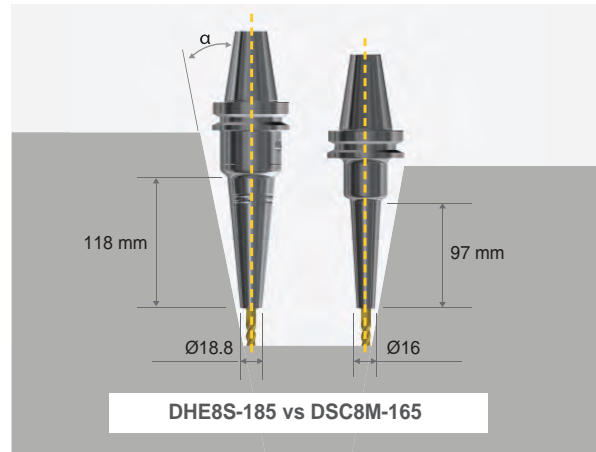


### Recommended Machining Works



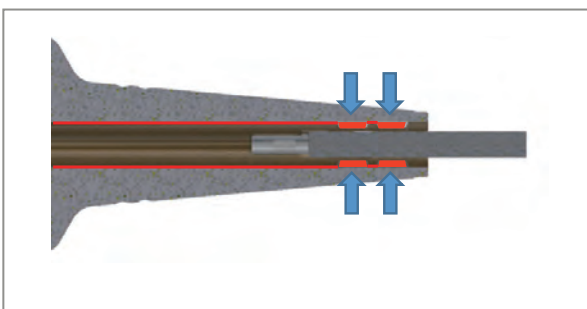
- Optimized for machining that requires high precision
- Enables challenging narrow and deep machining
- Products that require fine boring operations

### Product Comparison



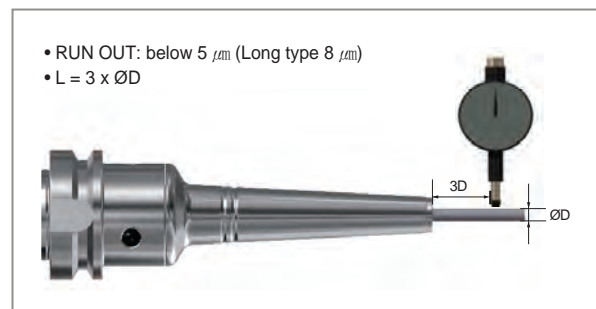
- Length and thickness are the same as those of DSC/M Type (if the tool projection length is 40 mm, difference of  $\alpha =$  around  $2^\circ$ )
- Longer gauge line and higher rigidity (versus the DSC/M Type)
- Ideal for mold machining due to its 3-degree taper shape

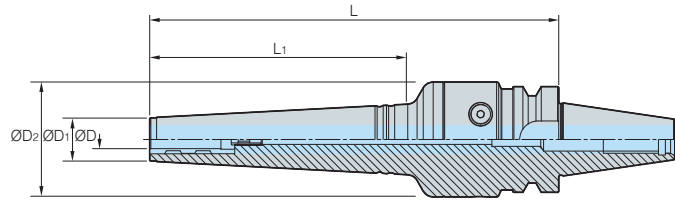
### Stable Clamping force




- Maintains high clamping force and good accuracy by holding the tool at two points


### High-precision



**BT-DHE/S**

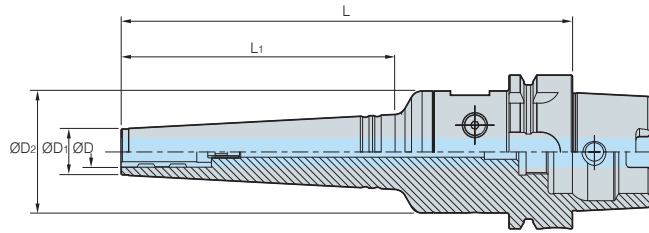
(mm)

Designation		ØD	ØD <sub>1</sub>	ØD <sub>2</sub>	L	L <sub>1</sub>	RPM	Run-out Based on 3D	 kg
<b>BT30 -</b>	DHE6S-115	6	16.8	50	115	50	25,000	5 µm	1.1
	DHE6S-180	6	16.8	50	180	115	25,000	8 µm	1.4
	DHE8S-115	8	18.8	50	115	50	25,000	5 µm	1.1
	DHE8S-180	8	18.8	50	180	115	25,000	8 µm	1.4
	DHE10S-120	10	20.8	50	120	55	25,000	5 µm	1.4
	DHE10S-180	10	20.8	50	180	115	25,000	8 µm	1.9
	DHE12S-130	12	22.8	50	130	65	25,000	5 µm	1.2
	DHE12S-180	12	22.8	50	180	115	25,000	8 µm	1.6
<b>BT40 -</b>	DHE6S-120	6	16.8	50	120	50	15,000	5 µm	1.7
	DHE6S-185	6	16.8	50	185	115	15,000	8 µm	2.0
	DHE8S-120	8	18.8	50	120	50	15,000	5 µm	2.0
	DHE8S-185	8	18.8	50	185	115	15,000	8 µm	2.0
	DHE10S-125	10	20.8	50	125	55	15,000	5 µm	1.6
	DHE10S-185	10	20.8	50	185	115	15,000	8 µm	2.0
	DHE12S-135	12	22.8	50	135	65	15,000	5 µm	1.8
	DHE12S-185	12	22.8	50	185	115	15,000	8 µm	2.2


 Spare Part **G06**

• Through coolant system installed

# HSK-DHE/S





(mm)

Designation		ØD	ØD <sub>1</sub>	ØD <sub>2</sub>	L	L <sub>1</sub>	RPM	Run-out Based on 3D	
HSK63A -	DHE6S-120	6	16.8	50	120	50	10,000	5 µm	1.4
	DHE6S-185	6	16.8	50	185	115	10,000	8 µm	1.7
	DHE8S-120	8	18.8	50	120	50	10,000	5 µm	1.4
	DHE8S-185	8	18.8	50	185	115	10,000	8 µm	1.8
	DHE10S-125	10	20.8	50	125	55	10,000	5 µm	1.5
	DHE10S-185	10	20.8	50	185	115	10,000	8 µm	1.8
	DHE12S-135	12	22.8	50	135	65	10,000	5 µm	1.8
	DHE12S-185	12	22.8	50	185	115	10,000	8 µm	1.8

• Through coolant system installed

## Parts

Basic					
Division		Clamp bolt	Wrench	Division	Adjust screw
Parts Designation				Parts	
				Designation	
BT30	DHE/S 6, 8, 10, 12	BTF1010	DHETW-5	DHE/S 6, 8, 10	DHE-M5 (ADJ)
BT40/HSK63A	DHE/S 6, 8, 10, 12	BTF1010	DHETW-5	DHE/S 12	DHE-M10 (ADJ)





## Hydraulic expansion chuck

# DHE

- Ideal for mold making and machining automobile components & precise parts due to high precision machining
- Improved surface roughness due to vibration proof by hydraulic chamber
- Reduced replacement time and tiredness of worker with the use of T wrench for removal
- Applicable shank diameter:  $\varnothing 6\sim 32$



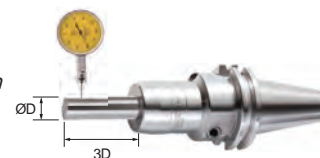
### Code system



### Features

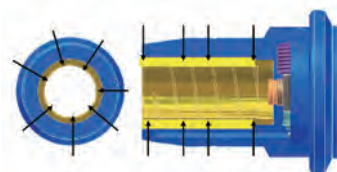
High accuracy provides long tool life due to reduced wear and hydraulic room enhances a surface roughness by lessening vibrations

- RUN OUT: under  $5\ \mu m$
- $L = 3 \times \varnothing D$
- Shank: Tolerance of  $\varnothing D: h6$



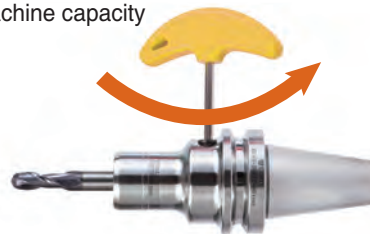
### Internal sealing structure (Durability)

- Internal sealing system protects the chuck against dust, cutting oil, lubricant and chips getting into it
- Maintaining clamping force and accuracy for a long time



### With simple t-wrench, very easy to change a tool

- Clamping structure for easy operation (Convenience)
- Decrease of worker's fatigue
- Improving machine capacity



Shank	Grade	Max.rpm
BT50, HSK100A	G6.3	8,000
BT40, HSK63A		10,000
BT30, SK30		15,000

### Stable clamping

The clearance between holder and tool is fixed by hydraulic pressure



# BT-DHE

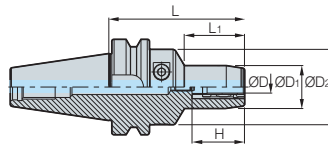


Fig. 1

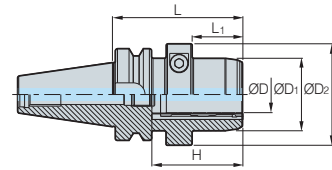


Fig. 2

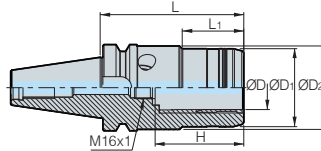


Fig. 3

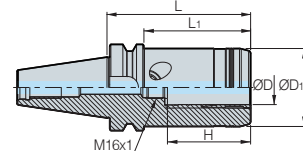



Fig. 4

(mm)

Designation	ØD	ØD <sub>1</sub>	ØD <sub>2</sub>	L	L <sub>1</sub>	H	Adjust screw		Fig.	
<b>BT30 -</b>	<b>DHE6-65</b>	6	29	46	65	33	30~39.8	M5	0.7	1
	<b>DHE8-65</b>	8	31	46	65	33	30~39.8	M5	0.7	1
	<b>DHE10-65</b>	10	32	46	65	34	35~44.8	M5	0.7	1
	<b>DHE12-70</b>	12	35	46	70	34	41~50.8	M5	0.8	1
	<b>DHE14-90</b>	14	36	46	90	40	43~52.8	M5	1.0	1
	<b>DHE16-90</b>	16	40	46	90	45	46~55.8	M5	1.0	1
	<b>DHE18-90</b>	18	42	46	90	40	49~58.8	M5	1.1	1
	<b>DHE20-90</b>	20	44	46	90	45	49~58.8	M5	1.1	1
<b>BT40 -</b>	<b>DHE6-90</b>	6	29	50	90	40	30~39.8	M5	1.4	1
	<b>DHE6-140</b>	6	29	50	140	40	30~39.8	M5	2.2	1
	<b>DHE8-90</b>	8	31	50	90	40	30~39.8	M5	1.4	1
	<b>DHE8-140</b>	8	31	50	140	40	30~39.8	M5	2.2	1
	<b>DHE10-90</b>	10	33	50	90	40	35~44.8	M5	1.5	1
	<b>DHE10-140</b>	10	33	50	140	40	35~44.8	M5	2.2	1
	<b>DHE12-90</b>	12	35	50	90	40	41~50.8	M10	1.5	1
	<b>DHE12-140</b>	12	35	50	140	40	41~50.8	M10	2.3	1
	<b>DHE14-90</b>	14	36	50	90	40	43~52.8	M10	1.5	1
	<b>DHE14-140</b>	14	36	50	140	40	43~52.8	M10	2.2	1
	<b>DHE16-90</b>	16	40	50	90	45	46~55.8	M10	1.5	1
	<b>DHE16-140</b>	16	40	50	140	45	46~55.8	M10	2.2	1
	<b>DHE18-90</b>	18	42	50	90	45	49~58.8	M10	1.5	1
	<b>DHE18-140</b>	18	42	50	140	45	49~58.8	M10	2.2	1
	<b>DHE20-90</b>	20	44	50	90	47	49~58.8	M10	1.5	1
	<b>DHE20-140</b>	20	44	50	140	50	49~58.8	M10	2.3	1
	<b>DHE25-90</b>	25	50	70	90	35	58~67.8	M16	2.0	2
	<b>DHE25-105</b>	25	57	-	105	78	51~61	M16	2.0	4
	<b>DHE25-140</b>	25	57	-	140	113	51~61	M16	2.6	4
	<b>DHE32-90</b>	32	63	75	90	35	58~67.8	M16	2.3	2
<b>DHE32-105</b>	32	57	61	105	45	55~65	M16	2.4	3	
<b>DHE32-140</b>	32	57	61	140	45	55~65	M16	3.0	3	

 Spare Part **G10**  Applicable collet **G11**

• H: Insertion depth of tool (Min.-max.) • Through coolant system installed



# BT-DHE

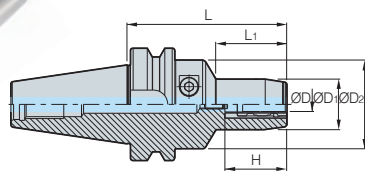


Fig. 1

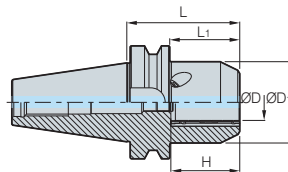


Fig. 2

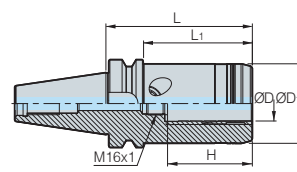


Fig. 3

(mm)

Designation	ØD	ØD <sub>1</sub>	ØD <sub>2</sub>	L	L <sub>1</sub>	H	Adjust screw	kg	Fig.	
<b>BT50 -</b>	<b>DHE6-90</b>	6	29	50	90	34	30~39.8	M5	3.9	1
	<b>DHE6-140</b>	6	29	50	140	40	30~39.8	M5	4.4	1
	<b>DHE8-90</b>	8	31	50	90	34	30~39.8	M5	4.2	1
	<b>DHE8-140</b>	8	31	50	140	40	30~39.8	M5	4.6	1
	<b>DHE10-90</b>	10	33	50	90	34	35~44.8	M5	3.9	1
	<b>DHE10-140</b>	10	33	50	140	34	35~44.8	M5	4.5	1
	<b>DHE12-90</b>	12	35	50	90	34	41~50.8	M10	4.0	1
	<b>DHE12-140</b>	12	35	50	140	34	41~50.8	M10	4.6	1
	<b>DHE14-90</b>	14	36	50	90	34	43~52.8	M10	3.9	1
	<b>DHE14-140</b>	14	36	50	140	34	43~52.8	M10	4.5	1
	<b>DHE16-90</b>	16	40	50	90	34	46~55.8	M10	4.1	1
	<b>DHE16-140</b>	16	40	50	140	34	46~55.8	M10	4.7	1
	<b>DHE18-90</b>	18	42	50	90	40	49~58.8	M10	4.0	1
	<b>DHE18-140</b>	18	42	50	140	45	49~58.8	M10	4.5	1
	<b>DHE20-90</b>	20	44	50	90	34	49~58.8	M10	4.0	1
	<b>DHE20-140</b>	20	44	50	140	47	49~58.8	M10	4.5	1
	<b>DHE25-90</b>	25	66	-	90	52	58~67.8	M16	4.7	2
	<b>DHE25-150</b>	25	57	-	150	112	51~61	M16	4.5	3
<b>DHE32-90</b>	32	72	-	90	52	58~67.8	M16	5.8	2	

↻ Spare Part **G10**   ↻ Applicable collet **G11**

• H: Insertion depth of tool (Min.-max.) • Through coolant system installed

# HSK-DHE

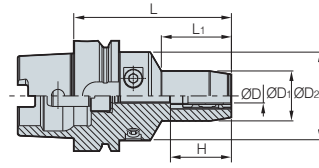


Fig. 1

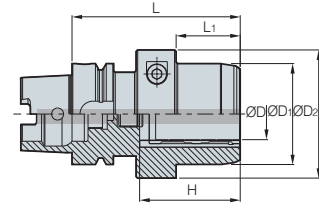




Fig. 2




(mm)

Designation	ØD	ØD <sub>1</sub>	ØD <sub>2</sub>	L	L <sub>1</sub>	H	Adjust Screw	RPM		Fig.	
HSK63A -	DHE6-75	6	29	50	75	34	30~39.8	M5	10,000	1.0	1
	DHE8-75	8	31	50	75	34	30~39.8	M5	10,000	1.0	1
	DHE10-85	10	33	50	85	40	35~44.8	M5	10,000	1.2	1
	DHE12-90	12	35	50	90	40	41~50.8	M5	10,000	1.2	1
	DHE16-95	16	40	50	95	45	46~55.8	M10	10,000	1.3	1
	DHE20-100	20	44	50	100	50	49~58.8	M10	10,000	1.4	1
	DHE20-150	20	44	50	150	50	49~58.8	M10	10,000	2.2	1
	DHE25-110	25	50	70	110	48	56~67.8	M16	10,000	2.0	2
HSK100A -	DHE20-105	20	44	50	105	50	49~58.8	M10	8,000	2.9	1
	DHE25-115	25	50	63	115	62	58~67.8	M16	8,000	3.2	1
	DHE32-115	32	63	75	115	62	58~67.8	M16	8,000	3.8	1

 Applicable collet **G11**

• H: Insertion depth of tool (Min.~max.) • Through coolant system is optional

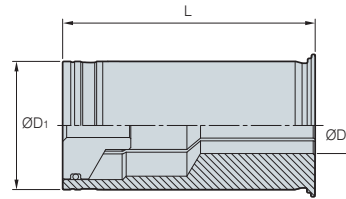
## Parts

Basic					
Division		Clamp bolt	Wrench	Division	Adjust screw
Parts				Parts	
Designation				Designation	
BT30 / HSK50	DHE 6, 8, 10, 12	BTF1010	DHETW-5	DHE 6, 8, 10	DHE-M5 (ADJ)
	DHE 14, 16, 18, 20	BTF1010	DHETW-5		
BT40 / BT50 HSK63A / HSK100A	DHE 6, 8, 10, 12, 14, 16, 18, 20	BTF1010	DHETW-5	DHE 12, 14, 16, 18, 20	DHE-M10 (ADJ)
	DHE 25, 32	BTF1212-1.5	DHETW-6	DHE 25, 32	DHE-M16 (ADJ)



# DHC Collet

General type



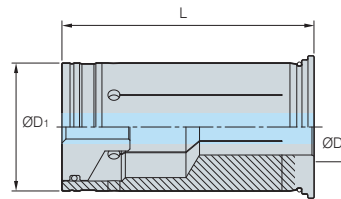
(mm)

Designation	ØD	ØD <sub>1</sub>	L
DHC12-3, 4, 5, 6, 8	3, 4, 5, 6, 8	12	47
DHC20-3, 4, 5, 6, 7, 8, 9, 10, 11, 12, 14, 16	3, 4, 5, 6, 7, 8, 9, 10, 11, 12, 14, 16	20	52
DHC32-6, 8, 10, 12, 14, 16, 18, 19, 20, 25	6, 8, 10, 12, 14, 16, 18, 19, 20, 25	32	63

• Through coolant system not available

# DHC Collet

Accuracy type



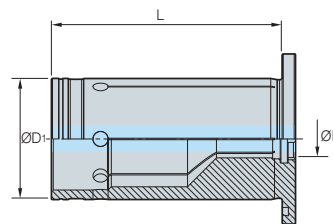
(mm)

Designation	ØD	ØD <sub>1</sub>	L
DHC12-3(P), 4(P), 5(P), 6(P), 8(P)	3, 4, 5, 6, 8	12	47
DHC20-3(P), 4(P), 5(P), 6(P), 7(P), 8(P), 9(P), 10(P), 11(P), 12(P), 14(P), 16(P)	3, 4, 5, 6, 7, 8, 9, 10, 11, 12, 14, 16	20	52
DHC32-6(P), 8(P), 10(P), 12(P), 14(P), 16(P), 18(P), 19(P), 20(P), 25(P)	6, 8, 10, 12, 14, 16, 18, 19, 20, 25	32	63

• Through coolant system installed

# DHJ Collet

Jet coolant



(mm)

Designation	ØD	ØD	L
DHJ20-6, 8, 10, 12, 14, 16	6, 8, 10, 12, 14, 16	20	50

• Through coolant system installed



## Shrinking chuck

# DSC

- Use of specially heat-treated steel
- High precision machining and clamping
- Increased precision and longer tool life due to minimized overhang when machining deep grooves
- Applicable shank diameter: Ø3~32

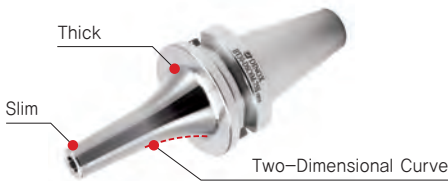


### Code System

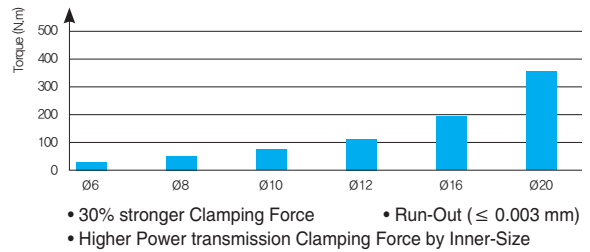
BT50 - DSC 6 - S - 165 - S					
<b>Shank type</b>	<b>Holder type</b>	<b>Tool Dia.</b>	<b>Type</b>	<b>Length</b>	<b>Special</b>
BT, HSK, ST, CS, CM	DSC: Shrinking chuck SLK: 2piece holder Collet		S: Slim M: Middle None: General		S: Curve type None: General

### Mono curve type

- Integral DSC with excellent precision and balancing
- Long but stable holder design



### High clamping force



### Symmetric design

- High clamping force



Shrinking chuck	Collet chuck
Fix the clearance between holder and tool by heat shrinking	Fix the tool by elasticity of collet
Thermal expansion $\rightarrow$ Thermal shrinking Highly strong clamping	Elastic deformation Strong clamping

### Slim type series

Straight type	Mono type	2piece type
Used by combining with various holders such as hydraulic expansion chuck, milling chuck, and collet chuck	Used with high precision as integral types	Holder + collet connection shape Connecting the holder and collet by the bolt tightening method



## 2-pieces type

2Piece types enable various machining operations by collet replacement and provide convenience in tool management and use based on easy and fast assembly using tightening bolts.

Figure	Accuracy	Type
		<p>Holder + collet connection shape Connecting the holder and collet by the bolt tightening method</p>

## Mono type

Figure	Accuracy	Type

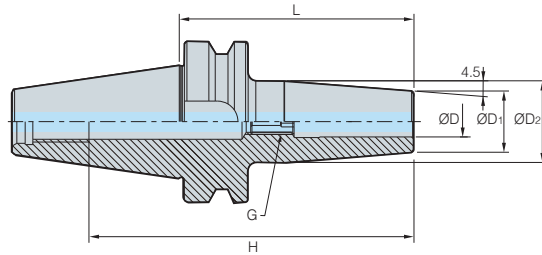
## Straight type

Figure	Accuracy	Type
		<p>Used by combining with various holders such as hydraulic expansion chuck, milling chuck, and collet chuck, etc.</p>







# BT-DSC



(mm)

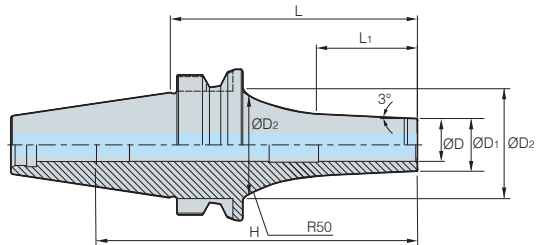
Designation	ØD	ØD <sub>1</sub>	ØD <sub>2</sub>	L	H	G	RPM	
<b>BT30 -</b> DSC3-60	3	11	18.5	60	82	-	25,000	0.4
DSC4-60	4	13	20.5	60	82	-	25,000	0.4
<b>BT40 -</b> DSC6-90	6	21	27	90	36	M5	20,000	1.1
DSC6-120	6	21	27	120	36	M5	20,000	1.2
DSC6-160	6	21	27	160	36	M5	20,000	1.4
DSC8-90	8	21	27	90	36	M5	20,000	1.1
DSC8-120	8	21	27	120	36	M5	20,000	1.2
DSC8-160	8	21	27	160	36	M5	20,000	1.4
DSC10-90	10	24	32	90	42	M8	20,000	1.1
DSC10-120	10	24	32	120	42	M8	20,000	1.3
DSC10-160	10	24	32	160	42	M8	20,000	1.6
DSC12-90	12	24	32	90	47	M8	20,000	1.1
DSC12-120	12	24	32	120	47	M8	20,000	1.3
DSC12-160	12	24	32	160	47	M8	20,000	1.6
DSC16-90	16	27	34	90	50	M12	20,000	1.2
DSC16-120	16	27	34	120	50	M12	20,000	1.3
DSC16-160	16	27	34	160	50	M12	20,000	1.7
DSC20-90	20	33	42	90	52	M12	20,000	1.3
DSC20-120	20	33	42	120	52	M12	20,000	1.5
DSC20-160	20	33	42	160	52	M12	20,000	2.0

 Adjust screw G19


• H: Insertion depth of tool • Through coolant system installed

# BT-DSC/M

Mono Curve type



(mm)

Designation	ØD	ØD <sub>1</sub>	ØD <sub>2</sub>	L	L <sub>1</sub>	H	RPM	
<b>BT30 -</b> DSC3M-75S	3	8	25	75	29.8	97	25,000	0.4
DSC4M-75S	4	10	25	75	31.8	97	25,000	0.4
DSC6M-75S	6	12	30	75	28.9	97	25,000	0.5
DSC8M-75S	8	14	32	75	28.9	97	25,000	0.5
DSC10M-75S	10	16	32	75	30.7	45	25,000	0.5
DSC12M-75S	12	19	32	75	33.8	45	25,000	0.5

• H: Insertion depth of tool • Not able to use the adjust screw • Through coolant system installed



# BT-DSC/M

Mono type

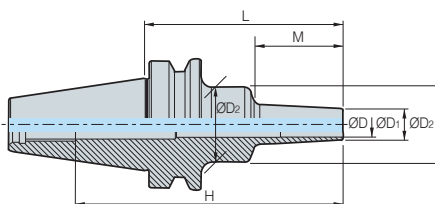


Fig. 1

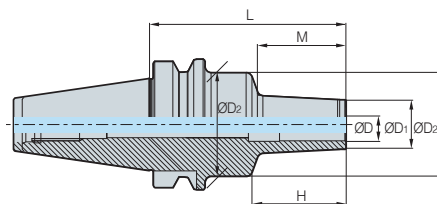



Fig. 2

(mm)

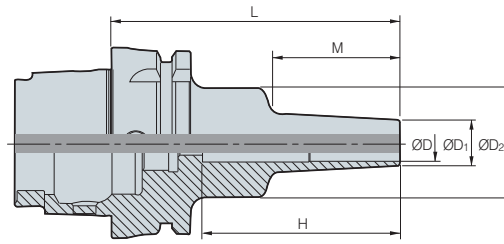
Designation		ØD	ØD <sub>1</sub>	ØD <sub>2</sub>	L	M	H	RPM	 kg	Fig.
<b>BT40 -</b>	<b>DSC3M-95</b>	3	8	26	95	42	128	20,000	1.1	1
	<b>DSC4M-95</b>	4	8	26	95	42	128	20,000	1.1	1
	<b>DSC6M-95</b>	6	10	26	95	42	128	20,000	1.0	1
	<b>DSC6M-120</b>	6	10	26	120	67	153	20,000	1.0	1
	<b>DSC6M-160</b>	6	10	36	160	97	193	20,000	1.2	1
	<b>DSC8M-95</b>	8	13	36	95	42	128	20,000	1.3	1
	<b>DSC8M-120</b>	8	13	36	120	67	153	20,000	1.3	1
	<b>DSC8M-160</b>	8	13	36	160	97	193	20,000	1.3	1
	<b>DSC10M-95</b>	10	16	36	95	42	128	20,000	1.1	1
	<b>DSC10M-120</b>	10	16	36	120	67	153	20,000	1.1	1
	<b>DSC10M-160</b>	10	16	36	160	97	193	20,000	1.3	1
	<b>DSC12M-95</b>	12	19	36	95	42	128	20,000	1.1	1
	<b>DSC12M-120</b>	12	19	36	120	67	153	20,000	1.2	1
	<b>DSC12M-160</b>	12	19	36	160	97	193	20,000	1.4	1
<b>BT50 -</b>	<b>DSC16M-95</b>	16	24	50	95	42	47	20,000	1.3	2
	<b>DSC16M-120</b>	16	24	50	120	67	47	20,000	1.4	2
	<b>DSC16M-160</b>	16	24	50	160	97	47	20,000	1.7	2
	<b>DSC20M-95</b>	20	29	50	95	42	55	20,000	1.3	2
	<b>DSC20M-120</b>	20	29	50	120	67	55	20,000	1.5	2
	<b>DSC20M-160</b>	20	29	50	160	97	55	20,000	1.9	2
	<b>DSC6M-110</b>	6	10	26	110	42	163	15,000	3.5	1
	<b>DSC6M-160</b>	6	10	36	160	97	213	15,000	3.6	1
	<b>DSC8M-110</b>	8	13	36	110	42	163	15,000	3.7	1
	<b>DSC8M-160</b>	8	13	36	160	97	213	15,000	3.7	1
	<b>DSC10M-110</b>	10	16	36	110	42	163	15,000	3.7	1
	<b>DSC10M-160</b>	10	16	36	160	97	213	15,000	3.7	1
<b>DSC12M-110</b>	12	19	36	110	42	163	15,000	3.7	1	
<b>DSC12M-160</b>	12	19	50	160	97	213	15,000	4.0	1	
<b>DSC16M-110</b>	16	24	50	110	42	163	15,000	3.9	1	
<b>DSC16M-160</b>	16	24	50	160	97	213	15,000	4.1	1	
<b>DSC20M-110</b>	20	29	50	110	42	55	15,000	3.9	2	
<b>DSC20M-160</b>	20	29	50	160	97	55	15,000	4.2	2	

 Adjust screw **G19**

• H: Insertion depth of tool • Through coolant system installed

# HSK-DSC/M

Mono type



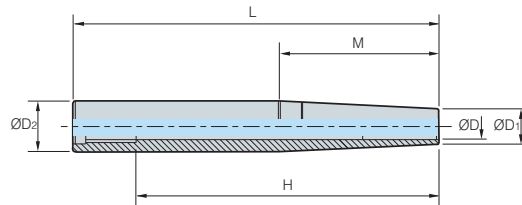
(mm)

Designation		ØD	ØD <sub>1</sub>	ØD <sub>2</sub>	L	M	H	RPM	kg
HSK63A -	DSC6M-95	6	10	26	95	42	73	20,000	0.7
	DSC8M-95	8	13	36	95	42	39	20,000	0.8
	DSC10M-120	10	16	36	120	67	45	20,000	0.8
	DSC12M-120	12	19	36	120	67	45	20,000	0.9
	DSC16M-120	16	24	50	120	67	47	20,000	1.1

• H: Insertion depth of tool • Not able to use the adjust screw • Through coolant system is optional

# ST-DSC/M

Straight Shank Shrinking Chuck



(mm)

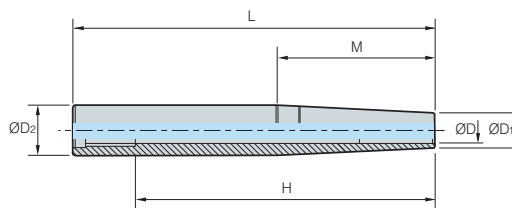
Designation		ØD	ØD <sub>1</sub>	ØD <sub>2</sub>	L	M	H	kg
ST16 -	DSC6M-115	6	10	16	115	50	95	0.1
	DSC6M-140	6	10	16	140	60	120	0.1
ST20 -	DSC6M-175	6	10	20	175	95	155	0.2
	DSC8M-145	8	13	20	145	70	125	0.2
	DSC10M-120	10	16	20	120	50	45	0.2
ST25 -	DSC8M-175	8	13	25	175	105	155	0.4
	DSC10M-145	10	16	25	145	75	45	0.4
	DSC10M-175	10	16	25	175	105	45	0.4
	DSC12M-120	12	19	25	120	50	45	0.3
	DSC12M-150	12	19	25	150	80	45	0.4
ST32 -	DSC16M-175	16	24	25	175	50	47	0.5
	DSC20M-175	20	29	32	175	50	55	0.8

• H: Insertion depth of tool • Not able to use the adjust screw • Through coolant system installed



# ST-DSC/S

## Straight Shank Shrinking Chuck



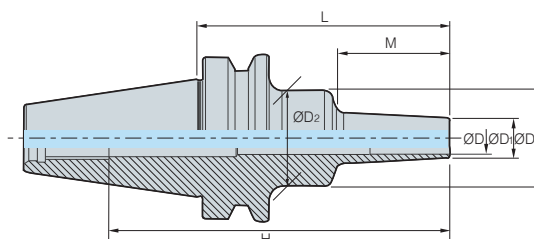
(mm)

Designation	ØD	ØD <sub>1</sub>	ØD <sub>2</sub>	L	M	H	
ST16 -	DSC6S-115	6	9	16	115	55	95
	DSC6S-140	6	9	16	140	70	120
	DSC8S-115	8	11	16	115	50	95
ST20 -	DSC6S-175	6	9	20	175	105	155
	DSC8S-175	8	11	20	175	85	155
	DSC10S-145	10	13	20	145	75	77
	DSC12S-120	12	15	20	120	50	52
ST32 -	DSC12S-315	12	15	32	315	185	295

• H: Insertion depth of tool • Not able to use the adjust screw • Through coolant system installed

# BT-DSC/S

## Mono slim type



(mm)

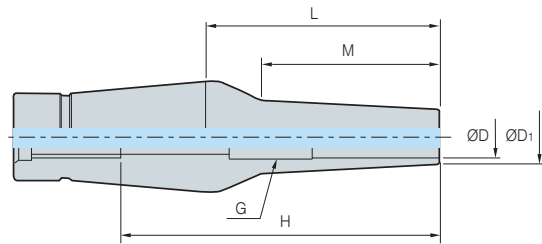
Designation	ØD	ØD <sub>1</sub>	ØD <sub>2</sub>	L	M	H	RPM	kg	
BT30 -	DSC6S-60	6	9	20	60	22	82	25,000	0.4
	DSC6S-80	6	9	20	80	42	102	25,000	0.5
	DSC6S-120	6	9	25	120	67	142	25,000	0.5
BT40 -	DSC6S-95	6	9	26	95	42	128	20,000	1.0
	DSC6S-120	6	9	26	120	67	153	20,000	1.0
	DSC6S-160	6	9	36	160	97	193	20,000	1.2
	DSC8S-95	8	11	36	95	42	128	20,000	1.1
	DSC8S-120	8	11	36	120	67	153	20,000	1.1
	DSC8S-160	8	11	36	160	97	193	20,000	1.2
	DSC10S-95	10	13	36	95	42	128	20,000	1.0
	DSC10S-120	10	13	36	120	67	153	20,000	1.1
	DSC10S-160	10	13	36	160	97	193	20,000	1.2
	DSC12S-95	12	15	36	95	42	128	20,000	1.1
	DSC12S-120	12	15	36	120	67	153	20,000	1.1
	DSC12S-160	12	15	36	160	97	193	20,000	1.2
BT50 -	DSC6S-110	6	9	26	110	42	166	15,000	3.5
	DSC6S-160	6	9	36	160	97	216	15,000	3.6
	DSC8S-110	8	11	36	110	42	166	15,000	3.6
	DSC8S-160	8	11	36	160	97	216	15,000	3.6
	DSC10S-110	10	13	36	110	42	166	15,000	3.6
	DSC10S-160	10	13	36	160	97	216	15,000	3.6
	DSC12S-110	12	15	36	110	42	166	15,000	3.6
	DSC12S-160	12	15	36	160	97	216	15,000	3.7

• H: Insertion depth of tool • Not able to use the adjust screw • Through coolant system installed




# CS/CM

2-pieces type




(mm)

Designation		ØD	ØD <sub>1</sub>	L	M	H	
<b>CS12</b>	<b>6-35</b>	6	9	35	22	55	0.1
	<b>6-80</b>	6	9	80	67	100	0.2
	<b>6-110</b>	6	9	110	97	130	0.2
	<b>8-35</b>	8	11	35	22	55	0.1
	<b>8-110</b>	8	11	110	97	130	0.3
	<b>10-35</b>	10	13	35	22	45	0.1
	<b>10-80</b>	10	13	80	67	65	0.2
	<b>10-110</b>	10	13	110	97	65	0.3
	<b>12-35</b>	12	15	35	22	45	0.1
	<b>12-55</b>	12	15	55	42	49.5	0.2
	<b>12-80</b>	12	15	80	67	65	0.2
	<b>12-110</b>	12	15	110	97	65	0.3

• H: Insertion depth of tool • Not able to use the adjust screw • Through coolant system installed

(mm)

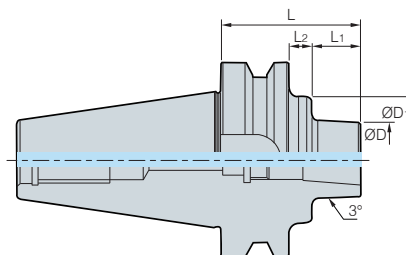
Designation		ØD	ØD <sub>1</sub>	L	M	H	G	
<b>CM12</b>	<b>6-35</b>	6	12	35	22	55	M5	0.2
	<b>6-80</b>	6	12	80	67	100	M5	0.2
	<b>8-35</b>	8	14	35	22	55	M5	0.2
	<b>8-55</b>	8	14	55	42	75	M5	0.2
	<b>8-80</b>	8	14	80	67	100	M5	0.3
	<b>10-35</b>	10	16	35	22	45	M8	0.2
	<b>10-55</b>	10	16	55	42	45	M8	0.2
	<b>10-80</b>	10	16	80	67	45	M8	0.3
	<b>12-35</b>	12	20	35	22	45	M8	0.2
	<b>12-55</b>	12	20	55	42	45	M8	0.3
	<b>12-80</b>	12	20	80	52	55	M8	0.3

• H: Insertion depth of tool • Not able to use the adjust screw • Through coolant system installed



# BT-SLK

2-pieces type



(mm)

Designation		ØD	ØD <sub>1</sub>	L	L <sub>1</sub>	L <sub>2</sub>	kg
<b>BT30 -</b>	<b>SLK12-35</b>	38	-	35	13	-	0.4
	<b>SLK12-45F</b>	41	-	45	18	-	1.0
	<b>SLK12-75F</b>	41	-	75	48	-	1.3
	<b>SLK12-135F</b>	41	-	135	108	-	2.1
<b>BT50 -</b>	<b>SLK12-75</b>	38	65	75	25	12	4.1
	<b>SLK12-75F</b>	41	65	75	25	12	4.1
	<b>SLK12-105F</b>	41	65	105	55	12	4.5
	<b>SLK12-135F</b>	41	65	135	85	12	5.3
	<b>SLK12-225</b>	38	65	225	150	37	6.2
	<b>SLK12-315</b>	38	90	315	150	127	11.5

• Through coolant system installed • PULL STUD BOLT is needed for BT30-SLK12-35

## Parts

		Basic									
Type		DSC6	DSC8	DSC10	DSC12	DSC14	DSC16	DSC18	DSC20	DSC25	DSC32
Adjust screw		M520C		M820C				M1230C			

## New power milling chuck

# NPM

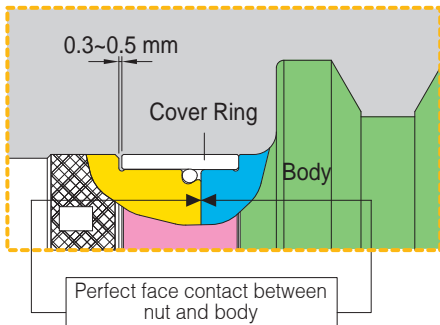
- Strong clamping over 500kgf·m (on NPM42 basis)
- DUST BLOCK functions for blocking foreign substance
- Jet coolant available
- High precision within 15 μm at L/D = 3
- Boring range: Ø20~42



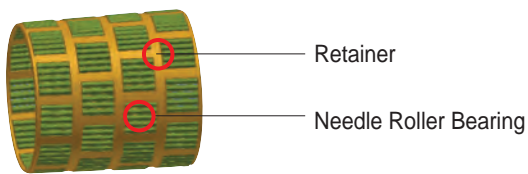
### Code system



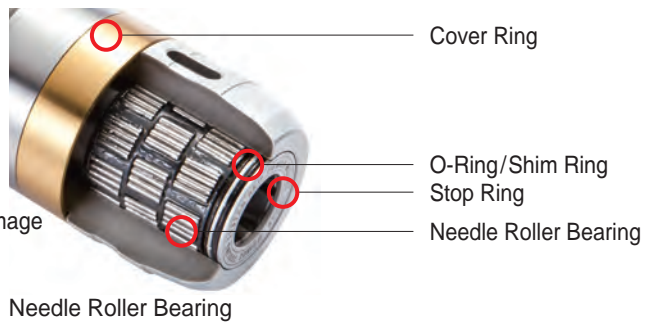
### Improvement of durability by preventing minute dust, chips and coolant



- Adopted Stop Ring on Head parts
- Preventing minute dust by Shim & O-Ring

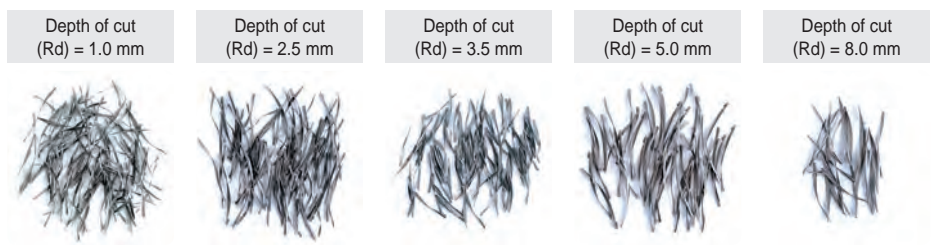


- Specially designed Steel Bearing for prevention of damage
- Strong clamping by spreading the force



### Stable machining from heavy to fine

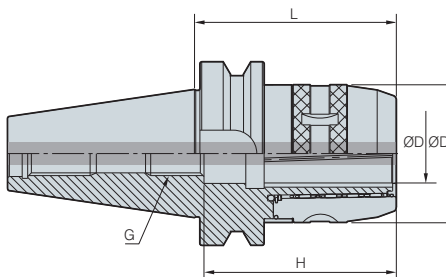
Perfect face contact and Powerful clamping force strengthen both Cutting force and Absorption of vibration.



Possible machining from heavy milling to fine finishing



# BT-NPM



(mm)

Designation	ØD	ØD <sub>1</sub>	L	H	G	Collet	kg
<b>BT30 - NPM20-85</b>	20	54	85	85	M16	DC20, DCS20, DCJ20	1.2
<b>BT40 -</b>	<b>NPM20-85</b>	20	54	85	M16	DC20, DCS20, DCJ20	2.6
	<b>NPM20-100</b>	20	54	100	M16	DC20, DCS20, DCJ20	2.3
	<b>NPM25-85</b>	25	61	85	M16	DC25	1.7
	<b>NPM32-90</b>	32	75	90	M16	DC32, DCS32, DCJ32	2.3
	<b>NPM32-110</b>	32	75	110	M16	DC32, DCS32, DCJ32	2.8
	<b>NPM32-135</b>	32	75	135	M16	DC32, DCS32, DCJ32	3.5
<b>BT50 -</b>	<b>NPM20-95</b>	20	54	95	M16	DC20, DCS20, DCJ20	4.3
	<b>NPM20-125</b>	20	54	125	M16	DC20, DCS20, DCJ20	4.7
	<b>NPM20-165</b>	20	54	165	M16	DC20, DCS20, DCJ20	5.2
	<b>NPM32-110</b>	32	75	110	M24	DC32, DCS32, DCJ32	5.0
	<b>NPM32-135</b>	32	75	135	M24	DC32, DCS32, DCJ32	5.7
	<b>NPM32-165</b>	32	75	165	M24	DC32, DCS32, DCJ32	6.9
	<b>NPM42-110</b>	42	90	110	M24	DC42, DCS42	5.4
	<b>NPM42-135</b>	42	90	135	M24	DC42, DCS42	6.5
<b>NPM42-165</b>	42	90	165	M24	DC42, DCS42	7.9	

↻ Applicable collet **G23**

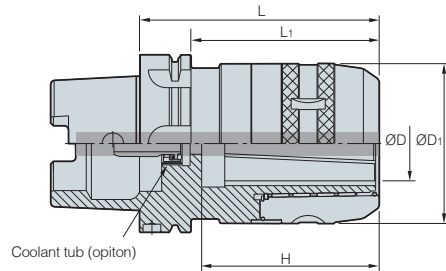
• H: Insertion depth of tool • Through coolant system is optional

• In case of L ≤ 90, chucks with over 90mm are recommended for medium cutting by short cap


## Parts

For separate purchase			
Division	Collet	Spanner	Through coolant system
Parts			
Designation			
<b>NPM20</b>	DC20, DCS20, DCJ20	57-60	CTC20-□□
<b>NPM32</b>	DC32, DCS32, DCJ20	75-79	CTC32-□□
<b>NPM42</b>	DC42, DCS42	92-96	CTC42-□□

# HSK-NPM




(mm)

Designation	ØD	ØD <sub>1</sub>	L	L <sub>1</sub>	H	Collet	
HSK63A - NPM20-100	20	54	100	74	75	DC20, DSC20, DCJ20	2.5
	NPM32-120	32	75	120	84	DC32, DCS32, DCJ32	2.9
HSK100A - NPM32-130	32	75	130	101	90	DC32, DCS32, DCJ32	4.0

 Spare Part **G21, G22**  Applicable collet **G23**

• H: Insertion depth of tool • Through coolant system is optional

## Parts

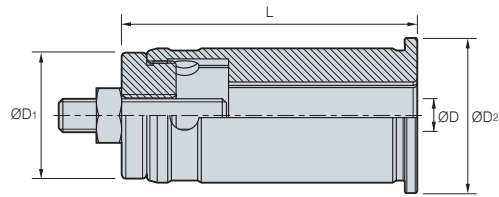
Division	For separate purchase
Internal coolant system	

Classification by shank	
HSK50	HSK50A-CNS
HSK63	HSK63A-CNS
HSK100	HSK100A-CNS




**DCS**

Straight Collet

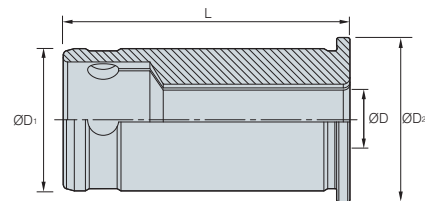


(mm)


Designation	ØD	ØD <sub>1</sub>	ØD <sub>2</sub>	L	
<b>DCS20-6, 8, 10, 12, 16</b>	6, 8, 10, 12, 16	20	26	55	0.2
<b>DCS32-6, 8, 10, 12, 14, 16, 19, 20, 25</b>	6, 8, 10, 12, 14, 16, 19, 20, 25	32	38	70	0.4
<b>DCS42-6, 8, 10, 12, 16, 20, 25, 32</b>	6, 8, 10, 12, 16, 20, 25, 32	42	48	75	0.7

**DC**

Straight Collet

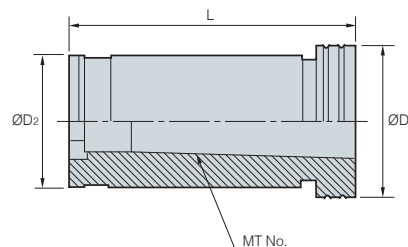


(mm)

Designation	ØD	ØD <sub>1</sub>	ØD <sub>2</sub>	L	
<b>DC20-6, 8, 10, 12, 14, 16</b>	6, 8, 10, 12, 14, 16	20	26	53	0.1
<b>DC25-6, 8, 10, 12, 16</b>	6, 8, 10, 12, 16	25	29	61.5	0.2
<b>DC32-6, 8, 10, 12, 14, 16, 19, 20, 25</b>	6, 8, 10, 12, 14, 16, 19, 20, 25	32	38	64.5	0.2
<b>DC42-6, 8, 10, 12, 16, 20, 25, 32</b>	6, 8, 10, 12, 16, 20, 25, 32	42	48	73	0.5

**TC**

Taper Collet



(mm)

Designation	ØD	ØD <sub>1</sub>	L	MT No.	Designation	ØD	ØD <sub>1</sub>	L	MT No.
<b>TC20-1</b>	26	20	60	MT1	<b>TC32-3</b>	38	32	90	MT3
<b>TC20-2</b>	26	20	72	MT2	<b>TC42-1</b>	48	42	60	MT1
<b>TC25-1</b>	32	25	60	MT1	<b>TC42-2</b>	48	42	72	MT2
<b>TC25-2</b>	32	25	72	MT2	<b>TC42-3</b>	48	42	90	MT3
<b>TC32-1</b>	38	32	60	MT1	<b>TC42-4</b>	48	42	112.5	MT4
<b>TC32-2</b>	38	32	72	MT2					

# G Collet Chuck Series

## Collet chuck

### SDC/P

- Improved precision (higher than conventional SDC)
- Simpler model number management than conventional SDC due to its organized gauge line
- Collet chuck suitable for multi-purpose machining with SWISSMADE sleeve nut adopted
- Boring range:  $\varnothing 1\sim\varnothing 25$

#### Best functional nut (SWISS Made )



General R/RU Nut  
Before




Soft sleeve bearing RN Nut  
After



## High speed collet chuck

### DSK

- Available for machining at max.15,000 RPM and balancing of G6.3
- Minimized tool vibration during operation by using collet  $8^\circ$
- Swiss made high precision nut enhances stability
- Tool clamping range:  $\varnothing 2\sim 25$

Standard type & Precision type	Designation	Max chucking	Run-out
	HC6- $\varnothing d$	6.0	Standard type 5 $\mu m$
	HC10- $\varnothing d$	10.0	
	HC13- $\varnothing d$	13.0	Precision type 3 $\mu m$
	HC16- $\varnothing d$	16.0	
	HC20- $\varnothing d$	20.0	
	HC25- $\varnothing d$	25.0	



#### $8^\circ$ HC collet



Minimized tool vibration during operation

## Great speed slim collet chuck

### GSK

- Available for machining at max.25,000 RPM and balancing of G6.3
- Increased productivity due to high speed machining
- Minimized tool vibration during operation by using collet  $8^\circ$
- Swiss made high precision nut enhances stability by pressing collet uniformly
- Tool clamping range:  $\varnothing 2\sim 25$

#### Original design

Fix on planar part

Nut ideal for high speed rotation

$8^\circ$  HC collet

Strong clamping by  $8^\circ$  collet and stable fixing with the use of planar part fixing

GSK



Chattering due to imbalance

Imbalance due to centrifugal force during high speed rotation

Competitor



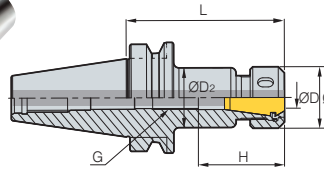
**BT-SDC/P**

Fig. 1

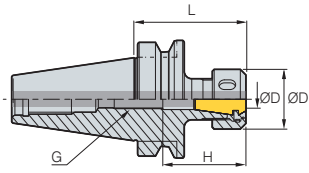


Fig. 2

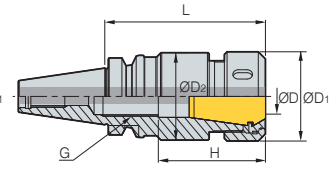



Fig. 3

(mm)

Designation	ØD	ØD <sub>1</sub>	ØD <sub>2</sub>	L	H	Collet	G		Fig.	
<b>BT30 -</b>	<b>SDC7P-70</b>	1.0~7.0	18	17	70	33	GERC11	M7	0.5	1
	<b>SDC7P-100</b>	1.0~7.0	18	17	100	33	GERC11	M7	0.5	1
	<b>SDC10P-50</b>	1.0~10.0	32	-	50	44.5	GERC16	M10	0.5	2
	<b>SDC10P-70</b>	1.0~10.0	32	31	70	44.5	GERC16	M10	0.6	1
	<b>SDC10P-100</b>	1.0~10.0	32	31	100	44.5	GERC16	M10	0.7	1
	<b>SDC13P-50</b>	1.0~13.0	35	-	50	49	GERC20	M7	0.5	2
	<b>SDC13P-70</b>	1.0~13.0	35	34	70	49	GERC20	M13	0.6	1
	<b>SDC13P-100</b>	1.0~13.0	35	34	100	49	GERC20	M13	0.8	1
	<b>SDC16P-50</b>	2.0~16.0	42	-	50	50	GERC25	M7	0.5	2
	<b>SDC16P-70</b>	2.0~16.0	42	41	70	50	GERC25	M18	0.7	1
	<b>SDC16P-100</b>	2.0~16.0	42	41	100	50	GERC25	M18	1.0	1
	<b>SDC20P-60</b>	2.0~20.0	50	-	60	60	GERC32	M7	0.6	2
	<b>SDC20P-90</b>	2.0~20.0	50	49	90	60	GERC32	M22	1.0	3
	<b>SDC20P-120</b>	2.0~20.0	50	49	120	60	GERC32	M22	1.4	3
<b>BT40 -</b>	<b>SDC7P-70</b>	1.0~7.0	18	17	70	33	GERC11	M7	0.9	1
	<b>SDC7P-90</b>	1.0~7.0	18	17	90	33	GERC11	M7	0.9	1
	<b>SDC7P-130</b>	1.0~7.0	18	17	130	33	GERC11	M7	1.0	1
	<b>SDC10P-70</b>	1.0~10.0	32	31	70	44.5	GERC16	M10	1.0	1
	<b>SDC10P-90</b>	1.0~10.0	32	31	90	44.5	GERC16	M10	1.2	1
	<b>SDC10P-130</b>	1.0~10.0	32	31	130	44.5	GERC16	M10	1.4	1
	<b>SDC13P-70</b>	1.0~13.0	35	34	70	49	GERC20	M13	1.1	1
	<b>SDC13P-90</b>	1.0~13.0	35	34	90	49	GERC20	M13	1.2	1
	<b>SDC13P-130</b>	1.0~13.0	35	34	130	49	GERC20	M13	1.4	1
	<b>SDC13P-150</b>	1.0~13.0	35	34	150	49	GERC20	M13	1.6	1
	<b>SDC16P-70</b>	2.0~16.0	42	41	70	50	GERC25	M18	1.1	1
	<b>SDC16P-90</b>	2.0~16.0	42	41	90	50	GERC25	M18	1.3	1
	<b>SDC16P-130</b>	2.0~16.0	42	41	130	50	GERC25	M18	1.7	1
	<b>SDC20P-70</b>	2.0~20.0	50	-	70	60	GERC32	M22	1.1	2
	<b>SDC20P-90</b>	2.0~20.0	50	49	90	60	GERC32	M22	1.4	1
	<b>SDC20P-130</b>	2.0~20.0	50	49	130	60	GERC32	M22	1.9	1
	<b>SDC20P-150</b>	2.0~20.0	50	49	150	60	GERC32	M22	2.2	1
	<b>SDC26P-90</b>	16.0~26.0	63	62	90	71	GERC40	M28	1.7	1

 Spare Part **G26**  Applicable collet **G34**

• H: Insertion depth of tool • Through coolant system is optional  
• Collets in the right size are recommended for oil hole type

# BT-SDC/P

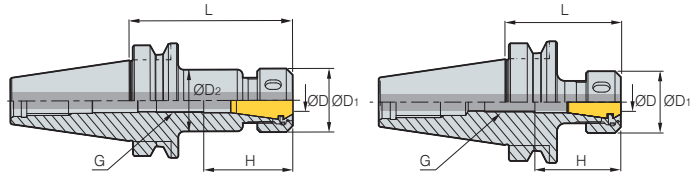



Fig. 1

Fig. 2





(mm)

Designation	ØD	ØD <sub>1</sub>	ØD <sub>2</sub>	L	H	Collet	G		Fig.	
BT50 -	SDC10P-100	1.0~10.0	32	31	100	44.5	GERC16	M10	3.7	1
	SDC10P-120	1.0~10.0	32	31	120	44.5	GERC16	M10	3.7	1
	SDC10P-160	1.0~10.0	32	31	160	44.5	GERC16	M10	3.8	1
	SDC13P-100	1.0~13.0	35	34	100	49	GERC20	M13	3.8	1
	SDC13P-130	1.0~13.0	35	34	130	49	GERC20	M13	3.8	1
	SDC13P-160	1.0~13.0	35	34	160	49	GERC20	M13	4.1	1
	SDC13P-180	1.0~13.0	35	34	180	49	GERC20	M13	4.2	1
	SDC16P-100	2.0~16.0	42	41	100	50	GERC25	M18	3.9	1
	SDC16P-160	2.0~16.0	42	41	160	50	GERC25	M18	4.3	1
	SDC20P-70	2.0~20.0	50	-	70	60	GERC32	M22	1.7	2
	SDC20P-100	2.0~20.0	50	49	100	60	GERC32	M22	4.0	1
	SDC20P-130	2.0~20.0	50	49	130	60	GERC32	M22	4.3	1
	SDC20P-160	2.0~20.0	50	49	160	60	GERC32	M22	4.7	1
	SDC20P-180	2.0~20.0	50	49	180	60	GERC32	M22	5.0	1
SDC26P-160	16.0~26.0	63	62	160	71	GERC40	M28	5.5	1	

 Spare Part **G26**  Applicable collet **G34**

• H: Insertion depth of tool • Through coolant system is optional  
• Collets in the right size are recommended for oil hole type

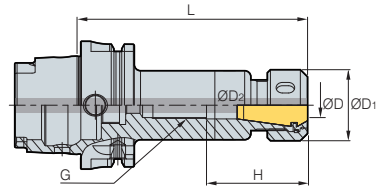
## Parts

Basic			For separate purchase	
Division	Sleeve bearing nut	Adjust screw	Spanner	Collet
Parts				
Designation				
SDC7P	RN11	BN0716F	20-22	GERC/ER 11-ØD
SDC10P	RN16	BN1025F	32-35	GERC/ER 16-ØD
SDC13P	RN20	BN1325F	35-38	GERC/ER 20-ØD
SDC16P	RN25	BN1830F	42-46	GERC/ER 25-ØD
SDC20P	RN32	BN2230F	48-52	GERC/ER 32-ØD
SDC26P	RN40	BN2838F	62-65	GERC/ER 40-ØD


\* NOTES: In case of the BT30-SDC13P-50/HSK63A-SDC13P-100, a BN0716F screw



# HSK-SDC/P




(mm)

Designation	ØD	ØD <sub>1</sub>	ØD <sub>2</sub>	L	H	Collet	G		
HSK63A -	SDC10P-100	1.0~10.0	32	31	100	44.5	GER16	M10	1.0
	SDC13P-100	1.0~13.0	35	34	100	49	GER20	M7	1.1
	SDC16P-100	1.0~16.0	42	41	100	50	GER25	M7	1.2
	SDC20P-110	1.0~20.0	50	49	110	60	GER32	M7	1.5
HSK100A -	SDC16P-110	1.0~16.0	42	41	110	50	GER25	M13	2.6
	SDC20P-120	2.0~20.0	50	49	120	60	GER32	M10	2.9

 Spare Part **G26, G27**  Applicable collet **G34**

• H: Insertion depth of tool • Through coolant system is optional  
• Collets in the right size are recommended for oil hole type

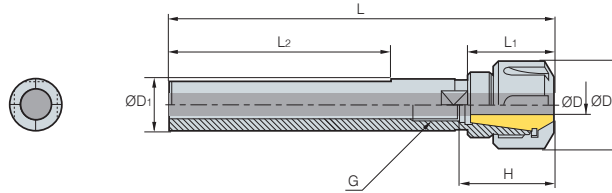
## Parts

Division	For separate purchase
Internal coolant system	


Classification by shank	
HSK50	HSK50A-CNS
HSK63	HSK63A-CNS
HSK100	HSK100A-CNS




# S-SDC



(mm)

Designation	ØD	ØD <sub>1</sub>	ØD <sub>2</sub>	L	L <sub>1</sub>	L <sub>2</sub>	H	Collet	G		
<b>S16 -</b>	<b>SDC7-120M</b>	1.0~7.0	19	16	120	-	-	33	GERC11	M7	0.1
	<b>SDC7-120T</b>	1.0~7.0	19	16	120	-	73	33	GERC11	M7	0.1
	<b>SDC10-150T</b>	1.0~10.0	28	16	150	46.5	83	34.5	GERC16	M10	0.2
<b>S20 -</b>	<b>SDC10-150M</b>	1.0~10.0	28	20	150	26.5	-	34.5	GERC16	M10	0.3
	<b>SDC10-150T</b>	1.0~10.0	28	20	150	26.5	83	34.5	GERC16	M10	0.3
	<b>SDC13-150M</b>	1.0~13.0	35	20	150	50	-	49	GERC20	M13	0.3
	<b>SDC13-150T</b>	1.0~13.0	35	20	150	50	83	49	GERC20	M13	0.3
<b>S25 -</b>	<b>SDC10-150M</b>	1.0~10.0	28	25	150	-	-	34.5	GERC16	M10	0.4
	<b>SDC10-150T</b>	1.0~10.0	28	25	150	-	83	34.5	GERC16	M10	0.4
	<b>SDC13-150M</b>	1.0~13.0	35	25	150	-	-	49	GERC20	M13	0.4
	<b>SDC13-150T</b>	1.0~13.0	35	25	150	-	83	49	GERC20	M13	0.4
<b>S32 -</b>	<b>SDC13-150M</b>	1.0~13.0	35	32	150	-	-	49	GERC20	M13	0.7
	<b>SDC13-150T</b>	1.0~13.0	35	32	150	-	83	49	GERC20	M13	0.7
	<b>SDC20-165M</b>	2.0~20.0	50	32	165	-	-	60	GERC32	M22	0.9
	<b>SDC20-165T</b>	2.0~20.0	50	32	165	-	83	60	GERC32	M22	0.9

 Applicable collet **G34**

• H: Insertion depth of tool • Through coolant system is optional



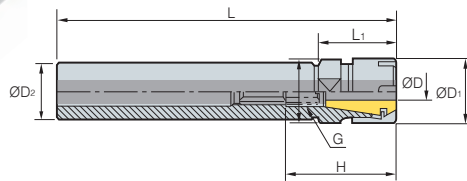
**S-SDC/S**

Fig. 1

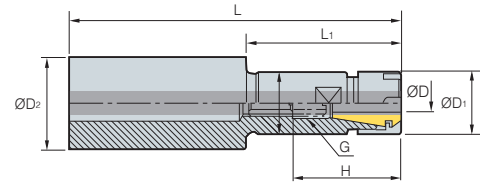




Fig. 2

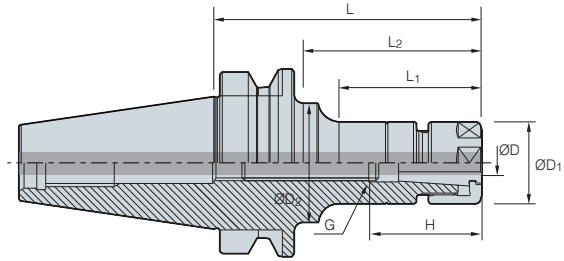
Designation		ØD	ØD <sub>1</sub>	ØD <sub>2</sub>	L	L <sub>1</sub>	H	Collet/Step	G	
<b>S16 -</b>	<b>SDC7S-100M</b>	1.0~7.0	16	16	100	21	33	GERC11/0.5	M7	0.1
	<b>SDC7S-150M</b>	1.0~7.0	16	16	150	21	33	GERC11/0.5	M7	0.1
	<b>SDC10S-100M</b>	1.0~10.0	22	16	100	50	44.5	GERC16/1.0	M10	0.1
	<b>SDC10S-150M</b>	1.0~10.0	22	16	150	50	44.5	GERC16/1.0	M10	0.1
<b>S20 -</b>	<b>SDC7S-100M</b>	1.0~7.0	16	20	100	30	35	GERC11/0.5	M7	0.1
	<b>SDC7S-150M</b>	1.0~7.0	16	20	150	80	35	GERC11/0.5	M7	0.2
	<b>SDC10S-100M</b>	1.0~10.0	22	20	100	50	44.5	GERC16/1.0	M10	0.1
	<b>SDC10S-150M</b>	1.0~10.0	22	20	150	50	44.5	GERC16/1.0	M10	0.2
	<b>SDC10S-200M</b>	1.0~10.0	22	20	200	50	44.5	GERC16/1.0	M10	0.3
	<b>SDC13S-100M</b>	1.0~13.0	28	20	100	50	49	GERC20/1.0	M13	0.1
	<b>SDC13S-150M</b>	1.0~13.0	28	20	150	50	49	GERC20/1.0	M13	0.2
<b>S25 -</b>	<b>SDC7S-100M</b>	1.0~7.0	16	25	100	30	33	GERC11/0.5	M7	0.2
	<b>SDC7S-150M</b>	1.0~7.0	16	25	150	80	33	GERC11/0.5	M7	0.2
	<b>SDC10S-100M</b>	1.0~10.0	22	25	100	30	44.5	GERC16/1.0	M10	0.2
	<b>SDC10S-150M</b>	1.0~10.0	22	25	150	80	44.5	GERC16/1.0	M10	0.3
	<b>SDC13S-100M</b>	1.0~13.0	28	25	100	50	49	GERC20/1.0	M13	0.2
	<b>SDC13S-150M</b>	1.0~13.0	28	25	150	50	49	GERC20/1.0	M13	0.4
	<b>SDC16S-100M</b>	1.0~16.0	35	25	100	50	50	GERC25/1.0	M18	0.3
	<b>SDC16S-150M</b>	1.0~16.0	35	25	150	50	50	GERC25/1.0	M18	0.4
<b>S32 -</b>	<b>SDC16S-120M</b>	1.0~16.0	35	32	120	50	50	GERC25/1.0	M18	0.5
	<b>SDC16S-150M</b>	1.0~16.0	35	32	150	50	50	GERC25/1.0	M18	0.6

(mm)


 Applicable collet **G34**

• H: Insertion depth of tool • Through coolant system is optional

# BT-DSK



(mm)

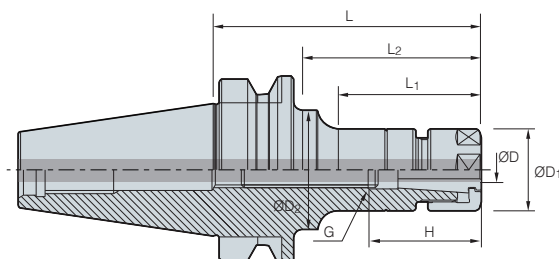
Designation	ØD	ØD <sub>1</sub>	ØD <sub>2</sub>	L	L <sub>1</sub>	L <sub>2</sub>	H	Collet	G	RPM		
<b>BT30 -</b>	<b>DSK6-60</b>	3.0~6.0	19.5	19.5	60	33	33	31	HC6	M8	15,000	0.4
	<b>DSK6-90</b>	3.0~6.0	19.5	32	90	56	65	31	HC6	M8	15,000	0.5
	<b>DSK10-60</b>	2.0~10.0	27.5	27.5	60	35	35	38	HC10	M12	15,000	0.5
	<b>DSK10-90</b>	2.0~10.0	27.5	27.5	90	65	65	38	HC10	M12	15,000	0.6
	<b>DSK13-60</b>	3.0~13.0	33	33	60	36	36	43	HC13	M12	15,000	0.5
	<b>DSK16-60</b>	3.0~16.0	40	40	60	37	37	52	HC16	M12	15,000	0.6
	<b>DSK16-90</b>	3.0~16.0	40	40	90	67	67	52	HC16	M18	15,000	0.8
	<b>DSK25-90</b>	16.0~25.0	55	55	90	67.5	67.5	63.5	HC25	M12	15,000	0.9
<b>BT40 -</b>	<b>DSK6-90</b>	3.0~6.0	19.5	32	90	51	61	31	HC6	M8	10,000	1.1
	<b>DSK6-120</b>	3.0~6.0	19.5	32	120	60	90	31	HC6	M8	10,000	1.1
	<b>DSK6-150</b>	3.0~6.0	19.5	25	150	60	120	31	HC6	M8	10,000	1.1
	<b>DSK10-90</b>	2.0~10.0	27.5	40	90	48	60	38	HC10	M12	10,000	1.2
	<b>DSK10-120</b>	2.0~10.0	27.5	40	120	73	90	38	HC10	M12	10,000	1.2
	<b>DSK10-150</b>	2.0~10.0	27.5	34.5	150	73	118	38	HC10	M12	10,000	1.4
	<b>DSK13-90</b>	3.0~13.0	33	33	90	59	59	43	HC13	M15	10,000	1.3
	<b>DSK16-90</b>	3.0~16.0	40	40	90	58	58	52	HC16	M18	10,000	1.3
	<b>DSK16-120</b>	3.0~16.0	40	40	120	88	88	52	HC16	M18	10,000	1.5
	<b>DSK16-150</b>	3.0~16.0	40	40	150	118	118	52	HC16	M18	10,000	1.9
	<b>DSK20-90</b>	4.0~20.0	48.5	48.5	90	60	60	60	HC20	M22	10,000	1.5
	<b>DSK20-120</b>	4.0~20.0	48.5	48.5	120	90	90	60	HC20	M22	10,000	1.8
	<b>DSK25-90</b>	16.0~25.0	55	55	90	61	61	63.5	HC25	M28	10,000	1.6
	<b>DSK25-120</b>	16.0~25.0	55	55	120	91	91	85	HC25	M28	10,000	2.0

 Spare Part **G31**  Applicable collet **G33**

- H: Insertion depth of tool
- Through coolant system is optional
- Coolant collets are recommended when using the coolant system



# BT-DSK



(mm)

Designation	ØD	ØD <sub>1</sub>	ØD <sub>2</sub>	L	L <sub>1</sub>	L <sub>2</sub>	H	Collet	G	RPM	kg	
<b>BT50 -</b>	<b>DSK6-105</b>	3.0~6.0	19.5	32	105	55	64	31	HC6	M8	8,000	3.6
	<b>DSK6-135</b>	3.0~6.0	19.5	32	135	60	92	31	HC6	M8	8,000	3.7
	<b>DSK6-165</b>	3.0~6.0	19.5	32	165	60	114	31	HC6	M8	8,000	4.1
	<b>DSK10-105</b>	2.0~10.0	27.5	27.5	105	57	57	38	HC10	M12	8,000	3.8
	<b>DSK10-135</b>	2.0~10.0	27.5	32	135	70	92	38	HC10	M12	8,000	3.9
	<b>DSK10-165</b>	2.0~10.0	27.5	36	165	75	114	38	HC10	M12	8,000	4.1
	<b>DSK13-135</b>	3.0~13.0	33	33	135	92	92	43	HC13	M15	8,000	3.8
	<b>DSK16-105</b>	3.0~16.0	40	40	105	62	62	52	HC16	M18	8,000	4.0
	<b>DSK16-135</b>	3.0~16.0	40	40	135	92	92	52	HC16	M18	8,000	4.2
	<b>DSK16-165</b>	3.0~16.0	40	50	165	40	122	52	HC16	M18	8,000	4.6
	<b>DSK20-105</b>	4.0~20.0	48	40	105	62	62	60	HC20	M22	8,000	4.2
	<b>DSK20-135</b>	4.0~20.0	48	40	135	92	92	60	HC20	M22	8,000	4.5
	<b>DSK20-165</b>	4.0~20.0	48	40	165	122	122	60	HC20	M22	8,000	4.9
	<b>DSK25-105</b>	16.0~25.0	55	55	105	62	62	63.5	HC25	M28	8,000	4.4
	<b>DSK25-135</b>	16.0~25.0	55	55	135	92	92	63.5	HC25	M28	8,000	4.5
<b>DSK25-165</b>	16.0~25.0	55	55	165	122	122	63.5	HC25	M28	8,000	5.2	

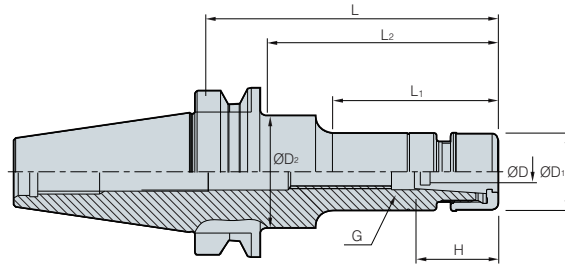
Applicable collet **G33**

- H: Insertion depth of tool
- Through coolant system is optional
- Coolant collets are recommended when using the coolant system


## Parts

Division	Basic			For separate purchase
	Nut	Adjust screw	Extractor	Spanner
<b>Parts</b>				
<b>Designation</b>				
<b>DSK6</b>	DN6	BN0825F	DSK-6CE	DSS-6
<b>DSK10</b>	DN10	BN1225F	DSK-10CE	DSS-10
<b>DSK13</b>	DN13	BN1230 (BT30)/BN1524F (Others)	DSK-13CE	DSS-13
<b>DSK16</b>	DN16	BN1830F	DSK-16CE	DSS-16
<b>DSK20</b>	DN20	BN2230F	DSK-20CE	DSS-20
<b>DSK25</b>	DN25	BN2838F	DSK-25CE	DSS-25

# BT-GSK



(mm)

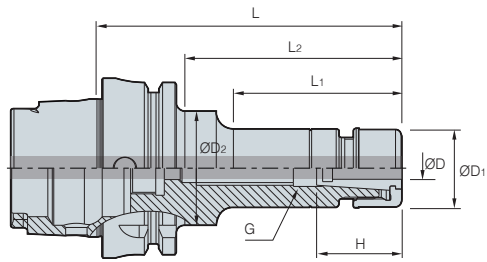
Designation	ØD	ØD <sub>1</sub>	ØD <sub>2</sub>	L	L <sub>1</sub>	L <sub>2</sub>	H	Collet/ Step	G	RPM		
<b>BT30 -</b>	<b>GSK6-60</b>	3.0~6.0	19.5	19.5	60	33	33	31	HC6/1.0	M8	25,000	0.4
	<b>GSK6-90</b>	3.0~6.0	19.5	32	90	56	65	31	HC6/1.0	M8	25,000	0.5
	<b>GSK10-60</b>	2.0~10.0	27	27	60	35	35	38	HC10/1.0	M12	25,000	0.5
	<b>GSK10-90</b>	2.0~10.0	27	27	90	65	65	38	HC10/1.0	M12	25,000	0.6
	<b>GSK13-60</b>	3.0~13.0	35	35	60	36	36	43	HC13/1.0	M12	25,000	0.6
	<b>GSK16-60</b>	3.0~16.0	40	40	60	37	37	52	HC16/1.0	M12	25,000	0.6
	<b>GSK16-90</b>	3.0~16.0	40	40	90	67	67	52	HC16/1.0	M18	25,000	0.8
	<b>GSK25-90</b>	16.0~25.0	55	55	90	67.5	67.5	63.5	HC25/1.0	M12	25,000	1.0
<b>BT40 -</b>	<b>GSK6-90</b>	3.0~6.0	19.5	32	90	51	61	31	HC6/1.0	M8	20,000	1.0
	<b>GSK6-120</b>	3.0~6.0	19.5	32	120	60	90	31	HC6/1.0	M8	20,000	1.2
	<b>GSK6-150</b>	3.0~6.0	19.5	25	150	60	120	31	HC6/1.0	M8	20,000	1.2
	<b>GSK10-90</b>	2.0~10.0	27	40	90	48	60	38	HC10/1.0	M12	20,000	1.1
	<b>GSK10-120</b>	2.0~10.0	27	40	120	73	90	38	HC10/1.0	M12	20,000	1.3
	<b>GSK10-150</b>	2.0~10.0	27	34.5	150	73	118	38	HC10/1.0	M12	20,000	1.4
	<b>GSK13-90</b>	3.0~13.0	35	35	90	59	59	43	HC13/1.0	M15	20,000	1.2
	<b>GSK16-90</b>	3.0~16.0	40	40	90	58	58	52	HC16/1.0	M18	20,000	1.3
	<b>GSK16-120</b>	3.0~16.0	40	40	120	88	88	52	HC16/1.0	M18	20,000	1.5
	<b>GSK16-150</b>	3.0~16.0	40	40	150	118	118	52	HC16/1.0	M18	20,000	1.8
	<b>GSK20-90</b>	4.0~20.0	48	48	90	60	60	60	HC20/1.0	M22	20,000	1.4
	<b>GSK20-120</b>	4.0~20.0	48	48	120	90	90	60	HC20/1.0	M22	20,000	1.8
	<b>GSK25-90</b>	16.0~25.0	55	55	90	61	61	63.5	HC25/1.0	M28	20,000	1.6
<b>GSK25-120</b>	16.0~25.0	55	55	120	91	91	63.5	HC25/1.0	M28	20,000	2.0	
<b>BT50 -</b>	<b>GSK6-105</b>	3.0~6.0	19.5	32	105	55	64	31	HC6	M8	15,000	3.6
	<b>GSK6-135</b>	3.0~6.0	19.5	32	135	60	92	31	HC6	M8	15,000	3.6
	<b>GSK6-165</b>	3.0~6.0	19.5	32	165	60	114	31	HC6	M8	15,000	3.9
	<b>GSK10-105</b>	2.0~10.0	27	27	105	57	57	38	HC10	M12	15,000	3.7
	<b>GSK10-135</b>	2.0~10.0	27	32	135	70	92	38	HC10	M12	15,000	3.7
	<b>GSK10-165</b>	2.0~10.0	27	36	165	75	114	38	HC10	M12	15,000	4.0
	<b>GSK13-135</b>	3.0~13.0	35	35	135	92	92	43	HC13	M15	15,000	3.9
	<b>GSK16-105</b>	3.0~16.0	40	40	105	62	62	52	HC16	M18	15,000	3.9
	<b>GSK16-135</b>	3.0~16.0	40	40	135	92	92	52	HC16	M18	15,000	4.1
	<b>GSK16-165</b>	3.0~16.0	40	50	165	40	122	52	HC16	M18	15,000	4.3
	<b>GSK20-105</b>	4.0~20.0	48	-	105	62	62	60	HC20	M22	15,000	4.1
	<b>GSK20-135</b>	4.0~20.0	48	-	135	92	92	60	HC20	M22	15,000	4.4
	<b>GSK20-165</b>	4.0~20.0	48	-	165	122	122	60	HC20	M22	15,000	4.9
	<b>GSK25-105</b>	16.0~25.0	55	55	105	62	62	63.5	HC25	M28	15,000	4.2
	<b>GSK25-135</b>	16.0~25.0	55	55	135	92	92	63.5	HC25	M28	15,000	4.6
<b>GSK25-165</b>	16.0~25.0	55	55	165	122	122	63.5	HC25	M28	15,000	5.1	

↻ Spare Part **G33** ↻ Applicable collet **G33**

- H: Insertion depth of tool
- Through coolant system is optional
- Coolant collets are recommended when using the coolant system



# HSK-GSK



(mm)

Designation	ØD	ØD <sub>1</sub>	ØD <sub>2</sub>	L	L <sub>1</sub>	L <sub>2</sub>	H	Collet / Step	G	RPM	kg	
HSK63A -	GSK6-100	3.0~6.0	19.5	32	100	51	61	35	HC6/0.5	M8	20,000	0.8
	GSK10-105	2.0~10.0	27	34.5	105	73	118	50	HC10/0.5	M12	20,000	0.9
	GSK16-120	3.0~16.0	40	40	120	58	58	60	HC16/0.5	M18	20,000	1.3
	GSK20-120	4.0~20.0	48	48	120	60	60	70	HC20/0.5	M22	20,000	1.6
HSK100A -	GSK6-120	3.0~6.0	19.5	32	120	55	64	35	HC6/0.5	M8	15,000	2.2
	GSK10-120	2.0~10.0	27	27	120	57	57	50	HC10/0.5	M12	15,000	2.3
	GSK16-140	3.0~16.0	40	40	140	62	62	60	HC16/0.5	M18	15,000	2.8
	GSK25-155	16.0~25.0	55	55	155	62	62	85	HC25/0.5	M28	15,000	3.6

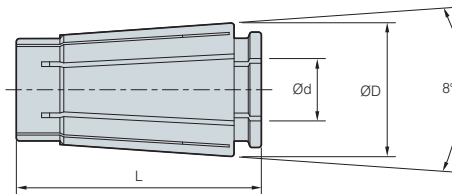
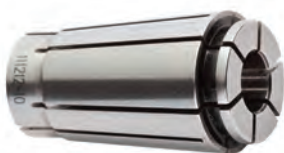
• H: Insertion depth of tool

## Parts

Basic				For separate purchase
Division	Nut	Adjust screw	Extractor	Spanner
Parts				
Designation				
GSK6	GN6	M820C	DSK-6CE	GSK-6
GSK10	GN10	M1230C	DSK-10CE	GSK-10
GSK13	GN13	BN1530F	DSK-13CE	GSK-13
GSK16	GN16	BN1830F	DSK-16CE	GSK-16
GSK20	GN20	BN2230F	DSK-20CE	GSK-20
GSK25	GN25	BN2838F	DSK-25CE	GSK-25

# HC Slim Collet

General & precision type



(mm)

Designation	ØD	L	Ød (Max.)	Distance (mm)	Tolerance	
					Standard type	Precision type (P)
HC6 - Ød(P)	10.5	25.0	6.0	1.0	5 µm	3 µm
HC10 - Ød(P)	15.6	30.5	10.0	1.0		
HC13 - Ød(P)	20.1	39.0	13.0	1.0		
HC16 - Ød(P)	24.6	45.0	16.0	1.0		
HC20 - Ød(P)	29.2	54.3	20.0	2.0		
HC25 - Ød(P)	35.7	57.0	25.0	1.0		



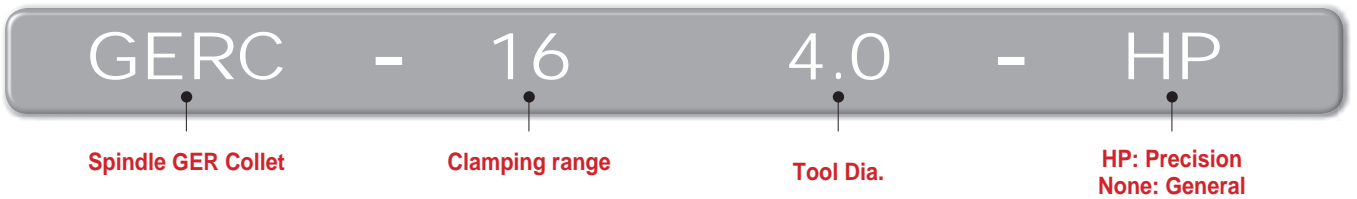
## GERC Collet

# GERC new

- Corrosion resistant collet to micro unit
- High tech coating for long lasting precision
- Longer tool life and higher productivity

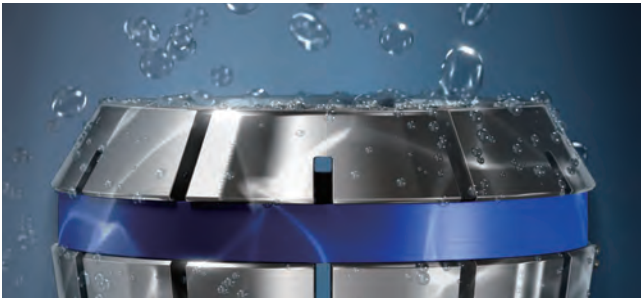


### Code system



### Special coating technology

Unlike GERC collets, Conventional non-coated collets have the following features:  
 Non-coated collets are affected by corrosion due to high humidity, cutting fluid, cleaner, salt, gas and many other factors, which in result deteriorates whole quality of machining



When a collet gets rusty, the tool life is shortened and precision considerably decreases. To prevent this problem, surface treatment by micro unit was applied to GERC collets for effective protection and long lasting precision



GERC



Competitor

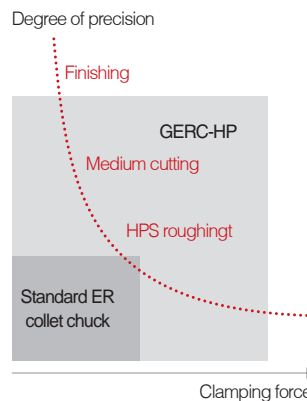
Two samples of collets after 4 months of use:  
 Left: GERC collet, Right: Non-coated

### GERC-HP

A precision type collet chuck is expensive than standard one, but still it has more advantages in long term cost and efficiency. Using GERC-HP can minimize pricy reworking due to smaller tolerance with maximum precision

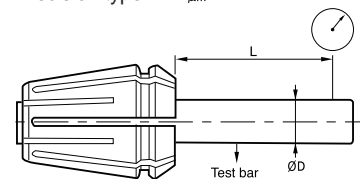


Precision type collet 2  $\mu$ m



### Precision (L/D = 3)

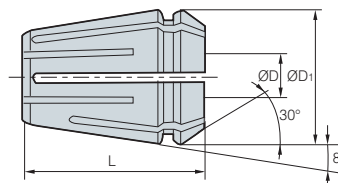
Standard type = 5  $\mu$ m  
 Precision type = 2  $\mu$ m





# GERC Collet

General/Precision/Water proof type



(mm)

Designation	ER size	ØD (Max.)	ØD <sub>1</sub>	L	Min. pi of water proof type	Distance (mm)	Tolerance	
							Standard type	Precision type (HP)
GER11-Ød(HP)	11	7.0	11.5	18.0	-	0.5	5 µm	2 µm
GER16-Ød(HP, C)	16	10.0	17.0	27.5	5.0	1.0		
GER20-Ød(HP, C)	20	13.0	21.0	31.5	6.0	1.0		
GER25-Ød(HP, C)	25	16.0	26.0	34.0	6.0	1.0		
GER32-Ød(HP, C)	32	20.0	33.0	40.0	8.0	1.0		
GER40-Ød	40	26.0	41.0	46.0	10.0	1.0		

# GERC Collet

General type



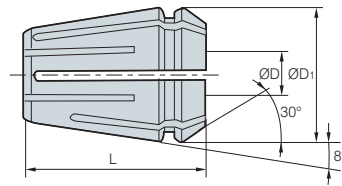
(mm)

Designation	ØD	Distance	Collet amount	Tolerance	kg
GERC11 1.0-7.0 mm/0.5 mm	1.0-7.0	0.5	13 pcs	5 µm	0.1
GERC16 1.0-10.0 mm/1.0 mm	1.0-10.0	1.0	10 pcs	5 µm	0.2
GERC20 2.0-13.0 mm/1.0 mm	2.0-13.0	1.0	12 pcs	5 µm	0.5
GERC25 2.0-16.0 mm/1.0 mm	2.0-16.0	1.0	15 pcs	5 µm	1.1
GERC32 3.0-20.0 mm/1.0 mm	3.0-20.0	1.0	18 pcs	5 µm	2.6
GERC40 4.0-26.0 mm/1.0 mm	4.0-26.0	1.0	23 pcs	5 µm	5.8



# ER Collet

General/Water proof type



(mm)

Designation	ER size	ØD (Max.)	ØD <sub>1</sub>	L	Min. pi of water proof type	Distance (mm)	Tolerance
ER11-Ød	11	7.0	11.5	18.0	-	0.5	10 µm
ER16-Ød (C)	16	10.0	17.0	27.5	5.0	1.0	
ER20-Ød (C)	20	13.0	21.0	31.5	6.0	1.0	
ER25-Ød (C)	25	16.0	26.0	34.0	6.0	1.0	
ER32-Ød (C)	32	20.0	33.0	40.0	8.0	1.0	

# ER Collet

General type



(mm)

Designation	ØD	Distance	Collet amount	Tolerance
ER11(SET)	1.0-7.0	0.5	12 pcs	10 µm
ER16(SET)	1.0-10.0	1.0	10 pcs	10 µm
ER20(SET)	2.0-13.0	1.0	12 pcs	10 µm
ER25(SET)	2.0-16.0	1.0	15 pcs	10 µm
ER32(SET)	3.0-20.0	1.0	18 pcs	10 µm



## Lock collet for ER collet chuck

## ER/L

- Designed to prevent the end mill from falling out
- Prevents tool fallout, slipping, or idle running
- Uses the Weldon flat (DIN 6535HB) end mill without any special endmill
- Useful for machining large-sized mold or difficult-to-cut materials



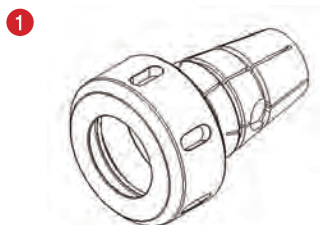
### Structural Features

#### Designed to prevent fallout

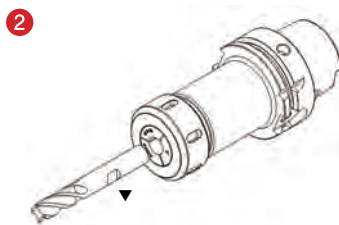
- Tool fallout is prevented by a key inserted in the collet
- A key is inserted to prevent the tool from falling out

### How to use

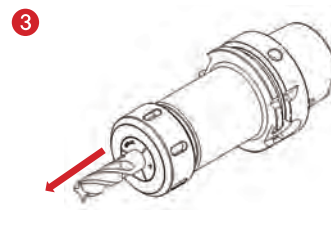
- Assemble the collet with nut (same for general ER collet in use)
- Assemble the end tool (in the direction of assembling notch with key)
- Tighten the nut with the body



Combine the non-slip ER collet with nut



Clamp the nut after inserting no. ❶ into the collet chuck. After that, insert the end mill notch to be aligned with the part ▼ (steel ball position)

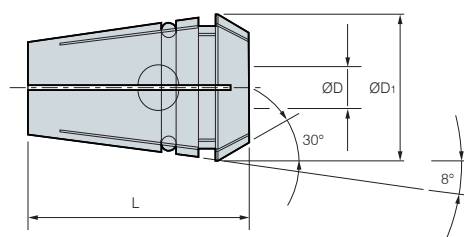


After checking that the steel ball in the collet is caught in the notched part, completely clamp the nut by pulling the end mill in the axial direction (arrow direction)

**Note** If an auto clamp device is used, skip step ❸ (Endmill rotation may cause injury.)

## ER/L Collet

### Non-slip collet chuck collet



(mm)

Designation	ØD	ØD	ØD <sub>1</sub>	L
ER20-6L	20	6	20.7	31.5
ER20-8L	20	8	20.7	31.5
ER20-10L	20	10	20.7	31.5
ER20-12L	20	12	20.7	31.5
ER32-12L	32	12	32.7	40
ER32-16L	32	16	32.7	40
ER32-20L	32	20	32.7	40

## Jet coolant disk

# RTJW

- Provides a longer cutting tool service life by preventing chips from adhering to the tool
- Improves chip breakability/breaking strong jet injection
- Reduces equipment non-operation time as nozzle position change is not necessary

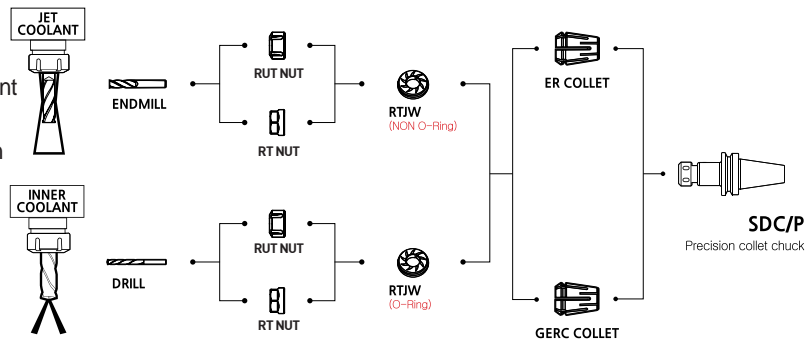


### Code system



### Application

- With one waterproof type (RT, RUT) NUT, the inside jet coolant is simultaneously used
- Enables a fast change of the inside jet coolant only by disk replacement
- Strong jet injection with no scattering even in the high-speed rotation



#### RT NUT

Type	M	D	L
RT16	M22x1.50	28.0	22.5

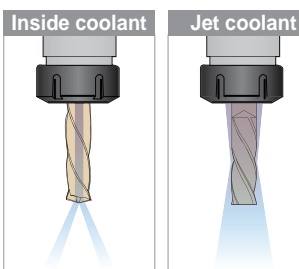


#### RUT NUT

Type	M	D	L
RUT20	M25x1.50	35.0	24.0
RUT25	M32x1.50	42.0	25.0
RUT32	M40x1.50	50.0	27.5
RUT40	M50x1.50	63.0	30.5

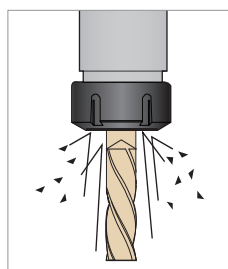


	Pocket machining	After	Remarks
Jet coolant			▶ The chips in the pocket completely are removed by a strong jet injection
Outside coolant			▶ The chips in the pocket are not removed ▶ Chips are accumulated in the collet and nut



#### Coolant method

According to use, inside coolant and jet coolant refueling can be used



#### Mixing prevention

Effective for vibration proof by preventing mixing of cutting chips by using RTJW

# RTJW



(mm)

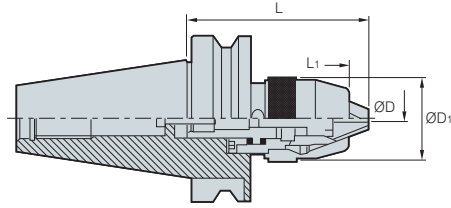
Designation		ER size	Inner diameter	Designation		ER size	Inner diameter
RTJW16 -	RTJW16-6	16	6	RTJW32 -	RTJW32-6	32	6
	RTJW16-7	16	7		RTJW32-7	32	7
	RTJW16-8	16	8		RTJW32-8	32	8
RTJW20 -	RTJW20-6	20	6		RTJW32-9	32	9
	RTJW20-7	20	7		RTJW32-10	32	10
	RTJW20-8	20	8		RTJW32-11	32	11
	RTJW20-9	20	9		RTJW32-12	32	12
	RTJW20-10	20	10		RTJW32-13	32	13
RTJW25 -	RTJW25-6	25	6		RTJW32-14	32	14
	RTJW25-7	25	7		RTJW32-15	32	15
	RTJW25-8	25	8		RTJW32-16	32	16
	RTJW25-9	25	9		RTJW32-17	32	17
	RTJW25-10	25	10		RTJW32-18	32	18
	RTJW25-11	25	11	RTJW32-20	32	20	
	RTJW25-12	25	12	RTJW40 -	RTJW40-18	40	18
	RTJW25-13	25	13		RTJW40-19	40	19
	RTJW25-14	25	14		RTJW40-20	40	20
	RTJW25-15	25	15		RTJW40-21	40	21
RTJW25-16	25	16	RTJW40-22		40	22	
			RTJW40-24		40	24	

➔ Clamping items: G25~G27


• Less than Ø5 cannot be used for production



# BT-NPU

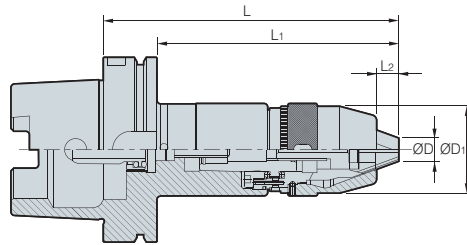


(mm)


Designation	ØD	ØD <sub>1</sub>	L	L <sub>1</sub>	
<b>BT30 -</b> NPU8-97	1~ 8	38	97	8.5	0.8
NPU13-125	1~13	50	125	12.5	1.4
<b>BT40 -</b> NPU8-87	1~ 8	38	87	8.5	1.2
NPU13-105	1~13	50	105	12.5	1.6
NPU13-130	1~13	50	130	12.5	1.9
<b>BT50 -</b> NPU13-130	1~13	50	130	12.5	4.5
NPU13-190	1~13	50	190	12.5	5.3

• Through coolant system not available

# HSK-NPU






(mm)

Designation	ØD	ØD <sub>1</sub>	L	L <sub>1</sub>	L <sub>2</sub>	
<b>HSK63A -</b> NPU13-175	1~13	50	175	149	12.5	2.4
<b>HSK100A -</b> NPU13-180	1~13	50	180	151	12.5	3.6

• Through coolant system not available

## Parts

Division	Basic		For separate purchase
	Chuck	Bolt	Spanner
<b>Parts</b>			
<b>Designation</b>			
<b>NPU8</b>	NPU08	BX0620	NPU0836
<b>NPU13</b>	NPU13	BX0825	NPU1348



## High speed synchro tapping chuck

DST **new**

- Tapping chuck for high speed machining
- Specially designed structure for absorbing thrust load and preventing damage on the tap
- Through coolant system available
- Applicable range: M1~M22



### Code system



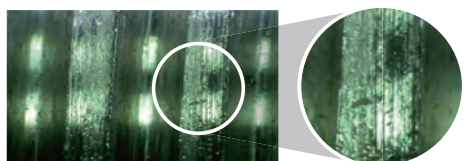
### Excellent performance, precise machining

Expanded machining area



**DST22**  
(vc = 100 m/min)

Excellent cutting face

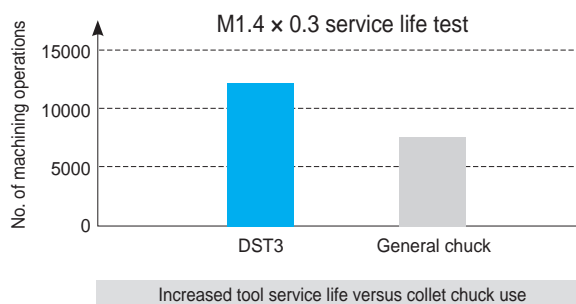


Conventional one

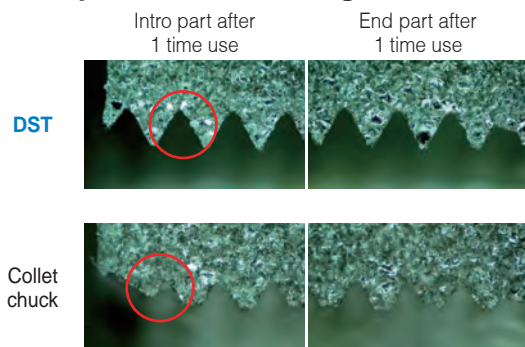


#### Exclusive collet for tapping

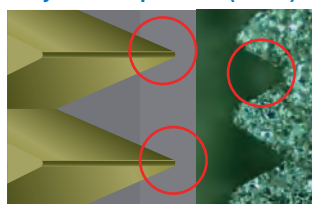
- At tapping work use of TER collet
- DST3: Use of ER11 collet



### Comparison of thread figures

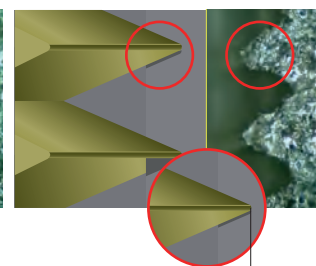


#### Synchro tap chuck (DST7)



The threads have a good figure, and didn't get out of its shape

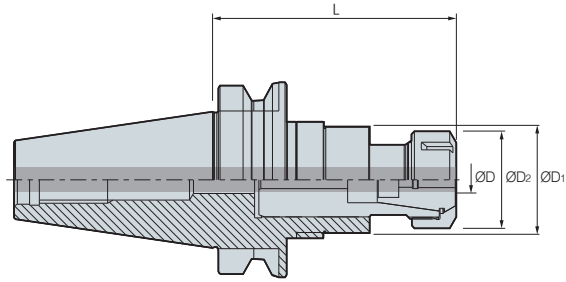
#### General collet chuck




The thread is out of its shape due to synchronization error



# BT-DST



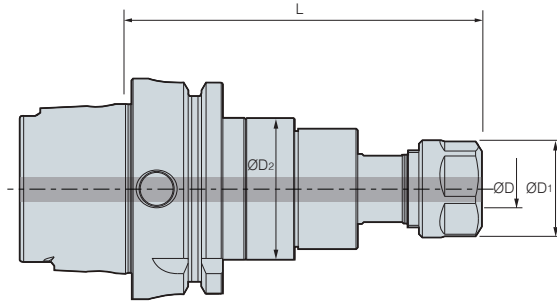
(mm)

Designation	ØD	ØD <sub>1</sub>	ØD <sub>2</sub>	L	Collet	F-	F+		
<b>BT30 -</b>	<b>DST3-70</b>	M1~M3	20	19	70	ER11	0.5	0.5	0.5
	<b>DST10-100</b>	M3~M10	40.4	28	100	TER16	0.5	0.5	0.8
<b>BT40 -</b>	<b>DST3-70</b>	M1~M3	20	19	70	ER11	0.5	0.5	1.0
	<b>DST10-100</b>	M3~M10	40.4	28	100	TER16	0.5	0.5	1.3
	<b>DST22-110</b>	M6~M22	60	49.5	110	TER32	0.7	0.7	1.7
<b>BT50 -</b>	<b>DST10-110</b>	M3~M10	60	49.5	110	TER16	0.5	0.5	3.8
	<b>DST22-130</b>	M6~M22	60	49.5	130	TER32	0.7	0.7	4.5


 Applicable collet **G36, G43**


• Through coolant system is optional

# HSK-DST



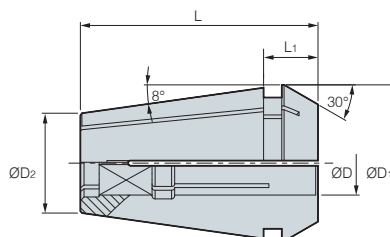
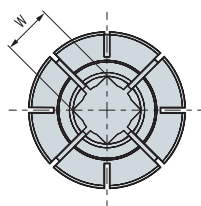
(mm)

Designation	ØD	ØD <sub>1</sub>	ØD <sub>2</sub>	L	Collet	F-	F+		
<b>HSK63A -</b>	<b>DST3-80</b>	M1~M3	19	20	80	ER11	0.5	0.5	0.7
	<b>DST10-100</b>	M3~M10	28	40.4	100	TER16	0.5	0.5	0.9
	<b>DST22 130</b>	M6~M22	49.5	60	130	TER32	0.7	0.7	1.8


 Applicable collet **G36, G43**

• Through coolant system is optional





(mm)

Designation	Tapping Range	ØD	ØD <sub>1</sub>	ØD <sub>2</sub>	L	L <sub>1</sub>	W		
<b>TER16 -</b>	<b>4x3.2</b>	M3	4	16.74	10.1	27.5	6.3	3.2	0.03
	<b>5x4</b>	M4	5	16.74	10.1	27.5	6.3	4	0.03
	<b>5.5x4.5</b>	M5	5.5	16.74	10.1	27.5	6.3	4.5	0.02
	<b>6x4.5</b>	M6, U1/4	6	16.74	10.1	27.5	6.3	4.5	0.02
	<b>6.2x5</b>	M7, M8	6.2	16.74	10.1	27.5	6.3	5	0.02
	<b>7x5.5</b>	M9, M10, U3/8	7	16.74	10.1	27.5	6.3	5.5	0.02
<b>TER20 -</b>	<b>5x4</b>	M4	5	20.74	13.2	31.5	7.2	4	0.05
	<b>5.5x4.5</b>	M5	5.5	20.74	13.2	31.5	7.2	4.5	0.05
	<b>6x4.5</b>	M6, U1/4	6	20.74	13.2	31.5	7.2	4.5	0.05
	<b>6.2x5</b>	M7, M8	6.2	20.74	13.2	31.5	7.2	5	0.04
	<b>7x5.5</b>	M9, M10, U3/8	7	20.74	13.2	31.5	7.2	5.5	0.05
	<b>8x6</b>	M11, U7/16, P1/8	8	20.74	-	-	-	6	0.04
<b>TER25 -</b>	<b>5x4</b>	M4	5	25.74	17.6	34	7.5	4	0.9
	<b>5.5x4.5</b>	M5	5.5	25.74	17.6	34	7.5	4.5	0.8
	<b>6x4.5</b>	M6	6	25.74	17.6	34	7.5	4.5	0.8
	<b>6.2x5</b>	M7, M8	6.2	25.74	17.6	34	7.5	5	0.1
	<b>7x5.5</b>	M9, M10, U3/8	7	25.74	17.6	34	7.5	5.5	0.8
	<b>8.5x6.5</b>	M12	8.5	25.74	17.6	34	7.5	6.5	0.8
<b>TER32 -</b>	<b>6x4.5</b>	M6, U1/4	6	32.74	23.1	40	8.2	4.5	0.2
	<b>6.2x5</b>	M7, M8	6.2	32.74	23.1	40	8.2	5	0.2
	<b>7x5.5</b>	M9, M10, U3/8	7	32.74	23.1	40	8.2	5.5	0.2
	<b>8X6</b>	M11, U7/16, P1/8	8	32.74	23.1	40	8.2	6	0.2
	<b>8.5x6.5</b>	M12	8.5	32.74	23.1	40	8.2	6.5	0.2
	<b>10.5x8</b>	M14, U9/16	10.5	32.74	23.1	40	8.2	8	0.2
	<b>12.5x10</b>	M16	12.5	32.74	23.1	40	8.2	10	0.2
	<b>14x11</b>	M18, P3/8	14	32.74	23.1	40	8.2	11	0.1
	<b>15x12</b>	M20	15	32.74	23.1	40	8.2	12	0.1
	<b>17x13</b>	M22, U7/8	17	32.74	23.1	40	8.2	13	0.1
	<b>11x9</b>	P1/4	11	32.74	23.1	40	8.2	9	0.2
	<b>12x9</b>	U5/8	12	32.74	23.1	40	8.2	9	0.2
	<b>9x7</b>	U1/2	9	32.74	23.1	40	8.2	7	0.2

• Water proof tapping is possible with the use of RTJW and nuts (limited to the right sizes)



## Tapping holder

# DTN

- Compact design and slim type
- Improvement of tapping force
- Tapping range: M3~M38

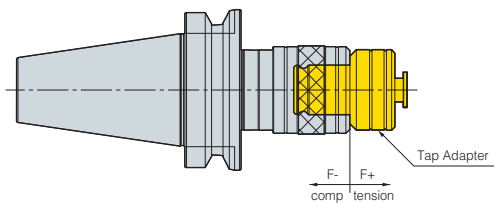


### Code system



### Easy exchange of TCA (Tap adaptor)

Convenient one-touch exchange type for high precision and longer tool life  
 Contraction of length is possible by axial floating way

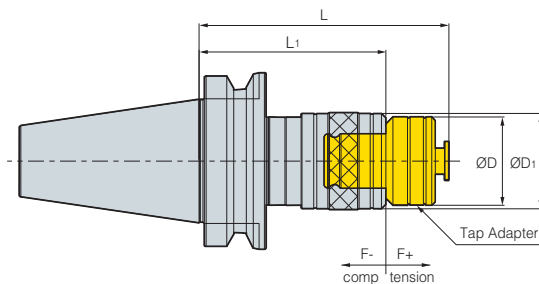


### How to clamp TCA and a tap holder

Before installation	After installation	Disassembly
<ol style="list-style-type: none"> <li>1. Insert TCA pushing the cover of tap holder</li> <li>2. Clamp the TCA in the Key groove and firmly</li> </ol>	<ol style="list-style-type: none"> <li>1. The cover of tap holder is placed correctly</li> </ol>	<ol style="list-style-type: none"> <li>1. Separate the TCA pushing the cover of tap holder</li> </ol>



# BT-DTN

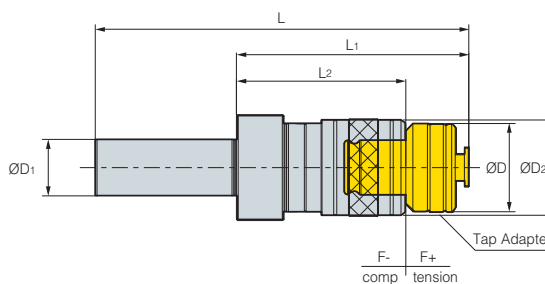


Designation		Tapping range	ØD	ØD <sub>1</sub>	L	L <sub>1</sub>	Adaptor	F-	F+	(mm)
BT30 -	DTN12-85	M3~M12	32	39	85	60	TCA1-M	4	10	0.5
	DTN12-90	M3~M12	32	39	90	65	TCA1-M	4	10	1.2
BT40 -	DTN12-120	M3~M12	32	39	120	95	TCA1-M	4	10	1.5
	DTN22-130	M8~M24	50	56	130	96	TCA2-M	12.5	12.5	1.7
	DTN22-160	M8~M24	50	56	160	126	TCA2-M	12.5	12.5	2.2
BT50 -	DTN12-100	M3~M12	32	39	100	75	TCA1-M	4	10	3.9
	DTN12-130	M3~M12	32	39	130	105	TCA1-M	4	10	3.9
	DTN22-140	M8~M24	50	56	140	106	TCA2-M	12.5	12.5	4.3
	DTN22-170	M8~M24	50	56	170	136	TCA2-M	12.5	12.5	4.7
	DTN38-185	M16~M38	72	81	185	140	TCA3-M	20	20	5.7
	DTN38-215	M16~M38	72	81	215	170	TCA3-M	20	20	6.7

Tap Adapter (TCA) G46

• Through coolant system not available

# S-DTN

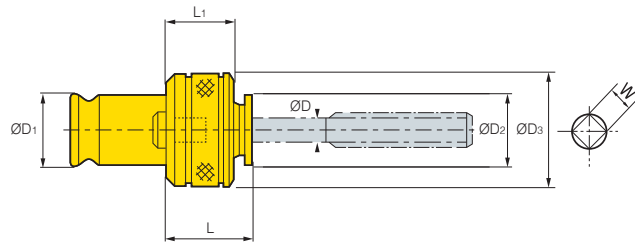


Designation		Tapping range	ØD	ØD <sub>1</sub>	ØD <sub>2</sub>	L	L <sub>1</sub>	L <sub>2</sub>	F-	F+	Adaptor	(mm)
S32 -	DTN12-90	M3-M12	32	32	39	170	90	65	4	10	TCA1	1.0
	DTN22-130	M8-M24	32	50	56	210	130	96	12.5	12.5	TCA2	1.8


Tap Adapter (TCA) G46

• Through coolant system not available

# TCA Tap Adaptor



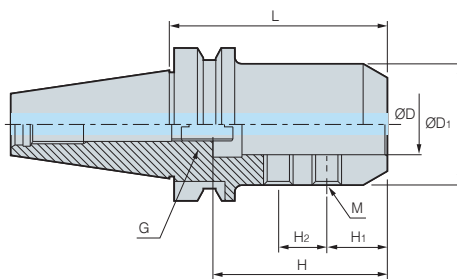
(mm)

Designation		ØD	ØD <sub>1</sub>	ØD <sub>2</sub>	ØD <sub>3</sub>	L	L <sub>1</sub>	W	
TCA1 -	M3	4	19	18.5	32	26.5	24.5	3.2	0.2
	M4	5	19	18.5	32	26.5	24.5	4	0.2
	M5	5.5	19	18.5	32	26.5	24.5	4	0.2
	M6	6	19	18.5	32	26.5	24.5	4	0.2
	M8	6.2	19	18.5	32	26.5	24.5	5	0.2
	M10	7	19	18.5	32	26.5	24.5	5.5	0.2
	M11	8	19	18.5	32	26.5	24.5	6	0.2
	M12	8.5	19	18.5	32	26.5	24.5	6.5	0.2
TCA2 -	M8	6.2	31	29	50	34	30.5	5	0.5
	M10	7	31	29	50	34	30.5	5.5	0.5
	M12	8.5	31	29	50	34	30.5	6.5	0.5
	M14	10.5	31	29	50	34	30.5	8	0.5
	P(=1/4)	11	31	29	50	34	30.5	9	0.5
	M16	12.5	31	29	50	34	30.5	10	0.5
	M18	14	31	29	50	34	30.5	11	0.5
	M20	15	31	29	50	34	30.5	12	0.5
	M22	17	31	29	50	34	30.5	13	0.5
	P1/2	18	31	29	50	34	30.5	14	0.5
	M24	19	31	29	50	34	30.5	15	0.5
	TCA3 -	M16	12.5	48	46	72	45	41	10
M18		14	48	46	72	45	41	11	1.4
M20		15	48	46	72	45	41	12	1.4
M22		17	48	46	72	45	41	13	1.4
M24		19	48	46	72	45	41	15	1.4
M27		20	48	46	72	45	41	15	1.4
M30		23	48	46	72	45	41	17	1.4
M33		25	48	46	72	45	41	19	1.4
M36	28	48	46	72	45	41	21	1.4	


• Through coolant system not available



# BT-SLA






(mm)

Designation	ØD	ØD <sub>1</sub>	L	H	H <sub>1</sub>	H <sub>2</sub>	M	G		
<b>BT30 -</b>	<b>SLA16-90</b>	16	40	90	72	25	20	M10	M12	0.9
	<b>SLA20-90</b>	20	50	90	72	25	20	M12	M12	1.2
	<b>SLA25-90</b>	25	50	90	72	25	20	M12	M12	1.1
<b>BT40 -</b>	<b>SLA16-90</b>	16	40	90	72	25	20	M10	M12	1.4
	<b>SLA20-90</b>	20	50	90	72	25	20	M12	M12	1.8
	<b>SLA25-90</b>	25	50	90	72	25	20	M12	M12	1.6
	<b>SLA32-90</b>	32	60	90	82	25	25	M14	M12	1.8
	<b>SLA32-105</b>	32	60	105	82	25	25	M14	M12	2.0
	<b>SLA40-105</b>	40	80	105	82	25	25	M16	M12	2.9
<b>BT50 -</b>	<b>SLA20-105</b>	20	50	105	72	25	20	M12	M12	4.4
	<b>SLA25-105</b>	25	50	105	72	25	20	M12	M12	4.3
	<b>SLA32-105</b>	32	60	105	82	25	25	M14	M12	4.5
	<b>SLA40-105</b>	40	90	105	82	25	20	M16	M12	6.1
	<b>SLA42-105</b>	42	90	105	80	25	25	M16	M12	5.9

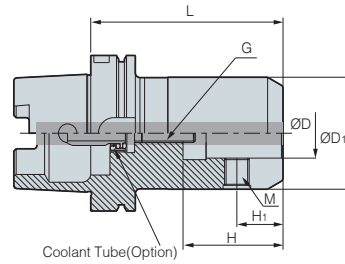
• H: Insertion depth of tool • Through coolant system installed

## Parts

Division	Basic		Adjust screw	For separate purchase		
	Set screw			Wrench		
Parts						
	Designation	BT type		HSK type	BT type	HSK type
	<b>SLA16</b>	BTF1010	BTF1414-1.5	M1230C	LW-5	LW-6
	<b>SLA20</b>	BTF1212-1.5	BTF1616-1.5		LW-6	LW-8
	<b>SLA25</b>	BTF1212-1.5	BTF1818-1.5		LW-6	LW-8
	<b>SLA32</b>	BTF1414-1.5	BTF2020-1.5		LW-6	LW-10
	<b>SLA40</b>	BTF1624-1.5	BTF2020-1.5		LW-8	LW-10
	<b>SLA42</b>	BTF1624-1.5	BTF2020-1.5		LW-8	LW-10



# HSK-SLA



(mm)

Designation		ØD	ØD <sub>1</sub>	L	H	H <sub>1</sub>	M	G	kg
HSK63A -	SLA20-100	20	52	100	51	25	M8	M12	1.6
	SLA25-105	25	65	105	59	25	M8	M12	2.1
	SLA32-105	32	72	105	63	30	M5	M12	2.3
HSK100A -	SLA20-105	20	52	105	51	25	M16	M12	3.1
	SLA25-110	25	65	110	59	25	M18	M12	3.8
	SLA32-125	32	72	125	63	30	M20	M12	4.4

• H: Insertion depth of tool • Through coolant system is optional

## Parts

Basic			For separate purchase		
Division	Set screw		Adjust screw	Wrench	
Parts					
	Designation	BT type		HSK type	BT type
SLA20	BTF1212-1.5	BTF1616-1.5	M1230C	LW-6	LW-8
SLA25	BTF1212-1.5	BTF1818-1.5		LW-6	LW-8
SLA32	BTF1414-1.5	BTF2020-1.5		LW-6	LW-10

Division	For separate purchase
Internal coolant system	

Classification by shank	
HSK50	HSK50A-CNS
HSK63	HSK63A-CNS
HSK100	HSK100A-CNS





# BT-FMA

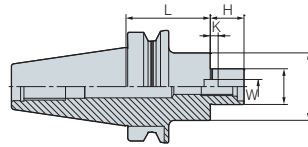


Fig. 1

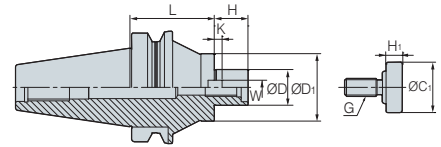


Fig. 2

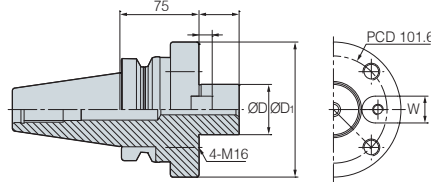


Fig. 3

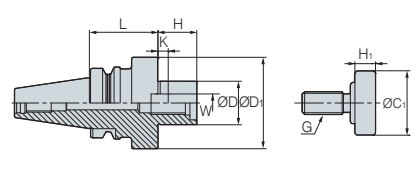








Fig. 4

(mm)

Designation	Cutter dia.	ØD	ØD <sub>1</sub>	L	H	W	K	G		Fig.
<b>BT30 -</b> FMA25.4-45	80	25.4	50	45	22	9.5	5	M12	1.0	4
<b>BT40 -</b> FMA25.4-45	80	25.4	50	45	22	9.5	5	M12	1.4	1
FMA25.4-90	80	25.4	50	90	22	9.5	5	M12	2.2	1
FMA31.75-45	100	31.75	60	45	30	12.7	7	M16	1.6	1
FMA31.75-90	100	31.75	60	90	30	12.7	7	M16	2.5	1
FMA38.1-60	125	38.1	80	60	34	15.87	9	M20	2.6	4
<b>BT50 -</b> FMA25.4-45	80	25.4	50	45	22	9.5	5	M12	4.0	1
FMA25.4-90	80	25.4	50	90	22	9.5	5	M12	4.7	1
FMA25.4-150	80	25.4	50	150	22	9.5	5	M12	6.4	2
FMA31.75-45	100	31.75	60	45	30	12.7	7	M16	4.1	1
FMA31.75-75	100	31.75	60	75	30	12.7	7	M16	4.8	1
FMA31.75-105	100	31.75	60	105	30	12.7	7	M16	5.6	2
FMA38.1-45	125	38.1	80	45	34	15.87	9	M20	4.4	1
FMA38.1-75	125	38.1	80	75	34	15.87	9	M20	5.6	1
FMA50.8-45	160	50.8	100	45	36	19.05	10	M24	4.9	1
FMA50.8-75	160	50.8	100	75	36	19.05	10	M24	6.8	1
FMA47.625-75	200	47.625	128	75	38	25.4	12.5	-	8.3	3

• H: Insertion depth of tool • Through coolant system is optional • The weight above exclude the face cutter

## Parts

Division	Basic				For separate purchase
	Key	Key bolt	Mount bolt	Clamp bolt	Wrench
<b>Parts</b>					
<b>Designation</b>					
FMA25.4	K9.5	BX0412	MBA-M12	BX1230	LW-10
FMA31.75	K12.7	BX0515	MBA-M16	-	LW-14
FMA38.1	K15.87	BX0616	MBA-M20	-	LW-17
FMA50.8	K19.05	BX0820	MBA-M24	-	-
FMA47.625	K25.4	BX1020	-	BX1645	-



# BT-FMC

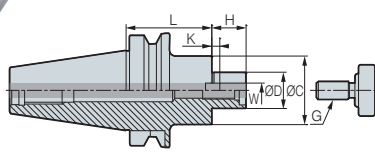


Fig. 1

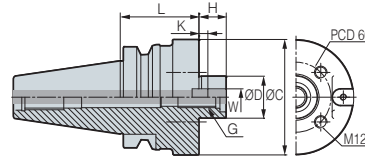


Fig. 2

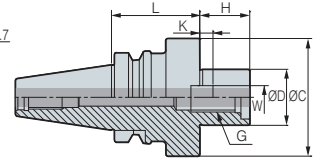








Fig. 3

(mm)

Designation	Cutter dia.	ØD	ØD <sub>1</sub>	L	H	W	K	G		Fig.	
<b>BT30 -</b>	<b>FMC16-45</b>	40	16	38	45	17	8	5.0	M8	0.7	1
	<b>FMC22-45</b>	50/63	22	48	45	19	10	5.6	M10	0.8	2
	<b>FMC27-50</b>	80	27	60	50	21	12	6.3	M12	1.2	2
<b>BT40 -</b>	<b>FMC16-60</b>	40	16	38	60	17	8	5.0	M8	1.2	1
	<b>FMC22-45</b>	50/63	22	48	45	19	10	5.6	M10	1.2	1
	<b>FMC22-90</b>	50/63	22	48	90	19	10	5.6	M10	1.2	1
	<b>FMC27-60</b>	80	27	60	60	21	12	6.3	M12	1.8	1
	<b>FMC27-90</b>	80	27	60	90	21	12	6.3	M12	3.2	1
	<b>FMC32-60</b>	100	32	78	60	24	14	7.0	M16	2.3	2
	<b>FMC40-50</b>	125/160	40	89	50	27	15.87	8.0	M20	3.3	3
	<b>BT50 -</b>	<b>FMC16-60</b>	40	16	38	60	17	8	5.0	M8	3.9
<b>FMC22-60</b>		50/63	22	48	60	19	10	5.6	M10	4.1	1
<b>FMC27-40</b>		80	27	60	40	21	12	6.3	M12	4.1	1
<b>FMC27-90</b>		80	27	60	90	21	12	6.3	M12	5.5	1
<b>FMC27-150</b>		80	27	60	150	21	12	6.3	M12	6.1	1
<b>FMC32-45</b>		100	32	78	45	24	14	7.0	M16	4.2	1
<b>FMC32-75</b>		100	32	78	75	24	14	7.0	M16	4.2	1
<b>FMC32-105</b>		100	32	78	105	24	14	7.0	M16	4.2	1
<b>FMC40-50</b>		125/160	40	89	50	27	15.87	8.0	M20	4.6	2

• H: Insertion depth of tool • Through coolant system is optional • The weight above exclude the face cutter

## Parts

Division	Basic				For separate purchase
	Key	Mount bolt	Key bolt	Clamp bolt	Wrench
<b>Parts</b>					
<b>Designation</b>					
<b>FMC16</b>	K8.0	-	BX0310	BX0830	LW-6
<b>FMC22</b>	K10.0	-	BX0412	BX1030	LW-8
<b>FMC27</b>	K12.0	MBA-M12	BX0616	BX1230	LW-10
<b>FMC32</b>	K14.0	MBA-M16	BX0616	-	LW-14
<b>FMC40</b>	K15.87	MBA-M20	BX0616	BX1030	LW-17



# HSK-FMC

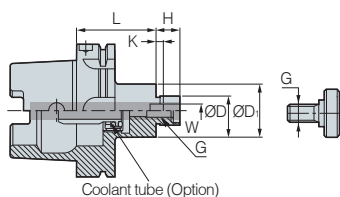


Fig. 1

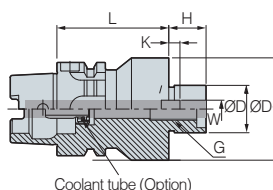


Fig. 2

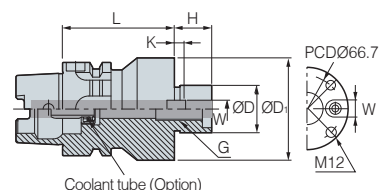


Fig. 3

(mm)

Designation	Cutter dia.	ØD	ØD <sub>1</sub>	L	H	W	K	G	kg	Fig.	
HSK50A -	FMC16-40	40	16	38	40	17	8	5	M8	0.4	1
	FMC22-50	50/63	22	48	50	19	10	5.6	M10	0.8	1
HSK63A -	FMC16-50	40	16	38	50	17	8	5.0	M8	0.9	1
	FMC22-50	50/63	22	48	50	19	10	5.6	M10	1.1	1
	FMC27-60	80	27	60	60	21	12	6.3	M12	1.4	1
	FMC32-60	100	32	78	60	24	14	7.0	M16	1.7	2
	FMC40-60	125/160	40	89	60	27	15.87	8.0	M20	2.5	3

• H: Insertion depth of tool • Through coolant system is optional • The weight above exclude the face cutter

## Parts

Division	Basic				For separate purchase
	Key	Mount bolt	Key bolt	Clamp bolt	Wrench
Parts					
Designation					
FMC16	K8.0	-	BX0310	BX0830	LW-6
FMC22	K10.0	-	BX0412	BX1030	LW-8
FMC27	K12.0	MBA-M12	BX0516	BX1230	LW-10
FMC32	K14.0	MBA-M16	BX0616	-	LW-14
FMC40	K15.87	MBA-M20	BX0616	BX1230	LW-17

# BT-MD

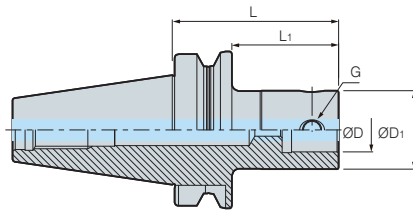


Fig. 1

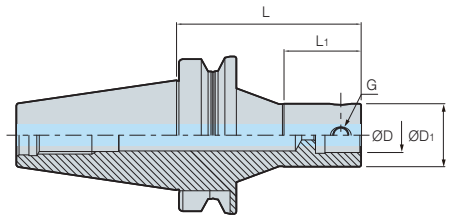



Fig. 2

(mm)

Designation	ØD	ØD <sub>1</sub>	L	L <sub>1</sub>	G		Fig.	
<b>BT30 -</b>	MD19F-70	11	19	70	45	M5	0.5	1
	MD25F-90	14	25	90	63	M6	0.6	1
	MD32F-80	18	32	80	55	M8	0.7	1
	MD40F-45	22	40	45	22	M10	0.5	1
	MD40F-60	22	40	60	36	M10	0.7	1
	MD40F-80	22	40	80	56	M10	0.9	1
	MD50F-70	28	50	70	48	M12	0.9	1
<b>BT40 -</b>	MD19F-70	11	19	70	40	M5	1.0	1
	MD25F-95	14	25	95	63	M6	1.1	1
	MD25F-105R	14	25	105	40	M6	1.2	2
	MD32F-100	18	32	100	70	M8	1.2	1
	MD32F-115R	18	32	115	45	M8	1.5	2
	MD40F-60	22	40	60	31	M10	1.1	1
	MD40F-110R	22	40	110	60	M10	1.6	2
	MD40F-115	22	40	115	83	M10	1.6	1
	MD50F-105	28	50	105	73	M12	1.8	1
	MD63F-64	36	63	64	37	M16	1.5	1
	MD63F-110	36	63	110	83	M16	2.4	1
	MD63F-135	36	63	135	108	M16	3.0	1
	MD80F-100	45	80	100	73	M16	2.9	1
<b>BT50 -</b>	MD19F-85	11	19	85	44	M5	3.7	1
	MD25F-105	14	25	105	62	M6	3.8	1
	MD25F-120R	14	25	120	40	M6	3.8	2
	MD32F-110	18	32	110	67	M8	4.0	1
	MD32F-115R	18	32	115	45	M8	4.1	2
	MD32F-235R	18	32	235	115	M8	5.5	2
	MD40F-60	22	40	60	22	M10	3.7	1
	MD40F-195	22	40	195	152	M10	4.8	1
	MD40F-230R	22	40	230	180	M10	5.0	2
	MD50F-125	28	50	125	82	M12	4.6	1
	MD50F-225	28	50	225	182	M12	6.0	1
	MD50F-250R	28	50	250	81	M12	7.0	2
	MD63F-75	36	63	75	35	M16	4.2	1
	MD63F-130	36	63	130	87	M16	5.3	1
	MD63F-195	36	63	195	152	M16	6.8	1
	MD63F-230	36	63	230	187	M16	7.5	1
	MD80F-75	45	80	75	36	M16	4.3	1
	MD80F-110	45	80	110	69	M16	5.7	1
	MD80F-175	45	80	175	134	M16	8.0	1
	MD90F-75	45	90	75	34	M16	4.8	1
MD90F-145	45	90	145	104	M16	7.4	1	
MD90F-195	45	90	195	154	M16	9.4	1	

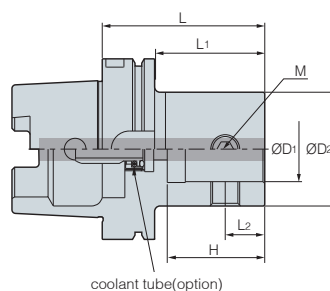
 Spare Part G53

• Through coolant system installed




# HSK-MD

Modular Arbor






(mm)

Designation	ØD <sub>1</sub>	ØD <sub>2</sub>	L	L <sub>1</sub>	H	M		
HSK 63A -	MD19F-60	11	19	60	31	15.5	M5	0.7
	MD25F-60	14	25	60	31	18.5	M6	0.7
	MD32F-65	18	32	65	36	23.5	M8	0.8
	MD40F-70	22	40	70	41	29	M10	0.9
	MD50F-85	28	50	85	58	36	M12	1.3
	MD63F-95	36	63	95	69	46	M16	1.7

• Through coolant system is optional

## Parts

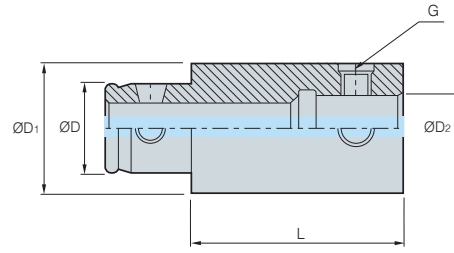
Basic		For separate purchase
Division	Taper screw	Wrench
Parts		
Designation		
MD19F	BTT0506F	LW-2.5
MD25F	BTT0608F	LW-3
MD32F	BTT0810F	LW-4
MD40F	BTT1013F	LW-5
MD50F	BTT1215F	LW-6
MD63F	BTT1620F	LW-8
MD80F	BTT1626F	LW-8
MD90F	BTT1631F	LW-8

Division	For separate purchase
Internal coolant system	

Classification by shank	
HSK50	HSK50A-CNS
HSK63	HSK63A-CNS
HSK100	HSK100A-CNS



## EXT Extension Bar

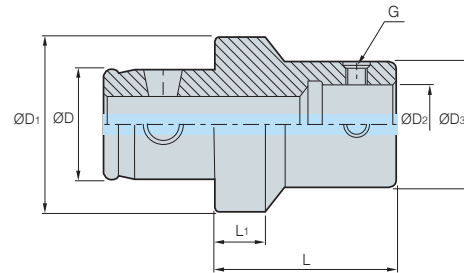


(mm)

Designation	ØD	ØD <sub>1</sub>	ØD <sub>2</sub>	L	G	kg	
EXT	1930F	11	19	11	30	M5	0.1
	1950F	11	19	11	50	M5	0.1
	2530F	14	25	14	30	M6	0.1
	2550F	14	25	14	50	M6	0.2
	3235F	18	32	18	35	M8	0.2
	3260F	18	32	18	60	M8	0.4
	4040F	22	40	22	40	M10	0.4
	4090F	22	40	22	90	M10	0.9
	5050F	28	50	28	50	M12	0.7
	50100F	28	50	28	100	M12	1.4
	6360F	36	63	36	60	M16	1.4
	63120F	36	63	36	120	M16	2.9
	8070F	45	80	45	70	M16	2.5
	80120F	45	80	45	120	M16	4.5
	9080F	45	90	45	80	M16	3.8
	90130F	45	90	45	130	M16	6.4

• Through coolant system installed

## RDC Reducer Bar



(mm)

Designation	ØD	ØD <sub>1</sub>	ØD <sub>2</sub>	ØD <sub>3</sub>	L	L <sub>1</sub>	G	kg	
RDC	3225F	18	32	14	25	30	9	M6	0.1
	4025F	22	40	14	25	30	9	M6	0.3
	4032F	22	40	18	32	30	9	M8	0.2
	5025F	28	50	14	25	30	9	M6	0.3
	5032F	28	50	18	32	40	9	M8	0.3
	5040F	28	50	22	40	40	10	M10	0.5
	6325F	36	63	14	25	30	9	M6	0.6
	6332F	36	63	18	32	40	9	M8	0.6
	6340F	36	63	22	40	40	10	M10	0.7
	6350F	36	63	28	50	45	10	M12	0.9
	8040F	45	80	22	40	40	10	M10	1.2
	8050F	45	80	28	50	45	10	M12	1.3
	8063F	45	80	36	63	50	13	M16	1.6

• Through coolant system installed



**FBH back boring & balanced type**

# FBH/B

- High speed boring and back boring capability
- High precision balancing: G2.5, Head: G6.3
- Min. adjustment range: 2 μm



**Code system**



**Back boring range calculation**



- A: Boring range (Ø)
- B: FBH/B body size (Ø)
- C: Diameter for pass (Ø)

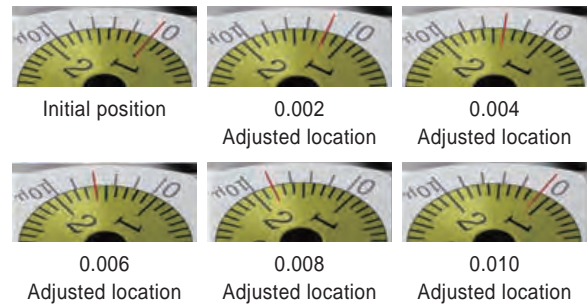
Designation	Min. diameter for pass (Ø)
<b>FBH1920B</b>	≥ Ø24
<b>FBH2526B</b>	≥ Ø30.5
<b>FBH3233B</b>	≥ Ø35
<b>FBH4042B</b>	≥ Ø44
<b>FBH5053B</b>	≥ Ø54
<b>FBH6368B</b>	≥ Ø71.5
<b>FBH6398B</b>	≥ Ø100
<b>FBH8098B</b>	≥ Ø100

<b>A</b>	Max. range of back boring (Ø)	A Max. value = (2 x C) - B
<b>B</b>	B Max. FBH body size (Ø)	B Max. value = (2 x C) - A
<b>C</b>	C Min. diameter for pass (Ø)	C Min. value = (A + B) / 2

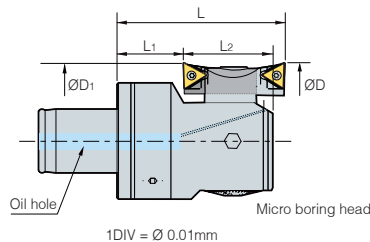
**Boring range adjustment method**

**Fine adjustment: 2 μm Boring range**

Can be adjusted at a rate of 2 μm by using the main scale and vernier scale



**Boring range**



Designation	Boring range ØD			Backboring Range (Ø)			
	Min	Max	L	Min	Max	L <sub>1</sub>	L <sub>2</sub>
<b>FBH1920B</b>	20	26 (30)	35.3	29	30	13.1	18.6
<b>FBH2526B</b>	26	34 (40)	40.9	36	40	15.1	21.9
<b>FBH3233B</b>	33	43 (50)	40.9	38	46 (50)	13.1	24.9
<b>FBH4042B</b>	42	54 (62)	50.4	48	54 (62)	15.2	31.4
<b>FBH5053B</b>	53	70 (82)	58.4	58	70 (82)	15.7	38.4
<b>FBH6368B</b>	68	100 (122)	80.6	78	100 (122)	27.4	48.6
<b>FBH6398B</b>	98	150 (172)	100.6	106	150 (172)	47.4	48.6
<b>FBH8098B</b>	98	150 (172)	100.6	106	150 (172)	47.4	48.6





# BT-FBH/B

Micro Boring Balance type

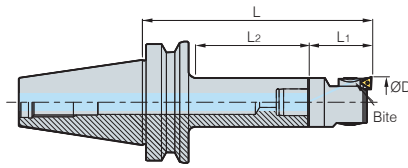
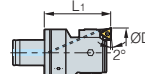


Fig. 1



Head

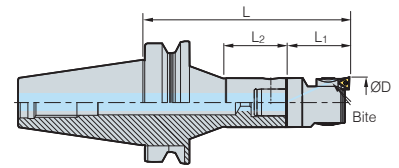



Fig. 2

(mm)

Head	Designation		Boring range ØD		ØD	ØD <sub>1</sub>	L	L <sub>1</sub>	L <sub>2</sub>		Fig.
	Bite	Arbor	Min	Max							
FBH1920B	FBB20N-□-□□	BT30-MD19F-70	20 (24)	26 (30)	19	11	105.2	35.2	45	0.2	1
FBH2526B	FBB26N-□-□□	BT30-MD25F-90	26 (32)	34 (40)	25	14	131	41	63	0.2	1
FBH3233B	FBB33N-□-□□	BT30-MD32F-80	33 (40)	43 (50)	32	18	121	41	55	0.3	1
FBH4042B	FBB42N-□-□□	BT30-MD40F-45	42 (50)	54 (62)	40	22	95.5	50.5	22	0.5	1
FBH4042B	FBB42N-□-□□	BT30-MD40F-60	42 (50)	54 (62)	40	22	110.5	50.5	36	0.5	1
FBH4042B	FBB42N-□-□□	BT30-MD40F-80	42 (50)	54 (62)	40	22	130.5	50.5	56	0.5	1
FBH5053B	FBB53N-□-□□	BT30-MD50F-70	53 (65)	70 (82)	50	28	128.4	58.5	48	0.8	1
FBH1920B	FBB20N-□-□□	BT40-MD19F-70	20 (24)	26 (30)	19	11	105.4	35.2	40	0.2	1
FBH2526B	FBB26N-□-□□	BT40-MD25F-95	26 (32)	34 (40)	25	14	135.9	41	63	0.2	1
FBH2526B	FBB26N-□-□□	BT40-MD25F-105R	26 (32)	34 (40)	25	14	146	41	40	0.2	2
FBH3233B	FBB33N-□-□□	BT40-MD32F-100	33 (40)	43 (50)	32	18	140.9	41	70	0.3	1
FBH3233B	FBB33N-□-□□	BT40-MD32F-115R	33 (40)	43 (50)	32	18	156	41	45	0.3	2
FBH4042B	FBB42N-□-□□	BT40-MD40F-60	42 (50)	54 (62)	40	22	165.5	50.5	31	0.5	1
FBH4042B	FBB42N-□-□□	BT40-MD40F-110R	42 (50)	54 (62)	40	22	160.5	50.5	60	0.5	2
FBH4042B	FBB42N-□-□□	BT40-MD40F-15	42 (50)	54 (62)	40	22	165.5	50.5	83	0.5	1
FBH5053B	FBB53N-□-□□	BT40-MD50F-105	53 (65)	70 (82)	50	28	163.4	58.5	73	0.8	1
FBH5053B	FBB53N-□-□□	BT40-MD63F-64	53 (65)	70 (82)	50	28	122.5	58.5	37	0.8	1
FBH6368B	FBB68N-□-□□	BT40-MD63F-110	68 (90)	100 (122)	63	36	190.6	80.6	83	2.1	1
FBH6398B	FBB68N-□-□□	BT40-MD63F-135	98 (120)	150 (172)	63	36	235.6	100.6	108	3.6	1
FBH8098B	FBB68N-□-□□	BT40-MD80F-100	98 (120)	150 (172)	80	45	200.6	100.6	73	4.8	1

➔ Spare Part G59 ➔ FBB Bite G61

• Head: Basic, Bite/Arbor: For separate purchase • Through coolant system installed

\* FBB bites are divided into two sorts Normal type: FBB□□N, Scalable type: FBB□□N-1  
There are also the other options for your insert type: FBB□□N-□-C09 or T11

Bite	Applicable insert
FBB□□N, FBB□□N-1	TPGT, TPGW0802□□L
FBB□□N-□-C	CCMT, CCGT0602□□L
FBB□□N-□-C09	CCMT, CCGT09T3□□L
FBB□□N-□-T11	TPGT1103□□L



# BT-FBH/B

Micro Boring Balance type

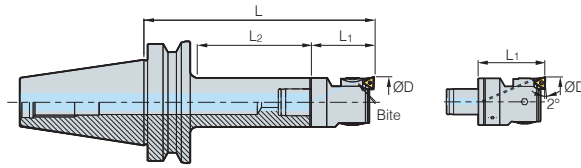
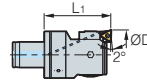


Fig. 1



Head

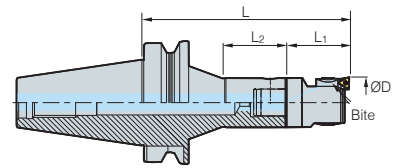




Fig. 2

(mm)

Head	Designation		Boring range ØD		ØD	ØD <sub>1</sub>	L	L <sub>1</sub>	L <sub>2</sub>	 kg	Fig.
	Bite	Arbor	Min	Max							
FBH1920B	FBB20N-□-□□	BT50-MD19F-85	20 (24)	26 (30)	19	11	120.2	35.2	44	0.2	1
FBH2526B	FBB26N-□-□□	BT50-MD25F-105	26 (32)	34 (40)	25	14	146	41	62	0.2	1
FBH2526B	FBB26N-□-□□	BT50-MD25F-120R	26 (32)	34 (40)	25	14	161	41	40	0.2	2
FBH3233B	FBB33N-□-□□	BT50-MD32F-110	33 (40)	43 (50)	32	18	151	41	67	0.3	1
FBH3233B	FBB33N-□-□□	BT50-MD32F-115R	33 (40)	43 (50)	32	18	156	41	45	0.3	2
FBH3233B	FBB33N-□-□□	BT50-MD32F-235R	33 (40)	43 (50)	32	18	276	41	115	0.3	2
FBH4042B	FBB42N-□-□□	BT50-MD40F-60	42 (50)	54 (62)	32	18	110.5	50.5	22	0.5	1
FBH4042B	FBB42N-□-□□	BT50-MD40F-195	42 (50)	54 (62)	40	22	245.5	50.5	152	0.5	1
FBH4042B	FBB42N-□-□□	BT50-MD40F-230R	42 (50)	54 (62)	40	22	280.5	50.5	180	0.5	2
FBH5053B	FBB53N-□-□□	BT50-MD50F-125	53 (65)	70 (82)	40	22	183.5	58.5	82	0.8	1
FBH5053B	FBB53N-□-□□	BT50-MD50F-225	53 (65)	70 (82)	50	28	283.5	58.5	182	0.8	1
FBH5053B	FBB53N-□-□□	BT50-MD50F-205R	53 (65)	70 (82)	50	28	263.5	58.5	81	0.8	2
FBH6368B	FBB68N-□-□□	BT50-MD63F-75	68 (90)	100 (122)	63	36	145.6	80.6	35	2.1	1
FBH6368B	FBB68N-□-□□	BT50-MD63F-130	68 (90)	100 (122)	63	36	210.6	80.6	87	2.1	1
FBH6368B	FBB68N-□-□□	BT50-MD63F-195	68 (90)	100 (122)	63	36	275.6	80.6	152	2.1	1
FBH6368B	FBB68N-□-□□	BT50-MD63F-230	68 (90)	100 (122)	63	36	310.6	80.6	187	2.1	1
FBH6398B	FBB68N-□-□□	BT50-MD63F-75	98 (120)	150 (172)	63	36	175.6	100.6	35	3.6	1
FBH6398B	FBB68N-□-□□	BT50-MD63F-130	98 (120)	150 (172)	63	36	230.6	100.6	87	3.6	1
FBH6398B	FBB68N-□-□□	BT50-MD63F-95	98 (120)	150 (172)	63	36	295.6	100.6	152	3.6	1
FBH6398B	FBB68N-□-□□	BT50-MD63F-230	98 (120)	150 (172)	63	36	330.6	100.6	187	3.6	1
FBH8098B	FBB68N-□-□□	BT50-MD80F-75	98 (120)	150 (172)	80	45	175.6	100.6	36	4.8	1
FBH8098B	FBB68N-□-□□	BT50-MD80F-110	98 (120)	150 (172)	80	45	215.6	100.6	69	4.8	1
FBH8098B	FBB68N-□-□□	BT50-MD80F-175	98 (120)	150 (172)	80	45	275.6	100.6	134	4.8	1

 Spare Part **G59**  FBB Bite **G61**

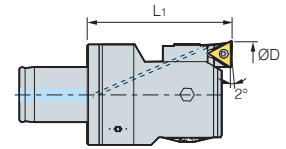
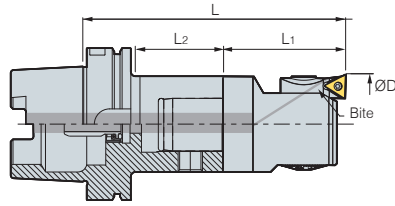
• Head: Basic, Bite/Arbor: For separate purchase • Through coolant system installed

\* FBB bites are divided into two sorts Normal type: FBB□□N, Scalable type: FBB□□N-1  
There are also the other options for your insert type: FBB□□N-□-C09 or T11

Bite	Applicable insert
FBB□□N, FBB□□N-1	TPGT, TPGW0802□□L
FBB□□N-□-C	CCMT, CCGT0602□□L
FBB□□N-□-C09	CCMT, CCGT09T3□□L
FBB□□N-□-T11	TPGT1103□□L

# HSK-FBH/B

Micro Boring Balance type



(mm)

Designation			Boring range ØD		ØD	ØD <sub>1</sub>	L	L <sub>1</sub>	L <sub>2</sub>	
Head	Bite	Arbor	Min	Max						
FBH1920B	FBB20N-□-□□	HSK63A-MD19F 60	20 (24)	26 (30)	19	11	95.2	35.2	31	0.2
FBH2526B	FBB26N-□-□□	HSK63A-MD25F 60	26 (32)	34 (40)	25	14	101	41	31	0.2
FBH3233B	FBB33N-□-□□	HSK63A-MD32F 65	33 (40)	43 (50)	32	18	106	41	36	0.3
FBH4042B	FBB42N-□-□□	HSK63A-MD40F 70	42 (50)	54 (62)	40	22	120.5	50.5	41	0.5
FBH5053B	FBB53N-□-□□	HSK63A-MD50F 85	53 (65)	70 (82)	50	28	143.5	58.5	58	0.9
FBH6368B	FBB68N-□-□□	HSK63A-MD63F 95	68 (90)	100 (122)	63	36	175.6	80.6	69	2.3
FBH6398B	FBB68N-□-□□	HSK63A-MD63F 95	98 (120)	150 (172)	63	36	195.6	100.6	69	3.8

➔ Spare Part G59 ➔ FBB Bite G61

• Head: Basic, Bite/Arbor: For separate purchase • Through coolant system is optional

\* FBB bites are divided into two sorts Normal type: FBB□□N, Scalable type: FBB□□N-1  
There are also the other options for your insert type: FBB□□N-□-C09 or T11

Bite	Applicable insert
FBB□□N, FBB□□N-1	TPGT, TPGW0802□□L
FBB□□N-□-C	CCMT, CCGT0602□□L
FBB□□N-□-C09	CCMT, CCGT09T3□□L
FBB□□N-□-T11	TPGT1103□□L

## ➔ Parts

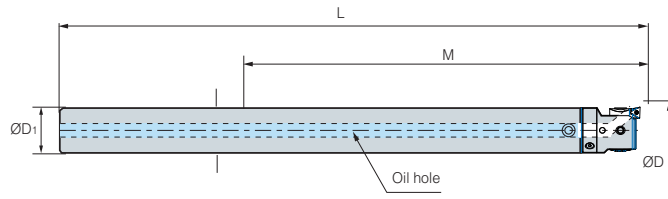
Division	For separate purchase
Internal coolant system	

Classification by shank	
HSK50	HSK50A-CNS
HSK63	HSK63A-CNS
HSK100	HSK100A-CNS



# S-FBH/B

Micro Boring Balance type



Designation	Boring range ØD		ØD <sub>1</sub>	L	M	Main component			kg
	Min	Max				Basic shank	Boring head	Bite	
S19W-FBH20B-120	20	26	19	192.35	120	S19W-MD19F-157	FBH1920B	FBB20N	0.6
S19W-FBH20B-140	20	26	19	212.35	140	S19W-MD19F-177	FBH1920B	FBB20N	0.7
S19W-FBH20B-160	20	26	19	232.35	160	S19W-MD19F-197	FBH1920B	FBB20N	0.8
S25W-FBH26B-150	26	34	25	238.35	150	S25W-MD25F-197.5	FBH2526B	FBB26N	1.4
S25W-FBH26B-175	26	34	25	263.35	175	S25W-MD25F-222.5	FBH2526B	FBB26N	1.6
S25W-FBH26B-200	26	34	25	288.35	200	S25W-MD25F-247.5	FBH2526B	FBB26N	1.8
S32W-FBH33B-180	33	43	32	279.9	180	S32W-MD32F-239	FBH3233B	FBB33N	2.7
S32W-FBH33B-240	33	43	32	339.9	240	S32W-MD32F-299	FBH3233B	FBB33N	3.4
S19-FBH20B-40	20	26	19	112.35	40	S19-MD19F-77	FBH1920B	FBB20N	0.2
S19-FBH20B-80	20	26	19	152.35	80	S19-MD19F-117	FBH1920B	FBB20N	0.2
S25-FBH26B-50	26	34	25	138.35	50	S25-MD25F-97.5	FBH2526B	FBB26N	0.4
S25-FBH26B-100	26	34	25	188.35	100	S25-MD25F-147.5	FBH2526B	FBB26N	0.6
S32-FBH33B-90	33	43	32	189.9	90	S32-MD32F-149	FBH3233B	FBB33N	1.1
S32-FBH33B-120	33	43	32	219.9	120	S32-MD32F-179	FBH3233B	FBB33N	1.2

➔ Spare Part **G59** ➔ FBB Bite **G61**

• S□□W: Cemented carbide shank, S□□: steel shank • Through coolant system installed

\* FBB bites are divided into two sorts Normal type: FBB□□N, Scalable type: FBB□□N-1  
There are also the other options for your insert type: FBB□□N-□-C09 or T11

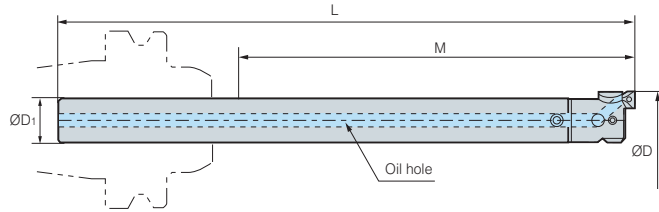
Bite	Applicable insert
FBB□□N, FBB□□N-1	TPGT, TPGW0802□□L
FBB□□N-□-C	CCMT, CCGT0602□□L
FBB□□N-□-C09	CCMT, CCGT09T3□□L
FBB□□N-□-T11	TPGT1103□□L

## Parts

Basic			
Type(FBH/B)	Lock screw	Clamp screw	Wrench
FBH1920B	BTF0404	BXC0304	LW-2
FBH2526B	BTF0505	BXC0405	LW-2.5
FBH3233B	BTF0606	BXC0506	LW-3
FBH4042B	BTF0808	BXC0610	LW-4
FBH5053B	BTF0812	BXC0610	LW-4
FBH6368B	BTF1016	BXC0810	LW-5
FBH6398B	BTF1012	BXC0810	LW-5
FBH8098B	BTF1014	BXC0810	LW-5



# S-FBH



(mm)

Designation	Boring range ØD		ØD <sub>1</sub>	L	M	Designation			kg
	Min	Max				Basic shank	Boring head	Bite	
S14W-FBH15-85	15	18	14	155	85	S14W-M6-123	FBH15	FBB15-C	0.3
S14W-FBH15-110	15	18	14	180	110	S14W-M6-148	FBH15	FBB15-C	0.3
S16W-FBH18-95	18	22	16	165	95	S16W-M8-128	FBH18	FBB15-C	0.4
S16W-FBH18-125	18	22	16	195	125	S16W-M8-158	FBH18	FBB15-C	0.5
S14-FBH15-40	15	18	14	110	40	S14-M6-78	FBH15	FBB15-C	0.1
S16-FBH18-45	18	22	16	115	45	S16-M8-78	FBH18	FBB15-C	0.1

↻ Spare Part **G59, G60** ↻ FBB Bite **G61**

• S□□W: Cemented carbide shank, S□□: steel shank • Through coolant system installed

\* FBB bites are divided into two sorts Normal type: FBB□□N, Scalable type: FBB□□N-1  
There are also the other options for your insert type: FBB□□N-□-C09 or T11

Bite	Applicable insert
FBB□□N, FBB□□N-1	TPGT, TPGW0802□□L
FBB□□N-□-C	CCMT, CCGT0602□□L
FBB□□N-□-C09	CCMT, CCGT09T3□□L
FBB□□N-□-T11	TPGT1103□□L

## ↻ Parts

Basic			
Type(FBH)	Lock screw	FBB	Clamp screw
FBH15	BT02503	FBB15-C	BFTX02505N
FBH18	BT02503	FBB15-C	BFTX02505N



# FBB Bite

Designation	Boring range	Insert	Insert screw	Clamp bolt
<b>FBB15-C</b>	Ø15~Ø18 mm	CCET0301-□□L	BFTX01604N	BFTX02505N
	Ø18~Ø22 mm	CCET0301-□□L	BFTX01604N	BFTX02505N
<b>FBB20N</b>	Ø20~Ø26 mm	TPGT0802□□L,TPGW0802□□	BFTX0204A	BXC0304
<b>FBB20N-C</b>	Ø20~Ø26 mm	CCET0401□□L	FTNA0238	BXC0304
<b>FBB20N-1</b>	Ø24~Ø30 mm	TPGT0802□□L,TPGW0802□□	BFTX0204A	BXC0304
<b>FBB20N-1-C</b>	Ø24~Ø30 mm	CCET0401□□L	FTNA0238	BXC0304
<b>FBB26N</b>	Ø26~Ø34 mm	TPGT0802□□L,TPGW0802□□	BFTX0204A	BXC0405
<b>FBB26N-C</b>	Ø26~Ø34 mm	CCET0401□□L	FTNA0238	BXC0405
<b>FBB26N-1</b>	Ø32~Ø40 mm	TPGT0802□□L,TPGW0802□□	BFTX0204A	BXC0405
<b>FBB26N-1-C</b>	Ø32~Ø40 mm	CCET0401□□L	FTNA0238	BXC0405
<b>FBB33N</b>	Ø33~Ø43 mm	TPGT0802□□L,TPGW0802□□	BFTX0204A	BXC0506
<b>FBB33N-C</b>	Ø33~Ø43 mm	CCMT0602□□,CCGT0602□□	BFTX02506N	BXC0506
<b>FBB33N-1</b>	Ø41~Ø50 mm	TPGT0802□□L,TPGW0802□□	BFTX0204A	BXC0506
<b>FBB33N-1-C</b>	Ø41~Ø50 mm	CCMT0602□□,CCGT0602□□L	BFTX02506N	BXC0506
<b>FBB42N</b>	Ø42~Ø54 mm	TPGT0802□□L,TPGW0802□□	BFTX0204A	BXC0610
<b>FBB42N-C</b>	Ø42~Ø54 mm	CCMT0602□□CCGT0602□□L	BFTX02506N	BXC0610
<b>FBB42N-11</b>	Ø42~Ø54 mm	TPGT1103□□L	BFTX0307A	BXC0610
<b>FBB42N-1</b>	Ø50~Ø62 mm	TPGT0802□□L,TPGW0802□□	BFTX0204A	BXC0610
<b>FBB42N-1-C</b>	Ø50~Ø62 mm	CCMT0602□□,CCGT0602□□L	BFTX02506N	BXC0610
<b>FBB42N-1-T11</b>	Ø50~Ø62 mm	TPGT1103□□L	BFTX0307A	BXC0610
<b>FBB53N</b>	Ø53~Ø70 mm	TPGT0802□□L,TPGW0802□□	BFTX0204A	BXC0610
<b>FBB53N-C</b>	Ø53~Ø70 mm	CCMT0602□□,CCGT0602□□	BFTX02506N	BXC0610
<b>FBB53N-11</b>	Ø53~Ø70 mm	TPGT1103□□L	BFTX0307A	BXC0610
<b>FBB53N-1</b>	Ø65~Ø82 mm	TPGT0802□□L,TPGW0802□□	BFTX0204A	BXC0610
<b>FBB53N-1-C</b>	Ø65~Ø82 mm	CCMT0602□□CCGT0602□□L	BFTX02506N	BXC0610
<b>FBB53N-1-C09</b>	Ø65~Ø82 mm	CCMT09T3□□,CCGT09T3□□L	BFTX0409N	BXC0610
<b>FBB53N-1-T11</b>	Ø65~Ø82 mm	TPGT1103□□L	BFTX0307A	BXC0610
<b>FBB68N</b>	Ø68~Ø100 mm/Ø98~Ø150 mm	TPGT0802□□L,TPGW0802□□	BFTX0204A	BXC0810
<b>FBB68N-C</b>	Ø68~Ø100 mm/Ø98~Ø150 mm	CCMT09T3□□,CCGT09T3□□L	BFTX0409N	BXC0810
<b>FBB68N-11</b>	Ø68~Ø100 mm/Ø98~Ø150 mm	TPGT1103□□L	BFTX0307A	BXC0810
<b>FBB68N-1</b>	Ø90~Ø122 mm/Ø120~Ø172 mm	TPGT0802□□L,TPGW0802□□	BFTX0204A	BXC0810
<b>FBB68N-1-C09</b>	Ø90~Ø122 mm/Ø120~Ø172 mm	CCMT09T3□□,CCGT09T3□□L	BFTX0409N	BXC0810
<b>FBB68N-1-T11</b>	Ø90~Ø122 mm/Ø120~Ø172 mm	TPGT1103□□L	BFTX0307A	BXC0810

**New balance cut tool**

**DBCA** *new*

- Applied adjustment function simultaneously in Bi/Uni-direction of cartridge
- Improves the rigidity of cutting by applying cover for rotating type
- Increased machining area versus conventional own products
- Improved capacity to evacuate chips by unique design of helical type Head
- Boring range: Ø28~Ø136



**Code system**



**Main features**

**Helical Type**



- Improved capacity to discharge chips from clogged and deep holes
- Minimized damage to tools and insert due to chip clogging

<b>Extended head length</b>	Deep hole machining implemented
<b>Helical Type</b>	Improved capacity to discharge chips from holes

**Boring area optimization**



- Max. diameter expanded owing to reinforced rigidity
- Boring range expanded per model no. versus conventional boring range of DINE

<b>Coolant Hole</b> (Direct spray to cutting edge)	<ul style="list-style-type: none"> <li>• Improved capacity to discharge chips</li> <li>• Improved capacity of machining</li> </ul>
---	--

**Effect of improved rigidity for cartridge by cover**

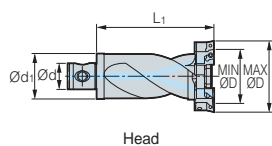
Clamps the top of the cartridge stably, minimizing the vibration of tools and improving the roughness of the working surface





# BT-DBC/A

Helical type



Head

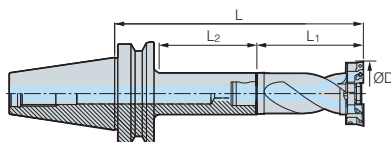


Fig. 1

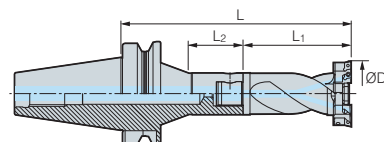


Fig. 2

(mm)

Designation		Boring range $\varnothing D$		$\varnothing d$	$\varnothing d_1$	L	L <sub>1</sub>	L <sub>2</sub>	kg	Fig.
Head	Arbor	Min	Max							
DBCA2528S-H	BT30-MD25F-90	28	38	14	25	193	103	63	0.3	1
DBCA3238S-H	BT30-MD32F-80	38	54	18	32	190	110	55	0.5	1
DBCA5054S-H	BT30-MD50F-70	54	74	28	50	215	145	48	1.8	1
DBCA2528S-H	BT40-MD25F-95	28	38	14	25	198	103	63	0.3	1
DBCA2528S-H	BT40-MD25F-105R	28	38	14	25	208	103	40	0.3	2
DBCA3238S-H	BT40-MD32F-100	38	54	18	32	210	110	70	0.5	1
DBCA3238S-H	BT40-MD32F-115R	38	54	18	32	225	110	45	0.5	2
DBCA5054S-H	BT40-MD50F-105	54	74	28	50	250	145	73	1.8	1
DBCA6374S-H	BT40-MD63F-64	74	100	36	63	244	180	37	3.3	1
DBCA6374S-H	BT40-MD63F-110	74	100	36	63	290	180	83	3.3	1
DBCA6374S-H	BT40-MD63F-135	74	100	36	63	315	180	108	3.3	1
DBCA80100S-H	BT40-MD80F-100	100	136	45	80	315	215	73	7.3	1
DBCA2528S-H	BT50-MD25F-105	28	38	14	25	208	103	62	0.3	1
DBCA2528S-H	BT50-MD25F-120R	28	38	14	25	223	103	40	0.3	2
DBCA3238S-H	BT50-MD32F-110	38	54	18	32	220	110	67	0.5	1
DBCA3238S-H	BT50-MD32F-115R	38	54	18	32	225	110	45	0.5	2
DBCA3238S-H	BT50-MD32F-235R	38	54	18	32	345	110	115	0.5	2
DBCA5054S-H	BT50-MD50F-125	54	74	28	50	270	145	82	1.8	1
DBCA5054S-H	BT50-MD50F-225	54	74	28	50	370	145	182	1.8	1
DBCA5054S-H	BT50-MD50F-250R	54	74	28	50	395	145	81	1.8	2
DBCA6374S-H	BT50-MD63F-75	74	100	36	63	255	180	35	3.3	1
DBCA6374S-H	BT50-MD63F-130	74	100	36	63	280	180	87	3.3	1
DBCA6374S-H	BT50-MD63F-195	74	100	36	63	375	180	152	3.3	1
DBCA6374S-H	BT50-MD63F-230	74	100	36	63	410	180	187	3.3	1
DBCA80100S-H	BT50-MD80F-75	100	136	45	80	290	215	36	7.3	1
DBCA80100S-H	BT50-MD80F-110	100	136	45	80	325	215	69	7.3	1
DBCA80100S-H	BT50-MD80F-175	100	136	45	80	390	215	134	7.3	1

Spare Part **G67**

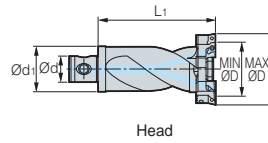
• Head: Basic, Arbor: For separate purchase • Through coolant system installed

\* In the above table, the Arbor Model No. is an example model no. and able to adjust the depth of boring with a combination of MD arbors and extension bars. For more details, see the MD arbor page.



# BT-DBC/A

Straight type



Head

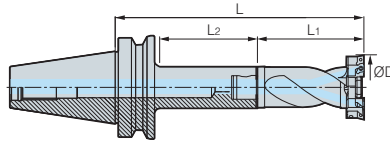


Fig. 1

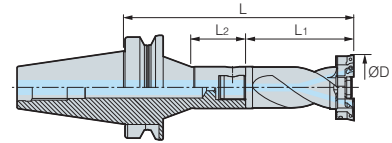


Fig. 2

(mm)

Designation		Boring range ØD		Ød	Ød <sub>1</sub>	L	L <sub>1</sub>	L <sub>2</sub>	kg	Fig.
Head	Arbor	Min	Max							
DBCA2528S	BT30-MD25F-90	28	38	14	25	193	103	63	0.2	1
DBCA3238S	BT30-MD32F-80	38	54	18	32	190	110	55	0.4	1
DBCA5054S	BT30-MD50F-70	54	74	28	50	215	145	48	1.1	1
DBCA2528S	BT40-MD25F-95	28	38	14	25	198	103	63	0.2	1
DBCA2528S	BT40-MD25F-105R	28	38	14	25	208	103	40	0.2	2
DBCA3238S	BT40-MD32F-100	38	54	18	32	210	110	70	0.4	1
DBCA3238S	BT40-MD32F-115R	38	54	18	32	225	110	45	0.4	2
DBCA5054S	BT40-MD50F-105	54	74	28	50	205	145	73	1.1	1
DBCA6374S	BT40-MD63F-64	74	100	36	63	244	180	37	1.9	1
DBCA6374S	BT40-MD63F-135	74	100	36	63	315	180	83	1.9	1
DBCA6374S	BT40-MD80F-100	74	100	36	63	280	180	108	1.9	1
DBCA80100S	BT40-MD80F-100	100	136	45	80	315	215	73	3.7	1
DBCA2528S	BT50-MD25F-105	28	38	14	25	208	103	62	0.2	1
DBCA2528S	BT50-MD25F-120R	28	38	14	25	223	103	40	0.2	2
DBCA3238S	BT50-MD32F-110	38	54	18	32	220	110	67	0.4	1
DBCA3238S	BT50-MD32F-115R	38	54	18	32	225	110	45	0.4	2
DBCA3238S	BT50-MD32F-235R	38	54	18	32	345	110	115	0.4	2
DBCA5054S	BT50-MD50F-125	54	74	28	50	270	145	82	1.1	1
DBCA5054S	BT50-MD50F-225	54	74	28	50	370	145	182	1.1	1
DBCA5054S	BT50-MD50F-250R	54	74	28	50	395	145	81	1.1	2
DBCA6374S	BT50-MD63F-75	74	100	36	63	255	180	35	1.9	1
DBCA6374S	BT50-MD63F-130	74	100	36	63	310	180	87	1.9	1
DBCA6374S	BT50-MD63F-195	74	100	36	63	375	180	152	1.9	1
DBCA6374S	BT50-MD63F-230	74	100	36	63	410	180	187	1.9	1
DBCA80100S	BT50-MD80F-75	100	136	45	80	290	215	36	3.7	1
DBCA80100S	BT50-MD80F-110	100	136	45	80	325	215	69	3.7	1
DBCA80100S	BT50-MD80F-175	100	136	45	80	390	215	134	3.7	1

Spare Part **G67**

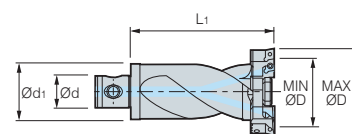
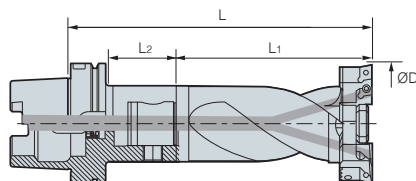
• Head: Basic, Arbor: For separate purchase • Through coolant system installed

\* In the above table, the Arbor Model No. is an example model no. and able to adjust the depth of boring with a combination of MD arbors and extension bars. For more details, see the MD arbor page.



# HSK-DBC/A

Helical type



Head

(mm)

Designation		Boring range ØD		Ød	Ød <sub>1</sub>	L	L <sub>1</sub>	L <sub>2</sub>	kg
Head	Arbor	Min	Max						
DBCA2528S-H	HSK63A-MD25F-60	38	54	14	25	163	103	31	0.3
DBCA3238S-H	HSK63A-MD32F-65	38	54	18	32	175	110	36	0.5
DBCA5054S-H	HSK63A-MD50F-85	54	74	28	50	230	145	58	1.8
DBCA6374S-H	HSK63A-MD63F-95	74	100	45	80	275	180	69	3.3

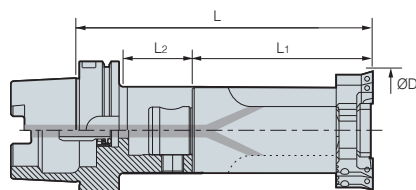
➔ Spare Part **G67**

• Head: Basic, Arbor: For separate purchase • Through coolant system is optional

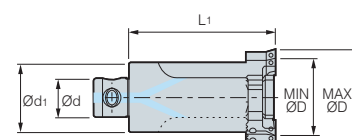
\* In the above table, the Arbor Model No. is an example model no. and able to adjust the depth of boring with a combination of MD arbors and extension bars. For more details, see the MD arbor page.

# HSK-DBC/A

Straight type



1DIV. = 0.01mm



Head

(mm)

Designation		Boring range ØD		Ød	Ød <sub>1</sub>	L	L <sub>1</sub>	L <sub>2</sub>	kg
Head	Arbor	Min	Max						
DBCA2528S	HSK63A-MD25F-60	38	54	14	25	122	62	31	0.3
DBCA3238S	HSK63A-MD32F-65	38	54	18	32	134.5	69.5	36	0.5
DBCA5054S	HSK63A-MD50F-85	54	74	28	50	179	94	58	1.8
DBCA6374S	HSK63A-MD63F-95	74	100	45	80	100	106.5	69	3.3

➔ Spare Part **G67**

• Head: Basic, Arbor: For separate purchase • Through coolant system is optional

\* In the above table, the Arbor Model No. is an example model no. and able to adjust the depth of boring with a combination of MD arbors and extension bars. For more details, see the MD arbor page.

## Parts

Designation	For separate purchase
Internal coolant system	

Classification by shank	
HSK50	HSK50A-CNS
HSK63	HSK63A-CNS
HSK100	HSK100A-CNS



# BT-DBC

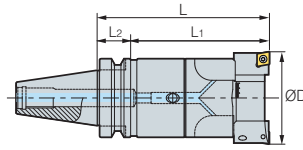


Fig. 1

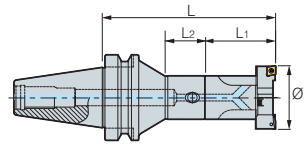
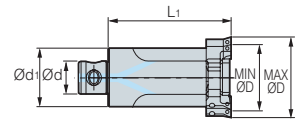


Fig. 2



Head

(mm)

Designation		Boring range ØD		Ød	Ød <sub>1</sub>	L	L <sub>1</sub>	L <sub>2</sub>	kg	Fig.
Head	Arbor	Min	Max							
DBC2528S	BT30-MD25F-90	28	35	14	25	150	60	63	0.3	1
DBC3235S	BT30-MD32F-80	35	46	18	32	145	65	55	0.4	1
DBC4046S	BT30-MD40F-45	46	58	22	40	115	70	22	0.6	1
DBC4046S	BT30-MD40F-60	46	58	22	40	130	70	36	0.6	1
DBC4046S	BT30-MD40F-80	46	58	22	40	140	70	56	0.6	1
DBC5058S	BT30-MD50F-70	58	74	28	50	150	80	48	1.1	1
DBC2528S	BT40-MD25F-95	28	35	14	25	155	60	63	0.3	1
DBC2528S	BT40-MD25F-105R	28	35	14	25	165	60	40	0.3	2
DBC3235S	BT40-MD32F-100	35	46	18	32	165	65	70	0.4	1
DBC3235S	BT40-MD32F-115R	35	46	18	32	180	65	45	0.4	2
DBC4046S	BT40-MD40F-60	46	58	22	40	130	70	31	0.6	1
DBC4046S	BT40-MD40F-110R	46	58	22	40	180	70	60	0.6	2
DBC4046S	BT40-MD40F-115	46	58	22	40	185	70	83	0.6	1
DBC5058S	BT40-MD50F-105	58	74	28	50	185	80	73	1.1	1
DBC6374S	BT40-MD63F-64	74	94	36	63	154	90	37	2.0	1
DBC6374S	BT40-MD63F-110	74	94	36	63	200	90	83	2.0	1
DBC6374S	BT40-MD63F-135	74	94	36	63	225	90	108	2.0	1
DBC8094S	BT40-MD80F-100	94	120	45	80	200	100	73	3.5	1
DBC2528S	BT50-MD25F-105	28	35	14	25	165	60	62	0.3	1
DBC2528S	BT50-MD25F-120R	28	35	14	25	185	60	40	0.3	2
DBC3235S	BT50-MD32F-110	35	46	18	32	175	65	67	0.4	1
DBC3235S	BT50-MD32F-115R	35	46	18	32	180	65	45	0.4	2
DBC3235S	BT50-MD32F-235R	35	46	18	32	300	65	115	0.4	2
DBC4046S	BT50-MD40F-60	46	58	22	40	130	70	22	0.6	1
DBC4046S	BT50-MD40F-195	46	58	22	40	265	70	152	0.6	1
DBC4046S	BT50-MD40F-230R	46	58	22	40	300	70	180	0.6	2
DBC5058S	BT50-MD50F-125	58	74	28	50	205	80	82	1.1	1
DBC5058S	BT50-MD50F-225	58	74	28	50	305	80	182	1.1	1
DBC5058S	BT50-MD50F-250R	58	74	28	50	330	80	81	1.1	2
DBC6374S	BT50-MD63F-75	74	94	36	63	165	90	35	2.0	1
DBC6374S	BT50-MD63F-130	74	94	36	63	220	90	87	2.0	1
DBC6374S	BT50-MD63F-195	74	94	36	63	285	90	152	2.0	1
DBC6374S	BT50-MD63F-230	74	94	36	80	320	90	187	2.0	1
DBC8094S	BT50-MD80F-75	94	120	36	80	175	100	36	3.5	1
DBC8094S	BT50-MD80F-110	94	120	45	80	210	100	69	3.5	1
DBC8094S	BT50-MD80F-175	94	120	45	80	275	100	134	4.5	1
DBC120S	BT50-MD80F-175	120	175	45	80	275	100	134	4.1	1

☞ Spare Part G67

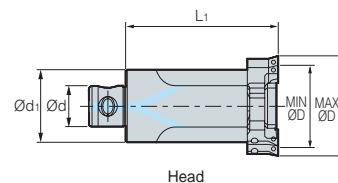
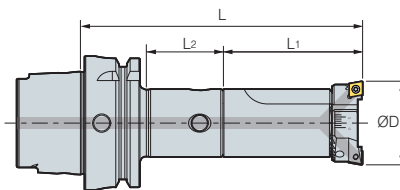
• Head: Basic, Arbor: For separate purchase • Through coolant system installed

\* In the above table, the Arbor Model No. is an example model no. and able to adjust the depth of boring with a combination of MD arbors and extension bars. For more details, see the MD arbor page.



# HSK-DBC

Modular type



(mm)

Designation		Boring range ØD		Ød	Ød <sub>1</sub>	L	L <sub>1</sub>	L <sub>2</sub>	kg
Head	Arbor	Min	Max						
DBC2528S	HSK63A-MD25F-60	28	35	14	25	120	60	31	0.3
DBC3235S	HSK63A-MD32F-65	35	46	18	32	130	65	36	0.4
DBC4046S	HSK63A-MD40F-70	46	58	22	40	140	70	41	0.6
DBC5058S	HSK63A-MD50F-85	58	74	28	50	165	80	58	1.1
DBC6374S	HSK63A-MD63F-95	74	94	36	63	185	90	69	2.0

➔ Spare Part **G67**

• Head: Basic, Arbor: For separate purchase • Through coolant system is optional

\* In the above table, the Arbor Model No. is an example model no. and able to adjust the depth of boring with a combination of MD arbors and extension bars. For more details, see the MD arbor page.

## Parts

### • DBCA

Basic									
Division	Head	Spring pin	Wrench bolt	Wrench	Cartridge	Set screw	Wrench	Clamp screw	Torx wrench
Parts Designation									
	DBCA2528S	DBCA2528	SP0308	BX0420	LW-3	BCC28-EC	BT0308	LW-1.5	BFTX02506N
DBCA3238S	DBCA3238	SP0410	BX0525	LW-4	BCC38-EC	BT0310	LW-1.5	BFTX02506M	TRX8
DBCA5054S	DBCA5054	SP0616	BX0630	LW-5	BCC54-EC	BT0414	LW-2	BFTX0407N	TRX15
DBCA6374S	DBCA6374	SP1018	BX0635	LW-5	BCC74-EC	BT0520	LW-2.5	BFTX0511N	TRX20
DBCA80100S	DBCA80100	SP1020	BX0840	LW-6	BCC100-EC	BT0625	LW-3	BFTX0511N	TRX20

### • DBC

Basic									
Division	Head	Spring pin	Wrench bolt	Wrench	Cartridge	Set screw	Wrench	Clamp screw	Torx wrench
Parts Designation									
	DBC2528S	DBC2528	SP0308	BX0415	LW-3	BCC28	BT0306	LW-1.5	FTKA02565
DBC3235S	DBC3235	SP0410	BX0515	LW-4	BCC35	BT0308			
DBC4046S	DBC4046	SP0516	BX0620	LW-5	BCC46	BT0410	LW-2	FTNA0408	TRX15
DBC5058S	DBC5058	SP0616			BCC58	BT0412			
DBC6374S	DBC6374	SP1018	BX0830	LW-6	BCC74	BT0516	LW-2.5	BFTX0511N	TRX20
DBC8094S	DBC8094	SP1020	BX1035	LW-8	BCC94	BT0620	LW-3		
DBC120S	DBC120N	SP1020	BX0830	LW-6	BCC120	BT0830	LW-4	BFTX0511N	TRX20



# BT-SMB

Small Micro Boring Bar

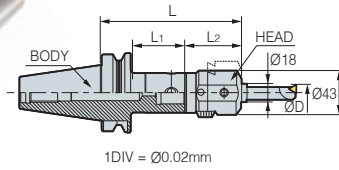


Fig. 1

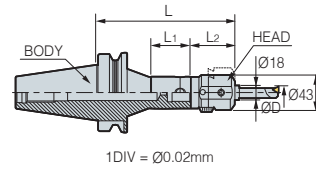
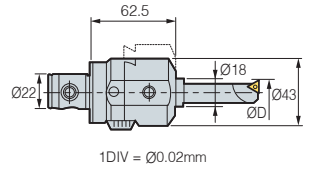


Fig. 2



Head

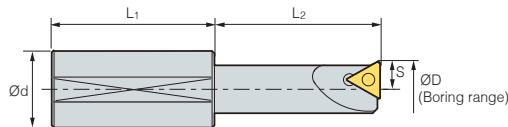
(mm)

Designation			Boring range ØD	L	L <sub>1</sub>	L <sub>2</sub>		Fig.
Head	Arbor	Bite						
SMB4022	BT30-MD40F-45	BB18-□(S)	Ø6.0~Ø34.0	107.5	22	62.5	0.6	1
SMB4022	BT30-MD40F-60	BB18-□(S)	Ø6.0~Ø34.0	122.5	36	62.5	0.6	1
SMB4022	BT30-MD40F-80	BB18-□(S)	Ø6.0~Ø34.0	142.5	56	62.5	0.6	1
SMB4022	BT40-MD40F-60	BB18-□(S)	Ø6.0~Ø34.0	122.5	31	62.5	0.6	1
SMB4022	BT40-MD40F-110R	BB18-□(S)	Ø6.0~Ø34.0	172.5	60	62.5	0.6	2
SMB4022	BT40-MD40F-115	BB18-□(S)	Ø6.0~Ø34.0	177.5	83	62.5	0.6	1
SMB4022	BT50-MD40F-60	BB18-□(S)	Ø6.0~Ø34.0	122.5	22	62.5	0.6	1
SMB4022	BT50-MD40F-195	BB18-□(S)	Ø6.0~Ø34.0	257.5	152	62.5	0.6	1
SMB4022	BT50-MD40F-230R	BB18-□(S)	Ø6.0~Ø34.0	292.5	180	62.5	0.6	2

\* Adjustment length: 7mm

• Head: Basic, Arbor/Bite: For separate purchase • Through coolant system not available

## BB Bite (For SMB)



(mm)

Designation	Boring range		Ød	L <sub>1</sub>	L <sub>2</sub>	S		Insert	Insert screw	
	Min	Max								
BB	18-7(S)	7	27	18	30	30	3.5	0.1	TBGT0601□□L	BFTX0204A
	18-9(S)	9	29	18	30	40	4.5	0.1	TPGT0802□□L	BFTX0204A
	18-11(S)	11	31	18	30	45	5.5	0.1	TPGT1103□□L	BFTX0307A
	18-13(S)	13	33	18	40	45	6.5	0.1	TPGT1103□□L	BFTX0307A
	18-15(S)	15	35	18	40	50	7.5	0.2	TPGT1103□□L	BFTX0307A
	18-17(S)	17	37	18	40	50	8.5	0.2	TPGT1103□□L	BFTX0307A

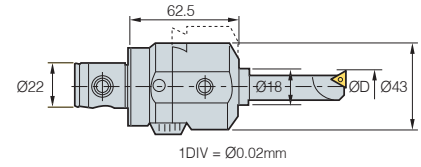
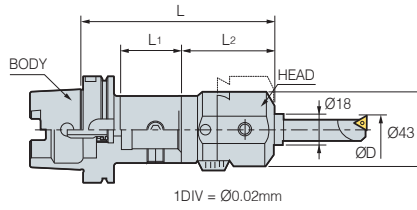
## Parts

Basic				For separate purchase	
Division	Boring head	Taper screw	Wrench	Boring bite	Basic holder
Parts					
Designation					
SMB	SMB4022	BTT1013F	LW-2.5	BB18	MD40F



# HSK-SMB

## Small Micro Boring Bar



Head

(mm)

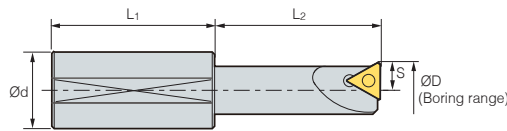
Designation			Boring range ØD	L	L <sub>1</sub>	L <sub>2</sub>	
Head	Arbor	Bite					
SMB4022	HSK63A-MD40F - 70	BB18-□(S)	Ø6.0-Ø34.0	132.5	41	62.5	0.6

\* Adjustment length: 17mm

• Head: Basic, Arbor/Bite: For separate purchase

• Through coolant system not available

### BB Bite (For SMB)



(mm)

Designation	Boring range		Ød	L <sub>1</sub>	L <sub>2</sub>	S		Insert	Insert screw	
	Min	Max								
BB	18-7(S)	7	27	18	30	30	3.5	0.1	TBGT0601□□L	BFTX0204A
	18-9(S)	9	29	18	30	40	4.5	0.1	TPGT0802□□L	BFTX0204A
	18-11(S)	11	31	18	30	45	5.5	0.1	TPGT1103□□L	BFTX0307A
	18-13(S)	13	33	18	40	45	6.5	0.1	TPGT1103□□L	BFTX0307A
	18-15(S)	15	35	18	40	50	7.5	0.2	TPGT1103□□L	BFTX0307A
	18-17(S)	17	37	18	40	50	8.5	0.2	TPGT1103□□L	BFTX0307A

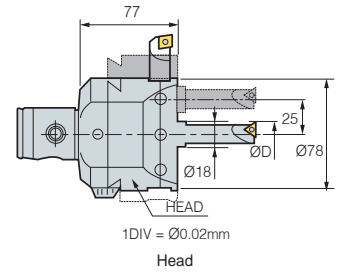
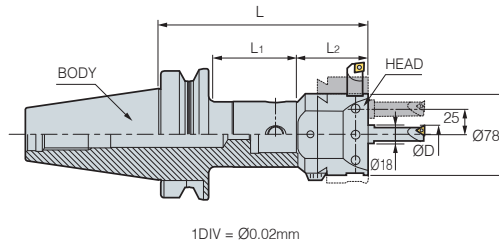
### Parts

Basic				For separate purchase	
Division	Boring head	Taper screw	Wrench	Boring bite	Basic holder
Parts					
Designation					
SMB	SMB4022	BTT1013F	LW-2.5	BB18	MD40F





# BT-KMB



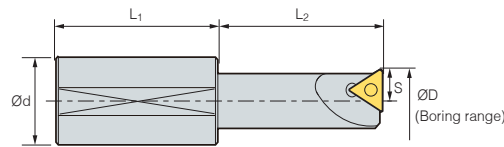
(mm)

Designation			Boring range ØD		L	L <sub>1</sub>	L <sub>2</sub>	kg
Head	Arbor	Bite	Bite position	ØD				
KMB6336	BT40-MD63F-64	BB18-□(S)	Center Hole	Ø8.0~Ø38.0	141	37	77	2.2
KMB6336	BT40-MD63F-110	BB18-□(S)	Center Hole	Ø8.0~Ø38.0	187	83	77	2.2
KMB6336	BT40-MD63F-135	BB18-□(S)	Eccentric Hole	Ø41.0~101.0	212	108	77	2.2
KMB6336	BT50-MD63F-75	BB18-□(S)	Eccentric Hole	Ø41.0~101.0	152	35	77	2.2
KMB6336	BT50-MD63F-135	BB18-□(S)	Side Hole	Max.Ø165.0	207	87	77	2.2
KMB6336	BT50-MD63F-195	BB18-□(S)	Side Hole	Max.Ø165.0	272	152	77	2.2

\* Adjustment length: 7mm

• Head: Basic, Arbor/Bite: For separate purchase • Through coolant system not available

## BB Bite (For KMB)



(mm)

Designation	Boring range (Center)				Ød	L <sub>1</sub>	L <sub>2</sub>	S	kg	Insert	Insert Screw
	Center	Eccentric									
BB	18-7(S)	7	40	27	91	18	30	30	3.5	0.1	TBGT0601□□L BFTX0204A
	18-9(S)	9	42	29	93	18	30	40	4.5	0.1	TPGT0802□□L BFTX0204A
	18-11(S)	11	44	31	95	18	30	45	5.5	0.1	TPGT1103□□L BFTX0307A
	18-13(S)	13	46	33	97	18	40	45	6.5	0.1	TPGT1103□□L BFTX0307A
	18-15(S)	15	48	35	99	18	40	50	7.5	0.2	TPGT1103□□L BFTX0307A
	18-17(S)	17	50	37	101	18	40	50	8.5	0.2	TPGT1103□□L BFTX0307A

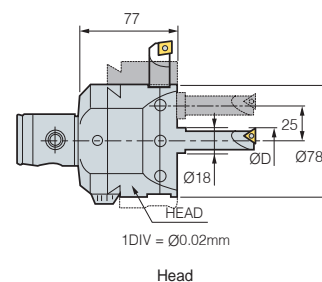
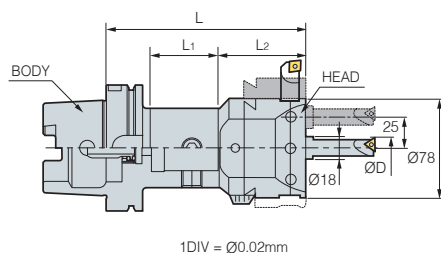
## Parts

Basic				For separate purchase	
Division	Boring head	Taper screw	Wrench	Boring bite	Basic holder
Parts					
Designation					
KMB	KMB6336	BTT1620F	LW-4.0	BB18	MD63F



# HSK-KMB

Micro Boring



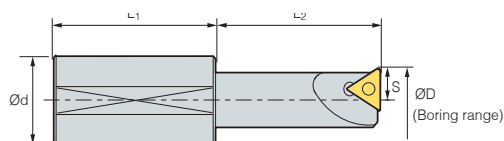
(mm)

Designation			Boring range ØD		L	L <sub>1</sub>	L <sub>2</sub>	kg
Head	Arbor	Bite	Bite position	ØD				
KMB6336	HSK63A-MD63F-95	BB18-□(S)	Center Hole	Ø8.0~Ø38.0	172	69	77	2.2

\* Adjustment length: 7mm

• Head: Basic, Arbor/Bite: For separate purchase • Through coolant system not available

## BB Bite (For KMB)



(mm)

Designation	Boring range (Center)				Ød	L <sub>1</sub>	L <sub>2</sub>	S	kg	Insert	Insert Screw	
	Center	Eccentric										
BB	18-7(S)	7	40	27	91	18	30	30	3.5	0.1	TBGT0601□□L	BFTX0204A
	18-9(S)	9	42	29	93	18	30	40	4.5	0.1	TPGT0802□□L	BFTX0204A
	18-11(S)	11	44	31	95	18	30	45	5.5	0.1	TPGT1103□□L	BFTX0307A
	18-13(S)	13	46	33	97	18	40	45	6.5	0.1	TPGT1103□□L	BFTX0307A
	18-15(S)	15	48	35	99	18	40	50	7.5	0.2	TPGT1103□□L	BFTX0307A
	18-17(S)	17	50	37	101	18	40	50	8.5	0.2	TPGT1103□□L	BFTX0307A

## Parts

Basic				For separate purchase	
Division	Boring head	Taper screw	Wrench	Boring bite	Basic holder
Parts					
Designation					
KMB	KMB6336	BTT1620F	LW-4.0	BB18	MD63F

# BT-SMH

Small Micro Boring Bar (For High precision)

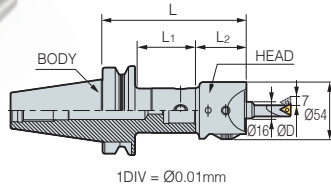


Fig. 1

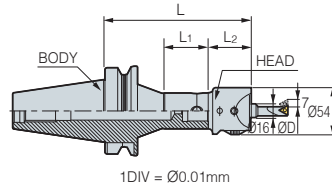
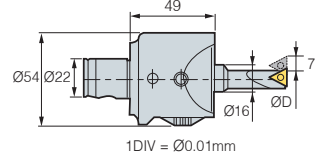


Fig. 2



Head

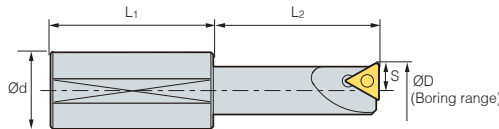
(mm)

Designation			Boring range ØD	L	L <sub>1</sub>	L <sub>2</sub>	kg	Fig.
Head	Arbor	Bite						
SMH4022	BT30-MD40F-45	BB16-□(S)	Ø6.0~Ø34.0	94	22	49	0.6	1
SMH4022	BT30-MD40F-60	BB16-□(S)	Ø6.0~Ø34.0	109	36	49	0.6	1
SMH4022	BT30-MD40F-80	BB16-□(S)	Ø6.0~Ø34.0	129	56	49	0.6	1
SMH4022	BT40-MD40F-60	BB16-□(S)	Ø6.0~Ø34.0	109	31	49	0.6	1
SMH4022	BT40-MD40F-110R	BB16-□(S)	Ø6.0~Ø34.0	159	60	49	0.6	2
SMH4022	BT40-MD40F-115	BB16-□(S)	Ø6.0~Ø34.0	164	83	49	0.6	1
SMH4022	BT50-MD40F-60	BB16-□(S)	Ø6.0~Ø34.0	109	22	49	0.6	1
SMH4022	BT50-MD40F-195	BB16-□(S)	Ø6.0~Ø34.0	244	152	49	0.6	1
SMH4022	BT50-MD40F-230R	BB16-□(S)	Ø6.0~Ø34.0	279	180	49	0.6	2

\* Adjustment length: 7 mm

• Head: Basic, Arbor/Bite: For separate purchase • Through coolant system not available

## BB Bite (For SMH)



(mm)

Designation	Boring range ØD		Ød	L <sub>1</sub>	L <sub>2</sub>	S	Insert	Insert Screw	Wrench	
	Min	Max								
BB	16-5(S)	5	19	16	34	20	2.75	WBGT0601□□L	BFTX0203A	TRX06
	16-7(S)	7	21	16	34	30	3.5	TBGT0601□□L	BFTX0204A	TRX06
	16-9(S)	9	23	16	34	40	4.5	TPGT0802□□L	BFTX0204A	TRX06
	16-11(S)	11	25	16	34	45	5.5	TPGT1103□□L	BFTX0307A	TRX10
	16-15(S)	15	29	16	34	50	7.5	TPGT1604□□L	BFTX0307A	TRX10
	16-19(S)	19	33	16	34	60	9.5	TPGT1604□□L	BFTX0410A	TRX15

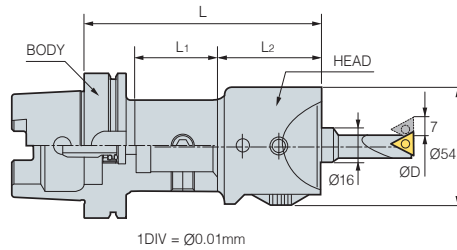
## Parts

Basic				For separate purchase	
Division	Boring head	Taper screw	Wrench	Boring bite	Basic holder
Parts					
Designation					
SMH	SMH4022	BTT1013F	LW-3.0	BB16	MD40F



# HSK-SMH

Small Micro Boring Bar (For High precision)

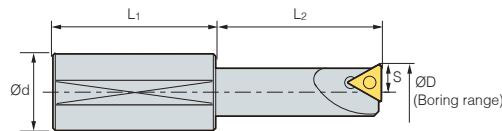


Designation			Boring range ØD	L	L <sub>1</sub>	L <sub>2</sub>	kg
Head	Arbor	Bite					
SMH4022	HSK63-MD40F-70	BB16-□(S)	Ø6.0~Ø34.0	132.5	41	49	0.6

\* Adjustment length: 17mm

• Head: Basic, Arbor/Bite: For separate purchase • Through coolant system not available

## BB Bite (For SMH)



Designation	Boring range ØD		Insert	Insert Screw	kg	
	Min	Max				
<b>BB</b>	16-7(S)	8	28	TBGT0601□□L	BFTX0204A	0.1
	16-9(S)	10	30	TPGT0802□□L	BFTX0204A	0.1
	16-11(S)	12	32	TPGT1103□□L	BFTX0307A	0.1
	16-13(S)	14	34	TPGT1103□□L	BFTX0307A	0.1
	16-15(S)	16	36	TPGT1604□□L	BFTX0307A	0.2
	16-17(S)	18	38	TPGT1604□□L	BFTX0307A	0.2

## Parts

Basic				For separate purchase	
Division	Boring head	Taper screw	Wrench	Boring bite	Basic holder
Parts					
Designation					
SMH	SMH4022	BTT1013F	LW-3.0	BB16	MD40F



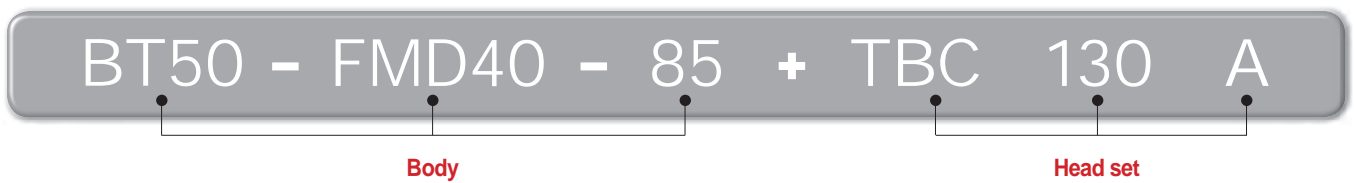
Wide diameter boring system

TBCA **new**

- Convenience in use simultaneously (available both inside and outside)
- Broad boring diameter and range
- Rough/Finishing boring with replaceable cartridge and common rail
- Boring range for outer diameter: Ø0~Ø395
- Boring range for inner diameter: Ø130~Ø631



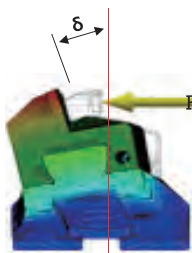
Code system



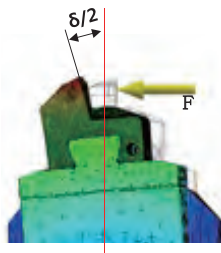
Features

Reinforced rigidity

- 50% less moment strain (versus the conventional product of DINE)



TBC460 (old type)



TBC460A (new type)

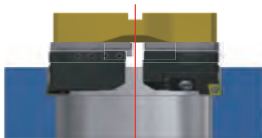
Lightweight design(Head set)

- BCC (Cartridge) + DBR (Bridge) + DBB (Rail)

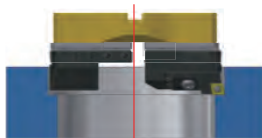


TBC130A	TBC175A	TBC220A	TBC265A
4.2 Kg	5.6 Kg	6.6 Kg	7.5 Kg
TBC310A	TBC385A	TBC460A	TBC535A
9.5 Kg	11.6Kg	14 Kg	16 Kg

Application



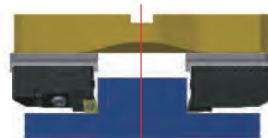
Twin edge boring



Single edge boring

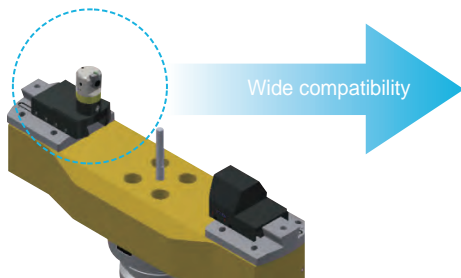


Step boring



Outside boring

Wide compatibility



Workpiece outer dia. boring



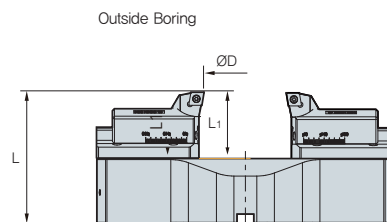
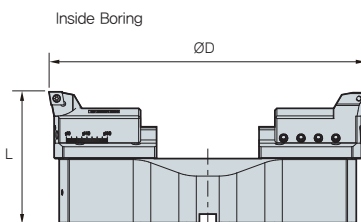
Workpiece outer dia. boring

	Images	List of clamping parts	Cutting type
Outer dia. boring		FBH3233B + FCE310 + FCB310	Finishing boring
		DBCA3235S + FCE310 + CB310	Rough boring
Inner dia. boring		DBS□□-□□CA + SCGCL16C-1A2	Rough boring
		FCC310	Finishing boring
		BCC1354	Rough boring

• TBC310A in case

# TBCA

## Wide diameter boring system



(mm)

FMC Arbor (Individual order)	kg	Twin Edge Boring for Roughing							kg
		TBC Head set (Rail + Cartridge (Main))	L	Boring range ØD					
				Inside Boring		Outside Boring			
Min	Max	Min	Max	L <sub>1</sub>					
BT50-FMC40-50	4.6	TBC130A (DBR130 + BCC1348 + BCC1348)	108	130	180	0	35	65	3.8
BT50-FMC40-50	4.6	TBC175A (DBR175 + BCC1348 + BCC1348)	113	175	225	0	75	65	5.2
BT50-FMC40-50	4.6	TBC220A (DBR07015 + BCC1348 + BCC1348)	118	220	270	60	124	65	7.3
BT50-FMC40-50	4.6	TBC265A (DBR07015 + BCC1348 + BCC1348)	123	265	315	64	174	65	7.3
BT50-FMC40-50	4.6	TBC310A (DBR10015 + BCC1345 + BCC1345)	128	310	390	79	159	65	9.7
BT50-FMC40-50	4.6	TBC385A (DBR10015 + BCC1354 + BCC1345)	133	385	465	153	233	65	11.8
BT50-FMC40-50	4.6	TBC460A (DBR10015 + BCC1354 + BCC1345)	138	460	540	229	309	65	14.3
BT50-FMC40-50	4.6	TBC535A (DBR10015 + BCC1354 + BCC1345)	143	535	615	303	383	65	16.4

• TBC Head set: Basic, Arbor: For separate purchase • Through coolant system is optional

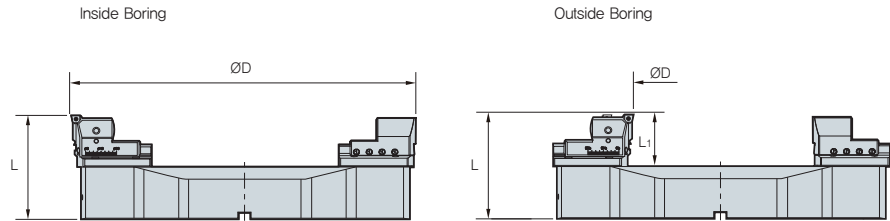
### Parts

Head set	Basic		For separate purchase		
	Bridge	Rail	Cartridge	Arbor	Pin
TBC130A	DBB130	DBR130	BCC1348S	BT50-FMC40-50	PN1080
TBC175A	DBB175	DBR175			
TBC220A	DBB220	DBR07015			
TBC265A	DBB265	DBR07015			
TBC310A	DBB310	DBR10015	BCC1354S	BT50-FMC40-50	PN1080
TBC385A	DBB385	DBR10015			
TBC460A	DBB460	DBR10015			
TBC535A	DBB535	DBR10015			



# TBCA

## Wide diameter boring system



(mm)

FMC Arbor (Individual order)	kg	Single Edge Boring for Roughing							kg
		TBC Head set (Rail + Cartridge (Separate sale))	L	Boring range ØD					
				Inside Boring		Outside Boring			
Min	Max	Min	Max	L <sub>1</sub>					
BT50-FMC40-50	4.6	TBC130A (DBR130 + FCC130 + FCB130 + FBB33N)	101	130	180	37	37	72	4.4
BT50-FMC40-50	4.6	TBC175A (DBR175 + FCC130 + FCB130 + FBB33N)	106	175	225	80	80	72	5.7
BT50-FMC40-50	4.6	TBC220A (DBR07015 + FCC130 + FCB130 + FBB33N)	111	220	270	173	173	72	7.8
BT50-FMC40-50	4.6	TBC265A (DBR07015 + FCC130 + FCB130 + FBB33N)	116	265	315	176	176	72	7.9
BT50-FMC40-50	4.6	TBC310A (DBR10015 + FCC310 + FCB310 + BB33N)	121	310	390	155.5	155.5	72	10.1
BT50-FMC40-50	4.6	TBC385A (DBR10015 + FCC310 + FCB310 + FBB33N)	126	385	465	229.5	229.5	72	12.2
BT50-FMC40-50	4.6	TBC460A (DBR10015 + FCC310 + FCB310 + FBB33N)	131	460	540	305.5	305.5	72	14.7
BT50-FMC40-50	4.6	TBC535A (DBR10015 + FCC310 + FCB310 + FBB33N)	136	535	615	379.5	379.5	72	16.7

• TBC Head set/Rail: Basic, Arbor/Cartridge: For separate purchase • Through coolant system is optional

### Parts

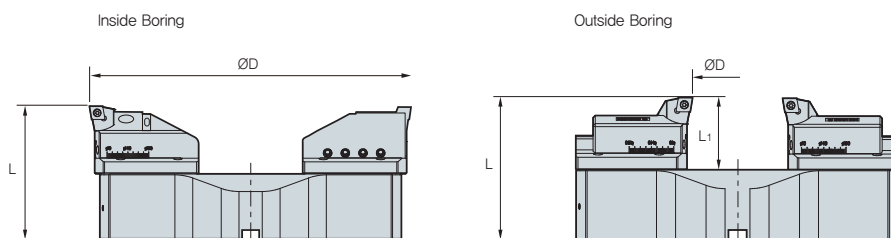
Basic			For separate purchase				
Head set	Bridge	Rail	Cartridge	Bite	Balance block	Arbor	Pin
TBC130A	DBB130	DBR130	FCC130	FBB130△□□	FCB130	BT50-FMC40-50	PN1080
TBC175A	DBB175	DBR175					
TBC220A	DBB220	DBR07015					
TBC265A	DBB265	DBR07015					
TBC310A	DBB310	DBR10015	FCC310		FCB310		
TBC385A	DBB385	DBR10015					
TBC460A	DBB460	DBR10015					
TBC535A	DBB535	DBR10015					





# TBCA

## Wide diameter boring system



(mm)

FMC Arbor (Individual order)	kg	Step Boring for Roughing								kg
		TBC Head set (Rail + Cartridge (Separate sale))	L	Boring range ØD						
				Inside Boring		Outside Boring				
Min	Max	Min	Max	L <sub>1</sub>						
<b>BT50-FMC40-50</b>	4.6	TBC130A (DBR130 + DBS25-□□CA + SCGCL16CA-12)	108	130	180	0	13.5	65	4.3	
<b>BT50-FMC40-50</b>	4.6	TBC175A (DBR175 + DBS25-□□CA + SCGCL16CA-12)	113	175	225	0	55	65	5.7	
<b>BT50-FMC40-50</b>	4.6	TBC220A (DBR07015 + DBS25-□□CA + SCGCL16CA-12)	118	220	270	64	128	65	7.8	
<b>BT50-FMC40-50</b>	4.6	TBC265A (DBR07015 + DBS25-□□CA + SCGCL16CA-12)	123	265	315	68	118	65	7.9	
<b>BT50-FMC40-50</b>	4.6	TBC310A (DBR10015 + DBS40-□□CA + SCGCL16CA-12)	128	310	390	109	159	65	10.2	
<b>BT50-FMC40-50</b>	4.6	TBC385A (DBR10015 + DBS40-□□CA + SCGCL16CA-12)	133	385	465	183	233	65	12.3	
<b>BT50-FMC40-50</b>	4.6	TBC460A (DBR10015 + DBS40-□□CA + SCGCL16CA-12)	138	460	540	259	309	65	14.8	
<b>BT50-FMC40-50</b>	4.6	TBC535A (DBR10015 + DBS40-□□CA + SCGCL16CA-12)	143	535	615	333	383	65	16.9	

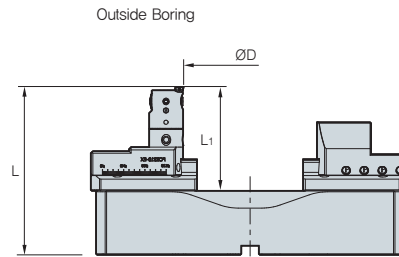
• TBC Head set/Rail: Basic, Arbor/Cartridge: For separate purchase • Through coolant system is optional

### Parts

Basic				For separate purchase				
Head set	Bridge	Rail	Cartridge	Arbor	Slide	Cartridge	Plate	Pin
TBC130A	DBB130	DBR130	BCC1348S	BT50-FMC40-50	DBS25-16CA DBS25-20CA DBS25-25CA	ISO Cartridge	ISO Cartridge Plates	PN1080
TBC175A	DBB175	DBR175	BCC1348S					
TBC220A	DBB220	DBR07015	BCC1348S					
TBC265A	DBB265	DBR07015	BCC1348S					
TBC310A	DBB310	DBR10015	BCC1354S					
TBC385A	DBB385	DBR10015	BCC1354S					
TBC460A	DBB460	DBR10015	BCC1354S					
TBC535A	DBB535	DBR10015	BCC1354S					
					DBS40-16CA DBS40-20CA DBS40-25CA			

# TBCA

## Wide diameter boring system



(mm)

FMC Arbor (Individual order)	kg	Step Boring for Roughing					kg	
		TBC Head set (Rail + Cartridge (Separate sale))		L	Boring range ØD			
					Outside Boring			
Min	Max	L <sub>1</sub>						
BT50-FMC40-50	4.6	TBC130A (DBR130 + FCB130 + FCE130 + FBH3233B + FBB33N)		145	0	39	102	5.2
BT50-FMC40-50	4.6	TBC175A (DBR175 + FCB130 + FCE130 + FBH3233B + FBB33N)		150	0	84	102	6.5
BT50-FMC40-50	4.6	TBC220A (DBR07015 + FCB130 + FCE130 + FBH3233B + FBB33N)		155	26	180	102	8.7
BT50-FMC40-50	4.6	TBC265A (DBR07015 + FCB130 + FCE130 + FBH3233B + FBB33N)		160	26	180	102	8.7
BT50-FMC40-50	4.6	TBC310A (DBR10015 + FCB310 + FCE310 + FBH3233B + FBB33N)		165	16	170	102	11
BT50-FMC40-50	4.6	TBC385A (DBR10015 + FCB310 + FCE310 + FBH3233B + FBB33N)		170	90	244	102	13.1
BT50-FMC40-50	4.6	TBC460A (DBR10015 + FCB310 + FCE310 + FBH3233B + FBB33N)		175	166	318	102	15.6
BT50-FMC40-50	4.6	TBC535A (DBR10015 + FCB310 + FCE310 + FBH3233B + FBB33N)		180	240	394	102	17.7

• TBC Head set/Rail: Basic, Arbor/Cartridge: For separate purchase • Through coolant system is optional

### Parts

Basic			For separate purchase				
Head set	Bridge	Rail	Arbor	Slide	B/B	Head	Pin
TBC130A	DBB130	DBR130					
TBC175A	DBB175	DBR175					
TBC220A	DBB220	DBR07015					
TBC265A	DBB265	DBR07015					
TBC310A	DBB310	DBR10015					
TBC385A	DBB385	DBR10015					
TBC460A	DBB460	DBR10015					
TBC535A	DBB535	DBR10015					

• B/B: Balance Block



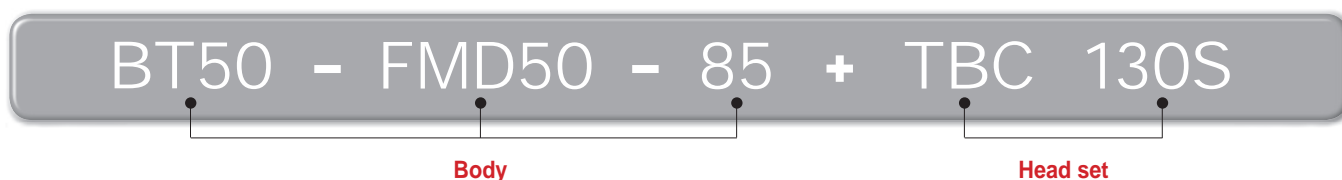
Balance cut tool for Rough boring

# TBC

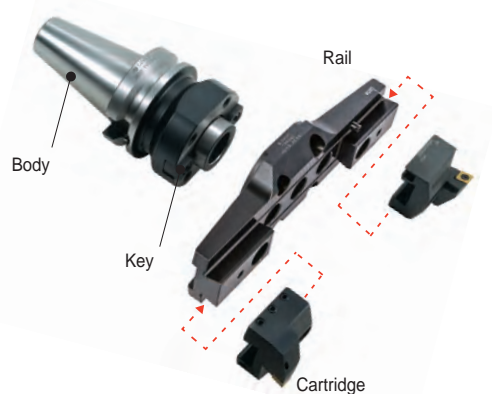
- Wide boring range for big diameters: Ø130~Ø540 mm
- Stable structure against for cutting load - Assembly by dove-tail structure
- Interconvert with FBC
  - Common boring head and rail adopted, different cartridge
- Light-weight (5%~20% reduced)
- Various cartridge approach angle: 15°, 45°



Code system



TBC boring tool structure & features



Cartridge: BCC1348  
 Incert: CCMT1204□□  
 CNMG1204□□



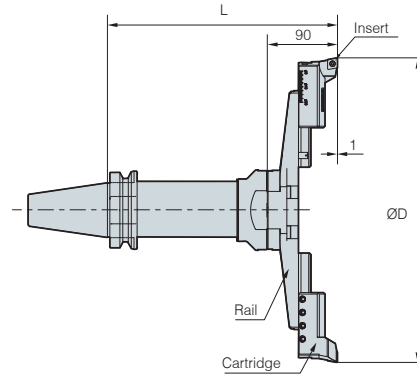
Rail: TBR□□  
 Weight reduced and space for chip discharge secured by removing the side part

Boring range

Grade	Dia (Ø)		Head set	Insert
	Min	Max		
TBC130	130	180	TBC130 (TBR130 + BCC1348 + BCC1348)	CCMT1204□□
TBC175	175	225	TBC175 (TBR175 + BCC1348 + BCC1348)	CCMT1204□□
TBC220	220	270	TBC220 (TBR220 + BCC1348 + BCC1348)	CCMT1204□□
TBC265	265	315	TBC265 (TBR265 + BCC1348 + BCC1348)	CCMT1204□□
TBC310	310	390	TBC310 (TBR310 + BCC1348 + BCC1348)	CCMT1204□□
TBC385	385	465	TBC385 (TBR310 + BCC1348 + BCC1348)	CCMT1204□□
TBC460	460	540	TBC460 (TBR460 + BCC1348 + BCC1348)	CCMT1204□□

# BT-TBC

Balance cut tool for rough boring



(mm)

FMC Arbor (Individual order)	kg	Rough boring (TBC)				
		TBC Head set (Rail + Cartridge)	L	Boring range ØD		kg
				Min	Max	
BT50-FMD50-85	5.9	TBC130 (TBR130 + BCC1348)	175	130	180	3.2
BT50-FMD50-155	7.9	TBC130 (TBR130 + BCC1348)	245	130	180	3.2
BT50-FMD50-205	9.7	TBC130 (TBR130 + BCC1348)	295	130	180	3.2
BT50-FMD50-255	13.4	TBC130 (TBR130 + BCC1348)	345	130	180	3.2
BT50-FMD50-85	5.9	TBC175 (TBR175 + BCC1348)	175	175	225	3.6
BT50-FMD50-155	7.9	TBC175 (TBR175 + BCC1348)	245	175	225	3.6
BT50-FMD50-205	9.7	TBC175 (TBR175 + BCC1348)	295	175	225	3.6
BT50-FMD50-255	13.4	TBC175 (TBR175 + BCC1348)	345	175	225	3.6
BT50-FMD50-85	5.9	TBC220 (TBR220 + BCC1348)	175	220	270	4
BT50-FMD50-155	7.9	TBC220 (TBR220 + BCC1348)	245	220	270	4
BT50-FMD50-205	9.7	TBC220 (TBR220 + BCC1348)	295	220	270	4
BT50-FMD50-255	13.4	TBC220 (TBR220 + BCC1348)	345	220	270	4
BT50-FMD50-85	5.9	TBC265 (TBR265 + BCC1348)	175	265	315	4.2
BT50-FMD50-155	7.9	TBC265 (TBR265 + BCC1348)	245	265	315	4.2
BT50-FMD50-205	9.7	TBC265 (TBR265 + BCC1348)	295	265	315	4.2
BT50-FMD50-255	13.4	TBC265 (TBR265 + BCC1348)	345	265	315	4.2
BT50-FMD50-85	5.9	TBC310 (TBR310 + BCC1354)	175	310	390	5.2
BT50-FMD50-155	7.9	TBC310 (TBR310 + BCC1354)	245	310	390	5.2
BT50-FMD50-205	9.7	TBC310 (TBR310 + BCC1354)	295	310	390	5.2
BT50-FMD50-255	13.4	TBC310 (TBR310 + BCC1354)	345	310	390	5.2
BT50-FMD50-85	5.9	TBC385 (TBR385 + BCC1354)	175	385	465	5.5
BT50-FMD50-155	7.9	TBC385 (TBR385 + BCC1354)	245	385	465	5.5
BT50-FMD50-205	9.7	TBC385 (TBR385 + BCC1354)	295	385	465	5.5
BT50-FMD50-255	13.4	TBC385 (TBR385 + BCC1354)	345	385	465	5.5
BT50-FMD50-85	5.9	TBC460 (TBR460 + BCC1354)	175	460	540	12.5
BT50-FMD50-155	7.9	TBC460 (TBR460 + BCC1354)	245	460	540	12.5
BT50-FMD50-205	9.7	TBC460 (TBR460 + BCC1354)	295	460	540	12.5
BT50-FMD50-255	13.4	TBC460 (TBR460 + BCC1354)	345	460	540	12.5

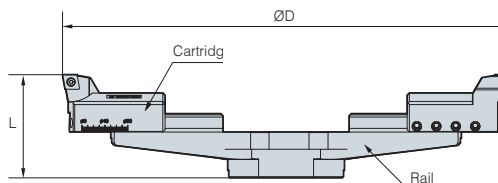
➔ Spare Part G81

• TBC Head set: Basic, Arbor: For separate purchase • Through coolant system is not available



# TBC Head Set

Balance cut tool for rough boring



(mm)

Head set (Main component)			Boring range ØD		L	kg	For separate purchase
Designation	Rail	Cartridge	Min	Max			Insert
<b>TBC130S</b>	TBR130	BCC1348	130	180	90	3.5	CCMT1204□□
<b>TBC175S</b>	TBR175	BCC1348	175	225	90	3.9	CCMT1204□□
<b>TBC220S</b>	TBR220	BCC1348	220	270	90	4.3	CCMT1204□□
<b>TBC265S</b>	TBR265	BCC1348	265	315	90	4.5	CCMT1204□□
<b>TBC310S</b>	TBR310	BCC1354	310	390	90	5.5	CCMT1204□□
<b>TBC385S</b>	TBR385	BCC1354	385	465	90	5.8	CCMT1204□□
<b>TBC460S</b>	TBR460	BCC1354	460	540	90	12.8	CCMT1204□□

\* If CNMG1204□□ insert is used, BCN1348, BCN1354 cartridges can be ordered.

## Parts

Basic							
Division	Rail	Cartridge	Clamp bolt	Clamp bolt	Hexagonal wrench	Clamp screw	Torx wrench
Parts Head set							
	<b>TBC130S</b>	TBR130	BX0820	BT0645	LW-3 LW-4 LW-6	BFTX0511N	TRX20
<b>TBC175S</b>	TBR175	BCC1348 (BCN1348)					
<b>TBC220S</b>	TBR220						
<b>TBC265S</b>	TBR265	BCC1354 (BCN1354)		BT0660			
<b>TBC310S</b>	TBR310						
<b>TBC385S</b>	TBR385						
<b>TBC460S</b>	TBR460						



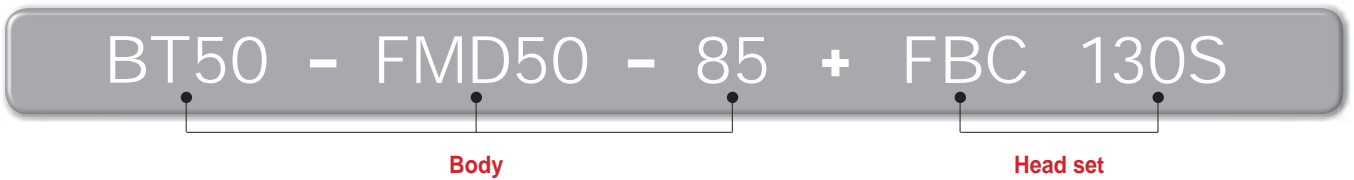
## Balance cut tool for fine boring

# FBC

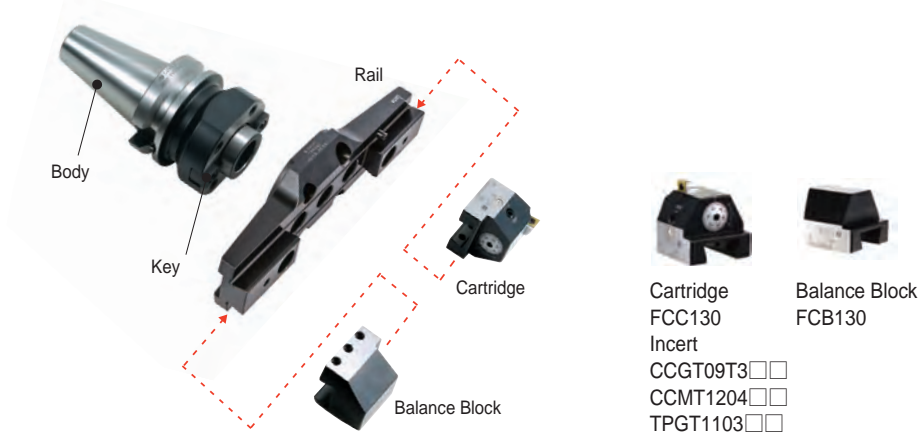
- Broad boring diameter and range
  - Wide Boring Range:  $\text{Ø}130\sim\text{Ø}540$  mm
- Structurally stable enough to resist cutting load
  - Provides strong cutting performance based on the precision grinding dovetail method
- Can perform rough boring operation by changing boring head cartridges
  - Compatible boring head and rail as they are in the same structure
- Various cartridge tip angles
  - cartridge fore end angles  $15^\circ$  and  $45^\circ$  selectable



### Code system



### FBC boring tool structure & features



### Boring range

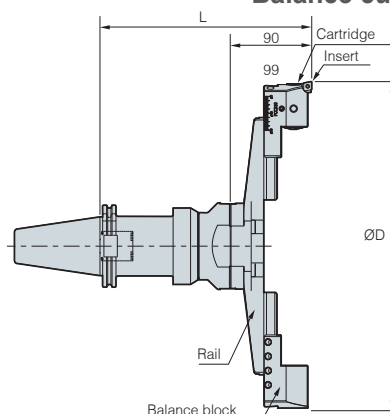
Designation	Dia (Ø)		Head set	Insert
	Min	Max		
<b>FBC130</b>	130	180	FBC130S (TBR130 + FCC130 + FCB130)	FBB130-C09 (CCMT09T3□□, CCGT09T3□□) FBB130-C12 (CCMT1204□□) FBB130-T11 (TPMT1103□□, TPGT1103□□L)
<b>FBC175</b>	175	225	FBC175S (TBR175 + FCC130 + FCB130)	
<b>FBC220</b>	220	270	FBC220S (TBR220 + FCC130 + FCB130)	
<b>FBC265</b>	265	315	FBC265S (TBR265 + FCC130 + FCB130)	
<b>FBC310</b>	310	390	FBC310S (TBR310 + FCC310 + FCB310)	
<b>FBC385</b>	385	465	FBC385S (TBR385 + FCC310 + FCB310)	
<b>FBC460</b>	460	540	FBC460S (TBR460 + FCC310 + FCB310)	



# BT-FBC



Balance cut tool for fine boring



(mm)

FMC Arbor (Individual order)	kg	Rough boring (TBC)				
		TBC Head set (Rail + Cartridge + Balance block)	L	Boring range (ØD)		kg
				Min	Max	
BT50-FMD50-85	5.9	FBC130S (TBR130 + FCC130 + FCB130)	182	130	180	3.7
BT50-FMD50-155	7.9	FBC130S (TBR130 + FCC130 + FCB130)	252	130	180	3.7
BT50-FMD50-205	9.7	FBC130S (TBR130 + FCC130 + FCB130)	302	130	180	3.7
BT50-FMD50-255	13.4	FBC130S (TBR130 + FCC130 + FCB130)	352	130	180	3.7
BT50-FMD50-85	5.9	FBC175S (TBR175 + FCC130 + FCB130)	182	175	225	4.1
BT50-FMD50-155	7.9	FBC175S (TBR175 + FCC130 + FCB130)	252	175	225	4.1
BT50-FMD50-205	9.7	FBC175S (TBR175 + FCC130 + FCB130)	302	175	225	4.1
BT50-FMD50-255	13.4	FBC175S (TBR175 + FCC130 + FCB130)	352	175	225	4.1
BT50-FMD50-85	5.9	FBC220S (TBR220 + FCC130 + FCB130)	182	220	270	4.5
BT50-FMD50-155	7.9	FBC220S (TBR220 + FCC130 + FCB130)	252	220	270	4.5
BT50-FMD50-205	9.7	FBC220S (TBR220 + FCC130 + FCB130)	302	220	270	4.5
BT50-FMD50-255	13.4	FBC220S (TBR220 + FCC130 + FCB130)	352	220	270	4.5
BT50-FMD50-85	5.9	FBC265S (TBR265 + FCC130 + FCB130)	182	265	315	4.7
BT50-FMD50-155	7.9	FBC265S (TBR265 + FCC130 + FCB130)	252	265	315	4.7
BT50-FMD50-205	9.7	FBC265S (TBR265 + FCC130 + FCB130)	302	265	315	4.7
BT50-FMD50-255	13.4	FBC265S (TBR265 + FCC130 + FCB130)	352	265	315	4.7
BT50-FMD50-85	5.9	FBC310S (TBR310 + FCC310 + FCB310)	182	310	390	5.5
BT50-FMD50-155	7.9	FBC310S (TBR310 + FCC310 + FCB310)	252	310	390	5.5
BT50-FMD50-205	9.7	FBC310S (TBR310 + FCC310 + FCB310)	302	310	390	5.5
BT50-FMD50-255	13.4	FBC310S (TBR310 + FCC310 + FCB310)	352	310	390	5.5
BT50-FMD50-85	5.9	FBC385S (TBR385 + FCC310 + FCB310)	182	385	465	5.8
BT50-FMD50-155	7.9	FBC385S (TBR385 + FCC310 + FCB310)	252	385	465	5.8
BT50-FMD50-205	9.7	FBC385S (TBR385 + FCC310 + FCB310)	302	385	465	5.8
BT50-FMD50-255	13.4	FBC385S (TBR385 + FCC310 + FCB310)	352	385	465	5.8
BT50-FMD50-85	5.9	FBC460S (TBR460 + FCC310 + FCB310)	182	460	540	12.8
BT50-FMD50-155	7.9	FBC460S (TBR460 + FCC310 + FCB310)	252	460	540	12.8
BT50-FMD50-205	9.7	FBC460S (TBR460 + FCC310 + FCB310)	302	460	540	12.8
BT50-FMD50-255	13.4	FBC460S (TBR460 + FCC310 + FCB310)	352	460	540	12.8

➔ Spare Part **G84**

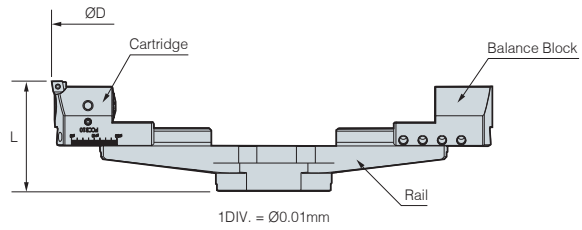
• TBC Head set: Basic, Arbor: For separate purchase • Through coolant system not available





# FBC Head Set

Balance cut tool for fine boring



(mm)

Head set (Main component)				Boring range ØD		L	Kg	For separate purchase
Designation	Rail	Cartridge	Balance block	Min	Max			Bite
TBC130S	TBR130	FCC130	FCB130	130	180	97	3.8	FBB130-C09 FBB130-C12 FBB130-T11
TBC175S	TBR175	FCC130	FCB130	175	225	97	4.1	
TBC220S	TBR220	FCC130	FCB130	220	270	97	4.5	
TBC265S	TBR265	FCC130	FCB130	265	315	97	4.6	
TBC310S	TBR310	FCC310	FCB310	310	390	97	5.5	
TBC385S	TBR385	FCC310	FCB310	385	465	97	5.8	
TBC460S	TBR460	FCC310	FCB310	460	540	97	12.8	

## Parts

Basic							For separate purchase	
Division	Rail	Cartridge	Balance block	Clamp bolt	Clamp bolt	Hexagonal wrench	Bite	
Parts Head set								
	FBC130S	TBR130	FCC130	FCB130	BTF0810 BTF0814	BT0645	LW-3 LW-4	FBB130-C09 FBB130-C12 FBB130-T11
	FBC175S	TBR175						
	FBC220S	TBR220						
	FBC265S	TBR265						
	FBC310S	TBR310	FCC310	FCB310	BT0660			
	FBC385S	TBR385						
	FBC460S	TBR460						

# FBB Bite



Designation	Insert
FBB130 - C09	CCMT09T3□□, CCGT09T3□□
C12	CCMT1204□□
T11	TPMT1103□□, TPGT1103□□



## Slim Angular Head BT-SAHA

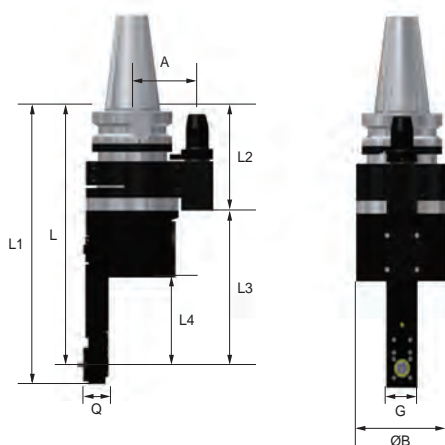
- Angular head for narrow inside boring  
(min. inner diameter of workpiece: Ø40, min. boring width: 32 mm)
- MAX 3,500 RPM, Spindle: applied rotation ratio = 1:1.37
- Boring range: Ø3, Ø4, Ø6



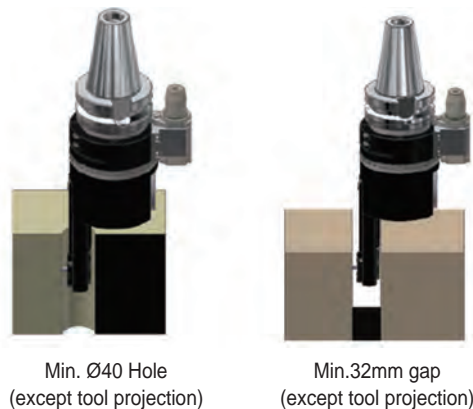
### Code system



### Details



### Machining Features



Designation	L	L1	L2	L3	L4	A	Q	G	ØB	Rotation ratio (IN: OUT)	Rotation direction	MAX RPM	kg
BT50-SAHA6-277	277	298	183.5	166.5	93.5	80 (110)	31.5	40	76	1: 1.37	CW: CW	3,500	14

### Clamping Force

Division	Measurement	Measured value (N-m)			
Clamp torque	2	2.5	3	3.5	4
Clamping Force	Not measurable	5.5	6.5	7	7

※ The moderate clamp torque of collet is 3.5N-m.

### Exclusive collet

	Designation	Clamping range
	SAH6-C3	3
	SAH6-C4	4
	SAH6-C6	6

### How to clamp



1. Couple the tool with SAH dedicated collet
2. Insert the coupled tool into SAH and fix it with a dedicated tightening jig
3. Turn the bolt using a hexagonal wrench

# G Angular head

## ANGULAR HEAD

# ANGULAR HEAD

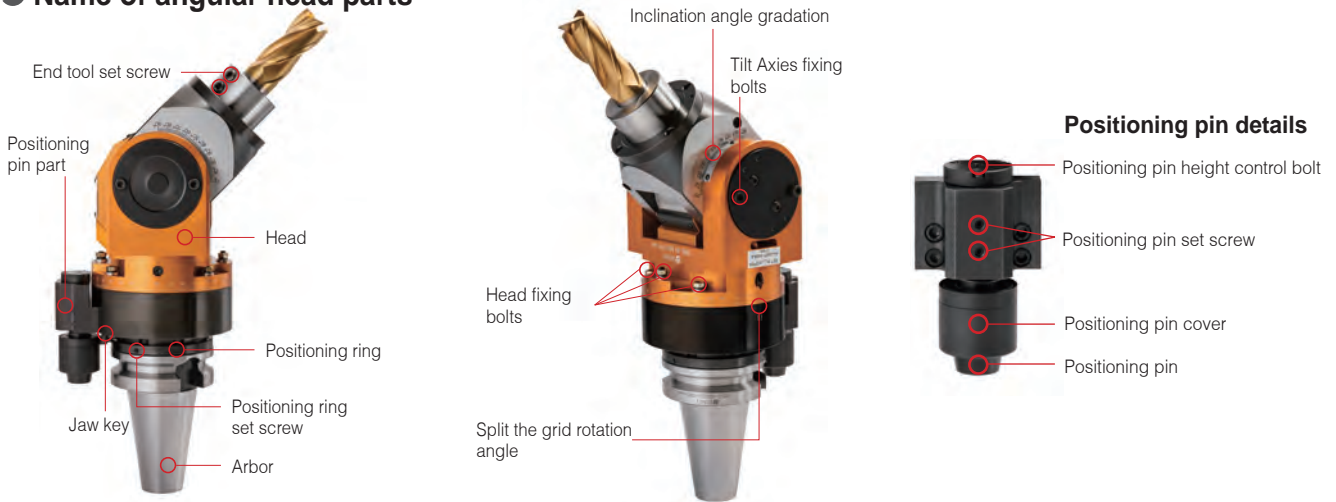
- Doubled effect by one equipment/Available for various angles
- Lighter aluminum body



### Code system



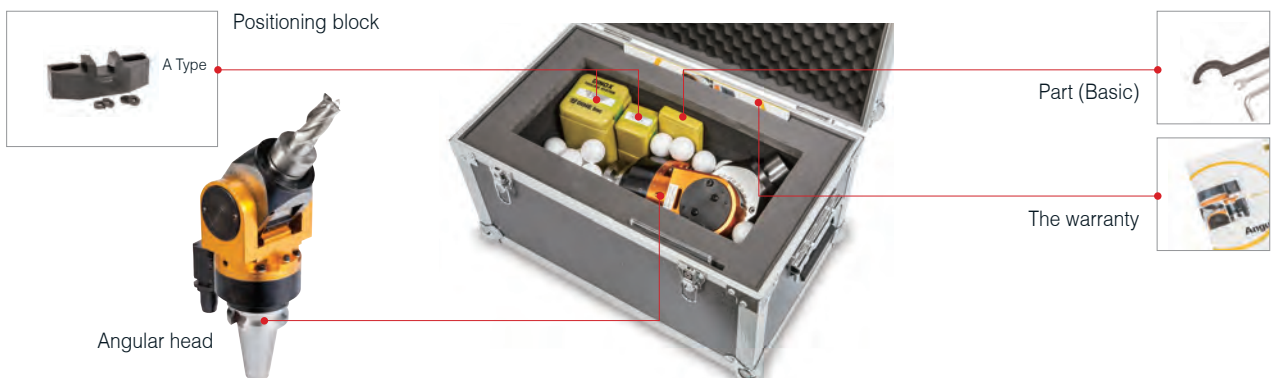
### Name of angular head parts



### Various applications

0-90-degree rotating (MAH, KHU)	Fixed 90-degree type (KAH)	Fixed 45-degree type (KAC)	Attachment type (HRAG, KAG)

### Components



**MAH**

**Universal type MAH (Reinforced series)**

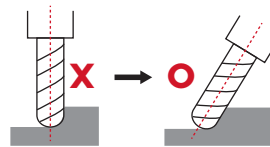
- Reinforced type Better performance by improving existing universal Angular head
  - Stability on large mold machining
  - Use 32mm Ball Endmill



**KHU**

**Universal type KHU (Free angle)**

- Adjustable angle-type angular head that enables flexible machining
  - Wide vertical (0°~90°) and horizontal (0°~360°) machining angle range
  - To use Tap-exclusive collet, please contact us in advance
  - HSK and SK types are customizable



Be sure to give a slope to the cutting edge of a ball end mill when machining it as the ball end mill edge is worn out and the surface roughness of the workpiece becomes defective

**HRAG**

**Attachment type HRAG (Reinforced type)**

- HRAG: The reinforced bracket enhanced durability upto 200%
  - Stability on face milling machining
  - Enhances compatibility with the machining device due to easy bracket disassembly/assembly even on the BT50 shank
  - Improves product life cycle



**KAG**

**Attachment type KAG**

- Free 360° angle adjusting from side to side
  - Possible to use various tools of BT40 and BT30
  - HSK and SK type are order made
  - Coolant types are to be ordered separately



**KAH**

**Modular type KAH (90° type)**

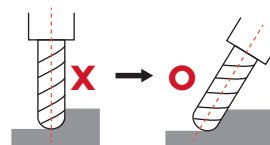
- Adjustable angle-type angular head that enables flexible machining
  - Adjusting angle up to 360°
  - To use Tap-exclusive Collet, please contact us in advance
  - HSK and SK type are order made



**KAC**

**Modular type KAC (45° type)**

- Fixed angle type angular head that enables flexible machining
  - Adjusting angle up to 360°
  - To use Tap-exclusive Collet, please contact us in advance
  - 45-degree fixed type angular head
  - For BT40 types, please contact us separately



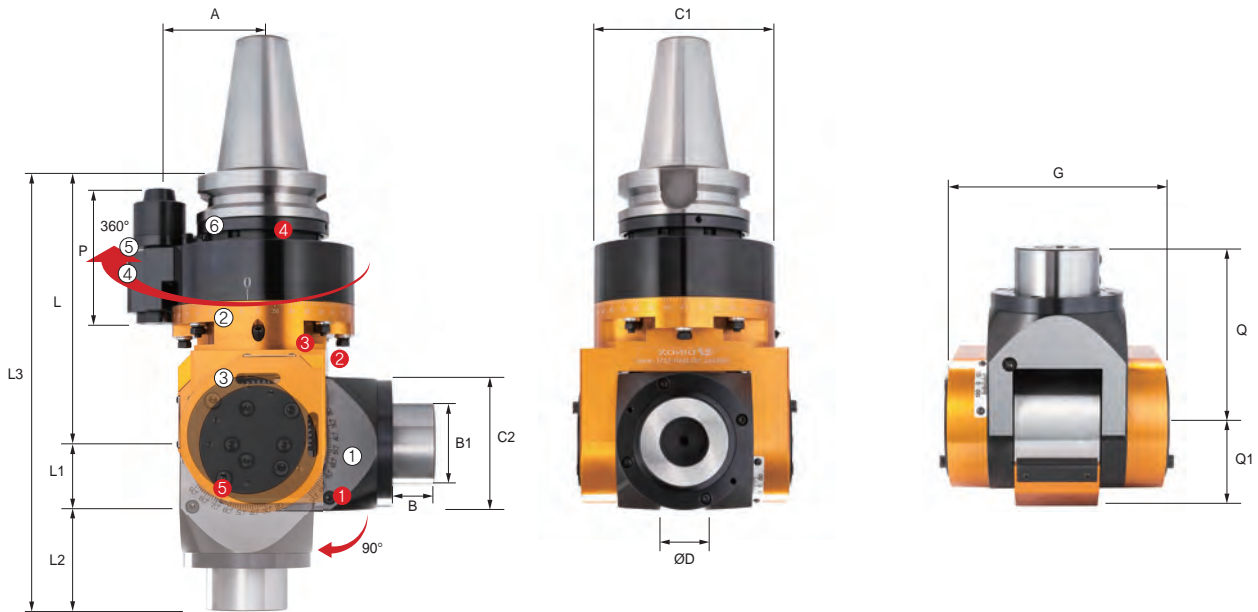
Be sure to give a slope to the cutting edge of a ball end mill when machining it as the ball end mill edge is worn out and the surface roughness of the workpiece becomes defective



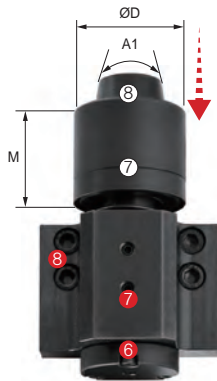
# G Angular Head

MHA for mold (0°~90°)\_Reinforced type

## BT-MAH



### Positioning pin



Shank size	M	A1	ØD
BT50	56.5	20°	Ø40

NO	Name
①	Inclination angle gradation (Axial positioning in 0°~90°)
②	Rotating angle gradation (Free radius position in 360°)
③	Head
④	Positioning pin part
⑤	Jaw key
⑥	Positioning ring
⑦	Positioning pin cover
⑧	Positioning pin

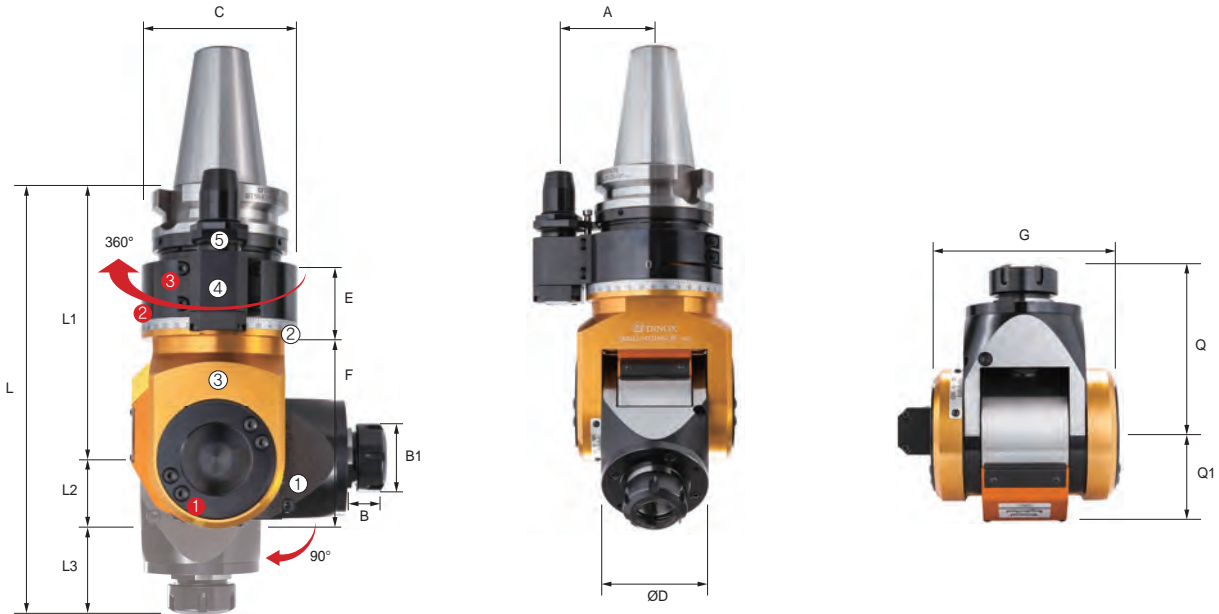
NO	Part name	Designation
①	Inclination angle gradation screw	BT1216
②	Head fixed bolts	BT0645
③	Rotating angle gradation screw	BT0640
④	Positioning ring set screw	MSST5-12
⑤	Tilt Axes fixing bolt	BH0616
⑥	Positioning pin height control bolt	BT0516
⑦	Positioning pin set screw	BT0512
⑧	Body position block set screw	BX0516

Designation	ØD	L	L1	L2	L3	C	C1	G	C2	Q	Q1	B	B1	P	A	Max RPM	Install tool	kg
BT50-MAH32-200	32	200	47	78	325	136	95	154	95	125	63	31	60	95	80	3,000	SIDE LOCK	19.6

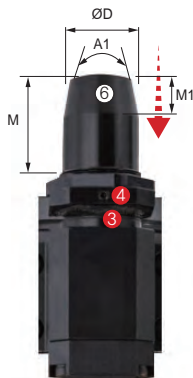


KHU (0°~90°)\_Collet type

# BT-KHU



## Positioning pin



Shank size	M	M1	A	ØD
BT40	Max: 32 Min: 26	10	20°	Ø19.6

NO	Name
①	Inclination angle gradation (Axial positioning in 0°~90°)
②	Rotating angle gradation (Free radius position in 360°)
③	Head
④	Positioning pin part
⑤	Jaw key
⑥	Height control wrench hole

NO	Part name	Designation
①	Tilt Axes fixing bolt	BH0630
②	Bracket angle fixing bolt	BX0630
③	Position block fixing bolt	BX0512
④	Set screw	BT0404
⑤	Fixing bolts	BX05630

Designation	ØD	ØD1	L	L1	L2	L3	B	B1	E	F	C	A	G	Q	Q1	Torque rate (IN: OUT)	Direction of rotation (IN: OUT)	Max RPM	Collet	kg
BT40-KHU10-160	1.0~10.0	58	247	160	33	54	22	28	51	98	96	65	90	87	40	1 : 2	CW: CW	6,000	GER16	8.3
BT50-KHU10-180	1.0~10.0	84	267	180	33	54	22	28	53	103	114	80	90	87	40	1 : 2	CW: CW	6,000	GER16	11.5
BT50-KHU20-195	1.0~20.0	84	315	195	47	73	29	50	53	132	114	80	124	120	63	1 : 1	CW: CW	3,000	GER32	17.9

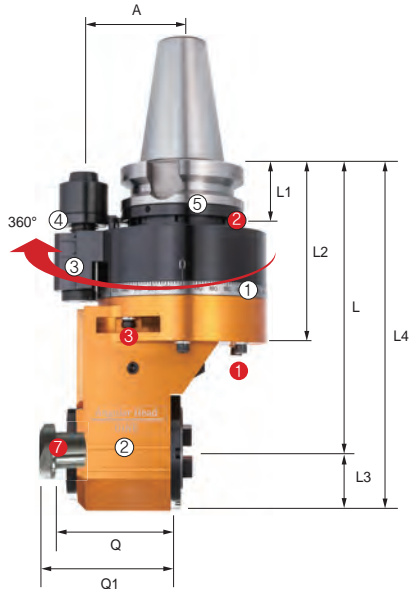




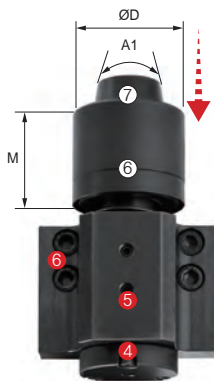
# G Angular Head

HRAG (90° fixed)\_Reinforced type

## BT-HRAG



### Positioning pin



Shank size	M	A1	ØD
BT50	56.5	20°	Ø40

NO	Name
①	Rotating angle graduation (Free radius position in 360°)
②	Head
③	Positioning pin part
④	Jaw key
⑤	Positioning ring
⑥	Positioning pin cover
⑦	Positioning pin

NO	Part name	Designation
①	Head fixed bolts	BX0660
②	Positioning ring set screw	MSST5-12
③	Rotating angle graduation screw	BT0648
④	Positioning pin height control bolt	BT0516
⑤	Positioning pin set screw	BT0512
⑥	Body position block set screw	BX0516
⑦	BT/NT Bolt	

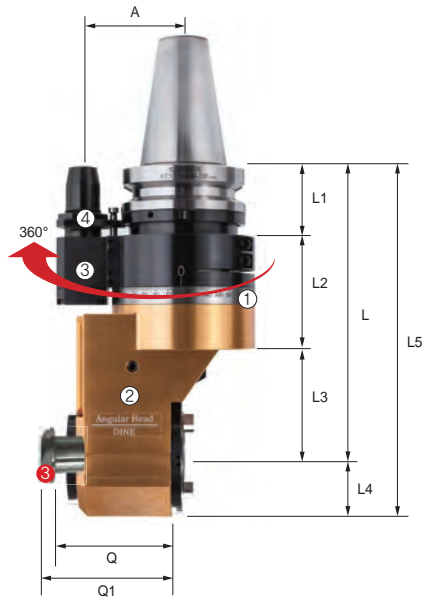
Designation	L	L1	L2	L3	L4	Q	Q1	A	G	G1	Max RPM	Tool shank	kg
BT50-HRAG40-230	230	56.5	145	46.5	276.5	89	101	80	93	136	3000	BT/NT40	18.2



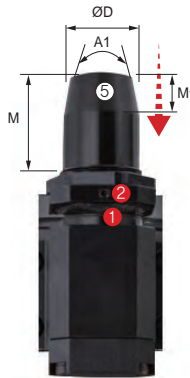


KAG (90° fixed type)

# BT-KAG




## Positioning pin



Shank size	M	M1	A1	ØD
BT40	Max: 32 Min: 26	10	20°	Ø19.6
BT50	Max: 35 Min: 29	15	20°	Ø28

NO	Name
①	Rotating angle graduation (Free radius position in 360°)
②	Head
③	Positioning pin part
④	Jaw key
⑤	Height control wrench hole

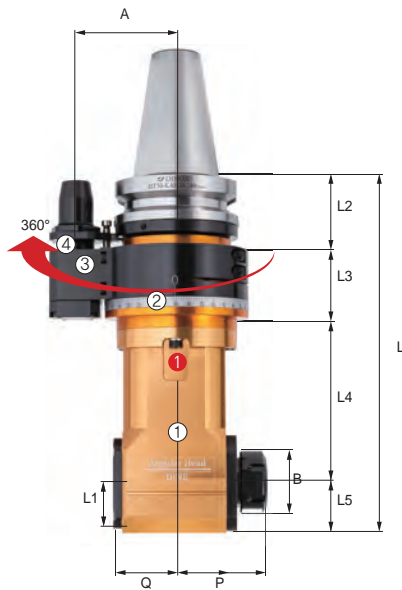
NO	Part name	Designation
①	Set screw	BT0404
②	Fixing bolts	BX50630
③	BT / NT Bolt	

Designation	L	L1	L2	L3	L4	L5	Q	Q1	A	C	G	Torque rate (IN: OUT)	Direction of rotation (IN: OUT)	MAX RPM	Holder shank	
BT40-KAG30-195	195	44	86	65	37.5	232.5	66	70	65	96	75	1: 1	CW: CW	4,000	BT30/NT30	6.4
BT50-KAG40-230	230	57	88	85	46.5	276.5	89	94	80	114	93	1: 1	CW: CW	3,000	BT40/NT40	15.8

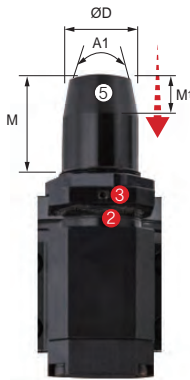
# G Angular Head

HRAG (90° fixed)\_Collet type

## BT-KAH



### Positioning pin



Shank size	M	M1	A1	ØD
BT40	Max: 32 Min: 26	10	20°	Ø19.6
BT50	Max: 35 Min: 29	15	20°	Ø28

NO	Name
①	Head
②	Rotating angle graduation (Free radius position in 360°)
③	Positioning pin part
④	Jaw key
⑤	Height control wrench hole

NO	Part name	Designation
①	Head fixing bolts	BX0618
②	Set screw	BT0404
③	Fixing bolts	BX50630

Designation	ØD	L	L1	L2	L3	L4	L5	B	A	P	Q	G	G1	Torque rate (IN: OUT)	Max RPM	Collet	kg
BT40-KAH7-170	1.0~7.0	190	20	44	71	55	20	19	65	37	24.5	40	96	1: 1	5,000	GER11	4.6
BT40-KAH10-195	1.0~10.0	220	25	44	71	80	25	28	65	46	32	58	96	1: 1	5,000	GER16	5.8
BT40-KAH13-165	1.0~13.0	193	28	44	71	50	28	35	65	53	35	60	96	1: 1	5,000	GER20	5.7
BT40-KAH20-180	2.0~20.0	218	38	44	71	65	38	50	65	71	49	76	96	1: 1	3,500	GER32	6.7
BT50-KAH07-220	1.0~7.0	240	20	57	54	109	20	19	80	37	24.5	40	96	1: 1	5,000	GER11	9.8
BT50-KAH10-215	1.0~10.0	240	25	57	54	104	25	28	80	46	32	58	96	1: 1	5,000	GER16	10.7
BT50-KAH10-260	1.0~10.0	285	25	57	54	149	25	28	80	46	32	58	96	1: 1	5,000	GER16	11.0
BT50-KAH13-260	1.0~13.0	288	28	57	54	149	28	35	80	53	35	60	96	1: 1	5,000	GER20	11.2
BT50-KAH20-200	2.0~20.0	238	38	57	54	89	38	50	80	71	49	76	96	1: 1	3,500	GER32	11.6
BT50-KAH20-240	2.0~20.0	278	38	57	54	129	38	20	80	71	49	76	96	1: 1	3,500	GER32	12.4

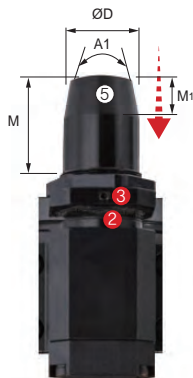


KAC (45° fixed)\_Collet type

# BT-KAC



## Positioning pin



NO	Name
①	Head
②	Rotating angle graduation (Free radius position in 360°)
③	Positioning pin part
④	Jaw key
⑤	Height control wrench hole

NO	Part name	Designation
①	Head fixing bolts	BX0618
②	Set screw	BT0404
③	Fixing bolts	BXS0630

Shank size	M	M1	A1	ØD
BT40	Max: 32 Min: 26	10	20°	Ø19.6
BT50	Max: 35 Min: 29	15	20°	Ø28

Designation	ØD	L	L1	L2	L3	B	G	G1	P	Q	A	Max RPM	Collet	kg
BT50-KAC10-240	1.0~10.0	240	57	54	129	28	60	96	25	54	80	5,000	GER16	9.7
BT50-KAC13-240	1.0~13.0	240	57	54	129	28	60	96	25	54	80	5,000	GER20	10.7
BT50-KAC20-250	2.0~20.0	240	57	54	139	50	72	96	30	60	80	3,500	GER32	11.7



## Zero fit collet

# DZC

### Correcting 10 - 20 $\mu\text{m}$ runout generated at tool tip to 0-2 $\mu\text{m}$

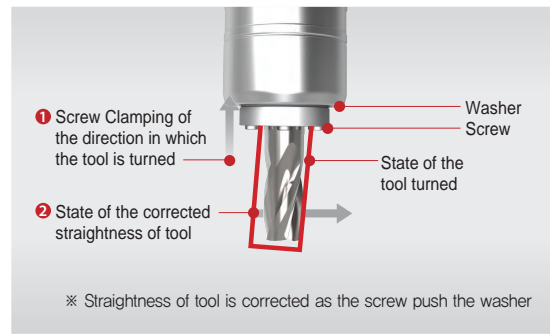
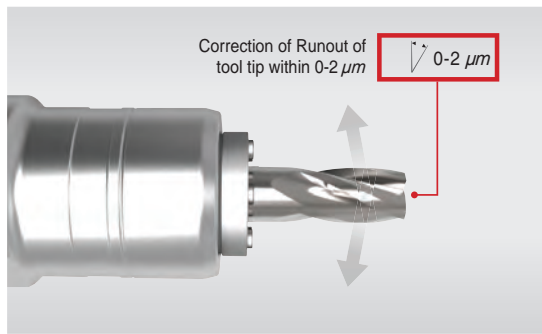
- Improves the runout and straightness of end tools
- Improves the surface roughness and quality of the machining area
- Improves the accuracy of boring hole dimension
- Improves the tool life of end tools



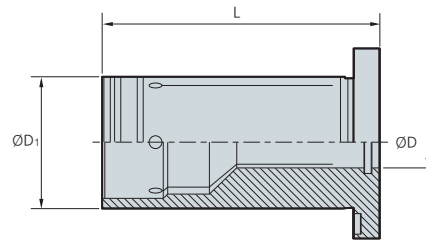
### Code system



### Features



# DZC



(mm)

Designation	ØD	ØD <sub>1</sub>	L
DZC20-6	20	6	56.5
DZC20-8	20	8	56.5
DZC20-10	20	10	56.5
DZC20-12	20	12	56.5
DZC20-14	20	14	56.5
DZC20-16	20	16	56.5
DZC32-6	32	6	67.5
DZC32-8	32	8	67.5
DZC32-10	32	10	67.5
DZC32-12	32	12	67.5
DZC32-16	32	16	67.5
DZC32-20	32	20	67.5
DZC32-25	32	25	67.5

• Through coolant system not available



## Jetcoolant collet (for milling chuck)

# DCJ

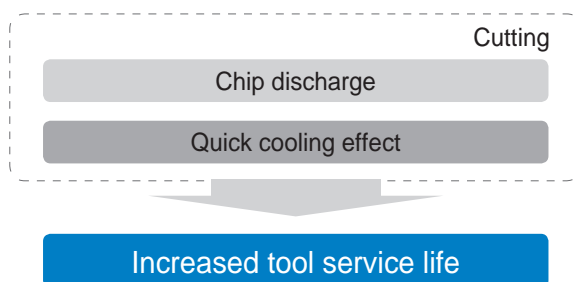
- Ensures a longer service life of cutting tools by preventing chips from adhering to tools
- Improves chip breakability/breaking strong jet injection
- Maintains the performance of the conventional milling chuck
- Enables a fast change of the inside jet coolant by collet replacement
- Available an ultrahigh-pressure inside coolant



Designation	Ø6	Ø8	Ø10	Ø12	Ø16	Ø20	Ø25	Ø32
NPM20	●	●	●	●	●			
NPM32	●	●	●	●	●	●	●	
NPM42	●	●	●	●	●	●	●	●

• Can be used for an ultrahigh-pressure inside coolant

### ➤ NPM + Jet coolant Collet



### ➤ Easy assembly



※ Can be used by only combining a collet with the conventional chuck (NPM)

### ➤ Coolant type

- Jet coolant



- Inside coolant



### ➤ Chip evacuation



### ➤ Coolant type

	Designation
DCJ20	DCJ20-6
	DCJ20-8
	DCJ20-10
	DCJ20-12
	DCJ20-16
DCJ32	DCJ32-6
	DCJ32-8
	DCJ32-10
	DCJ32-12
	DCJ32-16
	DCJ32-20
	DCJ32-25

**Lock collet for milling chuck**

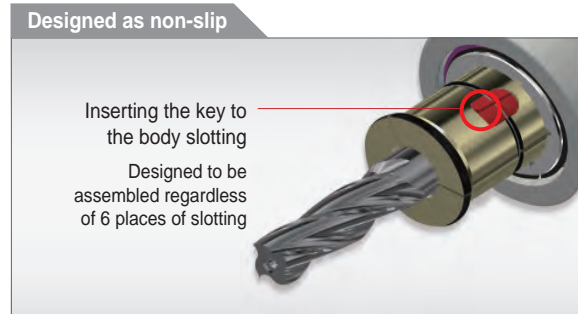
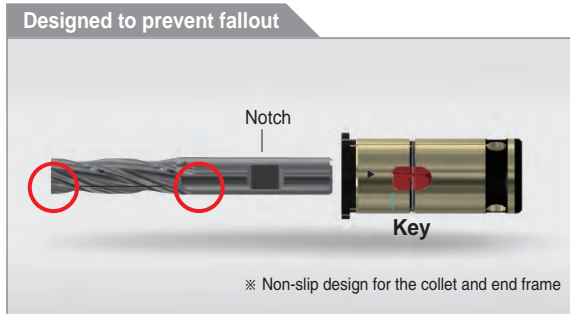
**DCL**

**Milling chuck equipped with anti-fallout feature to prevent poor milling when machining a workpiece and improve tool service life (with DINE's milling chuck)**

- Prevents the tool from falling out due to coolant pressure and vibration
- Useful for working with difficult-to-cut materials that require high workload
- Fit for difficult-to-cut materials with ultralight weight and high hardness in aerospace and automobile industries

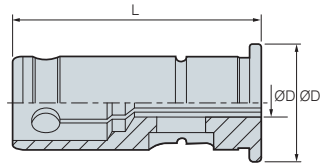


**Features**



- Designed especially for extreme machining with a lot of mechanical actions, prevents the tool from deviating or falling out.
- Weldon flat (DINE 6535HB) end mill used
- Closely adhered to the grooves of the milling chuck - No slip occurring even under high torque

**Detailed Specifications**



(mm)

Designation	ØD	ØD <sub>1</sub>	L	Designation	ØD	ØD <sub>1</sub>	L
DCL20-6	6	20	53	DCL32-10	10	32	64.5
DCL20-8	8	20	53	DCL32-12	12	32	64.5
DCL20-10	10	20	53	DCL32-14	14	32	64.5
DCL20-12	12	20	53	DCL32-16	16	32	64.5
DCL20-14	14	20	53	DCL32-18	18	32	64.5
DCL20-16	16	20	53	DCL32-20	20	32	64.5
DCL32-6	6	32	64.5	DCL32-25	25	32	64.5
DCL32-8	8	32	64.5				

**Parts**

Basic			Basic		
Division	Key	C-Grip	Division	Key	C-Grip
Parts			Parts		
Designation			Designation		
DCL20-6	DCL20-6K	DCL-CG20	DCL32-10	DCL32-10K	DCL-CG32
DCL20-8	DCL20-8K	DCL-CG20	DCL32-12	DCL32-12K	DCL-CG32
DCL20-10	DCL20-10K	DCL-CG20	DCL32-14	DCL32-14K	DCL-CG32
DCL20-12	DCL20-12K	DCL-CG20	DCL32-16	DCL32-16K	DCL-CG32
DCL20-14	DCL20-14K	DCL-CG20	DCL32-18	DCL32-18K	DCL-CG32
DCL20-16	DCL20-16K	DCL-CG20	DCL32-20	DCL32-20K	DCL-CG32
DCL32-6	DCL32-6K	DCL-CG32	DCL32-25	DCL32-25K	DCL-CG32
DCL32-8	DCL32-8K	DCL-CG32			





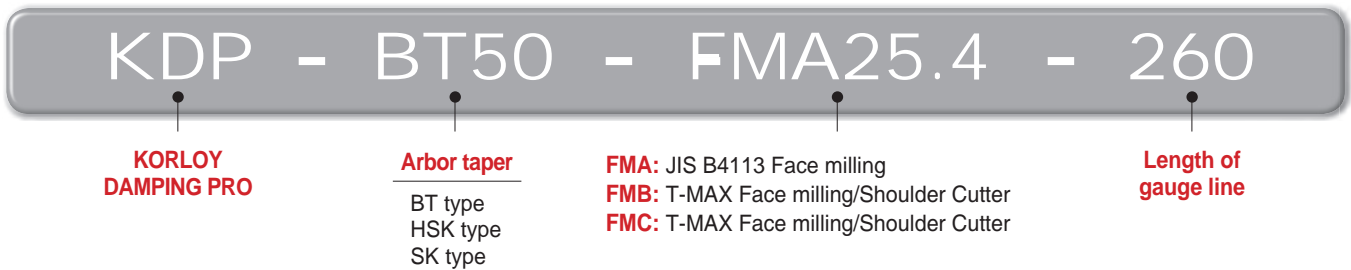


**KORLOY Anti-Vibration tool**

# KORLOY DAMPING PRO

- The application of a special design provides an excellent Anti-Vibration effect and is optimized for Overhang work
- Capable to elevate Feed comparing to standard arbor with stable machining
- Longer tool life and noise decrease
- Provides a solution for Mold, Deep Cavity machining, and Heavy-duty work

**Code system**



**Features**



- Anti-Vibration: Exclusively designed Anti-Vibration structure
- Material: Special alloy steel
- Anti-Vibration body: Application of high density damper
- Overhang: Capable for 2D~5D
- Coolant: Inner coolant is capable



BT type



HSK type

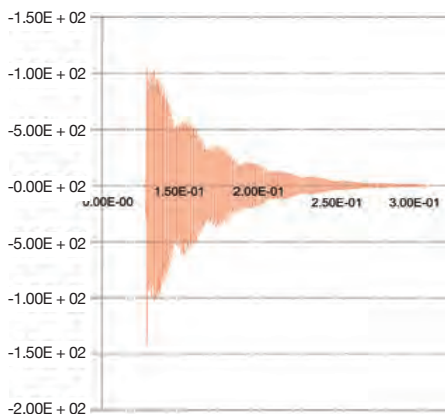
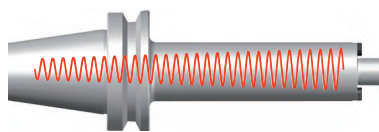


SK type

Various types and sizes are applicable

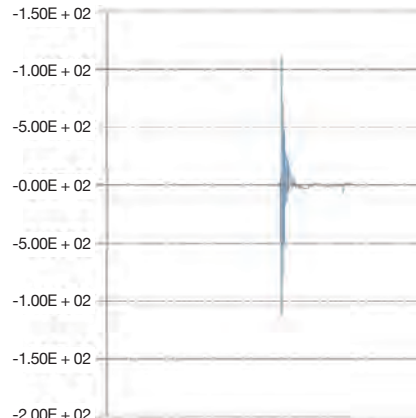
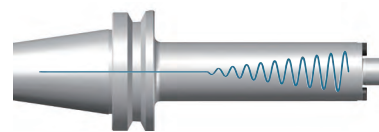
**Comparison of vibration damping time**

Standard Arbor



Longer Vibration damping time/  
Chattering is caused while Overhang work

KORLOY DAMPIG PRO



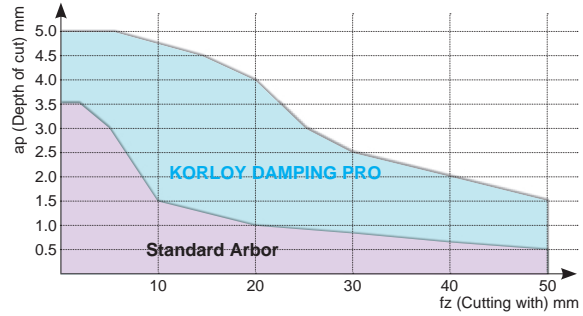
Short Vibration damping time/  
Performance is 2~3 times better than standard arbor



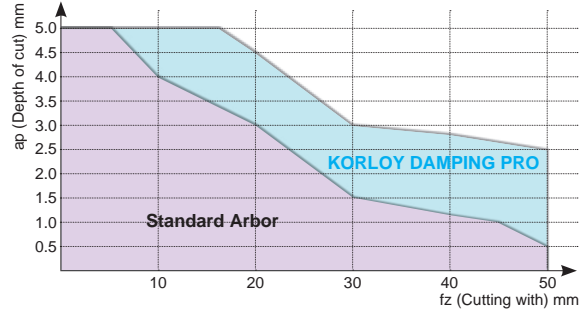


## Performance evaluation

- **Cutting condition:**  $fz$  (mm/t) = 0.1  
 $vc$  (m/min) = 100
- **Cutter:** AMC4063HS 6flute
- **Arbor:** BT50-FMC22-210 General arbor  
KDP-BT50-FMC22-210 Damping pro



- **Cutting condition:**  $fz$  (mm/t) = 0.1  
 $vc$  (m/min) = 100
- **Cutter:** FMRC3063HRD-H 6flute
- **Arbor:** BT50-FMC22-210 General arbor  
KDP-BT50-FMC22-210 Damping pro

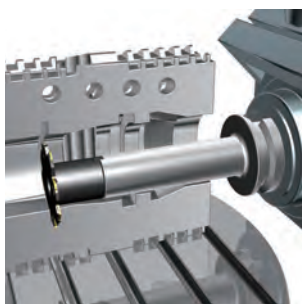


## Application examples

Mold machining	Side milling cutter machining	Facing for long depth	Deep-hole Boring machining
Better productivity than general arbor	Excellent performance in the deep grooving	Better productivity and surface roughness than general arbor	Better surface roughness and machinability than general arbor

### Side milling cutter machining example

- Faulty occurrence on size and surface roughness by the vibration, when use the general arbor
- **Using DAMPING PRO, good size and surface roughness**



- **General arbor**  
Cutting condition:  
 $vc$  (m/min) = 50  
 $fz$  (mm/t) = 0.1  
 $ae$  (mm) = 20
- **DAMPING PRO**  
Cutting condition:  
 $vc$  (m/min) = 100  
 $fz$  (mm/t) = 0.1  
 $ae$  (mm) = 20

### Big size Crankshaft machining example

- General arbor:  $ap$  = 2 mm
- KORLOY DAMPING PRO:  $ap$  = 4mm available
- **2 times better productivity**



- **General arbor**  
Cutting condition:  
 $vc$  (m/min) = 100  
 $fz$  (mm/t) = 0.15  
 $ap$  (mm) = 2
- **DAMPING PRO**  
Cutting condition:  
 $vc$  (m/min) = 100  
 $fz$  (mm/t) = 0.15  
 $ap$  (mm) = 4

# BT-FMA

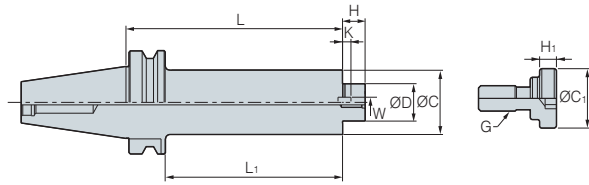


Fig. 1

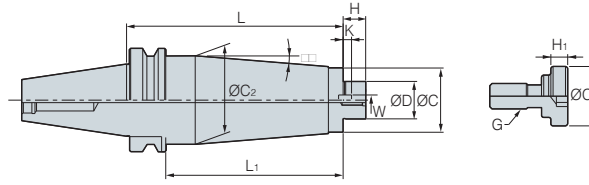








Fig. 2

(mm)

Designation	Cutter dia.	ØD	L	L <sub>1</sub>	ØC	ØC <sub>2</sub>	H	W	K	G	ØC <sub>1</sub>	H <sub>1</sub>	 kg	Fig.	α°	
<b>KDP-BT40 -</b>	<b>FMA25.4-210</b>	80	25.4	210	183	50	60	22	9.5	5	M12	33	10	5.42	2	1
	<b>FMA25.4-260</b>	80	25.4	260	233	50	60	22	9.5	5	M12	33	10	6.5	2	1.1
	<b>FMA31.75-210</b>	100	31.75	210	183	60	-	30	12.7	7	M16	40	10	5.94	1	-
	<b>FMA31.75-260</b>	100	31.75	260	233	60	-	30	12.7	7	M16	40	10	7.25	1	-
<b>KDP-BT50 -</b>	<b>FMA25.4-210</b>	80	25.4	210	172	50	78	22	9.5	5	M12	33	10	9.63	2	4
	<b>FMA25.4-260</b>	80	25.4	260	222	50	78	22	9.5	5	M12	33	10	11.8	2	3
	<b>FMA31.75-210</b>	100	31.75	210	172	60	85	30	12.7	7	M16	40	10	11.8	2	3
	<b>FMA31.7-260</b>	100	31.75	260	222	60	85	30	12.7	7	M16	40	10	13.6	2	2.5

- The A type is for JIS B4113 Face milling
- The B type and C type are arbors for T-MAX Face Milling and shoulder cutter
- The weight (kg) shown in the chart does not include the weight of face cutter
  - Key and screw are clamped
  - Wrench is separately sold

## Parts

Division	Basic				For separate purchase
	Key	Clamp bolt	Wrench bolt	Wrench bolt	Wrench
<b>Parts</b>					
<b>Designation</b>					
<b>FMA25.4</b>	K9.5 (B)	MBA-M12	BX0412	BX1225	LW-10
<b>FMA31.75</b>	K12.7 (D)	MBA-M16	BX0515	-	LW-14

## BT-FMC

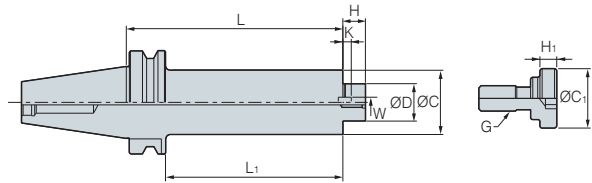


Fig. 1

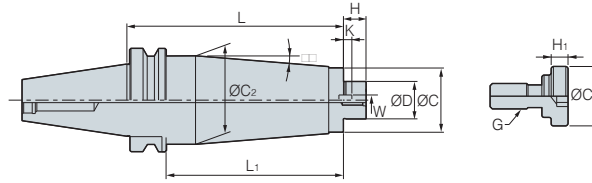








Fig. 2

(mm)

Designation	Cutter dia.	ØD	L	L <sub>1</sub>	ØC	ØC <sub>2</sub>	H	W	K	G	 kg	Fig.	α°	
KDP-BT40 -	FMC16-160	40	16	160	133	38	-	17	8	5	M8	2.45	1	-
	FMC22-210	50/63	22	210	183	48	4.95	19	10	5.6	M10	4.37	2	0.1
	FMC22-260	50/63	22	260	233	48	60	19	10	5.6	M10	6.3	2	1.5
	FMC27-210	80	27	210	183	60	-	21	12	6.3	M12	6	1	-
	FMC27-260	80	27	260	233	60	-	21	12	6.3	M12	7.25	1	-
KDP-BT50 -	FMC16-171	40	16	171	133	38	-	17	8	5	M8	5.1	1	-
	FMC22-210	50/63	22	210	172	48	49.5	19	10	5.6	M10	7.3	2	0.1
	FMC22-260	50/63	22	260	222	48	62	19	10	5.6	M10	10	2	1
	FMC27-210	80	27	210	172	60	78	21	12	6.3	M12	10.6	2	2.5
	FMC27-260	80	27	260	222	60	78	21	12	6.3	M12	12.6	2	2
	FMC27-320	80	27	320	282	60	78	21	12	6.3	M12	14.8	2	1
	FMC32-210	100	32	210	172	78	-	24	14	7	M16	11.7	1	-
	FMC32-260	100	32	260	222	78	-	24	14	7	M16	14.2	1	-
FMC32-330	100	32	330	292	78	-	24	14	7	M16	16.6	1	-	

- The A type is for JIS B4113 Face milling
- The B type and C type are arbors for T-MAX Face Milling and shoulder cutter
- The weight (kg) shown in the chart does not include the weight of face cutter
  - Key and screw are clamped
  - Wrench is separately sold

### Parts

Division	Basic				For separate purchase
	Key	Clamp bolt	Wrench bolt	Wrench bolt	Wrench
Parts					
Designation					
FMC16	K8.0 (A)	-	BX0310	BX0820	LW-6
FMC22	K10.0 (C)	-	BX0412	BX1030	LW-8
FMC27	K12.0	MBA-M12	BX0616	-	LW-10
FMC32	K14.0	MBA-M16	BX0820	-	LW-14



# HSK-FMA

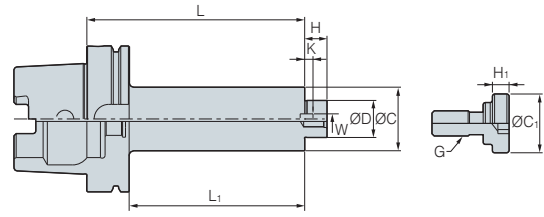


Fig. 1

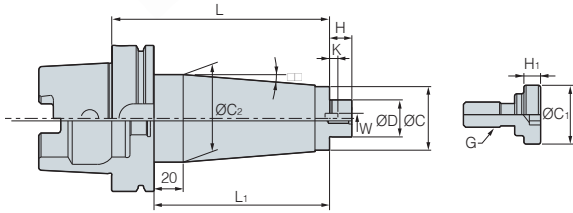


Fig. 2

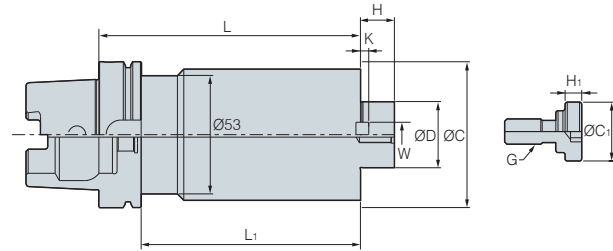


Fig. 3

(mm)

Designation	Cutter dia.	ØD	L	L <sub>1</sub>	ØC	ØC <sub>2</sub>	H	W	K	G	ØC <sub>1</sub>	H <sub>1</sub>	$\frac{kg}{mm^3}$	Fig.	$\alpha^\circ$	
KDP-HSK63 -	FMA25.4-210	80	25.4	210	184	50	53	22	9.5	5	M12	33	10	4.55	3	0.1
	FMA25.4-260	80	25.4	260	234	50	53	22	9.5	5	M12	33	10	5.6	3	0.1
	FMA31.75-210	100	31.75	210	184	60	-	30	12.7	7	M16	40	10	5.52	2	-
	FMA31.75-260	100	31.75	260	234	60	-	30	12.7	7	M16	40	10	6.9	2	-
KDP-HSK100 -	FMA25.4-210	80	25.4	210	181	50	78	22	9.5	5	M12	33	10	8.32	3	4
	FMA25.4-260	80	25.4	260	231	50	78	22	9.5	5	M12	33	10	10.5	3	3
	FMA31.75-210	100	31.75	210	181	60	85	30	12.7	7	M16	40	10	10.9	3	3
	FMA31.75-260	100	31.75	260	231	60	85	30	12.7	7	M16	40	10	12.8	3	2.5

- The A type is for JIS B4113 Face milling
- The B type and C type are arbors for T-MAX Face Milling and shoulder cutter
- The weight (kg) shown in the chart does not include the weight of face cutter
  - Key and screw are clamped
  - Wrench is separately sold

## Parts

Division	Basic				For separate purchase
	Key	Clamp bolt	Wrench bolt	Wrench bolt	Wrench
Parts					
Designation					
FMA25.4	K9.5 (B)	MBA-M12	BX0412	BX1230	LW-10
FMA31.75	K12.7 (D)	MBA-M16	BX0515	-	LW-14



# HSK-FMC

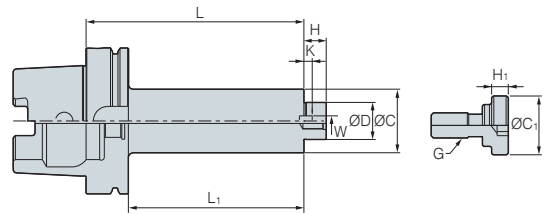


Fig. 1

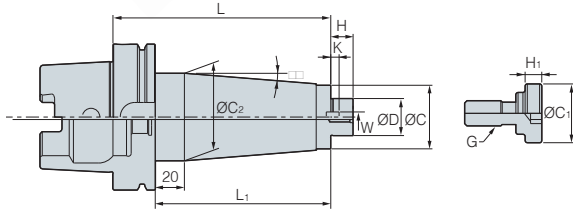


Fig. 2

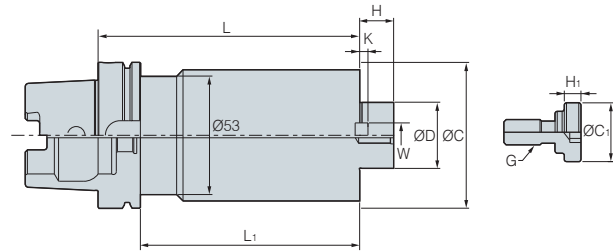


Fig. 3

(mm)

Designation	Cutter dia.	ØD	L	L <sub>1</sub>	ØC	ØC <sub>2</sub>	H	W	K	G	kg	Fig.	α°	
<b>KDP-HSK63 -</b>	<b>FMC16-160</b>	40	16	160	134	38	-	17	8	5	M8	2.10	1	-
	<b>FMC22-210</b>	50/63	22	210	184	48	4.95	19	10	5.6	M10	3.82	1	0.1
	<b>FMC22-260</b>	50/63	22	260	234	48	62	19	10	5.6	M10	6.14	3	1.6
	<b>FMC27-210</b>	80	27	210	184	60	-	21	12	6.3	M12	5.53	2	-
	<b>FMC27-260</b>	80	27	260	234	60	-	21	12	6.3	M12	6.83	2	-
<b>KDP-HSK100 -</b>	<b>FMC16-160</b>	40	16	160	131	38	-	17	8	5	M8	3.45	1	-
	<b>FMC22-210</b>	50/63	22	210	181	48	49.5	19	10	5.6	M10	4.60	3	0.1
	<b>FMC22-260</b>	50/63	22	260	231	48	62	19	10	5.6	M10	8.10	3	1
	<b>FMC27-210</b>	80	27	210	181	60	78	21	12	6.3	M12	8.44	3	2.5
	<b>FMC27-260</b>	80	27	260	231	60	78	21	12	6.3	M12	10.40	3	2
	<b>FMC27-320</b>	80	27	320	291	60	78	21	12	6.3	M12	13.60	3	1
	<b>FMC32-210</b>	100	32	210	181	78	-	24	14	7	M16	10.20	1	-
	<b>FMC32-260</b>	100	32	260	231	78	-	24	14	7	M16	13.00	1	-
	<b>FMC32-330</b>	100	32	330	301	78	-	24	14	7	M16	15.43	1	-

- The A type is for JIS B4113 Face milling
- The B type and C type are arbors for T-MAX Face Milling and shoulder cutter
- The weight (kg) shown in the chart does not include the weight of face cutter
- Key and screw are clamped
- Wrench is separately sold

## Parts

Division	Basic				For separate purchase
	Key	Clamp bolt	Wrench bolt	Wrench bolt	Wrench
<b>Parts</b>					
<b>Designation</b>					
<b>FMC16</b>	K8.0 (A)	-	BX0310	BX0820	LW-6
<b>FMC22</b>	K10.0 (C)	-	BX0412	BX1030	LW-8
<b>FMC27</b>	K12.0	MBA-M12	BX0616	-	LW-10
<b>FMC32</b>	K14.0	MBA-M16	BX0820	-	LW-14



# SK-FMC

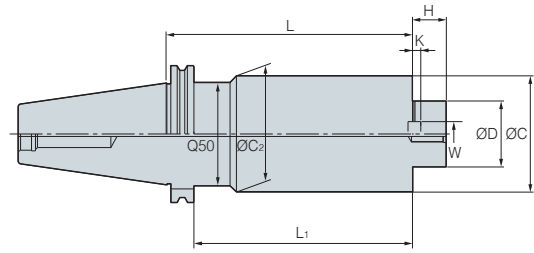


Fig. 1

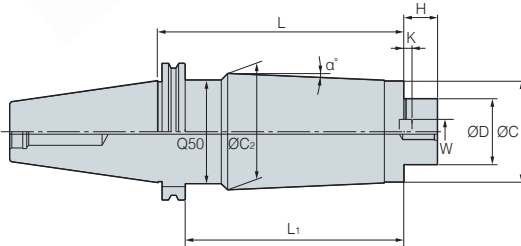


Fig. 2

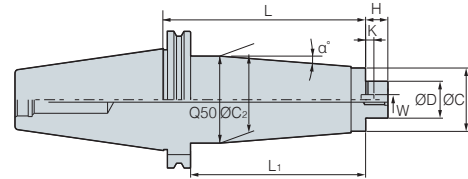


Fig. 3

(mm)

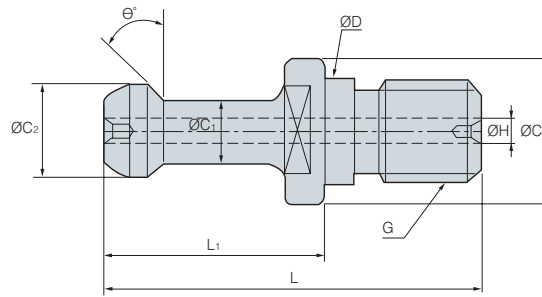
Designation	Cutter dia.	ØD	L	L <sub>1</sub>	ØC	ØC <sub>2</sub>	H	W	K	G	kg	Fig.	α°	
KDP-SK40 -	FMC22-210	50/63	22	210	183.0	48	49.5	19	10	4.4	M10	4.4	3	0.1
	FMC22-260	50/63	22	260	233.0	48	60	19	10	5.6	M10	6.2	2	1.4
	FMC27-210	80	27	210	183.0	60	60	21	12	6.3	M12	5.9	1	-
	FMC27-260	80	27	260	233.0	60	60	21	12	6.3	M12	7.2	1	-
KDP-SK50 -	FMC22-210	50/63	22	210	190.9	48	49.5	19	10	5.6	M10	6.4	3	0.1
	FMC22-260	50/63	22	260	240.9	48	62	19	10	5.6	M10	9.1	3	1
	FMC27-210	80	27	210	190.9	60	78	21	12	6.3	M12	9.8	3	2.5
	FMC27-260	80	27	260	240.9	60	78	21	12	6.3	M12	12.4	3	1.8
	FMC27-320	80	27	320	300.9	60	78	21	12	6.3	M12	14.5	3	1.2
	FMC32-210	100	32	210	190.9	78	-	24	14	7	M16	11.5	1	-
	FMC32-260	100	32	260	240.9	78	-	24	14	7	M16	14	1	-
	FMC32-330	100	32	330	310.9	78	-	24	14	7	M16	16.4	1	-

- The A type is for JIS B4113 Face milling
- The B type and C type are arbors for T-MAX Face Milling and shoulder cutter
- The weight (kg) shown in the chart does not include the weight of face cutter
  - Key and screw are clamped
  - Wrench is separately sold

## Parts

Division	Basic				For separate purchase
	Key	Clamp bolt	Wrench bolt	Wrench bolt	Wrench
Parts					
Designation					
FMC16	K8.0 (A)	-	BX0310	BX0820	LW-6
FMC22	K10.0 (C)	-	BX0412	BX1030	LW-8
FMC27	K12.0	MBA-M12	BX0616	-	LW-10
FMC32	K14.0	MBA-M16	BX0820	-	LW-14

# Pull Stud Bolt



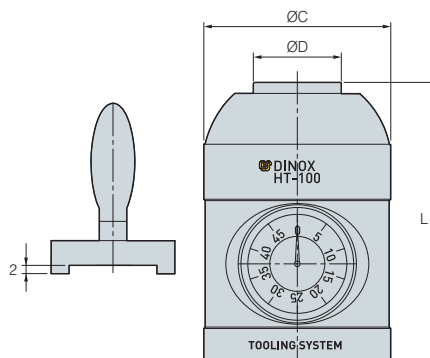
(mm)

Designation	ØD	ØC	ØC <sub>1</sub>	ØC <sub>2</sub>	L <sub>1</sub>	L	θ	G	ØH
P20T-1	8.5	12	6	8.5	17.5	31.5	15°	M8	
P30T-1	12.5	16.5	7	11	23	43	45°	M12	
P30T-1(Ø2.5)	12.5	16.5	7	11	23	43	45°	M12	Ø2.5
P30T-2	12.5	16.5	7	11	23	43	30°	M12	
P30T-2(Ø2.5)	12.5	16.5	7	11	23	43	30°	M12	Ø2.5
P40T-1	17	23	10	15	35	60	45°	M16	
P40T-1(3)	17	23	10	15	35	60	45°	M16	Ø3
P40T-2	17	23	10	15	35	60	30°	M16	
PS40-3F	17	23	10	15	35	60	0°	M16	
PS-G51	17	22	12.45	18.8	19.11	44.11	45°	M16	Ø7
DIN69872-A40	17	23	14	19	26	54	15°	M16	Ø7
DIN69872-B40	17	23	14	19	26	54	15°	M16	
JISB6339-A40(PS-806)	17	23	14	19	29	54	15°	M16	Ø7
JISB6339-B40(PS-805)	17	23	14	19	29	54	15°	M16	
P50T-1	25	38	17	23	45	85	45°	M24	
P50T-1(7)	25	38	17	23	45	85	45°	M24	Ø7
P50T-2	25	38	17	23	45	85	30°	M24	
PS50-1F	25	38	17	23	45	85	0°	M24	
PS50-1FH	25	38	17	23	45	85	0°	M24	Ø8
PS-G41	25	37	20.83	28.96	25.2	65.2	45°	M24	Ø10
DIN69872-A50	25	36	21	28	34	74	15°	M24	Ø11.5
P50T-1HS	25	38	17	23	45	85	45°	M24	Ø5.7





# HT



(mm)

Designation	ØD	ØC	L
HT-100	32	68	100

- Good for setting the Tool length at CNC machine
- No inturference between height Touch setter and Tool makes safe work
- Location Accuracy:  $\pm 0.003$  mm





# PARTS





## Parts

<b>H02</b>	Shim
<b>H03</b>	Cartridge
<b>H03</b>	Chip Breaker
<b>H03</b>	Chip Cover
<b>H03</b>	Clamp
<b>H04</b>	Coolant Bolt
<b>H04</b>	Wrench Bolt
<b>H04</b>	Lever
<b>H05</b>	Locator
<b>H05</b>	Nut
<b>H05</b>	Pin
<b>H05</b>	Screw
<b>H06</b>	Shim Pin
<b>H07</b>	Spring
<b>H07</b>	Wrench
<b>H07</b>	Stop Ring
<b>H07</b>	Washer
<b>H07</b>	Stopper
<b>H07</b>	Nozzle

Geometry	Designation	Dimensions					
		a	b	c	d	angle	
	<b>SC32</b>	8.5	3.18		4.9		
	<b>SC32N</b>	8.5	3.18		4.88		
	<b>SC42</b>	12.5	3.18		6.9		
	<b>SC42N</b>	11.6	3.18		6.5		
	<b>SC53</b>	15.7	4.76		7.9		
	<b>SC53N</b>	14.6	4.76		8.11		
	<b>SC63</b>	18.85	4.76		10		
	<b>SC63N</b>	17.8	4.76		9.6		
	<b>SC83</b>	24.4	4.76		12.8		
	<b>SC84N</b>	24.2	6.35		13		
	<b>SC42B</b>	12.5	3.18		6.9		
		<b>SC42CC</b>	12.5	3.18		3.5	
		<b>SC32D</b>	9.27	3.18		6.48	
		<b>SC43D</b>	12.45	4.76		7.34	
		<b>SC53D</b>	15.62	4.76		9.65	
		<b>SC63D</b>	18.8	4.76		11.25	
		<b>SC84D</b>	25.08	6.35		14.85	
		<b>SC42S</b>	11.5	3.18		6.4	
		<b>SC32S</b>	8.3	3.18		5.4	
			<b>SC63V</b>	18.35	4.76		5.5
<b>SC83V</b>			25.3	4.76		6.55	
<b>SC84V</b>	25.3		6.35		6.35		
<b>SC32V</b>	9.12		3.18		3.4		
<b>SC42V</b>	12.6		3.18		4.5		
<b>SC44V</b>	12.6		6.35		4.5		
<b>SC54V</b>	15.75		6.35		5.5		
<b>SS32V</b>	9.12		3.18		3.4		
<b>SS42V</b>	12.6		3.18		4.5		
<b>SS54V</b>	15.75		6.35		5.5		
<b>SS64V</b>	18.9	6.35		5.5			
	<b>SD317</b>	9.35	2.7		5.2		
	<b>SD32N</b>	8.5	3.18		4.88		
	<b>SD42</b>	12.5	3.18		6.9		
	<b>SD42N</b>	11.6	3.18		6.5		
	<b>SD43N</b>	11.6	4.75		6.5		
	<b>SD32D</b>	9.2	3.18		5.8		
	<b>SD43D</b>	12.45	4.76		7.34		
	<b>SD32S</b>	8.5	3.18		5.4		
	<b>SD42S</b>	11.5	3.18		6.4		
	<b>SD32V</b>	9.12	3.18		3.4		
	<b>SD43V</b>	12.6	4.76		4.5		
	<b>SD44V</b>	12.6	6.35		4.5		

Geometry	Designation	Dimensions				
		a	b	c	d	angle
	<b>SES33C</b>	9.1	12	4.76	3.5	
		<b>SK33C</b>	9.33	14.7	4.8	3.5
<b>SK33CL</b>		9.33	14.7	4.8	3.5	
	<b>SR10</b>	8.4	3.18		4.7	
	<b>SR12</b>	10	3.18		4.7	
	<b>SR16</b>	13.55	4.76		6.9	
	<b>SR20</b>	17.1	4.85		7.9	
	<b>SR25</b>	22	6.35		9.6	
	<b>SR32</b>	27.8	6.35		13	
	<b>SR42CC</b>	12.575	3.18		3.5	
	<b>SR10S</b>	8.8	3.18		5.4	
	<b>SR12S</b>	10.55	3.18		5.4	
	<b>SS32</b>	8.5	3.18		4.9	
	<b>SS32N</b>	8.5	3.18		4.88	
	<b>SS42</b>	12.5	3.18		6.9	
	<b>SS42B</b>	12.5	3.18		6.9	
	<b>SS42N</b>	11.6	3.18		6.5	
	<b>SS53</b>	15.7	4.76		7.9	
	<b>SS53N</b>	14.6	4.76		8.11	
	<b>SS63</b>	18.85	4.76		10	
	<b>SS63N</b>	17.8	4.76		9.6	
	<b>SS84</b>	24.4	6.35		12.8	
	<b>SS84N</b>	24.2	6.35		13	
	<b>SS42CC</b>	12.5	3.18		3.5	
	<b>SS32CC</b>	9.3	3.18		3.5	
	<b>SS32D</b>	9.27	3.18		5.77	
	<b>SS43D</b>	12.45	4.76		7.34	
	<b>SS53D</b>	15.62	4.76		9.65	
	<b>SS63D</b>	18.8	4.76		11.25	
	<b>SS84D</b>	25.15	6.35		14.43	
	<b>SS32S</b>	8.3	3.18		5.4	
	<b>SS42S</b>	11.5	3.18		6.4	
	<b>SS42SAF</b>	11.2	3		5.5	
		<b>ST317</b>	9.35	2.7		5
<b>ST317B</b>		9.35	2.7		5	
<b>ST317N</b>		8.5	2.7		4.88	
<b>ST42</b>		12.5	3.18		6.9	
<b>ST42N</b>		11.6	3.18		6.5	
<b>ST53</b>	15.7	4.76		7.9		



**Shim**

Geometry	Designation	Dimensions				
		a	b	c	d	angle
	<b>ST32CC</b>	9.35	3.18		3.5	
	<b>ST32C1</b>	9.13	3.18		4.95	
	<b>ST42C1</b>	12.3	3.18		4.95	
	<b>ST32D</b>	9.35	3.18		5.77	
	<b>ST43D</b>	12.52	4.76		7.34	
	<b>ST53D</b>	15.7	4.76		9.65	
	<b>ST63D</b>	18.87	4.76		11.25	
	<b>ST32M</b>	8.7	3.18		4.7	
	<b>ST43M</b>	12.5	4.76		6.3	
	<b>ST32S</b>	8.5	3.18		5.4	
	<b>ST32V</b>	9.12	3.18		3.4	
	<b>ST44V</b>	12.6	6.35		4.5	
	<b>SV32D</b>	9.2	3.18		5.8	
	<b>SV43D</b>	12.29	4.76		7.34	
	<b>SV32D2</b>	9.2	3.18		5.8	
	<b>SV32S</b>	8.4	3.18		5.4	
	<b>SW317</b>	9.35	2.7		5	
	<b>SW317N</b>	8.5	2.7		4.88	
	<b>SW42</b>	12.5	3.18		6.9	
	<b>SW42N</b>	11.6	3.18		6.5	
	<b>SW32D</b>	9.25	3.18		5.8	
	<b>SW43D</b>	12.45	4.76		7.34	
	<b>SW53D</b>	15.62	4.76		9.65	
	<b>SW63D</b>	18.8	4.76		11.25	
	<b>SW84D</b>	24.89	6.35		14.43	
	<b>SW43M</b>	12.5	4.76		6.2	
	<b>SW32M</b>	8.52	3.18		5.2	
	<b>SW32V</b>	9.12	3.18		3.4	
	<b>SW44V</b>	12.6	6.35		4.5	
	<b>SW54V</b>	15.75	4.76		5.5	

**Cartridge**

Geometry	Designation	Dimensions				
		a	b	c	d	angle
	<b>LAPDR-AJ</b>	M4x0.7	30	15	10	

**Chip breaker**

Geometry	Designation	Dimensions				
		a	b	c	d	angle
	<b>CB20</b>	8.5	3.4	20		

**Chip cover**

Geometry	Designation	Dimensions				
		a	b	c	d	angle
	<b>CFMP3R14R1-A</b>	10.5	20	1	(Ø4.3)	
	<b>CFMP3R-A</b>	8	18	1	(Ø4.3)	
	<b>CFMP4R-A</b>	8	22	1	(Ø4.3)	

**Clamp**

Geometry	Designation	Dimensions				
		a	b	c	d	angle
	<b>CA05R</b>	8.9	5.5	17.6	3.3	
	<b>CA06R</b>	12	7.2	20.6	5.3	
	<b>CH5R3</b>	7.85	7.2	14.8	3.1	
	<b>CH6R4</b>	12.02	9	23.97	3.75	
	<b>CBH4.5R1</b>	8	5.74	17.7	4	
	<b>CBH4.5R2</b>	9.5	6.4	18	4	
	<b>CBH5R1</b>	10	7.8	21.3	5	
	<b>CBH6R1</b>	12	9.3	26	6	
	<b>CDH6N</b>	9.5	10	18.6	6.1	
	<b>CDH7N</b>	7.9	11.4	14.7	4.7	
	<b>CDH8N</b>	10.9	16.9	22.4	6.1	
	<b>CDH8N1</b>	10.9	16.9	19.1	6.1	
	<b>CDH8N2</b>	10.9	16.9	25.4	6.1	
	<b>CDH8N3</b>	12.5	19.8	25.4	9.2	
	<b>CDS8N</b>	10.8	17	22.2	5	
	<b>CGH5R1</b>	19.5	9.5	28.8	2.5	
	<b>CGH5R2</b>	20.5	9.5	28.8	3.5	
	<b>CGH5R3</b>	22.5	9.5	28.8	5.5	



## Clamp

Geometry	Designation	Dimensions				
		a	b	c	d	angle
	<b>CGH6R1</b>	22.3	11.9	23.2	2.5	
	<b>CGH6R2</b>	23.2	11.9	23.2	3.4	
	<b>CGH6R3</b>	24.0	11.9	23.2	4.2	
	<b>CHH3.5R1</b>	7.5	6.7	13	2.45	
	<b>CHH4.5R1</b>	7.9	7.85	14.1	2.54	
	<b>CHH5.5R1</b>	9.8	10	16.4	4	
	<b>CH4R1</b>	7.4	5	14.1	3.1	
	<b>CH5R1</b>	10.0	6.6	20.2	4.5	
	<b>CH5R2</b>	6.85	7	13.8	2	
	<b>CH6R2</b>	8.85	8.7	16.5	2	
	<b>CH6R3</b>	11.8	10	23	4.2	
	<b>CMH5R1</b>	18.5	7.9	16	6.26	
	<b>CMH6R2</b>	20.0	11	17.5	13.8	
	<b>CMH6R6</b>	18.5	7.9	16	6.26	
	<b>CMH6R1</b>	24	8.5	16.5	8.28	
	<b>CMH6R3</b>	20.0	11	17.51		
	<b>CMH6L3</b>	20.0	11	17.51		
	<b>CS5R1</b>	6.8	7	14.5	2	
	<b>CS6R1</b>	8.8	8.5	18.1	2.7	
	<b>CS8R1</b>	11.8	10	23	4.2	
	<b>CTH6L1</b>	23.5	12	25.4	14.35	
	<b>CTH6R1</b>	23.5	12	25.4	14.35	
	<b>CTH6R2</b>	21.78	12.9	31.22	17.33	
	<b>CVH3</b>	21	11	5.8	7.7	
	<b>CVH3V</b>	29	14	7	8	
	<b>CVH4</b>	25.5	14.5	6	7	
	<b>CVH5</b>	30	17	7.5	9.5	
	<b>CVH6</b>	33.5	18.5	8	10	
	<b>CXH8N</b>	10.1	10.0	17.5	-	

## Coolant bolt

Geometry	Designation	Dimensions					
		a	b	c	d	B(T)	a'
	<b>CBA063-3IN/MM</b>	M10	Ø25	Ø16	37	8	(27)
	<b>CBA063-4IN/MM</b>	M10	Ø25	Ø16	42.5	8	(27)
	<b>CBA080-IN/MM</b>	M12	Ø28	Ø18	45.5	10	(32)
	<b>CBP063-IN/MM</b>	M10	Ø22	Ø16	38.6	8	(27)
	<b>CBP080-IN/MM</b>	M12	Ø25	Ø18	48.6	10	(32)

## Coolant bolt

Geometry	Designation	Dimensions						
		a	b	c	d	B(T)	a'	
	<b>CBA100-IN/MM</b>	M16	Ø54	Ø43	47	14	(32)	
	<b>CBA100-IN-25.4</b>	M12	Ø44	Ø36	41.5	10	(25)	
	<b>CBA125-IN</b>	M20	Ø65	Ø54	56	17	(38)	
	<b>CBA125-IN-25.4</b>	M12	Ø44	Ø36	43.5	10	(25)	
	<b>CBA125-MM</b>	M20	Ø65	Ø54	57	17	(35)	
	<b>CBA160-IN</b>	M24	Ø83	Ø73	56	19	(38)	
	<b>CBA160-MM</b>	M20	Ø83	Ø73	53	17	(34)	
	<b>CBP100-IN</b>	M16	Ø50	Ø43	48.6	14	(32)	
	<b>CBP100-IN-25.4</b>	M12	Ø44	Ø36	46.5	10	(25)	
	<b>CBP100-MM-1</b>	M16	Ø50	Ø43	48.6	14	(36)	
	<b>CBP125-IN</b>	M20	Ø65	Ø54	56	17	(35)	
	<b>CBP125-IN-25.4</b>	M12	Ø44	Ø36	55	10	(28)	
	<b>CBP125-MM</b>	M20	Ø65	Ø54	57	17	(35)	
	<b>CBP125-MM-1</b>	M20	Ø61	Ø54	65.6	14	(33)	
	<b>CBP160-IN</b>	M24	Ø83	Ø73	56	19	(38)	
	<b>CBP160-MM</b>	M20	Ø83	Ø73	53	17	(34)	

## Wrench bolt

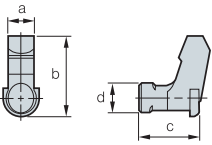
Geometry	Designation	Dimensions				
		A	C	K	L	M
	<b>SB0825</b>	13	6	8	25	M08 x 1.25
	<b>SB1025</b>	16	8	10	25	M10 x 1.50
	<b>SB1035</b>	16	8	10	35	M10 x 1.50
	<b>SB1230</b>	18	10	12	30	M12 x 1.75
	<b>SB1630</b>	24	14	16	30	M16 x 2.0
	<b>SB1645</b>	24	14	16	45	M6 x 2.0
	<b>SB2040</b>	30	17	20	40	M20 x 2.5
	<b>CB1025</b>	13	6	8	25	M08x1,25
	<b>CB1025</b>	16	8	10	25	M10x1,50
	<b>CB1035</b>	16	8	10	35	M10x1,50
	<b>CB1230</b>	18	10	12	30	M12x1,75
	<b>CB1245</b>	18	10	12	45	M12x1,75
	<b>CB1630</b>	24	14	16	30	M16x2,0
	<b>CB1645</b>	24	14	16	45	M16x2,0
	<b>CB2040</b>	30	17	20	40	M20x2,5

## Lever

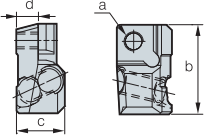
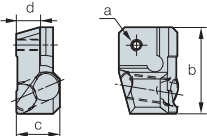
Geometry	Designation	Dimensions			
		a	b	c	d
	<b>LR10</b>	3.4	10.8	11.7	3
	<b>LR12</b>	3.7	13.5	13.4	3.5
	<b>LR16</b>	4.75	18.7	18.3	4.3
	<b>LR20</b>	5.9	20.5	18.7	5.55
	<b>LR25</b>	7.35	24.25	23.7	6.2
	<b>LR32</b>	8.45	29.7	26.95	7.9
	<b>LV2</b>	2.6	7.75	6	2.1
	<b>LV3B</b>	3.1	10	9.5	3.7
	<b>LV4B</b>	4.7	14.55	15.6	4.7
	<b>LV4BN</b>	4.7	16	14.9	4.68
	<b>LV3</b>	3.7	10	12	3.6
	<b>LV3N</b>	3.75	10	12	3.55
	<b>LV3AN</b>	3.75	12.1	11.4	4.64
	<b>LV3C</b>	3.1	10	7.85	3.6
	<b>LV3CN</b>	3.2	10	7.8	3.6
	<b>LV3DN</b>	3.2	11.65	9.5	3.55
	<b>LV4</b>	4.7	14.55	14	4.7
	<b>LV4N</b>	4.7	13.45	13.2	4.68
	<b>LV5</b>	6	17.1	17	6
	<b>LV5N</b>	6	16.4	17.08	5.95
<b>LV5AN</b>	6	18.82	17.3	5.95	
<b>LV6N</b>	7.5	20.5	21	7.6	
<b>LV8N</b>	8.6	25.5	25.4	8.6	



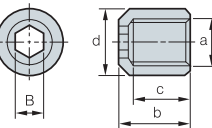
**Lever**

Geometry	Designation	Dimensions			
		a	b	c	d
	<b>LV4A</b>	4.6	13.24	9.95	4.7
	<b>LV4AN</b>	4.7	13.3	10	4.68

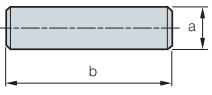
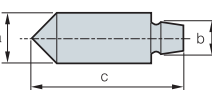
**Locator**

Geometry	Designation	Dimensions			
		a	b	c	d
	<b>LFMP3R-A</b>	M3.5	18.7	10.1	4.6
	<b>LFMP4R1-A</b>	M4.5	24.3	13.8	6.2
	<b>LFMP4R-A</b>	M4.5	26.3	13.8	6.2
	<b>LFMA3R-A</b>	M3	18.5	9.5	4.8
	<b>LFMA4R-A</b>	M3.5	26	13.1	7.3

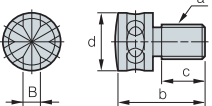
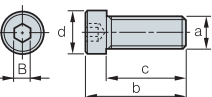
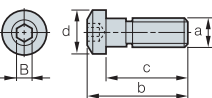
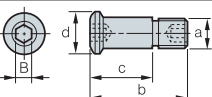
**Nut**

Geometry	Designation	Dimensions					
		a	b	c	d	B(T)	a'
	<b>N0407</b>	M4 X 0.7	7.5	6	7	3	
	<b>N0508</b>	M5 X 0.8	8.3	6.6	7	3	

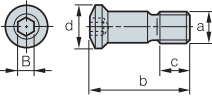
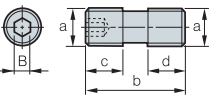
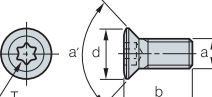





**Pin**

Geometry	Designation	Dimensions		
		a	b	c
	<b>PN0308</b>	3.0	8	
	<b>PN0310</b>	3.0	10	
	<b>PN0312</b>	3.0	12	
	<b>PN0314</b>	3.0	14	
	<b>PN0515</b>	4.8	3.3	14.5

**Screw**

Geometry	Designation	Dimensions					
		a	b	c	d	B(T)	a'
	<b>AZ0508F</b>	M5 X 0.5	13	8	9	Ø2	
	<b>AZ0514</b>	M5 X 0.8	14	7	9	Ø2.5	
	<b>BHA0510</b>	M5 X 0.8	15	10	8.5	4.0	
	<b>BHA0512</b>	M5 X 0.8	17	12	8.5	4.0	
	<b>BHA0612</b>	M6 X 1.0	18	12	10	5.0	
	<b>BHA0614</b>	M6 X 1.0	20	14	10	5.0	
	<b>BHA0616</b>	M6 X 1.0	22	16	10	5	
	<b>BHA0619-NYLOK</b>	M6 X 1.0	25	19	10	5	
	<b>CHX0407</b>	M4 X 0.7	9.5	7.36	5.7	2.5	
	<b>CHX0415</b>	M4 X 0.7	17.5	15	5.4	2.5	
	<b>CHX0510</b>	M5 X 0.8	13.1	10.1	7.7	3	
	<b>CHX0518</b>	M5 X 0.8	21.5	18	8	3	
	<b>CHX0622</b>	M6 X 1.0	26.5	22	10	4	
	<b>CHX0513</b>	M5 X 0.8	13	8	6.4	2.5	
	<b>CHX0616</b>	M6 X 1.0	16.2	10.1	8.5	3	
	<b>CHX0617L</b>	M6 x 1.0 (ø4.4)	17.2	10.1	8.5	3	
	<b>CHX0621</b>	M6 X 1.0	21	10.1	8.5	3	

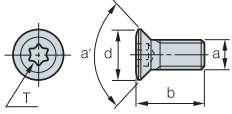
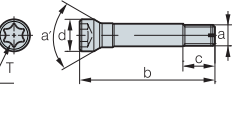
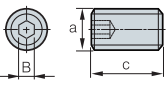
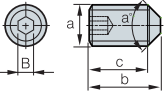
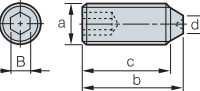
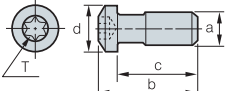
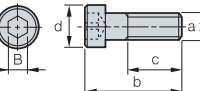
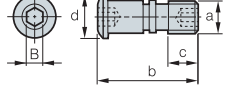
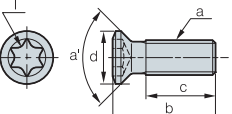
**Screw**

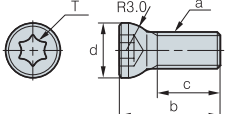
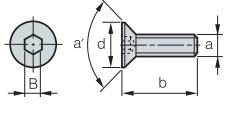
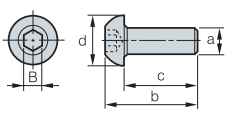
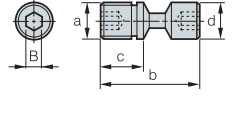
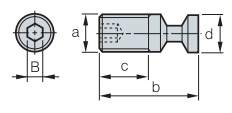
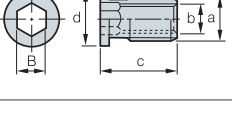
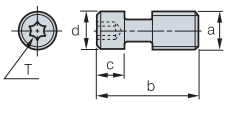
Geometry	Designation	Dimensions					
		a	b	c	d	B(T)	a'
	<b>CHX0625</b>	1/4-20UNC	24.8	11	10	4	
	<b>CTX03510</b>	M3.5 X 0.6	10	4.7	5.3	15	
	<b>CTX04513</b>	M4.5 X 0.75	13.1	6.9	6.8	20	
	<b>CTX04513H</b>	M4.5 X 0.75	13.1	7.2	6.8	20	
	<b>CTX0515</b>	M5 X 0.8	15	8	7	20	
	<b>CTX0517</b>	M5 X 0.8	17.5	10	7	20	
	<b>CTX0621</b>	M6 X 1.0	21.2	12.4	9	25	
	<b>DHA0514</b>	M5 X 0.8	14.0	5.0	7.0	2.5	
	<b>DHA0617</b>	M6 X 1.0	17.0	7.0	7.5	3.0	
	<b>DHA0620</b>	M6 X 1.0	20.0	8.0	8.0	3.0	
	<b>DHA0624</b>	M6 X 1.0	24.0	12.0	8.5	3.0	
	<b>DHA0815</b>	M8 X 1.25	15.5	6.25	6.25	4.0	
	<b>DHA0818F</b>	M8 X 1.0	18	8.5	5.5	4.0	
	<b>DHA0820</b>	M8 X 1.25	20.0	8.0	9.0	4.0	
	<b>DHA0821F</b>	M8 X 1.0	21.0	8.5	8.5	4.0	
	<b>DHA0825</b>	M8 X 1.25	25.0	10.0	9.0	4.0	
	<b>DHA0830</b>	M8 X 1.25	30.0	11.5	11.5	4.0	
	<b>ETGA0520CBM</b>	M5 X 0.8	20	6.5	20	43°	
	<b>ETGD0825</b>	M8 X 1.25	25.2	11.1	40	40°	
	<b>ETKA0523</b>	M5 X 0.8	23	7.6	20	43°	
	<b>ETKA0625</b>	M6 X 1.0	25.5	8.8	20	43°	
	<b>ETKD0516</b>	M5 X 0.8	16.4	6.8	20	40°	
	<b>ETKD0620</b>	M6 X 1.0	20	8.3	25	40°	
	<b>ETNA02506</b>	M2.5 X 0.45	5.7	3.4	7	43°	
	<b>ETNA0408</b>	M4 X 0.7	8.0	5.1	15	43°	
	<b>ETNA0412</b>	M4 X 0.7	12	5.1	15	43°	
	<b>ETNA0511</b>	M5 X 0.8	11.0	6.4	20	43°	
	<b>ETND02506F</b>	M2.5 X 0.35	6.25	3.1	7	40°	
	<b>ETND0307F</b>	M3 X 0.35	7.8	3.7	8	40°	
	<b>ETND03509</b>	M3.5 X 0.6	9.6	4.7	10	40°	
	<b>FTGA03507</b>	M3.5 X 0.6	7.0	5.3	15	60°	
	<b>FTGA03508</b>	M3.5 X 0.6	8.0	5.3	15	60°	
	<b>FTGA03510</b>	M3.5 X 0.6	10.0	5.3	15	60°	
	<b>FTGA03512</b>	M3.5 X 0.6	12.0	5.0	15	60°	
	<b>FTGA0411F</b>	M4 X 0.5	11.0	7.0	15	60°	
	<b>FTGA0417CBM</b>	M4 X 0.7	17.0	5.5	15	62°	
	<b>FTGA0510-P</b>	M5 X 0.8	10.0	7.0	20	63°	
	<b>FTGA0512-P</b>	M5 X 0.8	12.0	7.0	20	63°	
	<b>FTGA0513</b>	M5 X 0.8	13.2	7.0	20	61°	
	<b>FTGA0513-P</b>	M5 X 0.8	13.0	7.0	20	63°	
	<b>FTGA0517</b>	M5 X 0.8	17.0	7.5	20	61°	
	<b>FTGA0621</b>	M6 X 1.0	21.5	9.0	20	61°	
	<b>FTGA0826</b>	M8 X 1.25	26.0	11.6	25	61°	
	<b>FTKA02206</b>	M2.2 X 0.45	5.5	3.0	6	60°	
	<b>FTKA02206S</b>	M2.2 X 0.45	5.6	3.05	7	60°	
	<b>FTKA02555</b>	M2.5 X 0.45	5.5	3.5	7	60°	
	<b>FTKA02565</b>	M2.5 X 0.45	6.5	3.5	7	60°	
	<b>FTKA02565S</b>	M2.5 X 0.45	6.5	3.8	8	60°	
	<b>FTKA0307</b>	M3 X 0.5	7.2	4.2	9	60°	
	<b>FTKA03508</b>	M3.5 X 0.6	8.4	5.5	15	60°	
	<b>FTKA03510</b>	M3.5 X 0.6	10.4	5.5	15	60°	
	<b>FTKA03511A</b>	M3.5 X 0.6	11.0	5.2	15	60°	
	<b>FTKA0408</b>	M4 X 0.7	8.4	5.5	15	60°	
	<b>FTKA0410</b>	M4 X 0.7	10.0	5.5	15	60°	
	<b>FTKA0411K</b>	M4 X 0.7	11.0	6.8	15	60°	
	<b>FTKA0412B</b>	M4 X 0.7	12.5	5.5	15	60°	
	<b>FTKA0413</b>	M4 X 0.7	13.0	5.5	15	60°	
	<b>FTNA01633</b>	M1.6 X 0.35	3.3	2.6	6	60°	
	<b>FTNA0203</b>	M2 X 0.4	3.0	2.7	6	60°	
	<b>FTNA02033</b>	M2 X 0.4	3.3	2.7	6	60°	
	<b>FTNA0204</b>	M2 X 0.4	4.3	2.7	6	60°	
	<b>FTNA02205</b>	M2.2 X 0.45	4.5	3.0	6	60°	
	<b>FTNA0238</b>	M2 X 0.4	3.8	3.0	6	60°	
	<b>FTNA0305</b>	M3 X 0.5	5.2	4.2	9	60°	
	<b>FTNA0306</b>	M3 X 0.5	6.2	4.2	9	60°	
	<b>FTNA0307</b>	M3 X 0.5	7.2	4.2	9	60°	
	<b>FTNA0408</b>	M4 X 0.7	8.5	5.5	15	60°	
	<b>FTNA0411</b>	M4 X 0.7	11.0	5.5	15	60°	
	<b>FTNA0511</b>	M5 X 0.8	11	7.0	20	63°	
	<b>FTNA0513</b>	M5 X 0.8	13.0	7.0	20	60°	
	<b>FTNA0516</b>	M5 X 0.8	16.0	7.0	20	60°	



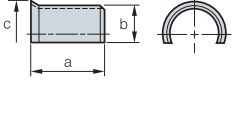
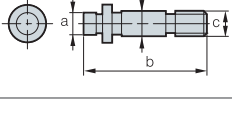


## Screw

Geometry	Designation	Dimensions					
		a	b	c	d	B(T)	α
	FTNB0411	M4 X 0.7	10.8	5.7	15	60°	
	FTNC04509	M4.5 X 0.75	9.5	6.8	20	55°	
	FTNC04511	M4.5 X 0.75	11.5	6.8	20	55°	
	FTNB0209	2 X 0.4	9	2.5	2.7	60°	
	FTNB0209-P	2 X 0.4	9	2.5	2.7	60°	
	FTNB02512	2.5 X 0.45	12	3.5	3.5	60°	
	FTNB02512-P	2.5 X 0.45	12	3.5	3.5	60°	
	FTNB02514	2.5 X 0.45	14	3.5	3.5	60°	
	FTNB02514-P	2.5 X 0.45	14	3.5	3.5	60°	
	FTNB0316	3 X 0.5	16	4.5	4.2	60°	
	FTNB0316-P	3 X 0.5	16	4.5	4.2	60°	
	FTNB0319	3 X 0.5	19	5	4.5	60°	
	FTNB03522	3.5 X 0.6	22	5.6	5.5	60°	
	FTNB03524	3.5 X 0.6	24	5.6	5.5	60°	
	FTNB0426	4 X 0.7	26	6.7	5.5	60°	
	FTNB0528	5 X 0.8	28	6.5	7	60°	
	KHA0508	M5 X 0.8	8		2.5		
	KHA0510	M5 X 0.8	10		2.5		
	KHA0610	M6 X 1.0	10		3		
	KHA0612	M6 X 1.0	12		3.0		
	KHA0812	M8 X 1.25	12		4.0		
	KHA0815	M8 X 1.25	15		4.0		
	KHA1015	M10 X 1.5	15		5.0		
	KHA1020	M10 X 1.5	20		5.0		
	KHB0417	M4 X 0.7	17.2	4.5	2.5	2	
	KHB0406	M4 X 0.7	6	4.2	3	2	
	KHC0510	M5 X 0.8	10	8.1	2.5	90°	
	KHC0610	M6 X 1.0	10	7.8	3.0	90°	
	KHC0812	M8 X 1.25	12	9	4.0	90°	
	KHC1016	M10 X 1.5	16	12.3	5.0	90°	
	KHC1020	M10 X 1.5	20	16.3	5.0	90°	
	KHD0510	M5 X 0.8	10	9	3	2.5	
	KHD0610	M6 X 1.0	10	10	4	3	
	KHD0810	M8 X 1.25	10	10	7.5	4	
	LTX0512	M5 X 0.8	15.1	12	7.3	20	
	LTX0514	M5 X 0.8	17.1	14	7.3	20	
	MHA0512	M5 X 0.8	17.0	10.8	8.0	4.0	
	MHB0310	M3 X 0.5	13.4	8.0	5.5	2.5	
	MHB0410	M4 X 0.7	14.0	8.0	7.0	3.0	
	MHB1055	M10 X 1.5	65	50	16	8	
	MHB1260	M12 X 1.75	72	55	18	10	
	MHB1680	M16 X 2.0	96	75	24	14	
	MHX0523	M5 X 0.8	23.5	9.7	10	2.5	
	MHX0626	M6 X 1.0	25.8	10	11	3	
	MHX0630	M6 X 1.0	30	12.5	10.5	4	
		PTKA02508	M2.5 X 0.45	8	5	3.8	8
PTKA03510		M3.5 X 0.6	10	5	5	15	92°
PTKA0407		M4 X 0.7	7	4.6	5.5	15	86°
PTKA0407F		M4 X 0.5	7.3	3.8	6.5	15	91°
PTKA0408		M4 X 0.7	8	5.6	5.5	15	86°
PTKA0408F		M4 X 0.5	8.3	5.7	6.5	15	91°
PTKA0409F		M4 X 0.5	9.3	6.7	6.5	15	91°
PTKA0410F		M4 X 0.5	10.3	7.7	6.5	15	91°
PTKA0411F		M4 X 0.5	11.3	8.7	6.5	15	91°
PTKA0412		M4 X 0.7	12	7.5	5.9	15	92°
PTKA0412F		M4 X 0.5	12.3	9.7	6.5	15	91°
PTKA0413F		M4 X 0.5	13.3	10.7	6.5	15	91°
PTKA0512		M5 X 0.8	12	7	6.9	20	92°
PTMA03508		M3.5 X 0.6	8	5.3	6	9	90°
PTMA0403F		M4 X 0.5	3.3	1.7	6.5	15	91°
PTMA0404F		M4 X 0.5	4.3	2.7	6.5	15	91°
PTMA0405F		M4 X 0.5	5.3	3.7	6.5	15	91°
PTMA0406F		M4 X 0.5	6.3	4.7	6.5	15	91°
PTMA0411		M4 X 0.7	11	8.5	6.6	15	90°

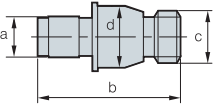
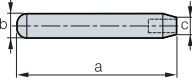
Geometry	Designation	Dimensions					
		a	b	c	d	B(T)	α
	FHGA0618	M4 X 0.7	11	6.9	6	15	
	FHGA0618	M6 X 1.0	18		8.5	4.0	61°
	PXMA0306	M3 X 0.5	5.9		5.7	2	90°
	SHX0310	M3 X 0.5	10		5.9	2	91°
	RHA0510	M5 X 0.8			10		4.0
	RHA0613	M6 X 1.0	16.3	13	10.5	4.0	
	RHA0620	M6 X 1.0	24	20	10.5	4.0	
	VHX0509B	M5 X 0.8	9	4.15	5	2	
	VHX0512B	M5 X 0.8	12	6.5	5	2	
	VHX0512BN	M5 X 0.8	12	6.56	5	2	
	VHX0514	M5 X 0.8	14.5	8.25	5	2	
	VHX0613N	M6 X 1.0	13.4	7.5	5.93	2.5	
	VHX0617	M6 X 1.0	17	10	6	2.5	
	VHX0617N	M6 X 1.0	16.75	8.34	5.9	2.5	
	VHX0621	M6 X 1.0	21	14	6		
	VHX0817N	M8 X 1.0	17.05	7.98	7.9	3	
	VHX0820N	M8 X 1.0	20.7	7.98	7.9	3	
	VHX0820AN	M8 X 1.0	20.5	10.36	7.9	3	
	VHX0821	M8 X 1.0	21	10	8	3	
	VHX0821N	M8 X 1.0	21.2	9.68	7.9	3	
	VHX0823N	M8 X 1.0	23.5	10.36	7.9	3	
	VHX0825	M8 X 1.0	25	12	8	3	
	VHX1027N	M10 X 1.0	27.2	14.4	9.8	5	
	VHX1236N	M12 X 1.0	36	18.3	11.8	5	
		VHX0613A	M6 X 1.0	13.4	9.1	6.0	2.5
SHXN0509F		M5 X 0.5	M3.5 X 0.6	8.65	6.3	3.5	
	SHXN0609F	M6 X 0.75	M4 X 0.7	9	7.8	4	
	SHXN0610F	M6 X 0.75	M4 X 0.5	10	7.8	4	
	SHXN0712F	M7 X 0.75	M5 X 0.8	12	8.5	5	
	WTX0813	M8 X 1.25	17.2	4.9	8.5	25	
	WTX0817	M8 X 1.25	22	4.9	8.5	25	

## Shim pin

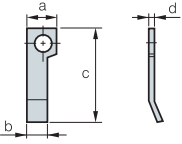
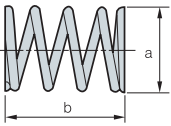
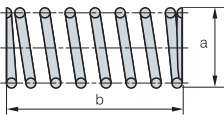
Geometry	Designation	Dimensions			
		a	b	c	d
	SP3	5.5	3.5	5.9	
	SP3N	6.85	3.3	5.55	
	SP4	7.0	4.0	7.6	
	SP4N	5.8	4.35	7.4	
	SP5	8.5	4.5	8.8	
	SP5N	8.5	5.68	9	
	SP6N	11.1	6.0	11.0	
	SP8N	12.0	10.0	15.35	
	SP2M	5	14	M5 X 0.8	6
	SP3M	3.5	19.5	M4 X 0.7	4
	SP3M-1	3.5	16.5	M4 X 0.7	4
	SP4M	5	19	M5 X 0.8	6



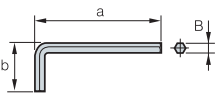
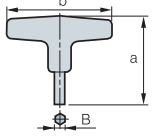
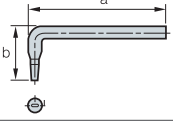
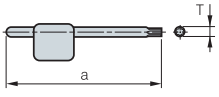
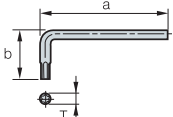
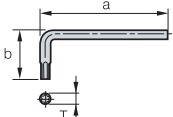
**Shim pin**

Geometry	Designation	Dimensions			
		a	b	c	d
	SP3D	3.7	13.1	UNF10-32	5.6
	SP3D2	3.6	12	UNF10-32	5.5
	SP3DS	3.7	11.54	UNF10-32	5.6
	SP4D	4.97	17.19	UNF1/4 28	7.12
	SP4DL	5	17.1	UNF1/4 28	7
	SP4DS	4.97	13.26	UNF1/4 28	
	SP5D	6.21	21.9	UNF5/16-24	9.44
	SP6D	7.75	21.9	UNF3/8-24	11.02
SP8D	9.02	29.63	UNF7/16-20	14.21	
	LSPS3	60	8.2	5.55	
	LSPS4	65	10	7	
	LSPS5	69	11.4	8.85	
	LSPS6	69	13	11	
	LSPS8	73	16.5	15.2	

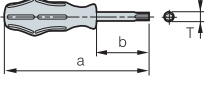
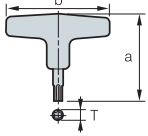
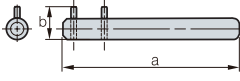
**Spring**

Geometry	Designation	Dimensions			
		a	b	c	d
	SR2	4.0	2.8	12.6	0.4
	SPR0315	3.0	15		
	SPR0415	4.0	15		
	SR3	9.2	12.5		
	SR4	4.0	11.0		
	SPR0714	7	14		
	SPR0510	5	10		
	SPR0714	7	14		
	SPR0811	8	11		

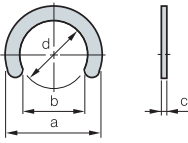
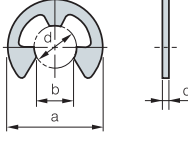
**Wrench**

Geometry	Designation	Dimensions		
		a	b	B(T)
	HW20L	52	18	2
	HW25L	58.5	20.5	2.5
	HW30L	66	23	3
	HW35L	72	25	3.5
	HW40L	74	29	4
	HW50L	85	33	5
	HW40	82	80	4
	HW50	96	90	5
	SW50L	70	27.5	
	TW06P	63	6	
	TW07P	63	7	
	TW08P	71	8	
	TW09P	75	9	
	TW10P	78	10	
	TW15P	82	15	
	TW20P	86	20	
	TW15L	60	21	15
	TW20L	60	21	20

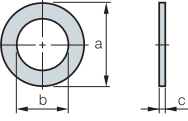
**Wrench**

Geometry	Designation	Dimensions		
		a	b	B(T)
	TW07S	140	60	7
	TW08S	150	76	8
	TW09S	165	70	9
	TW15S	190	90	15
	TW20S	195	91	20
	TW20	75	80	20
	TW25	74	80	25
	TW15-100	127	80	15
	TW20-100	127	80	20
	SW15S	150	13	

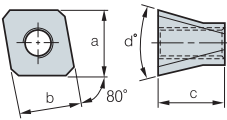
**Stop ring**

Geometry	Designation	Dimensions			
		a	b	c	d
	CR03	4.8	2.6	0.4	3.0
	CR04	6.6	3.6	0.4	4.0
	CR05	7.6	4.6	0.4	5.0
	ER03	7.0	2.6	0.6	3.0
	ER04	9.0	3.5	0.6	4.0
	ER05	11	4.3	0.6	5.0

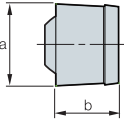
**Washer**

Geometry	Designation	Dimensions		
		a	b	c
	WA3	11.0	6.8	0.5-1.0
	WA4	10.0	5.3	0.5-1.0

**Stopper**

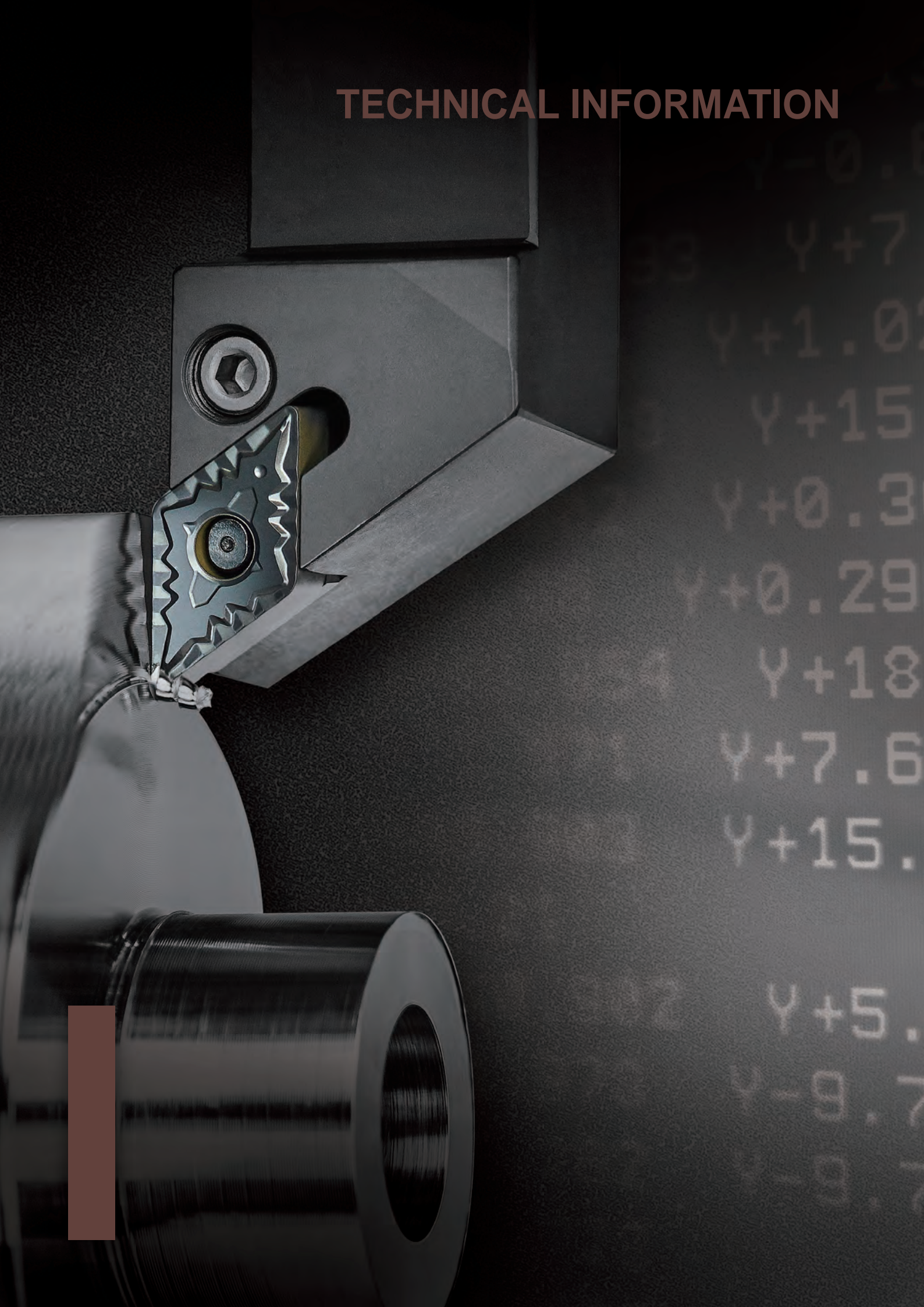
Geometry	Designation	Dimensions			
		a	b	c	d°
	STP5	11	10.2	11	30°

**Nozzle**

Geometry	Designation	Dimensions	
		a	b
	CN0605	6	4.6



# TECHNICAL INFORMATION



Y+0.0  
Y+7  
Y+1.0  
Y+15  
Y+0.3  
Y+0.29  
Y+18  
Y+7.6  
Y+15.  
Y+5.  
Y-9.7  
Y-9.7



### **General Information I**

- I 02** Workpiece Material Grades
- I 06** Steel, Non-ferrous Metal Symbol List
- I 07** SI unit Conversion Table
- I 08** Hardness Calculating Table
- I 09** Properties of Korloy Grades

### **Technical Information**

- I 10** Technical Information for Turning
- I 20** Technical Information for Milling
- I 24** Technical Information for Tapers
- I 27** Technical Information for Endmills
- I 30** Technical Information for Drills

### **General Information II**

- I 36** The comparison of chip breakers
- I 37** KORLOY Grades
- I 40** The comparison of grades for Turning/Milling

# General Information I

## Carbon steel and alloy steel for structural use

Type	Korea	ISO	Japan	U.S.A	Great Britain	Germany	France	Russia	
	KS	ISO	JIS	AISI SAE	BS BS/EN	DIN DIN/EN	NF NF/EN	GOCT	
Carbon steel	SM10C	C10	S10C	1010	040A10 045A10 045M10	C10E C10R	XC10	-	
	SM15C	C15E4 C15M2	S15C	1015	055M15	C15E C15R	-	-	
	SM20C	-	S20C	1020	070M20 C22, C22E C22R	C22 C22E C22R	C22 C22E C22R	-	
	SM25C	C25 C25E4 C25M2	S25C	1025	C25 C25E C25R	C25 C25E C25R	C25 C25E C25R	-	
	SM30C	C30 C30E4 C30M2	S30C	1030	080A30 080M30 CC30 C30E C30R	C30 C30E C30R	C30 C30E C30R	30 Г	
	SM35C	C35 C35E4 C35M2	S35C	1035	C35 C35E C35R	C35 C35E C35R	C35 C35E C35R	35 Г	
	SM40C	C40 C40E4 C40M2	S40C	1039 1040	080M40 C40 C40E C40R	C40 C40E C40R	C40 C40E C40R	40 Г	
	SM43C	-	S43C	1042 1043	080A42	-	-	40 Г	
	SM45C	C45 C45E4 C45M2	S45C	1045 1046	C45 C45E C45R	C45 C45E C45R	C45 C45E C45R	45 Г	
	SM48C	-	S48C	-	080A47	-	-	45 Г	
	SM50C	C50 C50E4 C50M2	S50C	1049	080M50 C50 C50E C50R	C50 C50E C50R	C50 C50E C50R	50 Г	
	SM53C	-	S53C	1050 1053	-	-	-	50 Г	
	SM55C	C55 C55E4 C55M2	S55C	1055	070M55 C55 C55E C55R	C55 C55E C55R	C55 C55E C55R	-	
	SM58C	C60 C60E4 C60M2	S58C	1059 1060	C60 C60E C60R	C60 C60E C60R	C60 C60E C60R	60 Г	
	Alloy steel	Nickel chromium steel	SNC236	-	SNC236	-	-	-	40XH
SNC415(H)			-	SNC415(H)	-	-	-	-	
SNC631(H)			-	SNC631(H)	-	-	-	30XH3A	
SNC815(H)			15NiCr13	SNC815(H)	-	655M13(655H13)	15NiCr13	-	
SNC836			-	SNC836	-	-	-	-	
Nickel chromium molybdenum steel		SNCM220	20NiCrMo2 20NiCrMoS2	SNCM220	8615 8617(H) 8620(H) 8622(H)	805A20 805M20 805A22 805M22	20NiCrMo2 20NiCrMoS2	20NCD2	-
		SNCM240	41CrNiMo2 41CrNiMoS2	SNCM240	8637 8640	-	-	-	
		SNCM415	-	SNCM415	-	-	-	-	
		SNCM420(H)	-	SNCM420(H)	4320(H)	-	-	-	
		SNCM431	-	SNCM431	-	-	-	-	
		SNCM439	-	SNCM439	4340	-	-	-	
		SNCM447	-	SNCM447	-	-	-	-	
		SNCM616	-	SNCM616	-	-	-	-	
		SNCM625	-	SNCM625	-	-	-	-	
		SNCM630	-	SNCM630	-	-	-	-	
SNCM815	-	SNCM815	-	-	-	-			
Chromium steel	SCr415(H)	-	SCr415(H)	-	-	17Cr3 17CrS3	-	15X 15XA	
	SCr420(H)	20Cr4(H) 20CrS4	SCr420(H)	5120(H)	-	-	-	20X	
	SCr430(H)	34Cr4 34CrS4	SCr430(H)	5130(H) 5132(H)	34Cr4 34CrS4	34Cr4 34CrS4	34Cr4 34CrS4	30X	
	SCr435(H)	34Cr4 34CrS4 37Cr4 37CrS4	SCr435(H)	5135(H)	37Cr4 37CrS4	37Cr4 37CrS4	37Cr4 37CrS4	35X	
	SCr440(H)	37Cr4 37CrS4 41Cr4 41CrS4	SCr440(H)	5140(H)	530M40 41Cr4 41CrS4	41Cr4 41CrS4	41Cr4 41CrS4	40X	
	SCr445(H)	-	SCr445(H)	-	-	-	-	45X	

• The above Alloy steel can supplied by domestic manufacturing





Type		Korea	ISO	Japan	U.S.A	Great Britain	Germany	France	Russia
		KS	ISO	JIS	AISI SAE	BS BS/EN	DIN DIN/EN	NF NF/EN	GOCT
Alloy steel	Chromium molybdenum steel	SCM415(H)	-	SCM415(H)	-	-	-	-	-
		SCM418(H)	18CrMo4 18CrMoS4	SCM418(H)	-	-	18CrMo4 18CrMoS4	-	20XM
		SCM420(H)	-	SCM420(H)	-	708M20(708H20)	-	-	20XM
		SCM430	-	SCM430	4130	-	-	-	30XM 30XMA
		SCM432	-	SCM432	-	-	-	-	-
		SCM435(H)	34CrMo4 34CrMoS4	SCM435(H)	(4135H) 4137(H)	34CrMo4 34CrMoS4	34CrMo4 34CrMoS4	34CrMo4 34CrMoS4	35XM
		SCM440(H)	42CrMo4 42CrMoS4	SCM440(H)	4140(H) 4142(H)	708M70 709M40 42CrMo4 42CrMoS4	42CrMo4 42CrMoS4	42CrMo4 42CrMoS4	-
		SCM445(H)	-	SCM445(H)	4145(H) 4147(H)	-	-	-	-
	Manganese steel and Manganese chromium steel	SMn420(H)	22Mn6(H)	SMn420(H)	1522(H)	150M19	-	-	-
		SMn433(H)	-	SMn433(H)	1534	150M36	-	-	30 Г 2 35 Г 2 35 Г 2 40 Г 2 40 Г 2 45 Г 2
		SMn438(H)	36Mn6(H)	SMn438(H)	1541(H)	150M36	-	-	-
		SMn443(H)	42Mn6(H)	SMn443(H)	1541(H)	-	-	-	-
		SMnC420(H)	-	SMnC420(H)	-	-	-	-	-
		SMnC443(H)	-	SMnC443(H)	-	-	-	-	-
	Aluminum chromium molybdenum steel	SACM645	41CrAlMo74	SACM645	-	-	-	-	-

• The above Alloy steel can supplied by domestic manufacturing

### Tool steel

Type		Korea	ISO	Japan	U.S.A	Great Britain	Germany	France	Russia
		KS	ISO	JIS	AISI SAE	BS BS/EN	DIN DIN/EN	NF NF/EN	GOCT
High speed steel	SKH2	HS18-0-1	SKH2	T1	BM 2	S6/5/2	Z 85 WDCV		
	SKH3	-	SKH3	T4					
	SKH4	-	SKH4	T5					
	SKH10	-	SKH10	T15					
	SKH51	HS6-5-2	SKH51	M2					
	SKH52	HS6-6-2	SKH52	M3-1	BM 35	S6/5/2/5	6-5-2-5		
	SKH53	HS6-5-3	SKH53	M3-2					
	SKH54	HS6-5-4	SKH54	M4					
	SKH55	HS6-5-2-5	SKH55	M 35					
	SKH56	-	SKH56	M36					
	SKH57	HS10-4-3-10	SKH57	-	S2/9/2				
	SKH58	HS2-9-2	SKH58	M7					
	SKH59	HS2-9-1-8	SKH59	M42					
	Alloy tool steel	STS11	-	SKS11	F2				
STS2		-	SKS2	-					
STS21		-	SKS21	-					
STS5		-	SKS5	-					
STS51		-	SKS51	L6					
STS7		-	SKS7	-					
STS8		-	SKS8	-					
STS4		-	SKS4	-					
STS41		-	SKS41	-					
STS43		105V	SKS43	W2-9 1/ W2-8 1-2					
STS44		-	SKS44	-	105WCr6	105WC13			
STS3		-	SKS3	-					
STS31		105WCr1	SKS31	-					
STS93		-	SKS93	-					
STS94		-	SKS94	-					
STS95		-	SKS95	-	BD3	X210Cr12	Z200C12		
STD1		210Cr12	SKD1	D3	BA2	X100CrMoV5 1	Z100CDV5		
STD11		-	SKD11	D2					
STD12		100CrMoV5	SKD12	A2	BH21	X30WCrV9 3	Z30WCV9		
STD4		-	SKD4	-					
STD5		X30WCrV9-3	SKD5	H21	BH13	X40CrMoV5 1	Z40CDV5		
STD6		X37CrMoV5-1	SKD6	H11					
STD61		X40CrMoV5-1	SKD61	H13					
STD62		X35CrVMoV5	SKD62	H12					
STD7		32CrMoV12-28	SKD7	H10					
STD8		-	SKD8	H19	55NiCrMoV6	55NCDV7			
STF3	-	SKT3	-						
STF4	55NiCrMoV7	SKT4	L6						

• The above Alloy steel can supplied by domestic manufacturing



# General Information I

Type	Korea	ISO	Japan	U.S.A	Great Britain	Germany	France	Russia
	KS	ISO	JIS	AISI SAE	BS BS/EN	DIN DIN/EN	NF NF/EN	GOCT
Free cutting carbon steel	SUM11	-	SUM11	1110				
	SUM12	-	SUM12	1109				
	SUM21	9S20	SUM21	1212				
	SUM22	11SMn28	SUM22	1213	230M07	9SMn28	S250	
	SUM22L	11SMnPb28	SUM22L	12L13		9SMnPb28	S250Pb	
	SUM23	-	SUM23	1215	240M07	9SMn36	S 300	
	SUM23L	-	SUM23L	-				
	SUM24L	11SMnPb28	SUM24L	12L14		9SMnPb36	S300Pb	
	SUM25	12SMn35	SUM25	-				
	SUM31	-	SUM31	1117				
	SUM31L	-	SUM31L	-				
	SUM32	-	SUM32	-				
	SUM41	-	SUM41	1137				
	SUM42	-	SUM42	1141				
	SUM43	44SMn28	SUM43	1144				
High carbon chromiom	STB1	-	SUJ1	-				
	STB2	B1	SUJ2	52100	534A99	100Cr6	100Cr6	
	STB3	B2	SUJ3	ASTM A 485 Grade 1				
	STB4	-	SUJ4	-				
	STB5	-	SUJ5	-				

• The above Alloy steel can supplied by domestic manufacturing

## Stainless steel

Type		Korea	ISO	Japan	U.S.A		Great Britain	Germany	France	Russia	
		KS	ISO	JIS	UNS	AISI SAE	BS BS/EN	DIN DIN/EN	NF NF/EN	GOCT	
Stainless steel	Austenitic	STS201	X12CrMnNiN17-7-5	SUS201	S20100	201	284S16	X12CrNi17-7	Z12CMN17-07Az	12X17-9AH4	
		STS202	X12CrMnNiN18-9-5	SUS202	S20200	202	301S21	X2CrNiN18-7		07X16H6	
		STS301	X10CrNi18-8	SUS301	S30100	301			X12CrNi17-7	Z11CN17-08	
		STS301L	X2CrNiN18-7	SUS301L							
		STS301J1		SUS301J1			302S25				12X18H9
		STS302		SUS302	S30200	302			X10CrNiS18-9	Z12CN18-09	
		STS302B	X12CrNiSi18-9-3	SUS302B	S30215	302B	303S21				
		STS303	X10CrNiS18-9	SUS303	S30300	303	303S41			Z8CNF18-09	12X18H10E
		STS303Se		SUS303Se	S30323	303Se			X5CrNi18-10		
		STS303Cu		SUS303Cu			304S31				08X18H10
		STS304	X5CrNi18-9 X2CrNi18-9	SUS304	S30400	304		304S11	X2CrNi19-11	Z7CN18-09	03X18H11
		STS304L	X2CrNi19-11	SUS304L	S30403	304L			X2CrNiN18-10	Z3CN19-11	
		STS304N1	X5CrNiN18-8	SUS304N1	S30451	304N				Z6CN19-09Az	
		STS304LN	X2CrNiN18-8	SUS304LN	S30453	304LN			X5CrNi18-12	Z3CN18-10Az	
		STS304J1		SUS304J1			305S19				06X18H11
		STS305	X6CrNi18-12	SUS305	S30500	305				Z8CN18-12	
		STS309S		SUS309S	S30908	309S	310S31		X5CrNiMo27-12-2	Z10CN24-13	10X23H18
		STS310S	X6CrNi25-20	SUS310S	S31008	310S	316S31		X5CrNiMo27-13-3	Z8CN25-20	
		STS316	X5CrNiMo17-12-2 X3CrNiMo17-12-3	SUS316	S31600	316		316S11	X2CrNiMo17-13-2 X2CrNiMo17-14-3	Z7CND17-12-02 Z6CND18-12-03	03X17H14M3
		STS316L	X2CrNiMo17-12-2 X2CrNiMo17-12-3 X2CrNiMo18-14-3	SUS316L	S31603	316L				Z3CND17-12-02 Z3CND17-12-03	
	STS316N		SUS316N	S31651	316N	317S16		X6CrNiTi18-10			
	STS317		SUS317	S31700	317	321S31		X6CrNiNb18-10		08X18H10T	
	STS321	X6CrNiTi18-10	SUS321	S32100	321	347S31			Z6CNT18-10	08X18H12	
	STS347	X6CrNiNb18-10	SUS347	S34700	347			X6CrAl13	Z6CNNb18-10		
	STS384	X3NiCr18-16	SUS384	S38400	384	405S17			Z6CN18-16		
	STS405	X6CrAl13	SUS405	S40500	405				Z8CA12		
	STS410L		SUS410L					X6Cr17	Z3C14		
	STS429		SUS429	S42900	429	430S17		X7CrS18		12X17	
	STS430	X6Cr17	SUS430	S43000	430		434S17	X6CrMo17-1	Z8C17		
	STS430F	X7CrS17	SUS430F	S43020	430F				Z8CF17		
	STS434	X6CrMo17-1	SUS434	S43400	434				Z8CD17-01		
	STS444	X2CrMoTi18-2	SUS444	S44400	444				Z3CDT18-02		
	STXMX27		SUSXM27	S44627				X10Cr13	Z1CD26-01		
Martensitic	STS403		SUS403	S40300	403	410S21					
	STS410	X12Cr13	SUS410	S41000	410	416S21	X20Cr13	Z13C13			
	STS416	X12CrS13	SUS416	S41600	416	420S29	X20CrNi17-2	Z11CF13	20X13		
	STS420J1	X20Cr13	SUS420J1	S42000	420	431S29		Z20C13	20X17H2		
	STS431	X19CrNi16-2	SUS431	S43100	431				Z15CN16-02		
STS440A	X70CrMo15	SUS440A	S44002	440A			X7CrNiAl17-7	Z70C15			
Precipitation hardening type	STS630	X5CrNiCuNb16-4	SUS630	S17400	S17400				Z6CNU17-04	09X17H7IO	
	STS631	X7CrNiAl17-7	SUS631	S17700	S17700				Z9CNA17-07		
STS631J1		SUS631J1									

• The above Alloy steel can supplied by domestic manufacturing





➤ Casting or forging steel

Type		Korea	ISO	Japan	U.S.A	Great Britain	Germany	France	Russia
		KS	ISO	JIS	AISI SAE	BS BS/EN	DIN DIN/EN	NF NF/EN	GOCT
Casting Iron	Grey iron casting	GC100 GC150 GC200 GC250 GC300 GC350	100,150, 200, 250, 300, 350	FC100 FC150 FC200 FC250 FC300 FC350	No 20 B No 25 B No 30 B No 35 B No 45 B No 50 B No 55 B	Grade 150 Grade 220 Grade 260 Grade 300 Grade 350 Grade 400	GG 10 GG 15 GG 20 GG 25 GG 30 GG 35 GG 40	Ft 10 D Ft 15 D Ft 20 D Ft 25 D Ft 30 D Ft 35 D Ft 40 D	
	Spheroidal graphite iron casting	GCD400-15, GCD400-18  GCD450-10, GCD500-7 GCD600-3 GCD700-2	400-15, 400-18  450-10, 500-7 600-3 700-2	FCD400  FCD500 FCD600 FCD700	60-40-18  65-45-12 80-55-06 100-70-03	SNG 420/12 SNG 370/17 SNG 500/7 SNG 600/3 SNG 700/2	GGG 40 GGG 40.3 GGG 50 GGG 60 GGG 70	FCS 400-12 FGS 370-17 FGS 500-7 FGS 600-3 FGS 700-2	
	Austempered Spheroidal graphite iron casting	FCAD	-	FCAD	-	EN-GJS-	EN-GJS-	EN-GJS-	
	Austenitic iron casting	FCA- FCDA-	L, S-	FCA- FCDA-	Type 1, 2, Type D-2, D-3A Class 1, 2	F1, F2, S2W, S5S	GGL-, GGG-	L, S-	

➤ Non-ferrous alloy

Type		Korea	ISO	Japan	U.S.A	Great Britain	Germany	France	Russia
		KS	ISO	JIS	AISI SAE	BS BS/EN	DIN DIN/EN	NF NF/EN	GOCT
Aluminum alloy	Aluminum alloy ingots for casting	AC1B	Al-Cu4MgTi	AC1B	204.0	-	-	A-U5GT	
		AC2A	-	AC2A	-	-	-	-	
		AC2B	-	AC2B	319.0	-	-	-	
		AC3A	-	AC3A	-	-	LM-6	-	
		AC4A	-	AC4A	-	-	-	G(GK)-AlSi9Cu3	-
		AC4B	-	AC4B	-	-	-	-	-
		AC4C	Al-Si7Mg(Fe)	AC4C	356.0	LM-25	G(GK)-AlSi7Mg	A-S7G	
		AC4CH	Al-Si7Mg	AC4CH	A356.0	-	-	-	
		AC4D	Al-Si5Cu1Mg	AC4D	355.0	LM-16	-	-	
		AC5A	Al-Cu4Ni2Mg2	AC5A	242.0	-	G(GK)-AlMg5	A-U4NT	
		AC7A	-	AC7A	514.0	LM-5	-	-	
		AC8A	-	AC8A	-	LM-13	-	A-S12UNG	
		AC8B	-	AC8B	-	LM-26	-	A-S10UG	
		AC8C	-	AC8C	-	-	-	A-S10UG	
		AC9A	-	AC9A	-	LM-29	-	-	
	AC9B	-	AC9B	-	-	-	GD-AlSi12 (Cu)	A-S18UNG	
	Aluminum alloy die casting	ALDC1	Al-Si12CuFe	ADC1	A413.0	LM20	GD-AlSi10Mg	A-S13	
		ALDC2	-	ADC3	A360.0	-	GD-AlMg9	A-S9G	
		ALDC3	-	ADC5	518.0	-	-	A-G6	
		ALDC4	-	ADC6	-	-	GD-AlSi9Cu3	A-G3T	
		ALDC7	Al-Si8Cu3Fe	ADC10	A380.0	-	GD-AlSi9Cu3	-	
		ALDC7Z	Al-Si8Cu3Fe	ADC10Z	A380.0	LM24	-	-	
		ALDC8	-	ADC12	383.0	LM2	-	-	
		ALDC8Z	-	ADC12Z	383.0	LM2	-	-	
	ALDC9	-	ADC14	B390.0	LM30	EN AW-5052	-		
	Aluminum alloy extruded shapes	A5052S	-	A5052S	5052	EN AW-5052	EN AW-5454	EN AW-5052	
		A5454S	-	A5454S	5454	EN AW-5454	EN AW-5083	EN AW-5454	
		A5083S	AlMg4.5Mn0.7	A5083S	5083	EN AW-5083	EN AW-5086	EN AW-5083	
		A5086S	-	A5086S	5086	EN AW-5086	EN AW-6061	EN AW-5086	
		A6061S	AlMg1SiCu	A6061S	6061	EN AW-6061	EN AW-6063	EN AW-6061	
		A6063S	AlMg0.7Si	A6063S	6063	EN AW-6063	EN AW-7003	EN AW-6063	
		A7003S	-	A7003S	-	EN AW-7003	-	EN AW-7003	
		A7N01S	-	A7N01S	-	-	EN AW-7075	-	
A7075S		AlZn5.5MgCu	A7075S	7075	EN AW-7075	-	EN AW-7075		

➤ Heat resistant steel

Type		Korea	ISO	Japan	U.S.A		Great Britain	Germany	France	Russia
		KS	ISO	JIS	UNS	AISI SAE	BS BS/EN	DIN DIN/EN	NF NF/EN	GOCT
Heat resistant steel	Austenitic	STR31		SUH31			331S42		Z35CNWS14-14	
		STR35		SUH35			349S52	X53CrMnNi21-9	Z52CMN21-09-Az	
		STR36		SUH36			349S54		Z55CMN21-09-Az	
		STR37		SUH37		S63008	381S34			
		STR38		SUH38		S63017				
		STR309		SUH309			309S24	CrNi2520	Z15CN24-13	
		STR310		SUH310		S30900	310S24		Z15CN25-20	
		STR330		SUH330		S31000	309		Z12NCS35-16	
		STR660		SUH660		N08330	310		Z6NCTV25-20	
		STR661		SUH661		S66286	N08330		CrAl1205	
	Ferritic	STR21		SUH21		R30155		X6CrTi12		
		STR409	X6CrTi12	SUH409			409S19		Z6CT12	
		STR409L	X2CrTi12	SUH409L		S40900			Z3CT12	
		STR446		SUH446			409	X45CrSi9-3	Z12C25	
	Martensitic	STR1		SUH1		S44600	401S45		Z45CS9	
		STR3		SUH3		S65007	446		Z40CSD10	
		STR4		SUH4			443S65		Z80CSN20-02	
		STR11		SUH11						
		STR600		SUH600						
		STR616		SUH616		S42200				

• The above Heat resistant steel can supplied by domestic manufacturing



## Steel, Non-ferrous metal symbol list

### Comparison of workpiece material standards

Group	Standard term	Code	Group	Standard term	Code	
<b>Structural Steel</b>	Rolled Steel for Welded Structure	SWS	<b>Forged steel</b>	Carbon Steel Forging	SF	
	Rerolled Steel	SBR		Chromium Molybdenum Steel Forging	SFCM	
	Rolled Steel for General Structure	SB		Nickel Chromium Molybdenum Steel Forging	SFNCM	
	Light Gauge Steel for General Structure	SBC	<b>Cast iron</b>	Gray Cast iron	GC	
	Hot-rolled Steel Plate, Sheet/ Strip for Automobile Structural Use	SAPH		Spheroidal Graphite Cast iron	GCD	
<b>Steel Plate</b>	Cold-rolled Steel Sheet/Strip	SBC		Blackheart Malleable Cast iron	BMC	
	Hot-rolled Soft Steel Sheet/Strip	SHP		Whiteheat Malleable Cast iron	WMC	
<b>Steel Pipe</b>	Carbon Steel Pipe for Ordinary Piping	SPP	Pearlitic Malleable Cast iron	PMC		
	Carbon Steel Pipe for Boiler and Heat Exchanger	STH	<b>Cast steel</b>	Carbon Cast Steel	SC	
	Seamless Steel Pipe for High Pressure Gas Cylinder	STHG		High Tensile Strength Carbon Cast Steel & Low Alloy Cast Steel	HSC	
	Carbon Steel Pipe for General Structural Use	SPS		Stainless Cast Steel	SSC	
	Carbon Steel Pipe for Machine Structural Use	STST		Heat Resisting Cast Steel	HRSC	
	Alloy Steel Pipe for Structural Use	STA		High Manganese Cast Steel	HMnSC	
	Stainless Steel Pipe for Machine and Structural Use	STS-TK		Cast Steel for High Temperature and High Pressure Service	SCPH	
	Carbon Steel Square Pipe for General Structural Use	SPSR		<b>Casting</b>	Brass Casting	BsC
	Alloy Steel Pipe	SPA			High Strength Brass Casting	HBsC
	Carbon Steel Pipe for Pressure Service	SPPS	Bronze Casting		BrC	
	Carbon Steel Pipe for High Temperature Service	SPSR	Phosphoric Bronze Casting		PCB	
	Carbon Steel Pipe for High Pressure Service	SPPH	Aluminum Bronze Casting		AIBC	
	Stainless Steel Pipe	STSxT	Aluminum Alloy Casting		ACxA	
	<b>Iron and Steel</b>	Carbon Steel for Machine Structural Use	SMxxC, SMxxCK		Magnesium Alloy Casting	MgC
Aluminum Chromium Molybdenum Steel		SACM	Zinc Alloy Die Casting		ZnDC	
Chromium Molybdenum Steel		SCM	Aluminum Alloy Die Casting		Al DC	
Chromium Steel		SCr	Magnesium Alloy Die Casting		MgDC	
Nickel Chromium Steel		SNC	White Metal	WM		
Nickel Chromium Molybdenum Steel		SNCM	Aluminum Alloy Casting for Bearing	AM		
Manganese Steel and manganese Chromium Steel for Machine Structural Use		SMn, SMnC	Brass Alloy Casting for Bearing	KM		
<b>Special steel</b>	<b>Tool steel</b>	Carbon Tool Steel	STC			
		Hollow Drill Steel	SKC			
		Alloy Tool Steel	STS, STD, STF			
		High Speed Tool Steel	SKH			
	<b>Stainless steel</b>	Stainless Steel Bar	STS			
		<b>Heat resisting steel</b>	Heat Resisting Steel	STR		
			Heat Resisting Steel Bar	STR		
	Heat Resisting Steel Sheet		STR			
	Free cutting carbon steel	SUM				
	Special steel	STB				
Spring steel	SPS					



## SI unit conversion table

### Major SI unit conversion table

#### Force

N	kgf	dyn
1	$1.01972 \times 10^{-1}$	$1 \times 10^{-5}$
9.80665	1	$9.80665 \times 10^5$
$1 \times 10^{-5}$	$1.01972 \times 10^{-6}$	1

#### Stress

Pa or N/m <sup>2</sup>	MPa or N/mm <sup>2</sup>	kgf/mm <sup>2</sup>	kgf/cm <sup>2</sup>	kgf/m <sup>2</sup>
1	$1 \times 10^{-6}$	$1.01972 \times 10^{-7}$	$1.01972 \times 10^{-5}$	$1.01972 \times 10^{-1}$
$1 \times 10^6$	1	$1.01972 \times 10^{-1}$	$1.01972 \times 10$	$1.01972 \times 10^5$
$9.80665 \times 10^6$	9.80665	1	$1 \times 10^2$	$1 \times 10^6$
$9.80665 \times 10^4$	$9.80665 \times 10^{-2}$	$1 \times 10^{-2}$	1	$1 \times 10^4$
9.80665	$9.80665 \times 10^{-6}$	$1 \times 10^{-6}$	$1 \times 10^{-4}$	1

#### Pressure

Pa	kPa	MPa	bar	kgf/cm <sup>2</sup>
1	$1 \times 10^{-3}$	$1 \times 10^{-6}$	$1 \times 10^{-5}$	$1.01972 \times 10^{-5}$
$1 \times 10^3$	1	$1 \times 10^{-3}$	$1 \times 10^{-2}$	$1.01972 \times 10^{-2}$
$1 \times 10^6$	$1 \times 10^3$	1	$1 \times 10$	$1.01972 \times 10$
$1 \times 10^5$	$1 \times 10^2$	$1 \times 10^{-1}$	1	1.01972
$9.80665 \times 10^4$	$9.80665 \times 10$	$9.80665 \times 10^{-2}$	$9.80665 \times 10^{-1}$	1

#### Work, Energy, Calorie

J	kW·h	kgf·m	kcal
1	$2.77778 \times 10^{-7}$	$1.01972 \times 10^{-1}$	$2.38889 \times 10^{-4}$
$3.60000 \times 10^6$	1	$3.67098 \times 10^5$	$8.60000 \times 10^2$
9.80665	$2.72407 \times 10^{-6}$	1	$2.34270 \times 10^{-3}$
$4.18605 \times 10^3$	$1.16279 \times 10^{-3}$	$4.26858 \times 10^2$	1

#### Power

W	kW	kgf·m/s	PS	kcal/h
1	$1 \times 10^{-3}$	$1.01972 \times 10^{-1}$	$1.35962 \times 10^{-3}$	0.860
$1 \times 10^3$	1	$1.01972 \times 10^2$	1.359 62	$8.60000 \times 10^2$
9.81 65	$9.80665 \times 10^{-3}$	1	$1.33333 \times 10^{-2}$	8.433 71
$7.355 \times 10^2$	$7.355 \times 10^{-1}$	$7.5 \times 10$	1	$6.32529 \times 10^2$
1.16279	$1.16279 \times 10^{-3}$	$1.18572 \times 10^{-1}$	$1.58095 \times 10^{-3}$	1

#### Specific heat

J/(kg·K)	kcal/(kg·°C) cal/(g·°C)
1	$2.38889 \times 10^{-4}$
$4.18605 \times 10^3$	1

#### Thermal conductivity

W/(m·K)	kcal/(h·m·°C)
1	$8.6000 \times 10^{-1}$
1.16279	1

#### Revolution per minute

min <sup>-1</sup>	s <sup>-1</sup>	r.p.m.
1	0.0167	1
60	1	60

## Hardness calculating table

### Work piece hardness calculating table

Vickers 50kgf HV	Brinell 3000kgf HB		Rockwell				Shore HS	Tensile strength (approximate value) MPa (t)
	Standard ball 10mm	Cemented carbide ball 10mm	A scale 60kgf Diamond particle HRA	B scale 100kgf 1/16in ball HRB	C scale 150kgf Diamond particle HRC	D scale 100kgf Diamond particle HRD		
940	-	-	85.6	-	68.0	76.9	97	
920	-	-	85.3	-	67.5	76.5	96	
900	-	-	85.0	-	67.0	76.1	95	
880	-	(767)	84.7	-	66.4	75.7	93	
860	-	(757)	84.4	-	65.9	75.3	92	
840	-	(745)	84.1	-	65.3	74.8	91	
820	-	(733)	83.8	-	64.7	74.3	90	
800	-	(722)	83.4	-	64.0	74.8	88	
780	-	(710)	83.0	-	63.3	73.3	87	
760	-	(698)	82.6	-	62.5	72.6	86	
740	-	(684)	82.2	-	61.8	72.1	84	
720	-	(670)	81.8	-	61.0	71.5	83	
700	-	(656)	81.3	-	60.1	70.8	81	
690	-	(647)	81.1	-	59.7	70.5	-	
680	-	(638)	80.8	-	59.2	70.1	80	
670	-	630	80.6	-	58.8	69.8	-	
660	-	620	80.3	-	58.3	69.4	79	
650	-	611	80.0	-	57.8	69.0	-	
640	-	601	79.8	-	57.3	68.7	77	
630	-	591	79.5	-	56.8	68.3	-	
620	-	582	79.2	-	56.3	67.9	75	
610	-	573	78.9	-	55.7	67.5	-	
600	-	564	78.6	-	55.2	67.0	74	
590	-	554	78.4	-	54.7	66.7	-	2055
580	-	545	78.0	-	54.1	66.2	72	2020
570	-	535	77.8	-	53.6	65.8	-	1985
560	-	525	77.4	-	53.0	65.4	71	1950
550	(505)	517	77.0	-	52.3	64.8	-	1905
540	(496)	507	76.7	-	51.7	64.4	69	1860
530	(488)	497	76.4	-	51.1	63.9	-	1825
520	(480)	488	76.1	-	50.5	63.5	67	1795
510	(473)	479	75.7	-	49.8	62.9	-	1750
500	(465)	471	75.3	-	49.1	62.2	66	1705
490	(456)	460	74.9	-	48.4	61.6	-	1660
480	488	452	74.5	-	47.7	61.3	64	1620
470	441	442	74.1	-	46.9	60.7	-	1570
460	433	433	73.6	-	46.1	60.1	62	1530
450	425	425	73.3	-	45.3	59.4	-	1495
440	415	415	72.8	-	44.5	58.8	59	1460
430	405	405	72.3	-	43.6	58.2	-	1410
420	397	397	71.8	-	42.7	57.5	57	1370
410	388	388	71.4	-	41.8	56.8	-	1330
100	379	379	70.8	-	40.8	56.0	55	1290
390	369	369	70.3	-	39.8	55.2	-	1240
380	360	360	69.8	(100.0)	38.8	54.4	52	1205
370	350	350	69.2	-	39.9	53.6	-	1170
360	341	341	68.7	(109.0)	36.6	52.8	50	1130
350	331	331	68.1	-	35.5	51.9	-	1095
340	322	322	67.6	(108.0)	34.4	51.1	47	1070
330	313	313	67.0	-	33.3	50.2	-	1035

Vickers 50kgf HV	Brinell 3000kgf HB		Rockwell				Shore HS	Tensile strength (approximate value) MPa (t)
	Standard ball 10mm	Cemented carbide ball 10mm	A scale 60kgf Diamond particle HRA	B scale 100kgf 1/16in ball HRB	C scale 150kgf Diamond particle HRC	D scale 100kgf Diamond particle HRD		
320	303	303	66.4	(107.0)	32.2	49.4	45	1005
310	294	294	65.8	-	31.0	48.4	-	980
300	284	284	65.2	(105.5)	29.8	47.5	42	950
295	280	280	64.8	-	29.2	47.1	-	935
290	275	275	64.5	(104.5)	28.5	46.5	41	915
285	270	270	64.2	-	27.8	46.0	-	905
280	265	265	63.8	(103.5)	27.1	45.3	40	890
275	261	261	63.5	-	26.4	44.9	-	875
270	256	256	63.1	(102.0)	25.6	44.3	38	855
265	252	252	62.7	-	24.8	43.7	-	840
260	247	247	62.4	(101.0)	24.0	43.1	37	825
255	243	243	62.0	-	23.1	42.2	-	805
250	238	238	61.6	99.5	22.2	41.7	36	795
245	233	233	61.2	-	21.3	41.1	-	780
240	228	228	60.7	98.1	20.3	40.3	34	765
230	219	219	-	96.7	(18.0)	-	33	730
220	209	209	-	95.0	(15.7)	-	32	695
210	200	200	-	93.4	(13.4)	-	30	670
200	190	190	-	91.5	(11.0)	-	29	635
190	181	181	-	89.5	(8.5)	-	28	605
180	171	171	-	87.1	(6.0)	-	26	580
170	162	162	-	85.0	(3.0)	-	25	545
160	152	152	-	81.7	(0.0)	-	24	515
150	143	143	-	78.7	-	-	22	490
140	133	133	-	75.0	-	-	21	455
130	124	124	-	71.2	-	-	20	425
120	114	114	-	66.7	-	-	-	390
110	105	105	-	62.3	-	-	-	-
100	95	95	-	56.2	-	-	-	-
95	90	90	-	52.0	-	-	-	-
90	86	86	-	48.0	-	-	-	-
85	81	81	-	41.0	-	-	-	-

Note) 1. 1MPa = 1N/mm<sup>2</sup>  
 2. The number in the blank is not generally used ranges



## Properties of KORLOY grades

### Physical properties of KORLOY grades

Application	ISO Classification symbol	KORLOY grades	Specific gravity (g/cm <sup>3</sup> )	Hardness (HRA)	TRS (kgf/mm <sup>2</sup> )	Compressive strength (kgf/mm <sup>2</sup> )	Young's modulus (10 <sup>3</sup> kgf/mm <sup>2</sup> )	Thermal expansion coefficient (10 <sup>-6</sup> /°C)	Thermal conductivity (cal/cmsec°C)
Grades for cutting tools	P	P01	ST05	10.6	92.7	140	440	-	-
		P10	ST10	10.0	92.1	175	460	48	6.2
		P20	ST20	11.8	91.9	200	480	56	5.2
		P30	ST30A	12.2	91.3	230	500	53	5.2
	M	M10	U10	12.9	92.4	170	500	47	-
		M20	U20	13.1	91.1	210	500	-	-
		M30	ST30A	12.2	91.3	230	500	53	5.2
		M40	U40	13.3	89.2	270	440	-	-
	K	K01	H02	14.8	93.2	185	-	61	4.4
		K10	H01	13.0	92.9	210	570	66	4.7
K20		G10	14.7	90.9	250	500	63	-	
Ultra fine grain alloy	Z	Z10	FA1	14.1	91.4	290	-	58	5.7
		Z20	FCC	12.5	91.3	235	-	-	-
Grade for tungsten carbide wear parts	V	V1	D1	15.0	92.3	205	520	-	-
		V2	D2	14.8	90.9	250	150	-	-
		V3	D3	14.6	89.7	310	410	-	-
		V4	G5	14.3	89.0	320	380	-	-
		V5	G6	14.0	87.7	350	330	-	-
Grade for mining and civil engineering tools	E	E1	GR10	14.8	90.9	220	-	-	-
		E2	GR20	14.8	90.3	240	-	-	-
		E3	GR30	14.8	89.0	270	-	-	-
		E4	GR35	14.8	88.2	270	-	-	-
		E5	GR50	14.5	87.0	300	-	-	-

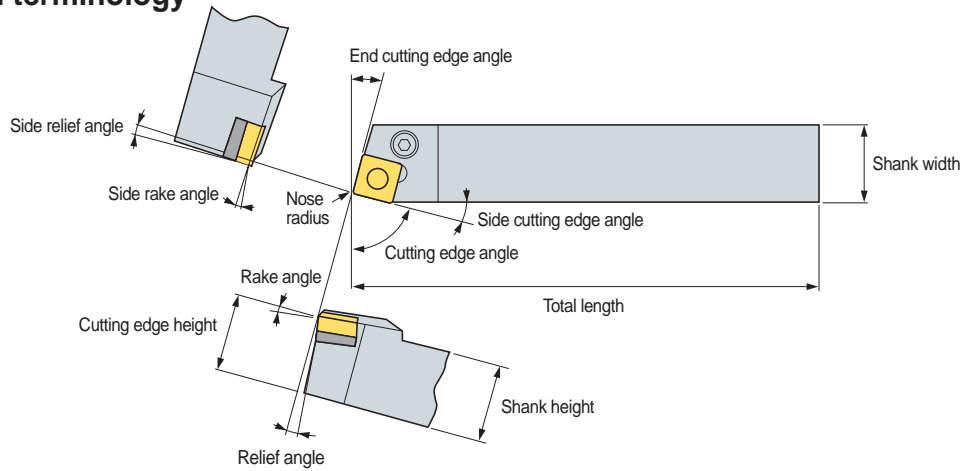
### The physical properties of element

Element	Specific gravity (g/cm <sup>3</sup> )	Hardness (HB)	Young's modulus (×10 <sup>3</sup> kgf/mm <sup>2</sup> )	Thermal conductivity (cal/cmsec°C)	Thermal expansion coefficient (×10 <sup>-6</sup> /°C)	Melting point (°C)
WC	15.6	2,150	70	0.3	5.1	2,900
TiC	4.94	3,200	45	0.04	7.6	3,200
TaC	14.5	1,800	29	0.05	6.6	3,800
NbC	8.2	2,050	35	0.04	6.8	3,500
TiN	5.43	2,000	26	0.07	9.2	2,950
Al <sub>2</sub> O <sub>3</sub>	3.98	3,000	42	0.07	8.5	2,050
cBN	3.48	4,500	71	3.1	4.7	-
Diamond	3.52	9,000	99	5.0	3.1	-
Co	8.9	-	10~18	0.165	12.3	1,495
Ni	8.9	-	20	0.22	13.3	1,455



# Technical Information for Turning

## Insert shape and terminology

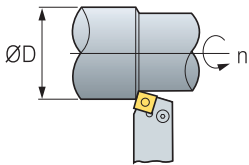


### Relating angles between tool and workpiece

Cutting edge inclination	Terminology	Function	Effect
Rake angle	Side rake angle Rake angle	• Cutting force, Cutting heat, The effects of chip control on tool life	<ul style="list-style-type: none"> <li>• (+): Excellent machine-ability(reducing cutting force, weakening cutting edge strength)</li> <li>• (+): When machining excellent machine-ability or thin workpiece</li> <li>• (-): When strong cutting edge is needed at interrupted condition or mill scale</li> </ul>
Relief angle	Relief angle Side relief angle	• Only cutting edge contact with cutting face	<ul style="list-style-type: none"> <li>• (-): Cutting edge is strong but has short tool life to make bad influence on flank wear</li> </ul>
Cutting edge angle	Cutting edge angle	• Affects chip control and cutting force direction	<ul style="list-style-type: none"> <li>• (+): Improved chip control because chip thickness is big</li> </ul>
	Side cutting edge angle	• Affects chip control and cutting force direction	<ul style="list-style-type: none"> <li>• (+): Strong cutting edge due to distributed cutting force but chip control is bad by thin chip thickness</li> <li>• (-): Improved chip performance</li> </ul>
	End cutting edge angle	• Prevent friction between cutting edge and cutting face	<ul style="list-style-type: none"> <li>• (-): Cutting edge is strong but has short tool life to make bad influence on flank wear</li> </ul>

## Calculation formulas for machining

### Cutting speed



$$vc = \frac{\pi \times D \times n}{1000} \text{ (m/min)}$$

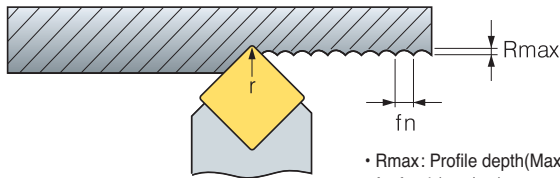
- vc: Cutting speed (m/min)
- D: Diameter (mm)
- n: Revolution per minute (min<sup>-1</sup>)
- π: Circular constant (3.14)

### Feed

$$fn = \frac{vf}{n} \text{ (mm/rev)}$$

- fn: Feed per revolution (mm/rev)
- vf: Table feed (mm/min)
- n: Revolution per minute (min<sup>-1</sup>)

### Surface finish



- Rmax: Profile depth(Maximum height roughness) (μ)
- fn: feed (mm/rev)
- r: nose radius

### Theoretical surface roughness

$$R_{max} = \frac{fn^2}{8r} 1000 (\mu\text{m})$$

### Practical surface roughness

Steel:  $R_{max} \times (1.5-3)$   
Cast iron:  $R_{max} \times (3-5)$

### Power requirement

$$P_{kw} = \frac{Q \times kc}{60 \times 102 \times \eta}$$

$$P_{HP} = \frac{P_{kw}}{0.75}$$

$$Q = \frac{vc \times fn \times ap}{1000}$$

- P<sub>kw</sub>: Power requirement [kW]
- P<sub>HP</sub>: Power requirement (horse power) [HP]
- vc: Cutting speed [m/min]
- ap: Depth of cut [mm]
- fn: Feed per revolution [mm/rev]
- kc: Specific cutting resistance [kg/mm<sup>2</sup>]
- η: Machine efficiency rate (0.7~0.8)

Rough Kc	
Mild steel	190
Medium carbon steel	210
High carbon steel	240
Low alloy steel	190
High alloy steel	245
Cast iron	93
Malleable cast iron	120
Bronze, Brass	70

### Material removal rate

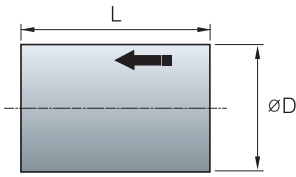
$$Q \text{ (cm}^3\text{/min)} = vc \times ap \times fn$$

- Q: Material removal rate [cm<sup>3</sup>/min]
- ap: Depth of cut [mm]
- vc: Cutting speed [m/min]
- fn: Feed per revolution [mm/rev]



## ● Machining time

### External face machining 1



#### Constant revolution per minute

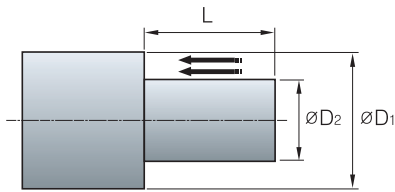
$$T = \frac{60 \times L}{fn \times n}$$

#### Constant cutting speed

$$T = \frac{60 \times \pi \times L \times D}{1000 \times fn \times vc}$$

T: Machining time [sec]  
L: Cutting length [mm]  
fn: Feed per revolution [mm/rev]  
n: Revolution per minute [min<sup>-1</sup>]  
D: Diameter of workpiece [mm]  
vc: Cutting speed [m/min]

### External face machining 2



#### Constant revolution per minute

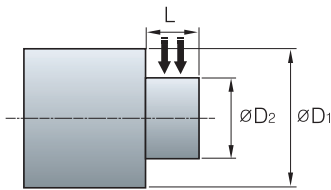
$$T = \frac{60 \times L}{fn \times n} \times N$$

#### Constant cutting speed

$$T = \frac{60 \times \pi \times L \times (D_1 + D_2)}{2 \times 1000 \times fn \times vc} \times N$$

T: Machining time [sec]  
L: Cutting length [mm]  
fn: Feed per revolution [mm/rev]  
n: Revolution per minute [min<sup>-1</sup>]  
D1: Maximum diameter of workpiece [mm]  
D2: Minimum diameter of workpiece [mm]  
vc: Cutting speed [m/min]  
N: The number of pass = (D1-D2)/d/2

### Facing



#### Constant revolution per minute

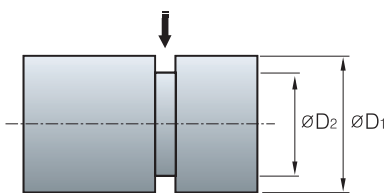
$$T = \frac{60 \times (D_1 - D_2)}{2 \times fn \times n} \times N$$

#### Constant cutting speed

$$T_1 = \frac{60 \times \pi \times (D_1 + D_2) \times (D_1 - D_2)}{4000 \times fn \times vc} \times N$$

T: Machining time [sec]  
T1: Machining time before the maximum rpm[sec]  
L: Width of machining [mm]  
fn: Feed per revolution [mm/rev]  
n: Revolution per minute [min<sup>-1</sup>]  
D1: Maximum diameter of workpiece [mm]  
D2: Minimum diameter of workpiece [mm]  
vc: Cutting speed [m/min]  
N: The number of pass = (D1-D2)/d/2

### Grooving



#### Constant revolution per minute

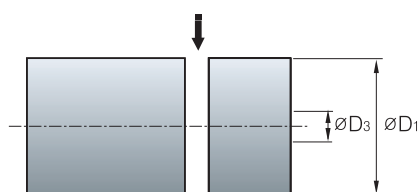
$$T = \frac{60 \times (D_1 - D_2)}{2 \times fn \times n}$$

#### Constant cutting speed

$$T_1 = \frac{60 \times \pi \times (D_1 + D_2) \times (D_1 - D_2)}{4000 \times fn \times vc}$$

T: Machining time [sec]  
T1: Machining time before the maximum rpm[sec]  
L: Width of machining [mm]  
fn: Feed per revolution [mm/rev]  
n: Revolution per minute [min<sup>-1</sup>]  
D1: Maximum diameter of workpiece [mm]  
D2: Minimum diameter of workpiece [mm]  
vc: Cutting speed [m/min]

### Parting



#### Constant revolution per minute

$$T = \frac{60 \times D_1}{2 \times fn \times n}$$

#### Constant cutting speed

$$T_1 = \frac{60 \times \pi \times (D_1 + D_3) \times (D_1 - D_3)}{4000 \times fn \times vc}$$

$$T_3 = T_1 + \frac{60 \times D_3}{2 \times fn \times n_{max}}$$

T: Machining time [sec]  
T1: Machining time before the maximum rpm[sec]  
T3: Machining time till maximum RPM[sec]  
fn: Feed per revolution [mm/rev]  
n: Revolution per minute [min<sup>-1</sup>]  
nmax: Maximum revolution per minute [min<sup>-1</sup>]  
D1: Maximum diameter of workpiece [mm]  
D3: Maximum diameter at maximum RPM [mm]  
vc: Cutting speed [m/min]



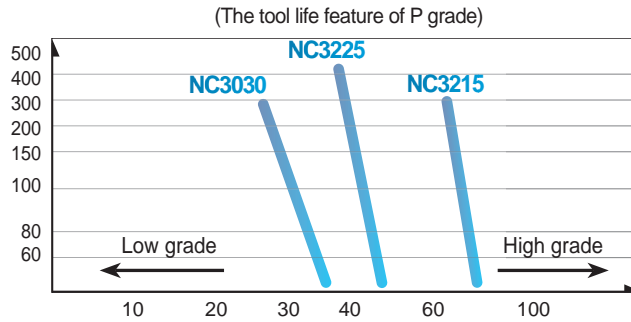
# Technical Information for Turning

## The affects of cutting condition

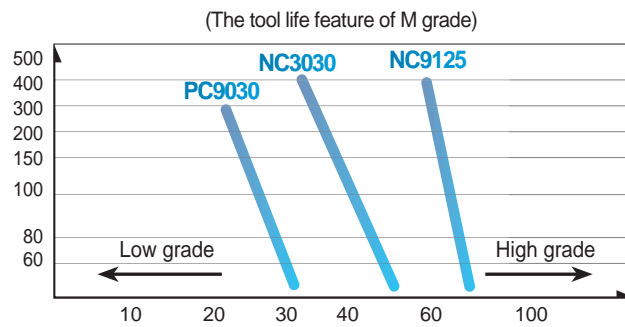
- The most desirable machining means short machining time, long tool life and good precision  
This is the reason that proper cutting condition for each tools should be selected according to material's properties, hardness, shapes, the efficiency of machine

## Cutting speed

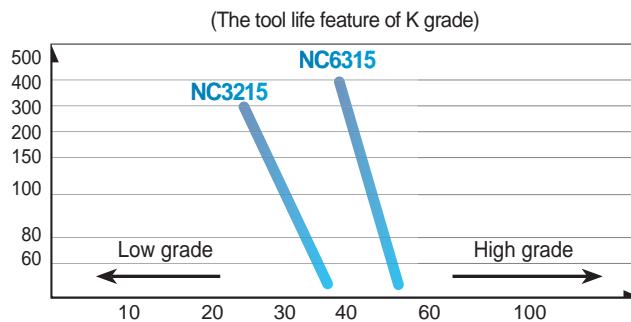
- Workpiece:** S45C (180HB)
- Tool life criterion:** VB = 0.2 mm
- Depth of cut:** 1.5 mm
- Feed:** 0.3 mm/rev
- Holder:** PCLNR2525-M12
- Insert:** CNMG120408, Dry cutting



- Workpiece:** STS304 (200HB)
- Tool life criterion:** VB = 0.2 mm
- Depth of cut:** 1.5 mm
- Feed:** 0.3 mm/rev
- Holder:** PCLNR2525-M12
- Insert:** CNMG120408, Dry cutting



- Workpiece:** GC300 (180HB)
- Tool life criterion:** VB = 0.2 mm
- Depth of cut:** 1.5 mm
- Feed:** 0.3 mm/rev
- Holder:** PCLNR2525-M12
- Insert:** CNMG120408, Dry cutting



## Cutting Speed's effects

- When the cutting speed increases up to 20% in an application, the tool life respectively decreases down 50%  
Although inversely, if the cutting speed increases up to 50% the tool life decreases 20%. On the other hand if cutting speed is too low (20-40m/min) Tool life shortens due to vibration



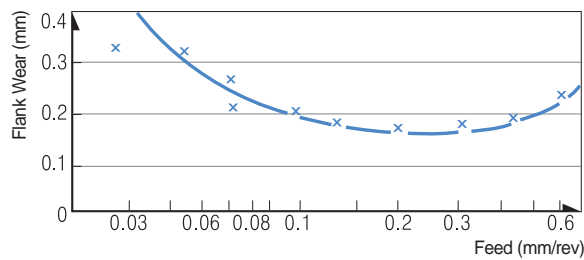
## ➤ Feed

- The feed rate in turning means the progressed interval of a distance in a work piece within 1 revolution  
The feed rate in a milling application means the table feed divided by number of teeth of cutter (feed rate per tooth)

## ➤ The effects of feed

- When the feed rate decreases the flank wear is increased. When the feed rate is too low, the tool life shortens radically
- When the feed rate increases, the flank wear increases due to high temperatures, however the feed rates effects tool life less than the cutting speed. And higher feed rates improve machining efficiency

(Relationship between feed and flank wear in steel turning)

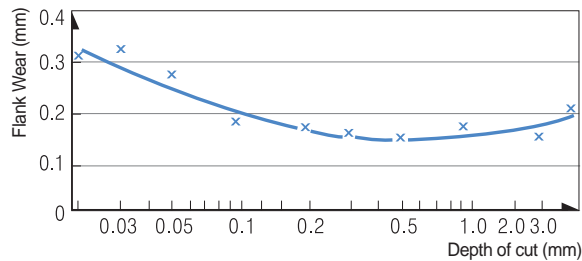


- **Workpiece:** SNCN431
- **Grade:** ST20
- **Cutting speed:** 200 m/min
- **Depth of cut:** 1.0 mm
- **Cutting time:** 10 min

## ➤ Depth of cut

- Determined by the required allowances in machining a material and the capacity the machine can tolerate  
There are cutting limits according to the different shapes and sizes of the insert

(Relationship between depth of cut and flank wear in steel turning)

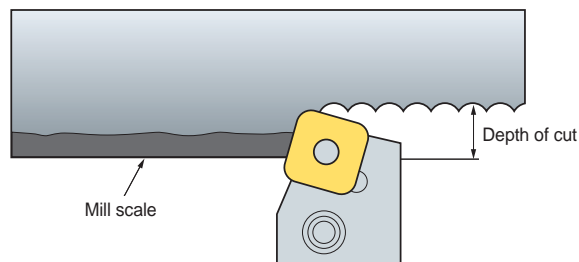


- **Workpiece:** SNCN431
- **Grade:** ST20
- **Cutting speed:** 200 m/min
- **Feed:** 0.2 mm/rev
- **Cutting time:** 10 min

## ➤ The effect of a depth of cut

- The depth of cut does not have a big influence on tool life
- When the depth of cut is small the work piece is not cut but rather rubbed. In these cases, machine off the work hardened parts that decrease tool life
- When machining a cast skin or milling scale smaller depth of cuts usually cause chipping and abnormal wear because of hard impurities in the surface of the work piece

(Surface parts including mill scale Roughing)



# Technical Information for Turning

## Relief angle

- Relief angle avoids the friction between workpiece and relief face and makes cutting edge move along workpiece easily

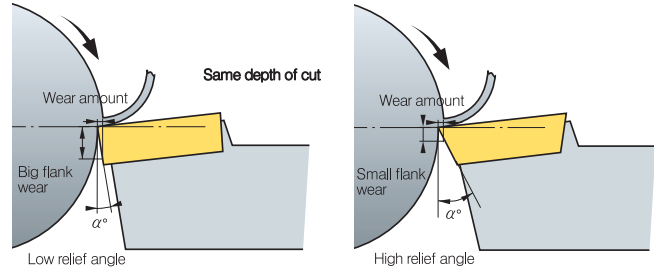
### Relationship between various relief angle and flank wear

#### Affects

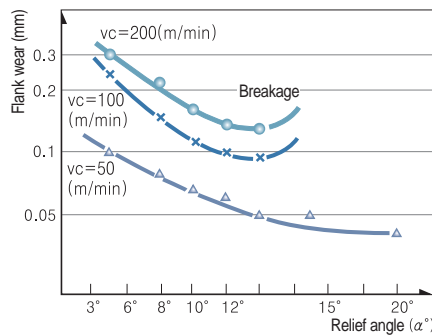
- If relief angle is big Flank wear decreases
- If relief angle is big Cutting edge strength weakens
- If relief angle is small Chattering occurs

#### Selection system

- Hard workpiece/When strong cutting edge is needed
  - Low relief angle
- Soft workpiece/Workpiece turning to work hardening easily
  - High relief angle



- Workpiece: SNCM431 (HB)
- Grade: P20
- Depth of cut: 1 mm
- Feed: 0.32 mm/rev
- Cutting time: 20 min



## Side cutting edge angle

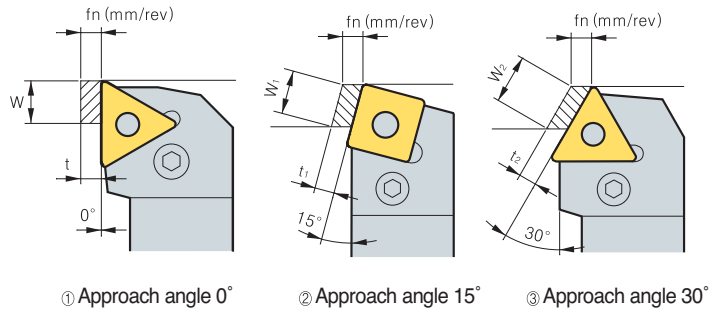
- Side cutting edge angle has big influence on chip flow and cutting force therefore proper Side cutting edge angle is very important

### Side cutting edge angle and chip thickness

- As side cutting edge angle is getting bigger chips are getting thinner and wider (refer to left picture)
- At the same feed and depth of cut with approach angle 0° Chip thickness is the same as feed ( $t = f_n$ ) and chip width is equal to depth of cut ( $W = ap$ )

$$t_1 = 0.97t, W_1 = 1.04W$$

$$t_2 = 0.87t, W_2 = 1.15W$$



### Side cutting edge angle and 3 cutting forces

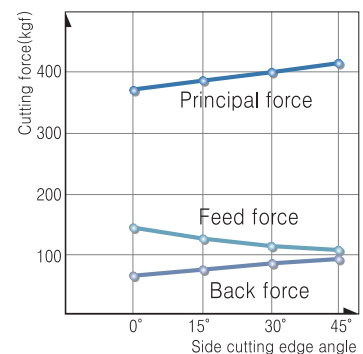
#### Affects

- Big side cutting edge angle with the same feed makes chip attaching length longer and chip thickness thinner. So that cutting forces scatter to long cutting edge therefore tool life gets longer
- Big side cutting edge angle for machining long bars can cause bending

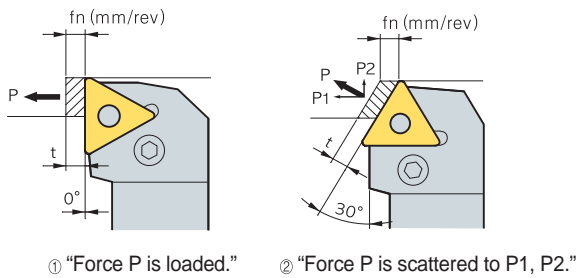
#### Selection system

- Deep depth of cut finishing/Long thin workpiece/Low machine rigidity
  - Side cutting edge angle
- Hard and high calorific power workpiece/Roughing big workpiece/High machine rigidity - Side cutting edge angle

- Workpiece : SCM440 (HB250)
- Grade: TNGA220412
- vc: 100 m/min
- ap: 4 mm
- fn: 0.45 mm/rev



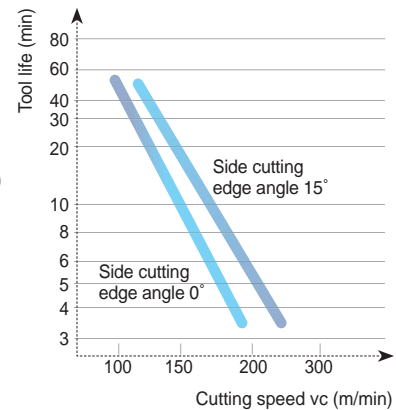
## ● Side cutting edge angle and cutting load



As approach angle gets bigger Back force gets bigger and feed force gets smaller

## ● Side cutting edge angle and tool life

- Workpiece: SCM440
- Grade: P20
- Depth of cut: 3 mm
- Feed: 0.2 mm/rev



## ● Side cutting edge angle and cutting performance

Specification	Low	← Approach angle →	High
Wear rate	High		Low
Workpiece	Easy to cut material		Difficult to cut material
Machining power	Small		Big
Chatter	Hard to occur		Easy to occur
How to machine	Finishing		Roughing
Workpiece rigidity	Long thin workpiece		Thick workpiece
Machine rigidity	In case of low rigidity		In case of high rigidity

## 🔍 End cutting edge angle

- It affects machined surface to prevent interference between surface of workpiece and insert

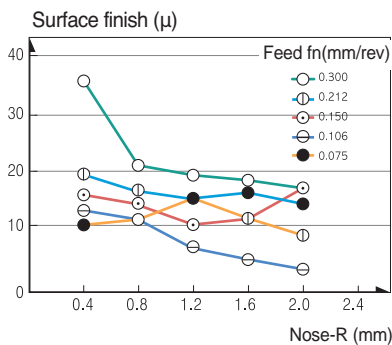
### Affects

1. If end cutting edge angle reduces cutting edge get stronger but cutting heat generated by machining increases
2. Small end cutting edge angle can cause chattering due to the increases cutting force

## 🔍 Nose-R

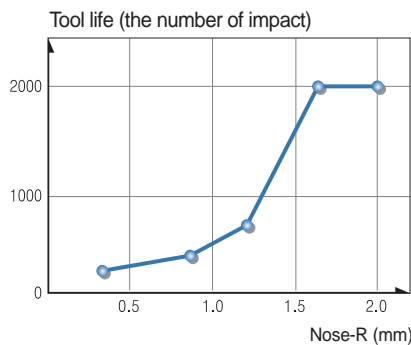
- Nose-R affects not only surface roughness but strength of cutting edge
- In general, It's desirable that Nose-R is 2~3 times bigger than feed

### ● Nose R and surface finish



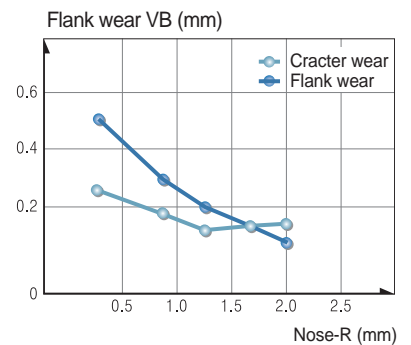
- Workpiece: SNCM439, HB200
- Grade: P20
- $v_c$ : 120 m/min
- $ap$ : 0.5 mm

### ● Nose R and tool life



- Workpiece: SCM440, HB280
- Grade: P10
- $v_c$ : 100 m/min,  $ap$ : 0.5 mm
- $fn$ : 0.3 mm/rev

### ● Nose R and wear of tool



- Workpiece: SNCM439, HB200
- Grade: P10
- $v_c$ : 140 m/min,  $ap$ : 2 mm
- $fn$ : 0.2 mm/rev, T: 10 min



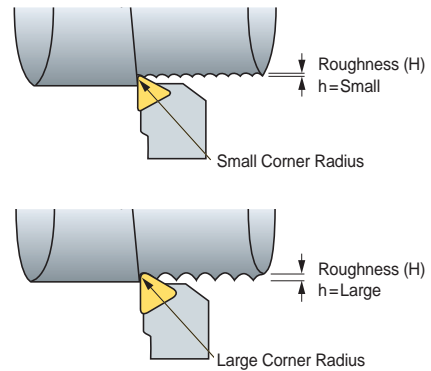
## Nose-R

### Affects

1. Big Nose-R improves surface finish
2. Big Nose-R improves cutting edge strength
3. Big Nose-R reduces flank wear and crater wear
4. Too big Nose-R causes chattering due to increased cutting force

### Selection system

1. For finishing with small depth of cut/long and thin workpiece/  
When machine power is low - Small Nose-R
2. For applications that need strong cutting edge such as intermittent  
and machining mill scale/For roughing of big workpiece/When  
the machine power is strong enough - Big Nose-R



## Relationship between nose radius, feed and various surface roughness

Nose R \ Feed (mm/rev)	0.4	0.8	1.2
0.15			
0.26			
0.46			

## Cutting edge shape and the affects

### Rake angle ( $\alpha$ )

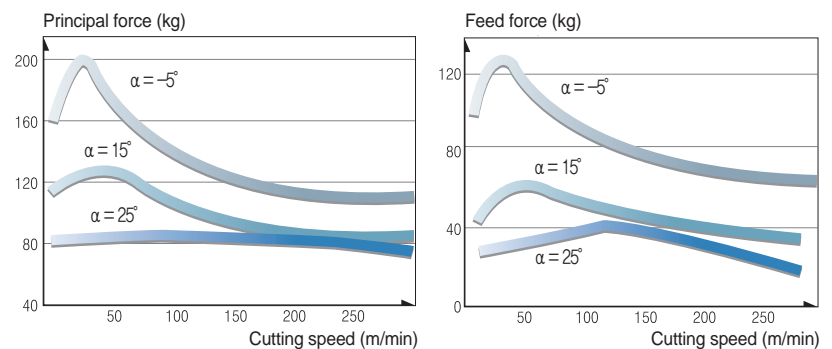
Rake angle has big influence on cutting force, chip flow and tool life

### Affects

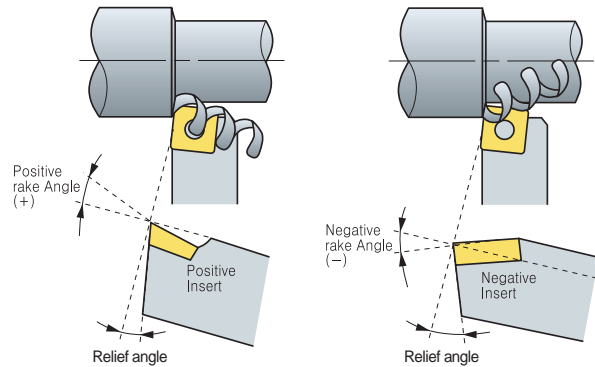
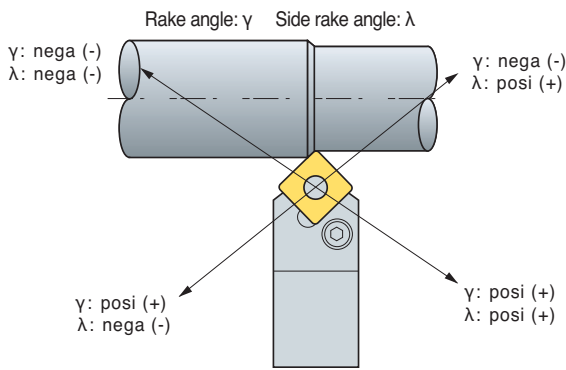
1. High rake angle results in good surface finish
2. As the rake angle increases by 1° Machining power decreases by 1%.
3. High rake angle weakens cutting edge

### Selection system

1. For hard workpiece/For applications that need strong cutting edge such as interrupted and machining mill scale - Low rake angle
2. For soft workpiece/Easy to cut material/When the rigidity of machine power and workpiece is low - High rake angle



## ● Rake angle and the direction of chip flow



In order to prevent machined surface from damages Avoid nega, posi combination.  
 $\gamma$ : nega (-)  $\lambda$ : posi (+)

## ➤ Selecting proper tools

- Nowadays, It's very difficult to select the best tools in complicating tooling system and various cutting conditions  
 However, It can be simplified by classifying basic factors below

### ● Selection of inserts and tool holder

Listed below is the basic factors and choose B according to A

#### A : Basic factors

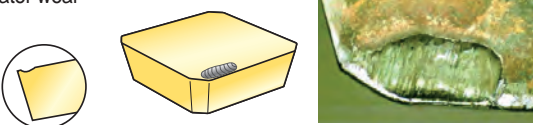
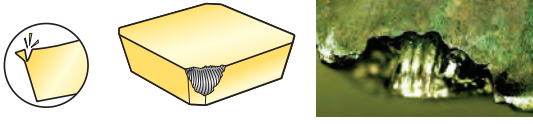
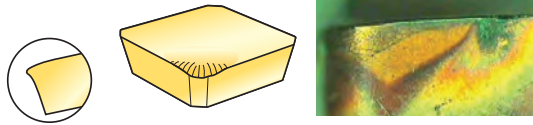

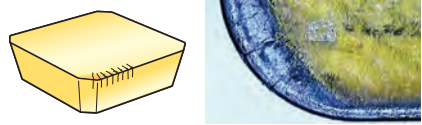




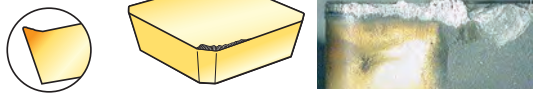
- Workpiece material
- Workpiece shape
- Workpiece size
- Hardness of workpiece
- Surface roughness of workpiece (before machining)
- Surface finish required
- Type of lathe machine
- Condition of lathe machine (rigidity, power etc)
- Horse power of machine
- Clamping method of workpiece

#### B : Selection system

- ① Select as big approach angle as possible
- ② Select as big shank as possible
- ③ Select as strong cutting edge of insert as possible
- ④ Select as big nose radius as possible
- ⑤ In finishing, Select the insert using many corners
- ⑥ Select as small insert as possible
- ⑦ Cutting speed should be determined carefully according to cutting conditions
- ⑧ Select as deep depth of cut as possible
- ⑨ Select as fast feed as possible
- ⑩ Cutting condition should be determined within chip breaker application ranges

# Technical Information for Turning

## Trouble shooting

Tool failure	Cause	Solution
<p>Crater wear</p> 	<ul style="list-style-type: none"> <li>• Improper grade</li> <li>• Excessive cutting condition</li> </ul>	<ul style="list-style-type: none"> <li>• Choose harder grade</li> <li>• Decrease cutting condition</li> </ul>
<p>Fracture</p> 	<ul style="list-style-type: none"> <li>• Improper grade</li> <li>• Excessive feed</li> <li>• Shorten cutting edge strength</li> <li>• Insufficient rigidity of holder</li> </ul>	<ul style="list-style-type: none"> <li>• Choose tougher grade</li> <li>• Decrease feed</li> <li>• Apply to large honed or chamfered edge</li> <li>• Choose bigger size holder</li> </ul>
<p>Plastic deformation</p> 	<ul style="list-style-type: none"> <li>• Improper grade</li> <li>• Excessive cutting condition</li> <li>• High cutting temperature</li> </ul>	<ul style="list-style-type: none"> <li>• Choose harder grade</li> <li>• Decrease cutting condition</li> <li>• Choose grade with heat conductivity are big</li> </ul>
<p>Wear on nose radius (Flank wear)</p> 	<ul style="list-style-type: none"> <li>• When the hardness of workpiece is too high compare with tool</li> <li>• When machining surface hardened workpiece</li> <li>• Improper grade</li> <li>• Excessive cutting speed</li> <li>• Too small relief angle</li> <li>• Too low feed</li> </ul>	<ul style="list-style-type: none"> <li>• Choose harder grade</li> <li>• Decrease cutting speed</li> <li>• Choose larger relief angle</li> <li>• Increase feed</li> </ul>
<p>Thermal crack</p> 	<ul style="list-style-type: none"> <li>• Expansion and shrinking by cutting temperature</li> <li>• Improper grade (*Specially milling operation)</li> </ul>	<ul style="list-style-type: none"> <li>• Apply to dry cutting (In case of wet cutting, use enough coolant)</li> <li>• Choose tougher grade</li> </ul>
<p>Chipping</p> 	<ul style="list-style-type: none"> <li>• Improper grade</li> <li>• Excessive feed</li> <li>• Shorten cutting edge strength</li> <li>• Insufficient rigidity of holder</li> </ul>	<ul style="list-style-type: none"> <li>• Choose tougher grade</li> <li>• Decrease feed</li> <li>• Apply to large honing or chamfer edge</li> <li>• Choose bigger size holder</li> </ul>
<p>Notch wear</p> 	<ul style="list-style-type: none"> <li>• Surface hardened workpiece</li> <li>• Friction due to bad chip geometry (Generate vibration)</li> </ul>	<ul style="list-style-type: none"> <li>• Choose harder grade</li> <li>• Improve chip control form large rake angle</li> </ul>
<p>Flaking</p> 	<ul style="list-style-type: none"> <li>• Deposition on cutting edge</li> <li>• Bad chip control</li> </ul>	<ul style="list-style-type: none"> <li>• Improve cutting performance from large rake angle</li> <li>• Apply to chip pocket with big size</li> </ul>
<p>Complete breakage</p> 	<ul style="list-style-type: none"> <li>• Unusable condition due to wear off the most parts of cutting edge by progress of wear</li> </ul>	<ul style="list-style-type: none"> <li>• Reduce the feed rate.</li> <li>• Reduce the depth of cut.</li> <li>• Select a tougher grade.</li> <li>• Select a stronger chipbreaker.</li> <li>• Select a thicker insert.</li> </ul>
<p>Built-up edge</p> 	<ul style="list-style-type: none"> <li>• Slow cutting speed</li> <li>• Sticky materials</li> </ul>	<ul style="list-style-type: none"> <li>• Increase cutting speed.</li> <li>• Use more positive rake geometry.</li> <li>• Use tougher grade</li> </ul>





## Types of tool failure and trouble shooting

Troubles	Causes	Solution																
		Cutting conditions				Selecting insert grade				Tool shape				Machine clamping				
		Cutting speed	Feed	Depth of cut	Coolant	Select harder grade	Select tougher grade	Select better heat-impact resistance grade	Select better adhesion resistance grade	Chip breaker valuation	Rake angle	Nose radius	Side cutting edge angle	Cutting edge strength Honing	Improving insert precision M class → G class	Improving holder rigidity	Clamping workpiece	Holder overhang
<b>Poor precision</b> Unstable machining size	Insert precision is variable													●				
	Workpiece, Separation of tool								●	↑	↓				●	●	●	●
<b>Cutting edge back thrust is big</b> It's necessary to adjust because machining precision changes during operation.	Flank wear increase					●					↑							
	Cutting condition is improper	↓	↑			●												
<b>Poor surface roughness for finishing</b> Criterion of tool life.	Weakened cutting force by increasing wear of tool	↓			Wet cutting			●	●	↑	↑		↓	●				
	Cutting edge chipping		↓	↓		●			●		↑		↑			●	●	●
	Adhesion, built-up edge	↑	↑		Wet cutting			●	●	↑			↓	●				
	Improper cutting conditions	↑	↓	↓	Wet cutting													
	Improper tool and shape of cutting edge								●		↑		↓	●				
	Vibration, chattering	↓	↓	↓	Wet cutting	●			●	●	↑	↓		↓		●	●	●
<b>Cutting heat generation</b> Poor machining precision and short tool life by cutting heat	Improper cutting conditions	↓	↓	↓		●												
	Improper tool and shape of cutting edge								●	↑			↓					
<b>Burr, chipping, nap</b> steel, aluminum (burr)	Improper cutting conditions	↓	↑		Wet cutting	●												
	Wear on the tool, improper shape of cutting edge							⊙	●	↑	↓		↓					
<b>Cast iron (Weak chipping)</b>	Improper cutting conditions		↓	↓		●												
	Wear on the tool, improper shape of cutting edge								●	↑	↑		↓		●	●	●	●
<b>Soft steel (nap)</b>	Improper cutting conditions	↑	↑		Wet cutting	●												
	Wear on the tool, improper shape of cutting edge							⊙	●	↑			↓					

↑: Increase ↓: Decrease ●: use ⊙: Correct use

## Tool life criterion

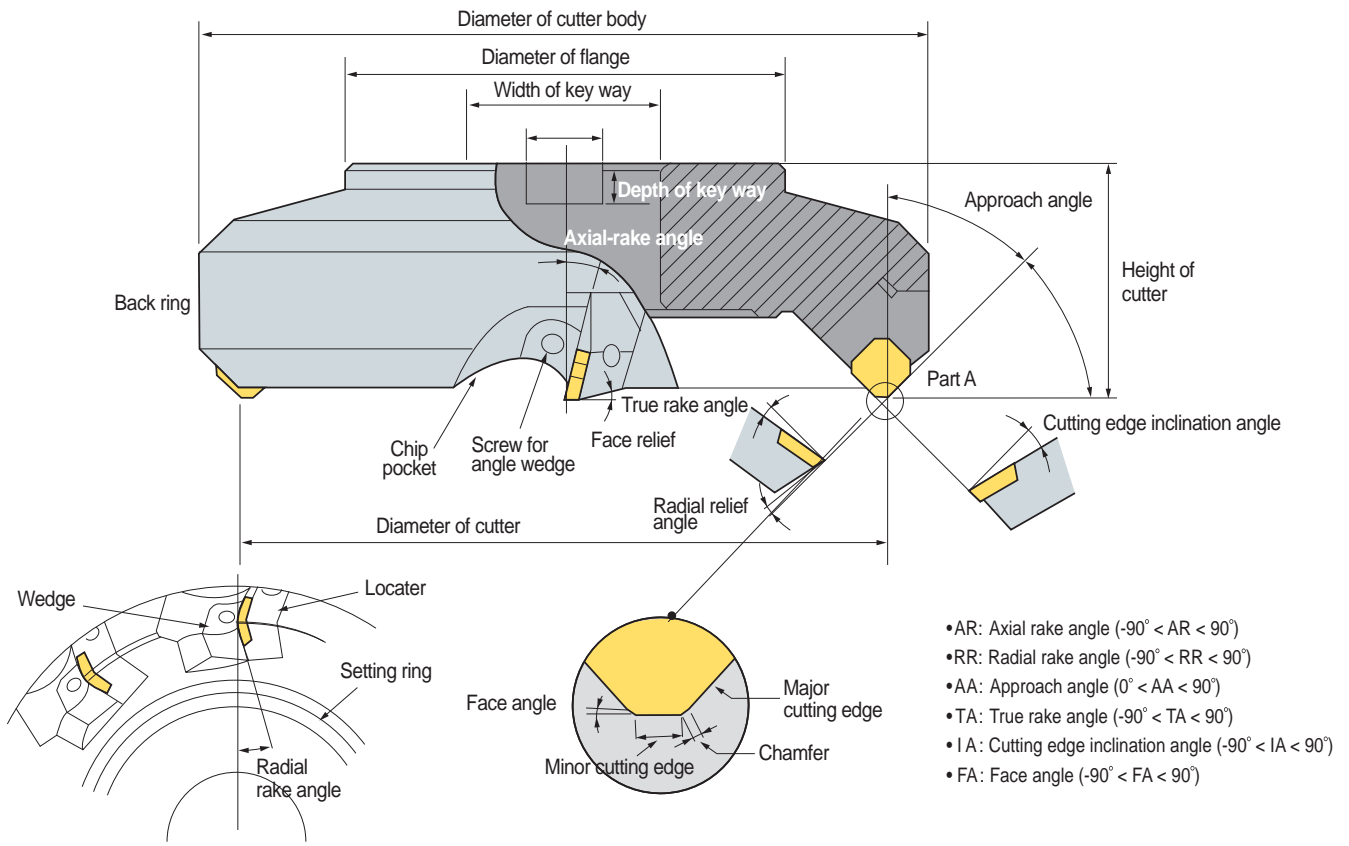
### ● KS B0813

Flank wear width	Value	Application
	0.2 mm	Precision light cutting, Finishing in nonferrous alloy
	0.4 mm	Machining special steel
	0.7 mm	General cutting in cast iron, steel etc
	1~1.25 mm	General cutting in cast iron, steel etc
Depth of crater wear	In general 0.05~0.1 mm	

### ● ISO (B8688)

Tool life criterion	Application
Complete breakage	Machining special steel
Flank wear width VB = 0.3 mm	Even flank wear of cemented carbides, Ceramic tool
VBmax = 0.5 mm	Uneven flank wear
Crater wear width KT = 0.06+0.3fmm (f:mm/rev)	Cemented carbides tool
Criterion by surface roughness 1, 1.6, 2.5, 4, 6.3, 10 $\mu$ Ra	When surface roughness is important

## Milling cutter shape and designation



### The terminology and functions of cutting edge angle

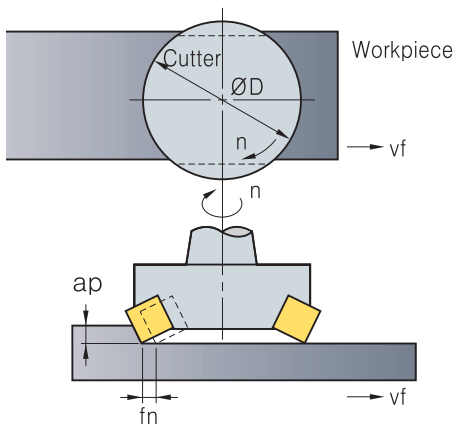
No.	Tool failure	Symbol	Function	Effects
1	Axial rake angle	A.R	Chip flow direction, Adhesion	Positive: Excellent cutting, built-up edge prevented
2	Radial rake angle	R.R	Affecting on thrust	Negative: Excellent chip control
3	Approach angle	A.A	Chip thickness, Determines flow direction	(+): Chip thickness become thinner, cutting force could be reduced
4	True rake angle	T.A	Effective rake angle	(+): Better cutting. Preventing adhesion, Weakening cutting edge strength (-): Cutting edge strength increases, easy to adhere
5	Cutting edge inclination angle	I.A	Determines chip flow direction	(+): Good chip flow, cutting force could decrease, Corner edge strength weakens
6	Relief angle	F.A	Controlling cutting edge strength, tool life and chattering	Surface roughness increases as F.A gets close to 0 degree



## Features by combination of rake angle

	Double positive angle	Double negative angle	Posi - Negative angle	Nega - Positive angle
Division				
Use	<ul style="list-style-type: none"> <li>General machining of steel, cast iron, stainless steel</li> <li>Machining soft steel that brings about built-up edge easily</li> <li>Machining material having tendency to poor surface roughness</li> </ul>	<ul style="list-style-type: none"> <li>Under interrupted cutting condition</li> <li>Roughing of cast iron and steel</li> </ul>	<ul style="list-style-type: none"> <li>Machining difficult to cut material</li> <li>Roughing with deep depth of cut and wide width of cut in steel and cast iron</li> </ul>	<ul style="list-style-type: none"> <li>Chip flows to center of cutter body</li> </ul>
Advantages	<ul style="list-style-type: none"> <li>As for tough workpiece material It prevents built-up edge to improve surface roughness</li> <li>Low cutting load and better machinability</li> </ul>	<ul style="list-style-type: none"> <li>Strong cutting edge</li> <li>Roughing of workpiece that has bad surface condition containing sand, mill scale</li> <li>Double sided inserts can be applied(Economical)</li> <li>Good chip control</li> </ul>	<ul style="list-style-type: none"> <li>Good chip flow and machinability.</li> <li>Suitable for machining of difficult-to-cut material</li> </ul>	-
Disadvantages	<ul style="list-style-type: none"> <li>Weak cutting edge strength</li> <li>Only single sided inserts are available (No economical)</li> <li>Machine and cutter need enough power and rigidity</li> </ul>	<ul style="list-style-type: none"> <li>Machine and cutter need enough power and rigidity</li> </ul>	<ul style="list-style-type: none"> <li>Only single sided inserts are available (No economical)</li> </ul>	<ul style="list-style-type: none"> <li>Since the chips flows toward the center of cutter. Chips scratch on machined surface</li> <li>Bad chip flow</li> <li>No economical</li> </ul>

## Major cutting formulas



### ● Cutting speed

$$vc = \frac{\pi \cdot D \cdot n}{1000} \text{ (m/min)}$$

- vc: Cutting speed (m/min)
- D: Diameter of tool (mm)
- n: Revolution per minute (min<sup>-1</sup>)
- π: Circular constant (3.14)

### ● Feed

$$fz = \frac{vf}{z \cdot n} \text{ (mm/t)}$$

- fz: Feed per tooth (mm/t)
- vf: Feed per minute (mm/min)
- n: Revolution per minute (min<sup>-1</sup>)
- z: Number of tooth

### ● Chip removal amount

$$Q = \frac{L \cdot v_f \cdot a_p}{1000} \text{ (cm}^3\text{/min)}$$

- Q: Chip removal amount (cm<sup>3</sup>/min)
- L: Width of cut (mm)
- vf: Table feed (mm/min)
- ap: Depth of cut (mm)

### ● Power requirement

$$P_{kw} = \frac{Q \cdot k_c}{60 \times 102 \cdot \eta} \quad P_{hp} = \frac{P_{kw}}{0.75}$$

- Pc: Power requirement (kW)
- H: Horse power requirement (hp) (mm/min)
- Q: Chip removal amount (cm<sup>3</sup>/min)
- kc: Specific cutting resistance (kgf/mm<sup>2</sup>)
- η: Machine efficiency rate (0.7~0.8)

### ● Machining time

$$T = \frac{60 \times L_t}{vf} \text{ (sec)}$$

- T: Machining time (sec)
- Lt: Total length of table feed (mm) (= Lw+D+2R)
- Lw: The length of workpiece (mm)
- D: The diameter of cutter body (mm)
- vf: Table feed (mm/min)
- R: Relief length (mm)

### ● True rake angle/Cutting edge inclination angle

True rake angle  $\tan(T) = \tan(R) \times \cos(AA) + \tan(A) \times \sin(C)$   
 Cutting edge inclination angle  $\tan(I) = \tan(A) \times \cos(AA) - \tan(R) \times \sin(C)$

# Technical Information for Milling

## Values of specific cutting resistance

Workpiece	Tensile strength (kg/mm <sup>2</sup> ) and hardness	Specific cutting resistance according to various feed kc(MPa)				
		0.1 (mm/t)	0.2 (mm/t)	0.3 (mm/t)	0.4 (mm/t)	0.6 (mm/t)
Soft steel	52	220	195	182	170	158
Medium carbon steel	62	198	180	173	160	157
High carbon steel	72	252	220	204	185	174
Tool steel	67	198	180	173	170	160
Tool steel	77	203	180	175	170	158
Chrome manganese steel	77	230	200	188	175	166
Chrome manganese steel	63	275	230	206	180	178
Chrome molybdenum steel	73	254	225	214	200	180
Chrome molybdenum steel	60	218	200	186	180	167
Nickel Chrome molybdenum steel	94	200	180	168	160	150
Nickel Chrome molybdenum steel	HB352	210	190	176	170	153
Cast steel	52	280	250	232	220	204
Hardened cast iron	HrC46	300	270	250	240	220
Meehanite cast iron	36	218	200	175	160	147
Gray cast iron	HB200	175	140	124	105	97
Brass	50	115	95	80	70	63
Light alloy (Al - Mg)	16	58	48	40	35	32
Light alloy (Al - Si)	20	70	60	52	45	39

## Chip removal amount (cm<sup>3</sup>/min) per rated horse power

Workpiece	Rated horse power	Chip removal amount (cm <sup>3</sup> /min)					
		5Hp	10Hp	20Hp	30Hp	40Hp	50Hp
Steel	Soft	32	75	163	295	425	570
	Medium	26	55	127	212	310	425
	hard	18	41	93	163	228	310
Cast iron	Soft	52	116	260	455	670	880
	Medium	32	75	163	295	425	570
	hard	26	55	127	212	310	425
Bronze Brass	Soft	77	163	390	670	980	1,280
	Medium	54	118	275	490	700	910
	hard	26	55	127	245	325	425
Aluminum		90	195	440	780	1,110	1,500

## Classification of surface roughness

Type	Symbol	How to calculate	Measured value
Maximum height	Rmax	<ul style="list-style-type: none"> <li>The distance between the top of profile peak line and the bottom of profile valley line on this sampled portion is measured in the longitudinal magnification direction of roughness curve ( Expressed by unit: μ )</li> <li>Exclude extraordinary values (too small or big) that look like grooves or mountains</li> </ul>	
+10 point mean roughness	Rz	<ul style="list-style-type: none"> <li>Sampled from the roughness curve in the direction of its mean line, the sum of the average value of absolute value of the highest profile peaks and the depths of five deepest profile valleys measured in the vertical magnification is expressed by micro meter ( μ )</li> </ul>	
Arithmetic mean roughness	Ra	<ul style="list-style-type: none"> <li>Sampling only the reference length from the roughness curve in the direction of mean line, taking X-axis in the direction of mean line and Y-axis in the direction of longitudinal magnification of this sampled part and is expressed by micro meter ( μ )</li> <li>Generally, Read measured value by Ra measurer</li> </ul>	

Finish mark		▽▽▽▽	▽▽▽	▽▽	▽	~
Surface roughness	Rmax	0.8s	6.3s	25s	100s	Unspecified
	Rz	0.8z	6.3z	25z	100z	
	Ra	0.2a	1.6a	6.3a	25a	

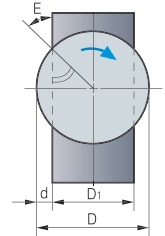
## Selection of MILL-MAX diameter (D)

### Selection by machine rigidity

Machine horse power (PS)	10~15	15~20	Over 20
Proper cutter body specification (mm)	Ø80~Ø100	Ø125~Ø160	Ø160~Ø200

### Selection by machine rigidity

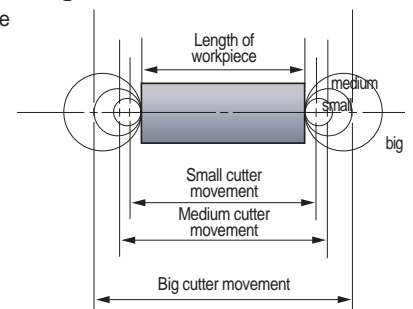
Workpiece	E	δ
Steel	+20°~-10°	3 : 2
Cast iron	Under +50°	5 : 4
Light alloy	Under +40°	5 : 3



D: External diameter of cutter body  
 D1: Width of workpiece  
 d: Projected part of cutter body  
 E: Engage angle  
 δ: Ratio of cutter body and width of workpiece (D: D1)

### Selection by machining time

The bigger size cutter the longer machining time



### Selection by number of tooth

Workpiece	Steel	Cast iron	Light alloy
Number of tooth	Dx (1~1.5)	Dx (1~4)	Dx1+α

ex) D = ø100 ⇒ 4" x(1~1.5) = 4~6      D is the size of cutter body converted into inch size



## 🔍 Trouble shooting for milling

Trouble	Causes	Solutions										
		Cutting conditions				Tool shape					Insert grade	
		Cutting speed	Depth of cut	Feed	Coolant	Rake angle	Relief angle	Approach angle	Chattering at cutting edge	Nose radius	Toughness	Hardness
<b>Flank wear</b>	<ul style="list-style-type: none"> <li>• Improper insert grade</li> <li>• Improper cutting conditions</li> <li>• Chattering</li> </ul>	↓		↑			↑	↓		↑		↑
<b>Crater wear</b>	<ul style="list-style-type: none"> <li>• Improper cutting conditions</li> <li>• Improper insert grade</li> </ul>	↓	↓	↓	●	↑	↑			↓		↑
<b>Chipping</b>	<ul style="list-style-type: none"> <li>• Lack of insert toughness</li> <li>• Excessive feed</li> <li>• Excessive cutting load</li> </ul>			↓		↓	↓	↓		↑	↑	
<b>Built-up edge</b>	<ul style="list-style-type: none"> <li>• Improper cutting conditions</li> <li>• Improper cutting edge shape</li> <li>• Improper insert grade</li> </ul>	↑	↓			↑				↓		
<b>Chattering</b>	<ul style="list-style-type: none"> <li>• Improper cutting conditions</li> <li>• Lack of number of cutting teeth</li> <li>• Improper cutting edge shape</li> <li>• Bad chip flow</li> <li>• Unstable workpiece clamping</li> </ul>		↓	↓	●	↑		↑	↓	↓		
<b>Poor surface finish</b>	<ul style="list-style-type: none"> <li>• Built-up edge</li> <li>• Improper cutting conditions</li> <li>• Chattering</li> <li>• Bad chip flow</li> </ul>	↑	↓	↓	●	↑			↓	↑		
<b>Thermal crack</b>	<ul style="list-style-type: none"> <li>• Improper cutting conditions</li> <li>• Improper insert grade</li> </ul>	↓	↓	↓	⊙	↑				↑	↑	
<b>Fracture</b>	<ul style="list-style-type: none"> <li>• Improper insert grade</li> <li>• Excessive cutting load</li> <li>• Bad chip flow</li> <li>• Chattering</li> <li>• Excessive overhang</li> </ul>		↓	↓	●							↑

↑: Increase ↓: Decrease ●: use ⊙: Correct use

## 🔍 General formulas for milling

### ● Machine efficiency rate ( $\eta$ )

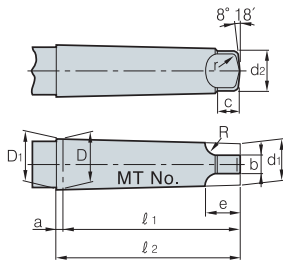
Power transmission mode	Efficiency rate (E)	Reference
Principal axis direct connection driving	0.90	
Belt driving	0.85	Double connection: $0.85 \times 0.85 = 0.70$
Starting driving	0.75	
Oil pressure driving	0.60~0.90	



# Technical Information for Tapers

(mm)

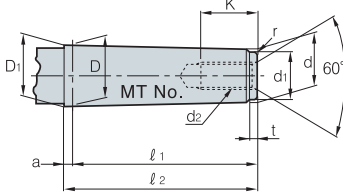
## Morse taper (Tang type)



MT No.	Taper	Taper angle (α)	D	a	D <sub>1</sub>	d <sub>1</sub>	ℓ <sub>1</sub>	ℓ <sub>2</sub>	d <sub>2</sub>	b	c	e	R	r
0	$\frac{1}{19.212}$	1°29'27"	9.045	3	9.201	6.104	56.5	59.5	6.0	3.9	6.5	10.5	4	1
1	$\frac{1}{20.047}$	1°25'43"	12.065	3.5	12.240	8.972	62.0	65.5	8.7	5.2	8.5	13.5	5	1.2
2	$\frac{1}{20.020}$	1°25'50"	17.780	5	18.030	14.034	75.0	80.0	13.5	6.3	10	16	6	1.6
3	$\frac{1}{19.922}$	1°26'16"	23.825	5	24.076	19.107	94.0	99.0	18.5	7.9	13	20	7	2
4	$\frac{1}{19.254}$	1°29'15"	31.267	6.5	31.605	25.164	117.5	124.0	24.5	11.9	16	24	8	2.5
5	$\frac{1}{19.002}$	1°30'26"	44.399	6.5	4.741	36.531	149.5	156.0	35.7	15.9	19	29	10	3
6	$\frac{1}{19.180}$	1°29'36"	63.348	8	63.765	52.399	210.0	218.0	51.0	19.0	27	40	13	4
7	$\frac{1}{19.231}$	1°29'22"	83.058	10	83.578	68.186	286.0	296.0	66.8	28.6	35	54	19	5

(mm)

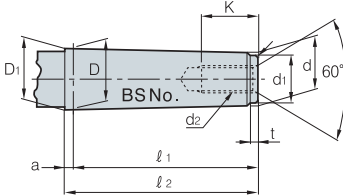
## Morse taper (Screw type)



MT No.	Taper	Taper angle (α)	D	a	D <sub>1</sub>	d	ℓ <sub>1</sub>	ℓ <sub>2</sub>	d <sub>1</sub>	d <sub>2</sub>	k	t	r
0	$\frac{1}{19.212}$	1°29'27"	9.045	3	9.201	6.442	50	53	6	-	-	4	0.2
1	$\frac{1}{20.047}$	1°25'43"	12.065	3.5	12.230	9.396	53.5	57	9	M6	16	5	0.2
2	$\frac{1}{20.020}$	1°25'50"	17.780	5	18.030	14.583	64	69	14	M10	24	5	0.2
3	$\frac{1}{19.922}$	1°26'16"	23.825	5	24.076	19.759	81	86	19	M12	28	7	0.6
4	$\frac{1}{19.254}$	1°29'15"	31.267	6.5	31.605	25.943	102.5	109	25	M16	32	9	1
5	$\frac{1}{19.002}$	1°30'26"	44.399	6.5	4.741	37.584	129.5	136	35.7	M20	40	9	2.5
6	$\frac{1}{19.180}$	1°29'36"	63.348	8	63.765	53.859	182	190	51	M24	50	12	4
7	$\frac{1}{19.231}$	1°29'22"	83.058	10	83.578	70.058	250	260	65	M33	80	18.5	5

(mm)

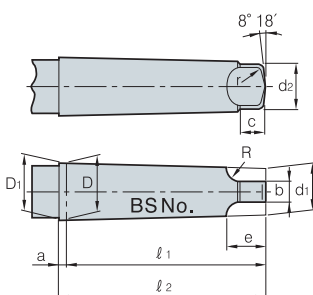
## Brown sharp taper (Screw type)



B&S No.	D	a	D <sub>1</sub>	d	d <sub>1</sub>	ℓ <sub>1</sub>	ℓ <sub>2</sub>	t	r	d <sub>2</sub>	K
4	10.221	2.4	10.321	8.890	8.0	31.0	34.2	2	0.2	-	-
5	13.286	2.4	13.386	11.430	10.0	44.4	46.8	3	0.2	-	-
6	15.229	2.4	15.330	12.700	11.0	60.0	62.7	3	0.2	M 8(1/4)	20
7	18.424	2.4	18.524	15.240	14.0	76.2	78.6	4	0.2	M10(3/8)	24
8	22.828	3.2	22.962	19.090	17.0	90.5	93.7	4	0.6	M12(1/2)	28
9	27.104	3.2	27.238	22.863	21.0	101.6	104.8	4	0.6	M12(1/2)	28
10	32.749	3.2	32.887	26.534	24.0	144.5	147.7	5	1.0	M16(5/8)	32
11	38.905	3.2	39.039	31.749	29.0	171.4	174.6	5	1.0	M16(5/8)	32
12	45.641	3.2	45.774	38.103	35.0	181.0	184.2	6	2.5	M20(3/4)	40
13	52.654	3.2	52.787	44.451	41.0	196.8	200.0	6	3.0	M20(3/4)	40
14	59.533	3.2	59.666	50.800	47.0	209.6	212.8	7	4.0	M24(1)	40
15	66.408	3.2	66.541	57.150	53.0	222.2	225.4	7	4.0	M24(1)	50
16	73.292	3.2	73.425	63.500	59.0	35.0	238.2	8	5.0	M30(1 1/8)	60

(mm)

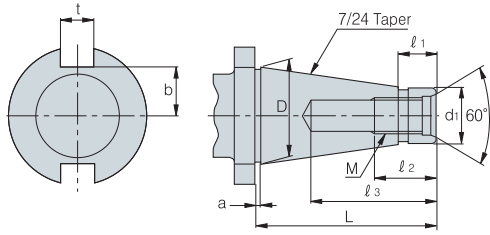
## Brown sharp taper (Tang type)



B&S No.	D	a	D <sub>1</sub>	d <sub>1</sub>	d <sub>2</sub>	ℓ <sub>1</sub>	ℓ <sub>2</sub>	b	c	e	R	r
4	10.221	2.4	10.321	8.458	8.1	42.1	44.5	5.5	8.7	14.4	7.9	1.3
5	13.286	2.4	13.386	10.962	10.7	55.6	58.0	6.3	9.5	16.2	7.9	1.5
6	15.229	2.4	15.330	12.167	11.7	73.0	75.4	7.1	11.1	18.0	7.9	1.5
7	18.424	2.4	18.524	14.675	14.2	89.7	92.1	7.9	11.9	20.3	9.5	1.8
8	22.828	3.2	22.962	18.453	18.0	104.8	108.0	8.7	12.7	22.0	9.5	2.0
9	28.104	3.2	27.238	22.200	21.8	117.5	120.7	9.5	14.3	25.4	11.1	2.5
10	32.749	3.2	32.887	25.751	25.7	162.7	165.9	11.1	16.7	28.1	11.1	2.8
11	38.905	3.2	39.039	30.985	30.7	189.7	192.9	11.1	16.7	30.0	12.7	3.3
12	45.641	3.2	45.774	37.246	37.1	201.6	204.8	12.7	19.0	32.5	12.7	3.8
13	52.654	3.2	52.787	43.589	43.4	217.5	220.7	12.7	19.0	35.7	15.9	4.3
14	59.533	3.2	59.666	49.841	49.8	232.6	235.8	14.2	21.4	41.2	19.0	4.8
15	66.408	3.2	66.541	56.186	56.1	245.3	248.5	14.2	21.4	44.4	22.2	5.3
16	73.292	3.2	73.425	62.441	62.2	260.4	263.6	15.8	23.8	50.0	25.4	5.8

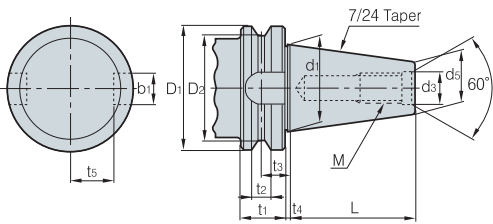


## Standard taper of american milling machine



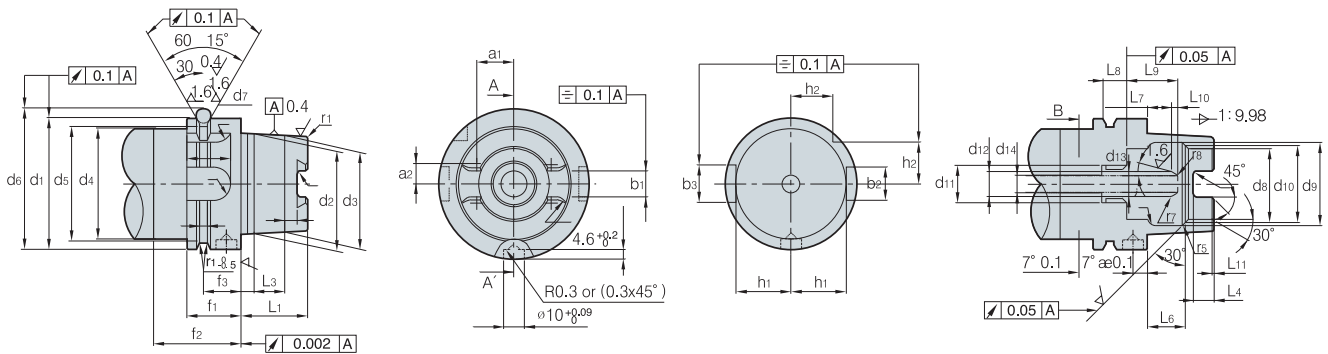
NT No.	Dimensions	D	D <sub>1</sub>	L	l <sub>1</sub>	M	l <sub>2</sub>	l <sub>3</sub>	a	t	b
30	1 <sup>1</sup> / <sub>4</sub>	31.750	17.40 <sup>-0.29</sup> <sub>-0.36</sub>	70	20	UNC 1/2"	24	50	1.6	15.9	6
40	1 <sup>3</sup> / <sub>4</sub>	44.450	25.32 <sup>-0.30</sup> <sub>-0.384</sub>	95	25	UNC 5/8"	30	60	1.6	15.9	22.5
50	2 <sup>3</sup> / <sub>4</sub>	69.850	39.60 <sup>-0.31</sup> <sub>-0.41</sub>	130	25	UNC 1"	45	90	3.2	25.4	35
60	4 <sup>1</sup> / <sub>4</sub>	107.950	60.20 <sup>-0.34</sup> <sub>-0.46</sub>	210	45	UNC 1 <sup>1</sup> / <sub>4</sub> "	56	110	3.2	25.4	60

## Bottle grip taper



BT No.	D <sub>1</sub>	D <sub>2</sub>	t <sub>1</sub>	t <sub>2</sub>	t <sub>3</sub>	t <sub>4</sub>	d <sub>1</sub>	d <sub>3</sub>	L	M	b <sub>1</sub>	t <sub>s</sub>	d <sub>s</sub>
35	53	43	22	10	14.6	2	38.1	13	56.5	M12×1.75	16.1	19.6	21.62
40	63	52	25	10	16.6	2	44.45	17	65.4	M16×2	16.1	22.6	25.3
45	85	73	30	12	21.2	3	57.15	21	82.8	M20×25	19.3	29.1	33.1
50	100	85	35	15	23.2	3	69.85	25	101.8	M24×3	25.7	35.4	40.1
60	155	135	45	20	28.2	3	107.95	31	161.8	M30×3.5	25.7	60.1	60.7

## HSK shank (DIN 69893)



HSK No.	b <sub>1</sub>	b <sub>2</sub>	b <sub>3</sub>	d <sub>1</sub>	d <sub>2</sub>	d <sub>3</sub>	d <sub>4</sub>	d <sub>5</sub>	d <sub>6</sub>	d <sub>7</sub>	d <sub>8</sub>	d <sub>9</sub>	d <sub>10</sub>	d <sub>11</sub>	d <sub>12</sub>	d <sub>13</sub>	d <sub>14</sub>	a <sub>1</sub>	a <sub>2</sub>
50	10.54	12	14	50	38	36.90	42	43	59.3	7	26	32	29	M16X1	10	6.8	6.8	13.997	7.648
63	12.5	16	14	63	48	46.53	53	55	72.3	7	34	40	37	M18X1	12	8	8.4	17.862	9.25
100	20	20	14	100	75	72.80	85	92	109.75	7	53	63	58	M24X1.5	16	12	12	27.329	15.00

HSK No.	f <sub>1</sub>	f <sub>2</sub>	f <sub>3</sub>	f <sub>4</sub>	b <sub>1</sub>	b <sub>2</sub>	L <sub>1</sub>	L <sub>2</sub>	L <sub>3</sub>	L <sub>4</sub>	L <sub>5</sub>	L <sub>6</sub>	L <sub>7</sub>	L <sub>8</sub>	L <sub>9</sub>	L <sub>10</sub>	L <sub>11</sub>	L <sub>12</sub>	r <sub>1</sub>	r <sub>2</sub>	r <sub>3</sub>	r <sub>4</sub>	r <sub>5</sub>	r <sub>6</sub>	r <sub>7</sub>	r <sub>8</sub>
50	26	42	18	3.75	2	15.5	25	5	11	7.5	4.5	14.13	10	10	23	3	1	19	1	1.5	2.38	6	0.5	1	2	6
63	26	42	18	3.75	28.5	20	32	6.3	14.7	10	6	18.13	10	12	24.5	3	1	21	1.2	1.5	3	8	0.6	1.5	3	8
100	29	45	20	3.75	44	31.5	50	10	24	15	10	28.56	12.5	16	28	3	1.5	24	2	2	3	12	1	1.5	3	10

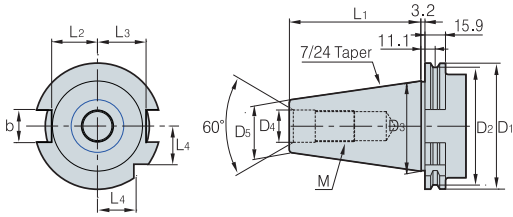




# Technical Information for Tapers

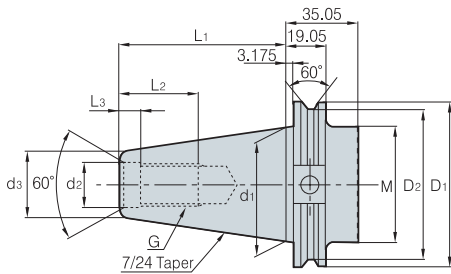
(mm)

## DIN 69871



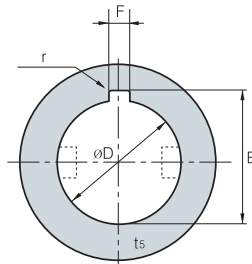
Shank No	D <sub>1</sub>	D <sub>2</sub>	D <sub>3</sub>	D <sub>4</sub>	D <sub>5</sub>	L <sub>1</sub>	L <sub>2</sub>	L <sub>3</sub>	L	b	M
30	50.0	44.3	31.75	13	17.8	47.8	16.4	19.0	33.5	16.0	M12x1.75
40	63.5	56.2	44.45	17	24.5	68.4	22.8	25.0	42.5	16.1	M16x2
45	82.5	57.2	57.15	21	33.0	82.7	29.1	31.3	52.5	19.3	M20x2.5
50	97.5	91.2	68.85	25	40.1	101.7	35.5	37.7	61.5	25.7	M24x3

## CAT shank



Shank No	D <sub>1</sub>	D <sub>2</sub>	M	d <sub>1</sub>	d <sub>2</sub>	d <sub>3</sub>	L <sub>1</sub>	L <sub>2</sub>	L <sub>3</sub>	G
CAT40	63.5	56.36	M16x2	44.45	16.28	21.84	68.25	28.45	4.78	5/8-11
CAT45	82.55	75.41	M20x2.5	57.15	19.46	27.69	82.55	38.1	4.78	3/4-10
CAT50	98.43	91.29	M24x3	69.85	26.19	35.05	101.6	44.45	6.35	1-8

## Standard of milling cutter hole (KSB3203)



### ● Type A

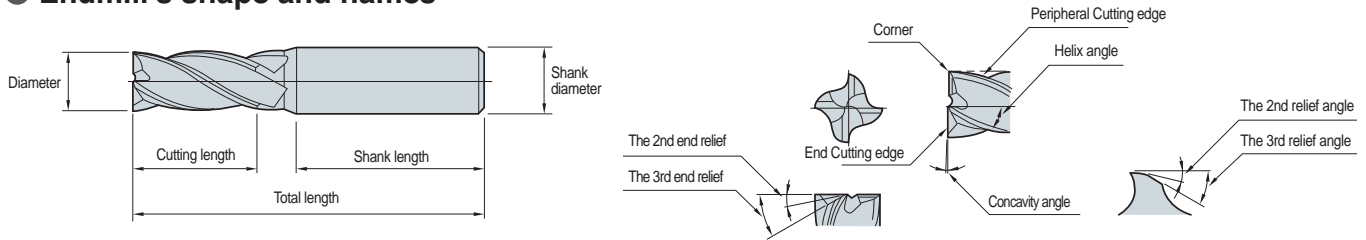
Diameter	øDH <sub>7</sub>	E	F	r
8	8 <sup>+0.015</sup> <sub>0</sub>	8.9 <sup>+0.25</sup> <sub>0</sub>	2 <sup>+0.16</sup> <sub>+0.06</sub>	0.4
10	10 <sup>+0.015</sup> <sub>0</sub>	11.5 <sup>+0.25</sup> <sub>0</sub>	3 <sup>+0.16</sup> <sub>+0.06</sub>	0.4
13	13 <sup>+0.018</sup> <sub>0</sub>	14.6 <sup>+0.25</sup> <sub>0</sub>	3 <sup>+0.16</sup> <sub>+0.06</sub>	0.6
16	16 <sup>+0.018</sup> <sub>0</sub>	17.7 <sup>+0.25</sup> <sub>0</sub>	4 <sup>+0.19</sup> <sub>+0.07</sub>	0.6
19	19 <sup>+0.021</sup> <sub>0</sub>	21.1 <sup>+0.25</sup> <sub>0</sub>	5 <sup>+0.19</sup> <sub>+0.07</sub>	1
22	22 <sup>+0.021</sup> <sub>0</sub>	24.1 <sup>+0.25</sup> <sub>0</sub>	6 <sup>+0.19</sup> <sub>+0.07</sub>	1
27	27 <sup>+0.021</sup> <sub>0</sub>	29.8 <sup>+0.25</sup> <sub>0</sub>	7 <sup>+0.23</sup> <sub>+0.08</sub>	1.2
32	32 <sup>+0.025</sup> <sub>0</sub>	34.8 <sup>+0.25</sup> <sub>0</sub>	8 <sup>+0.23</sup> <sub>+0.08</sub>	1.2
40	40 <sup>+0.025</sup> <sub>0</sub>	43.5 <sup>+0.3</sup> <sub>0</sub>	10 <sup>+0.23</sup> <sub>+0.08</sub>	1.2
50	50 <sup>+0.025</sup> <sub>0</sub>	53.5 <sup>+0.3</sup> <sub>0</sub>	12 <sup>+0.23</sup> <sub>+0.095</sub>	1.6
60	60 <sup>+0.030</sup> <sub>0</sub>	64.2 <sup>+0.3</sup> <sub>0</sub>	14 <sup>+0.275</sup> <sub>+0.095</sub>	1.6
70	70 <sup>+0.030</sup> <sub>0</sub>	75.0 <sup>+0.3</sup> <sub>0</sub>	16 <sup>+0.275</sup> <sub>+0.095</sub>	2
80	80 <sup>+0.030</sup> <sub>0</sub>	85.5 <sup>+0.3</sup> <sub>0</sub>	18 <sup>+0.275</sup> <sub>+0.095</sub>	2
100	100 <sup>+0.035</sup> <sub>0</sub>	107.0 <sup>+0.3</sup> <sub>0</sub>	24 <sup>+0.32</sup> <sub>+0.11</sub>	2.5

### ● Type B

Diameter	øDH <sub>7</sub>	E	F	r
1/2	12.70 <sup>+0.018</sup> <sub>0</sub>	14.17 <sup>+0.25</sup> <sub>0</sub>	2.38 <sup>+0.31</sup> <sub>+0.13</sub>	0.5
5/8	15.875 <sup>+0.018</sup> <sub>0</sub>	17.74 <sup>+0.25</sup> <sub>0</sub>	3.18 <sup>+0.31</sup> <sub>+0.13</sub>	0.8
3/4	19.050 <sup>+0.021</sup> <sub>0</sub>	20.89 <sup>+0.25</sup> <sub>0</sub>	3.18 <sup>+0.31</sup> <sub>+0.13</sub>	0.8
7/8	22.225 <sup>+0.021</sup> <sub>0</sub>	24.07 <sup>+0.25</sup> <sub>0</sub>	3.18 <sup>+0.31</sup> <sub>+0.13</sub>	0.8
1	25.40 <sup>+0.021</sup> <sub>0</sub>	28.04 <sup>+0.25</sup> <sub>0</sub>	6.35 <sup>+0.31</sup> <sub>+0.13</sub>	1.2
1 1/4	31.750 <sup>+0.025</sup> <sub>0</sub>	35.18 <sup>+0.25</sup> <sub>0</sub>	7.94 <sup>+0.32</sup> <sub>+0.14</sub>	1.6
1 1/2	38.10 <sup>+0.025</sup> <sub>0</sub>	42.32 <sup>+0.25</sup> <sub>0</sub>	9.53 <sup>+0.89</sup> <sub>+0.25</sub>	1.6
1 3/4	44.450 <sup>+0.025</sup> <sub>0</sub>	49.48 <sup>+0.25</sup> <sub>0</sub>	11.11 <sup>+0.89</sup> <sub>+0.25</sub>	1.6
2	50.80 <sup>+0.03</sup> <sub>0</sub>	55.83 <sup>+0.25</sup> <sub>0</sub>	12.7 <sup>+0.89</sup> <sub>+0.25</sub>	1.6
2 1/2	63.50 <sup>+0.03</sup> <sub>0</sub>	69.42 <sup>+0.25</sup> <sub>0</sub>	15.81 <sup>+0.89</sup> <sub>+0.25</sub>	1.6
3	76.20 <sup>+0.03</sup> <sub>0</sub>	82.93 <sup>+0.25</sup> <sub>0</sub>	19.05 <sup>+0.89</sup> <sub>+0.25</sub>	2.4
3 1/2	88.90 <sup>+0.035</sup> <sub>0</sub>	98.81 <sup>+0.25</sup> <sub>0</sub>	22.23 <sup>+0.89</sup> <sub>+0.25</sub>	2.4
4	101.60 <sup>+0.035</sup> <sub>0</sub>	111.51 <sup>+0.25</sup> <sub>0</sub>	25.4 <sup>+0.89</sup> <sub>+0.25</sub>	2.4
4 1/2	114.30 <sup>+0.035</sup> <sub>0</sub>	125.81 <sup>+0.25</sup> <sub>0</sub>	25.58 <sup>+0.89</sup> <sub>+0.25</sub>	3.2
5	127.0 <sup>+0.04</sup> <sub>0</sub>	140.08 <sup>+0.25</sup> <sub>0</sub>	31.75 <sup>+0.89</sup> <sub>+0.25</sub>	3.2



## Endmill's shape and names



## The comparison according to number of flute

### Features of number of flute

Ø10 mm	2 flutes	3 flutes	4 flutes
Shape			
Cross section	44 mm <sup>2</sup>	46 mm <sup>2</sup>	48 mm <sup>2</sup>
Ratio	56%	58%	61%
Advantages	Good chip flow	Good chip flow	High rigidity
Disadvantages	Weak rigidity	Difficult to measure external diameter	Bad chip flow
Usages	Side facing, Grooving	Side facing, Grooving	Side cutting
	Multi-functional	Medium, finishing	Finishing

### Affection of number of flute

Specification	Major features	2 flutes	4 flutes
Tool rigidity	Torsional rigidity	○	◎
	Bending rigidity	○	◎
Surface finish	Surface roughness	○	◎
	Machining precision	○	◎
Chip control	Chip clogging	◎	○
	Chip evacuation	◎	○
Grooving	Chip evacuation	◎	○
	Grooving	◎	○
Side facing	Surface finish	○	◎
	Vibration	◎	○

◎: Excellent ○: Good

## The differences between general endmills and high speed endmills

General endmills		High speed endmills	
Cross section shape	Features	Cross section shape	Features
	- Applied for Low speed, High depth of cut, Low feed - Low hardness workpiece (general steel, cast iron)		- Applied for high speed, low depth of cut, high feed - Useful for hardened workpiece such as die steel

## Calculations of cutting condition

### Calculations of Cutting speed

$$vc = \frac{\pi \times D \times n}{1000} \quad n = \frac{1000 \times vc}{\pi \times D}$$

### Calculations of feed speed

$$vf = n \times fn \quad \text{or} \quad n \times fz \times z$$

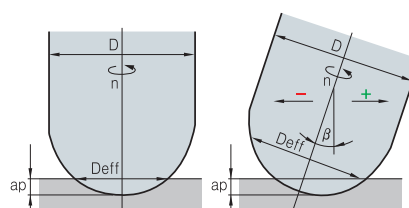
$$fn = \frac{vf}{n} \quad fz = \frac{fn}{z} \quad \text{or} \quad \frac{vf}{n \times z}$$

vc: Cutting speed (m/min)      vf: Feed speed (m/min)  
 π: Circular constant (3.141592)      fn: Feed per revolution (mm/rev)  
 D: Endmill diameter (mm)      fz: Feed per flute (mm/t)  
 n: Revolution per minute (min<sup>-1</sup>)      z: Number of flute

## Ball endmills cutting speed calculation formulas

Revolution per minute	$n = \frac{vc \times 1000}{D \times \pi}$
Cutting speed	$vc = \frac{D \times \pi \times n}{1000}$
Feed per tooth	$fz = \frac{vf}{z \times n}$
Feed per revolution	$fn = fz \times z$
Feed speed	$vf = fz \times z \times n$
Chip removal rate	$Q = ae \times ap \times vf$

### Effective diameter of Ball Endmill



$$D_{\text{eff}} = 2 \times \sqrt{D \times ap - ap^2} \quad \text{Calculation Table}$$

$$D_{\text{eff}} = D \times \sin \left[ \beta \pm \arccos \left( \frac{D - 2ap}{D} \right) \right]$$

# Technical Information for Endmills

## The affection of flute length

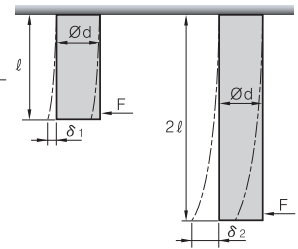
### ● Expression of aspect ratio

- Aspect ratio
- $l/d$
- Ex) 3D, 15D, 22D

### ● Deformation rate according to length

- Deformation rate is reaction force against external force
- Proportional to the cube of length
- Set flute length and overall length as short as possible
- The more flute the better rigidity
- When flute width rate is narrower drill's rigidity is higher

$$\delta = \frac{P\ell^3}{3EI}$$



$\delta$  = Deformation volume  $l$  = Length of cut

$P$  = Cutting force  $E$  = Elasticity coefficient

$$I = \text{Inertia moment} \left( I = \frac{\pi d^4}{64} \right)$$

•  $l: 2l$

•  $\delta_1: \delta_2 = 8\delta_1 = \delta_2$

## Spindle revolution conversion table (RPM) - external diameter

vc External	Cutting speed (vc, m/min)															
	20	30	40	50	60	70	80	90	100	120	140	150	180	200	250	300
0.2	31,831	47,746	63,662	79,577	95,493	111,408	127,324	143,239	159,155	190,986	222,817	238,720	286,479	318,310	397,887	477,465
0.3	21,221	31,831	42,441	53,052	63,662	74,272	84,883	95,493	106,103	127,324	148,545	159,155	190,986	212,207	265,258	318,310
0.4	15,915	23,873	31,831	39,789	47,746	55,704	63,662	71,620	79,577	95,493	111,408	119,366	143,239	159,155	198,944	238,732
0.5	12,732	19,099	25,465	31,831	38,197	44,563	50,930	57,296	63,662	76,394	89,127	95,493	114,592	127,324	159,155	190,986
0.6	10,610	15,915	21,221	26,526	31,831	37,136	42,441	47,746	53,052	63,662	74,272	79,577	95,493	106,103	132,629	159,155
0.7	9,095	13,642	18,189	22,736	27,284	31,831	36,378	40,926	45,473	54,567	63,662	68,209	81,851	90,946	113,682	136,419
0.8	7,958	11,937	15,915	19,894	23,873	27,852	31,831	35,810	39,789	47,746	55,704	59,683	71,620	79,577	99,472	119,366
0.9	7,074	10,610	14,147	17,684	21,221	24,757	28,294	31,831	35,368	42,441	49,515	53,052	63,662	70,736	88,419	106,103
1	6,366	9,549	12,732	15,915	19,099	22,282	25,465	28,648	31,831	38,197	44,563	47,746	57,296	63,662	79,577	95,793
1.5	4,244	6,366	8,488	10,610	12,732	14,854	16,977	19,099	21,221	25,465	29,709	31,831	38,197	42,441	53,052	63,662
2	3,183	4,775	6,366	7,958	9,549	11,141	12,732	14,324	15,915	19,099	22,282	23,873	28,648	31,831	39,789	47,746
2.5	2,546	3,820	5,093	6,366	7,639	8,913	10,186	11,459	12,732	15,279	17,825	19,099	22,918	25,465	31,831	38,197
3	2,122	3,183	4,244	5,305	6,366	7,427	8,488	9,549	10,610	12,732	14,854	15,915	19,099	21,221	26,526	31,831
3.5	1,819	2,728	3,638	4,547	5,457	6,366	7,276	8,185	9,095	10,913	12,732	13,642	16,370	18,189	22,736	27,284
4	1,592	2,387	3,183	3,979	4,775	5,570	6,366	7,162	7,958	9,549	11,141	11,937	14,324	15,915	19,894	23,873
4.5	1,415	2,122	2,829	3,537	4,244	4,951	5,659	6,366	7,074	8,488	9,903	10,610	12,732	14,147	17,684	21,221
5	1,273	1,910	2,546	3,183	3,820	4,456	5,093	5,730	6,366	7,639	8,913	9,549	11,459	12,732	15,915	19,099
5.5	1,157	1,736	2,315	2,894	3,472	4,051	4,630	5,209	5,787	6,945	8,102	8,681	10,417	11,575	14,469	17,362
6	1,061	1,592	2,122	2,653	3,183	3,714	4,244	4,775	5,305	6,366	7,427	7,958	9,549	10,610	13,263	15,915
6.5	979	1,469	1,959	2,449	2,938	3,428	3,918	4,407	4,897	5,876	6,856	7,346	8,815	9,794	12,243	14,691
7	909	1,364	1,819	2,274	2,728	3,183	3,638	4,093	4,547	5,457	6,366	6,821	8,185	9,095	11,368	13,642
7.5	849	1,273	1,698	2,122	2,546	2,971	3,395	3,820	4,244	5,093	5,942	6,366	7,639	8,488	10,610	12,732
8	796	1,194	1,592	1,989	2,387	2,785	3,183	3,581	3,979	4,775	5,570	5,968	7,162	7,958	9,947	11,937
8.5	749	1,123	1,498	1,872	2,247	2,621	2,996	3,370	3,745	4,494	5,243	5,617	6,741	7,490	9,362	11,234
9	707	1,061	1,415	1,768	2,122	2,476	2,829	3,183	3,537	4,244	4,951	5,305	6,366	7,074	8,842	10,610
9.5	670	1,005	1,340	1,675	2,010	2,345	2,681	3,016	3,351	4,021	4,691	5,026	6,031	6,701	9,377	10,052
10	637	955	1,273	1,592	1,910	2,228	2,546	2,865	3,183	3,820	4,456	4,775	5,730	6,366	7,958	9,549
11	579	868	1,157	1,447	1,736	2,026	2,315	2,604	2,894	3,472	4,051	4,341	5,209	5,787	7,234	8,681
12	531	796	1,061	1,326	1,592	1,857	2,122	2,387	2,653	3,183	3,714	3,979	4,775	5,305	6,631	7,958
13	490	735	979	1,224	1,469	1,714	1,959	2,204	2,449	2,938	3,428	3,673	4,407	4,897	6,121	7,346
14	455	682	909	1,137	1,364	1,592	1,819	2,046	2,274	2,728	3,183	3,410	4,093	4,547	5,684	6,821
15	424	637	849	1,061	1,273	1,485	1,698	1,910	2,122	2,546	2,971	3,183	3,820	4,244	5,305	6,366
16	398	597	796	995	1,194	1,393	1,592	1,790	1,989	2,387	2,785	2,984	3,581	3,979	4,974	5,968
17	374	562	749	969	1,123	1,311	1,498	1,685	1,872	2,247	2,621	2,809	3,370	3,745	4,681	5,617
18	354	531	707	884	1,061	1,238	1,415	1,592	1,768	2,122	2,476	2,653	3,183	3,537	4,421	5,305
19	335	503	670	838	1,005	1,173	1,340	1,508	1,675	2,010	2,345	2,513	3,016	3,351	4,188	5,026
20	318	477	637	796	955	1,114	1,273	1,432	1,592	1,910	2,228	2,387	2,865	3,183	3,979	4,775
21	303	455	606	758	909	1,061	1,213	1,364	1,516	1,819	2,122	2,274	2,728	3,032	3,789	4,547
22	289	434	579	723	868	1,013	1,157	1,302	1,447	1,736	2,026	2,170	2,604	2,894	3,617	4,341
23	277	415	554	692	830	969	1,107	1,246	1,384	1,661	1,938	2,076	2,491	2,768	3,460	4,152
24	265	398	531	663	796	928	1,061	1,194	1,326	1,592	1,857	1,989	2,387	2,653	3,316	3,979
25	255	382	509	637	764	891	1,019	1,146	1,273	1,528	1,783	1,910	2,292	2,546	3,183	3,820



## 🔍 Tool failure and trouble shooting

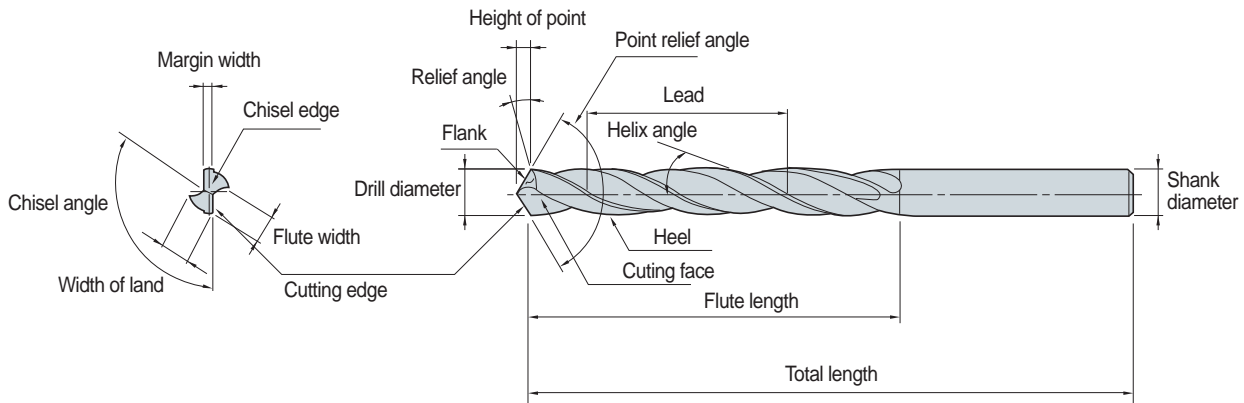
Trouble	Causes	Solutions																
		Cutting condition					Tool shape					Grade		etc				
		Cutting speed	Feed	Depth of cut	Coolant	Up cut-down cut	Relief angle	Lead angle	Length of flute	Number of flute	Honing	Chip pocket	Toughness	Hardness	Machine rigidity	Machine vibration	Workpiece fixing	Overhang
Damage at cutting edge	Excessive periphery cutting edge	↓	↑		●												↑	
	Chipping		↓			↓	↓			●		↑				↓	↑	↓
	Fracture during operation		↓	↓				↓			↑			↑		↑		↓
Poor surface finish	Generating built-up edge	↑	↑		●		↑			●								
	Chattering	↓				↓		↓						↑	↓	↑	↓	
	Poor straightness		↓	↓		↑	↑	↓										↓
Poor machining precision (Machined size, perpendicularity)	Improper cutting conditions Improper tool shape	↑	↓			↓		↓	↑					↑	↓		↓	
Bad chip evacuation	Excessive cutting volume Improper chip pocket Improper cutting conditions		↓	↓					↓		↑							

↑ : Increase   ↓ : Decrease   ● : use   ○ : Correct use



# Technical Information for Drills

## The shape of drills and the names



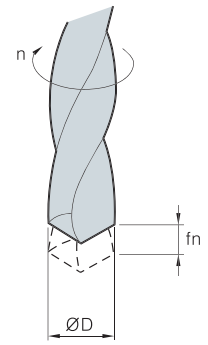
## Shape and the feature of cutting

<b>Helix angle</b>	<p>Plays rake angle of cutting edge's role. If helix angle increases Cutting force decreases. On the other hand If helix angle is too big Drill rigidity decreases</p> <p>Poor machinability      ◀ low - Helix angle - high ▶                  Hard workpiece (hardened steel)      ▶ low - Helix angle - high ▶      Smooth chip evacuation                  Soft material (aluminum etc)</p>												
<b>Length of flute</b>	<p>The path of both chip evacuation and cooling lubricant                  Too big length of flute weakens drill rigidity and too small length of flute worsens chip evacuation to breakage</p>												
<b>Point angle</b>	<p>Point angle has big influence on cutting performance. It mainly depends on workpiece. In case of standard drills Point angle is generally 118</p> <p>thrust resistance decrease      ◀ low - Point angle - high ▶      thrust resistance increase                  Torque increase, Burr on exit increase      ▶ low - Point angle - high ▶      Torque decrease, Burr on exit decrease                  Soft material (aluminum etc)      ▶ low - Point angle - high ▶      Hard workpiece (hardened steel)</p>												
<b>Margin</b>	<p>While machining Margin is the part of contact between workpiece and drill's external. It prevents bending and plays guide's role                  It depends on drill size</p> <p>Cutting force decrease      ◀ small - Margin - big ▶      Cutting force increase                  Poor guide      ▶ small - Margin - big ▶      Good guide</p>												
<b>Web thickness</b>	<p>Web is the part of center of drill and drill's rigidity depends on the web. Drill needs cutting edge, chisel edge, at the tip of drill because drill makes a hole at the beginning of drilling . When web thickness is big Thinning is needed to reduce cutting force</p> <p>Cutting force decrease      ◀ small - Web thickness - big ▶      Cutting force increase                  Rigidity decrease      ▶ small - Web thickness - big ▶      Rigidity increase                  Good chip evacuation      ▶ small - Web thickness - big ▶      Bad chip evacuation                  Soft material (aluminum etc)      ▶ small - Web thickness - big ▶      Hard workpiece (hardened steel)</p>												
<b>Back taper</b>	<p>Drill diameter size is getting smaller from point to shank in order to avoid the friction between drill periphery and workpiece.                  The decrease of diameter divided by flute length 100mm generally becomes 0.04~0.1mm. As for high performance drills and drills for hole shrinkage workpiece during operation have big back taper</p>												
<b>Thinning</b>	<p>In general drills Thrust effects on chisel over 50%. Chisel edge length depends on web thickness and chisel angle. But if web is thin Drill rigidity weaken. Therefore without web thickness change Thinning makes chisel edge short or gives rake angle. In other words, Thinning makes rake angle at chisel and improves chip evacuation and decrease thrust</p> <table border="1" style="width: 100%; border-collapse: collapse;"> <thead> <tr> <th style="width: 20%;">Types of</th> <th style="width: 20%;">Edge shape</th> <th style="width: 30%;">Feature</th> <th style="width: 30%;">Korloy's drills</th> </tr> </thead> <tbody> <tr> <td style="text-align: center;"><b>X type</b></td> <td style="text-align: center;"></td> <td>Good centering High central thickness Crank shaft</td> <td>Mach solid drill (MSD) Vulcan drill (VZD)</td> </tr> <tr> <td style="text-align: center;"><b>S type</b></td> <td style="text-align: center;"></td> <td>For wide use For general Easy regrinding</td> <td>Solid drill (SSD)</td> </tr> </tbody> </table>	Types of	Edge shape	Feature	Korloy's drills	<b>X type</b>		Good centering High central thickness Crank shaft	Mach solid drill (MSD) Vulcan drill (VZD)	<b>S type</b>		For wide use For general Easy regrinding	Solid drill (SSD)
Types of	Edge shape	Feature	Korloy's drills										
<b>X type</b>		Good centering High central thickness Crank shaft	Mach solid drill (MSD) Vulcan drill (VZD)										
<b>S type</b>		For wide use For general Easy regrinding	Solid drill (SSD)										



## Major cutting formulas

Cutting speed	Feed	Helix angle	Machining time
$vc = \frac{\pi \cdot D \cdot n}{1000} \text{ (m/min)}$ <ul style="list-style-type: none"> <li>vc: Cutting speed (m/min)</li> <li>D: Drill diameter (mm)</li> <li>n: Revolution per minute (min<sup>-1</sup>)</li> <li>π: Circular constant (3.14)</li> </ul>	$fn = \frac{vf}{n} \text{ (mm/rev)}$ <ul style="list-style-type: none"> <li>fn: Feed per revolution (mm/rev)</li> <li>vf: Feed per minute (mm/min)</li> <li>n: Revolution per minute (min<sup>-1</sup>)</li> </ul>	$\delta = \tan^{-1} \left( \frac{\pi D}{L} \right)$ <ul style="list-style-type: none"> <li>δ: Helix angle</li> <li>D: Drill diameter (mm)</li> <li>L: Lead (mm)</li> <li>π: Circular constant (3.14)</li> </ul>	$tc = \frac{ld}{n \cdot fn} \text{ (min)}$ <ul style="list-style-type: none"> <li>tc: Machining time (min)</li> <li>n: Revolution per minute (min<sup>-1</sup>)</li> <li>ld: Drilling time (mm)</li> <li>fn: Feed (mm/rev)</li> </ul>



### Cutting torque and thrust (calculation formulas)

$Md = KD^2 \times (0.0631 + 1.686 \times fn) \text{ (kg·cm)}$	<ul style="list-style-type: none"> <li>Md: Cutting torque (kg·cm)</li> <li>T: Cutting thrust (kg)</li> <li>D: Drill diameter (mm)</li> </ul>	<ul style="list-style-type: none"> <li>fn: Feed per revolution (mm/rev)</li> <li>K: Material coefficient</li> </ul>
$T = 57.95KDfn^{0.85} \text{ (kg)}$		

Workpiece material (SAE/AISI)	Tensile strength (kgf)	Hardness (HB)	Material coefficient K	
Cast iron	Cast iron (Gray)	21	177	1.00
	Cast iron	28	198	1.39
	Cast iron (Ductile)	35	224	1.88
General steel	1020(carbon steel C 0.2%)	55	160	2.22
	1112(C 0.12, S 0.2%)	62	183	1.42
	1335(Mn 1.75%)	63	197	1.45
Nickel Chrome steel	3115 (Ni 1.25, Cr 0.6, Mn 0.5)	53	163	1.56
	3120 (Ni 1.25, Cr 0.6, Mn 0.7)	69	174	2.02
	3140	88	241	2.32
Chrome molybdenum steel	4115 (Cr 0.5, Mo 0.11, Mn 0.8)	63	167	1.62
	4130 (Cr 0.95, Mo 0.2, Mn 0.5)	77	229	2.10
	4140 (Cr 0.95, Mo 0.2, Mn 0.85)	94	269	2.41
Nickel molybdenum steel	4615 (Ni 1.8, Mo 0.25, Mn 0.5)	75	212	2.12
	4820 (Ni 3.5, Mo 0.25, Mn 0.6)	140	390	3.44
Chrome steel	5150 (Cr 0.8, Mn 0.8)	95	277	2.46
Chrome vanadium steel	6115 (Cr 0.6, Mn 0.6, V 0.12)	58	174	2.08
	6120 (Cr 0.8, Mn 0.8, V 0.1)	80	255	2.22

### Cutting torque and thrust (empirical formula)

$Md = K_1 d^2 \cdot fn^m$	<ul style="list-style-type: none"> <li>Md: Cutting torque (kg·cm)</li> <li>T: Thrust (kg)</li> </ul>	<ul style="list-style-type: none"> <li>fn: Feed (mm/rev)</li> <li>d: Drill diameter (mm)</li> </ul>	<ul style="list-style-type: none"> <li>K1, K2, m, n: Experimental Data Characteristic value</li> </ul>
$T = K_2 d \cdot fn^n$			

Workpiece	K1	m	K2	n
Soft steel	5.9	1.00	125.0	0.88
Rolled steel	3.5	1.00	55.0	0.88
7-3 brass	2.5	0.94	44.4	0.87
Aluminum	1.5	0.90	33.3	0.78
Zinc	1.4	0.88	27.0	0.74
Gun metal	2.0	0.94	21.6	0.75
Galvanized iron	0.3	0.57	6.4	0.55



## Tool failures and solutions

Trouble	Causes	Solutions																
		Cutting condition					Tool shape					Grade		etc				
		Cutting speed	Feed	Step feed	Initial feed	Coolant	Relief angle	Point angle	Thinning angle	Honing	Flute width rate	Thinning	Toughness	Hardness	Machine rigidity	Machine vibration	Guide bush	Clamping workpiece
Chipping	• Too sharp cutting edge (too big relief angle) (thinning edge is too sharp)						↓		↓	↑			↑					
	• Excessive cutting speed	↓				●												
	• Built-up edge					●	↓		↓	↑			↑					
	• Vibration and chattering	↓												↑	↓		●	
Wear	• Excessive cutting speed (Abnormal wear at margin)	↓				●												
	• Insufficient cutting speed (Abnormal wear at center)	↑				●												
Chip	• Long chip	↑	↑			●				↓								
	• Over lap	↑	↑															
	• Chip burning	↑				●												
Hole precision burr, poor surface finish	• Tool clamping precision				↓			↓		↓				↑	↓		●	
	• Excessive feed, sharp point angle		↓					↑		↓								
	• Excessive cutting speed (Considered tool grade)	↑				●	↓	⊙					↑					
Fracture	Breakage on contact	• Poor surface finish			●	↓											●	
		• Insufficient machine rigidity													↑			●
		• Improper cutting condition	↑	↓														
	Breakage at hole bottom	• Crooked hole	↑						↑				●			↓	●	
		• Chip clogging		↓	●								↑					

↑: Increase ↓: Decrease ●: use ⊙: Correct use





## 🔗 Hole size for threading

### ● Metric coarse screw threads

Specification	Hole diameter
M1 X 0.25	0.75
M1.1 X 0.25	0.85
M1.2 X 0.25	0.95
M1.4 X 0.3	1.1
M1.6 X 0.35	1.25
M1.7 X 0.35	1.35
M1.8 X 0.35	1.45
M2 X 0.4	1.6
M2.2 X 0.45	1.75
M2.3 X 0.4	1.9
M2.5 X 0.45	2.1
M2.6 X 0.45	2.2
M3 X 0.6	2.4
M3 X 0.5	2.5
M3.5 X 0.6	2.9
M4 X 0.75	3.25
M4 X 0.7	3.3
M4.5 X 0.75	3.8
M5 X 0.9	4.1
M5 X 0.8	4.2
M5.5 X 0.9	4.6
M6 X 1	5
M7 X 1	6
M8 X 1.25	6.8
M9 X 1.25	7.8
M10 X 1.5	8.5
M11 X 1.5	9.5
M12 X 1.75	10.3
M14 X 2	12
M16 X 2	14
M18 X 2.5	15.5
M20 X 2.5	17.5
M22 X 2.5	19.5
M24 X 3	21
M27 X 3	24
M30 X 3.5	26.5
M33 X 3.5	29.5
M36 X 4	32
M39 X 4	35
M42 X 4.5	37.5
M45 X 4.5	40.5
M48 X 5	43

### ● Metric coarse screw threads

Specification	Hole diameter
M2.5 X 0.35	2.2
M3 X 0.35	2.7
M3.5 X 0.35	3.2
M4 X 0.5	3.5
M4.5 X 0.5	4
M5 X 0.5	4.5
M5.5 X 0.5	5
M6 X 0.75	5.3
M7 X 0.75	6.3
M8 X 1	7
M8 X 0.75	7.3
M9 X 1	8
M9 X 0.75	8.3
M10 X 1.25	8.8
M10 X 1	9
M10 X 0.75	9.3
M11 X 1	10
M11 X 0.75	10.3
M12 X 1.5	10.5
M12 X 1.25	10.8
M12 X 1	11
M14 X 1.5	12.5
M14 X 1	13
M15 X 1.5	13.5
M15 X 1	14
M16 X 1.5	14.5
M16 X 1	15
M17 X 1.5	15.5
M17 X 1	16
M18 X 2	16
M18 X 1.5	16.5
M18 X 1	17
M20 X 2	18
M20 X 1.5	18.5
M20 X 1	19
M22 X 2	20
M22 X 1.5	20.5
M22 X 1	21
M24 X 2	22
M24 X 1.5	22.5
M24 X 1	23
M25 X 2	23
M25 X 1.5	23.5
M25 X 1	24
M26 X 1.5	24.5
M27 X 2	25

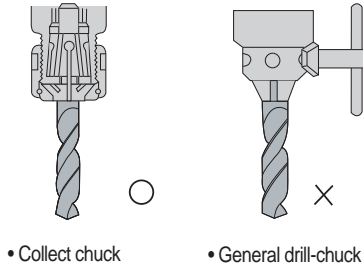


# Technical Information for Drills

## Cautions

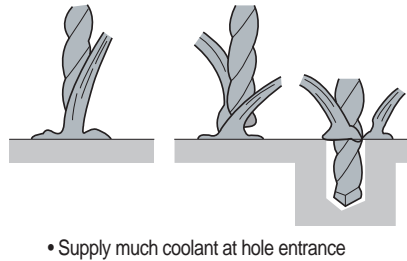
### ● Selection of drill chuck

- Collect chuck is favorable Because it has strong grip power (General drill-chuck and Keyless chuck don't have enough grip power.)



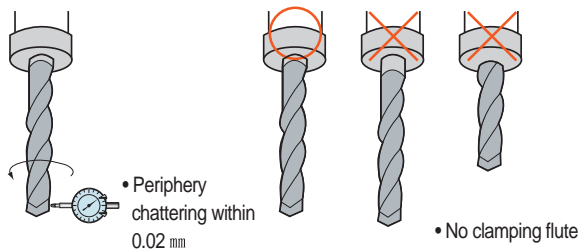
### ● Coolant supply

- Supply enough coolant around hole entrance
- Standard cutting oil pressure: 3~5 kg/cm<sup>2</sup>, Flux: 2~5 l/min



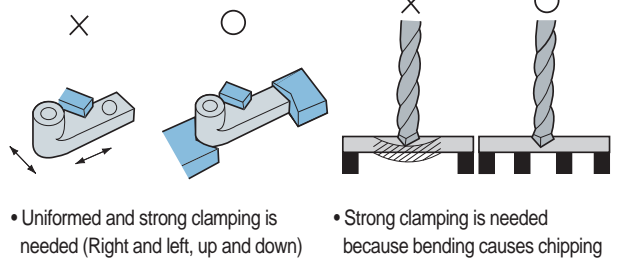
### ● Mounting drill

- When mounting drill Periphery chattering should be within 0.02 mm
- Flute should not be clamped



### ● How to clamp workpiece

- At high performance drilling High thrust, torque and horizontal cutting force work at the same time so that workpiece should be clamped strongly to prevent chattering

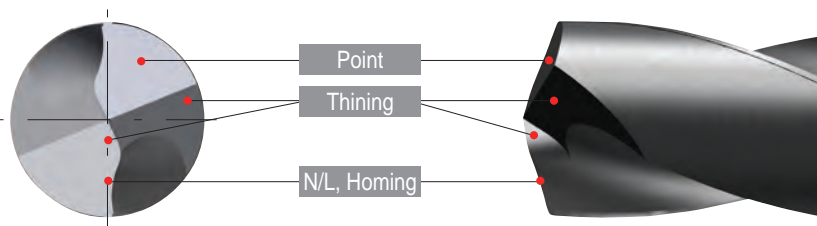


## Notice

- 1) For better drill's life, small damage and wear are favorable to be regrinding
- 2) Damage and wear size should be within 1.5 mm for regrinding
- 3) If drill has crack, regrinding is impossible
- 4) Ordering for regrinding is acceptable or purchase regrinding machine

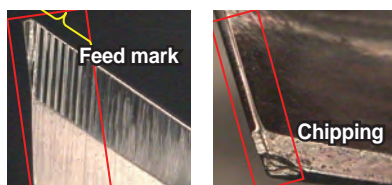
## Regrinding procedures

### ● Regrinding method (Mach Drill)



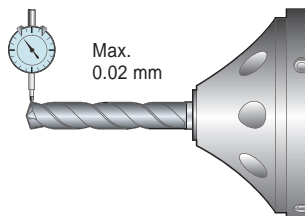
#### 1) Preparation Determination of regrinding areas

- Check the cutting edge for damage and wear If large fracture is found, remove it by rough grinding



#### 2) Grinding operation Drills setting

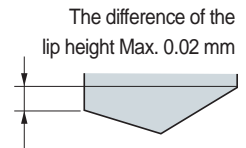
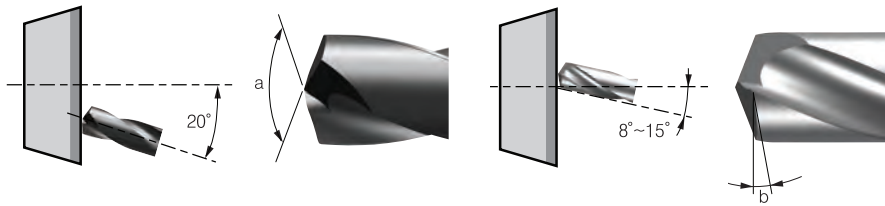
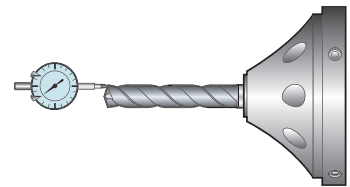
- Drill is clamped to collet chuck Chattering is kept within 0.02 mm



### 3) Grinding operation-Grinding point

- Check damage and wear at the point and remove it completely
- The difference of the lip height is kept within 0.02 mm

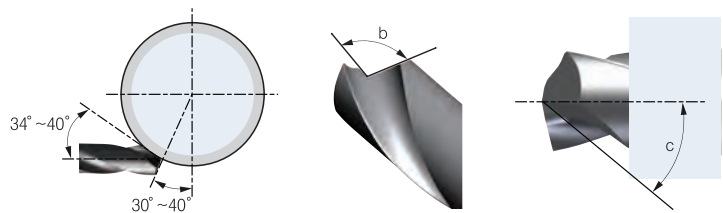
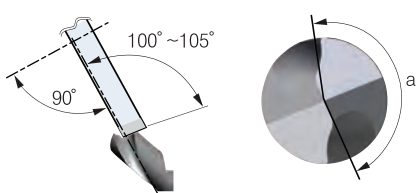
Point angle (a): 140°  
Point relief angle (b): 8°~15°



### 4) Grinding operation-Thinning grinding

- Considering N/L width Cutting edge length from the center of drill axis should be 0.03~0.08mm for balancing
- Set the wheel to tilt drill axis by 34°~40°.

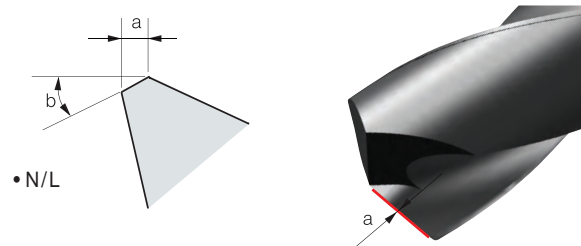
Thinning angle (a): 155°~160° Thinning open angle (b): 100°~105°  
Thinning relief angle (c): 34°~40°



### 5) Grinding-N/L grinding and honing

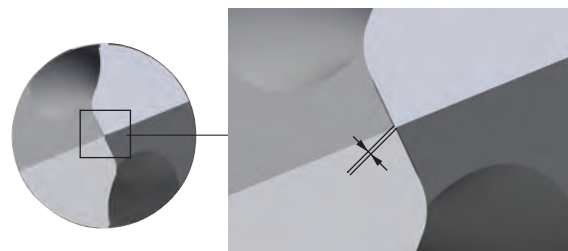
- Using diamond chisel Grinds the width flat along point cutting edge
- After negaland operation Finishes with brush or handstone

N/L width (a): 0.05mm~0.16mm/N/L angle (b): 24°~26°



### ● TIP

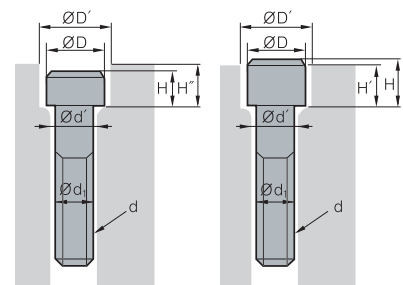
- Making point
  - Without center drill, the point width should be below 0.10 mm
- Recommended grinding condition
  - Diamond wheel: 240~400 mesh
  - Diamond chisel: 400~600 mesh
  - Diamond hand stone: 800~1500 mesh



### ➤ Hexagonal socket bolt (clamping screw) size

#### ● Counter boring and size of bolt hole for hexagonal socket bolt

ISO (d)	M3	M4	M5	M6	M8	M10	M12	M14	M16	M18	M20	M22	M24	M27	M30
Ød <sub>i</sub>	3	4	5	6	8	10	12	14	16	18	20	22	24	27	30
Ød'	3.4	4.5	5.5	6.5	8.5	11	14	16	18	20	22	24	26	30	33
ØD	5.5	7	8.5	10	13	16	18	21	24	27	30	33	36	40	45
ØD'	5	8	9.5	11	14	17.5	20	23	26	29	32	35	39	43	48
H	3	4	5	6	8	10	12	14	16	18	20	22	24	27	30
H'	2.7	3.6	4.6	5.5	7.4	9.2	11.0	12.8	14.5	16.5	18.5	20.5	22.5	25	28
H''	3.3	4.4	5.4	6.5	8.6	10.8	13.0	15.2	17.5	19.5	21.5	23.5	25.5	29	32



# General Information II

## The comparison of chip breakers

Application			KORLOY	KYOCERA	TAEGUTEC	SUMITOMO	SANDVIK	KENNAMETAL	ISCAR	WLATER	MITSUBISHI	SECO	TUNGALLOY		
Negative	P	Application	Ultra-Finishing	- VL	DP (G-class) GP	- FA	FA FL, FB	PMC QF	FF (G-class) UF	SF PF	- NF3	PK (G-class), FY FH, FS, SY	FF1 FF2	TF NS, ZF	
			Finishing	VF, VB -	PP -	FG SF	LU, FE SU	PF, XF 61	FN K	NF, SM F3P	NF4 FP5	FP LP, SH, SA		NM, NS, SS TS, TSF	
		Medium to finishing	VC LP, CP	HQ, CQ PQ, CJ	MC FC	SE SX	HM PMC	LF, CT -	TF -	NS6 MP3	C(Cermet) MV		AS MF5	AM ZM, AM	
			Medium machining	VM, HM MP	HK, GS, HS, PS PG	MP, MT PC	GU(UG) GE, UX	QM, SM PM, XM	MP, MN -	PP, TF M3P	NM4, NP5 MP5	MA, MH MP	M3, M5 -		TQ, TM DM, None C/B
		Roughing	B25 GR					-	RP, MR RN, None C/B	GN R3P	- RP5, NM9	GM, None C/B GH, RP	M5 MR5, MR6, MR7		TH THS
			Heavy duty machining	GH VH VT	PX - -	HB, RH, RX HZ, EH HT, HY, HD	HG, MP HP HU, HW, HF	PR, XMR QR HR	RH RM MM	NR, HT HR T3P	RP7, NR4, NRF NRR, NR8 -	HZ HX HV	R4, R5 R6, R7, R8, PR6 PR9, R56, R57, R68		CH THS, TRS 65, TUS
	Low carbon steel	Soft steel	VL	XF, XP, XP-T XQ, XS	SF -	FL -	LC -	- -	- -	- -	FY SY	- -	- -	- -	
			High feed	Wiper	VW LW -	WP, WF WQ, WE -	WS WT -	LUW, SEW GUW -	WF, WL WM, WMX WR	FW MW RW	WF WG -	NF NM -	SW MW -	FF2, MF2 MF5, M3 R4, R7	AFW, FW ASW, SW -
	Application	Shaft (long bar)	SH KNUX-	CJ, ST KNMX-	FS, VF, FX KNUX-	HM -	K KNUX-71	- -	- -	- -	- -	ES KNMX-19	UX -	P, S KNMX	
			M	Stainless steel	Finishing	VP2, MP	MQ, GU, SK	EA, SF	SU, EF	MF, XF	FP, FF	SF, VL, F3M	NF4, FM5	SH, LM	FF1, MF1
Medium cutting	MM	HU, TK, MS			MP, EM	EX, EG, GU	MM, XM, QM, MMC	MP, UP, MS	PP, TF, M3M	NM4, NR4	MS, GM, MM	MF3, MF4	SM		
Roughing	RM	MU			ET	MU, HM, EM	MR, XMR, MRR	RP, P	MR, R3M	RM5, NRS	MA, ES	MF5, M5	S, SH		
K	Cast iron	Finishing	MP	None C/B, C, KQ	MT	UZ	KF, PMC, XF	T-20, FN	TF	NM, MK5	LK, MA	M4	CF		
		Medium cutting	B25, MK	ZS, KG	RT, KT	UX, GZ	KM, XM	UN, RP	GN	NM5, RK5	MK, GK, None C/B	M5	CM, None C/B		
		Roughing	-MA, RK	-MA, GC, KH	-MA	-MA	KR, XMR, KRR	MR, S-20, -MA	-MA, NR	-MA, RK7	RK, -MA	MR7	CH		
S	HRSA	Ultra-finishing	VP1	MQ, SK	EA	EF	SF, SGF	FS (G-class) LF (G-class)	SF, PF	NF4	FJ(G-class)	M1	SF		
		Finishing	VP2	TK	ML	UP, EG	23.SR, XF, SMC	UP	PP	NFT	LS	MF1	HMM		
		Medium cutting	VP3	MS	EM	EX	SM, SMR, XM	MS, GP, P, UN	TF	NMS, NMT	MS	MF4, MR3	HRF		
		Roughing	VP4	MU	ET	MU	XMR	RP	MR	NRS, NRT	RS, GJ	MR4	HRM		
N	Aluminium alloy	HA	AH	ML	AX	23	GP, MS	NF, PP	FN2, PF2, MN2, PM2	MJ	MF1	P			
Positive	P M K	Application	Finishing	FP VL, VF	XP, PP GP	FA, FX -	FC FB, LU(FP, FK)	PF, XF UF	11 UF	PF F3P	FP4 FK6	SMG (G-class), FV SV, FP	FF1 F1	01 PSF, PF	
				Medium cutting	HMP MP	XQ HQ, GK	FG PC, FM	LB, NF SU, SC	PM, XM UM, PMC	LF, FP MP, T-20	14 SM	MP4, FM2, FM4, MK4 FP6, MM4, FM6, RK4	LP MV	MF2 F2, M3	PSS PS
			Roughing		C25	None C/B	MT	MU	PR, UR, XR	MF, GM, -C	19	RP4, RM4, RK6	None C/B, MP	M5	PM
				Wiper	- -	WP -	- WT	LUW SDW	WL, WF WM, WMX	FW MW	WF WG	PM -	SW MW	- -	- -
	M S	Stainless steel For HRSA	Finishing		FS, MS, VP1	CF, GF, GQ	FG	FC, FM	MF, MM, MMC	11, UF, LF	PF	FM4, NM4	FJ (G-class), FM, LM	F1, MF2	PSF, PSS
			Medium to finish cutting	FP, VL, LU	MQ	SA	LB, SI	MR, XR	MF	SM	RM4	MM	M3	PS	
			Medium cutting	MU	MF	-	-	SMC	-	M3M	-	None C/B	M5	CM	
	K	Cast iron	Medium cutting	MP	HQ	PC	MU	KF, KM	LF	17	FK6	MK	M3	CM	
			Roughing	C25	GK	MT	None C/B	KR	MF, UF	19	MK4, RK6	None C/B, -MW	M5	None C/B	
	N	Aluminium alloy	AK, AR	AH	FL	AW, AG, AY	AL	HP, LF	AS, AF	PM2	AZ, FS	AL	AL		
High precision bar turning (tolerance class G&E)			KF, KM	FSF, USF, J, A3	GF, FF, GW	FY, FX, FZ	K, F, UM	GH	LF, RF, XL	-	F, SR, SS, SM	UX	JS, J10, JRP, JPP		

KORLOY grades

Cat.	Grade	ISO						Turning	Multi functional tools	Threading	Milling	Endmill	Index drill	Solid drill	Brazen tools	Coating layer
		P	M	K	S	N	H									
CVD	NC3215	P10-P15						●								
CVD	NC3225	P20-P25						●	●							
CVD	NC3120	P20-P25						●	●							
CVD	NC3030	P25-P35						●	●							
PVD	PC3030T	P35-P45	M25-M35							●						
PVD	PC3035	P30-P40							●							
CVD	NC6310				K01-K10			●								
CVD	NC6315				K10-K20			●	●							
PVD	PC8105		M05-M15		S01-S10			●								
PVD	PC8110		M10-M20		S05-S15			●	●							
PVD	PC8115		M15-M25		S10-S20			●								
PVD	PC8120				S15-S25			●								
CVD	NC9115		M10-M20					●								
CVD	NC9125		M20-M30		S10-S20			●								
CVD	NC9135		M30-M40		S15-S25			●								
PVD	PC9030		M25-M35					●	●							
PVD	PC9070T		M25-M35							●						
PVD	PC2005						H01-H10				●					
PVD	PC2010						H05-H15				●					
PVD	PC2015						H10-H20				●					
PVD	PC2505						H01-H10				●					
PVD	PC2510						H05-H15				●	●				
PVD	PC210F						H10-H20				●					
CVD	NCM325	P30-P40									●	●				
CVD	NCM335	P35-P45									●					
PVD	PC3700	P25-P40									●	●				
CVD	NC5330	P30-P35	M25-M35	K15-K25				●	●		●	●				
CVD	NCM535	P30-P40			K20-K30				●			●				
CVD	NCM545	P40-P50			K30-K40					●						

Coating



# General Information II

## KORLOY grades

Cat.	Grade	ISO						Turning	Multi functional tools	Threading	Milling	Endmill	Index drill	Solid drill	Brazen tools	Coating layer
		P	M	K	S	N	H									
Coating	PVD PC5300	P30-P40	M20-M30	K20-K30	S15-S25			●	●	●	●	●			★ New TiAlN film (High hardness/Oxidation resistance)	
	PVD PC5335	P30-P40	M20-M30									●			★ TiAlCrN film (Lubricative)	
	PVD PC5400	P35-P45	M30-M40	K25-K35	S25-S35			●		●					★ TiAlCrN film (Lubricative)	
	PVD PC6510			K05-K15							●	●			TiN TiAlN	
	PVD PC9530		M25-M35								●				TiAlN	
	PVD PC9540		M35-M45		S30-S40						●				Al <sub>2</sub> O <sub>3</sub> TiAlN	
Cermet	PVD CC1500 <sup>new</sup>	P10-P20		K05-K15				●							★ New TiAlN film (High hardness/Oxidation resistance)	
	PVD CC2500 <sup>new</sup>	P20-P30		K10-K15				●							★ New TiAlN film (High hardness/Oxidation resistance)	
	CN1500	P10-P20		K10-K20				●								
	CN2500	P15-P30		K15-K25				●								
	CN30	P25-P35								●						
Uncoated	ST10	P10-P15								●				●		
	ST20	P15-P20							●					●		
	ST30A	P25-P35							●		●					
	U20		M25-M30											●		
	H01			K05-K10	S01-S10	N10-N20	H05-H10	●	●		●	●	●	●		
	H05			K10-K15	S05-S15	N15-N25		●			●					
	G10				K15-K20			●			●			●		
Coating	PVD PC203F						H05-H15					●			★ New TiAlN film (High hardness/Oxidation resistance)	
	PVD PC210C					N10-N20						●			CrN	
	PVD PC215F	P20-P35										●			★ New TiAlN film (High hardness/Oxidation resistance)	
	PVD PC215G	P15-P30		K15-K30								●			TiAlN	
	PVD PC221F	P35-P45		K35-K45							●				★ New TiAlN film (High hardness/Oxidation resistance)	
	PVD PC230F	P05-P15	M05-M15	K05-K15									●		★ New TiAlN film (High hardness/Oxidation resistance)	
	PVD PC303S	P05-P15		K05-K15			H05-H15					●			TiMeN TiAlN	
	PVD PC310U	P10-P20		K10-K20			H10-H20					●			TiMeN TiAlN	
	PVD PC315E	P20-P35		K20-K35								●			AlCrN	
	PVD PC315G	P15-P30		K15-K30									●		TiAlCrN	
	PVD PC320	P20-P35		K20-K35							●				TiAlN	



KORLOY grades

Cat.	Grade	ISO						Turning	Multi functional tools	Threading	Milling	Endmill	Index drill	Solid drill	Brazed tools	Coating layer
		P	M	K	S	N	H									
Coating	PVD PC320S		M20-M30		S20-S30						●					
	PVD PC320U	P01-P10		K05-K10							●					
	PVD SL				S25-S35						●					
	PVD PC325T <b>new</b>				S20-S30								●			
	PVD PC325U	P20-P35	M20-M30	K20-K35										●		
Uncoated	H01					N10-N20					●					
	H05S					N10-N20					●					
	FCC			N15-N35							●					
	FG2	P05-P25				N05-N25							●			
	FA1	P05-P25				N05-N25							●			
cBN	DBN500			K05-K15				●								
	DBN700A			K01-K10				●								
	DB7000	S01-S10						●								
	DB1000					H01-H10		●								
	DB2000					H05-H15		●								
	DBNX20					H15-H25		●								
	DBN250					H15-H25		●								
	DBN400					H15-H25		●								
	PVD DNC100					H01-H10		●								
	PVD DNC250					H05-H15		●								
	PVD DNC350					H25-H35		●								
	PVD DNC400 <b>new</b>					H15-H25		●								
PCD	DP90					N01-N20				●						
	DP150					N05-N25				●						
	DP200					N10-N30				●						
DIA	CVD ND2100 <b>new</b>					N2.5-N7.5		●		●	●		●			
	CVD ND3000 <b>new</b>					N01-N05		●		●	●					
DLC	PVD PD1005					N05-N10		●		●	●					
	PVD PD1010					N10-N15		●		●	●					





## The comparison of grade for turning

### WC

ISO	KORLOY	SUMITOMO	KYOCERA	ISCAR	SANDVIK	SECO	KENAMETAL	TOSHIBA	mitsubishi	HITACHI	VALENITE	WALTER	TAEGUTEC	NTK	DIJET
Turning	P	ST10	ST10					TX10S	ST110T	SRN5	S1F		P10		
		ST20	ST20			S1P		TX20	ST120T	WS20B			P20		
	ST30A	ST30A	PW30	IC50M	SM30	TTX	K45	TX30	UTi20T	EX35	VC6		P30		
		ST40E	IC54	S6	TTR	K420		TX40		EX40	VC5		P40		
		EX45								EX45	VC56				
	M	U20	U10E			AT10		TU10	UTi20T	WAM10B	VC27		M10		
		U20	U20		H13A	AT15	K2885	TU20		EX35	VC28		M20		
		ST30A	A40		H10F	TTR	K2S	TU40					M40		
	K	H01	H1	IC4	H1P	THM	K68	TH03	HTi10T	WH05	VC3		K10		
		H05		IC20	H10F	THR	K8735	TH10	HTi20T	W10	VC1		K20		
		G10	G10	IC28				KS20		WH20			K20M		
			KW10H										K30		

### CVD coated

ISO	KORLOY	SUMITOMO	KYOCERA	ISCAR	SANDVIK	SECO	KENAMETAL	TOSHIBA	mitsubishi	HITACHI	VALENITE	WALTER	TAEGUTEC	NTK	DIJET	
Turning	P	AC805P	CA5505			GC4305	TP0500	T9105	UE6105				TT8105			
		AC810P	CA510			GC4205	TP0501						TT8110			
		AC700G	CA515	IC8150		GC4315	TP1500	KCP05	T9115	UE6110	HG8010	VP5515	WPP10S	LC215P		
		AC900G	VP5115			GC4215	TGP25	KCP05B		MY5015			WKP13S	TT8115		
		CA5515	CA515					KCP10	T9125	MC6025	HG8025	VP5525	WPP20S	TT8120	CP5	JC110V
	AC820P	CA525	IC8250		GC4325	TP2500	KCP25	T9135	UE6020			WKP23S	LC225P		JC215V	
	AC2000	VP5125			GC4225	TP2501	KCP25B						TT8125			
	AC8025P	CA5525				TGP35							TT8125			
	NC3030	CR9025	IC8350		GC4335	TP3500	KCP30	T9135	MC6035	GM8035	VP5535	WPP30S	TT5100		JC325V	
	NC5330	CA5535			GC4235	TGP45	KCP30B		UE6035			WKP33S	TT8135		JC450	
	CA530					KCP40						TT7100				
						KCP40B		UH6400								
	M	NC9115	AC610M	CA6515	IC6015	S05F	KCM15	T6120	MC7015		VP8515	WAM10	TT9215			
		NC9125	AC610M	CA6515	IC6025	GC2015	KCM15M		MC7025	GM25	VP8525	WMP20S	TT9225			
		NC9135	AC630M	CA6525		GC2220	KCM25	T6130	US7020	GX30		WAM20	TT9235			
			AC6030M			GC2025	KCM25B					WAM30				
			AC6030M				KCM35		US735							
							KCM35B									
	K	NC6310	AC405K	CA4505	IC5005	GC3205	KCK05	T5105	MC5005	HG3505	VP1505	WKK10S	TT7005	CP2	JC105V	
		NC6315	AC415K	CA4010		GC3210	KCK05B	T5115	UC5105	HG3515	VP1510	WKK20S	TT7505	CP5	JC110V	
			CA4515	CA4115	IC5015	GC3215	KCK15	T5125	UC5115		VP1515		TT7310		JC215V	
			CA4115			GC3225	KCK15B						TT7015			
			CA4120				KCK20					WAK30	TT7025			
							KCK20B									

### PVD coated

ISO	KORLOY	SUMITOMO	KYOCERA	ISCAR	SANDVIK	SECO	KENAMETAL	TOSHIBA	mitsubishi	HITACHI	VALENITE	WALTER	TAEGUTEC	NTK	DIJET	
Turning	P	PC8105		PR1005	IC507			AH710			VC907					
		PC8110		PR915	IC808		CP200	KU10T			VC927				JC5003	
		PC8115		PR1115	IC830		CP250	KU25T	GH730							JC5015
		PC3035		PR930	IC908	GC1025			AH330	VP15TF	IP2000	VC905	WTA43			
		PC5300		PR1025	IC3028		CP500		AH740	VP20MF	IP3000		WTA41	TT5030		
			PR630	IC330				AH120								
			PR660	IC830	GC4125			GH330								
		M	PC8105	AC510U	PR915	IC907	GC1005	CP200	AH330	MP9005	IP50S	VC929	WSM10S			
			PC8110	EH510Z	PR930	IC830	GC1105	CP250	GH330	VP10RT	IP100S	VC927	WSM20S		ZM3	JC5003
			PC8120	AC520U		IC3028	GC1020		AH120			VC902	WSM30S		QM3	
		PC5300	EH520Z	PR1125	IC830	GC1025	CP500	GH730	VP15TF		VC901	WSM40S	TT5030	VM1	JC5015	
			AC530U	PR630		GC4125		AH140	VP20MF		VC905			TAS		
				PR660				AH630								
				IC330		GC2035			MP7035				TT8020			
	K	PC5300	EH510Z		IC5100						VC929					
			EH520Z		IC810		CP200	AH110		CY110H	VC903		TT5030			
					IC220		CP250	GH110			VC927					
					IC908		CP500	AH120			VC902					
					IC228						VC901					
											VC907					
	S	PC8105	AC510U	PR915	IC808	TS2000	CP500	AH110	VP05RT			WSM10	TT5030			
		PC8110	AC520U	PR660	IC907	CP500	CP500	AH120	VP10RT			WSM20				
		PC8115		PR1325	IC3028	TS2500	CP500		VP15TF			WSM30				
		PC8120			IC328		KC5010	AH120	MP7035							
		PC5300			IC328		KC5025									
		PC5400				GC2035										

### CERMET

ISO	KORLOY	SUMITOMO	KYOCERA	ISCAR	SANDVIK	SECO	KENAMETAL	TOSHIBA	mitsubishi	HITACHI	VALENITE	WALTER	TAEGUTEC	NTK	DIJET
Turning	P	CC1500	T110A	PV30				NS520	NX2525				PV3010	T3N	LN10
		CN1500	T2000Z	TN30	IC20N	CT5015	CM	HT2	GT530	NX3035			CT3000	T15	CX50
	CC2500	T1500A		IC520N	GC1525	C15M	KT125	NS530	UP35N	CH350	VC83	WTA43		N20	CX75
		CN2000	PV7020	IC30N		TP1020	HT5	NS530	AP25N	CH530		WTA41		C30	CX90
		CN2500	TN60	IC530N		TP1030	KT175	NS9530	NX335	CH550				N40	CX99
			TN6020				KT195M	GT9530	MP3025	CH570					
			TN90					NS540							
			PV90					NS730							
	M														
	K	CN1500	T110A						NX2525				CT3000	T15	LN10
		CN2500													CX75

★ : PVD Coating cermet ★ : New Grade

## The comparison of grade for milling

### CVD coated

ISO	KORLOY	SUMITOMO	KYOCERA	ISCAR	SANDVIK	SECO	KENAMETAL	TOSHIBA	mitsubishi	HITACHI	VALENITE	WALTER	TAEGUTEC	NTK	DIJET
Milling	P NC5330 NCM325 NCM535★ NCM335 NCM545★	ACP100		IC5100	GC4210 GC4220 GC4230	MP1500 MS2500 MP2500 MS2500 T350M MM4500	KCPM20 KCMP30 KC927M		FH7020 F7030		SM245	WKP25S WKP25S WKP35S WKP35G	TT8525 TT7800		
		NC5330 NC5340★ NC5350★				MP2500 MS2500 MM4500		T3130	F7030						
	K NC5330 NCM535★ NCM545★	ACK200		IC5100	GC3330 GC3040	MK1500 MK2000 MS2500 T350M MK3000	KC907M KCK15 KC914M KCPK30 KC917M KC924M	T1115 T1015	MC5020			WAK15 WKK25 WKP25S WKP35S WKP35G	TT7515 TT6800		

### PVD coated

ISO	KORLOY	SUMITOMO	KYOCERA	ISCAR	SANDVIK	SECO	KENAMETAL	TOSHIBA	mitsubishi	HITACHI	VALENITE	WALTER	TAEGUTEC	NTK	DIJET	
Milling	P PC2005★ PC2010★ PC2015★ PC2505★ PC2510★ PC3600 PC3700★ PC5400★				P20A GC1010					ATH80D PCA08M ACS05E PCA12M PC20M JX1005 TB6005 JX1020 CY9020			TT2510		DH102	
		ACZ310		IC903 IC908 IC950	MP3000		KC522M KUC20M	GH330	MP6120	TB6045	VC935	WKP25		TT7070 TT7080 TT7030		JC5003 JC5015
		ACP200	PR730	PR830 PR630	GC1025 GC1030	F25M F30M			VP15TF							
		PC210F	ACZ330	PR660	IC1008	GC1030		KC525M KUC30M	AH120	UP20M	CY250 PTH30E				QM3 ZM3	JC5030 JC5040
		PC5300	ACP300 ACZ350	PR660	IC928	GC1030	F40M T60M	KC935M KC7140 KC720	AH3135	VP30RT	JM4160 PTH40H		WKP35 WKP45	TT8020		
	M	PC210F PC5300	ACM100 ACP200	PR730	IC903			KC5510 KC7020	AH120		JX1020 CY9020 JX1015 TB6020 CY250			TT9030	QM3 ZM3	JC5003 JC5015
		PC9530	ACM300 ACP300 ACZ350	PR630 PR660 PR1535	IC900 IC250 IC928	GC1125 GC1025 GC2030 GC1030	F25M F30M	KC522M KC725M KC735M KC7030	AH140	MP7130	JX1045 TB6045	VC928 VC902 VC901	WQM35 WSM35S WSP45 WSM45S	TT9080 TT8020		JC5030 JC5040
		PC5400★ PC9540★		PR660	IC328		F40M	KC722	AH3135	MP7140	JX1060 TB6060					
	K	PC6510		PR510 PR905	DT7150 IC900 IC910 IC950 IC350		MK2050	KC510M KC915M KC520M		VP10MF VP15TF		VC903 VC928		TT6290		JC5003
		PC5300							AH120	VP20RT		VC902 VC901		TT6030 TT6060		JC5015
S	PC5300 PC5400★ PC9540★	AC520U	PR620 PR660 PR1535	IC328 IC408	GC1025 GC1040 S40T	F40M MS2050	KC510M KCU30M		VP15TF VP30RT MP9130	ACS05E		WSM35S WSM45S	TT9030 TT8020 TT8080			

### CERMET

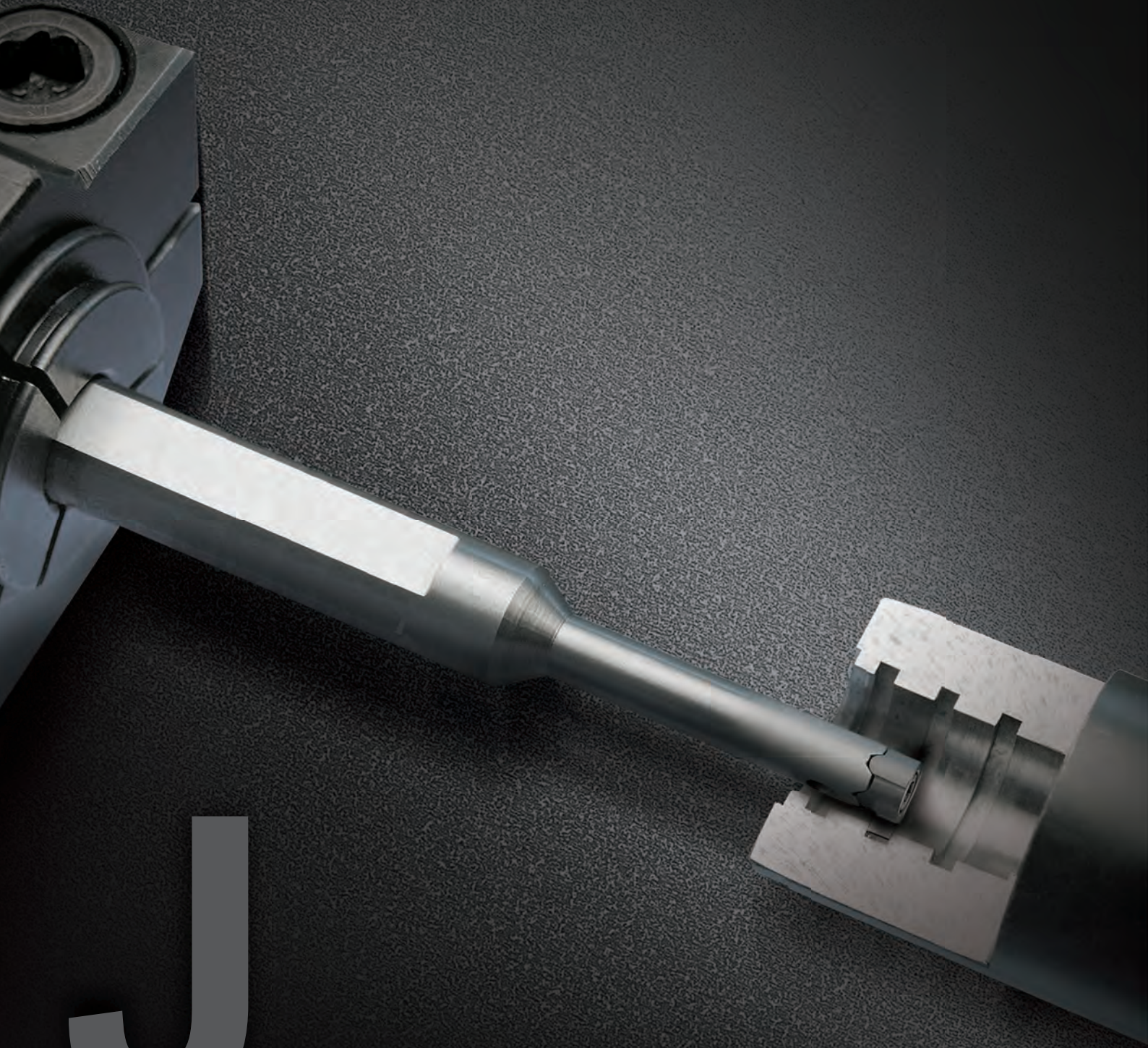
ISO	KORLOY	SUMITOMO	KYOCERA	ISCAR	SANDVIK	SECO	KENAMETAL	TOSHIBA	mitsubishi	HITACHI	VALENITE	WALTER	TAEGUTEC	NTK	DIJET
Milling	P CN2000 CN30	T250A	TN100M TC60M	IC30N			KT195M	NS540 NS740	NX2525 NX4545	CH550 CH570			CT3000 CT7000	C50	
	M	T250A				CT530									
K									NX2525						

★ : PVD Coating cermet    ★ : New Grade





# OLD-FASHIONED PRODUCT INFORMATION





## Old-fashioned product information

- J02** Grade
- J02** External Holder
- J02** Fine Tool
- J03** Threading Tool
- J03** Mill-Max
- J04** Cen-Mill
- J04** Jip Drill
- J04** LPD/SPD/NPD

## Grade

ISO material code		Old grade	New grade
Coating grade	P	NC5340	NCM535
		NCM325	
		NCM335	NCM545
		NC5350	
	PC3530, PC3525, PC3535, PC3500, PC3600		PC3700
	K	NC6215	NC6315
		NC6110, NC6210, NC6205	NC6310
	S	PC8010	PC8110
P, M, K, S	PC8520, PC215K	PC5300	
	PC225F	PC205F	
Cermet	CN1000	CN1500	
	CT10, CN200	CN2500	

- KORLOY always study and develops cutting-edge technology tools and grades which covers higher speed and feed conditions
- KORLOY guarantees better performance and wide stock-management range for the new grade

## External holder

Designation	Insert	Old parts name				New holder	Page
		Wedge clamp	Screw	Washer	Others		
WTENN□□□□-□16 (Old Type: MTEEN)	TN**1604	CMH5R1	MHX0523	WA4	Same as before	WTEEN□□□□-□16	B179
WTJNR□□□□-□16 (Old Type: MTJNR)	TN**1604	CMH5R1	MHX0523	WA4	Same as before	WTJNR□□□□-□16	B179
WTXNR□□□□-□16 (Old Type: MTXNR)	TN**1604	CMH5R1	MHX0523	WA4	Same as before	WTXNR□□□□-□16	B179

- Old parts are not interchangeable with new type holder part
- Good performance and convenient use of New type holder gives customer best quality of service

## Fine tool

Designation	Insert		Old parts name		New holder	Page
			Screw	Wrench		
FTIH	FTIH08****	FTG08, FTT08, FTF08	PTKA02508	TW08P	NFTIH	C69
	FTIH11****	FTG11, FTT11, FTF11	PTKA03510	TW15P		
	FTIH14****	FTG14, FTT14, FTF14	PTKA0412	TW15P		
	FTIH16****	FTG16, FTT16, FTF16	PTKA0512	TW20P		

- Old inserts and parts are not interchangeable with new fine tool
- Good performance and convenient use of new fine tool gives customer best quality of service



**Threading tool**

Designation	Insert		Old parts name						New holder	Page
			Clamp	Clamp screw	Shim	Screw	C-ring	Wrench		
<b>ETH</b>	~ ETH3**R	ECTR3***	CH5R3	CHX0513	ST32C1	SHX0310	CR04	HW20L, HW25L	ER(L)H-*	<b>D31</b>
	~ ETH4**R	ECTR4***	CH6R4	CHX0621	ST42C1	SHX0310	CR05	HW20L, HW30L		
<b>ITH</b>	~ ITH2**R	ICTR2***	CH5R3	CHX0513	ST32C1	FTKA02565	CR04	TW07P	IR(L)H-*	<b>D32</b>
	~ ITH3**R	ICTR3***	CH5R3	CHX0513	ST32C1	SHX0310	CR04	TW15P, HW20L, HW25L		
	~ ITH4**R	ICTR4***	CH6R4	CHX0621	ST42C1	SHX0310	CR05	HW20L, HW30L		

- Old inserts and parts are not interchangeable with threading holders
- Good performance and convenient use of new fine tool gives customer best quality of service

**Mill-Max**

Designation	Insert	Old parts name					New holder	Page
		Locator	Wedge	Wedge screw	Locator screw	Wrench		
<b>AD(ADM)4000</b>	SD**1203	LAS4R/L	WASR/L	WTX0817	LTX0512	TW25	ADN(ADNM)4000	<b>E47</b>
<b>AD(ADM)5000</b>	SD**1504	LAS5R/L	WASR/L	WTX0817	LTX0512	TW25	ADN(ADNM)5000+	<b>E48</b>
<b>ADN(ADNM)5000</b>	SD**1504	LADN5R/L	WEPN5R/L	DHA0821F	LTX0514	HW40		
<b>EP(EPM)4000</b>	SP**1203	LES4R/L LES4R1/L1 (Ø80 ~ Ø100)	WESR/L	WTX0817 WTX0813 (Ø80 ~ Ø100)	LTX0512	TW25	EPN(EPNM)4000	<b>E53</b>
<b>EP(EPM)5000</b>	SP**1504	LES5R/L LES5R1/L1 (Ø80 ~ Ø100)	WESR/L	WTX0817 WTX0813 (Ø80 ~ Ø100)	LTX0512	TW25	EPN(EPNM)5000+	<b>E54</b>
<b>EPN(EPNM)5000</b>	SP**1504	LEPN5R/L LEPN5R1/L1 (Ø80 ~ Ø100)	WEPN5R/L	DHA0821F DHA0817F (Ø80 ~ Ø100)	LTX0514	HW40		
<b>PP(PPM)4000</b>	TP**2204	LPT4R/L LPT4R1/L1 (Ø80 ~ Ø100)	WESR/L	WTX0817 WTX0813 (Ø80 ~ Ø100)	LTX0512	TW25	PPN(PPNM)4000	<b>E56</b>

- Parts are not interchangeable with new mill-max cutters
- Good performance and convenient use of new mill-max gives customer best quality of service



## ➤ Cen-Mill

Designation	Insert		Old parts name		New product	Page
			Screw	Wrench		
HE	Ø25	MCMT080308EN ZCMT080308ER	FTNA0307	TW09P	AMS****M	E185-E187
	Ø32, 40, 50	MCMT09T308EN ZCMT09T308ER	FTNA0408	TW15P		
LE (LEM)	LOCX1205ZZ		FTNB0411	TW15S	AMC****M	E172-E174
SE	Ø25	MPMT090308	FTNA0408	TW15S	AMS****MH	E188-E189
	Ø32, 40	MPMT120408	FTNA0513	TW20S		
TM	MIT100,150,200,300,400 MET100,150,200,300,400		FTNB0411(TM632R) FTNA0513	TW15L(TM632R) TW20L	TMS(I)	D49
PM	EDCW1604ZDF/TR		FTNA0513	TW20L	RM4Z	E118-E119
CE (Code changed)	SPG(M)N1203**				CE45-****R-S32 (New code)	E369-E371

- Old inserts and parts are not interchangeable with new milling product
- New product : Alpha mill which has unique alpha-curve edge guarantees wide range machining and good performance.
- Good performance and convenient use of new milling tool gives customer best quality of service

## ➤ Jip Drill

Designation	Insert		Old parts name		New product	Page
			Screw	Wrench		
JD	~ JD200	WCMT030208-C20	FTNA02565	TW07P	K□D (KING-DRILL)	F11-F25
	~ JD250	WCMT040208-C20				
	~ JD300	WCMT050308-C20	FTNA0307	TW09P		
	~ JD410	WCMT06T308-C20	FTGA03508			
	~ JD580	WCMT080408-C20	FTNA0408	TW15P		

- Old inserts and parts are not interchangeable with new indexable drill
- Good performance and convenient use of new indexable drill gives customer best quality of service

## ➤ LPD/SPD/NPD

Designation	Insert		Old parts name		New product	Page
			Screw	Wrench		
LPD	~ LPD135	LPMT040203-DF	FTNA0204	TW06P	K□D (KING-DRILL)	F11-F25
SPD	~ SPD155	SPM(E)T050203-DM, DF, DS, DA	FTNA0204	TW06P		
	~ SPD195	SPM(E)T060204-DM, DS, DR, DA	FTKA02206S	TW07S		
	~ SPD225	SPM(E)T070204-DM, DS, DR, DA	FTKA02565	TW07S		
NPD	~ NPD245	NPM(E)T222408-DM, DS, DR, DA	FTKA02565	TW07S		
	~ NPD285	NPM(E)T252808-DM, DS, DR, DA	FTKA0307	TW09S		
	~ NPD325	NPM(E)T293208-DM, DS, DR, DA	FTKA0307	TW09S		
	~ NPD405	NPM(E)T334008-DM, DS, DR, DA	FTKA03508	TW15S		
	~ NPD505	NPM(E)T415008-DM, DS, DR, DA	FTKA0410	TW15S		
	~ NPD605	NPM(E)T516012-DM, DS, DR, DA	FTNC04511	TW20S		

- Old inserts and parts are not interchangeable with new indexable drill
- Good performance and convenient use of new indexable drill gives customer best quality of service

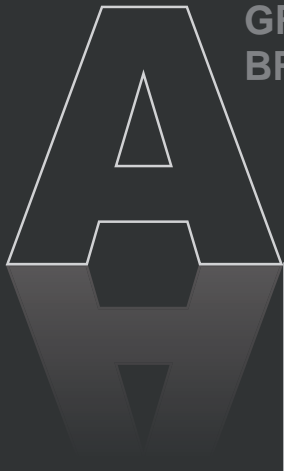






# INDEX

GRADES & CHIP  
BREAKERS



TURNING

MULTI  
FUNCTIONAL  
TOOLS



THREADING

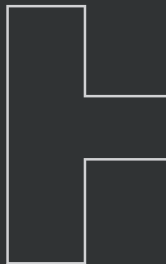
TOOLING  
SYSTEM



MILLING

DRILL

PARTS



TECHNICAL  
INFORMATION

OLD-FASHIONED  
PRODUCT  
INFORMATION



**INDEX**

**K02** Index by items

**K07** Index by designation

# K Index by items

## A

Actual Designations of Milling Cutter and Arbor	Milling	E426
Aero Mill	Milling	E151
Aero Mill Mini	Milling	E154
Aero Mill Plus	Milling	E152
Alpha Mill	Milling	E164
Alpha Mill-X		E197
Alpha Mill-X	Milling	E145
Aluminum Insert (Positive)	Turning	B102
American ACME	Threading	D24
American Buttress (ABUT)	Threading	D28
American UN	Threading	D16
Angular Head		G86
API Buttress Casing (BUT)	Threading	D30
API Round Casing & Tubing (APIRD)	Threading	D30
Application Example	Multi functional Tools	C02
Application range of KORLOY Main Chip Breakers	Turning	B02
Auto Tools (Blade Type)	Turning	B136
Auto Tools (ISO Type)	Turning	B122
Auto Tools (KGT/MGT Type)	Turning	B142
Auto Tools (MSB Tool)	Turning	B145
Auto Tools (Multi Utility Type)	Turning	B139
Available Insert	Drills	F03
Available Insert for Fine Tools	Multi functional Tools	C68
Available Insert for K Notch	Multi functional Tools	C57
Available Insert for KGT	Multi functional Tools	C12
Available Insert for MGT	Multi functional Tools	C28
Available Insert for MGT Aluminum Wheel	Multi functional Tools	C44
Available Insert for TB/TB-M	Multi functional Tools	C51
Available Insert for TB/TB-M	Multi functional Tools	C50

## B

Bearing Solution	Turning	B156
BFE	Milling	E331
Boring Bar Code System (ISO)	Turning	B204
BRE	Milling	E335
British Buttress (BBUT)	Threading	D28
British Standard Pipe Thread	Threading	D22
BT Tooling System (Alpha Mill)	Milling	E342
BT Tooling System (Mono-Tool)	Milling	E347

## C

Cartridge		H03
Cartridge Code System (ISO)	Turning	B241

## C

cBN inserts grades	Grades & Chip Breakers	A31
cBN Insert	Turning	B110
Cen-Mill	Old-Fashioned Product Information	J04
Center Drill	Drills	F78
Ceramic Holder	Turning	B197
Cermet grades (Milling)	Grades & Chip Breakers	A24
Cermet grades (Turning)	Grades & Chip Breakers	A13
Chamfer Tool	Milling	E366
Chip breaker		H03
Chip breaker for drilling	Grades & Chip Breakers	A49
Chip breaker for milling	Grades & Chip Breakers	A42
Chip breaker for turning	Grades & Chip Breakers	A37
Chip Cover	Parts	H03
Clamp	Parts	H03
Clamp On System (Boring Bar)	Turning	B212
Clamp On System (Cartridge)	Turning	B243
Clamp On System (Holder)	Turning	B181
Coated cermet grades (Turning)	Grades & Chip Breakers	A15
Collet Chuck Series	Tooling System	G24
Compact Mini	Turning	B225
Coolant Bolt	Parts	H04
CVD coated grades (Milling)	Grades & Chip Breakers	A17
CVD coated grades (Turning)	Grades & Chip Breakers	A05

## D

DAMPING PRO		G97
DBC	Tooling System	G66
DBCA	Tooling System	G62
DBH	Multi functional Tools	C70
DCJ		G95
DCL		G96
DCS/DC/TC	Tooling System	G23
DHC/DHJ Collet	Tooling System	G11
DHE	Tooling System	G07
DHE/S	Tooling System	G04
Diamond coated grades	Grades & Chip Breakers	A29
DLC coated grades	Grades & Chip Breakers	A30
Double Clamp System (Boring Bar)	Turning	B208
Double Clamp System (Holder)	Turning	B167
Double Mill	Milling	E62
DSC	Tooling System	G12
DSK	Tooling System	G30
DST	Tooling System	G41



**D**

DTN	Tooling System	G44
DZC		G94

**E**

ER	Tooling System	G36
ER/L	Tooling System	G37
EXT Bar	Tooling System	G54
External Holder	Threading	D31
External Holder	Old-Fashioned Product Information	J02
External Tool Holder Code System (ISO)	Turning	B162
Extreme Line Casing (EL)	Threading	D30

**F**

FBC	Tooling System	G82
FBH/B	Tooling System	G55
Feature of Chip Breakers	Turning	B16
Fine Tool	Old-Fashioned Product Information	J03
Fine Tools Holder	Multi functional Tools	C69
FMA	Tooling System	G49
FMC	Tooling System	G50
FMR P-positive	Milling	E242
Future Mill	Milling	E216

**G**

GBE	Milling	G82
Gear Cutter	Milling	G55
Gear Cutter Order Form	Milling	B16
Gear Cutter Table	Milling	J03
GERC	Tooling System	C69
GFIP	Multi functional Tools	G49
Grade	Old-Fashioned Product Information	G50
Grades system	Grades & Chip Breakers	E242
GSK	Tooling System	E216

**H**

Hardness calculating table		I 08
HAVE (Single edge/Multi edge)	Milling	E339
HFM	Milling	E281
HFMD		E267
HFMD	Milling	E264
HRM	Milling	E300

**H**

HRMDouble	Milling	E289
HSK Tooling System	Turning	B231
HSK Tooling System (Alpha Mill)	Milling	E353
HSK Tooling System (Mono-Tool)	Milling	E358
HSK Tooling System (Pro-V Mill)	Milling	E363

**I**

IGH	Multi functional Tools	C70
Index for Boring Bar	Turning	B205
Index for Cartridge	Turning	B242
Index for External Holder	Turning	B163
Index for HSK Tooling System	Turning	B230
Index for KM Tooling System	Turning	B230
Indexable HOB	Milling	E440
Indexable HOB Order Form	Milling	E441
Indexable Reamer		F86
Instruction of Boring Bar assembly	Turning	B207
Instruction of External Holder	Turning	B166
Internal Holder	Threading	D32
ISO Metric	Threading	D12
Jip Drill	Old-Fashioned Product Information	J04

**K**

K Notch Holder	Multi functional Tools	C59
KED Plus Drill	Drills	F29
KGT Blade for Parting off	Multi functional Tools	C25
KGT Cartridge	Multi functional Tools	C41
KGT Holder	Multi functional Tools	C15
KGT/MGT Cartridge Holder	Multi functional Tools	C40
KHP Coolant	Turning	B127
KHP Coolant	Turning	B202
KING DRILL	Drills	F11
KING DRILL for large diameter drilling	Drills	F25
KING DRILL for through coolant system with a lathe	Drills	F21
KM Tooling System	Turning	B237
KMB	Tooling System	G70
KORLOY Cutters	Milling	E34
KORLOY Grades	Technical Information	I 37
KORLOY Modular Adaptors	Milling	E45
KORLOY Shanks	Milling	E42
KRLOY Drills	Drills	F02

# K Index by items

## L

Laser Mill	Milling	E326
Lever	Parts	H04
Lever Lock System (Boring Bar)	Turning	B210
Lever Lock System (Holder)	Turning	B172
Locator	Parts	H05
LPD/SPD/NPD	Old-Fashioned Product Information	J04

## M

MD	Tooling System	G52
Metric Buttress (SAGE)/API	Threading	D29
MGT Aluminum Wheel	Multi functional Tools	C45
MGT Cartridge	Multi functional Tools	C42
MGT Holder	Multi functional Tools	C31
MGT Holder (Face Grooving)	Multi functional Tools	C36
MGT Special Order Form for MGT	Multi functional Tools	C72
Milling grade selections	Grades & Chip Breakers	A16
Milling Insert Code System (ISO)	Milling	E02
Milling Inserts	Milling	E04
Mill-max	Milling	E47
Mill-Max	Old-Fashioned Product Information	J03
Mill-max Heavy	Milling	E58
Mill-max Plus	Milling	E48, 54
Modular Adaptor	Milling	E401
Multi Lock System (Boring Bar)	Turning	B213
Multi Lock System (Holder)	Turning	B183
Multi Turn	Turning	B154

## N O

National Pipe Thread	Threading	D22
National Pipe Thread-Dry seal	Threading	D23
Nozzle	Parts	H07
NPM	Tooling System	G20
NPU	Tooling System	G40
Nut	Parts	H05
O-Ring Cutter	Milling	E364
Others	Tooling System	G104

## P

Partial Profile 55°	Threading	D11
Partial Profile 60°	Threading	D10
PCD Face Cutter	Milling	E156
PCD inserts grades	Grades & Chip Breakers	A36

## P

PCD Insert	Turning	B113
Pin	Parts	H05
Power Buster	Milling	E68
Pro-A Mill	Milling	E385
Pro-L Mill	Milling	E394
Properties of Korloy grades	Technical Information	I 09
Pro-V Mill		E399
Pro-V Mill	Milling	E368
Pro-X Mill	Milling	E388
Pro-XL Mill	Milling	E398
PVD coated grades (Milling)	Grades & Chip Breakers	A18
PVD coated grades (Turning)	Grades & Chip Breakers	A10

## R

RDC Bar	Tooling System	G54
Recommended Chip Breakers for workpiece	Turning	B04
Rich Mill	Milling	E99
Round DIN 405	Threading	D23
RTJW	Tooling System	G38

## S

SAH		G85
Save Turn Boring Bar	Turning	B119
Save Turn Holder	Turning	B116
Save Turn Insert	Turning	B115
Saw man	Multi functional Tools	C61
Saw man-X	Multi functional Tools	C65
Screw	Parts	H05
Screw On System (Boring Bar)	Turning	B215
Screw On System (Cartridge)	Turning	B245
Screw On System (Holder)	Turning	B190
SDC/P	Tooling System	G25
Shim		H02
Shim Pin	Parts	H06
SI unit conversion table	Technical Information	I 07
Side Cutter	Milling	E411
Side Milling Cutter	Milling	E407
SLA	Tooling System	G47
Sleeve	Turning	B151
SMB	Tooling System	G68
SMH	Tooling System	G72
Solid drills grade selections	Grades & Chip Breakers	A27
Solid drills grades	Grades & Chip Breakers	A28



**S**

<b>Solid endmills grade selections</b>	Grades & Chip Breakers	<b>A25</b>
<b>Solid endmills grades</b>	Grades & Chip Breakers	<b>A26</b>
<b>Special Order Form for Bearing Inserts</b>	Turning	<b>B161</b>
<b>Special Order Form for V-Pulley Insert</b>	Multi functional Tools	<b>C73</b>
<b>Spring</b>	Parts	<b>H07</b>
<b>Steel, Non-ferrous metal symbol list</b>	Technical Information	<b>I 06</b>
<b>Stop Ring</b>	Parts	<b>H07</b>
<b>Stopper</b>	Parts	<b>H07</b>
<b>Stub ACME</b>	Threading	<b>D25</b>

**T**

<b>Tank Mill</b>	Milling	<b>E307</b>
<b>TBC</b>	Tooling System	<b>G79</b>
<b>TBCA</b>	Tooling System	<b>G74</b>
<b>TB-M/TB Holder</b>	Multi functional Tools	<b>C54</b>
<b>TCA Tap Adaptor</b>	Tooling System	<b>G46</b>
<b>T-Cutter</b>	Milling	<b>E374</b>
<b>Technical Information for Aero Mill</b>	Milling	<b>E147</b>
<b>Technical Information for Aero Mill Mini</b>	Milling	<b>E150</b>
<b>Technical Information for Aero Mill Plus</b>	Milling	<b>E149</b>
<b>Technical Information for Alpha Mill</b>	Milling	<b>E157</b>
<b>Technical Information for Alpha Mill Nick</b>		<b>E158</b>
<b>Technical Information for Alpha Mill-X</b>		<b>E193</b>
<b>Technical Information for Alpha Mill-X</b>	Milling	<b>E142</b>
<b>Technical Information for Auto Tools</b>	Turning	<b>B121</b>
<b>Technical Information for Bearing Solution</b>	Turning	<b>B155</b>
<b>Technical Information for BRE</b>	Milling	<b>E325</b>
<b>Technical Information for BT/HSK Tooling System</b>	Milling	<b>E341</b>
<b>Technical Information for Couple Mill</b>	Milling	<b>E421</b>
<b>Technical Information for Cube Mill</b>	Milling	<b>E420</b>
<b>Technical Information for Drills</b>	Technical Information	<b>I 30</b>
<b>Technical Information for Endmills</b>	Technical Information	<b>I 27</b>
<b>Technical Information for Fine Tools</b>	Multi functional Tools	<b>C67</b>
<b>Technical Information for FMR P-positive</b>	Milling	<b>E211</b>
<b>Technical Information for Future Mill</b>	Milling	<b>E201</b>
<b>Technical Information for GBE</b>	Milling	<b>E322</b>
<b>Technical Information for Gear Cutter Tools</b>	Milling	<b>E429</b>
<b>Technical Information for HAVE</b>	Milling	<b>E337</b>
<b>Technical Information for HFM</b>	Milling	<b>E277</b>
<b>Technical Information for HFMD</b>		<b>E262</b>
<b>Technical Information for HFMD</b>	Milling	<b>E260</b>
<b>Technical Information for Hihg feed Cutter</b>	Milling	<b>E418</b>
<b>Technical Information for HRMDouble</b>	Milling	<b>E284</b>
<b>Technical Information for HSK Tooling System</b>	Turning	<b>B228</b>

**T**

<b>Technical Information for Indexable Reamer</b>		<b>F82</b>
<b>Technical Information for K Notch</b>	Multi functional Tools	<b>C55</b>
<b>Technical Information for KED Plus Drill</b>	Drills	<b>F26</b>
<b>Technical Information for KGT</b>	Multi functional Tools	<b>C07</b>
<b>Technical Information for KGT/MGT Cartridge</b>	Multi functional Tools	<b>C39</b>
<b>Technical Information for KHP Coolant</b>	Turning	<b>B199</b>
<b>Technical Information for KING DRILL</b>	Drills	<b>F05</b>
<b>Technical Information for KING DRILL (for large diameter drilling)</b>	Drills	<b>F24</b>
<b>Technical Information for KING DRILL (for through coolant system with a lathe)</b>	Drills	<b>F20</b>
<b>Technical Information for Laser Mill</b>	Milling	<b>E317</b>
<b>Technical Information for MGT</b>	Multi functional Tools	<b>C26</b>
<b>Technical Information for MGT Aluminum Wheel</b>	Multi functional Tools	<b>C43</b>
<b>Technical Information for Milling</b>	Technical Information	<b>I 20</b>
<b>Technical Information for Mill-max Heavy</b>	Milling	<b>E57</b>
<b>Technical Information for Multi Functional Tools Series</b>	Multi functional Tools	<b>C04</b>
<b>Technical Information for Multi Turn</b>	Turning	<b>B152</b>
<b>Technical Information for Power Buster</b>	Milling	<b>E64</b>
<b>Technical Information for Pro-A Mill</b>	Milling	<b>E375</b>
<b>Technical Information for Pro-L Mill</b>	Milling	<b>E379</b>
<b>Technical Information for Pro-L Mill</b>		<b>E382</b>
<b>Technical Information for Pro-V Mill</b>	Milling	<b>E351</b>
<b>Technical Information for Pro-X Mill</b>	Milling	<b>E377</b>
<b>Technical Information for Pro-XL Mill</b>	Milling	<b>E381</b>
<b>Technical Information for Rich Mill</b>	Milling	<b>E71</b>
<b>Technical Information for Save Turn</b>	Turning	<b>B114</b>
<b>Technical Information for Saw man</b>	Multi functional Tools	<b>C60</b>
<b>Technical Information for Saw man-X</b>	Multi functional Tools	<b>C63</b>
<b>Technical Information for Shave Mill</b>	Milling	<b>E423</b>
<b>Technical Information for Shave Mill Ultra</b>	Milling	<b>E425</b>
<b>Technical Information for Side Milling Cutters</b>	Milling	<b>E405</b>
<b>Technical Information for Tapers</b>	Technical Information	<b>I 24</b>
<b>Technical Information for TB/TB-M</b>	Multi functional Tools	<b>C47</b>
<b>Technical Information for Thread Milling</b>	Threading	<b>D34</b>
<b>Technical Information for Threading</b>	Threading	<b>D03</b>
<b>Technical Information for TP2P</b>	Milling	<b>E308</b>
<b>Technical Information for TPDB Plus Drill</b>	Drills	<b>F54</b>
<b>Technical Information for TPDB-F</b>		<b>F63</b>
<b>Technical Information for TPDB-H</b>	Drills	<b>F68</b>
<b>Technical Information for TPDC Plus Drill</b>	Drills	<b>F37</b>
<b>Technical Information for Triple Mill</b>		<b>E254</b>
<b>Technical Information for Turning</b>	Technical Information	<b>I 10</b>
<b>Technical Information for Wind Mill</b>	Milling	<b>E414</b>
<b>Technical Information for WPDC</b>	Drills	<b>F75</b>
<b>Technical Information KM Tooling System</b>	Turning	<b>B229</b>
<b>TER Tap Collet</b>	Tooling System	<b>G43</b>



# K Index by items

## T

<b>The Comparison of Grade for Milling</b>	Technical Information	I 41
<b>The Comparison of Grade for Turning</b>	Technical Information	I 40
<b>The Comparison of Chip Breakers</b>	Technical Information	I 36
<b>Thread Milling Holder</b>	Threading	D49
<b>Thread Milling Inserts</b>	Threading	D44
<b>Threading Holder Code System</b>	Threading	D02
<b>Threading Insert Code System</b>	Threading	D02
<b>Threading Insert with Chip Breaker</b>	Threading	D09
<b>Threading Tool</b>	Old-Fashioned Product Information	J03
<b>Tooling System Index</b>	Tooling System	G02
<b>TP2P</b>	Milling	E311
<b>TPDB Plus Drill</b>	Drills	F57
<b>TPDB-F</b>		F66
<b>TPDB-H</b>	Drills	F71
<b>TPDC Plus Drill</b>	Drills	F47
<b>Trapez DIN 103</b>	Threading	D24
<b>Triple Mill</b>		E258
<b>Turbo Mill</b>	Milling	E59
<b>Turning grade selections</b>	Grades & Chip Breakers	A04
<b>Turning Insert (Negative)</b>	Turning	B36
<b>Turning Insert (Positive)</b>	Turning	B73
<b>Turning Insert Code System (ISO)</b>	Turning	B34

## U

<b>Uncoated carbide grades (Milling)</b>	Grades & Chip Breakers	A23
<b>Uncoated carbide grades (Turning)</b>	Grades & Chip Breakers	A12
<b>UNJ (Unified Constant Thread)</b>	Threading	D26

## V

<b>Vertical Type Holder</b>	Threading	D33
-----------------------------	-----------	-----

## W

<b>Washer</b>	Parts	H07
<b>Wedge Clamp System(Holder)</b>	Turning	B179
<b>Wind Mill</b>	Milling	E416
<b>With Worth</b>	Threading	D18
<b>Workpiece material grades</b>	Technical Information	I 02
<b>WPDC</b>	Drills	F79
<b>Wrench</b>	Parts	H07
<b>Wrench Bolt</b>	Parts	H04



**A**

<b>ADKA</b>	Milling insert (Indexable Endmill)	<b>E04</b>
<b>ADKT-ML</b>	Milling insert (Alpha Mill-X)	<b>E04</b>
<b>ADKT-MM</b>	Milling insert (Alpha Mill-X)	<b>E04</b>
<b>ADLT</b>	Milling insert (Tank Mill)	<b>E04</b>
<b>ADN(M)4000</b>	Mill-max	<b>E47</b>
<b>ADN(M)5000+</b>	Mill-max Plus	<b>E48</b>
<b>ADS4000</b>	Turbo Mill	<b>E59</b>
<b>ADS5000</b>	Turbo Mill	<b>E60</b>
<b>AE(M)4000</b>	Mill-max	<b>E49</b>
<b>AE(M)5000</b>	Mill-max	<b>E50</b>
<b>AFO(M)4000</b>	Double Mill	<b>E62</b>
<b>AFO(M)5000</b>	Double Mill	<b>E63</b>
<b>AMC(M)1000S</b>	Alpha Mill	<b>E164</b>
<b>AMC(M)1000SE</b>	Alpha Mill	<b>E170</b>
<b>AMC(M)1500S</b>	Alpha Mill	<b>E165</b>
<b>AMC(M)2000M</b>	Alpha Mill	<b>E172</b>
<b>AMC(M)2000S</b>	Alpha Mill	<b>E166</b>
<b>AMC(M)2000SE</b>	Alpha Mill	<b>E170</b>
<b>AMC(M)3000M</b>	Alpha Mill	<b>E173</b>
<b>AMC(M)3000S</b>	Alpha Mill	<b>E167</b>
<b>AMC(M)3000SE</b>	Alpha Mill	<b>E171</b>
<b>AMC(M)3000S-K</b>	Alpha Mill	<b>E168</b>
<b>AMC(M)4000M</b>	Alpha Mill	<b>E174</b>
<b>AMC(M)4000S</b>	Alpha Mill	<b>E169</b>
<b>AMM1000</b>	Alpha Mill	<b>E190</b>
<b>AMM1500</b>	Alpha Mill	<b>E191</b>
<b>AMM2000</b>	Alpha Mill	<b>E192</b>
<b>AMS1000M</b>	Alpha Mill	<b>E185</b>
<b>AMS1000MH</b>	Alpha Mill	<b>E188</b>
<b>AMS1000S</b>	Alpha Mill	<b>E175</b>
<b>AMS1000SE</b>	Alpha Mill	<b>E183</b>
<b>AMS1500M</b>	Alpha Mill	<b>E185</b>
<b>AMS1500MH</b>	Alpha Mill	<b>E188</b>
<b>AMS1500S</b>	Alpha Mill	<b>E176</b>
<b>AMS2000M</b>	Alpha Mill	<b>E186</b>
<b>AMS2000MH</b>	Alpha Mill	<b>E189</b>
<b>AMS2000S</b>	Alpha Mill	<b>E178</b>
<b>AMS2000SE</b>	Alpha Mill	<b>E183</b>
<b>AMS3000MH(-K)</b>	Alpha Mill	<b>E189</b>
<b>AMS3000S</b>	Alpha Mill	<b>E179</b>
<b>AMS3000SE</b>	Alpha Mill	<b>E184</b>
<b>AMS3000S-K</b>	Alpha Mill	<b>E180</b>
<b>AMS4000M</b>	Alpha Mill	<b>E187</b>
<b>AMS4000S</b>	Alpha Mill	<b>E181</b>
<b>AMXCM-AD10/12</b>	Alpha Mill-X	<b>E197</b>

**A**

<b>AMXCM-AD17</b>	Alpha Mill-X	<b>E198</b>
<b>AMXS-AD10/12</b>	Alpha Mill-X	<b>E199</b>
<b>AMXS-AD17</b>	Alpha Mill-X	<b>E200</b>
<b>APD(M)-A</b>	Aero Mill	<b>E151</b>
<b>APD(M)-PB</b>	Aero Mill-Plus	<b>E152</b>
<b>API</b>	Thread Insert	<b>D29</b>
<b>APKT</b>	Milling Insert (Alpha Mill)	<b>E04</b>
<b>APKT-MA</b>	Milling Insert (Alpha Mill)	<b>E04</b>
<b>APKT-MA2</b>	Milling Insert (Alpha Mill)	<b>E04</b>
<b>APKT-MA3</b>	Milling Insert (Alpha Mill)	<b>E04</b>
<b>APKT-MF</b>	Milling Insert (Alpha Mill)	<b>E04</b>
<b>APKT-MM</b>	Milling Insert (Alpha Mill)	<b>E04</b>
<b>APLT</b>	Milling insert (Tank Mill)	<b>E05</b>
<b>APMT-MA</b>	Milling Insert (Alpha Mill)	<b>E05</b>
<b>APMT-ML</b>	Milling Insert (Alpha Mill)	<b>E05</b>
<b>APMT-MM</b>	Milling Insert (Alpha Mill)	<b>E06</b>
<b>APMT-MN</b>	Milling Insert (Alpha Mill)	<b>E06</b>

**B**

<b>BAMPR/L-XAF</b>	Milling Insert (Aero Mill-Plus)	<b>E07</b>
<b>BAMPR/L-XAW</b>	Milling Insert (Aero Mill-Plus)	<b>E07</b>
<b>BAMPR/L-XAWR</b>	Milling Insert (Aero Mill-Plus)	<b>E07</b>
<b>BF</b>	Multi functional Insert (Grooving Tools)	<b>C71</b>
<b>BFE</b>	BFE	<b>E331</b>
<b>BRE</b>	BRE	<b>E335</b>
<b>BT30</b>	Modular Adaptor (BT)	<b>E403</b>
<b>BT30 AM1000</b>	BT Tooling System (Mono-Tool)	<b>E347</b>
<b>BT30 AM1000HS</b>	BT Tooling System (Alpha Mill)	<b>E342</b>
<b>BT30 AM1500</b>	BT Tooling System (Mono-Tool)	<b>E348</b>
<b>BT30 AM2000</b>	BT Tooling System (Mono-Tool)	<b>E349</b>
<b>BT40</b>	Modular Adaptor (BT)	<b>E403</b>
<b>BT40 AM1000</b>	BT Tooling System (Mono-Tool)	<b>E347</b>
<b>BT40 AM1500</b>	BT Tooling System (Mono-Tool)	<b>E348</b>
<b>BT40 AM1500HS</b>	BT Tooling System (Alpha Mill)	<b>E343</b>
<b>BT40 AM2000</b>	BT Tooling System (Mono-Tool)	<b>E349</b>
<b>BT40 AM2000HS</b>	BT Tooling System (Alpha Mill)	<b>E344</b>
<b>BT50</b>	Modular Adaptor (BT)	<b>E403</b>
<b>BT50 AM3000</b>	BT Tooling System (Mono-Tool)	<b>E350</b>
<b>BT50 AM3000HS</b>	BT Tooling System (Alpha Mill)	<b>E345</b>
<b>BT50 AM4000</b>	BT Tooling System (Mono-Tool)	<b>E351</b>
<b>BT50 AM4000HS</b>	BT Tooling System (Alpha Mill)	<b>E346</b>
<b>BT50 HAT4000</b>	BT Tooling System (Mono-Tool)	<b>E352</b>

# K Index by designation



<b>CCET</b>	Turning Insert_Positive (Carbide Shank Boring Bar)	<b>B75</b>
<b>CCET-KF</b>	Auto tools Insert (ISO type)	<b>B130</b>
<b>CCET-KF</b>	Auto tools Insert (ISO type)	<b>B76</b>
<b>CCET-KM</b>	Auto tools Insert (ISO type)	<b>B131</b>
<b>CCET-KM</b>	Auto tools Insert (ISO type)	<b>B77</b>
<b>CCGT-AK</b>	Aluminum Insert_Positive (Screw on System)	<b>B103</b>
<b>CCGT-AR</b>	Aluminum Insert_Positive (Screw on System)	<b>B103</b>
<b>CCGT-FS</b>	Auto tools Insert (ISO type)	<b>B131</b>
<b>CCGT-FS</b>	Turning Insert_Positive (Screw on System)	<b>B74</b>
<b>CCGT-KF</b>	Auto tools Insert (ISO type)	<b>B130</b>
<b>CCGT-KF</b>	Turning Insert_Positive (Screw on System)	<b>B76</b>
<b>CCGT-KM</b>	Auto tools Insert (ISO type)	<b>B130</b>
<b>CCGT-KM</b>	Turning Insert_Positive (Screw on System)	<b>B77</b>
<b>CCGT-MS</b>	Auto tools Insert (ISO type)	<b>B131</b>
<b>CCGT-MS</b>	Turning Insert_Positive (Screw on System)	<b>B74</b>
<b>CCGT-VP1</b>	Auto tools Insert (ISO type)	<b>B131</b>
<b>CCGT-VP1</b>	Turning Insert_Positive (Screw on System)	<b>B75</b>
<b>CCLNR/L</b>	Ceramic Holder	<b>B197</b>
<b>CCMT</b>	PCD Insert_Positive	<b>B113</b>
<b>CCMT-C25</b>	Turning Insert_Positive (Screw on System)	<b>B74</b>
<b>CCMT-FP</b>	Turning Insert_Positive (Screw on System)	<b>B73</b>
<b>CCMT-HMP</b>	Turning Insert_Positive (Screw on System)	<b>B73</b>
<b>CCMT-MP</b>	Turning Insert_Positive (Screw on System)	<b>B73</b>
<b>CCMT-VF</b>	Turning Insert_Positive (Screw on System)	<b>B73</b>
<b>CCMT-VL</b>	Turning Insert_Positive (Screw on System)	<b>B73</b>
<b>CCMT-VP1</b>	Turning Insert_Positive (Screw on System)	<b>B74</b>
<b>CCMW</b>	cBN Insert_Positive (Regrinding)	<b>B112</b>
<b>CCMW</b>	PCD Insert_Positive	<b>B113</b>
<b>CCT</b>	Solid Chamfer Tool	<b>E373</b>
<b>CD</b>	Drill Insert (Center Drill)	<b>F78</b>
<b>CDEW-NAF</b>	Milling Insert (Aero Mill)	<b>E07</b>
<b>CDEW-NAW</b>	Milling Insert (Aero Mill)	<b>E07</b>
<b>CDEW-XAF</b>	Milling Insert (Aero Mill)	<b>E07</b>
<b>CDEW-XAW</b>	Milling Insert (Aero Mill)	<b>E07</b>
<b>CDEW-XCF</b>	Milling Insert (Aero Mill)	<b>E07</b>
<b>CDH</b>	Drill Insert (Center Drill)	<b>F78</b>
<b>CE</b>	Chamfer Tool (Back & Front Chamfer)	<b>E369</b>
<b>CE</b>	Chamfer Tool (Long Chamfer)	<b>E370</b>
<b>CE</b>	Chamfer Tool (Multi-functional)	<b>E371</b>
<b>CET</b>	Solid Chamfer Tool	<b>E372</b>
<b>CKFNR/L...RW</b>	Bearing Solution	<b>B159</b>
<b>CKGNR...RW</b>	Bearing Solution	<b>B159</b>
<b>CKJNR/L</b>	Holder (Clamp on System)	<b>B181</b>
<b>CKNNR/L</b>	Holder (Clamp on System)	<b>B181</b>
<b>CKUNR/L</b>	Boring Bar (Clamp on System)	<b>B212</b>



<b>CMSNR/L...B</b>	Bearing Solution	<b>B156</b>
<b>CMSNR/L...F</b>	Bearing Solution	<b>B156</b>
<b>CNGG-VP1</b>	Turning Insert_Negative (Multi Lock/Lever Lock System)	<b>B40</b>
<b>CNGG-VP3</b>	Turning Insert_Negative (Multi Lock/Lever Lock System)	<b>B41</b>
<b>CNHQ</b>	Milling Insert (Side milling cutter_Tangential type)	<b>E07</b>
<b>CNMA</b>	cBN Insert_Negative(Regrinding)	<b>B112</b>
<b>CNMA</b>	Turning Insert_Negative (Multi Lock / Lever Lock System)	<b>B39</b>
<b>CNMG-B25</b>	Turning Insert_Negative (Multi Lock/Lever Lock System)	<b>B38</b>
<b>CNMG-CP</b>	Turning Insert_Negative (Multi Lock/Lever Lock System)	<b>B36</b>
<b>CNMG-GR</b>	Turning Insert_Negative (Multi Lock/Lever Lock System)	<b>B38</b>
<b>CNMG-HA</b>	Turning Insert_Negative (Multi Lock/Lever Lock System)	<b>B41</b>
<b>CNMG-HM</b>	Turning Insert_Negative	<b>B37</b>
<b>CNMG-LP</b>	Turning Insert_Negative (Multi Lock/Lever Lock System)	<b>B36</b>
<b>CNMG-LW</b>	Turning Insert_Negative (Multi Lock/Lever Lock System)	<b>B42</b>
<b>CNMG-MK</b>	Turning Insert_Negative (Multi Lock/Lever Lock System)	<b>B38</b>
<b>CNMG-MM</b>	Turning Insert (SAVE TURN)	<b>B115</b>
<b>CNMG-MM</b>	Turning Insert_Negative (Multi Lock/Lever Lock System)	<b>B40</b>
<b>CNMG-MP</b>	Turning Insert (SAVE TURN)	<b>B115</b>
<b>CNMG-MP</b>	Turning Insert_Negative (Multi Lock/Lever Lock System)	<b>B37</b>
<b>CNMG-RK</b>	Turning Insert_Negative (Multi Lock/Lever Lock System)	<b>B39</b>
<b>CNMG-RM</b>	Turning Insert_Negative (Multi Lock/Lever Lock System)	<b>B40</b>
<b>CNMG-VB</b>	Turning Insert_Negative (Multi Lock/Lever Lock System)	<b>B36</b>
<b>CNMG-VC</b>	Turning Insert_Negative (Multi Lock/Lever Lock System)	<b>B36</b>
<b>CNMG-VF</b>	Turning Insert_Negative (Multi Lock/Lever Lock System)	<b>B36</b>
<b>CNMG-VL</b>	Turning Insert_Negative (Multi Lock/Lever Lock System)	<b>B36</b>
<b>CNMG-VM</b>	Turning Insert_Negative (Multi Lock/Lever Lock System)	<b>B37</b>
<b>CNMG-VP1</b>	Turning Insert_Negative (Multi Lock/Lever Lock System)	<b>B40</b>
<b>CNMG-VP2</b>	Turning Insert_Negative (Multi Lock/Lever Lock System)	<b>B41</b>
<b>CNMG-VP3</b>	Turning Insert_Negative (Multi Lock/Lever Lock System)	<b>B41</b>
<b>CNMG-VP4</b>	Turning Insert_Negative (Multi Lock/Lever Lock System)	<b>B41</b>
<b>CNMG-VQ</b>	Turning Insert (SAVE TURN)	<b>B115</b>
<b>CNMG-VQ</b>	Turning Insert_Negative (Multi Lock/Lever Lock System)	<b>B38</b>
<b>CNMG-VR</b>	Turning Insert_Negative (Multi Lock/Lever Lock System)	<b>B39</b>
<b>CNMG-VW</b>	Turning Insert_Negative (Multi Lock/Lever Lock System)	<b>B41</b>
<b>CNMM</b>	PCD Insert_Negative	<b>B113</b>
<b>CNMM-GH</b>	Turning Insert_Negative (Multi Lock / Lever Lock System)	<b>B42</b>
<b>CNMM-GR</b>	Turning Insert_Negative (Lever Lock System)	<b>B42</b>
<b>CNMM-VH</b>	Turning Insert_Negative (Lever Lock System)	<b>B42</b>
<b>CNMM-VT</b>	Turning Insert_Negative (Lever Lock System)	<b>B42</b>
<b>CP Chip Breaker</b>	Turning Chip Breaker	<b>B16</b>
<b>CPGT</b>	Turning Insert_Positive (Screw on System)	<b>B78</b>
<b>CPGT-HMP</b>	Turning Insert_Positive (Screw on System)	<b>B78</b>
<b>CPMH</b>	Milling Insert (T-Cutter)	<b>E07</b>
<b>CPMT</b>	Milling Insert (T-Cutter)	<b>E08</b>
<b>CPMT-C25</b>	Turning Insert_Positive (Screw on System)	<b>B78</b>



**C**

<b>CPMT-VF</b>	Turning Insert_Positive (Screw on System)	<b>B78</b>
<b>CPMT-VL</b>	Turning Insert_Positive (Screw on System)	<b>B78</b>
<b>CRDNN</b>	Ceramic Holder	<b>B197</b>
<b>CRGNR/L</b>	Ceramic Holder	<b>B197</b>
<b>CSBNR/L...BS</b>	Bearing Solution	<b>B160</b>
<b>CSDNN</b>	Ceramic Holder	<b>B197</b>
<b>CSDPN</b>	Holder (Clamp on System)	<b>B181</b>
<b>CSGNR/L...RW</b>	Bearing Solution	<b>B159</b>
<b>CSKNR/L</b>	Ceramic Holder	<b>B198</b>
<b>CSKNR/L...BS</b>	Bearing Solution	<b>B160</b>
<b>CSKPR/L</b>	Holder (Clamp on System)	<b>B182</b>
<b>CSKPR/L</b>	Boring Bar (Clamp on System)	<b>B212</b>
<b>CSKPR/L</b>	Cartridge (Clamp on System)	<b>B243</b>
<b>CSKPR/L...B</b>	Bearing Solution	<b>B158</b>
<b>CTFNR/L</b>	Ceramic Holder	<b>B198</b>
<b>CTFPR/L</b>	Holder (Clamp on System)	<b>B182</b>
<b>CTFPR/L</b>	Boring Bar (Clamp on System)	<b>B212</b>
<b>CTFPR/L</b>	Cartridge (Clamp on System)	<b>B243</b>
<b>CTGNR/L</b>	Ceramic Holder	<b>B198</b>
<b>CTGNR/L...BS</b>	Bearing Solution	<b>B160</b>
<b>CTGPR/L</b>	Holder (Clamp on System)	<b>B182</b>
<b>CTSPR/L</b>	Cartridge (Clamp on System)	<b>B244</b>
<b>CTTPR/L</b>	Cartridge (Clamp on System)	<b>B244</b>
<b>CTWPR/L</b>	Cartridge (Clamp on System)	<b>B245</b>

**D**

<b>DB</b>	Multi functional Insert (Grooving Tools)	<b>C70</b>
<b>DBH</b>	Multi functional holder (Grooving Tools)	<b>C70</b>
<b>DC</b>	Multi functional Insert (Grooving Tools)	<b>C70</b>
<b>DCBNR/L</b>	Holder (Double clamp system)	<b>B167</b>
<b>DCET-KF</b>	Auto tools Insert (ISO type)	<b>B132</b>
<b>DCET-KF</b>	Turning Insert_Positive (Screw on System)	<b>B81</b>
<b>DCET-KM</b>	Auto tools Insert (ISO type)	<b>B132</b>
<b>DCET-KM</b>	Turning Insert_Positive (Screw on System)	<b>B82</b>
<b>DCGT</b>	PCD Insert_Positive	<b>B113</b>
<b>DCGT-AK</b>	Aluminum Insert_Positive (Screw on System)	<b>B104</b>
<b>DCGT-AR</b>	Aluminum Insert_Positive (Screw on System)	<b>B104</b>
<b>DCGT-FS</b>	Auto tools Insert (ISO type)	<b>B132</b>
<b>DCGT-FS</b>	Turning Insert_Positive (Screw on System)	<b>B80</b>
<b>DCGT-KF</b>	Auto tools Insert (ISO type)	<b>B131</b>
<b>DCGT-KF</b>	Turning Insert_Positive (Screw on System)	<b>B81</b>
<b>DCGT-KM</b>	Auto tools Insert (ISO type)	<b>B132</b>
<b>DCGT-KM</b>	Turning Insert_Positive (Screw on System)	<b>B82</b>
<b>DCGT-MS</b>	Auto tools Insert (ISO type)	<b>B132</b>

**D**

<b>DCGT-MS</b>	Turning Insert_Positive (Screw on System)	<b>B80</b>
<b>DCGT-VP1</b>	Auto tools Insert (ISO type)	<b>B133</b>
<b>DCGT-VP1</b>	Turning Insert_Positive (Screw on System)	<b>B81</b>
<b>DCGW</b>	cBN Insert_Positive (Regrinding)	<b>B112</b>
<b>DCKNR/L</b>	Holder (Double clamp system)	<b>B167</b>
<b>DCLNR/L</b>	Holder (Double clamp system)	<b>B167</b>
<b>DCLNR/L</b>	Boring Bar (Double clamp system)	<b>B208</b>
<b>DCLNR/L</b>	HSK Tooling System	<b>B231, 235</b>
<b>DCLNR/L</b>	KM Tooling System	<b>B237</b>
<b>DCMNN</b>	HSK Tooling System	<b>B231</b>
<b>DCMNN</b>	KM Tooling System	<b>B237</b>
<b>DCMT</b>	PCD Insert_Positive	<b>B113</b>
<b>DCMT-C25</b>	Turning Insert_Positive (Screw on System)	<b>B80</b>
<b>DCMT-FP</b>	Turning Insert_Positive (Screw on System)	<b>B79</b>
<b>DCMT-HMP</b>	Turning Insert_Positive (Screw on System)	<b>B79</b>
<b>DCMT-MP</b>	Turning Insert_Positive (Screw on System)	<b>B79</b>
<b>DCMT-VF</b>	Turning Insert_Positive (Screw on System)	<b>B79</b>
<b>DCMT-VL</b>	Turning Insert_Positive (Screw on System)	<b>B79</b>
<b>DCMT-VP1</b>	Turning Insert_Positive (Screw on System)	<b>B80</b>
<b>DDJNR/L</b>	Holder (Double clamp system)	<b>B168</b>
<b>DDJNR/L</b>	HSK Tooling System	<b>B231</b>
<b>DDJNR/L</b>	KM Tooling System	<b>B237</b>
<b>DDNNN</b>	HSK Tooling System	<b>B231</b>
<b>DDNNN</b>	KM Tooling System	<b>B238</b>
<b>DDUNR/L</b>	Boring Bar (Double clamp system)	<b>B208</b>
<b>DF</b>	Side Cutter	<b>E413</b>
<b>DNGG-VP1</b>	Turning Insert_Negative (Multi Lock/Lever Lock, HSK Tooling System)	<b>B47</b>
<b>DNGG-VP3</b>	Turning Insert_Negative (Multi Lock/Lever Lock, HSK Tooling System)	<b>B47</b>
<b>DNMA</b>	cBN Insert_Negative (Regrinding)	<b>B112</b>
<b>DNMA</b>	Turning Insert_Negative (Multi Lock/Lever Lock, HSK Tooling System)	<b>B46</b>
<b>DNMG-B25</b>	Turning Insert_Negative (Multi Lock/Lever Lock, HSK Tooling System)	<b>B45</b>
<b>DNMG-CP</b>	Turning Insert_Negative (Multi Lock/Lever Lock, HSK Tooling System)	<b>B44</b>
<b>DNMG-GR</b>	Turning Insert_Negative (Multi Lock/Lever Lock, HSK Tooling System)	<b>B45</b>
<b>DNMG-HA</b>	Turning Insert_Negative (Multi Lock/Lever Lock, HSK Tooling System)	<b>B48</b>
<b>DNMG-HM</b>	Turning Insert_Negative	<b>B44</b>
<b>DNMG-LP</b>	Turning Insert_Negative (Multi Lock/Lever Lock, HSK Tooling System)	<b>B43</b>
<b>DNMG-LW</b>	Turning Insert_Negative (Multi Lock/Lever Lock, HSK Tooling System)	<b>B48</b>
<b>DNMG-MK</b>	Turning Insert_Negative (Multi Lock/Lever Lock, HSK Tooling System)	<b>B46</b>
<b>DNMG-MM</b>	Turning Insert_SAVE TURN	<b>B115</b>
<b>DNMG-MM</b>	Turning Insert_Negative (Multi Lock/Lever Lock, HSK Tooling System)	<b>B46</b>
<b>DNMG-MP</b>	Turning Insert_SAVE TURN	<b>B115</b>
<b>DNMG-MP</b>	Turning Insert_Negative (Multi Lock/Lever Lock, HSK Tooling System)	<b>B44</b>
<b>DNMG-RK</b>	Turning Insert_Negative (Multi Lock/Lever Lock, HSK Tooling System)	<b>B46</b>
<b>DNMG-RM</b>	Turning Insert_Negative (Multi Lock/Lever Lock, HSK Tooling System)	<b>B47</b>
<b>DNMG-VB</b>	Turning Insert_Negative (Multi Lock/Lever Lock, HSK Tooling System)	<b>B43</b>

# K Index by designation

## D

<b>DNMG-VC</b>	Turning Insert_Negative (Multi Lock/Lever Lock, HSK Tooling System)	<b>B44</b>
<b>DNMG-VF</b>	Turning Insert_Negative (Multi Lock/Lever Lock, HSK Tooling System)	<b>B43</b>
<b>DNMG-VL</b>	Turning Insert_Negative (Multi Lock/Lever Lock, HSK Tooling System)	<b>B43</b>
<b>DNMG-VM</b>	Turning Insert_Negative (Multi Lock/Lever Lock, HSK Tooling System)	<b>B45</b>
<b>DNMG-VP1</b>	Turning Insert_Negative (Multi Lock/Lever Lock, HSK Tooling System)	<b>B47</b>
<b>DNMG-VP2</b>	Turning Insert_Negative (Multi Lock/Lever Lock, HSK Tooling System)	<b>B47</b>
<b>DNMG-VP3</b>	Turning Insert_Negative (Multi Lock/Lever Lock, HSK Tooling System)	<b>B47</b>
<b>DNMG-VP4</b>	Turning Insert_Negative (Multi Lock/Lever Lock, HSK Tooling System)	<b>B48</b>
<b>DNMG-VQ</b>	Turning Insert_SAVE TURN	<b>B115</b>
<b>DNMG-VQ</b>	Turning Insert_Negative (Multi Lock/Lever Lock, HSK Tooling System)	<b>B45</b>
<b>DNMG-VR</b>	Turning Insert_Negative (Multi Lock/Lever Lock, HSK Tooling System)	<b>B46</b>
<b>DNMG-VW</b>	Turning Insert_Negative (Multi Lock/Lever Lock, HSK Tooling System)	<b>B48</b>
<b>DNMM</b>	PCD Insert_Negative/Positive	<b>B113</b>
<b>DNMX-SH</b>	Turning Insert_Negative (Multi Lock/Lever Lock, HSK Tooling System)	<b>B48</b>
<b>DNMX-SR</b>	Turning Insert_Negative	<b>B48</b>
<b>DSBNR/L</b>	Holder (Double clamp system)	<b>B168</b>
<b>DSDNN</b>	Holder (Double clamp system)	<b>B169</b>
<b>DSKNR/L</b>	Holder (Double clamp system)	<b>B169</b>
<b>DSKNR/L</b>	Boring Bar (Double clamp system)	<b>B208</b>
<b>DSSNR/L</b>	Holder (Double clamp system)	<b>B169</b>
<b>DTFNR/L</b>	Holder (Double clamp system)	<b>B170</b>
<b>DTFNR/L</b>	Boring Bar (Double clamp system)	<b>B209</b>
<b>DTGNR/L</b>	Holder (Double clamp system)	<b>B170</b>
<b>DVJNR/L</b>	Holder (Double clamp system)	<b>B170</b>
<b>DVVNN</b>	Holder (Double clamp system)	<b>B171</b>
<b>DWLNRL</b>	Holder (Double clamp system)	<b>B171</b>
<b>DWLNRL</b>	Boring Bar (Double clamp system)	<b>B209</b>

## E

<b>E2D</b>	Drill (KED Plus-2D)	<b>F29~30</b>
<b>E3D</b>	Drill (KED Plus-3D)	<b>F31~32</b>
<b>E4D</b>	Drill (KED Plus-4D)	<b>F33~34</b>
<b>E5D</b>	Drill (KED Plus-5D)	<b>F35~36</b>
<b>EF(M)4000</b>	Mill-max	<b>E51</b>
<b>EN(M)4000</b>	Mill-max	<b>E52</b>
<b>EPN(M)4000</b>	Mill-max	<b>E53</b>
<b>EPN(M)5000+</b>	Mill-max Plus	<b>E54</b>
<b>ER(L)</b>	Thread Insert	<b>D10~30</b>
<b>ER(L)H</b>	Thread External Holder (Screw on System)	<b>D31</b>
<b>ER(L)H-C</b>	Thread External Holder (Clamp on System)	<b>D31</b>
<b>ERM</b>	Thread Insert	<b>D10~19</b>
<b>EV2525R/L-105-3</b>	HSK Tooling System	<b>B236</b>
<b>EV2525R/L-112</b>	HSK Tooling System	<b>B236</b>
<b>EV2525R/L-115</b>	HSK Tooling System	<b>B236</b>

## F

<b>FGD</b>	MGT Insert	<b>C28</b>
<b>FGHH</b>	MGT Holder (Face Grooving)	<b>C37</b>
<b>FGM</b>	MGT Insert	<b>C28</b>
<b>FGVH</b>	MGT Holder (Face Grooving)	<b>C38</b>
<b>FMAC(M)3000</b>	Future Mill	<b>E216</b>
<b>FMAC(M)3000-A</b>	Future Mill (Aluminum body)	<b>E218</b>
<b>FMAC(M)4000</b>	Future Mill	<b>E217</b>
<b>FMAC(M)4000-A</b>	Future Mill (Aluminum body)	<b>E219</b>
<b>FMAS3000</b>	Future Mill	<b>E220</b>
<b>FMAS4000</b>	Future Mill	<b>E221</b>
<b>FMM</b>	MGT Insert	<b>C28</b>
<b>FMPC(M)3000</b>	Future Mill	<b>E222</b>
<b>FMPC(M)3000-A</b>	Future Mill (Aluminum body)	<b>E224</b>
<b>FMPC(M)4000</b>	Future Mill	<b>E223</b>
<b>FMPC(M)4000-A</b>	Future Mill (Aluminum body)	<b>E225</b>
<b>FMPS3000</b>	Future Mill	<b>E226</b>
<b>FMPS4000</b>	Future Mill	<b>E227</b>
<b>FMRC(M)3000</b>	Future Mill	<b>E228</b>
<b>FMRC(M)4000</b>	Future Mill	<b>E229</b>
<b>FMRC(M)4000</b>	Future Mill P-Positive	<b>E243</b>
<b>FMRC(M)5000</b>	Future Mill	<b>E230</b>
<b>FMRC(M)5000</b>	Future Mill P-Positive	<b>E244</b>
<b>FMRC(M)6000</b>	Future Mill	<b>E231</b>
<b>FMRC(M)6000</b>	Future Mill P-Positive	<b>E245</b>
<b>FMRCM3000</b>	Future Mill P-Positive	<b>E242</b>
<b>FMRM1000</b>	Future Mill	<b>E238</b>
<b>FMRM1500</b>	Future Mill	<b>E238</b>
<b>FMRM2000</b>	Future Mill	<b>E239</b>
<b>FMRM2500</b>	Future Mill	<b>E239</b>
<b>FMRM2500</b>	Future Mill P-Positive	<b>E250</b>
<b>FMRM3000</b>	Future Mill	<b>E240</b>
<b>FMRM3000</b>	Future Mill P-Positive	<b>E251</b>
<b>FMRM4000</b>	Future Mill	<b>E241</b>
<b>FMRM4000</b>	Future Mill P-Positive	<b>E252</b>
<b>FMRM5000</b>	Future Mill	<b>E241</b>
<b>FMRM5000</b>	Future Mill P-Positive	<b>E253</b>
<b>FMRS1000</b>	Future Mill	<b>E232</b>
<b>FMRS1500</b>	Future Mill	<b>E232</b>
<b>FMRS2000</b>	Future Mill	<b>E233</b>
<b>FMRS2500</b>	Future Mill	<b>E233</b>
<b>FMRS2500</b>	Future Mill P-Positive	<b>E246</b>
<b>FMRS3000</b>	Future Mill	<b>E234</b>
<b>FMRS3000</b>	Future Mill P-Positive	<b>E247</b>
<b>FMRS4000</b>	Future Mill	<b>E235</b>
<b>FMRS4000</b>	Future Mill P-Positive	<b>E248</b>



**F**

<b>FMRS5000</b>	Future Mill	<b>E236</b>
<b>FMRS5000</b>	Future Mill P-Positive	<b>E249</b>
<b>FMRS6000</b>	Future Mill	<b>E237</b>
<b>FMRS6000</b>	Future Mill P-Positive	<b>E249</b>
<b>FP Chip Breaker</b>	Turning Chip Breaker	<b>B17</b>
<b>FS Chip Breaker</b>	Turning Chip Breaker	<b>B18</b>

**G**

<b>GBE</b>	GBE (Single edge type)	<b>E332</b>
<b>GBEM</b>	GBE (Modular type)	<b>E334</b>
<b>GBE-M</b>	GBE (Multi edge type)	<b>E333</b>
<b>GFIP</b>	Multi functional holder (Grooving Tools)	<b>C71</b>
<b>GW</b>	Multi functional Insert (Grooving Tools)	<b>C71</b>

**H**

<b>HAVE</b>	HAVE (Multi Edge type)	<b>E339</b>
<b>HAVE</b>	HAVE (Single Edge type)	<b>E340</b>
<b>HDDCM7000</b>	Mill-max Heavy	<b>E58</b>
<b>HDDCM9000</b>	Mill-max Heavy	<b>E58</b>
<b>HECN</b>	Milling Insert (High feed Cutter)	<b>E08</b>
<b>HFMD(M)-LN10</b>	HFMD (Cutter)	<b>E273</b>
<b>HFMD(M)-LN06</b>	HFMD (Cutter)	<b>E272</b>
<b>HFMD(M)-LN04</b>	HFMD (Modular)	<b>E274</b>
<b>HFMD(M)-LN06</b>	HFMD (Modular)	<b>E275</b>
<b>HFMD(M)-LN10</b>	HFMD (Modular)	<b>E276</b>
<b>HFMD(S)-LN04</b>	HFMD (Shank)	<b>E267</b>
<b>HFMD(S)-LN06</b>	HFMD (Shank)	<b>E269</b>
<b>HFMD(S)-LN10</b>	HFMD (Shank)	<b>E271</b>
<b>HFMM</b>	HFMD (Modular)	<b>E283</b>
<b>HFMS1000</b>	HFMD (Shank)	<b>E281</b>
<b>HPEN</b>	Milling Insert (High feed Cutter)	<b>E08</b>
<b>HPEN-WC</b>	Milling Insert (High feed Cutter)	<b>E08</b>
<b>HRMC(M)13</b>	HRM	<b>E300</b>
<b>HRMC(M)15</b>	HRM	<b>E301</b>
<b>HRMDC(M)09</b>	HRMDouble	<b>E289</b>
<b>HRMDC(M)13</b>	HRMDouble	<b>E290</b>
<b>HRMDC(M)16</b>	HRMDouble	<b>E291</b>
<b>HRMDM 06</b>	HRMDouble	<b>E297</b>
<b>HRMDM 09</b>	HRMDouble	<b>E298</b>
<b>HRMDM 13</b>	HRMDouble	<b>E299</b>
<b>HRMDS06</b>	HRMDouble	<b>E292</b>
<b>HRMDS09</b>	HRMDouble	<b>E293</b>
<b>HRMDS13</b>	HRMDouble	<b>E295</b>

**H**

<b>HRMM08</b>	HRM	<b>E305</b>
<b>HRMM10</b>	HRM	<b>E306</b>
<b>HRMM13</b>	HRM	<b>E306</b>
<b>HRMS 08</b>	HRM	<b>E302</b>
<b>HRMS 10</b>	HRM	<b>E302</b>
<b>HRMS 13</b>	HRM	<b>E303</b>
<b>HRMS 15</b>	HRM	<b>E304</b>
<b>HSK100A</b>	Modular Adaptor (HSK)	<b>E404</b>
<b>HSK100A AM3000</b>	HSK Tooling System (Mono-Tool)	<b>E361</b>
<b>HSK100A AM4000</b>	HSK Tooling System (Mono-Tool)	<b>E362</b>
<b>HSK63A</b>	Modular Adaptor (HSK)	<b>E404</b>
<b>HSK63A AM1000</b>	HSK Tooling System (Mono-Tool)	<b>E358</b>
<b>HSK63A AM1000HS</b>	HSK Tooling System (Alpha Mill)	<b>E353</b>
<b>HSK63A AM1500</b>	HSK Tooling System (Mono-Tool)	<b>E359</b>
<b>HSK63A AM1500HS</b>	HSK Tooling System (Alpha Mill)	<b>E354</b>
<b>HSK63A AM2000</b>	HSK Tooling System (Mono-Tool)	<b>E360</b>
<b>HSK63A AM2000HS</b>	HSK Tooling System (Alpha Mill)	<b>E355</b>
<b>HSK63A AM3000HS</b>	HSK Tooling System (Alpha Mill)	<b>E356</b>
<b>HSK63A AM4000HS</b>	HSK Tooling System (Alpha Mill)	<b>E357</b>
<b>HSK63A/100A PAX5000</b>	Pro-X Mill	<b>E393</b>
<b>HSK-XD19</b>	HSK Tooling System (Mono-Tool)	<b>E363</b>

**I**

<b>IG</b>	Multi functional Insert (Grooving Tools)	<b>C70</b>
<b>IG</b>	Multi functional holder (Grooving Tools)	<b>C70</b>
<b>IR(L)</b>	Thread Insert	<b>D10~30</b>
<b>IR(L)H</b>	Thread External Holder (Screw on System)	<b>D32</b>
<b>IR(L)H-C</b>	Thread External Holder (Clamp on System)	<b>D32</b>
<b>IRB</b>	Indexable Reamer (Stuffed hole)	<b>F87</b>
<b>IRM</b>	Thread Insert	<b>D10~21</b>
<b>IRT</b>	Indexable Reamer (Throughout hole)	<b>F86</b>

**K**

<b>K2D</b>	KING DRILL-2D	<b>F11~12</b>
<b>K2D</b>	KING DRILL (for through coolant system with a lathe)-2D	<b>F21</b>
<b>K2D</b>	KING DRILL (for large diameter drilling)-2D	<b>F25</b>
<b>K3D</b>	KING DRILL-3D	<b>F13~15</b>
<b>K3D</b>	KING DRILL (for through coolant system with a lathe)-3D	<b>F22</b>
<b>K3D</b>	KING DRILL (for large diameter drilling)-3D	<b>F25</b>
<b>K3D*</b>	KING DRILL (for machining a tap foundation hole)-3D	<b>F13~14</b>
<b>K4D</b>	KING DRILL-4D	<b>F16~17</b>
<b>K4D</b>	KING DRILL (for through coolant system with a lathe)-4D	<b>F23</b>
<b>K4D</b>	KING DRILL (for large diameter drilling)-4D	<b>F25</b>





# K Index by designation

## K

<b>K5D</b>	KING DRILL-5D	<b>F18~19</b>
<b>KCER/L</b>	Multi functional (KGT Cartridge)	<b>C41</b>
<b>KCFR/L</b>	Multi functional (KGT Cartridge)	<b>C41</b>
<b>KEL-ANN</b>	Milling insert (Storm Mill)	<b>E08</b>
<b>KEL-MF</b>	Milling insert (Gear cutter)	<b>E08</b>
<b>KEL-QNN</b>	Milling insert (Storm Mill)	<b>E08</b>
<b>KGEHR/L</b>	Multi functional (KGT Holder)	<b>C15</b>
<b>KGEHR/L-D00A</b>	Multi functional (Auto Tool Holder)	<b>C17</b>
<b>KGEHR/L-D00B</b>	Multi functional (Auto Tool Holder)	<b>C17</b>
<b>KGEHR/L-DOOA</b>	Auto tools (KGT type)	<b>B143</b>
<b>KGEHR/L-DOOB</b>	Auto tools (KGT type)	<b>B143</b>
<b>KGEHR/L-T00</b>	Multi functional (KGT Holder)	<b>C18</b>
<b>KGEUR/L</b>	Multi functional (KGT Holder)	<b>C20</b>
<b>KGEVR/L-T00</b>	Multi functional (KGT Holder)	<b>C19</b>
<b>KGFHR/L</b>	Multi functional (KGT Holder)	<b>C22</b>
<b>KGFVR/L</b>	Multi functional (KGT Holder)	<b>C21</b>
<b>KGGN-A</b>	Multi functional Insert (KGT series)	<b>C14</b>
<b>KGGN-B</b>	Multi functional Insert (KGT series)	<b>C13</b>
<b>KGGN-R</b>	Multi functional Insert (KGT series)	<b>C14</b>
<b>KGIUR/L</b>	Multi functional (KGT Holder)	<b>C23</b>
<b>KGIVR/L</b>	Multi functional (KGT Holder)	<b>C24</b>
<b>KGMI-T</b>	Multi functional Insert (KGT series)	<b>C13</b>
<b>KGML-LP</b>	Auto tools Insert (KGT type)	<b>B144</b>
<b>KGML-LP</b>	Multi functional Insert (KGT series)	<b>C13</b>
<b>KGML-RP</b>	Auto tools Insert (KGT type)	<b>B144</b>
<b>KGML-RP</b>	Multi functional Insert (KGT series)	<b>C13</b>
<b>KGMN-C</b>	Auto tools Insert (KGT type)	<b>B144</b>
<b>KGMN-L</b>	Auto tools Insert (KGT type)	<b>B143</b>
<b>KGMN-L</b>	Multi functional Insert (KGT series)	<b>C12</b>
<b>KGMN-R</b>	Auto tools Insert (KGT type)	<b>B143</b>
<b>KGMN-R</b>	Multi functional Insert (KGT series)	<b>C12</b>
<b>KGMN-T</b>	Auto tools Insert (KGT type)	<b>B143</b>
<b>KGMN-T</b>	Multi functional Insert (KGT series)	<b>C12</b>
<b>KGMR-LP</b>	Auto tools Insert (KGT type)	<b>B144</b>
<b>KGMR-LP</b>	Multi functional Insert (KGT series)	<b>C13</b>
<b>KGMR-RP</b>	Auto tools Insert (KGT type)	<b>B144</b>
<b>KGMR-RP</b>	Multi functional Insert (KGT series)	<b>C13</b>
<b>KGTB</b>	KGT Blade for Parting off	<b>C25</b>
<b>KM-DCLNR/L</b>	KM Tooling System	<b>B240</b>
<b>KNB</b>	Multi functional Insert (K Notch, Metric)	<b>C57</b>
<b>KNG</b>	Multi functional Insert (K Notch, Metric)	<b>C57</b>
<b>KNG</b>	Multi functional Insert (K Notch, Inch)	<b>C58</b>
<b>KNGP</b>	Multi functional Insert (K Notch, Metric)	<b>C57</b>
<b>KNGP</b>	Multi functional Insert (K Notch, Inch)	<b>C58</b>
<b>KNR</b>	Multi functional Insert (K Notch, Inch)	<b>C58</b>

## K

<b>KNRP</b>	Multi functional Insert (K Notch, Inch)	<b>C58</b>
<b>KNSR</b>	Multi functional (K Notch Holder)	<b>C59</b>
<b>KNT</b>	Multi functional Insert (K Notch, Threading)	<b>C57</b>
<b>KNUX-11</b>	Turning Insert_Negative (Clamp on System)	<b>B49</b>
<b>KNUX-12</b>	Turning Insert_Negative (Clamp on System)	<b>B49</b>
<b>KRGN-A</b>	Multi functional Insert (KGT series)	<b>C14</b>
<b>KRMI-C</b>	Multi functional Insert (KGT series)	<b>C12</b>
<b>KRMN-C</b>	Auto tools Insert (KGT type)	<b>B144</b>
<b>KRMN-C</b>	Multi functional Insert (KGT series)	<b>C12</b>
<b>KSPB</b>	Multi functional (Saw Man-X, Blade)	<b>C65</b>
<b>KSPH</b>	Multi functional(Saw Man-X, Shank)	<b>C66</b>

## L

<b>LBE08/10/12/16/20/25/30/32</b>	Laser Mill (Carbide Shank-Ball, Straight type)	<b>E326</b>
<b>LBE08/10/12/16/20/25/30/32</b>	Laser Mill (Steel Shank-Ball, Taper type)	<b>E327</b>
<b>LBE12/16/20/25/30/32</b>	Laser Mill (Steel Shank-Ball, Straight type)	<b>E327</b>
<b>LBE-MHD</b>	Laser Mill (Modular type)	<b>E330</b>
<b>LBH</b>	Milling Insert (Laser Mill)	<b>E08</b>
<b>LBH-KF</b>	Milling Insert (Laser Mill)	<b>E08</b>
<b>LBH-KH</b>	Milling Insert (Laser Mill)	<b>E09</b>
<b>LBS</b>	Milling Insert (Laser Mill)	<b>E09</b>
<b>LCF</b>	Milling Insert (Laser Mill)	<b>E09</b>
<b>LDET</b>	Milling Insert (Pro-XL Mill)	<b>E09</b>
<b>LDET-MA</b>	Milling Insert (Pro-XL Mill)	<b>E10</b>
<b>LFH</b>	Milling Insert (Laser Mill)	<b>E09</b>
<b>LNCS</b>	Milling Insert (Rich Mill)	<b>E10</b>
<b>LNE</b>	Milling Insert (Gear cutter)	<b>E10</b>
<b>LNEX-MA</b>	Milling Insert (Rich Mill)	<b>E11</b>
<b>LNEX-MF</b>	Milling Insert (Rich Mill)	<b>E11</b>
<b>LNEX-MM</b>	Milling Insert (Rich Mill)	<b>E11</b>
<b>LNKT-MA</b>	Milling Insert (TP2P)	<b>E10</b>
<b>LNKT-ML</b>	Milling Insert (TP2P)	<b>E11</b>
<b>LNKT-MM</b>	Milling Insert (TP2P)	<b>E11</b>
<b>LNMX-MF</b>	Milling Insert (Rich Mill)	<b>E11</b>
<b>LNMX-MF</b>	Milling Insert (HFMD)	<b>E12</b>
<b>LNMX-ML</b>	Milling Insert (HFMD)	<b>E12</b>
<b>LNMX-MM</b>	Milling Insert (Rich Mill)	<b>E11</b>
<b>LNMX-MM</b>	Milling Insert (HFMD)	<b>E12</b>
<b>LP Chip Breaker</b>	Turning Chip Breaker	<b>B20</b>
<b>LPEW</b>	Milling Insert (HFM)	<b>E12</b>
<b>LPMT-MF</b>	Milling Insert (HFM)	<b>E12</b>
<b>LPMW</b>	Milling Insert (HFM)	<b>E13</b>
<b>LR</b>	Milling Insert (Laser Mill)	<b>E09</b>
<b>LRE10/12</b>	Laser Mill (Steel Shank-Corner R, Taper type)	<b>E329</b>





## L

<b>LRE10/12/16/20/25/30/32</b>	Laser Mill (Carbide Shank-Corner R, Straight type)	<b>E328</b>
<b>LRE12/16/25/30/32</b>	Laser Mill (Steel Shank-Corner R, Straight type)	<b>E329</b>
<b>LRH</b>	Milling Insert (Laser Mill)	<b>E09</b>
<b>LW Chip Breaker</b>	Turning Chip Breaker	<b>B32</b>
<b>LXET-MA</b>	Milling Insert (Pro-L Mill)	<b>E13</b>
<b>LXET-ML</b>	Milling Insert (Pro-L Mill)	<b>E13</b>

## M

<b>MAPD000HR/L-ZO</b>	Aero Mill-Mini	<b>E155</b>
<b>MAPDS000HR/L-ZO</b>	Aero Mill-Mini	<b>E154</b>
<b>MAT</b>	Modular Adaptor (Steel Shank)	<b>E401</b>
<b>MAT-C</b>	Modular Adaptor (Carbide Shank)	<b>E402</b>
<b>MBBR</b>	Auto tools (MSB Tools_Back Boring)	<b>B148</b>
<b>MBCR</b>	Auto tools (MSB Tools_Copying)	<b>B147</b>
<b>MBFR</b>	Auto tools ((MSB Tools_Chamfering)	<b>B148</b>
<b>MBR</b>	Auto tools ((MSB Tools_Boring)	<b>B147</b>
<b>MC</b>	Multi functional Insert (Bearing Solution)	<b>B156</b>
<b>MCER/L</b>	HSK Tooling System (Cartridge)	<b>B234</b>
<b>MCER/L</b>	KM Tooling System (Cartridge)	<b>B240</b>
<b>MCER/L</b>	Multi functional (MGT Cartridge)	<b>C42</b>
<b>MCFR/L</b>	HSK Tooling System (Cartridge)	<b>B235</b>
<b>MCFR/L</b>	Multi functional (MGT Cartridge)	<b>C42</b>
<b>MCHR/L</b>	HSK Tooling System	<b>B234</b>
<b>MCHR/L</b>	KM Tooling System (Cartridge)	<b>B239</b>
<b>MCHR/L</b>	Multi functional (MGT Cartridge Holder)	<b>C40</b>
<b>MCKNR/L</b>	Holder (Multi Lock System)	<b>B183</b>
<b>MCLNR/L</b>	Holder (Multi Lock System)	<b>B183</b>
<b>MCLNR/L</b>	Boring Bar (Multi Lock System)	<b>B213</b>
<b>MCMNN</b>	Holder (Multi Lock System)	<b>B183</b>
<b>MCRNR/L</b>	Holder (Multi Lock System)	<b>B184</b>
<b>MCVR/L</b>	Multi functional (MGT Cartridge Holder)	<b>C40</b>
<b>MDJNR/L</b>	Holder (Multi Lock System)	<b>B184</b>
<b>MDNNN</b>	Holder (Multi Lock System)	<b>B184</b>
<b>MDQNR/L</b>	Holder (Multi Lock System)	<b>B185</b>
<b>MDUNR/L</b>	Boring Bar (Multi Lock System)	<b>B213</b>
<b>MFMN</b>	Multi functional Insert (MGT Cartridge, MGT)	<b>C28</b>
<b>MGEHR/L</b>	Auto tools (MGT type)	<b>B144</b>
<b>MGEHR/L</b>	Multi functional (MGT Holder)	<b>C31</b>
<b>MGEHR/L</b>	Multi functional (MGT for Aluminum Wheel)	<b>C45</b>
<b>MGEHR/L-15</b>	Multi functional (MGT for Aluminum Wheel)	<b>C45</b>
<b>MGEUR/L</b>	Multi functional (MGT Holder)	<b>C32</b>
<b>MGEVR/L</b>	Multi functional (MGT Holder)	<b>C33</b>
<b>MGEXR/L</b>	Multi functional (MGT for Aluminum Wheel)	<b>C46</b>
<b>MGFHR/L</b>	Multi functional (MGT Holder)	<b>C36</b>

## M

<b>MGFR</b>	Auto tools (MSB Tools_Face Grooving)	<b>B150</b>
<b>MGFVR/L</b>	Multi functional (MGT Holder)	<b>C36</b>
<b>MGGN-A</b>	Multi functional Insert (MGT Cartridge, MGT)	<b>C29</b>
<b>MGGN-M</b>	Multi functional Insert (MGT Cartridge, MGT)	<b>C28</b>
<b>MGIUR/L</b>	Multi functional (MGT Holder)	<b>C34</b>
<b>MGIUR/L-MR</b>	Multi functional (MGT for Aluminum Wheel)	<b>C45</b>
<b>MGIUR/L-MV</b>	Multi functional (MGT for Aluminum Wheel)	<b>C46</b>
<b>MGIVR/L</b>	Multi functional (MGT Holder)	<b>C35</b>
<b>MGIXR/L-MR</b>	Multi functional (MGT for Aluminum Wheel)	<b>C46</b>
<b>MGML-PS</b>	Multi functional Insert (MGT Cartridge, MGT)	<b>C30</b>
<b>MGML-PT</b>	Multi functional Insert (MGT Cartridge, MGT)	<b>C30</b>
<b>MGMN-G</b>	Auto tools Insert (MGT type)	<b>B144</b>
<b>MGMN-G</b>	Multi functional Insert (MGT Cartridge, MGT)	<b>C28</b>
<b>MGMN-L</b>	Multi functional Insert (MGT Cartridge, MGT)	<b>C29</b>
<b>MGMN-M</b>	Auto tools Insert (MGT type)	<b>B144</b>
<b>MGMN-M</b>	Multi functional Insert (MGT Cartridge, MGT)	<b>C28</b>
<b>MGMN-R</b>	Multi functional Insert (MGT Cartridge, MGT)	<b>C29</b>
<b>MGMN-T</b>	Multi functional Insert (MGT Cartridge, MGT)	<b>C29</b>
<b>MGMR-PS</b>	Multi functional Insert (MGT Cartridge, MGT)	<b>C30</b>
<b>MGMR-PT</b>	Multi functional Insert (MGT Cartridge, MGT)	<b>C30</b>
<b>MGR</b>	Auto tools (MSB Tools_Square Grooving)	<b>B149</b>
<b>MGRR</b>	Auto tools (MSB Tools_Round Grooving)	<b>B150</b>
<b>MK Chip Breaker</b>	Turning Chip Breaker	<b>B24</b>
<b>MM Chip Breaker</b>	Turning Chip Breaker	<b>B22</b>
<b>MP Chip Breaker</b>	Turning Chip Breaker	<b>B21</b>
<b>MPMT</b>	Milling Insert	<b>E14</b>
<b>MRGN-A</b>	Multi functional Insert (MGT Cartridge, MGT)	<b>C30</b>
<b>MRGN-A</b>	Multi functional Insert (MGT for Aluminum Wheel)	<b>C44</b>
<b>MRMN-M</b>	Multi functional Insert (MGT Cartridge, MGT)	<b>C30</b>
<b>MS Chip Breaker</b>	Turning Chip Breaker	<b>B19</b>
<b>MSBNR/L</b>	Holder (Multi Lock System)	<b>B185</b>
<b>MSDNN</b>	Holder (Multi Lock System)	<b>B185</b>
<b>MSKNR/L</b>	Holder (Multi Lock System)	<b>B186</b>
<b>MSKNR/L</b>	Boring Bar (Multi Lock System)	<b>B213</b>
<b>MSRNR/L</b>	Holder (Multi Lock System)	<b>B186</b>
<b>MSSNR/L</b>	Holder (Multi Lock System)	<b>B187</b>
<b>MT</b>	Multi functional (Multi Turn)	<b>B154</b>
<b>MTENN</b>	Holder (Multi Lock System)	<b>B187</b>
<b>MTFNR/L</b>	Holder (Multi Lock System)	<b>B187</b>
<b>MTFNR/L</b>	Boring Bar (Multi Lock System)	<b>B214</b>
<b>MTGNR/L</b>	Holder (Multi Lock System)	<b>B188</b>
<b>MTJNR/L</b>	Holder (Multi Lock System)	<b>B188</b>
<b>MTR</b>	Auto tools (MSB Tools_Threading)	<b>B151</b>
<b>MVGN</b>	Multi functional Insert (MGT for Aluminum Wheel)	<b>C44</b>
<b>MVJNR/L</b>	Holder (Multi Lock System)	<b>B188</b>

# K Index by designation

## M

<b>MVQNR/L</b>	Holder (Multi Lock System)	<b>B189</b>
<b>MVUNR/L</b>	Boring Bar (Multi Lock System)	<b>B214</b>
<b>MVVNN</b>	Holder (Multi Lock System)	<b>B189</b>
<b>MWLNRL</b>	Holder (Multi Lock System)	<b>B189</b>
<b>MWLNRL</b>	Boring Bar (Multi Lock System)	<b>B214</b>

## N

<b>NFTFR/L</b>	Multi functional Insert ( Fine Tools)	<b>C69</b>
<b>NFTGR/L</b>	Multi functional Insert ( Fine Tools)	<b>C68</b>
<b>NFTIH</b>	Multi functional (Fine Tools Holder)	<b>C69</b>
<b>NFTTR/L</b>	Multi functional Insert ( Fine Tools)	<b>C68</b>
<b>NU-CCGW</b>	cBN Insert_Positive (Multi-Corner Type)	<b>B111</b>
<b>NU-CNGA</b>	cBN Insert_Negative (Multi-Corner Type)	<b>B110</b>
<b>NU-DCGW</b>	cBN Insert_Positive (Multi-Corner Type)	<b>B111</b>
<b>NU-DNGA</b>	cBN Insert_Negative (Multi-Corner Type)	<b>B110</b>
<b>NU-SNGA</b>	cBN Insert_Negative (Multi-Corner Type)	<b>B110</b>
<b>NU-TCGW</b>	cBN Insert_Positive (Multi-Corner Type)	<b>B111</b>
<b>NU-TNGA</b>	cBN Insert_Negative (Multi-Corner Type)	<b>B110</b>
<b>NU-TPGB</b>	cBN Insert_Positive (Multi-Corner Type)	<b>B111</b>
<b>NU-TPGN</b>	cBN Insert_Positive (Multi-Corner Type)	<b>B111</b>
<b>NU-TPGW</b>	cBN Insert_Positive (Multi-Corner Type)	<b>B111</b>
<b>NU-VBGW</b>	cBN Insert_Positive (Multi-Corner Type)	<b>B111</b>
<b>NU-VCGW</b>	cBN Insert_Positive (Multi-Corner Type)	<b>B111</b>
<b>NU-VNGA</b>	cBN Insert_Negative (Multi-Corner Type)	<b>B110</b>

## O

<b>OFCN</b>	Milling Insert (Double Mill)	<b>E14</b>
<b>OFCW</b>	Milling Insert (Double Mill)	<b>E14</b>
<b>OFKR-MA</b>	Milling Insert (Double Mill)	<b>E14</b>
<b>OFKR-MF</b>	Milling Insert (Double Mill)	<b>E14</b>
<b>OFKR-MM</b>	Milling Insert (Double Mill)	<b>E14</b>
<b>OFKT-MA</b>	Milling Insert (Double Mill)	<b>E14</b>
<b>OFKT-MF</b>	Milling Insert (Double Mill)	<b>E14</b>
<b>OFKT-MM</b>	Milling Insert (Double Mill)	<b>E15</b>
<b>ONHX-MA</b>	Milling Insert (Rich Mill)	<b>E15</b>
<b>ONHX-MF</b>	Milling Insert (Rich Mill)	<b>E15</b>
<b>ONHX-ML</b>	Milling Insert (Rich Mill)	<b>E15</b>
<b>ONHX-MM</b>	Milling Insert (Rich Mill)	<b>E15</b>
<b>ONHX-W</b>	Milling Insert (Rich Mill)	<b>E15</b>
<b>ONMX-MF</b>	Milling Insert (Rich Mill)	<b>E15</b>
<b>ONMX-MM</b>	Milling Insert (Rich Mill)	<b>E15</b>
<b>ORC</b>	O-ring Cutter	<b>E365</b>
<b>ORG</b>	Milling Insert (O-Ring Cutter)	<b>E15</b>

## P

<b>PAC(M)2000</b>	Pro-A Mill	<b>E385</b>
<b>PAC(M)4000</b>	Pro-A Mill	<b>E385</b>
<b>PALCM</b>	Pro-L Mill	<b>E394</b>
<b>PALS (Multi-edge)</b>	Pro-L Mill	<b>E397</b>
<b>PALS (Single-edge)</b>	Pro-L Mill	<b>E395</b>
<b>PAM2000</b>	Pro-A Mill	<b>E387</b>
<b>PAS2000</b>	Pro-A Mill	<b>E386</b>
<b>PAS4000</b>	Pro-A Mill	<b>E386</b>
<b>PAVCM-XD19</b>	Pro-V Mill	<b>E399</b>
<b>PAVS-XD19</b>	Pro-V Mill	<b>E400</b>
<b>PAXC(M)5000</b>	Pro-X Mill	<b>E388</b>
<b>PAXC(M)6000</b>	Pro-X Mill	<b>E389</b>
<b>PAXM5000</b>	Pro-X Mill	<b>E392</b>
<b>PAXS5000</b>	Pro-X Mill	<b>E390</b>
<b>PAXS6000</b>	Pro-X Mill	<b>E391</b>
<b>PBAC(M)5000</b>	Power Buster	<b>E68</b>
<b>PBPCM6000</b>	Power Buster	<b>E70</b>
<b>PBZC(M)5000</b>	Power Buster	<b>E69</b>
<b>PCBNR/L</b>	Holder (SAVE TURN)	<b>B116</b>
<b>PCBNR/L</b>	Holder (Lever Lock System)	<b>B172</b>
<b>PCKNR/L</b>	Holder (Lever Lock System)	<b>B172</b>
<b>PCLNR</b>	Holder (KHP)	<b>B202</b>
<b>PCLNR/L</b>	Holder (SAVE TURN)	<b>B116</b>
<b>PCLNR/L</b>	Boring Bar (SAVE TURN)	<b>B119</b>
<b>PCLNR/L</b>	Holder (Lever Lock System)	<b>B173</b>
<b>PCLNR/L</b>	Boring Bar (Lever Lock System)	<b>B210</b>
<b>PCLNR/L</b>	HSK Tooling System	<b>B232</b>
<b>PCLNR/L</b>	KM Tooling System	<b>B238</b>
<b>PCMNN</b>	HSK Tooling System	<b>B232</b>
<b>PCMNN</b>	KM Tooling System	<b>B238</b>
<b>PDF</b>	PCD Face Cutter	<b>E156</b>
<b>PDJNR</b>	Holder (KHP)	<b>B202</b>
<b>PDJNR/L</b>	Holder (SAVE TURN)	<b>B116</b>
<b>PDJNR/L</b>	Holder (Lever Lock System)	<b>B173</b>
<b>PDJNR/L</b>	HSK Tooling System	<b>B232</b>
<b>PDJNR/L</b>	KM Tooling System	<b>B239</b>
<b>PDNNN</b>	HSK Tooling System	<b>B232</b>
<b>PDNNN</b>	KM Tooling System	<b>B239</b>
<b>PDNNR/L</b>	Holder (SAVE TURN)	<b>B117</b>
<b>PDNNR/L</b>	Holder (Lever Lock System)	<b>B174</b>
<b>PDQNR/L</b>	Holder (SAVE TURN)	<b>B117</b>
<b>PDSNR/L</b>	Boring Bar (Lever Lock System)	<b>B210</b>
<b>PDUNR/L</b>	Boring Bar (SAVE TURN)	<b>B119</b>
<b>PDUNR/L</b>	Boring Bar (Lever Lock System)	<b>B210</b>
<b>PDZNR/L</b>	Boring Bar (SAVE TURN)	<b>B120</b>



**P**

<b>PES2000</b>	Turbo Mill	<b>E61</b>
<b>PES3000</b>	Turbo Mill	<b>E61</b>
<b>PES4000</b>	Turbo Mill	<b>E61</b>
<b>PF(M)4000</b>	Mill-max	<b>E55</b>
<b>PNEJ</b>	Milling Insert (Side Cutter)	<b>E16</b>
<b>PNEJ-C</b>	Milling Insert (Side Cutter)	<b>E16</b>
<b>PPN(M)4000</b>	Mill-max	<b>E56</b>
<b>PRDCN</b>	Holder (Lever Lock System)	<b>B174</b>
<b>PRDCN</b>	HSK Tooling System	<b>B233</b>
<b>PRGCR/L</b>	Holder (Lever Lock System)	<b>B175</b>
<b>PRGCR/L</b>	HSK Tooling System	<b>B233</b>
<b>PSBNR/L</b>	Holder (SAVE TURN)	<b>B117</b>
<b>PSBNR/L</b>	Holder (Lever Lock System)	<b>B175</b>
<b>PSDNN</b>	Holder (SAVE TURN)	<b>B118</b>
<b>PSDNN</b>	Holder (Lever Lock System)	<b>B176</b>
<b>PSKNR/L</b>	Holder (SAVE TURN)	<b>B118</b>
<b>PSKNR/L</b>	Boring Bar (SAVE TURN)	<b>B120</b>
<b>PSKNR/L</b>	Holder (Lever Lock System)	<b>B176</b>
<b>PSKNR/L</b>	Boring Bar (Lever Lock System)	<b>B211</b>
<b>PSSNR</b>	Holder (KHP)	<b>B202</b>
<b>PSSNR/L</b>	Holder (SAVE TURN)	<b>B118</b>
<b>PSSNR/L</b>	Holder (Lever Lock System)	<b>B177</b>
<b>PT</b>	Tap Series (Point Tap)	<b>D80</b>
<b>PTFNR/L</b>	Holder (Lever Lock System)	<b>B177</b>
<b>PTFNR/L</b>	Boring Bar (Lever Lock System)	<b>B211</b>
<b>PTGNR/L</b>	Holder (Lever Lock System)	<b>B178</b>
<b>PTTNR/L</b>	Holder (Lever Lock System)	<b>B178</b>
<b>PWLNR</b>	Holder (KHP)	<b>B203</b>
<b>PWLNR/L</b>	Holder (SAVE TURN)	<b>B119</b>
<b>PWLNR/L</b>	Boring Bar (SAVE TURN)	<b>B120</b>
<b>PWLNR/L</b>	Holder (Lever Lock System)	<b>B178</b>
<b>PWLNR/L</b>	Boring Bar (Lever Lock System)	<b>B211</b>
<b>PXL(S)</b>	Pro-XL Mill	<b>E398</b>

**Q**

<b>QCGT</b>	Multi functional Insert (Multi Turn)	<b>B154</b>
<b>QCMT</b>	Multi functional Insert (Multi Turn)	<b>B154</b>

**R**

<b>RAFCB</b>	Side Milling Cutter (Radial type-Full side cutter)	<b>E409</b>
<b>RAFCP</b>	Side Milling Cutter (Radial type-Full side cutter)	<b>E409</b>
<b>RAHCB</b>	Side Milling Cutter (Radial type-Half side cutter)	<b>E410</b>
<b>RAHCP</b>	Side Milling Cutter (Radial type-Half side cutter)	<b>E410</b>

**R**

<b>RC</b>	Milling Insert (BFE)	<b>E16</b>
<b>RCGT-AK</b>	Aluminum Insert_Positive (Screw on System)	<b>B105</b>
<b>RCGT-AR</b>	Aluminum Insert_Positive (Screw on System)	<b>B105</b>
<b>RCMT-VM</b>	Turning Insert_Positive (Screw on System)	<b>B83</b>
<b>RCMX</b>	Turning Insert_Positive (Screw on System)	<b>B83</b>
<b>RDCT-MA</b>	Milling Insert (Future Mill)	<b>E16</b>
<b>RDHW</b>	Milling Insert (Future Mill)	<b>E16</b>
<b>RDKT-MF</b>	Milling Insert (Future Mill)	<b>E17</b>
<b>RDKT-ML</b>	Milling Insert (Future Mill)	<b>E17</b>
<b>RDKT-MM</b>	Milling Insert (Future Mill)	<b>E17</b>
<b>RDKW</b>	Milling Insert (Future Mill)	<b>E17</b>
<b>REKR-MM</b>	Milling Insert (Double Mill)	<b>E17</b>
<b>RI</b>	Drill (Indexable Reamer Insert)	<b>F85</b>
<b>RK Chip Breaker</b>	Turning Chip Breaker	<b>B25</b>
<b>RM Chip Breaker</b>	Turning Chip Breaker	<b>B23</b>
<b>RM14XCM-XN06</b>	Rich Mill	<b>E142</b>
<b>RM16AC(M)6000</b>	Rich Mill	<b>E143</b>
<b>RM16AC(M)8000</b>	Rich Mill	<b>E144</b>
<b>RM3PC(M)3000</b>	Rich Mill	<b>E99</b>
<b>RM3PC(M)4000</b>	Rich Mill	<b>E100</b>
<b>RM3PC(M)5000</b>	Rich Mill	<b>E101</b>
<b>RM3PM3000</b>	Rich Mill	<b>E104</b>
<b>RM3PM4000</b>	Rich Mill	<b>E104</b>
<b>RM3PS3000</b>	Rich Mill	<b>E102</b>
<b>RM3PS4000</b>	Rich Mill	<b>E103</b>
<b>RM4PC(M)3000</b>	Rich Mill	<b>E105</b>
<b>RM4PC(M)4000</b>	Rich Mill	<b>E106</b>
<b>RM4PFCB3000</b>	Rich Mill	<b>E107</b>
<b>RM4PFCB4000</b>	Rich Mill	<b>E108</b>
<b>RM4PFCP3000</b>	Rich Mill	<b>E111</b>
<b>RM4PFCP4000</b>	Rich Mill	<b>E112</b>
<b>RM4PHCB3000</b>	Rich Mill	<b>E109</b>
<b>RM4PHCB4000</b>	Rich Mill	<b>E110</b>
<b>RM4PHCP3000</b>	Rich Mill	<b>E113</b>
<b>RM4PHCP4000</b>	Rich Mill	<b>E114</b>
<b>RM4PM3000</b>	Rich Mill	<b>E117</b>
<b>RM4PS3000</b>	Rich Mill	<b>E115</b>
<b>RM4PS4000</b>	Rich Mill	<b>E116</b>
<b>RM4ZC(M)3000</b>	Rich Mill	<b>E118</b>
<b>RM4ZC(M)4000</b>	Rich Mill	<b>E118</b>
<b>RM4ZM3000</b>	Rich Mill	<b>E119</b>
<b>RM4ZS3000</b>	Rich Mill	<b>E119</b>
<b>RM6PC(M)-WN08</b>	Rich Mill	<b>E121</b>
<b>RM6PCM-WN04</b>	Rich Mill	<b>E120</b>
<b>RM6PM-WN04</b>	Rich Mill	<b>E124</b>



# K Index by designation

## R

<b>RM6PM-WN08</b>	Rich Mill	<b>E125</b>
<b>RM6PS-WN04</b>	Rich Mill	<b>E122</b>
<b>RM6PS-WN08</b>	Rich Mill	<b>E123</b>
<b>RM8AC(M)4000</b>	Rich Mill	<b>E126</b>
<b>RM8AC(M)5000</b>	Rich Mill	<b>E128</b>
<b>RM8EC(M)4000</b>	Rich Mill	<b>E130</b>
<b>RM8EC(M)5000</b>	Rich Mill	<b>E132</b>
<b>RM8QC(M)4000</b>	Rich Mill	<b>E134</b>
<b>RMH8AC(M)4000</b>	Rich Mill	<b>E127</b>
<b>RMH8AC(M)5000</b>	Rich Mill	<b>E129</b>
<b>RMH8EC(M)4000</b>	Rich Mill	<b>E131</b>
<b>RMH8EC(M)5000</b>	Rich Mill	<b>E133</b>
<b>RMH8QC(M)4000</b>	Rich Mill	<b>E135</b>
<b>RMRC(M)-RN12</b>	Rich Mill	<b>E145</b>
<b>RMRS-RN12</b>	Rich Mill	<b>E146</b>
<b>RMT8A(M)4000</b>	Rich Mill	<b>E136</b>
<b>RMT8A(M)5000</b>	Rich Mill	<b>E137</b>
<b>RMT8E(M)4000</b>	Rich Mill	<b>E138</b>
<b>RMT8E(M)5000</b>	Rich Mill	<b>E139</b>
<b>RMT8Q(M)4000</b>	Rich Mill	<b>E140</b>
<b>RMX8AC(M)-SA14</b>	Rich Mill	<b>E141</b>
<b>RNMG-B25</b>	Turning Insert_Negative	<b>B49</b>
<b>RNMX-ML</b>	Milling Insert (Rich Mill)	<b>E17</b>
<b>RPCT-MA</b>	Milling Insert (Future Mill P-Positive)	<b>E17</b>
<b>RPET-ML</b>	Milling Insert (Future Mill P-Positive)	<b>E18</b>
<b>RPGT</b>	Multi functional Insert (Bearing Solution)	<b>B158</b>
<b>RPMT-MF</b>	Milling Insert (Future Mill P-Positive)	<b>E18</b>
<b>RPMT-MM</b>	Milling Insert (Future Mill P-Positive)	<b>E18</b>
<b>RPMW</b>	Milling Insert (Future Mill P-Positive)	<b>E18</b>
<b>RT</b>	Tap Series (Roll Tap)	<b>D77, 82</b>

## S

<b>SAGX-ML</b>	Milling Insert (Alpha Mill)	<b>E18</b>
<b>SAGX-MM</b>	Milling Insert (Alpha Mill)	<b>E18</b>
<b>SBBR/L</b>	Auto Tools Insert (Blade type)	<b>B137</b>
<b>SBCR/L</b>	Auto Tools Insert (Blade type)	<b>B138</b>
<b>SBGR/L</b>	Auto Tools Insert (Blade type)	<b>B137</b>
<b>SBHR/L</b>	Holder (Auto Tools_Blade type)	<b>B137</b>
<b>SBHR/L-X</b>	Holder (Auto Tools_Blade type)	<b>B137</b>
<b>SBR/L</b>	Auto Tools Insert (Multi utility type)	<b>B140</b>
<b>SBTR/L</b>	Auto Tools Insert (Blade type)	<b>B137</b>
<b>SCACR/L</b>	Holder (Auto Tools_ISO type)	<b>B123</b>
<b>SCACR/L</b>	Holder (Screw on System)	<b>B190</b>
<b>SCGT-AK</b>	Aluminum Insert_Positive (Screw on System)	<b>B106</b>

## S

<b>SCGT-AR</b>	Aluminum Insert_Positive (Screw on System)	<b>B106</b>
<b>SCKN</b>	Milling Insert (Mill Max Heavy)	<b>E19</b>
<b>SCLCR/L</b>	Holder (Auto Tools_ISO type)	<b>B123</b>
<b>SCLCR/L</b>	Holder (Auto Tools_KHP)	<b>B129</b>
<b>SCLCR/L</b>	Holder (Screw on System)	<b>B190</b>
<b>SCLCR/L</b>	Boring Bar (Screw on System)	<b>B215</b>
<b>SCLCR/L</b>	Compact Mini	<b>B225</b>
<b>SCLPR/L</b>	Boring Bar (Screw on System)	<b>B216</b>
<b>SCMT-C25</b>	Turning Insert_Positive (Screw on System)	<b>B84</b>
<b>SCMT-FP</b>	Turning Insert_Positive (Screw on System)	<b>B84</b>
<b>SCMT-HMP</b>	Turning Insert_Positive (Screw on System)	<b>B84</b>
<b>SCMT-MP</b>	Turning Insert_Positive (Screw on System)	<b>B84</b>
<b>SCMT-VF</b>	Turning Insert_Positive (Screw on System)	<b>B84</b>
<b>SCMT-VL</b>	Turning Insert_Positive (Screw on System)	<b>B84</b>
<b>SCR/L</b>	Auto Tools Insert (Multi utility type)	<b>B140</b>
<b>SDACR/L</b>	Holder (Screw on System)	<b>B190</b>
<b>SDCN</b>	Milling Insert (Mill-max, High feed Cutter)	<b>E19</b>
<b>SDET-MA</b>	Milling Insert (Future Mill)	<b>E19</b>
<b>SDET-MF</b>	Milling Insert (Future Mill)	<b>E19</b>
<b>SDET-MM</b>	Milling Insert (Future Mill)	<b>E19</b>
<b>SDJCR/L</b>	Holder (Auto Tools-ISO Type)	<b>B123</b>
<b>SDJCR/L</b>	Holder (Auto Tools-KHP)	<b>B129</b>
<b>SDJCR/L</b>	Holder (Screw on System)	<b>B191</b>
<b>SDKN-CM</b>	Milling Insert	<b>E19</b>
<b>SDKN-MU</b>	Milling Insert (Mill-Max)	<b>E20</b>
<b>SDKN-SU</b>	Milling Insert (Mill-max, Turbo Mill)	<b>E20</b>
<b>SDKR-MX</b>	Milling Insert (Mill-max, Turbo Mill)	<b>E20</b>
<b>SDMT-MM</b>	Milling Insert (Tank Mill, GBE)	<b>E20</b>
<b>SDNCN</b>	Holder (Auto Tools-ISO Type)	<b>B124</b>
<b>SDNCN</b>	Holder (Screw on System)	<b>B191</b>
<b>SDQCR/L</b>	Boring Bar (Screw on System)	<b>B217</b>
<b>SDUCR/L</b>	Boring Bar (Screw on System)	<b>B218</b>
<b>SDXT-MA</b>	Milling Insert (Future Mill)	<b>E20</b>
<b>SDXT-MF</b>	Milling Insert (Future Mill)	<b>E20</b>
<b>SDXT-MM</b>	Milling Insert (Future Mill)	<b>E20</b>
<b>SDZCR/L</b>	Boring Bar (Screw on System)	<b>B219</b>
<b>SECA</b>	Milling Insert	<b>E20</b>
<b>SECN</b>	Milling Insert (Mill-max)	<b>E21</b>
<b>SEET-MA</b>	Milling Insert (Future Mill)	<b>E21</b>
<b>SEET-MF</b>	Milling Insert (Future Mill)	<b>E21</b>
<b>SEET-MM</b>	Milling Insert (Future Mill)	<b>E21</b>
<b>SEEW</b>	Milling Insert (Future Mill)	<b>E21</b>
<b>SEEW-W</b>	Milling Insert (Future Mill)	<b>E21</b>
<b>SEKN-SU</b>	Milling Insert (Mill-max)	<b>E21</b>
<b>SEKR-MX</b>	Milling Insert (Mill-max)	<b>E22</b>



**S**

<b>SEM N</b>	Milling Insert	<b>E22</b>
<b>SEXT-MF</b>	Milling Insert (Future Mill)	<b>E22</b>
<b>SEXT-MM</b>	Milling Insert (Future Mill)	<b>E22</b>
<b>SEXT-MR</b>	Milling Insert (Future Mill)	<b>E22</b>
<b>SFCN</b>	Milling Insert (Mill-max)	<b>E22</b>
<b>SGBR/L</b>	Auto Tools Insert (Multi utility type)	<b>B141</b>
<b>SGR/L</b>	Auto Tools Insert (Multi utility type)	<b>B141</b>
<b>SH Chip Breaker</b>	Turning Chip Breaker	<b>B33</b>
<b>SL</b>	Sleeve	<b>B151</b>
<b>SMBB</b>	Multi functional(Saw Man_Block)	<b>C61</b>
<b>SMBB</b>	Multi functional(Saw Man-X_Block)	<b>C65</b>
<b>SNCF-MF</b>	Milling Insert (Rich Mill)	<b>E22</b>
<b>SNCF-MM</b>	Milling Insert (Rich Mill)	<b>E23</b>
<b>SNCN</b>	Milling Insert (Mill-max)	<b>E23</b>
<b>SNEF</b>	Milling Insert (High feed Cutter)	<b>E23</b>
<b>SNEU-MF</b>	Milling Insert (Shave Mill)	<b>E23</b>
<b>SNEU-TBW</b>	Milling Insert (Shave Mill)	<b>E24</b>
<b>SNEU-WMF</b>	Milling Insert (Shave Mill)	<b>E24</b>
<b>SNEW</b>	Milling Insert (Aero Mill-Mini)	<b>E24</b>
<b>SNEW-NAF</b>	Milling Insert (Aero Mill-Mini)	<b>E24</b>
<b>SNEW-XAF</b>	Milling Insert (Aero Mill-Mini)	<b>E24</b>
<b>SNEX</b>	Milling Insert (Cube Mill)	<b>E24</b>
<b>SNEX-CU1</b>	Milling Insert (Cube Mill)	<b>E24</b>
<b>SNEX-MA</b>	Milling Insert (Rich Mill)	<b>E24</b>
<b>SNEX-MF</b>	Milling Insert (Rich Mill)	<b>E25</b>
<b>SNEX-ML</b>	Milling Insert (Rich Mill)	<b>E24</b>
<b>SNEX-MM</b>	Milling Insert (Rich Mill)	<b>E25</b>
<b>SNEX-W</b>	Milling Insert (Rich Mill)	<b>E26</b>
<b>SNGA</b>	Turning Insert_Negative (Multi Lock/Lever Lock System)	<b>B54</b>
<b>SNGG</b>	Turning Insert_Negative (Multi Lock/Lever Lock System)	<b>B53</b>
<b>SNGG-VP3</b>	Turning Insert_Negative (Multi Lock/Lever Lock System)	<b>B55</b>
<b>SNGN</b>	Turning Insert_Negative (Lever Lock System/Ceramic Holder)	<b>B56</b>
<b>SNGX</b>	Turning Insert_Negative (Multi Lock/Lever Lock System)	<b>B57</b>
<b>SNHT-WX</b>	Milling Insert (Wind Mill)	<b>E25</b>
<b>SNKN</b>	Milling Insert (Mill-max)	<b>E25</b>
<b>SNMA</b>	Turning Insert_Negative (Multi Lock/Lever Lock System)	<b>B53</b>
<b>SNMF-MF</b>	Milling Insert (Rich Mill)	<b>E22</b>
<b>SNMF-MM</b>	Milling Insert (Rich Mill)	<b>E23</b>
<b>SNMG-B25</b>	Turning Insert_Negative (Multi Lock/Lever Lock System)	<b>B52</b>
<b>SNMG-CP</b>	Turning Insert_Negative (Multi Lock/Lever Lock System)	<b>B50</b>
<b>SNMG-GR</b>	Turning Insert_Negative (Multi Lock/Lever Lock System)	<b>B52</b>
<b>SNMG-HA</b>	Turning Insert_Negative (Multi Lock/Lever Lock System)	<b>B56</b>
<b>SNMG-HM</b>	Turning Insert_Negative	<b>B51</b>
<b>SNMG-LP</b>	Turning Insert_Negative (Multi Lock/Lever Lock System)	<b>B50</b>
<b>SNMG-MK</b>	Turning Insert_Negative (Multi Lock/Lever Lock System)	<b>B53</b>

**S**

<b>SNMG-MM</b>	Turning Insert (SAVE TURN)	<b>B115</b>
<b>SNMG-MM</b>	Turning Insert_Negative (Multi Lock/Lever Lock System)	<b>B54</b>
<b>SNMG-MP</b>	Turning Insert (SAVE TURN)	<b>B115</b>
<b>SNMG-MP</b>	Turning Insert_Negative (Multi Lock/Lever Lock System)	<b>B51</b>
<b>SNMG-RK</b>	Turning Insert_Negative (Multi Lock/Lever Lock System)	<b>B54</b>
<b>SNMG-RM</b>	Turning Insert_Negative (Multi Lock/Lever Lock System)	<b>B55</b>
<b>SNMG-VB</b>	Turning Insert_Negative (Multi Lock/Lever Lock System)	<b>B50</b>
<b>SNMG-VC</b>	Turning Insert_Negative (Multi Lock/Lever Lock System)	<b>B50</b>
<b>SNMG-VF</b>	Turning Insert_Negative (Multi Lock/Lever Lock System)	<b>B50</b>
<b>SNMG-VL</b>	Turning Insert_Negative (Multi Lock/Lever Lock System)	<b>B50</b>
<b>SNMG-VM</b>	Turning Insert_Negative (Multi Lock/Lever Lock System)	<b>B51</b>
<b>SNMG-VP2</b>	Turning Insert_Negative (Multi Lock/Lever Lock System)	<b>B55</b>
<b>SNMG-VP3</b>	Turning Insert_Negative (Multi Lock/Lever Lock System)	<b>B55</b>
<b>SNMG-VP4</b>	Turning Insert_Negative (Multi Lock/Lever Lock System)	<b>B55</b>
<b>SNMG-VQ</b>	Turning Insert (SAVE TURN)	<b>B115</b>
<b>SNMG-VQ</b>	Turning Insert_Negative (Multi Lock/Lever Lock System)	<b>B52</b>
<b>SNMG-VR</b>	Turning Insert_Negative (Multi Lock/Lever Lock System)	<b>B54</b>
<b>SNMM-GH</b>	Turning Insert_Negative (Multi Lock/Lever Lock System)	<b>B57</b>
<b>SNMM-GR</b>	Turning Insert_Negative (Multi Lock/Lever Lock System)	<b>B57</b>
<b>SNMM-VH</b>	Turning Insert_Negative (Lever Lock System)	<b>B57</b>
<b>SNMM-VT</b>	Turning Insert_Negative (Lever Lock System)	<b>B57</b>
<b>SNMX</b>	Turning Insert_Negative (Ceramic Holder)	<b>B56</b>
<b>SNMX-MF</b>	Milling Insert (Rich Mill)	<b>E25</b>
<b>SNMX-MM</b>	Milling Insert (Alpha Mill)	<b>E18</b>
<b>SNMX-MM</b>	Milling Insert (Rich Mill)	<b>E25</b>
<b>SNUN</b>	Turning Insert_Negative (Ceramic Holder)	<b>B56</b>
<b>SP</b>	Multi functional Insert (Saw Man)	<b>C60</b>
<b>SP</b>	Tap series (Spiral Tap)	<b>D76, 81</b>
<b>SPB</b>	Multi functional (Saw Man_Blades)	<b>C61</b>
<b>SPB(M)</b>	Side Cutter	<b>E412</b>
<b>SPB-S</b>	Multi functional (Saw Man_Blades)	<b>C61</b>
<b>SPCN</b>	Milling Insert (Mill-max)	<b>E26</b>
<b>SPEN-WC</b>	Milling Insert (High feed Cutter)	<b>E26</b>
<b>SPET-ND</b>	Drill Insert (KING DRILL)	<b>F03</b>
<b>SPEX</b>	Milling Insert (Mill-max)	<b>E26</b>
<b>SPFN</b>	Milling Insert (Side Cutter)	<b>E26</b>
<b>SPGA</b>	Turning Insert_Positive	<b>B86</b>
<b>SPGH</b>	Multi functional Insert (Bearing Solution)	<b>B158</b>
<b>SPGN</b>	PCD Insert_Positive	<b>B113</b>
<b>SPGN</b>	Turning Insert_Positive	<b>B86</b>
<b>SPGR</b>	Multi functional Insert (Bearing Solution)	<b>B158</b>
<b>SPGR-F</b>	Turning Insert_Positive (Clamp on System)	<b>B85</b>
<b>SPGR-M</b>	Turning Insert_Positive (Clamp on System)	<b>B85</b>
<b>SPGT</b>	Turning Insert_Positive (Screw on System)	<b>B86</b>
<b>SPH</b>	Multi functional (Saw Man_Holder)	<b>C62</b>





# K Index by designation

## S

<b>SPH-S</b>	Multi functional (Saw Man_Holder)	<b>C62</b>
<b>SPKN-MU</b>	Milling Insert (Mill-max)	<b>E27</b>
<b>SPKN-SU</b>	Milling Insert (Mill-max)	<b>E27</b>
<b>SPKR-MX</b>	Milling Insert (Mill-max)	<b>E27</b>
<b>SPMN</b>	Milling Insert (Chamfer tools)	<b>E27</b>
<b>SPMR-F</b>	Turning Insert_Positive (Clamp on System)	<b>B85</b>
<b>SPMR-M</b>	Turning Insert_Positive (Clamp on System)	<b>B85</b>
<b>SPMT</b>	Milling Insert (Tank Mill, GBE, BT Tooling System)	<b>E27</b>
<b>SPMT-KC</b>	Milling Insert (Chamfer tools)	<b>E27</b>
<b>SPMT-LD</b>	Drill Insert (KING DRILL)	<b>F03</b>
<b>SPMT-MM</b>	Milling Insert (Tank Mill, GBE)	<b>E27</b>
<b>SPMT-PD</b>	Drill Insert (KING DRILL)	<b>F03</b>
<b>SPMT-VF</b>	Turning Insert_Positive (Clamp on System)	<b>B85</b>
<b>SPMT-VL</b>	Turning Insert_Positive	<b>B85</b>
<b>SPP(M)</b>	Side Cutter	<b>E411</b>
<b>SPS</b>	Side Cutter	<b>E413</b>
<b>SPUN</b>	Turning Insert_Positive	<b>B85</b>
<b>SR</b>	Tap series (Spiral Roll Tap)	<b>D78, 83</b>
<b>SR Chip Breaker</b>	Turning Chip Breaker	<b>B33</b>
<b>SRCPR/L...B</b>	Bearing Solution	<b>B157</b>
<b>SRDCN</b>	Holder (Screw on System)	<b>B191</b>
<b>SRGCR</b>	Holder (KHP)	<b>B203</b>
<b>SRGCR/L</b>	Holder (Screw on System)	<b>B192</b>
<b>SRGPR/L...E</b>	Bearing Solution	<b>B157</b>
<b>SRGPR/L...F</b>	Bearing Solution	<b>B157</b>
<b>SSBCR/L</b>	Holder (Screw on System)	<b>B192</b>
<b>SSDCN</b>	Holder (Screw on System)	<b>B192</b>
<b>SSKCR/L</b>	Holder (Screw on System)	<b>B193</b>
<b>SSKCR/L</b>	Boring Bar (Screw on System)	<b>B219</b>
<b>SSKCR/L</b>	Cartridge (Screw on System)	<b>B245</b>
<b>SSKPR/L</b>	Boring Bar (Screw on System)	<b>B219</b>
<b>SSKPR/L...B</b>	Bearing Solution	<b>B158</b>
<b>SSSCR/L</b>	Holder (Screw on System)	<b>B193</b>
<b>SSSCR/L</b>	Cartridge (Screw on System)	<b>B246</b>
<b>ST</b>	Tap series (Straight Tap)	<b>D75, 79</b>
<b>STACR/L</b>	Holder (Auto Tools-ISO Type)	<b>B124</b>
<b>STACR/L</b>	Holder (Screw on System)	<b>B193</b>
<b>STFCR/L</b>	Holder (Screw on System)	<b>B194</b>
<b>STFCR/L</b>	Boring Bar (Screw on System)	<b>B220</b>
<b>STFCR/L</b>	Cartridge (Screw on System)	<b>B246</b>
<b>STFPR/L</b>	Boring Bar (Screw on System)	<b>B221</b>
<b>STGCR/L</b>	Holder (Screw on System)	<b>B194</b>
<b>STLBR/L</b>	Compact Mini	<b>B225</b>
<b>STMD1T</b>	Solid Threading Endmills (ISO Metric)	<b>D64, 68</b>
<b>STMD2L</b>	Solid Threading Endmills (ISO Metric / UN)	<b>D69~70</b>

## S

<b>STMD3T</b>	Solid Threading Endmills (ISO Metric / UN)	<b>D65~67</b>
<b>STMH</b>	Solid Threading Endmills (ISO Metric)	<b>D57~60</b>
<b>STMHC</b>	Solid Threading Endmills (ISO Metric)	<b>D51~56</b>
<b>STMS</b>	Solid Threading Endmills (ISO Metric)	<b>D61~63</b>
<b>STR/L</b>	Auto Tools Insert (Multi utility type)	<b>B141</b>
<b>STTCR/L</b>	Holder (Screw on System)	<b>B194</b>
<b>STTCR/L</b>	Cartridge (Screw on System)	<b>B247</b>
<b>STUBR/L</b>	Compact Mini	<b>B225</b>
<b>STUPR/L</b>	Compact Mini	<b>B226</b>
<b>STWCR/L</b>	Cartridge (Screw on System)	<b>B247</b>
<b>STWPR/L</b>	Boring Bar (Screw on System)	<b>B222</b>
<b>SVABR/L</b>	Holder (Screw on System)	<b>B195</b>
<b>SVACR/L</b>	Holder (Auto Tools-ISO Type)	<b>B124</b>
<b>SVAPR/L</b>	Holder (Auto Tools-ISO Type)	<b>B125</b>
<b>SVHBR/L</b>	Holder (Screw on System)	<b>B195</b>
<b>SVJBR</b>	Holder (KHP)	<b>B203</b>
<b>SVJBR/L</b>	Holder (Auto Tools-ISO Type)	<b>B125</b>
<b>SVJBR/L</b>	Holder (Screw on System)	<b>B195</b>
<b>SVJCR/L</b>	Holder (Auto Tools-ISO Type)	<b>B125</b>
<b>SVJCR/L</b>	Holder (Auto Tools-KHP)	<b>B129</b>
<b>SVJCR/L</b>	Holder (Screw on System)	<b>B196</b>
<b>SVJCR/L</b>	Boring Bar (Screw on System)	<b>B222</b>
<b>SVJPR/L</b>	Holder (Auto Tools-ISO Type)	<b>B126</b>
<b>SVPBR/L</b>	HSK Tooling System	<b>B233</b>
<b>SVQBR/L</b>	Boring Bar (Screw on System)	<b>B222</b>
<b>SVQCR/L</b>	Boring Bar (Screw on System)	<b>B223</b>
<b>SVUBR/L</b>	Boring Bar (Screw on System)	<b>B223</b>
<b>SVUCR/L</b>	Boring Bar (Screw on System)	<b>B223</b>
<b>SVVBN</b>	Holder (Screw on System)	<b>B196</b>
<b>SVVBN</b>	HSK Tooling System	<b>B233</b>
<b>SVVCN</b>	Holder (Screw on System)	<b>B196</b>
<b>SVVPN</b>	Holder (Auto Tools-ISO Type)	<b>B126</b>
<b>SWLCR/L</b>	Boring Bar (Screw on System)	<b>B224</b>
<b>SWUBR/L</b>	Compact Mini	<b>B227</b>
<b>SXGNR/L</b>	Holder (Auto Tools_Multi utility type)	<b>B140</b>

## T

<b>TAFCB</b>	Side Milling Cutter (Tangential type-Full side cutter)	<b>E407</b>
<b>TAFCP</b>	Side Milling Cutter (Tangential type-Full side cutter)	<b>E407</b>
<b>TAHCB</b>	Side Milling Cutter (Tangential type-Half side cutter)	<b>E408</b>
<b>TAHCP</b>	Side Milling Cutter (Tangential type-Half side cutter)	<b>E408</b>
<b>TB</b>	Multi functional Insert (Grooving Tools)	<b>C51</b>
<b>TBGT</b>	Turning Insert_Positive (Compact Mini)	<b>B87</b>
<b>TBH</b>	Multi functional (Grooving Tools)	<b>C54</b>



**T**

<b>TB-M</b>	Multi functional Insert (Grooving Tools)	<b>C52</b>
<b>TBMT-VL</b>	Turning Insert_Positive (Screw on System)	<b>B87</b>
<b>TB-P</b>	Multi functional Insert (Grooving Tools)	<b>C53</b>
<b>TCGT-AK</b>	Aluminum Insert_Positive (Screw on System)	<b>B107</b>
<b>TCGT-AR</b>	Aluminum Insert_Positive (Screw on System)	<b>B107</b>
<b>TCGT-FS</b>	Auto tools Insert (ISO type)	<b>B133</b>
<b>TCGT-FS</b>	Turning Insert_Positive (Screw on System)	<b>B89</b>
<b>TCGT-KF</b>	Auto tools Insert (ISO type)	<b>B133</b>
<b>TCGT-KF</b>	Turning Insert_Positive (Screw on System)	<b>B89</b>
<b>TCGT-VP1</b>	Turning Insert_Positive (Screw on System)	<b>B89</b>
<b>TCMT-C25</b>	Turning Insert_Positive (Screw on System)	<b>B89</b>
<b>TCMT-FP</b>	Turning Insert_Positive (Screw on System)	<b>B88</b>
<b>TCMT-HMP</b>	Turning Insert_Positive (Screw on System)	<b>B88</b>
<b>TCMT-MP</b>	Turning Insert_Positive (Screw on System)	<b>B88</b>
<b>TCMT-VF</b>	Turning Insert_Positive (Screw on System)	<b>B88</b>
<b>TCMT-VL</b>	Turning Insert_Positive (Screw on System)	<b>B88</b>
<b>TCMT-VP1</b>	Turning Insert_Positive (Screw on System)	<b>B89</b>
<b>T-CNMA</b>	cBN Insert_Negative(Regrinding)	<b>B112</b>
<b>T-DCGW</b>	cBN Insert_Positive(Regrinding)	<b>B112</b>
<b>TEC(E)N</b>	Milling Insert (Turbo Mill)	<b>E27</b>
<b>TEEN</b>	Milling Insert (Turbo Mill)	<b>E27</b>
<b>TFCN</b>	Milling Insert (Mill-max)	<b>E28</b>
<b>TFE</b>	T-Cutter	<b>E374</b>
<b>THE</b>	Tank Mill	<b>E307</b>
<b>TM</b>	Thread Milling Inserts (ISO Metric)	<b>D44~49</b>
<b>TNGA</b>	Turning Insert_Negative (Lever Lock/Wedge Clamp/Multi Lock System)	<b>B62</b>
<b>TNGG</b>	Turning Insert_Negative (Lever Lock/Wedge Clamp/Multi Lock System)	<b>B61</b>
<b>TNGG-SC</b>	Turning Insert_Negative (Lever Lock/Wedge Clamp/Multi Lock System)	<b>B60</b>
<b>TNGG-VP3</b>	Turning Insert_Negative (Lever Lock/Wedge Clamp/Multi Lock System)	<b>B63</b>
<b>TNGN</b>	Turning Insert_Negative (Ceramic Holder)	<b>B64</b>
<b>TNKT-ML</b>	Milling Insert (Triple Mill)	<b>E28</b>
<b>TNKT-MM</b>	Milling Insert (Triple Mill)	<b>E28</b>
<b>TNMA</b>	cBN Insert_Negative(Regrinding)	<b>B112</b>
<b>TNMA</b>	Turning Insert_Negative (Lever Lock/Wedge Clamp/Multi Lock System)	<b>B61</b>
<b>TNMG-B25</b>	Turning Insert_Negative (Lever Lock/Wedge Clamp/Multi Lock System)	<b>B60</b>
<b>TNMG-CP</b>	Turning Insert_Negative (Lever Lock/Wedge Clamp/Multi Lock System)	<b>B58</b>
<b>TNMG-GR</b>	Turning Insert_Negative (Lever Lock/Wedge Clamp/Multi Lock System)	<b>B60</b>
<b>TNMG-HA</b>	Turning Insert_Negative (Lever Lock/Wedge Clamp/Multi Lock System)	<b>B63</b>
<b>TNMG-HM</b>	Turning Insert_Negative	<b>B59</b>
<b>TNMG-LP</b>	Turning Insert_Negative (Lever Lock/Wedge Clamp/Multi Lock System)	<b>B58</b>
<b>TNMG-LW</b>	Turning Insert_Negative (Lever Lock/Wedge Clamp/Multi Lock System)	<b>B64</b>
<b>TNMG-MK</b>	Turning Insert_Negative (Lever Lock/Wedge Clamp/Multi Lock System)	<b>B61</b>
<b>TNMG-MM</b>	Turning Insert_Negative (Lever Lock/Wedge Clamp/Multi Lock System)	<b>B62</b>
<b>TNMG-MP</b>	Turning Insert_Negative (Lever Lock/Wedge Clamp/Multi Lock System)	<b>B59</b>
<b>TNMG-RK</b>	Turning Insert_Negative (Lever Lock/Wedge Clamp/Multi Lock System)	<b>B62</b>

**T**

<b>TNMG-RM</b>	Turning Insert_Negative (Lever Lock/Wedge Clamp/Multi Lock System)	<b>B63</b>
<b>TNMG-VB</b>	Turning Insert_Negative (Lever Lock/Wedge Clamp/Multi Lock System)	<b>B58</b>
<b>TNMG-VC</b>	Turning Insert_Negative (Lever Lock/Wedge Clamp/Multi Lock System)	<b>B59</b>
<b>TNMG-VF</b>	Turning Insert_Negative (Lever Lock/Wedge Clamp/Multi Lock System)	<b>B58</b>
<b>TNMG-VL</b>	Turning Insert_Negative (Lever Lock/Wedge Clamp/Multi Lock System)	<b>B58</b>
<b>TNMG-VM</b>	Turning Insert_Negative (Lever Lock/Wedge Clamp/Multi Lock System)	<b>B59</b>
<b>TNMG-VP2</b>	Turning Insert_Negative (Lever Lock/Wedge Clamp/Multi Lock System)	<b>B63</b>
<b>TNMG-VP3</b>	Turning Insert_Negative (Lever Lock/Wedge Clamp/Multi Lock System)	<b>B63</b>
<b>TNMG-VP4</b>	Turning Insert_Negative (Lever Lock/Wedge Clamp/Multi Lock System)	<b>B63</b>
<b>TNMG-VQ</b>	Turning Insert_Negative (Lever Lock/Wedge Clamp/Multi Lock System)	<b>B60</b>
<b>TNMG-VR</b>	Turning Insert_Negative (Lever Lock/Wedge Clamp/Multi Lock System)	<b>B62</b>
<b>TNMG-VW</b>	Turning Insert_Negative (Lever Lock/Wedge Clamp/Multi Lock System)	<b>B64</b>
<b>TNMM-GH</b>	Turning Insert_Negative (Lever Lock/Wedge Clamp/Multi Lock System)	<b>B65</b>
<b>TNMM-GR</b>	Turning Insert_Negative (Lever Lock/Wedge Clamp/Multi Lock System)	<b>B65</b>
<b>TNMX</b>	Turning Insert_Negative (Lever Lock/Wedge Clamp/Multi Lock System)	<b>B65</b>
<b>TNMX-NM</b>	Milling Insert (Power Buster)	<b>E28</b>
<b>TNMX-SH</b>	Turning Insert_Negative (Lever Lock/Wedge Clamp/Multi Lock System)	<b>B64</b>
<b>TNMX-SR</b>	Turning Insert_Negative	<b>B64</b>
<b>TOEH</b>	Turning Insert_Positive	<b>B90</b>
<b>TP2PCM-LN08</b>	TP2P	<b>E311</b>
<b>TP2PCM-LN14</b>	TP2P	<b>E312</b>
<b>TP2PCM-LN17</b>	TP2P	<b>E313</b>
<b>TP2PS-LN08</b>	TP2P	<b>E314</b>
<b>TP2PS-LN14</b>	TP2P	<b>E315</b>
<b>TP2PS-LN17</b>	TP2P	<b>E316</b>
<b>TPCN</b>	Milling Insert (Mill-max, Side cutter)	<b>E28</b>
<b>TPD</b>	Drill Insert (TPDC Plus Drill)	<b>F47~49</b>
<b>TPD</b>	Drill Insert (TPDB Plus Drill)	<b>F57</b>
<b>TPD</b>	Drill Insert (TPDB-F)	<b>F66</b>
<b>TPD</b>	Drill Insert (TPDB-H)	<b>F71</b>
<b>TPDB-F(1.5D)</b>	Drill (TPDB-F)	<b>F67</b>
<b>TPDB-H(3D)</b>	Drill (TPDB-H)	<b>F72</b>
<b>TPDB-H(4D)</b>	Drill (TPDB-H)	<b>F73</b>
<b>TPDB-H(8D)</b>	Drill (TPDB-H)	<b>F74</b>
<b>TPDB-P(10D)</b>	Drill (TPDB Plus)	<b>F61</b>
<b>TPDB-P(12D)</b>	Drill (TPDB Plus)	<b>F62</b>
<b>TPDB-P(3D)</b>	Drill (TPDB Plus)	<b>F58</b>
<b>TPDB-P(5D)</b>	Drill (TPDB Plus)	<b>F59</b>
<b>TPDB-P(8D)</b>	Drill (TPDB Plus)	<b>F60</b>
<b>TPDC(1.5D)</b>	Drill (TPDC Plus)	<b>F51</b>
<b>TPDC(10D)</b>	Drill (TPDC Plus)	<b>F53</b>
<b>TPDC(12D)</b>	Drill (TPDC Plus)	<b>F53</b>
<b>TPDC(3D)</b>	Drill (TPDC Plus)	<b>F51</b>
<b>TPDC(5D)</b>	Drill (TPDC Plus)	<b>F52</b>
<b>TPDC(8D)</b>	Drill (TPDC Plus)	<b>F52</b>





# K Index by designation

## T

<b>TPDX(3D)</b>	Drill (TPDC Plus)	<b>F50</b>
<b>TPDX(5D)</b>	Drill (TPDC Plus)	<b>F50</b>
<b>TPDX(8D)</b>	Drill (TPDC Plus)	<b>F50</b>
<b>TPGB</b>	cBN Insert_Positive (Regrinding)	<b>B112</b>
<b>TPGH</b>	Turning Insert_Positive	<b>B93</b>
<b>TPGN</b>	PCD Insert_Positive	<b>B113</b>
<b>TPGN</b>	Turning Insert_Positive	<b>B92</b>
<b>TPGR-F</b>	Turning Insert_Positive (Clamp on System)	<b>B91</b>
<b>TPGR-M</b>	Turning Insert_Positive (Clamp on System)	<b>B92</b>
<b>TPGT</b>	Turning Insert_Positive (Screw on System)	<b>B93</b>
<b>TPGW</b>	PCD Insert_Positive	<b>B113</b>
<b>TPGX</b>	Turning Insert_Positive (Screw on System)	<b>B93</b>
<b>TPKN-MU</b>	Milling Insert (Mill-max)	<b>E29</b>
<b>TPKN-SU</b>	Milling Insert (Mill-max)	<b>E29</b>
<b>TPKR-MX</b>	Milling Insert (Mill-max)	<b>E29</b>
<b>TPMCM-TN16</b>	Triple Mill	<b>E258</b>
<b>TPMCM-TN20</b>	Triple Mill	<b>E259</b>
<b>TPMR-F</b>	Turning Insert_Positive (Clamp on System)	<b>B91</b>
<b>TPMR-M</b>	Turning Insert_Positive (Clamp on System)	<b>B91</b>
<b>TPMS-TN11</b>	Triple Mill	<b>E260</b>
<b>TPMS-TN16</b>	Triple Mill	<b>E261</b>
<b>TPMT-FP</b>	Turning Insert_Positive (Screw on System)	<b>B90</b>
<b>TPMT-MP</b>	Turning Insert_Positive (Screw on System)	<b>B91</b>
<b>TPMT-VF</b>	Turning Insert_Positive (Screw on System)	<b>B91</b>
<b>TPMT-VL</b>	Turning Insert_Positive (Screw on System)	<b>B91</b>
<b>TPUN</b>	Turning Insert_Positive	<b>B92</b>
<b>T-TPGB</b>	cBN Insert_Negative (Regrinding)	<b>B112</b>
<b>T-VNMA</b>	cBN Insert_Negative (Regrinding)	<b>B112</b>
<b>TWX-KC</b>	Milling Insert (Multi functional Chamfer Tool)	<b>E29</b>

## U

<b>UNJ (Unified Constant Thread)</b>	Thread Insert	<b>D26</b>
--------------------------------------	---------------	------------

## V

<b>VB Chip Breaker</b>	Turning Chip Breaker	<b>B29</b>
<b>VBGT</b>	Aluminum Insert_Positive (Screw on System)	<b>B95</b>
<b>VBGT-AK</b>	Aluminum Insert_Positive (Screw on System)	<b>B108</b>
<b>VBGT-AR</b>	Turning Insert_Positive (Screw on System)	<b>B108</b>
<b>VBGT-FS</b>	Auto tools Insert (ISO type)	<b>B133</b>
<b>VBGT-FS</b>	Turning Insert_Positive (Screw on System)	<b>B95</b>
<b>VBGT-KF</b>	Auto tools Insert (ISO type)	<b>B133</b>
<b>VBGT-KF</b>	Turning Insert_Positive (Screw on System)	<b>B96</b>
<b>VBGT-KM</b>	Auto tools Insert (ISO type)	<b>B133</b>

## V

<b>VBGT-KM</b>	Turning Insert_Positive (Screw on System)	<b>B96</b>
<b>VBGT-VP1</b>	Turning Insert_Positive (Screw on System)	<b>B95</b>
<b>VBGW</b>	PCD Insert_Positive	<b>B113</b>
<b>VBMT</b>	PCD Insert_Positive	<b>B113</b>
<b>VBMT</b>	Turning Insert_Positive (Screw on System)	<b>B95</b>
<b>VBMT-FP</b>	Turning Insert_Positive (Screw on System)	<b>B94</b>
<b>VBMT-HMP</b>	Turning Insert_Positive (Screw on System)	<b>B94</b>
<b>VBMT-MP</b>	Turning Insert_Positive (Screw on System)	<b>B94</b>
<b>VBMT-VB</b>	Turning Insert_Positive (Screw on System)	<b>B94</b>
<b>VBMT-VF</b>	Turning Insert_Positive (Screw on System)	<b>B94</b>
<b>VBMT-VL</b>	Turning Insert_Positive (Screw on System)	<b>B94</b>
<b>VBMT-VP1</b>	Turning Insert_Positive (Screw on System)	<b>B95</b>
<b>VBMW</b>	cBN Insert_Positive (Regrinding)	<b>B112</b>
<b>VC Chip Breaker</b>	Turning Chip Breaker	<b>B30</b>
<b>VCET-KF</b>	Auto Tools Insert (ISO type)	<b>B134</b>
<b>VCET-KF</b>	Turning Insert_Positive (Screw on System)	<b>B99</b>
<b>VCET-KM</b>	Auto Tools Insert (ISO type)	<b>B134</b>
<b>VCET-KM</b>	Turning Insert_Positive (Screw on System)	<b>B99</b>
<b>VCGT-AK</b>	Aluminum Insert_Positive (Screw on System)	<b>B109</b>
<b>VCGT-AR</b>	Aluminum Insert_Positive (Screw on System)	<b>B109</b>
<b>VCGT-FS</b>	Auto Tools Insert (ISO type)	<b>B134</b>
<b>VCGT-FS</b>	Turning Insert_Positive (Screw on System)	<b>B98</b>
<b>VCGT-KF</b>	Auto Tools Insert (ISO type)	<b>B133</b>
<b>VCGT-KF</b>	Turning Insert_Positive (Screw on System)	<b>B99</b>
<b>VCGT-KM</b>	Auto Tools Insert (ISO type)	<b>B134</b>
<b>VCGT-KM</b>	Turning Insert_Positive (Screw on System)	<b>B99</b>
<b>VCGT-MS</b>	Auto Tools Insert (ISO type)	<b>B134</b>
<b>VCGT-MS</b>	Turning Insert_Positive (Screw on System)	<b>B98</b>
<b>VCGT-VP1</b>	Auto Tools Insert (ISO type)	<b>B134</b>
<b>VCGT-VP1</b>	Turning Insert_Positive (Screw on System)	<b>B98</b>
<b>VCGX-VP1</b>	Auto Tools Insert (ISO type)	<b>B134</b>
<b>VCGX-VP1</b>	Turning Insert_Positive (Screw on System)	<b>B99</b>
<b>VCKT-MA</b>	Milling Insert (Pro-A Mill)	<b>E29</b>
<b>VCMT</b>	PCD Insert_Positive	<b>B113</b>
<b>VCMT-FP</b>	Turning Insert_Positive (Screw on System)	<b>B97</b>
<b>VCMT-HMP</b>	Turning Insert_Positive (Screw on System)	<b>B97</b>
<b>VCMT-MP</b>	Turning Insert_Positive (Screw on System)	<b>B97</b>
<b>VCMT-VF</b>	Turning Insert_Positive (Screw on System)	<b>B97</b>
<b>VCMT-VL</b>	Turning Insert_Positive (Screw on System)	<b>B97</b>
<b>VCMT-VP1</b>	Turning Insert_Positive (Screw on System)	<b>B97</b>
<b>VDKT-MA</b>	Milling Insert (Pro-A Mill)	<b>E29</b>
<b>VETR</b>	Thread Insert (Vertical Type)	<b>D33</b>
<b>VH Chip Breaker</b>	Turning Chip Breaker	<b>B31</b>
<b>VL Chip Breaker</b>	Turning Chip Breaker	<b>B29</b>
<b>VNGG-HA</b>	Turning Insert_Negative (Multi Lock System)	<b>B67</b>



## V

<b>VNMG-VP3</b>	Turning Insert_Negative (Multi Lock System)	<b>B67</b>
<b>VNMA</b>	cBN Insert_Negative (Regrinding)	<b>B112</b>
<b>VNMG-CP</b>	Turning Insert_Negative (Multi Lock System)	<b>B66</b>
<b>VNMG-HM</b>	Turning Insert_Negative	<b>B66</b>
<b>VNMG-LP</b>	Turning Insert_Negative (Multi Lock System)	<b>B66</b>
<b>VNMG-MK</b>	Turning Insert_Negative (Multi Lock System)	<b>B67</b>
<b>VNMG-MM</b>	Turning Insert_Negative (Multi Lock System)	<b>B67</b>
<b>VNMG-MP</b>	Turning Insert_Negative (Multi Lock System)	<b>B66</b>
<b>VNMG-RM</b>	Turning Insert_Negative (Multi Lock System)	<b>B67</b>
<b>VNMG-VB</b>	Turning Insert_Negative (Multi Lock System)	<b>B66</b>
<b>VNMG-VC</b>	Turning Insert_Negative (Multi Lock System)	<b>B66</b>
<b>VNMG-VF</b>	Turning Insert_Negative (Multi Lock System)	<b>B66</b>
<b>VNMG-VL</b>	Turning Insert_Negative (Multi Lock System)	<b>B66</b>
<b>VNMG-VM</b>	Turning Insert_Negative (Multi Lock System)	<b>B67</b>
<b>VNMG-VP3</b>	Turning Insert_Negative (Multi Lock System)	<b>B67</b>
<b>VNMG-VQ</b>	Turning Insert_Negative (Multi Lock System)	<b>B67</b>
<b>VP1 Chip Breaker</b>	Turning Chip Breaker	<b>B26</b>
<b>VP2 Chip Breaker</b>	Turning Chip Breaker	<b>B26</b>
<b>VP3 Chip Breaker</b>	Turning Chip Breaker	<b>B27</b>
<b>VP4 Chip Breaker</b>	Turning Chip Breaker	<b>B27</b>
<b>VPET-KF</b>	Turning Insert_Positive (Screw on System)	<b>B100</b>
<b>VPET-KF</b>	Auto Tools Insert (ISO type)	<b>B135</b>
<b>VPET-KM</b>	Turning Insert_Positive (Screw on System)	<b>B100</b>
<b>VPET-KM</b>	Auto Tools Insert (ISO type)	<b>B135</b>
<b>VPGT-KF</b>	Auto Tools Insert (ISO type)	<b>B135</b>
<b>VPGT-KM</b>	Auto Tools Insert (ISO type)	<b>B135</b>
<b>VPGT-VP1</b>	Turning Insert_Positive (Screw on System)	<b>B100</b>
<b>VPGT-VP1</b>	Auto Tools Insert (ISO type)	<b>B135</b>
<b>VQ Chip Breaker</b>	Turning Chip Breaker	<b>B30</b>
<b>VT Chip Breaker</b>	Turning Chip Breaker	<b>B31</b>
<b>VTH</b>	Vertical Type Holder	<b>D33</b>
<b>VW Chip Breaker</b>	Turning Chip Breaker	<b>B32</b>

## W

<b>WBGT</b>	Turning Insert_Positive (Compact Mini)	<b>B101</b>
<b>WCMT-C20N</b>	Drill Insert (WPDC)	<b>F04</b>
<b>WCMT-C21N</b>	Drill Insert (WPDC)	<b>F04</b>
<b>WDKT-MH</b>	Milling Insert (HRM)	<b>E29</b>
<b>WFSB(M)</b>	Wind Mill (Boss type)	<b>E416</b>
<b>WFSP(M)</b>	Wind Mill (Plane type)	<b>E417</b>
<b>WNGG-VP3</b>	Turning Insert_Negative (Lever Lock/Wedge Clamp/Multi Lock System)	<b>B71</b>
<b>WNGX-MA</b>	Milling Insert (Rich Mill)	<b>E30</b>
<b>WNGX-ML</b>	Milling Insert (Rich Mill)	<b>E30</b>
<b>WNGX-MM</b>	Milling Insert (Rich Mill)	<b>E30</b>

## W

<b>WNMA</b>	Turning Insert_Negative (Lever Lock/Wedge Clamp/Multi Lock System)	<b>B70</b>
<b>WNMG-B25</b>	Turning Insert_Negative (Lever Lock/Wedge Clamp/Multi Lock System)	<b>B69</b>
<b>WNMG-CP</b>	Turning Insert_Negative (Lever Lock/Wedge Clamp/Multi Lock System)	<b>B68</b>
<b>WNMG-GR</b>	Turning Insert_Negative (Lever Lock/Wedge Clamp/Multi Lock System)	<b>B69</b>
<b>WNMG-HA</b>	Turning Insert_Negative (Lever Lock/Wedge Clamp/Multi Lock System)	<b>B72</b>
<b>WNMG-HM</b>	Turning Insert_Negative	<b>B69</b>
<b>WNMG-LP</b>	Turning Insert_Negative (Lever Lock/Wedge Clamp/Multi Lock System)	<b>B68</b>
<b>WNMG-LW</b>	Turning Insert_Negative (Lever Lock/Wedge Clamp/Multi Lock System)	<b>B72</b>
<b>WNMG-MK</b>	Turning Insert_Negative (Lever Lock/Wedge Clamp/Multi Lock System)	<b>B70</b>
<b>WNMG-MM</b>	Turning Insert (SAVE TURN)	<b>B115</b>
<b>WNMG-MM</b>	Turning Insert_Negative (Lever Lock/Wedge Clamp/Multi Lock System)	<b>B71</b>
<b>WNMG-MP</b>	Turning Insert (SAVE TURN)	<b>B115</b>
<b>WNMG-MP</b>	Turning Insert_Negative (Lever Lock/Wedge Clamp/Multi Lock System)	<b>B69</b>
<b>WNMG-RK</b>	Turning Insert_Negative (Lever Lock/Wedge Clamp/Multi Lock System)	<b>B70</b>
<b>WNMG-RM</b>	Turning Insert_Negative (Lever Lock/Wedge Clamp/Multi Lock System)	<b>B71</b>
<b>WNMG-VB</b>	Turning Insert_Negative (Lever Lock/Wedge Clamp/Multi Lock System)	<b>B68</b>
<b>WNMG-VC</b>	Turning Insert_Negative (Lever Lock/Wedge Clamp/Multi Lock System)	<b>B68</b>
<b>WNMG-VF</b>	Turning Insert_Negative (Lever Lock/Wedge Clamp/Multi Lock System)	<b>B68</b>
<b>WNMG-VL</b>	Turning Insert_Negative (Lever Lock/Wedge Clamp/Multi Lock System)	<b>B68</b>
<b>WNMG-VM</b>	Turning Insert_Negative (Lever Lock/Wedge Clamp/Multi Lock System)	<b>B69</b>
<b>WNMG-VP2</b>	Turning Insert_Negative (Lever Lock/Wedge Clamp/Multi Lock System)	<b>B71</b>
<b>WNMG-VP3</b>	Turning Insert_Negative (Lever Lock/Wedge Clamp/Multi Lock System)	<b>B71</b>
<b>WNMG-VP4</b>	Turning Insert_Negative (Lever Lock/Wedge Clamp/Multi Lock System)	<b>B71</b>
<b>WNMG-VQ</b>	Turning Insert (SAVE TURN)	<b>B115</b>
<b>WNMG-VQ</b>	Turning Insert_Negative (Lever Lock/Wedge Clamp/Multi Lock System)	<b>B70</b>
<b>WNMG-VR</b>	Turning Insert_Negative (Lever Lock/Wedge Clamp/Multi Lock System)	<b>B70</b>
<b>WNMG-VW</b>	Turning Insert_Negative (Lever Lock/Wedge Clamp/Multi Lock System)	<b>B72</b>
<b>WNMM-B25</b>	Turning Insert_Negative (Lever Lock/Wedge Clamp/Multi Lock System)	<b>B72</b>
<b>WNMX-MF</b>	Milling Insert (HRMDouble)	<b>E30</b>
<b>WNMX-ML</b>	Milling Insert (HRMDouble)	<b>E30</b>
<b>WNMX-MM</b>	Milling Insert (HRMDouble)	<b>E30</b>
<b>WNMX-SH</b>	Turning Insert_Negative (Lever Lock/Wedge Clamp/Multi Lock System)	<b>B72</b>
<b>WNMX-SR</b>	Turning Insert_Negative	<b>B72</b>
<b>WPDC-5D</b>	Drill (WPDC Standard type)	<b>F79</b>
<b>WPDC-5D</b>	Drill (WPDC Dual insert cartridge type)	<b>F81</b>
<b>WPDC-5D</b>	Drill (WPDC Single insert cartridge type)	<b>F80</b>
<b>WPDC-6.5D</b>	Drill (WPDC Standard type)	<b>F79</b>
<b>WPDC-6.5D</b>	Drill (WPDC Dual insert cartridge type)	<b>F81</b>
<b>WPDC-6.5D</b>	Drill (WPDC Single insert cartridge type)	<b>F80</b>
<b>WPDC-8D</b>	Drill (WPDC Standard type)	<b>F79</b>
<b>WPDC-8D</b>	Drill (WPDC Dual insert cartridge type)	<b>F81</b>
<b>WPDC-8D</b>	Drill (WPDC Single insert cartridge type)	<b>F80</b>
<b>WS</b>	Side Cutter	<b>E413</b>
<b>WTENN</b>	Holder (Wedge Clamp System)	<b>B179</b>
<b>WTJNR/L</b>	Holder (Wedge Clamp System)	<b>B179</b>

# K Index by designation

## W

<b>WTXNR/L</b>	Holder (Wedge Clamp System)	<b>B179</b>
<b>WWLNR/L</b>	Holder (Wedge Clamp System)	<b>B180</b>

## X

<b>XCET-KC</b>	Milling Insert (Chamfer Tool)	<b>E31</b>
<b>XDET-MA</b>	Milling Insert (Pro-V Mill)	<b>E31</b>
<b>XEKT-MA</b>	Milling Insert (Pro-X Mill)	<b>E31</b>
<b>XEKT-ML</b>	Milling Insert (Pro-X Mill)	<b>E31</b>
<b>XNCT-MA</b>	Milling Insert (Rich Mill)	<b>E31</b>
<b>XNKT-ML</b>	Milling Insert (Rich Mill)	<b>E32</b>
<b>XNKT-MM</b>	Milling Insert (Rich Mill)	<b>E32</b>
<b>XNMX-ML</b>	Milling Insert (Rich Mill)	<b>E32</b>
<b>XOET-ND</b>	Drill Insert (KING DRILL)	<b>F04</b>
<b>XOMT-LD</b>	Drill Insert (KING DRILL)	<b>F03</b>
<b>XOMT-PD</b>	Drill Insert (KING DRILL)	<b>F03</b>
<b>XOMT-RD</b>	Drill Insert (KING DRILL)	<b>F04</b>
<b>XPMT-MM</b>	Milling Insert (HAVE)	<b>E32</b>

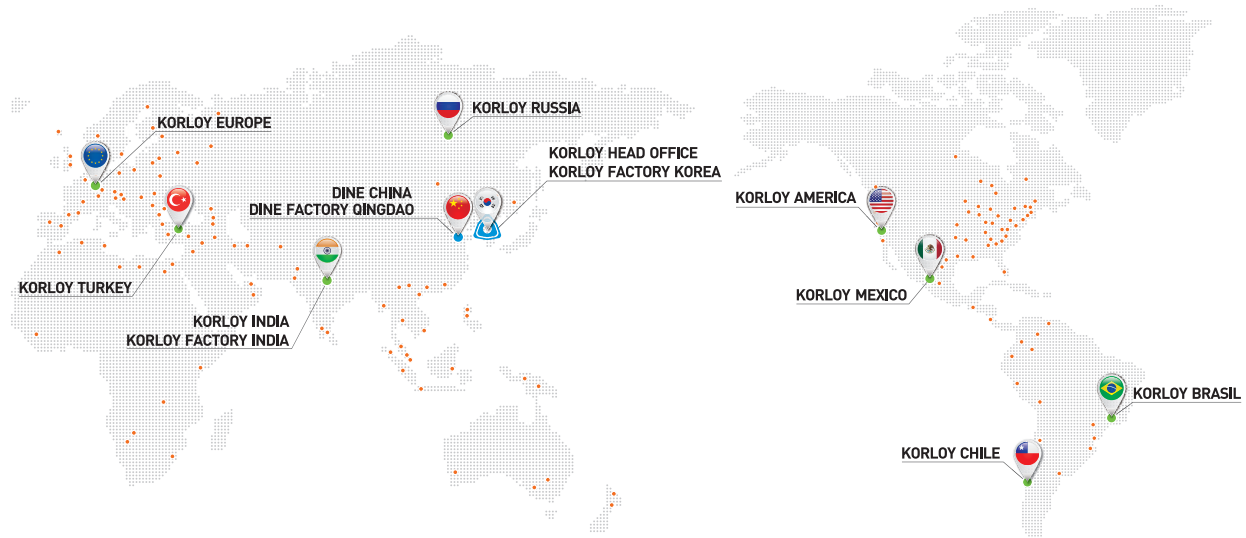
## Z

<b>ZDMT-R-MM</b>	Milling Insert (BRE)	<b>E33</b>
<b>ZPET-MM</b>	Milling Insert (GBE)	<b>E33</b>
<b>ZPMT-MM</b>	Milling Insert (BT Tooling System, Tank Mill)	<b>E33</b>
<b>ZPMT-R-MM</b>	Milling Insert (BRE)	<b>E33</b>
<b>ZPMT-R-MR</b>	Milling Insert (BRE)	<b>E33</b>



# KORLOY Global Network

We stand to be the Global Top Manufacturer. Korea's Best. World's Best



## KORLOY

### Head Office

Holystar B/D, 326, Seocho-daero, Seocho-gu,  
Seoul, 06633, Republic of Korea

Tel: +82-2-522-3181 Fax: +82-2-522-3184, +82-2-3474-4744

### R&D Institute Cheongju

55, Sandan-ro, Heungdeok-gu, Cheongju-si,  
Chungcheongbuk-do, 28589, Korea

Tel: +82-43-262-0141 Fax: +82-43-262-0711

### Cheongju Factory

55, Sandan-ro, Heungdeok-gu, Cheongju-si,  
Chungcheongbuk-do, 28589, Korea

Tel: +82-43-262-0141 Fax: +82-43-263-8731

### Jincheon Factory

54, Gwanghyewonsandan 2-gil, Gwanghyewon-myeon,  
Jincheon-gun, Chungcheongbuk-do, 27807, Korea

Tel: +82-43-535-0141 Fax: +82-43-535-0144

## KORLOY AMERICA

620 Maple Avenue, Torrance, CA 90503, USA

Tel: +1-310-782-3800 Toll Free: +1-888-711-0001 Fax: +1-310-782-3885

E-mail: sales.kai@korloy.com

## KORLOY INDIA

Plot No. 415, Sector 8, IMT Manesar, Gurgaon 122051, Haryana, India

Tel: +91-124-4391790 Fax: +91-124-4050032

E-mail: sales.kip@korloy.com

## KORLOY TURKEY

Serifali Mahallesi, Burhan Sokak NO: 34

Dudullu OSB/Umraniye/Istanbul, 34775, Turkey

Tel: +90-216-415-8874 E-mail: sales.ktl@korloy.com

## KORLOY RUSSIA

Krasivy Dom office No. 305, Bld. 5, Novovladynkiy proezd 8, 127106,

Moscow, Russia

Tel: +7-495-280-1458 Fax: +7-495-280-1459 E-mail: sales.krc@korloy.com

## KORLOY FACTORY INDIA

Plot No. 415, Sector 8, IMT Manesar, Gurgaon 122051, Haryana, India

Tel: +91-124-4391790 Fax: +91-124-4050032

E-mail: pro.kim@korloy.com

## KORLOY EUROPE

Gablonzer Str. 25-27, 61440 Oberursel, Germany

Tel: +49-6171-277-83-0 Fax: +49-6171-277-83-59

E-mail: sales.keg@korloy.com

## KORLOY BRASIL

Av. Aruana 280, conj.12, WLC, Alphaville, Barueri,

CEP06460-010, SP, Brasil

Tel: +55-11-4193-3810 E-mail: sales.kbl@korloy.com

## KORLOY CHILE

Av. Providencia 1650, Office 1009, 7500027

Providencia-Santiago, Chile

Tel: +56-229-295-490 E-mail: sales.kcs@korloy.com

## KORLOY MEXICO

Queretaro, Mexico

E-mail: sales.kml@korloy.com

[www.korloy.com](http://www.korloy.com)



CA-EM-01 / 20221110